

Programmable High Precision DC Power Supply

PPX Series

USER MANUAL

Rev. A



ISO-9001 CERTIFIED MANUFACTURER

GW INSTEK

This manual contains proprietary information, which is protected by copyright. All rights are reserved. No part of this manual may be photocopied, reproduced or translated to another language without prior written consent of Good Will company.

The information in this manual was correct at the time of printing. However, Good Will continues to improve products and reserves the rights to change specification, equipment, and maintenance procedures at any time without notice.

Good Will Instrument Co., Ltd.
No. 7-1, Jhongsing Rd., Tucheng Dist., New Taipei City 236, Taiwan.

Table of Contents

SAFETY INSTRUCTIONS	5
GETTING STARTED.....	8
PPX Series Overview	9
Appearance.....	12
Theory of Operation.....	20
OPERATION	30
Set Up.....	31
Menu Tree.....	40
Basic Operation	46
Sequence Test.....	74
MENU CONFIGURATION.....	107
Configuration Overview	108
Output.....	108
Measurement.....	112
EXT Control	115
TRIG Control.....	120
PWR On Config.....	126
Constant PWR.....	127
Temperature.....	130
Save/Recall	134
Interface	137
Utility.....	144
APP.....	152
Calibration	155
ANALOG CONTROL.....	156
Analog Remote Control Overview.....	157
Remote Monitoring.....	173







COMMUNICATION INTERFACE	178
Interface Configuration	179
FAQ.....	208
APPENDIX.....	210
PPX Factory Default Settings.....	210
PPX Specifications	213
PPX Dimensions	218
Declaration of Conformity.....	219
INDEX.....	220

S SAFETY INSTRUCTIONS

This chapter contains important safety instructions that you must follow during operation and storage. Read the following before any operation to insure your safety and to keep the instrument in the best possible condition.

Safety Symbols

These safety symbols may appear in this manual or on the instrument.

	WARNING	Warning: Identifies conditions or practices that could result in injury or loss of life.
	CAUTION	Caution: Identifies conditions or practices that could result in damage to the PPX or to other properties.
	DANGER	High Voltage
	Attention	Refer to the Manual
	Protective Conductor Terminal	
	Earth (ground) Terminal	



Do not dispose electronic equipment as unsorted municipal waste. Please use a separate collection facility or contact the supplier from which this instrument was purchased.

Safety Guidelines

General Guideline



CAUTION

- Do not place any heavy object on the PPX.
- Avoid severe impact or rough handling that leads to damaging the PPX.
- Do not discharge static electricity to the PPX.
- Use only mating connectors, not bare wires, for the terminals.
- Do not disassemble the PPX unless you are qualified.

Power Supply



CAUTION

- AC Input Voltage:
100Vac/120Vac/220Vac/240Vac, 50Hz/60Hz, single phase
- Frequency: 47Hz to 63Hz
- Before connecting the power plug to an AC line outlet, make sure the voltage selector switches of the bottom panel in the correct position.
- Disconnect power cord and test leads before replacing fuse.



WARNING

- The fuse specification is as following:

FUSE	LINE
250V T3.15A	100V~ 120V~
250V T1.6A	220V~ 240V~

- To avoid electrical shock connect the protective grounding conductor of the AC power cord to an earth ground.

- Cleaning the PPX
- Disconnect the power cord before cleaning.
 - Use a soft cloth dampened in a solution of mild detergent and water. Do not spray any liquid.
 - Do not use chemicals containing harsh material such as benzene, toluene, xylene, and acetone.

- Operation Environment
- Location: Indoor, no direct sunlight, dust free, almost non-conductive pollution (Note below)
 - Relative Humidity: 20%~ 80% (no condensation)
 - Altitude: < 2000m
 - Temperature: 0°C to 40°C
- (Pollution Degree) EN61010-1:2010 specifies the pollution degrees and their requirements as follows. The PPX falls under degree 2.
- Pollution refers to “addition of foreign matter, solid, liquid, or gaseous (ionized gases), that may produce a reduction of dielectric strength or surface resistivity”.
- Pollution degree 1: No pollution or only dry, non-conductive pollution occurs. The pollution has no influence.
 - Pollution degree 2: Normally only non-conductive pollution occurs. Occasionally, however, a temporary conductivity caused by condensation must be expected.
 - Pollution degree 3: Conductive pollution occurs, or dry, non-conductive pollution occurs which becomes conductive due to condensation which is expected. In such conditions, equipment is normally protected against exposure to direct sunlight, precipitation, and full wind pressure, but neither temperature nor humidity is controlled.

- Storage environment
- Location: Indoor
 - Temperature: -20°C to 70°C
 - Relative Humidity: 20 to 85%(no condensation)

Disposal



Do not dispose this instrument as unsorted municipal waste. Please use a separate collection facility or contact the supplier from which this instrument was purchased. Please make sure discarded electrical waste is properly recycled to reduce environmental impact.

GETTING STARTED

This chapter describes the power supply in a nutshell, including its main features and front / rear panel introduction. After going through the overview, please read the theory of operation to become familiar with the operating modes, protection modes and other safety considerations.

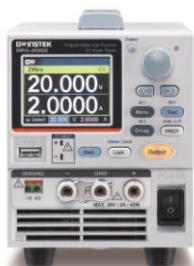

PPX Series Overview	9
Series lineup	9
Main Features	9
Accessories	10
Appearance	12
Front Panel	12
Display Area	16
Rear Panel	18
Theory of Operation	20
Operating Description	20
CC and CV Mode	21
Slew Rate	22
Bleeder Control	23
Alarms	24
Considerations	25
Grounding	28

PPX Series Overview

Series lineup

The PPX series consists of 6 models, covering a number of different current, voltage and power capacities:

Model name	Operation Voltage	Operation Current	Rated Power
PPX-1005	0-10V	0-5A	50W
PPX-2002	0-20V	0-2A	40W
PPX-2005	0-20V	0-5A	100W
PPX-3601	0-36V	0-1A	36W
PPX-3603	0-36V	0-3A	108W
PPX-10H01	0-100V	0-1A	100W

Main Features

- Features
- 2.4" TFT-LCD Panel.
 - Preset memory function.
 - Output ON/OFF delay function.
 - CV, CC priority start function. (prevents overshoot with output ON)
 - Adjustable voltage and current slew rates.
 - Bleeder circuit ON/OFF setting. (to prevent over-discharging of batteries)
 - OVP, OCP, AC Alarm and OTP protection.
 - Supports test sequence.
 - Web server monitoring and control. (The function is activated when connecting to LAN Interface)
 - Analog monitor output.

- Remote sensing to compensate for voltage drop in load leads.
- Support K type thermocouple temperature measurement.
- With 4 measuring currents and Manual / Auto shift function.

Interface

- Built-in USB, RS-232/485 and LAN interface.
- External analog control function.
- Optional GPIB interface.

Accessories

Before using the PPX power supply unit, check the package contents to make sure all the standard accessories are included.

Standard Accessories	Part number	Description	Qty.
	GTL-104A	Test leads for PPX-1005/PPX-2005/PPX-3603 (Binding Posts Terminal), 1m, 10A	1
	GTL-105A	Test leads for PPX-2002/PPX-3601, 1m, 3A	1
		Short Bar (Binding Posts Terminal)	1
	GTL-204A	Test leads for PPX-1005/PPX-2005/PPX-3603 (European Type Jack Terminal), 1m, 10A	1
	GTL-203A	Test leads for PPX-2002/PPX-3601/PPX-10H01 (European Type Jack Terminal), 1m, 3A	1
	GTL-201A	Ground lead for European Type Jack Terminal	1
		Power Cord	1



Optional Accessories	Part number	Description
	GRA-441-J	Rack for PPX (JIS)
	GRA-441-E	Rack for PPX (EIA)
	GTL-205A	Temperature probe adaptor with thermocouple K type
	GTL-246	USB Cable (USB 2.0 Type A- Type B Cable, 4P)
	GTL-258	GPIB Cable, 2000mm
	GTL-259	RS232 cable with DB9 connector to RJ45
	GTL-260	RS485 cable with DB9 connector to RJ45
	GTL-262	RS485 slave cable

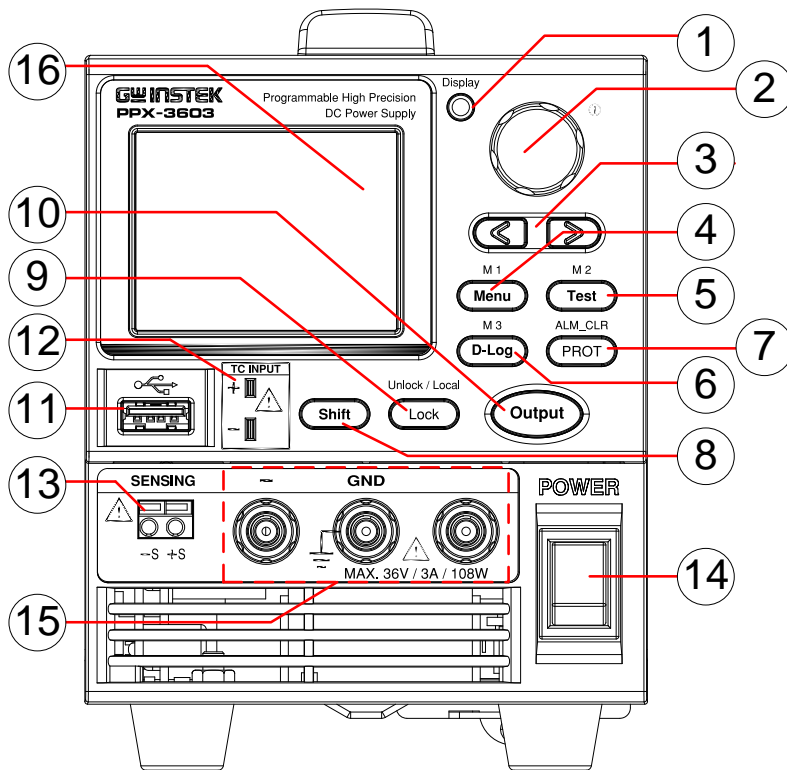

Factory Installed Options	Part number	Description
	Option 1	GPIB interface

Appearance

Front Panel





- 1. Display Button  Display Used to switch among 4 different display modes.
- 2. Knob Key  [Ⓢ] Used to navigate menu, and to configure or confirm voltage/current/time values, among others. Also, the indicator on the upper-right corner shows current state and power mode.

- 3. Left/Right Arrow Keys  Used to select a parameter number in the Function settings. Also the left arrow key can be used as backspace.
- 4. Menu Button  Used to enter the Menu page. Refer to page 108 for detail.

M1 Button (+Shift) Used to recall the M1 setup.
- 5. Test Button  Used to run customized test sequence. Refer to page 74 for detail.

M2 Button (+Shift) Used to recall the M2 setup.
- 6. D-Log Button  Used to run data log function. Refer to page 71 for detail.

M3 Button (+Shift) Used to recall the M3 setup.
- 7. PROT Button  Used to set OVP, OCP and UVL protecting functions. Refer to page 47 for details.

ALM_CLR Button (+Shift) Used to release protection functions that have been activated. The tripped protection alarms include the following: OVP Alarm, OCP Alarm, OTP Alarm, AC Alarm, Sense Alarm, WDOG Alarm, Ah CAP Alarm, Wh CAP Alarm, TEMP Short Alarm, TEMP Monitor Alarm.
- 8. Shift Button  Used to enable the functions that are written in blue characters above certain buttons.

9. Lock Button

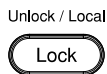

Unlock/Local Button

Used to lock all front panel buttons other than the Output Button. Refer to page 60 for detail.

(+Shift) Used to unlock the front panel buttons or it switches to local mode.

10. Output Button



Used to turn the output on or off.

11. USB A Port

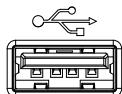

USB A port for data transfer, loading test scripts and firmware update.

12. TC Input

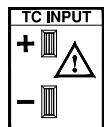

Terminal to connect the K type thermocouple cable for temperature measurement. Refer to page 66 for detail.

13. Sensing Terminal

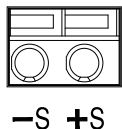

Terminal to connect the sensing cables, which compensate voltage drop occurred in load leads.

14. Power Switch

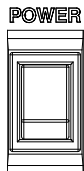

Used to turn the power on/off.

15. Output terminal

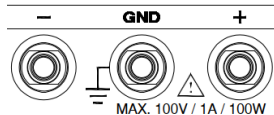

DC output terminal for PPX is European Type Jack Terminal.

PPX-10H01 the max. output is 100V/1A/100W

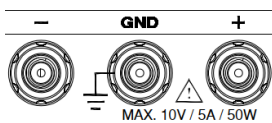

DC output terminal for PPX is Binding Posts Terminal or European Type Jack Terminal.

PPX-1005 the max. output is 10V/5A/50W

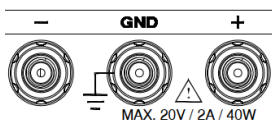

DC output terminal for PPX is Binding Posts Terminal or European Type Jack Terminal.

PPX-2002 the max. output is 20V/2A/40W

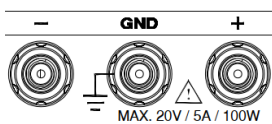

DC output terminal for PPX is Binding Posts Terminal or European Type Jack Terminal.

PPX-2005 the max. output is 20V/5A/100W

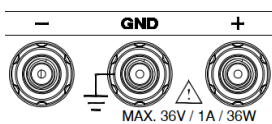

DC output terminal for PPX is Binding Posts Terminal or European Type Jack Terminal.

PPX-3601 the max. output is 36V/1A/36W

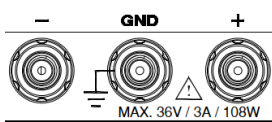

DC output terminal for PPX is Binding Posts Terminal or European Type Jack Terminal.

PPX-3603 the max. output is 36V/3A/108W

16 Display Area The display area shows set values, output values and parameter settings.

Display Area

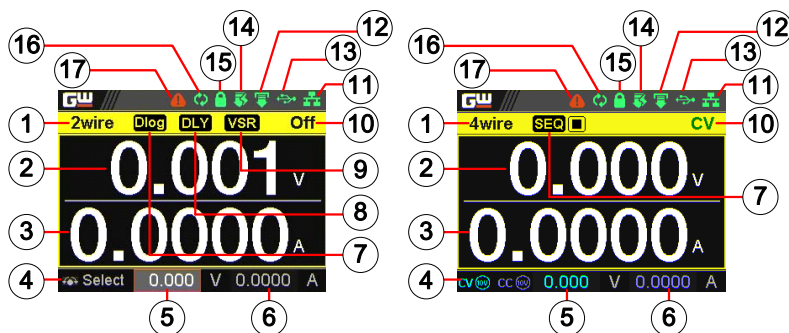

- | | | |
|----|-----------------------------|--|
| 1. | 2Wire/4Wire | 2-wire or 4-wire indicator. |
| 2. | Voltage Meter | Displays the voltage. |
| 3. | Current Meter | Displays the current. |
| 4. | V/A Set
Guidance | The scrolling symbol indicates to select between V and A set via scrolling knob key. |
| | External CC &
CV Control | When the external CC or CV control is activated, the indicator(s) will be shown. |
| 5. | V Set | Manually sets voltage. |
| 6. | I(A) Set | Manually sets current. |
| 7. | Dlog Icon | When Data Logger is enabled, the icon will be shown accordingly. Note that when SEQ appears, the icon will be faded out. |
| | SEQ | When Sequence function is turned On, the icon will be shown accordingly. |

8. DLY Icon When Output On/Off Dly is enabled, the icon will be shown accordingly. Note that when SEQ appears, the icon will be faded out.
9. VSR/ISR
Icon When CV/CC Slew Rate Priority (CVLS/CCLS) is activated, the icon will be shown. Note that when SEQ appears, the icon will be faded out.
10. CC/CV/UR
indicator It shows when constant voltage or constant current mode is ongoing. However, when output is unregulated, which means neither in CV mode nor CC mode, it shows UR instead. If it is not under power output, it simply shows Off.
11. LAN Indicator When PPX series connects to LAN network, the icon will be shown.
12. Remote Control
Indicator When remote control (USB/LAN/GPIB, UART) is underway, the icon will be shown.
13. USB Indicator When USB disk is inserted into the front panel of PPX series, the icon will be shown.
14. External Output
Indicator When external output enable is turned On, the icon will be shown.
15. Lock Indicator When the lock mode is activated, the icon will be shown.
16. Communication
Monitor
Indicator When communication monitor is enabled, the icon will be shown.
17. Error Indicator When error occurs from command of remote control, the icon will be shown.

Rear Panel

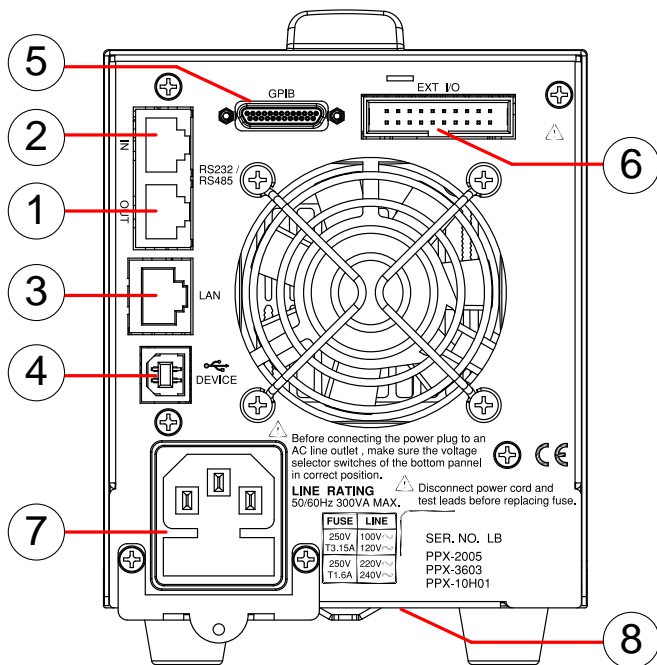

1. Remote-OUT RJ-45 connector that is used to daisy chain power supplies with the Remote-IN port to form a communication bus.
2. Remote-IN Two different types of cables can be used for RS232 or RS485-based remote control.
PSU-232: RS232 cable with DB9 connector kit.
PSU-485: RS485 cable with DB9 connector kit.
3. LAN Ethernet port for controlling the PPX remotely
4. USB USB port for controlling the PPX remotely.

5. GPIB GPIB connector for units equipped with IEEE programming option. (Factory Installed Options)
6. EXT I/O External analog remote control connector.
7. Line Voltage Input AC inlet.

8. AC Select Switch

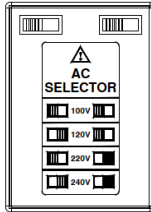

The AC selector is located at the bottom side of the unit.

Switch Voltage to 100V, 120V, 220V or 240V.

Theory of Operation

The theory of operation chapter describes the basic principles of operation, protection modes and important considerations that must be taken into account before use.

Operating Description

Background

The PPX power supplies are regulated DC power supplies with a stable voltage and current output. These operate within a switch automatically between constant voltage and constant current according to changes in the load.



Suitable supply cord set for use with the equipment:

- Mains plug: shall be national approval
- Mains connector: C13 type
- Cable:
 1. Length of power supply cord: less than 3m
 2. Cross-section of conductors: at least 0.75mm^2
 3. Cord type: shall meet the requirements of IEC 60227 or IEC 60245 (e.g.: H05VV-F, H05RN-F)



Caution

If the equipment is used in a manner not specified by the manufacturer, the protection provided by the equipment may be impaired.

CC and CV Mode

CC and CV mode Description

When the power supply is operating in constant current mode (CC) a constant current will be supplied to the load. When in constant current mode the voltage output can vary, whilst the current remains constant. When the load resistance increases to the point where the set current limit (I_{SET}) can no longer be sustained the power supply switches to CV mode. The point where the power supply switches modes is the crossover point.

When the power supply is operating in CV mode, a constant voltage will be supplied to the load, whilst the current will vary as the load varies. At the point that the load resistance is too low to maintain a constant voltage, the power supply will switch to CC mode and maintain the set current limit.

The conditions that determine whether the power supply operates in CC or CV (V_{SET}), the load resistance (R_L) and the critical resistance (R_C). The critical resistance is determined by V_{SET}/I_{SET} . The power supply will operate in CV mode when the load resistance is greater than the critical resistance. This means that the voltage output will be equal to the V_{SET} voltage but the current will be less than I_{SET} . If the load resistance is reduced to the point that the current output reaches the I_{SET} level, the power supply switches to CC mode.

Conversely the power supply will operate in CC mode when the load resistance is less than the critical resistance. In CC mode the current output is equal to I_{SET} and the voltage output is less than V_{SET} .

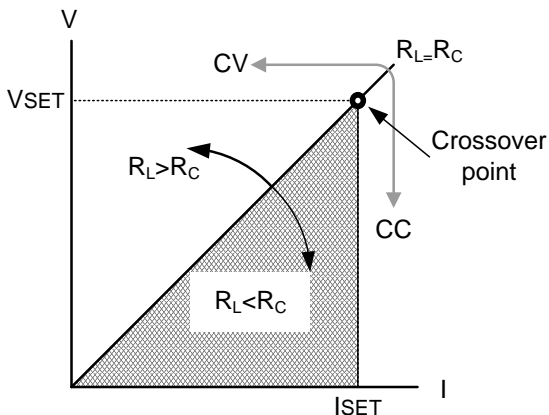

Slew Rate

Theory

The PPX has selectable slew rates for CC and CV mode. This gives the PPX power supply the ability to limit the current/voltage draw of the power supply. Slew rate settings are divided into High Speed Priority and Slew Rate Priority. High speed priority mode will use the fastest slew rate for the instrument. Slew Rate Priority mode allows for user adjustable slew rates for CC or CV mode. The rising and falling slew rate can be set independently.

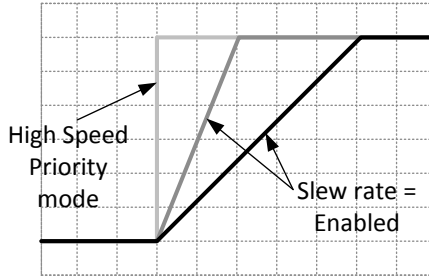

Bleeder Control

Background

The PPX DC power supplies employ a bleed resistor in parallel with the output terminals.

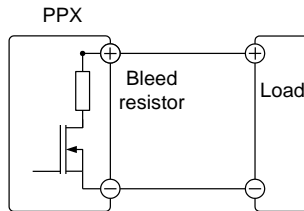

Bleed resistors are designed to dissipate the power from the power supply filter capacitors when power is turned off and the load is disconnected. Without a bleed resistor, power may remain charged on the filter capacitors for some time and be potentially hazardous.

In addition, bleed resistors also allow for smoother voltage regulation of the power supply as the bleed resistor acts as a minimum voltage load.

The bleed resistance can be turned on or off using the configuration settings.



Note

By default the bleed resistance is on. For battery charging applications, be sure to turn the bleed resistance off as the bleed resistor can discharge the connected battery when the unit is off.

Alarms

The PPX power supplies have a number of protection features. When one of the protection alarms is set, the ALM icon on the display will be lit. For details on how to set the protection modes, please see page 47.

OVP	Over voltage protection (OVP) prevents a high voltage from damaging the load. This alarm can be set by the user.
OC	Over current protection prevents high current from damaging the load. This alarm can be set by the user.
UVL	Under voltage limit. This function sets a minimum voltage setting level for the output. It can be set by the user.
OTP	Over temperature protection protect the instrument from overheating
AC ALARM	When AC input voltage or frequency is abnormal or beyond the AC power range under operation, the alarm will be generated.
SENSE ALARM	This alarm function is activated when real output voltage is larger than sense output voltage.
Alarm output	Alarms are output via the analog control connector. The alarm output is an isolated open-collector photo coupler output.

Considerations

The following situations should be taken into consideration when using the power supply.

Inrush current When the power supply switch is first turned on, an inrush current is generated. Ensure there is enough power available for the power supply when first turned on, especially if a number of units are turned on at the same time.



Cycling the power on and off quickly can cause the inrush current limiting circuit to fail as well as reduce the working life of the input fuse and power switch.

Pulsed or Peaked loads When the load has current peaks or is pulsed, it is possible for the maximum current to exceed the mean current value. The PPX power supply ammeter only indicates mean current values, which means for pulsed current loads, the actual current can exceed the indicated value. For pulsed loads, the current limit must be increased, or a power supply with a greater capacity must be chosen. As shown below, a pulsed load may exceed the current limit and the indicated current on the power supply ammeter.

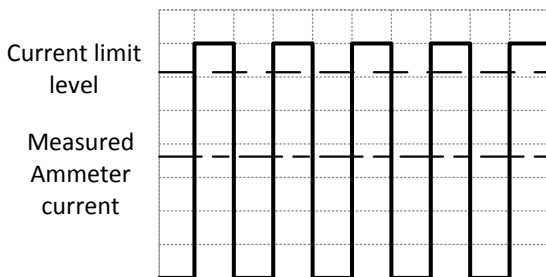

**Reverse Current:
Regenerative load**

When the power supply is connected to a regenerative load such as a transformer or inverter, reverse current will feed back to the power supply. The PPX power supply cannot absorb reverse current. For loads that create reverse current, connect a resistor in parallel (dummy load) to the power supply to bypass the reverse current. To calculate the resistance for the dummy resistor, R_D , first determine the maximum reverse current, I_R , and determine what the output voltage, E_O , will be.

$$R_D(\Omega) \leq E_O(V) \div I_R(A)$$

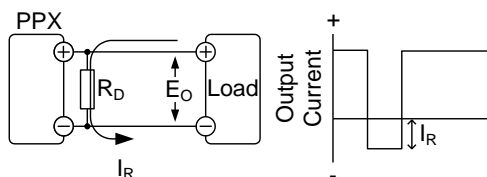

! Note

The current output will decrease by the amount of current absorbed by the resistor.

Ensure the resistor used can withstand the power capacity of the power supply/load.

Reverse Current:
Accumulative
energy.

When the power supply is connected to a load such as a battery, reverse current may flow back to the power supply. To prevent damage to the power supply, use a reverse-current-protection diode in series between the power supply and load.

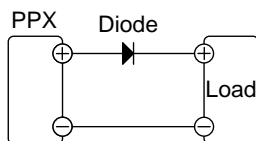

CAUTION

Ensure the reverse withstand voltage of the diode is able to withstand 2 times the rated output voltage of the power supply and the forward current capacity can withstand 3 to 10 times the rated output current of the power supply.

Ensure the diode is able to withstand the heat generated in the following scenarios.

When the diode is used to limit reverse voltage, remote sensing cannot be used.

Grounding

The output terminals of the PPX power supplies are isolated with respect to the protective grounding terminal. The insulation capacity of the load, the load cables and other connected devices must be taken into consideration when connected to the protective ground or when floating.

Floating

As the output terminals are floating, the load and all load cables must have an insulation capacity that is greater than the isolation voltage of the power supply.

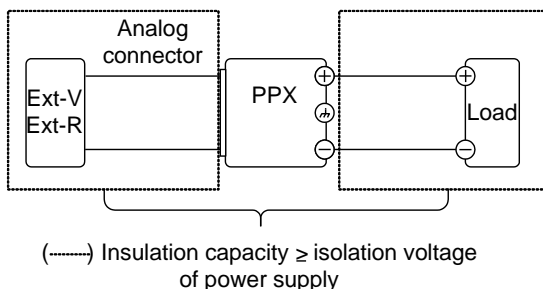

If the insulation capacity of the load and load cables are not greater than the isolation voltage of the power supply, electric shock may occur.

Grounded output terminal

If the positive or negative terminal is connected to the protective ground terminal, the insulation capacity needed for the load and load cables is greatly reduced. The insulation capacity only needs to be greater than the maximum output voltage of the power supply with respect to ground.

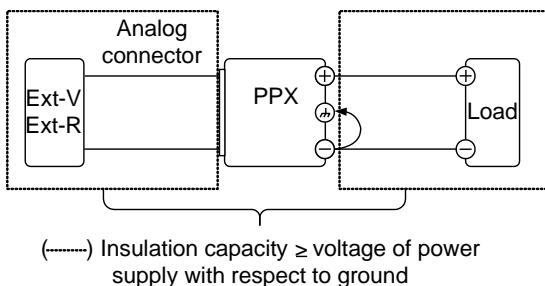

CAUTION

If using external voltage control, do not ground the external voltage terminal as this will create a short circuit.

OPERATION

Set Up	31
Power Up.....	31
Wire Gauge Considerations	32
Output Terminals.....	33
Connection with the front panel output terminal	33
Using the Rack Mount Kit	34
How to Use the Instrument.....	34
Reset to Factory Default Settings.....	38
View System Version and Build Date	39
Menu Tree	40
Menu Page - 1	41
Menu Page - 2.....	42
Menu Page - 3.....	43
D-Log.....	44
PROT.....	44
TEST.....	45
Basic Operation	46
Setting OVP/OCP/UVL Levels.....	47
Set to C.V. Priority Mode	51
Set to C.C. Priority Mode	55
Display Modes	59
Panel Lock.....	60
Save Setup	61
Recall Setup.....	62
Remote Sensing.....	64
Temperature.....	66
Data Logger.....	71
Sequence Test	74
Sequence Script File Format	75
Sequence Script Settings	75
Sequence Step Edit Settings.....	77
Setting Sequence Script Configurations.....	82
Run Sequence Script.....	94
Load Sequence Script.....	98
Save Sequence Script.....	101

Set Up

Power Up

Background Make sure that the power source is shut off.

Use the AC power cable supplied with the product.

Steps 1. Connect the power cord to the rear panel socket.

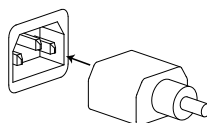

Note

Before connecting the power plug to an AC line outlet, make sure the voltage selector switches of the bottom panel in the correct position. Disconnect power cord and test leads before replacing fuse. Refer to page 19 for more details.

2. Press the POWER switch on. If used for the first time, the default settings will appear on the display, otherwise The PPX recovers the state right before the power was last turned OFF.



CAUTION

Do not turn the power on and off quickly. Please wait for the display to fully turn off.

Wire Gauge Considerations

Background Before connecting the output terminals to a load, the wire gauge of the cables should be considered. It is essential that the current capacity of the load cables is adequate. The rating of the cables must equal or exceed the maximum current rated output of the instrument.

Recommended wire gauge	Wire Gauge	Nominal Cross Section	Maximum Current
	28	0.10	3
	26	0.15	4
	24	0.25	5
	22	0.35	7
	20	0.55	9
	18	1	12

The maximum temperature rise can only be 60 degrees above the ambient temperature. The ambient temperature must be less than 30 degrees.

Output Terminals

Background Before connecting the output terminals to the load, first consider whether voltage sense will be used, the gauge of the cable wiring and the withstand voltage of the cables and load.



WARNING

Dangerous voltages. Ensure that the power to the instrument is disabled before handling the power supply output terminals. Failing to do so may lead to electric shock.

Connection with the front panel output terminal

Steps

1. Turn the power switch off.

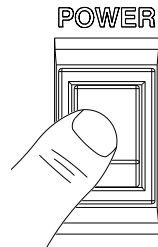

2. Connect the test lead includes in the accessory parts to front panel output terminal.
3. Fix the load cables firmly to eliminate loose connections from the front output terminals and load cables.

Using the Rack Mount Kit

Background The PPX series has an optional Rack Mount Kit (GW Instek part number: GRA-441-J [JIS], GRA-441-E [EIA]) that can be used to hold up to 4 PPX units into rack.

GRA-441-E [EIA]
Rack mount
diagram

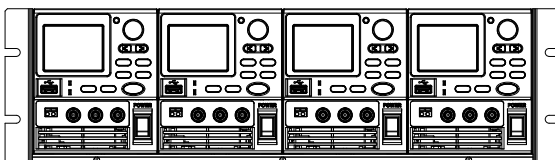

GRA-441-J [JIS]
Rack mount
diagram

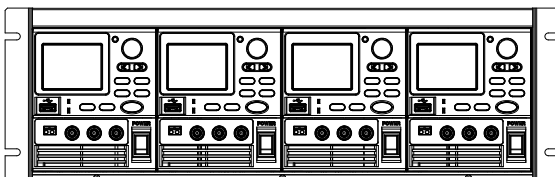

How to Use the Instrument

Background The PPX power supplies generally use the knob key and arrow keys to enter each page and setting, to return to previous page, to edit numerical values or to confirm settings.

The following section will explain some of these concepts in detail.

Example 1 Use the knob key and arrow keys to set a voltage of 10.100 volts.

1. From the main display, scroll knob key to move cursor to V Set field.

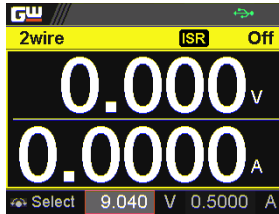
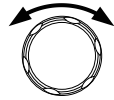

2. Click the knob key to enter the V Set field.

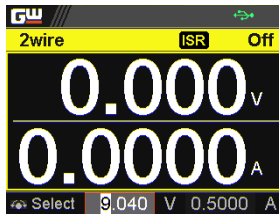

3. Use arrow keys to move the cursor to desired digits followed scrolling knob key to edit values. Repeat the step for each digit until target value.

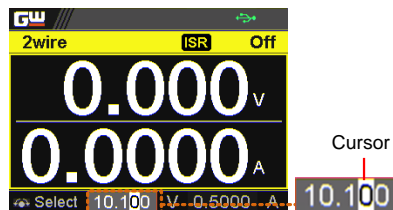
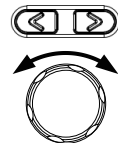

- Click the knob key to confirm the input value setting (10.100).

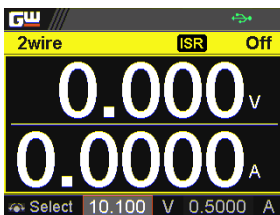

Example 2

Use the knob key to enter Measurement Average field and setting High option. Also, use the left arrow key to return to the previous page.

- Press the Menu key to enter the Menu page.

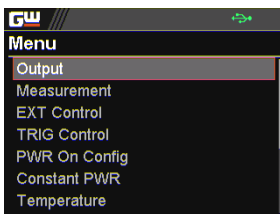

- Scroll the knob key to move to the Measurement field followed by clicking the knob key to enter the Measurement page.

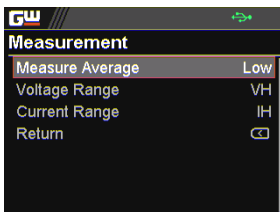
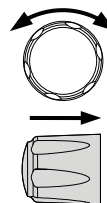

- Click the knob key to enter the Measurement Average field followed by scrolling the knob key to select High option.

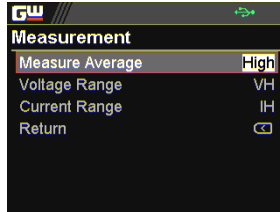
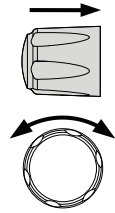

- Click the knob key to confirm the High option for Measurement Average.

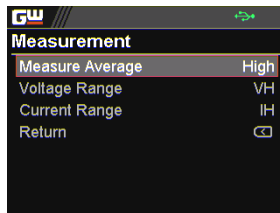

- Click the left arrow key to return to the previous page – Menu page.

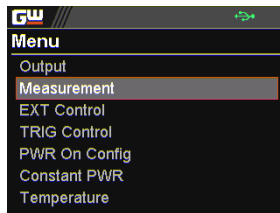

Reset to Factory Default Settings

Background The Recall Setup allows the PPX series to be reset back to the factory default settings. See page 210 for the default factory settings.

Steps

1. Press the Menu key to enter the Menu page.



2. Scroll the knob key to move to the Save/Recall field followed by clicking the knob key to enter the Save/Recall page.

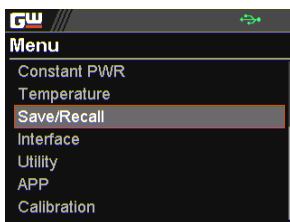
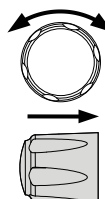

3. Scroll knob key to move to the Recall Mem Set field. Click knob key to enter the field followed by scrolling knob key to select Default option. Click knob key again to confirm setting.

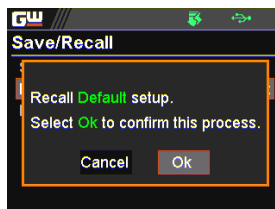
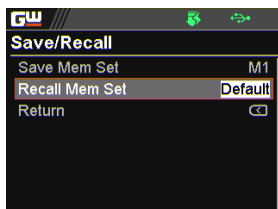
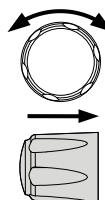

View System Version

Background The System Information allows you to view the PPX model name, serial number as well as firmware version.

Steps

1. Press the Menu key to enter the Menu page.

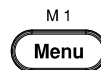

2. Scroll the knob key to move to the Utility field followed by clicking the knob key to enter the Utility page.

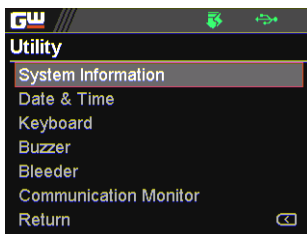
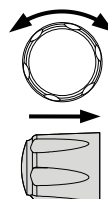

3. Click the knob key to enter the System Information page where PPX model name, serial number, as well as firmware version are displayed.

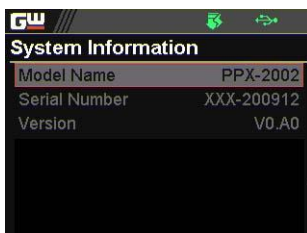
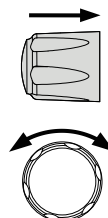

Menu Tree

Convention Use the menu trees as a handy reference for the power supply functions and properties. The PPX-1005/PPX-2002/PPX-2005/PPX-3601/PPX-3603/PPX-10H01 menu system is arranged in a hierarchical tree. Each hierarchical level, which is coated in varied colors, can be navigated through the orders within the diagrams below.

For example: To set the measurement average high:

- ① Press the *Menu* key.
- ② Navigate to the Measurement option.
- ③ Enter the Measure Average option.
- ④ Select High.

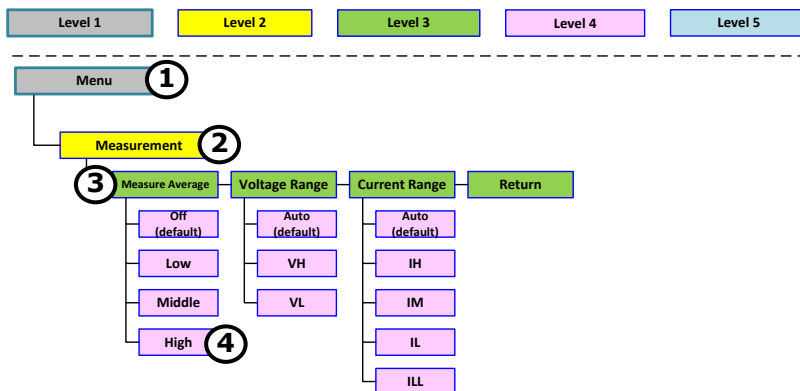

Menu Page - 1

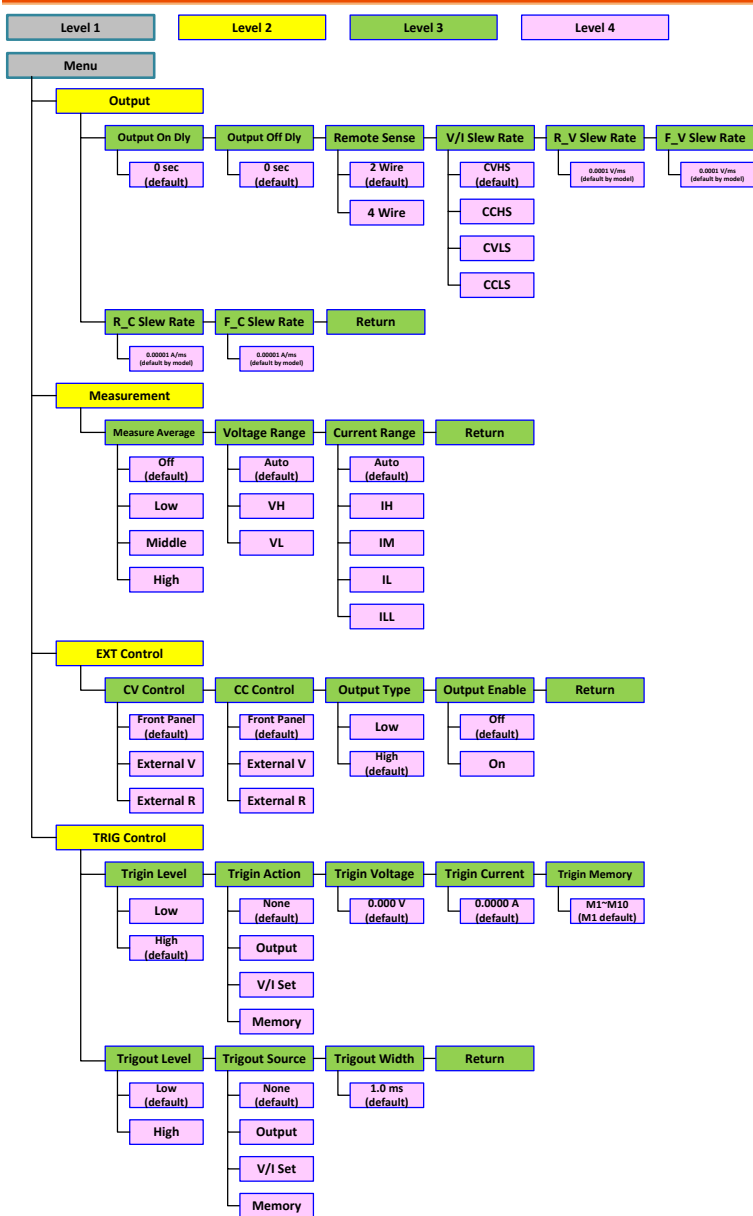

Menu Page - 2

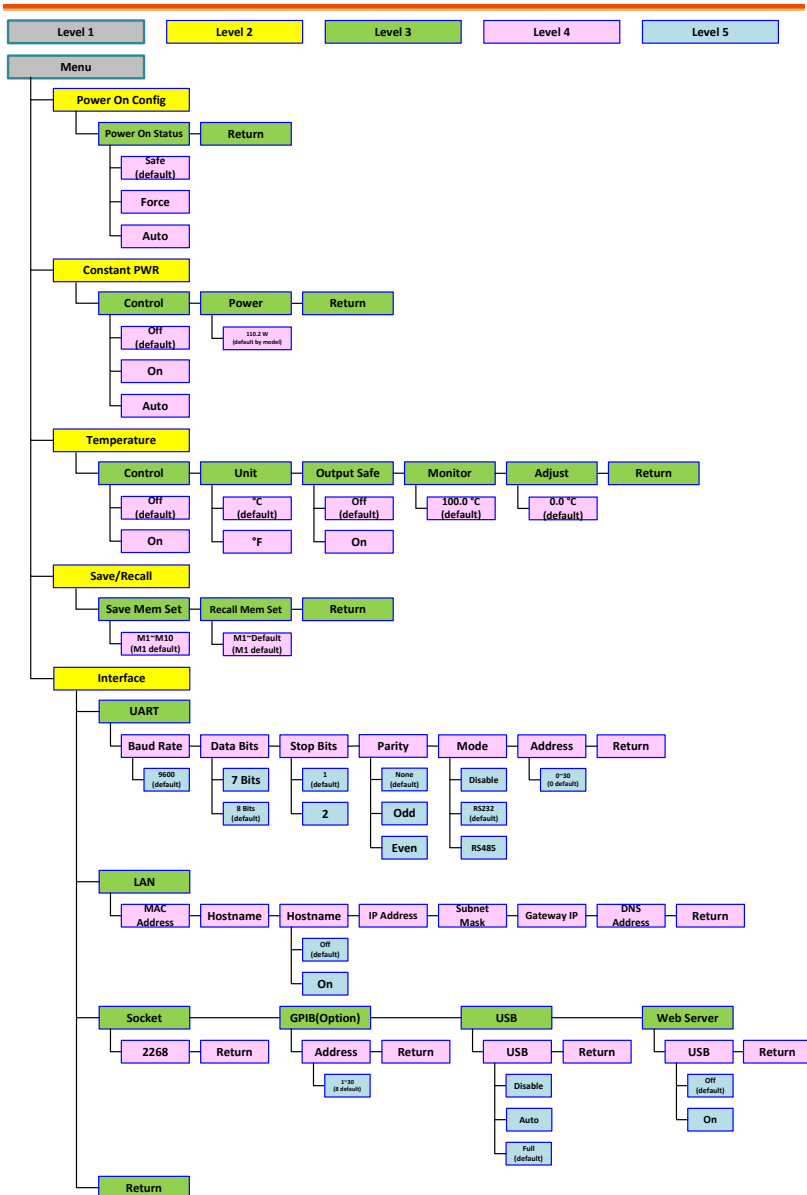

Menu Page - 3

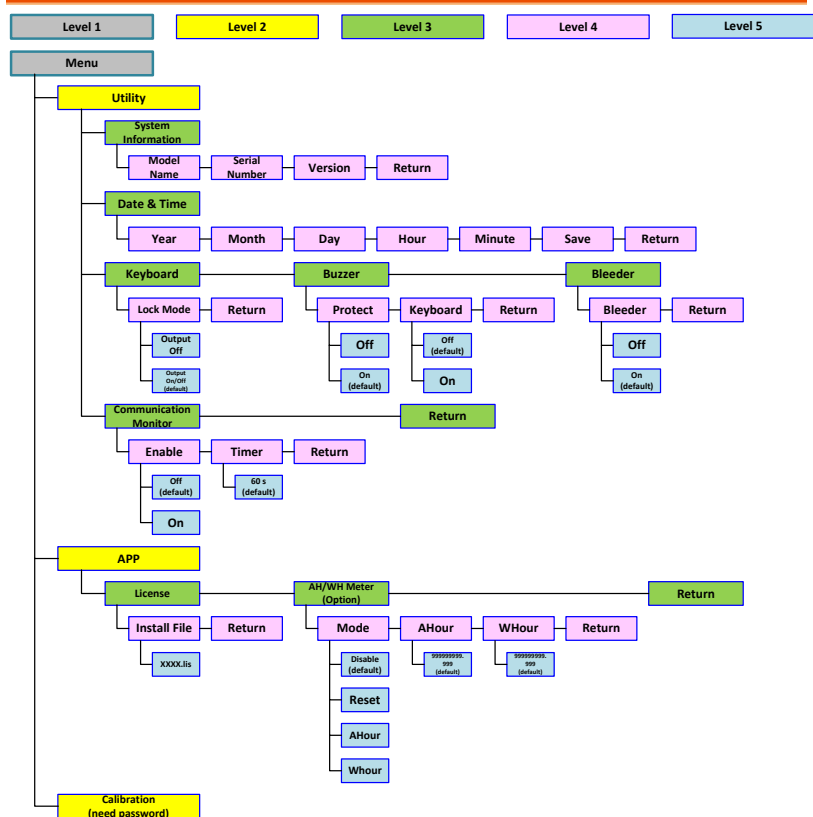

D-Log

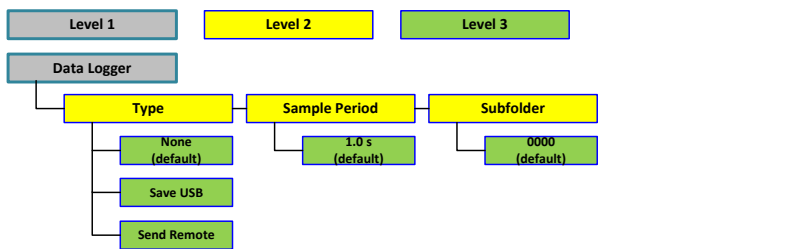

PROT

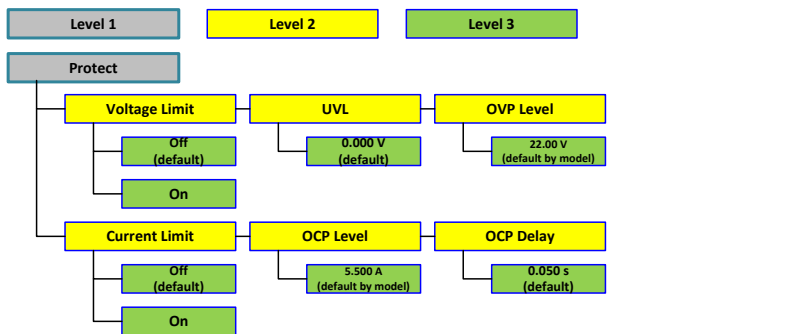

TEST

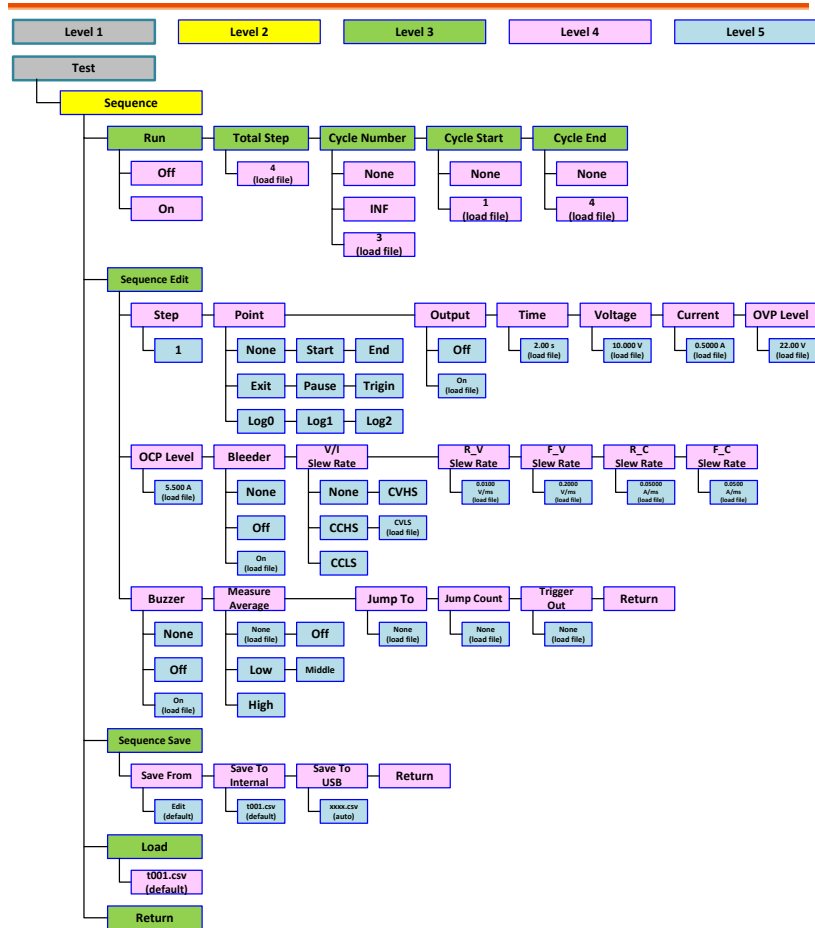

Basic Operation

This section describes the basic operations required to operate the power supply.

Setting OVP/OCP/UVL → from page 47

C.V. priority mode → from page 51

C.C. priority mode → from page 55

Display mode → page 59

Panel lock → page 60

Save setups → from page 61

Recall setups → from page 62

Remote sensing → from page 64

Temperature → from page 66

Data Logger → from page 71

Before operating the power supply, please see the Getting Started chapter, page 8.

Setting OVP/OCP/UVL Levels

Background

The OVP level and OCP level has a selectable range that is based on the output voltage and output current, respectively. The OVP and OCP level is set to the highest level by default. The actual selectable OVP and OCP range depends on the PPX model.

When one of the protection measures are on, the type of alarm message will be shown on display. Press Shift + PROT key to clear any protection alarm messages that have been tripped. By default, the output will turn off when the OVP or OCP protection levels are tripped.

The UVL will prevent you from setting a voltage that is less than the UVL setting. The UVL setting range is from 0% ~ 105% of the rated output voltage.

Before setting the protection settings:

- Ensure the load is not connected.
- Ensure the output is turned off.



Note

You can enter the PROT setting to apply limits to the voltage and current settings, respectively. You can set limitations so that the values do not exceed the set OVP and the set OCP level, and so that the values are not lower than the set UVL trip point. By using this feature, you can avoid turning the output off by mistakenly setting the voltage or current to a value that exceeds the set OVP or OCP level or to a value that is lower than the set UVL trip point.

If you have selected to limit the voltage setting, you

will no longer be able to set the output voltage to a value that is above about 95% of the OVP trip point or to a value that is lower than the UVL trip point. If you have selected to limit the current setting, you will no longer be able to set the output current to a value that is above about 95% of the OCP trip point.

Lastly, the Delay time setting for OCP delays trigger for OCP by set time period.

Steps

1. Press the PROT key to enter the Protect page.

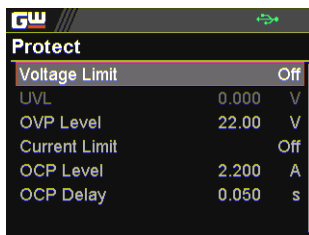

Enable/Disable Voltage and Current Limit

2. Scroll the knob key to move between Voltage/Current Limit fields. Click the knob key to enter each field, respectively. Scroll the knob key to turn ON/OFF the function. Further click the knob key again to confirm your setting.

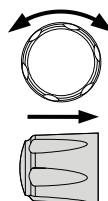

Option On, Off

Setting the Protection Level

3. Scroll the knob key to move among UVL/OVP/OCP Level fields. Click the knob key to enter each field, respectively. Scroll the knob key to adjust value, along with the arrow keys to change among digits followed by clicking the knob key to confirm set value.

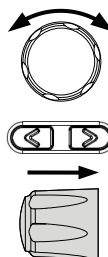

Model	Setting Range		UVL
	OCP	OVP	
PPX-1005	0.25~5.5	0.5~11	0~10.5
PPX-2002	0.1~2.2	1~22	0~21.0
PPX-2005	0.25~5.5	1~22	0~21.0
PPX-3601	0.05~1.1	1.8~39.6	0~37.8
PPX-3603	0.15~3.3	1.8~39.6	0~37.8
PPX-10H01	0.05~1.1	5~110	0~105

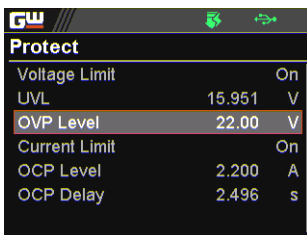

Note

- The UVL setting range is from 0% ~ 105% of the rated output voltage. It depends on Voltage Limit On/Off to activate/deactivate UVL setting.
- The OVP setting range is from 5% ~ 110% of the rated output voltage.
- The OCP setting range is from 5% ~ 110% of the rated output current.

Setting the Delay Time

4. Scroll the knob key to move between OCP Delay fields. Click the knob key to enter each field, respectively. Scroll the knob key to adjust value, along with the arrow keys to change among digits followed by clicking the knob key to confirm set value.

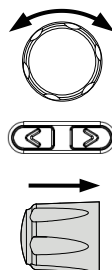

Setting Range
OCP Delay
0.05~2.500 s

Protect		
Voltage Limit		On
UVL	15.951	V
OVP Level	22.00	V
Current Limit		On
OCP Level	2.200	A
OCP Delay	2.496	s

Clear OVP/OCP protection

The OVP and OCP protection can be cleared after it has been tripped by clicking Shift key + ALM CLR key.

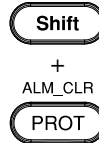

Note

The UVL protection On/Off depends on Voltage Limit.

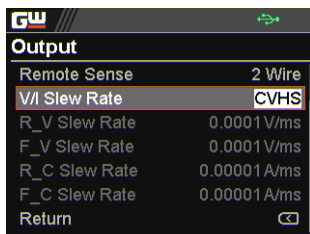

3. Scroll the knob key to select between CVHS (CV High Speed Priority) and CVLS (CV Slew Rate Priority) options.

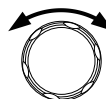

Options CVHS = CV High Speed Priority
 CVLS = CV Slew Rate Priority

4. Press the knob key to save the selected option.

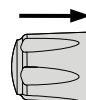

5. When CV Slew Rate Priority was chosen as the operating mode, scroll knob key to R_V Slew Rate and F_V Slew Rate fields followed by clicking knob key to enter the fields, respectively.

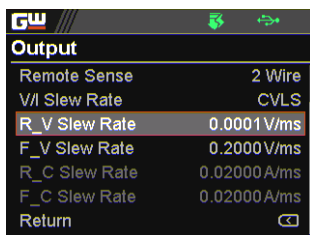
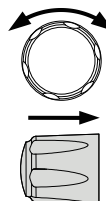

6. Scroll the knob key to adjust value, along with the arrow keys to change among digits followed by clicking the knob key to confirm set value, respectively.

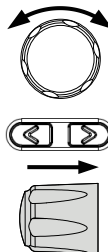

R_V Slew Rate / F_V Slew Rate Setting Range		
Model	Max. Value	Min. Value
PPX-1005	0.0001V/ms	0.1V/ms
PPX-2002	0.0001V/ms	0.2V/ms
PPX-2005	0.0001V/ms	0.2V/ms
PPX-3601	0.0001V/ms	0.36V/ms
PPX-3603	0.0001V/ms	0.36V/ms
PPX-10H01	0.001V/ms	0.5V/ms

7. Press the Menu key again to return to the main screen.

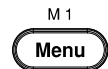

8. Scroll the knob key to move to V Set. Click knob key followed by scrolling knob key, along with the arrow keys to change among digits, to set the voltage. Click knob key to confirm the set value.

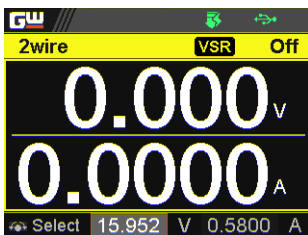
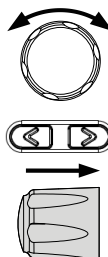

9. Scroll the knob key to move to I (A) Set. Click knob key followed by scrolling knob key, along with the arrow keys to change among digits, to set the current limit (crossover point). Click knob key to confirm the set value.

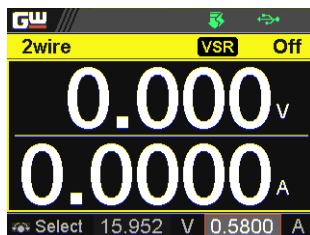
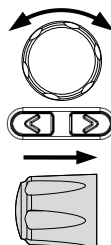

10. Press the Output key. The Output key becomes illuminated.

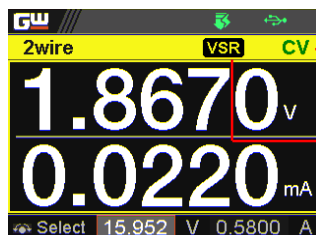

CV icon appears

VSR (CV Slew Rate Priority)

Set to C.C. Priority Mode

When setting the power supply to constant current mode, a voltage limit must also be set to determine the crossover point. When the voltage exceeds the crossover point, the mode switches to C.V. mode. For details about C.C. operation, see page 21.

C.C. and C.V. mode have two selectable slew rates: High Speed Priority and Slew Rate Priority. High Speed Priority will use the fastest slew rate for the instrument while Slew Rate Priority will use a user-configured slew rate.

Background Before setting the power supply to C.C. mode, ensure:

- The output is off.
- The load is connected.

Steps 1. Press the Menu key followed by clicking on Output to enter the Output page.

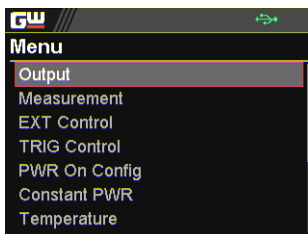
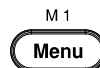

2. Scroll the knob key to move to the V/I Slew Rate field followed by clicking the knob key to enter the field.

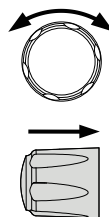

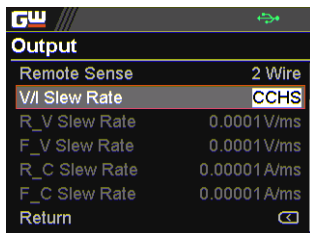

3. Scroll the knob key to select between CCHS (CC High Speed Priority) and CCLS (CC Slew Rate Priority) options.

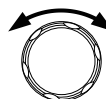

Options CCHS = CC High Speed Priority
 CCLS = CC Slew Rate Priority

4. Press the knob key to save the selected option.

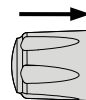

5. When CC Slew Rate Priority was chosen as the operating mode, scroll knob key to R_C Slew Rate and F_C Slew Rate fields followed by clicking knob key to enter the fields, respectively.

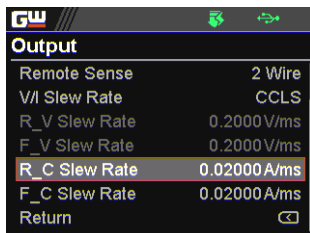
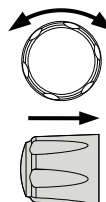

6. Scroll the knob key to adjust value, along with the arrow keys to change among digits followed by clicking the knob key to confirm set value, respectively.

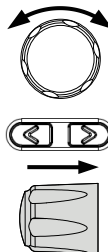

R_C Slew Rate / F_C Slew Rate Setting Range		
Model	Max. Value	Min. Value
PPX-1005	0.00001A/ms	0.05A/ms
PPX-2002	0.00001A/ms	0.02A/ms
PPX-2005	0.00001A/ms	0.05A/ms
PPX-3601	0.00001A/ms	0.01A/ms
PPX-3603	0.00001A/ms	0.03A/ms
PPX-10H01	0.00001A/ms	0.005A/ms

7. Press the Menu key again to return to the main screen.



8. Scroll the knob key to move to V Set. Click knob key followed by scrolling knob key, along with the arrow keys to change among digits, to set the voltage limit (crossover point). Click knob key to confirm the set value.

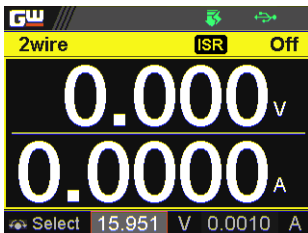
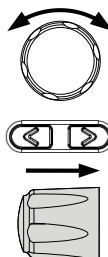

9. Scroll the knob key to move to I (A) Set. Click knob key followed by scrolling knob key, along with the arrow keys to change among digits, to set the current. Click knob key to confirm the set value.

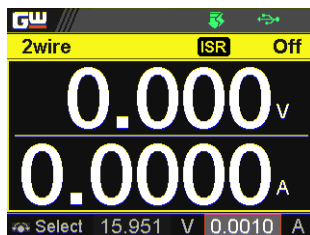
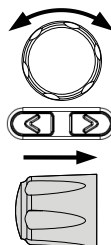

10. Press the Output key. The Output key becomes illuminated.

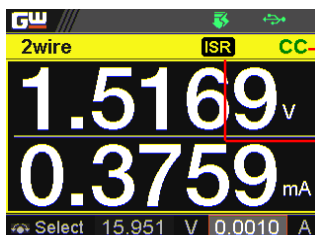

CC icon appears
 ISR (CC Slew Rate Priority)

Display Modes

The PPX series power supplies allow you to view the output in 4 different modes: General (V/A), Power (V/A/W), Sequence (V/A/Sequence) or Temperature (V/A/T).

Steps

1. Press the Display key on main screen to toggle among each mode.

Display



V and A

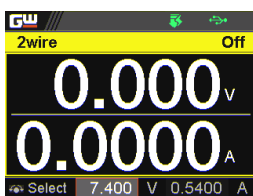

V, A and W

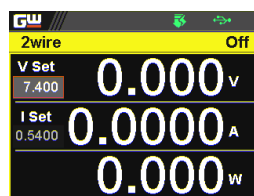

V, A and Sequence

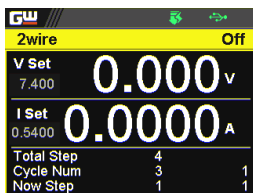

V, A and Temperature



2. Scroll the knob key to change between V and I (A) Set fields. Click the Knob key followed by scrolling it to adjust value, along with the arrow keys to change among digits followed by click knob key again to confirm value.

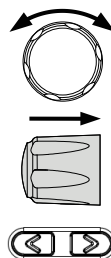

 **Note**

When sequence mode is selected, V and I set can Not be modified here.

Refer to page 95 for details of V, A and Sequence display and page 69 for details of V, A and Temperature.

Panel Lock

The panel lock feature prevents settings from being changed accidentally. When activated, all keys including the knob key except the Shift key, Lock (Unlock/Local) key and Output key (if active) will be disabled.

If the instrument is remotely controlled via the USB/LAN/GPIB interface, the panel lock is automatically enabled.

Activate the panel lock

Press the Lock (Unlock/Local) key to activate the panel lock. The lock icon will be shown on display.

Unlock / Local

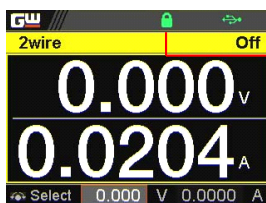

Panel Lock icon

Disable the panel lock

Press the Shift key followed by the Lock (Unlock/Local) key to disable the panel lock. The lock icon will thus be cleared from display.



+

Unlock / Local



Note

By default, the output key is disabled when lock function is activated. However, if Output On/Off function is selected under Utility section, the output key can be tuned On/Off even though the lock mode is activated. Refer to page 146 for detail.

Save Setup

The PPX has up to 10 memory storage (M1 ~ M10) to save the set current, set voltage, OVP, OCP and ULV settings.

Steps

1. Press the Menu key to enter the Menu page.

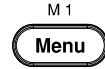

2. Scroll the knob key to move to the Save/Recall field followed by clicking the knob key to enter the Save/Recall page.

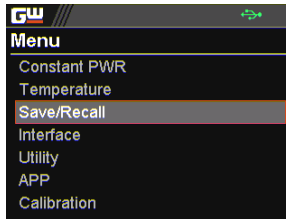
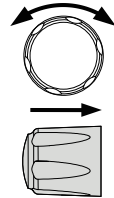

3. Click knob key to enter the Save Mem Set field followed by scrolling knob key to select one of the options for saving setting. Click knob key again to confirm the saving.

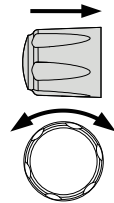

Options M1 ~ M10

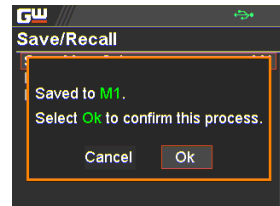
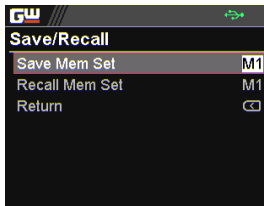

Recall Setup

The PPX has up to 10 memory storage (M1 ~ M10) to recall the set current, set voltage, OVP, OCP and ULV settings.

Also, it has 3 dedicated keys (M1, M2, M3) on front panel to promptly recall the setups.

Recall Memory from Save/Recall

1. Press the Menu key to enter the Menu page.



2. Scroll the knob key to move to the Save/Recall field followed by clicking the knob key to enter the Save/Recall page.

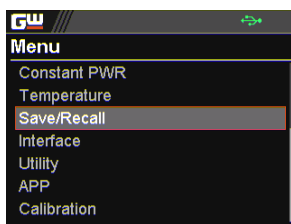
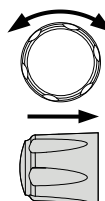

3. Scroll knob key to move to the Recall Mem Set field. Click knob key to enter the field followed by scrolling knob key to select one of the options to recall setting. Click knob key again to confirm.

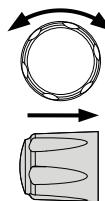

Options M1 ~ M10, Default

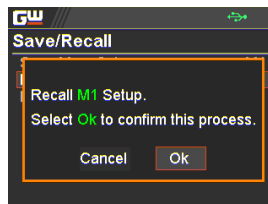
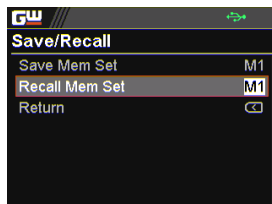



Note

When default is selected, the unit will restore back to the factory default setting.

Recall Memory from front panel keys

1. Press the Shift key followed by M1 ~ M3 key on front panel to promptly recall the set setting.

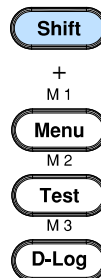

2. The M1 ~ M3 memory setting is thus recalled quickly with ease.

Single Load

1. Connect the +S terminal to the positive potential of the load. Connect the -S terminal to the negative potential of the load.

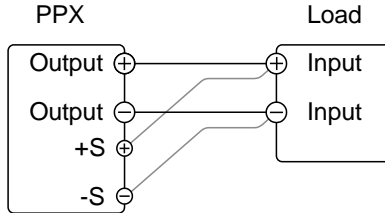

2. Operate the instrument as normal. See the Basic Operation chapter for details.

Wire Shielding and Load line impedance

To help to minimize the oscillation due to the inductance and capacitance of the load cables, use an electrolytic capacitor in parallel with the load terminals.

To minimize the effect of load line impedance use twisted wire pairing.

Shield the sense wires and connect the shield to the chassis ground.

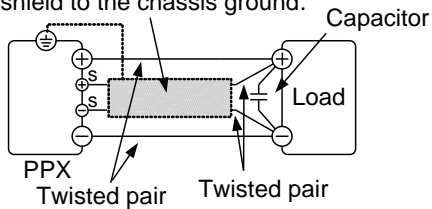

Temperature

The PPX series can measure DUT temperature while power output simultaneously. Prior to temperature measurement, utilize the optional accessory GTL-205A, which includes a temperature probe adaptor with thermocouple K type, to connect between DUT and TC input on the front panel of PPX series.

The optional GTL-205A

Temperature probe adaptor with thermocouple K type with 1000mm in length.



Steps

1. Press the Menu key to enter the Menu page.



2. Scroll the knob key to move to the Temperature field followed by clicking the knob key to enter the Temperature page.

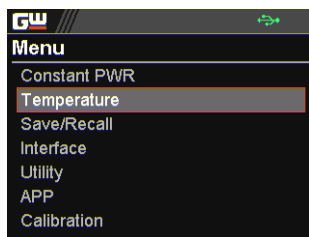
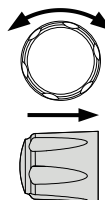

3. Scroll knob key to move to the Unit field. Click knob key to enter the field followed by scrolling knob key to select one of the options for temperature unit display. Click knob key again to confirm.

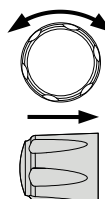

Options °C, °F

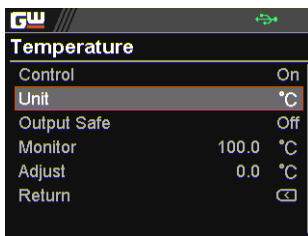

4. Scroll knob key to move to the Output Safe field, which is used to monitor temperature of DUT with user-defined threshold. The power output stops once threshold is met. Click knob key to enter the field followed by scrolling knob key to turn On/Off the function, along with the arrow keys to change among digits. Click knob key again to confirm.

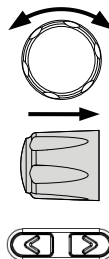

Options On, Off

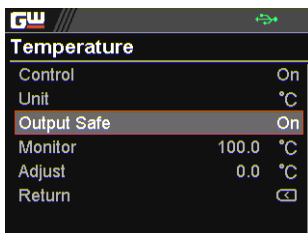

5. Scroll knob key to move to the Monitor field, which sets temperature threshold that goes with Output Safe function. Click knob key to enter the field followed by scrolling knob key to set temperature value, along with the arrow keys to change among digits. Click knob key again to confirm.

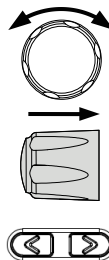

Options °C -200.0 ~ 1372.0
 °F -328.0 ~ 2501.6

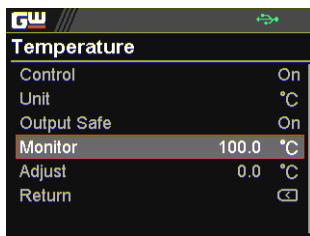

6. Scroll knob key to move to the Adjust field, which acts like a user-defined offset value in accordance with environment factors by user preference. Click knob key to enter the field followed by scrolling knob key to set adjust value, along with the arrow keys to change among digits. Click knob key again to confirm.

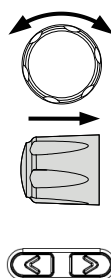

Options °C -2.5 ~ 2.5
 °F -4.5 ~ 4.5

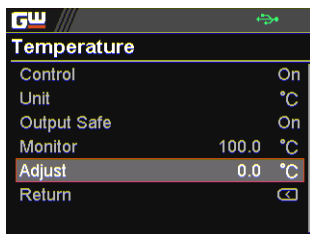

7. Scroll knob key to move to the Control field. Click knob key to enter the field followed by scrolling knob key to turn On/Off the temperature measurement function. Click knob key to confirm.

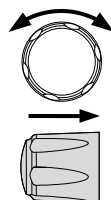

Options On, Off

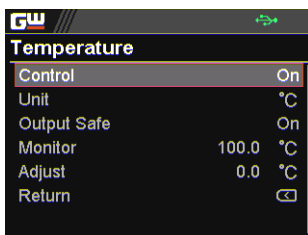

Temperature measurement status

When it is under V, A and Temperature display mode, a thermometer icon appears in the lower-left corner and varied colors of the icon represent different statuses as follows.

Blue

Temperature Control On with no GTL-205A connected

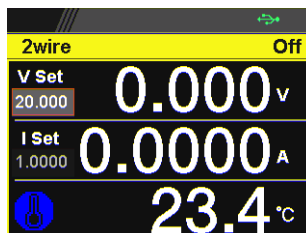

White

Temperature Control On with GTL-205A connected

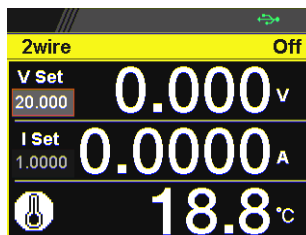

Green

Output Safe is activated and Output is On with GTL-205A connected

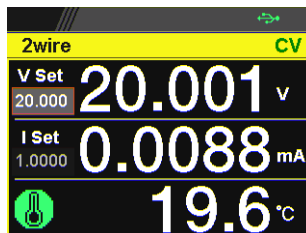

Red

The alarm of short circuit occurs from temperature measurement

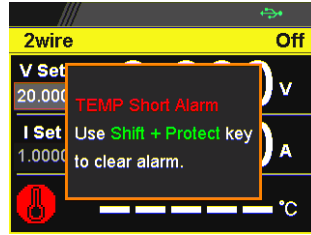

Data Logger

The PPX series can save measured voltage, current and temperature data into either USB flash disk or send the data to program via remote control.

Steps

1. Press the D-Log key to enter the Data Logger page.

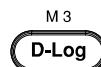

2. Scroll the knob key to move to the Sample Period field, which determines the interval of data log saving. Click knob key followed by scrolling it to adjust value, along with the arrow keys to change among digits. Click knob key again to confirm set period.

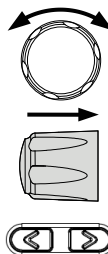

Range 0.1s ~ 999.9s

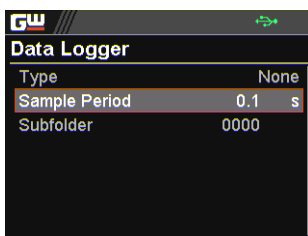

3. Scroll the knob key to move to the Subfolder field, which creates a user-defined serial number for folder in which up to 1000.csv files are stored. Click knob key followed by scrolling it to adjust serial number, along with the arrow keys to change among digits. Click knob key again to confirm setting.

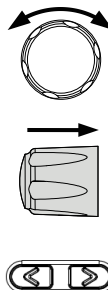

Range 0000 ~ 9999

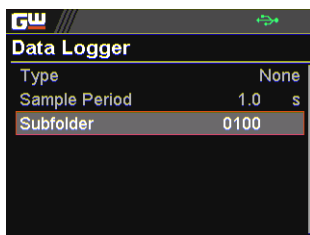

4. Scroll the knob key to move to the Type field. Click knob key followed by scrolling it to select a type for data log saving. Click knob key to confirm setting.

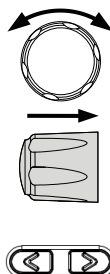

Type

- None No action will be executed.
- Save USB Save data log into USB disk. It is required to insert USB disk first.
- Send Remote Send data log to remote side via remote control in real time.

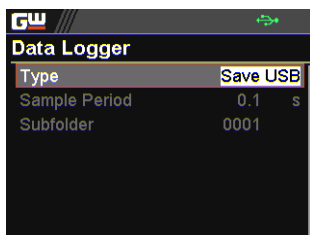

Dlog icon in main display

When Data Logger is activated, the Dlog icon will be shown on the main screen.

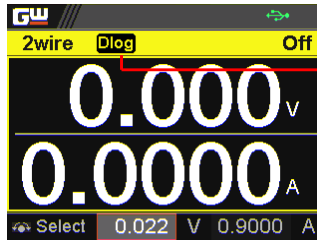

Dlog icon
appears



When the Save USB is selected, make sure that return to Data Logger page to select None for Type so that the latest data file can be saved properly.

Owing to the fact that data log is being transmitted in real time via remote control, when the Send Remote is selected, there is no need to return to Data Logger page to select None for Type.

Sequence Test

This section describes how to use the Sequence function to edit, run, load and save sequence scripts for automated testing. The sequence function is useful if you want to perform a number of tests automatically. The PPX sequence function can store up to 10 test scripts in internal memory and also into the connected USB disk.

Each test script can also be programmed in a scripting language. For more information on how to create sequence scripts via programs, please contact GW Instek.

Sequence Script File Format → from page 75

Sequence Script Settings → from page 75

Sequence Step Edit Settings → from page 77

Setting Sequence Script Configurations → from page 82

Run Sequence Script → from page 94

Load Sequence Script → from page 98

Save Sequence Script → from page 101

Sequence Script File Format

Background	The sequence script files are saved in the *.csv file format. When saving script file into internal memory, each file is saved as tXXX.csv where XXX is the file number from 001 to 010. When saving script file into the USB disk, each file is saved as S202_XXXX.csv where XXXX is the file serial number from 0001 to 9999.
------------	---

Sequence Script Settings

Background	This section mainly introduces the settings within the Sequence page.
Run	It runs sequence script automatically. A script can be saved in or loaded from the internal memory or USB disk. Once the Run field is turned On, return to the main display followed by pressing Output key to initiate the set sequence script. Run On, Off
Total Step	It determines the total steps for a sequence script. Each step can be edited from the Edit field. Total Step 1 ~ 20000
Cycle Number	It sets how many cycles will be repeated. For example, when a script consists of 6 steps and cycle number is set 3, the sequence runs the script, which contains step 1 ~ 6, for 3 times in a row. Cycle Number None No cycle will be repeated.

	INF	It indicates infinite cycles.
	1 ~ 1000000000	It sets cycle(s) from 1 to 1000000000 times.
Cycle Start		It sets which step is the starting step of cycle. The available steps options vary per total steps.
	Cycle Start	
	None	None of steps is for cycle start. It fits when no cycle will be executed.
	1 ~ 20000	It sets which step is the starting point of cycle.
Cycle End		It sets which step is the end step of cycle. The available steps options vary per total steps.
	Cycle End	
	None	None of steps is for cycle end. It fits when no cycle will be executed.
	1 ~ 20000	It sets which step is the end point of cycle.
 Note	Jump and Cycle functions can Not be activated at the same time. Refer to page 81 for details of Jump.	
Save		It saves a select sequence script into either internal memory or the connected USB disk.
	Save From	
	Edit	To select currently edited script as a source of script to be saved.
	S202_XXXX.csv	If connected USB disk contains saved scripts, the files are available to select.

Save To Internal

tXXX.csv To save the selected source script into a select internal memory from no. 001 to 010.

Save To USB

S202_XXXX.csv To save the selected source script into the USB disk from no. 0001 to 9999.

Load

It loads a select sequence script from either connected USB disk or internal memory. Note that when USB disk is plugged in, memory from USB disk will prioritize over internal memory.

S202_XXXX.csv To load script from USB disk (S202_XXXX.csv) or internal memory (tXXX.csv).

**Note**

When there is any issue occurred from settings, PPX series will not be able to run sequence script. The error code along with warning message will be shown within the prompt message box when Run filed is enabled.

Sequence Step Edit Settings

Background

This section mainly introduces the settings within the Sequence Edit page, which is used to edit several parameters for each step.

Step



To select which step to be edited. The available option(s) depends on the total step setting.

Step 1 ~ 20000

Point	It sets a core action for select step. The available options are described as follows.
	Point
Start	It sets which step is the starting step of an entire sequence script. Be aware that this Start step can only be set equal to or earlier than the "Cycle Start". For example, to set step 3 as Start and step 2 as Cycle Start is not available for PPX series.
End	It sets which step is the end step of an entire sequence script. Be aware that this End step can only be set equal to or later than the "Cycle End". For example, to set step 2 as End and step 3 as Cycle End is not available for PPX series.
Exit	It sets which step is the exit step of an entire sequence script. Generally, a sequence script can be executed again after finishing by pressing Output key. However, when Exit step is set, the sequence function won't be executed again after finishing by Output key directly.
Pause	It sets which step will be paused during a sequence script. When a sequence is paused, press Test key to continue running the sequence.
Trigin	It sets which step will be executed by trig-in signal. The Trigin step will be held until trig-in signal is received by PPX series unit.

Log0	It sets which step will be executed in stop action for the data log function. This relates to the Log1 and Log2 actions as the following sections.
Log1	It sets which step will be executed in the action of saving data log into USB disk. Once a sequence script runs to this step, data log will be kept saving into USB disk instantly until next Log0 action is met. Refer to page 71 for details.
Log2	It sets which step will be executed in the action of sending data log to remote control side. Once a sequence script runs to this step, data log will be kept sending to remote control side until next Log0 action is met. Refer to page 71 for details.
Output	It sets if power output will be activated for the select step. Output ON, OFF
Time	It sets time duration of execution for the select step. Time 0.05 ~ 999.99s
Voltage	It sets output voltage of CV mode for the select step. Voltage 0V ~ 105% rated voltage
Current	It sets output limit current of CC mode for the select step. Current 0A ~ 105% rated current

OVP Level	It sets over voltage protection setting for the select step. OVP Level 5% ~ 110% rated voltage
OCP Level	It sets over current protection setting for the select step. OCP Level 5% ~ 110% rated current
Bleeder	It enables or disables discharge loop control for the select step. Bleeder None, ON, OFF
V/I Slew Rate	It sets High Speed Priority and Slew Rate Priority of CV and CC modes for the select step. V/I Slew Rate CVHS It utilizes the fastest slew rate of CV mode. Refer to page 51 for more details. CCHS It utilizes the fastest slew rate of CC mode. Refer to page 55 for more details. CVLS It utilizes the user-configured slew rate of CV mode. When this option is selected, go to configure the R_V slew Rate (rising) and F_V slew rate (falling) settings, respectively. Refer to page 51 for more details. CCLS It utilizes the user-configured slew rate of CC mode. When this option is selected, go to configure the R_C slew Rate (rising) and F_C slew rate (falling) settings, respectively. Refer to page 55 for more details.

Buzzer	It enables or disables buzzer sound for the select step. Buzzer ON, OFF
Measure Average	It sets the speed level of display sampling for the measure average setting for the select step. More the average numbers (High), slower the display update. Refer to page 112 for details. Measure Average Off, Low, Middle, High
Jump To	It sets the target step to jump to. For example, when step 5 is set for Jump To under the step 2 Edit page, it means that when sequence runs to step 2, it will directly jump to step 5 at the end of step 2. The available step option(s) depends on the total step setting. Jump To 1 ~ 20000
Jump Count	It sets the number of times to loop the Jump To step action. Jump Count 1 ~ 10000
 Note	Jump and Cycle functions can Not be activated at the same time. Refer to page 75 for details of Cycle.
Trigger Out	It sets if trigger out signal will be transmitted when the sequence runs to the step. Trigger Out ON, OFF
 Note	When there is any issue occurred from settings, PPX series will not be able to run sequence script. The error code along with warning message will be shown within the prompt message box when Run filed is enabled.

Setting Sequence Script Configurations

Steps

1. Press Test key followed by clicking on Sequence field via knob key to enter the Sequence page.

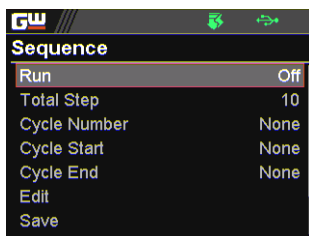

2. Scroll knob key to move to the Total Step field followed by clicking knob key to enter the field. Scroll knob key to adjust value along with arrow keys to change among digits followed by clicking knob key to confirm total steps.

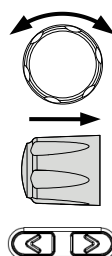
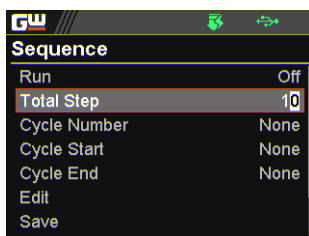

Total Step 1 ~ 20000

3. Scroll knob key to move to the Cycle Number field followed by clicking knob key to enter the field. Scroll knob key to adjust value along with arrow keys to change among digits followed by clicking knob key to confirm cycle number.

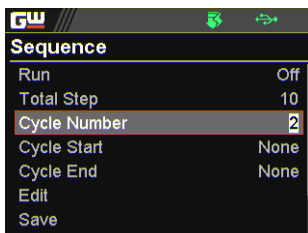
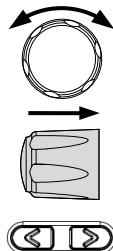

Cycle Number INF, 1 ~ 1000000000

4. Scroll knob key to move to the Cycle Start field followed by clicking knob key to enter the field. Scroll knob key to adjust value along with arrow keys to change among digits followed by clicking knob key to confirm cycle start.

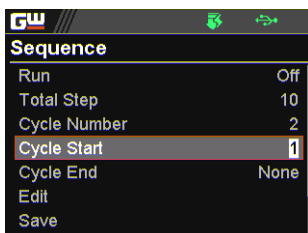
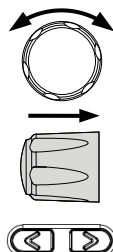

Cycle Start 1 ~ 20000

5. Scroll knob key to move to the Cycle End field followed by clicking knob key to enter the field. Scroll knob key to adjust value along with arrow keys to change among digits followed by clicking knob key to confirm cycle end.

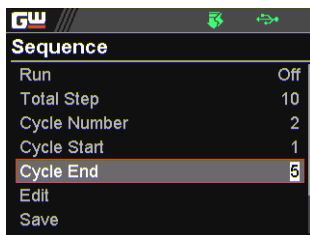
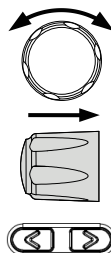

Cycle End 1 ~ 20000

6. Scroll knob key to move to the Edit field followed by clicking knob key to enter the Sequence Edit page.

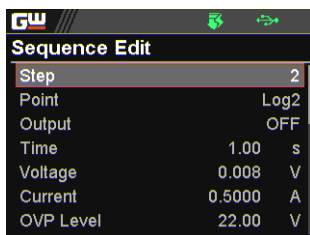
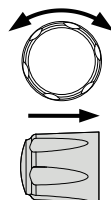

7. Scroll knob key to move to the Step field followed by clicking knob key to enter the field. Scroll knob key to select a step along with arrow keys to change among digits followed by clicking knob key to confirm the step to edit.

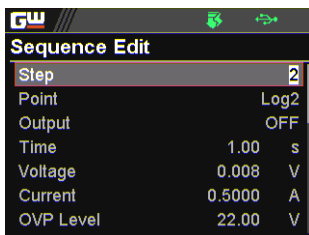
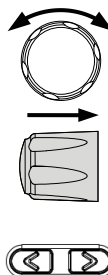

Step 1 ~ 20000

8. Scroll knob key to move to the Point field followed by clicking knob key to enter the field. Scroll knob key to select an action followed by clicking knob key to confirm the action for the step to edit.

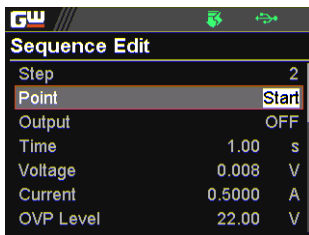
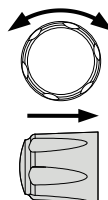

Point Start, End, Exit, Pause, Trigin,
Log0, Log1, Log2

9. Scroll knob key to move to the Output field followed by clicking knob key to enter the field. Scroll knob key to turn on/off output followed by clicking knob key to confirm output action.

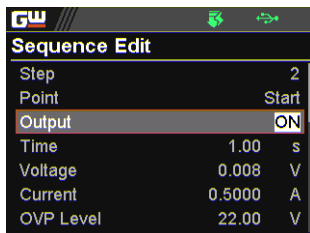
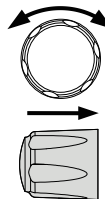

Output ON, OFF

10. Scroll knob key to move to the Time field followed by clicking knob key to enter the field. Scroll knob key to adjust value along with arrow keys to change among digits followed by clicking knob key to confirm time setting.

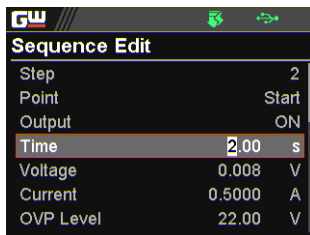
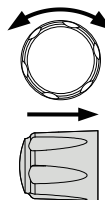

Time 0.05 ~ 999.99s



11. Scroll knob key to move to the Voltage field followed by clicking knob key to enter the field. Scroll knob key to adjust value along with arrow keys to change among digits followed by clicking knob key to confirm voltage setting.

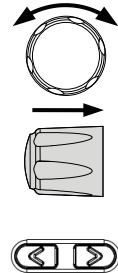

Sequence Edit	
Step	2
Point	Start
Output	ON
Time	2.00 s
Voltage	0.028 V
Current	0.5000 A
OVP Level	22.00 V

Voltage 0V ~ 105% rated voltage

12. Scroll knob key to move to the Current field followed by clicking knob key to enter the field. Scroll knob key to adjust value along with arrow keys to change among digits followed by clicking knob key to confirm current setting.

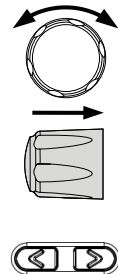

Sequence Edit	
Step	2
Point	Start
Output	ON
Time	2.00 s
Voltage	0.028 V
Current	0.5000 A
OVP Level	22.00 V

Current 0A ~ 105% rated current

13. Scroll knob key to move to the OVP Level field followed by clicking knob key to enter the field. Scroll knob key to adjust value along with arrow keys to change among digits followed by clicking knob key to confirm OVP setting.

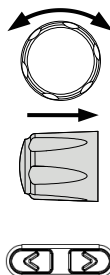

Sequence Edit	
Step	2
Point	Start
Output	ON
Time	2.00 s
Voltage	0.028 V
Current	0.6000 A
OVP Level	19.00 V

OVP Level 5% ~ 110% rated voltage

14. Scroll knob key to move to the OCP Level field followed by clicking knob key to enter the field. Scroll knob key to adjust value along with arrow keys to change among digits followed by clicking knob key to confirm OCP setting.

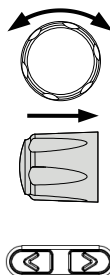

Sequence Edit	
Point	Start
Output	ON
Time	2.00 s
Voltage	0.028 V
Current	0.6000 A
OVP Level	19.00 V
OCP Level	1.100 A

OCP Level 5% ~ 110% rated current

15. Scroll knob key to move to the Bleeder field followed by clicking knob key to enter the field. Scroll knob key to turn on/off bleeder followed by clicking knob key to confirm bleeder action.

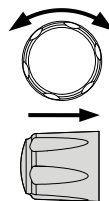

Sequence Edit		
Output		ON
Time	2.00	s
Voltage	0.028	V
Current	0.6000	A
OVP Level	19.00	V
OCP Level	1.100	A
Bleeder		ON

Bleeder ON, OFF

16. Scroll knob key to move to the V/I Slew Rate field followed by clicking knob key to enter the field. Scroll knob key to select an option followed by clicking knob key to confirm V/I slew rate setting.

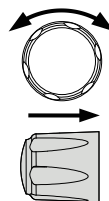

Sequence Edit		
Time	2.00	s
Voltage	0.028	V
Current	0.6000	A
OVP Level	19.00	V
OCP Level	1.100	A
Bleeder		ON
V/I Slew Rate		CVLS

V/I Slew Rate CVHS, CCHS, CVLS, CCLS

When CVLS is selected in previous step, scroll knob key to R_V Slew Rate and F_V Slew Rate fields respectively followed by clicking knob key to enter each field.

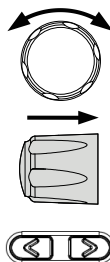

Scroll the knob key to adjust value, along with the arrow keys to change among digits followed by clicking knob key to confirm set value, respectively.

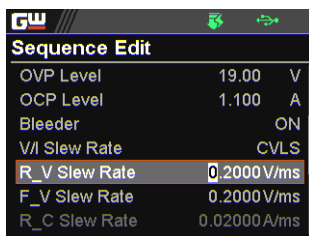

When CCLS is selected in previous step, scroll knob key to R_C Slew Rate and F_C Slew Rate fields respectively followed by clicking knob key to enter each field.

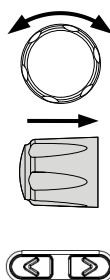

Scroll the knob key to adjust value, along with the arrow keys to change among digits followed by clicking knob key to confirm set value, respectively.

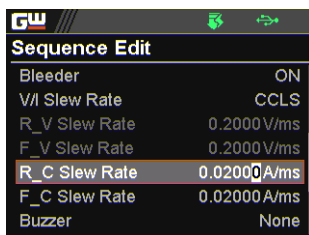

17. Scroll knob key to move to the Buzzer field followed by clicking knob key to enter the field. Scroll knob key to turn on/off buzzer followed by clicking knob key to confirm buzzer setting.

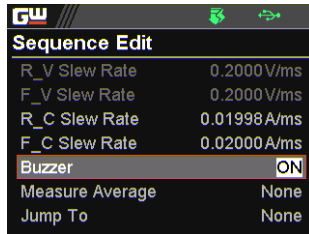
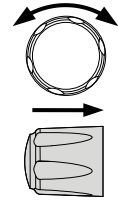

Buzzer ON, OFF

18. Scroll knob key to move to the Measure Average field followed by clicking knob key to enter the field. Scroll knob key to select an option followed by clicking knob key to confirm the setting.

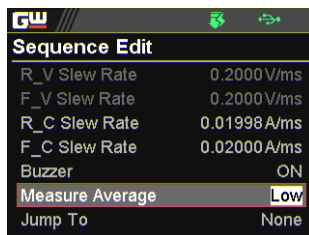
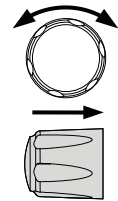

Measure Average Off, Low, Middle, High

19. Scroll knob key to move to Jump To field followed by clicking knob key to enter the field. Scroll knob key to select a step number along with arrow keys to change among digits followed by clicking knob key to confirm step to jump to.

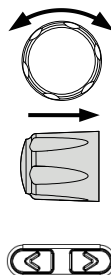

Sequence Edit	
R_V Slew Rate	0.2000 V/ms
F_V Slew Rate	0.2000 V/ms
R_C Slew Rate	0.01998 A/ms
F_C Slew Rate	0.02000 A/ms
Buzzer	ON
Measure Average	Low
Jump To	2

Jump To 1 ~ 20000

20. Scroll knob key to move to Jump Count field followed by clicking knob key to enter the field. Scroll knob key to select a count number along with arrow keys to change among digits followed by clicking knob key to confirm jump count.

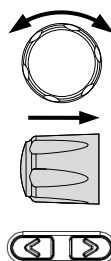

Sequence Edit	
R_C Slew Rate	0.01998 A/ms
F_C Slew Rate	0.02000 A/ms
Buzzer	ON
Measure Average	Low
Jump To	2
Jump Count	3
Trigger Out	None

Jump Count 1 ~ 10000

21. Scroll knob key to move to the Trigger Out field followed by clicking knob key to enter the field. Scroll knob key to turn on/off the function followed by clicking knob key to confirm the selection.

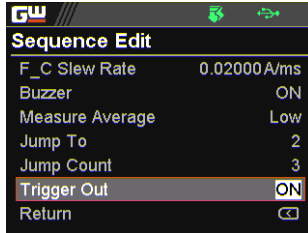
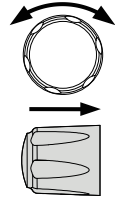

Trigger Out ON, OFF

22. Repeat the previous step 7 to step 21 for each step individually within a sequence script.

Run Sequence Script

Overview

After well setting the relevant configurations from Sequence and Sequence Edit pages, it is ready to launch a sequence script test. Also, it is available to load script from internal memory or the connected USB disk. See page 98 for how to load sequence script.

Steps

1. Press Test key followed by clicking on Sequence field via knob key to enter the Sequence page.

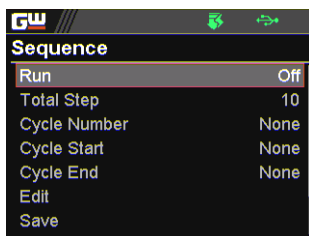

2. Scroll knob key to move to the Run field followed by clicking knob key to enter the field. Scroll knob key to turn On followed by clicking knob key to confirm setting.

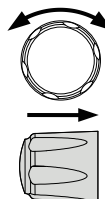
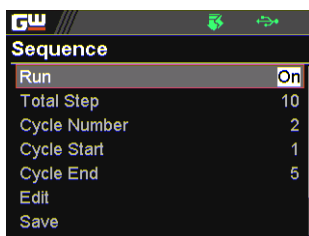

Run On, Off

3. The Test key will be illuminated in yellow light on the front panel.



- Press the Test key to switch to display mode in which press Display key repeatedly until the V, A and Sequence mode is shown. The SEQ icon is displayed on the top banner accordingly.

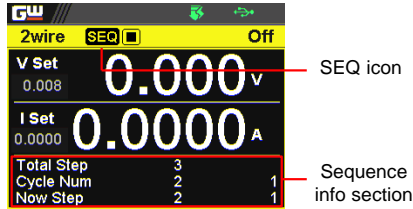
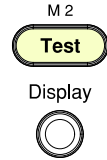

- Press the Output key to execute the sequence script test. See the figures below for descriptions on varied conditions.



SEQ stop in cycle mode

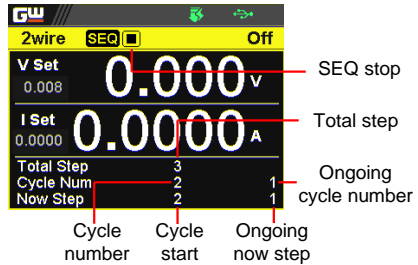

SEQ run in cycle mode

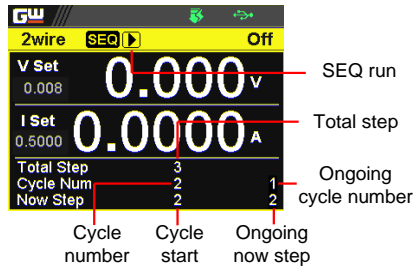

SEQ pause
in cycle
mode

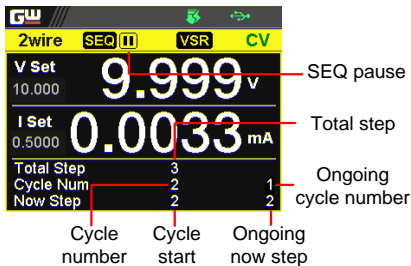

SEQ trigin
in cycle
mode

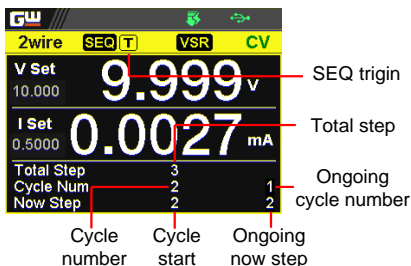

SEQ stop in
jump mode

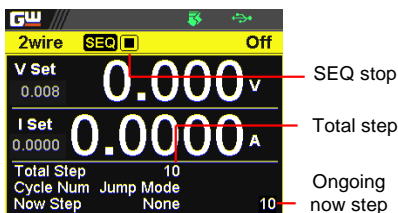

SEQ run in
jump mode

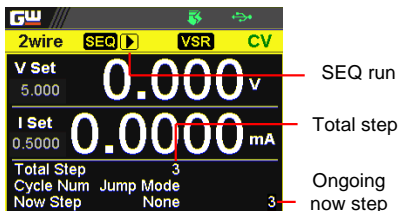

SEQ pause
in jump
mode

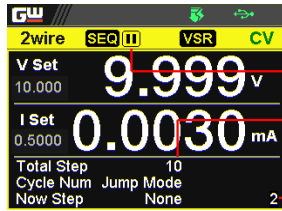

SEQ
pause
Total step
Ongoing
now step

SEQ trigin
in jump
mode

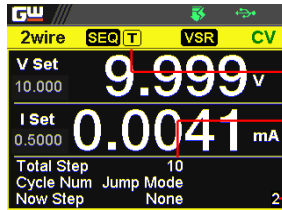

SEQ
trigin
Total step
Ongoing
now step



Note

When a script is running, pressing the Output key will abort the execution of the script immediately. The Output key illumination will turn off.

Load Sequence Script

Overview

A sequence script can be loaded from either USB disk or internal memory. When USB disk is connected with PPX series, the script file in USB disk has higher priority over internal memory; that is, user can only load script file in USB disk when USB disk is plugged in. Prior to loading script from USB disk, ensure the script file is placed in root directory.

Load script from USB disk

1. Insert a USB disk into the front panel USB-A port. Ensure the USB disk contains a test script in root directory.
2. The icon of USB disk detection will be displayed on the upper status bar after a few seconds if the USB disk is recognized.

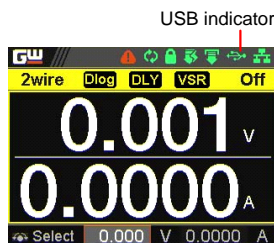

3. Press Test key followed by clicking on Sequence field via knob key to enter the Sequence page.

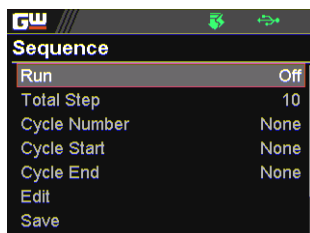

4. Scroll knob key to move to the Load field followed by clicking knob key to enter the field. Scroll knob key to select an available script from USB disk.
(Format: S202_XXXX.csv).

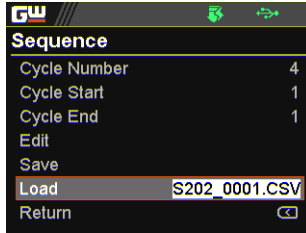
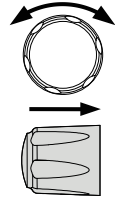

5. The prompt window appears as follows. Click knob key to confirm loading the select script file.

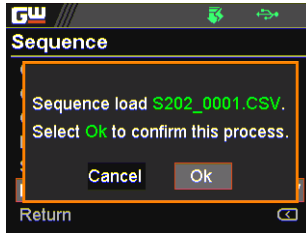
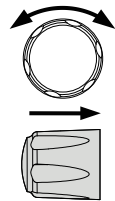

Load script from internal memory

1. Press Test key followed by clicking on Sequence field via knob key to enter the Sequence page.

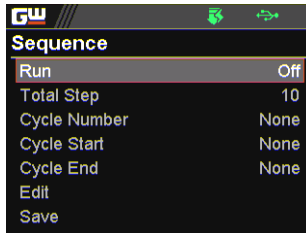
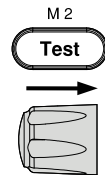

2. Scroll knob key to move to the Load field followed by clicking knob key to enter the field. Scroll knob key to select an available script from internal memory (Format: tXXX.csv).

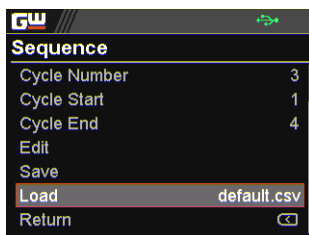
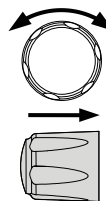

3. The prompt window appears as follows. Click knob key to confirm loading the select script file.

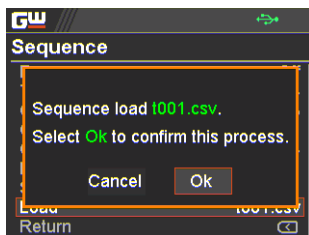
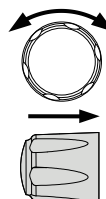

Save Sequence Script

Overview

A sequence script can be saved from either an edited one or USB disk to either internal memory or USB disk. Prior to saving script from USB disk, ensure the script file is placed in root directory. When saving script to USB disk, ensure USB disk is plugged into PPX series.

Save script from edited one to internal memory

1. Press Test key followed by clicking on Sequence field via knob key to enter the Sequence page.

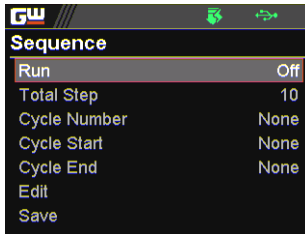
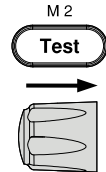

2. Scroll knob key to move to the Save field followed by clicking knob key to enter the Sequence Save page.

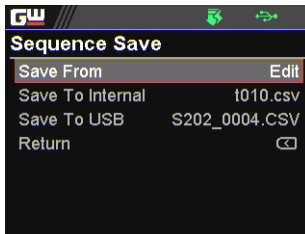
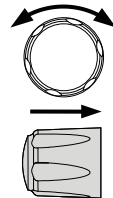

- Click knob key to enter the Save From field followed by scrolling knob key to select Edit option. Click knob key again to confirm selection.

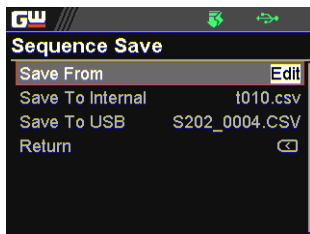
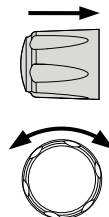

- Scroll knob key to move to the Save To Internal field followed by clicking knob key to enter the field. Scroll knob key to select a target memory (Format: tXXX.csv).

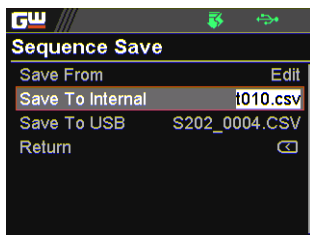
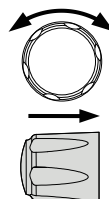

- Click knob key and the prompt window shows as follows. Click knob key again to confirm saving Edit to target tXXX.csv.

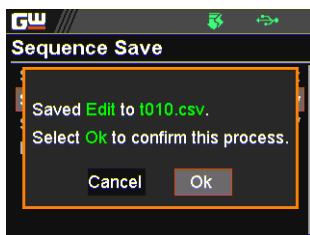
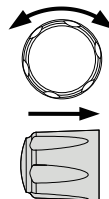

Save script from USB disk to internal memory

1. Insert a USB disk into the front panel USB-A port. Ensure the USB disk contains a test script in root directory.
2. The icon of USB disk detection will be displayed on the upper status bar after a few seconds if the USB disk is recognized.

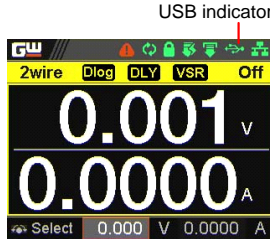

3. Press Test key followed by clicking on Sequence field via knob key to enter the Sequence page.

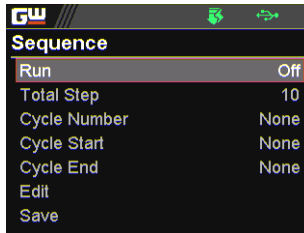
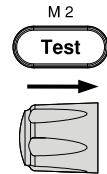

4. Scroll knob key to move to the Save field followed by clicking knob key to enter the Sequence Save page.

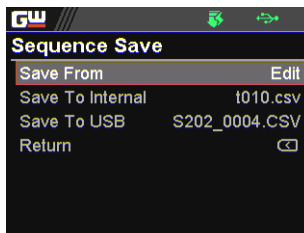
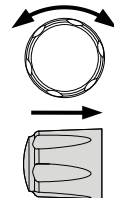

- Click knob key to enter the Save From field followed by scrolling knob key to select a script file from USB disk (Format: S202_XXXX.csv). Click knob key to confirm selection.

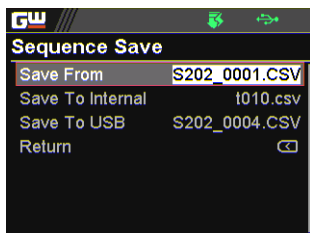
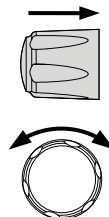

- Scroll knob key to move to the Save To Internal field followed by clicking knob key to enter the field. Scroll knob key to select a target memory (Format: tXXX.csv).

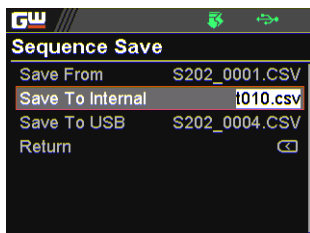
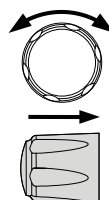

- Click knob key and the prompt window shows as follows. Click knob key again to confirm saving S202_XXXX.csv to target tXXX.csv.

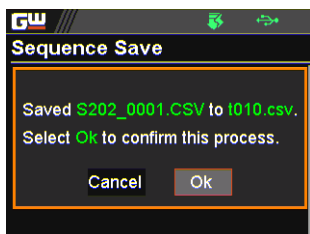
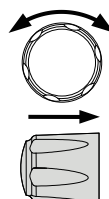

Save script from edited one to USB disk

1. Insert a USB disk into the front panel USB-A port.



2. The icon of USB disk detection will be displayed on the upper status bar after a few seconds if the USB disk is recognized.

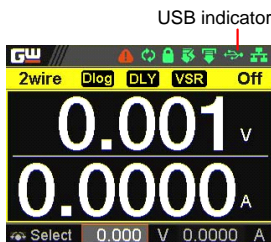

3. Press Test key followed by clicking on Sequence field via knob key to enter the Sequence page.

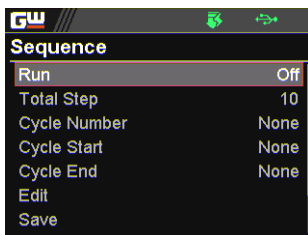
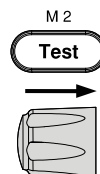

4. Scroll knob key to move to the Save field followed by clicking knob key to enter the Sequence Save page.

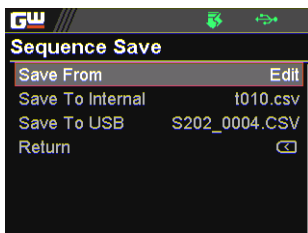
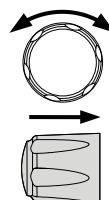

- Click knob key to enter the Save From field followed by scrolling knob key to select Edit option. Click knob key again to confirm selection.

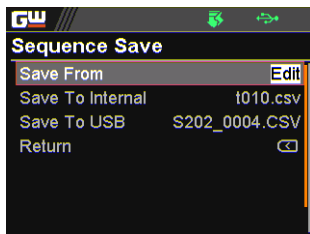
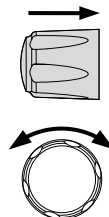

- Scroll knob key to move to the Save To USB field followed by clicking knob key to enter the field. Scroll knob key to select a target memory (Format: S202_XXXX.csv).

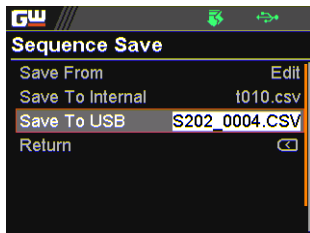
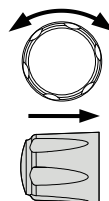

- Click knob key and the prompt window shows as follows. Click knob key again to confirm saving Edit to target S202_XXXX.csv.

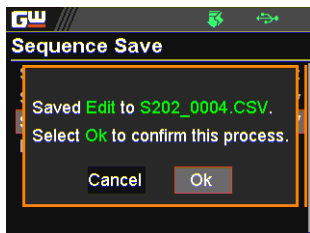
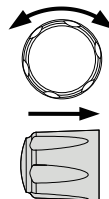

MENU CONFIGURATION

Configuration Overview	108
Output.....	108
Measurement.....	112
EXT Control	115
TRIG Control	120
PWR On Config.....	126
Constant PWR.....	127
Temperature	130
Save/Recall	134
Interface	137
Utility	144
APP.....	152
Calibration	155

Configuration Overview

The MENU configuration of PPX series consists of Output setting, Measurement setting, EXT Control setting, TRIG Control setting, PWR On Config setting, Constant PWR setting, Temperature setting, Save/Recall setting, Interface setting, Utility setting, APP setting and Calibration setting. The last Calibration setting, which also includes System firmware update, is generally not recommended for end-user use.

Output

Output
On/Off Dly

It delays turning the output on/off for a designated amount of time. Note that this function has a maximum deviation (error) of 20ms and is disabled when the output is set to external control.

1. Press the Menu key followed by scrolling knob key to move to Output field.

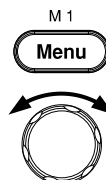
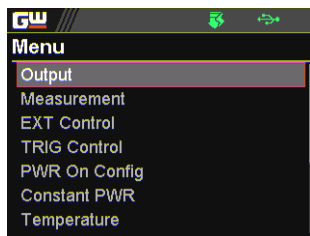

- Click knob key to enter the Output page. Scroll knob key to move to Output On/Off Dly fields, respectively, followed by clicking knob key to enter each field.

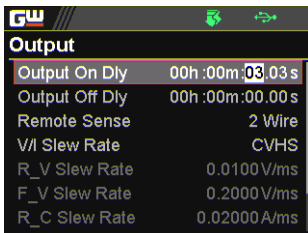
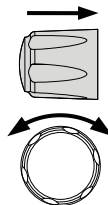

- Click arrow keys to move among each unit (h:m:s). Scroll knob key to change value followed by clicking the knob key to confirm the set value.

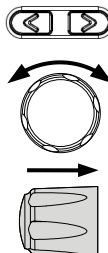

Output	00h:00m:00.00s ~
On/Off Dly	99h:59m:59.99s

Remote Sense	To determine 2 Wire or 4 Wire connection.
--------------	---

- Scroll knob key to move to Remote Sense field followed by clicking knob key to enter the field.

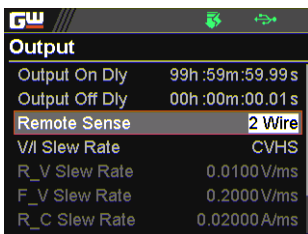
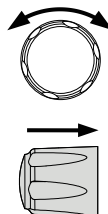

5. Scroll the knob key to select option followed by clicking the knob key to confirm the selection.

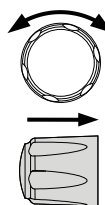

Remote Sense 2 Wire, 4 Wire

V/I Slew Rate

The C.V. and C.C. mode have two selectable slew rates: High Speed Priority (CVHS, CCHS) and Slew Rate Priority (CVLS, CCLS). High Speed Priority will use the fastest slew rate for the instrument while Slew Rate Priority will use a user-configured slew rate.

6. Scroll knob key to move to V/I Slew Rate field followed by clicking knob key to enter the field.

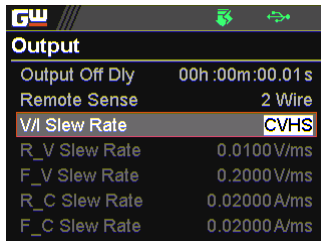
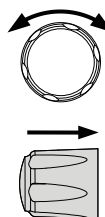

7. Scroll the knob key to select option followed by clicking the knob key to confirm the selection.

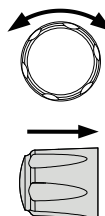

V/I Slew Rate CVHS, CVLS, CCHS, CCLS

8. When CVLS or CCLS is selected, scroll knob key to R_V Slew Rate or F_V Slew Rate fields followed by clicking knob key to enter the fields, respectively.

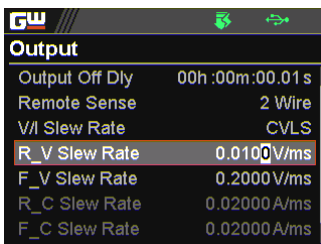
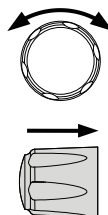

9. Scroll the knob key to adjust value, along with the arrow keys to change among digits followed by clicking the knob key to confirm set value, respectively.

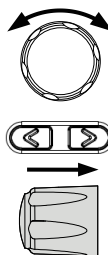

R_V Slew Rate / F_V Slew Rate Setting Range		
Model	Max. Value	Min. Value
PPX-1005	0.0001V/ms	0.1V/ms
PPX-2002	0.0001V/ms	0.2V/ms
PPX-2005	0.0001V/ms	0.2V/ms
PPX-3601	0.0001V/ms	0.36V/ms
PPX-3603	0.0001V/ms	0.36V/ms
PPX-10H01	0.001V/ms	0.5V/ms

Measurement

Measure
Average

It sets the speed level of display sampling for the measure average setting. More the average numbers (High), slower the display update. By contrast, the Off option indicates no sampling average and thus with the fastest speed in display update.

1. Press the Menu key followed by scrolling knob key to move to Measurement field.

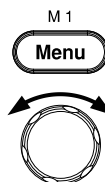
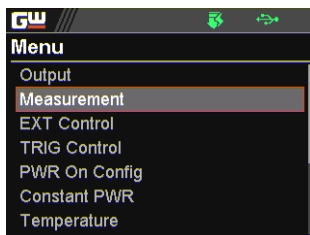

2. Click knob key to enter the Measurement page. Scroll knob key to move to Measure Average field followed by clicking knob key to enter the field.

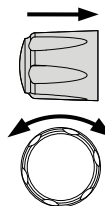
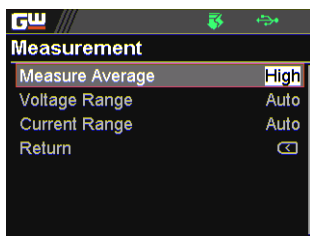

3. Scroll knob key to change option followed by clicking the knob key to confirm the selection.

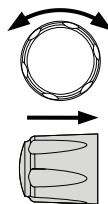

Measure Average High, Middle, Low, Off

Voltage Range

It sets display range for voltage.

4. Scroll knob key to move to Voltage Range field followed by clicking knob key to enter the field.

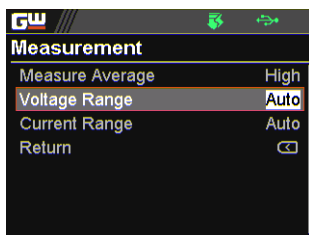
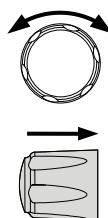

5. Scroll the knob key to select option followed by clicking the knob key to confirm the selection.

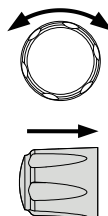

Voltage Range

- Auto It judges and adjusts range automatically
- VH 10% * rated voltage ~ rated voltage
- VL 0% ~ 10% * rated voltage

Current Range It sets display range for current.

6. Scroll knob key to move to Current Range field followed by clicking knob key to enter the field.

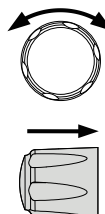
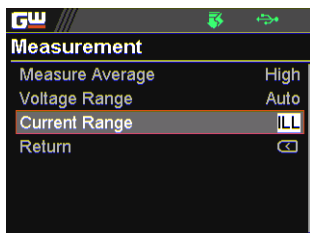

7. Scroll the knob key to select option followed by clicking the knob key to confirm the selection.

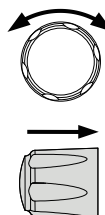

Current Range

- Auto It judges and adjusts range automatically
- IH 0.1 * rated current ~ rated current
- IM 0.01 * rated current ~ 0.1 * rated current
- IL 0.001 * rated current ~ 0.01 * rated current
- ILL 0 ~ 0.001 * rated current

EXT Control

CV Control

By connecting with an external voltage or resistance control, it can output voltage in the Constant Voltage (CV) control. Both CV and CC controls can be enabled simultaneously.

Before setting the EXT Control, ensure that:
 The output is off.

The load is not connected.

1. Press the Menu key followed by scrolling knob key to move to EXT Control field.

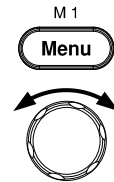
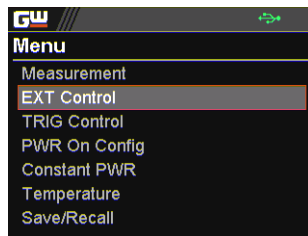

2. Click knob key to enter the EXT Control page. Scroll knob key to move to CV Control field followed by clicking knob key to enter the field.

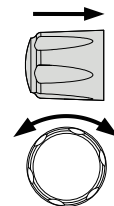
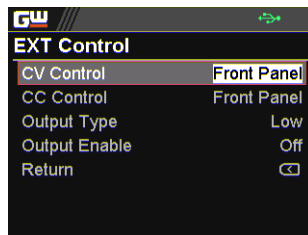

3. Scroll knob key to select option followed by clicking the knob key to confirm the selection.

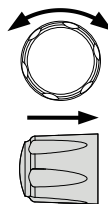

CV Control Option

Front	Internal control for the CV range.
External V	External voltage control of the voltage output is performed by the EXT I/O connector. A voltage of 0~10V is used to control CV setting. The input voltage of 0~10V is equivalent to the CV range. Pay attention to ground and common ground issues.
External R	External resistance control of the voltage output is performed by the EXT I/O connector. A resistance of 0 Ω ~10k Ω is used to control CV setting. The input resistance of 0~10k Ω is equivalent to CV range.

CC Control

By connecting with an external voltage or resistance control, it can output current in the Constant Current (CC) control. Both CV and CC controls can be enabled simultaneously.

Before setting the EXT Control, ensure that:

The output is off.

The load is not connected.

4. Scroll knob key to move to CC Control field followed by clicking knob key to enter the field.

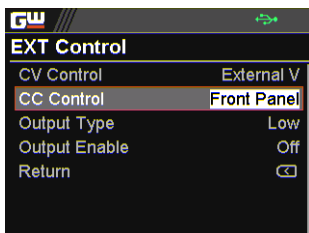
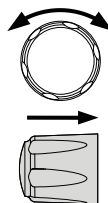

5. Scroll knob key to select option followed by clicking the knob key to confirm the selection.

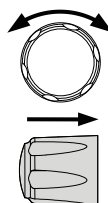

CC Control Option

- | | |
|------------|--|
| Front | Internal control for the CC range. |
| External V | External voltage control of the current output is performed by the EXT I/O connector. A voltage of 0~10V is used to control CC setting. The input voltage of 0~10V is equivalent to the CC range.

Pay attention to ground and common ground issues. |
| External R | External resistance control of the current output is performed by the EXT I/O connector. A resistance of 0Ω~10kΩ is used to control CC setting. The input resistance of 0~10kΩ is equivalent to CC range. |

Output Type Via the pin 10 of EXT I/O connector, power output can be activated through either a high or low signal externally.

Before setting the EXT Control, ensure that:
The output is off.

The load is not connected.

6. Scroll knob key to move to Output Type field followed by clicking knob key to enter the field.

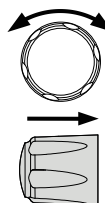
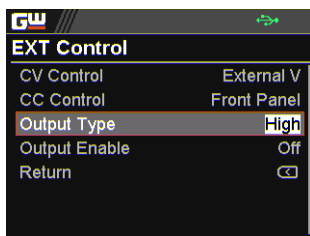

7. Scroll knob key to select option followed by clicking the knob key to confirm the selection.

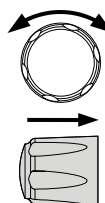

Output Type Option

- | | |
|-------------|---|
| High | Power output can be turned on externally using a high signal. |
| Low | Power output can be turned on externally using a low signal. |

Output Enable

Prior to external signal control, it is required to turn On Output Enable so that power output can be activated via external high/low signal.

Before setting the EXT Control, ensure that:

The output is off.

The load is not connected.

8. Scroll knob key to move to Output Enable field followed by clicking knob key to enter the field.

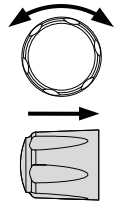
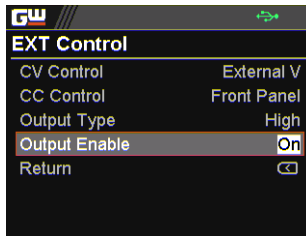

9. Scroll knob key to turn On or Off followed by clicking the knob key to confirm the setting.

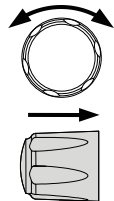

Output Enable Option

On The Output Type (High/Low) control is available when this function is turned On.

Off The Output Type (High/Low) control is not available when this function is turned Off.

TRIG Control

Trigin Level

It determines what signal (High or Low) will trigger the trigger-in action.

Before setting the TRIG Control, ensure that:

The output is off.

The load is not connected.

1. Press the Menu key followed by scrolling knob key to move to TRIG Control field.

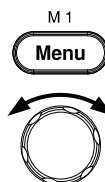
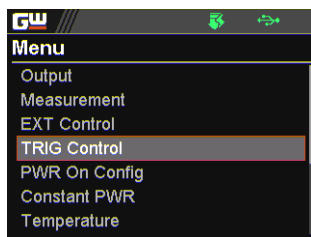

2. Click knob key to enter the TRIG Control page. Scroll knob key to move to Trigin Level field followed by clicking knob key to enter the field.

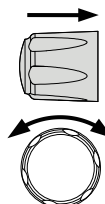
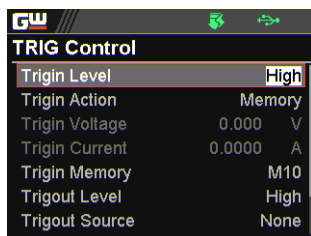

3. Scroll knob key to select option followed by clicking the knob key to confirm the selection.

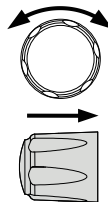

Trigin Level High, Low

Trigin Action

To determine the ensuing action when trigger-in signal is received.

4. Scroll knob key to move to Trigin Action field followed by clicking knob key to enter the field.

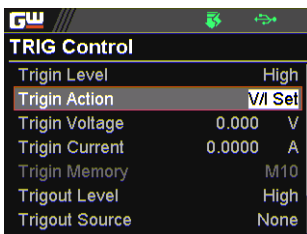
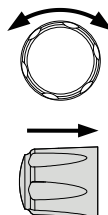

5. Scroll the knob key to select option followed by clicking the knob key to confirm the selection.

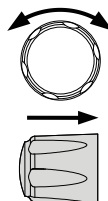

Trigin Action

- None None of actions will be executed.
- Output PPX will turn On/Off power output when trigger-in signal is received.

- V/I Set PPX will change to the predefined V/I settings when trigger-in signal is received. It is required to set Trigin Voltage and Trigin Current, individually before enabling V/I Set.
- Memory PPX will change to the predefined Trigin Memory when trigger-in signal is received. It is required to set Trigin Memory before enabling Memory.

Trigin Voltage & Trigin Current

6. Scroll knob key to move between Trigin Voltage and Trigin Current fields. Click the knob key to enter each field, respectively. Scroll the knob key to adjust value, along with the arrow keys to change among digits followed by clicking the knob key to confirm set value.

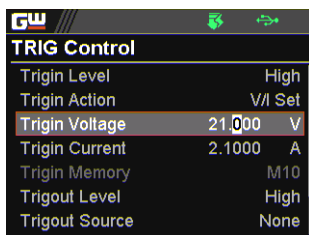
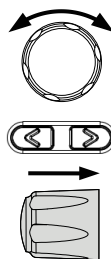

Model	Setting Range	
	Trigin Voltage	Trigin Current
PPX-1005	0.000 ~ 10.500V	0.0000 ~ 5.2500A
PPX-2002	0.000 ~ 21.000V	0.0000 ~ 2.1000A
PPX-2005	0.000 ~ 21.000V	0.0000 ~ 5.2500A
PPX-3601	0.000 ~ 37.800V	0.0000 ~ 1.0500A
PPX-3603	0.000 ~ 37.800V	0.0000 ~ 3.1500A
PPX-10H01	0.000 ~ 105.000V	0.0000 ~ 1.0500A

Trigin Memory

7. Scroll knob key to move to Trigin Memory field. Click the knob key to enter the field. Scroll the knob key to selection option followed by clicking knob key to confirm the memory selection.

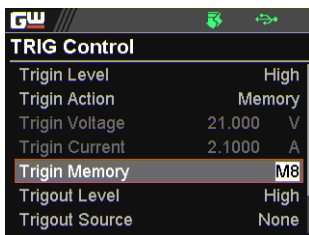
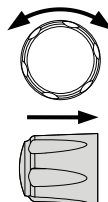

Trigin Memory M1 ~ M10

Trigout Level

It determines what trigger-out signal (High or Low) will be transmitted after execution of predefined Trigout Source from PPX series.

8. Scroll knob key to move to Trigout Level field followed by clicking knob key to enter the field.

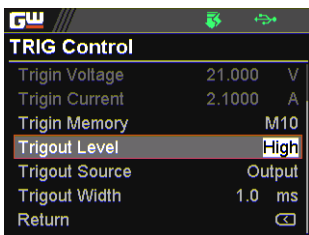
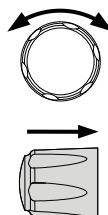

9. Scroll knob key to select option followed by clicking the knob key to confirm the selection.

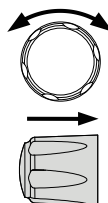

Trigout Level High, Low

Trigout Source To determine what source of action to launch the trigger-out signal.

10. Scroll knob key to move to Trigout Source field followed by clicking knob key to enter the field.

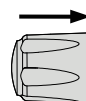
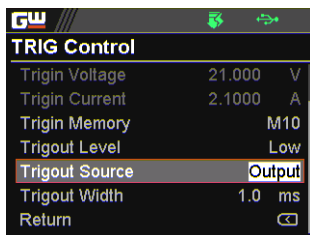
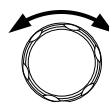

11. Scroll the knob key to select option followed by clicking the knob key to confirm the selection.

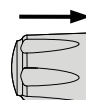
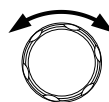

Trigout Source

- None No trigger-out signal will be sent out.
- Output When power output is turned On/Off, a trigger-out signal will be sent out.
- V/I Set When V/I set is adjusted from PPX, a trigger-out signal will be sent out.
- Memory When one of memories is recalled on PPX, a trigger-out signal will be sent out.

Trigout Width To determine the duration period for width of trigger-out signal.

12. Scroll the knob key to move to the Trigout Width field followed by clicking knob key to enter the field.

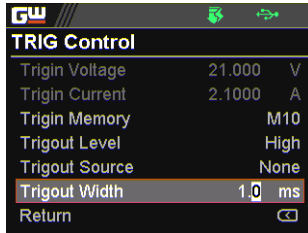
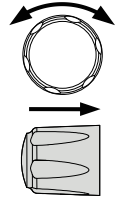

13. Scroll knob key to adjust value, along with the arrow keys to change among digits. Click knob key again to confirm set value.

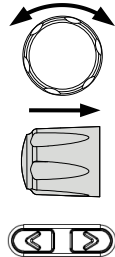

Trigout Width 1.0 ~ 100.0 ms

PWR On Config

- Power On Status It determines power output On or Off when PPX unit is starting up.
- Safe: Output Off at startup.
 - Force: Output On at startup.
 - Auto: Output follows the previous status.

1. Press the Menu key followed by scrolling knob key to move to PWR On Config field.

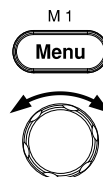
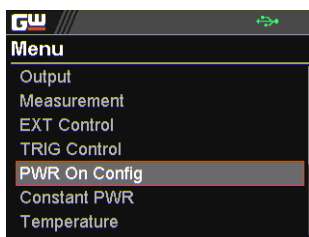

2. Click knob key to enter the PWR On Config page. Scroll knob key to move to Power On Status field followed by clicking knob key to enter the field.

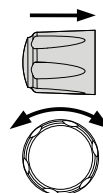
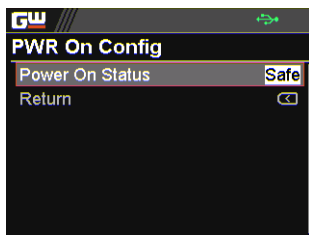

3. Scroll knob key to select option followed by clicking the knob key to confirm the selection.

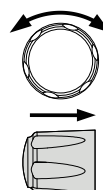

Power On Status Safe, Force, Auto

Constant PWR

Control

To turn On or Off the Constant PWR function, which indicates the output power watt(s) will be fixed in the set value.

1. Press the Menu key followed by scrolling knob key to move to Constant PWR field.

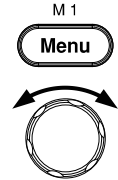
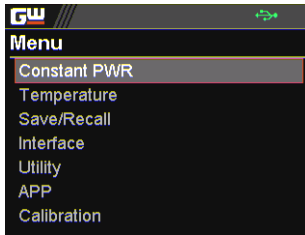

2. Click knob key to enter the Constant PWR page. Scroll knob key to move to Control field followed by clicking knob key to enter the field.

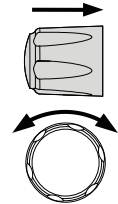
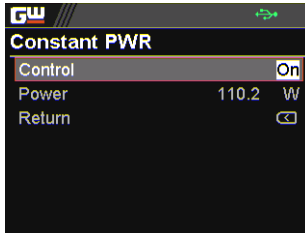

3. Scroll knob key to turn On or Off the function by clicking the knob key to confirm the setting.

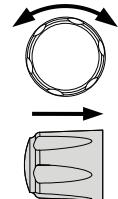

Control

On, Off

Power

To determine the fixed output power value for Constant PWR function.

4. Scroll knob key to move to Power field followed by clicking knob key to enter the field.

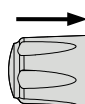
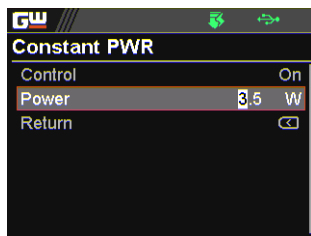
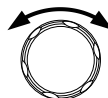

5. Scroll the knob key to adjust value, along with the arrow keys to change among digits followed by clicking the knob key to confirm the set value.

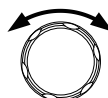

Model	Power
PPX Series	0.5 ~ (105% * voltage * 105% * current)

The maximum value varies per different models. See the example below:

PPX 1005
 0.5 ~ 1.05*10 * 1.05*5
 -> 0.5 ~ 55.125 (calculate to the 1st decimal place)
 -> 0.5 ~ 55.1

Constant PWR on Power (V/A/W) display mode

After turning On and setting Constant PWR value, switch to Power (V/A/W) display mode and the set value will be shown in the lower left corner (CP). Also, it is available to promptly set CP value in the Power (V/A/W) display mode.

- Under the Power (V/A/W) display mode, scroll knob key to move among V Set, I Set and CP fields followed by clicking knob key enter each field, respectively.

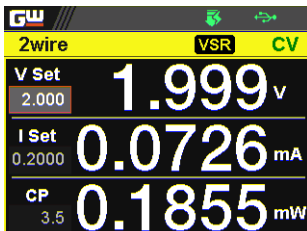
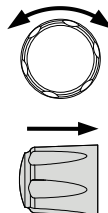

- Scroll knob key to CP field followed by click knob key to enter the field. Scroll the knob key to adjust value, along with the arrow keys to change among digits followed by clicking the knob key again to confirm the set value.

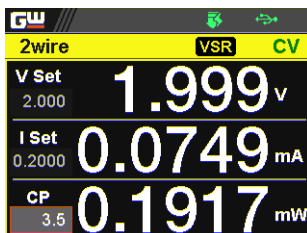
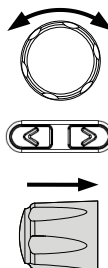

Temperature

Control

To turn On or Off the Temperature function, which measures temperature of DUT while powering output simultaneously. This function requires the affiliated accessory. Refer to page 66 for more details.

1. Press the Menu key followed by scrolling knob key to move to Temperature field.

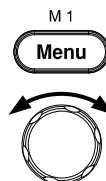
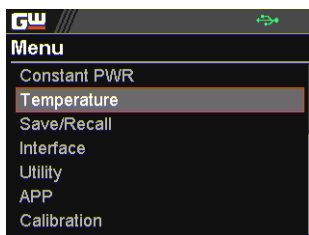

2. Click knob key to enter the Temperature page. Scroll knob key to move to Control field followed by clicking knob key to enter the field.

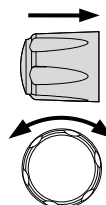
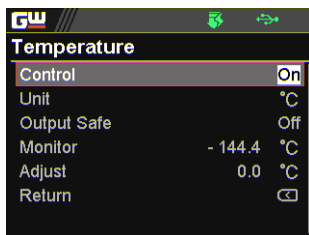

3. Scroll knob key to turn On or Off the function by clicking the knob key to confirm the setting.

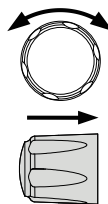

Control On, Off

Unit To determine the Temperature unit for display.

4. Scroll knob key to move to Unit field followed by clicking knob key to enter the field.

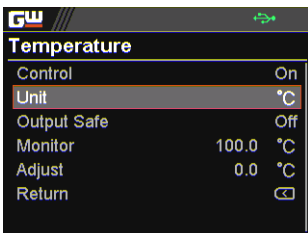
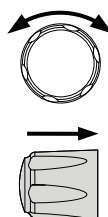

5. Scroll knob key to select option followed by clicking the knob key to confirm the selection.

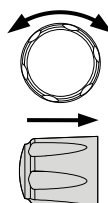

Options °C, °F

Output Safe To turn On or Off the Output Safe function, which is used to monitor temperature of DUT with user-defined threshold. The power output stops once threshold is met.

6. Scroll knob key to move to the Output Safe field followed by clicking knob key to enter the field.

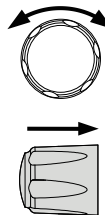
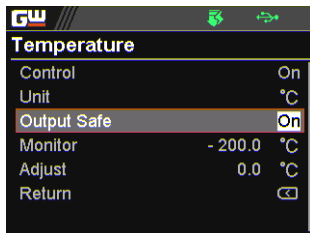

7. Scroll knob key to turn On/Off the function. Click knob key again to confirm.

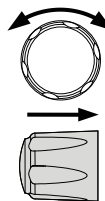

Options On, Off

Monitor

To set a user-defined threshold for the temperature monitor.

8. Scroll knob key to move to the Monitor field followed by clicking knob key to enter the field.

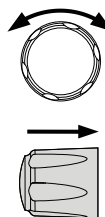
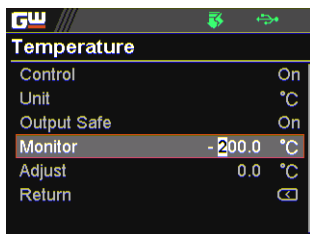

9. Scroll knob key to set monitor value, along with the arrow keys to change among digits. Click knob key again to confirm.

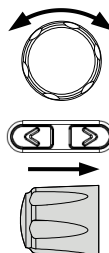

Options °C -200.0 ~ 1372.0
 °F -328.0 ~ 2501.6

Adjust

To set an offset value for temperature measurement in accordance with environment factors by user preference.

10. Scroll knob key to move to the Adjust field followed by clicking knob key to enter the field.

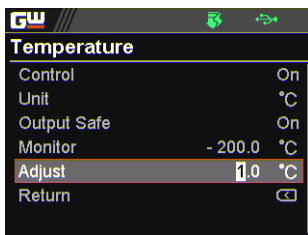
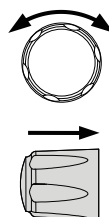

11. Scroll knob key to set Adjust value, along with the arrow keys to change among digits. Click knob key again to confirm.

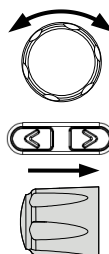

Options °C -2.5 ~ 2.5
 °F -4.5 ~ 4.5

Save/Recall

Save Mem Set

Up to 10 memory setups (M1~M10) can be saved to the internal storage.

1. Press the Menu key followed by scrolling knob key to move to Save/Recall field.

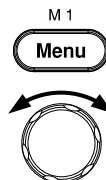
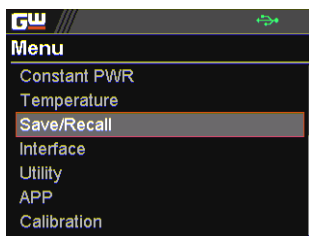

2. Click knob key to enter the Save/Recall page. Scroll knob key to move to Save Mem Set field followed by clicking knob key to enter the field.

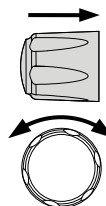
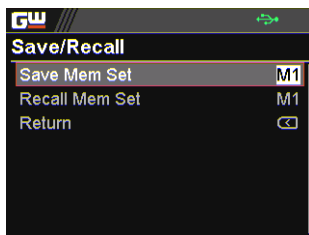

3. Scroll knob key to select an option followed by clicking the knob key to confirm the selection. Scroll knob key to move to OK followed by clicking knob key again to confirm save.

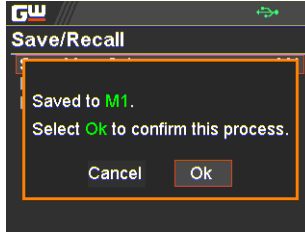
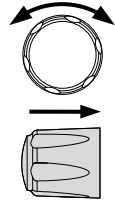

Save Mem Set M1 ~ M10

Recall Mem Set

Up to 10 memory setups (M1~M10) can be recalled from the internal storage

4. Scroll knob key to move to Recall Mem Set field followed by clicking knob key to enter the field.

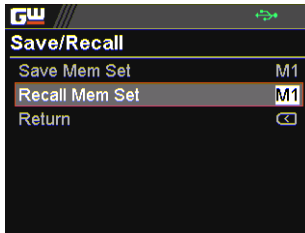
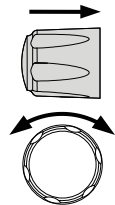

5. Scroll knob key to select an option followed by clicking the knob key to confirm the selection. Scroll knob key to move to OK followed by clicking knob key again to confirm recall.

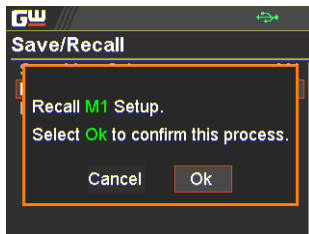
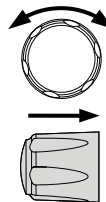

Recall Mem Set	M1~M10 Default	From the internal memory M1 ~ M10. To recall the factory default setup.
----------------	-------------------	--

Interface

UART

The PPX series use the IN & OUT ports for UART communication coupled with RS232 or RS485 adapters.

1. Press the Menu key followed by scrolling knob key to move to Interface field.

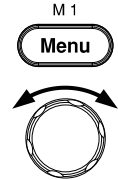
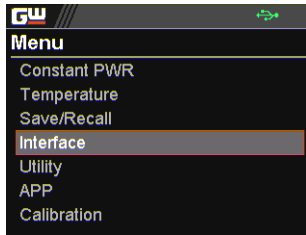

2. Click knob key to enter the Interface page. Scroll knob key to move to UART field followed by clicking knob key to enter the UART page.

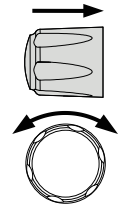
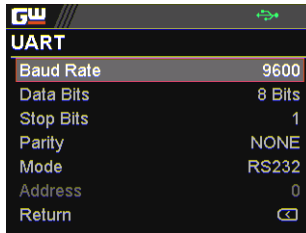

3. There are several relevant settings for UART interface as the following details. Use knob key to scroll and click to configure each setting.

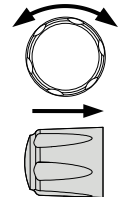

UART Baud Rate	Sets the UART baud rate. 2400, 4800, 9600, 19200, 38400, 57600, 115200
UART Data Bits	Sets the number of data bits. 7 bits, 8 bits
UART Stop Bit	Sets the number of stop bits. 1 bit, 2 bits
UART Parity	Sets the parity. None, Odd, Even
UART Mode	Sets the adaptor. Disable, RS232, RS485
UART Address	Sets the UART address. This is available when Mode is RS485. 0 ~ 30

4. Scroll knob key to move to Return field followed by clicking knob key to return back to the previous page. Also, it is available to return by clicking the left arrow key.

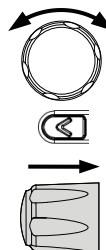

LAN The PPX series use the Ethernet LAN (Local Area Network) port for a number of different applications. Ethernet can be configured for basic remote control or monitoring using a web server or it can be configured as a socket server.

5. Scroll knob key to move to LAN field followed by click knob key to enter the LAN page.

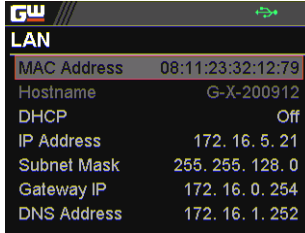
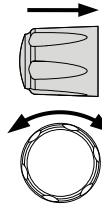

6. There are several relevant settings for LAN interface as following details. Use knob key to scroll and click to configure each setting.

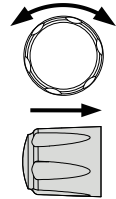

MAC Address	<p>Displays the MAC address in 6 parts. This setting is not configurable.</p> <p>0x00~0xFF</p>
Hostname	<p>Displays the hostname of remote control command. This setting is not configurable.</p> <p>G-X-XXXXXX</p>
DHCP	<p>Turns DHCP on or off. When DHCP is Off, the following IP Address, Subnet Mask, Gateway IP and DNS Address are configurable.</p> <p>Off, On</p>
IP Address	<p>Sets the default IP address. IP address 1~4 splits the IP address into four sections.</p> <p>0~255, 0~255, 0~255, 0~255</p>

- Subnet Mask Sets the subnet mask. The subnet mask is split into four parts.
0~255, 0~255, 0~255, 0~255

- Gateway IP Sets the gateway address. The gateway address is split into 4 parts.
0~255, 0~255, 0~255, 0~255

- DNS Address Sets the DNS address. The DNS address is split into 4 parts.
0~255, 0~255, 0~255, 0~255

7. Scroll knob key to move to Return field followed by clicking knob key to return back to the previous page. Also, it is available to return by clicking the left arrow key.

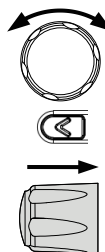

Socket The Socket port is fixed in 2268 (Not configurable) and is specifically for when Ethernet LAN is configured as a socket server.

8. Scroll knob key to move to Socket field followed by click knob key to enter the Socket page.

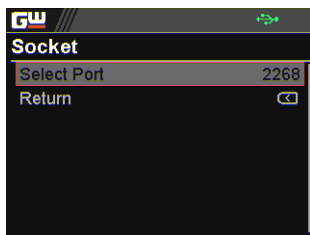
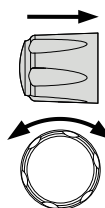

9. The Socket info is as follows

Select Port The Socket port is fixed in 2268.
2268

10. Scroll knob key to move to Return field followed by clicking knob key to return back to the previous page. Also, it is available to return by clicking the left arrow key.

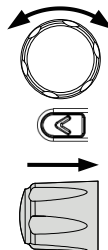

GPIB

The PPX series use the GPIB connector for basic remote control.

11. Scroll knob key to move to GPIB field followed by click knob key to enter the GPIB page.

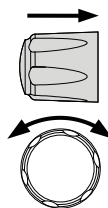
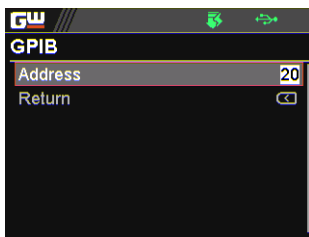

12. There is only an Address field for GPIB interface as the following detail. Use knob key to scroll and click to configure Address setting.

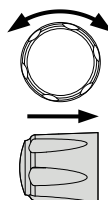

Address Displays the GPIB address.
1~30

13. Scroll knob key to move to Return field followed by clicking knob key to return back to the previous page. Also, it is available to return by clicking the left arrow key.

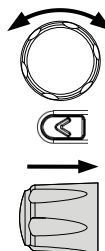

USB

The PPX series use the USB B-type port for basic remote control.

14. Scroll knob key to move to USB field followed by click knob key to enter the USB page.

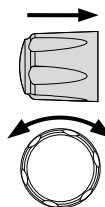
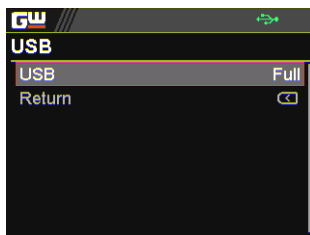

15. There is only an USB field for USB interface as the following detail. Use knob key to scroll and click to configure USB setting.

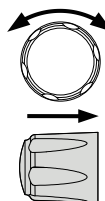

USB

Sets the USB connection function.

Disable, Auto, Full

16. Scroll knob key to move to Return field followed by clicking knob key to return back to the previous page. Also, it is available to return by clicking the left arrow key.

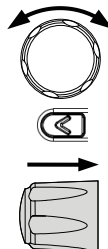

Web Server

Sets PPX series as a web server. Enter the IP address of PPX series in a web browser to establish connection.

17. Scroll knob key to move to Web Server field followed by click knob key to enter the Web Server page.

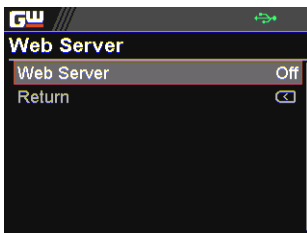
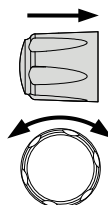

18. There is only a Web Server field for as the following detail. Use knob key to scroll and click to configure Web Server setting.

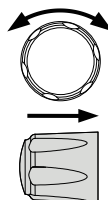

Web Server

Sets the Web Server function On or Off.

On, Off

Utility

System Information

The system information including Model Name, Serial Number as well as Version of PPX series are shown in this section.

1. Press the Menu key followed by scrolling knob key to move to Utility field.

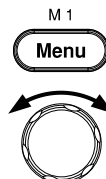
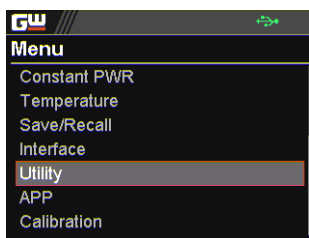

2. Click knob key to enter the Utility page. Scroll knob key to move to System Information field followed by clicking knob key to enter the System Information page.

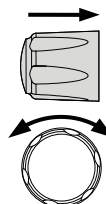
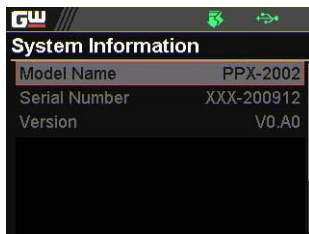

3. There are several information as the following details, which are displayed only and not configurable.

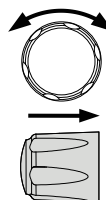

- Model Name The specific model name of PPX series.
- Serial Number The serial number of PPX series.
- Version The firmware version of PPX series.

4. Scroll knob key to move to Return field followed by clicking knob key to return back to the previous page. Also, it is available to return by clicking the left arrow key.

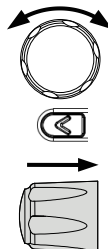

Date & Time The system time of PPX series can be configured within this section.

5. Scroll knob key to move to Date & Time field followed by click knob key to enter the Date & Time page.

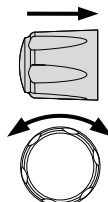
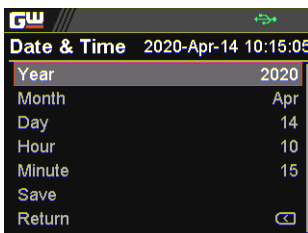

6. There are several relevant settings for Date & Time setting as following details. Use knob key to scroll and click to configure each setting.

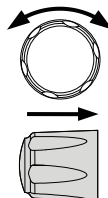

Year To configure year field.

- Month To configure month field.
- Day To configure day field.
- Hour To configure hour field.
- Minute To configure minute field.
- Save To save the configured system time.

7. Scroll knob key to move to Return field followed by clicking knob key to return back to the previous page. Also, it is available to return by clicking the left arrow key.

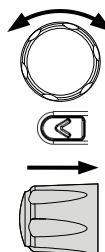

Keyboard Basically this section relates to Lock mode. It determines if power output is available when lock mode is activated.

8. Scroll knob key to move to Keyboard field followed by click knob key to enter the Keyboard page.

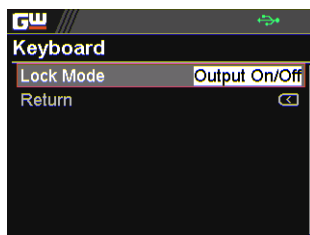
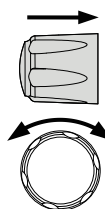

9. There is only a Lock Mode field for Keyboard setting as the following detail. Use knob key to scroll and click to configure Lock Mode setting.

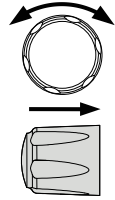

Lock Mode

Output On/Off

Power output can be turned On/Off when lock mode is activated.

Output Off

Power output can only be turned Off when lock mode is activated.

10. Scroll knob key to move to Return field followed by clicking knob key to return back to the previous page. Also, it is available to return by clicking the left arrow key.

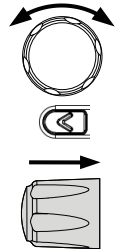

Buzzer

It turns the buzzer sound On or Off when either protection alarm function is tripped or keyboard entry is engaged.

11. Scroll knob key to move to Buzzer field followed by click knob key to enter the Buzzer page.

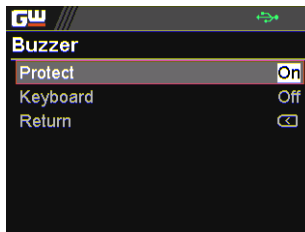
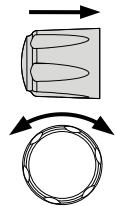

12. There are two relevant settings for Buzzer setting as following details. Use knob key to scroll and click to configure each setting.

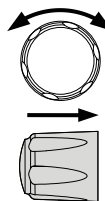

Protect To turn On or Off the buzzer sound for protection alarm.

On, Off

Keyboard To turn On or Off the buzzer sound for keyboard entry.

On, Off

13. Scroll knob key to move to Return field followed by clicking knob key to return back to the previous page. Also, it is available to return by clicking the left arrow key.

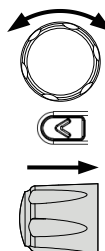

Bleeder It turns the bleeder control On or Off for the bleeder resistor, which is critical for discharge. For more details, refer to page 23.

14. Scroll knob key to move to Bleeder field followed by click knob key to enter the Bleeder page.

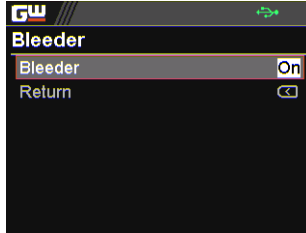
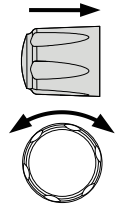

15. There is only a Bleeder field for Bleeder setting as following detail. Use knob key to scroll and click to configure the setting.

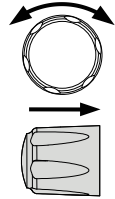

Bleeder

To turn On or Off the bleeder control for the bleeder resistor.

On, Off

16. Scroll knob key to move to Return field followed by clicking knob key to return back to the previous page. Also, it is available to return by clicking the left arrow key.

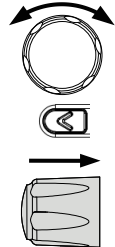

Communication Monitor

While operating PPX series via remote control, it is convenient to enable Communication Monitor function for regular connection checkup.

17. Scroll knob key to move to Communication Monitor field followed by click knob key to enter the Communication Monitor page.

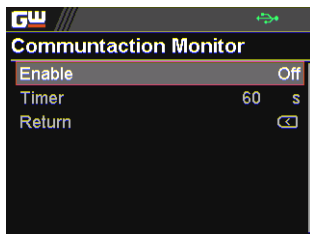
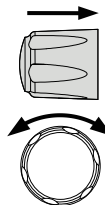

18. There are two settings for Communication Monitor page as following details. Use knob key to scroll and click to configure the setting.

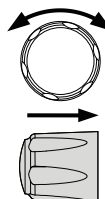

- | | |
|--------|--|
| Enable | It enables/disables communication monitor, which transmits a signal to remote control side regularly in accordance with set timer.

On, Off |
| Timer | It allows user to set a timer, which acts like an interval between each signal transmitted from the communication monitor.

1 ~ 3600 seconds |

Communicati
on Monitor
Display

The icon indicates Communication
Monitor is activated

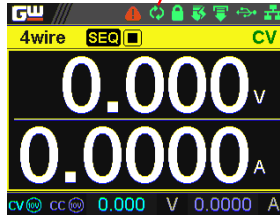

APP

License

The APP (application) field is the extending function for future update when license file is available. It is required to insert the USB disk in which the license file is stored into the PPX series beforehand. Contact your dealer for the necessary license file.

1. Press the Menu key followed by scrolling knob key to move to APP field.

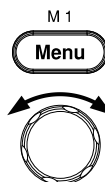
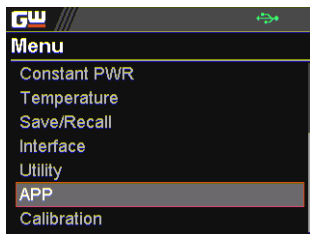

2. Click knob key to enter the APP page. Scroll knob key to move to License field followed by clicking knob key to enter the License page.

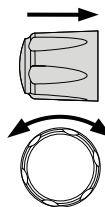
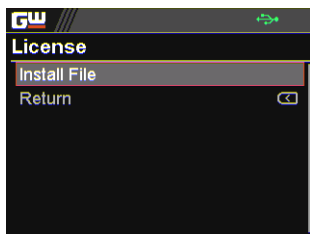

- Click knob key to enter the Install File field followed by importing the license file from the USB disk for installation.

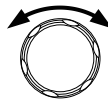
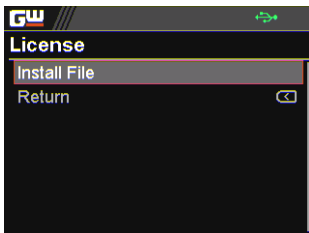

- Scroll knob key to move to Return field followed by clicking knob key to return back to the previous page. Also, it is available to return by clicking the left arrow key.

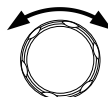

- Scroll knob key to move to AH/WH Meter field followed by clicking knob key to enter the AH/WH Meter page.

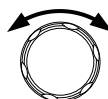
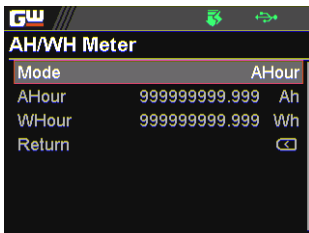
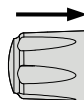

- There are few settings for AH/WH Meter page as following details. Use knob key to scroll and click to configure the setting. Also, use arrow keys to move among digits when available.

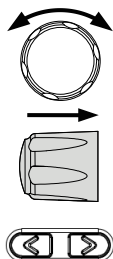

Mode It sets alarm for either AHour or WHour function from the APP display mode. AHour indicates Ampere/hour, whereas WHour stands for Watt/hour. When power output is ongoing, the values of 2 fields will fluctuate in accord with the actual condition. The selected option will be highlighted in orange and the alarm will be activated one value is beyond the set threshold.

Disable, Reset, AHour, WHour

AHour It sets the threshold of alarm for Ampere/hour.
0.001 ~ 999999999.999 Ah

WHour It sets the threshold of alarm for Watt/hour.
0.001 ~ 999999999.999 Wh

APP Display Mode

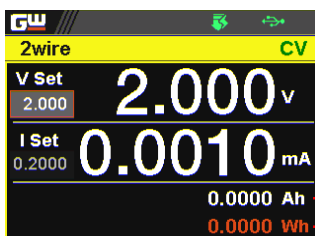

Ampere/Hour

(Alarm is set in orange highlight)

Watt/Hour

Calibration

System Update

The Calibration section is used to access to the calibration function, which requires a password to enter the menu. Please see your distributor or dealer for details when necessary.

A ANALOG CONTROL

The Analog Control chapter describes how to control the voltage or current output using an external voltage or resistance, monitor the voltage or current output as well as remotely turning off the output or shutting down the power supply.

Analog Remote Control Overview	157
Analog Control Connector Overview.....	158
External Voltage Control of Voltage Output.....	160
External Voltage Control of Current Output.....	163
External Resistance Control of Voltage Output.....	166
External Resistance Control of Current Output.....	167
External Control of Output.....	169
External Trigger In / Out.....	171
Remote Monitoring	173
External Voltage and Current Monitoring.....	173
External Operation and Status Monitoring.....	175

Analog Remote Control Overview

The PPX power supply series have a number of analog control options. The Analog Control connectors are used to control output voltage and current using external voltage or resistance. The power supply output can also be controlled using external switches.

Analog control connector overview → from page 158

External voltage control of voltage output → from page 160

External voltage control of current output → from page 163

External resistance control of voltage output → from page 166

External resistance control of current output → from page 167

External control of output → from page 169

External Trigger In/Out → from page 171

Analog Control Connector Overview

Overview The EXT I/O Connector is a 20pin connector that can be used with the plug for wiring connection. The connector is used for all analog remote control. The pins used determine what remote control mode is used.

Pin Assignment

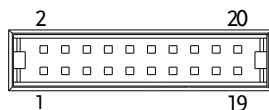

Pin name	Pin number	Description
I MON	1	Output current monitor. 0 % to 100 % of the rated output current is generated as a voltage between 0 V and 10 V.
V MON	2	Output voltage monitor. 0 % to 100 % of the rated output voltage is generated as a voltage between 0 V and 10 V.
EXT-V/R CV CONT	3	This line uses an external voltage or resistance to control the output voltage. External voltage control; External resistor control 0 to 10 V or 0 to 10k ; 0 % to 100 % of the rated output voltage.
A COM	4	This is the common line for external signal pins 1, 2, 3, and 5.
EXT-V/R CC CONT	5	This line uses an external voltage or resistance to control the output current. External voltage control; External resistor control 0 to 10 V or 0 to 10k ; 0 % to 100 % of the rated output current.

A COM	6	This is the common line for external signal pins 1, 2, 3, and 5.
N.C.	7	Not connected.
N.C.	8	Not connected.
OUT ON/OFF CONT	9	Output on/off line. On when set to a low TTL signal, Off when set to a high TTL signal. On when set to a high TTL signal, Off when set to a low TTL level signal.
TRIG IN	10	Trigger signal input line. Pulled down the internal circuit to B COM using 100k Ω . The minimum pulse is width is 100us.
TRIG OUT	11	Trigger signal output line. Outputs a TTL signal when a trigger out function is activated. The minimum pulse is width is 1ms.
B COM	12	This is the common line for external signal pins 9, 10, and 11.
N.C.	13	Not connected.
N.C.	14	Not connected.
OUT ON Status	15	On when the output is on (open-collector photocoupler output).1
CV Status	16	This line is On when the PPX is in CV mode (open-collector photocoupler output).1
PWR OFF Status	17	Outputs a low level signal when power is turned off. (open-collector photocoupler output).1
CC Status	18	This line is On when the PPX is in CC mode (open-collector photocoupler output).1

Alarm Status	19 On when a protection function (OVP, OCP, OTP, AC ALARM) has been activated or when an output shutdown signal is being applied (open-collector photocoupler output). ¹
Status COM	20 This is the common line for the status signal pins 2 to 6.

¹ Open collector output: Maximum voltage of 30 V and maximum current of 8 mA. The common line for the status pins is floating (isolated voltage of 60 V or less). It is isolated from the output and control circuits.

External Voltage Control of Voltage Output

Background External voltage control of the voltage output is accomplished using the analog control connector on the rear panel. A voltage of 0~10V is used to control the full scale voltage of the instrument, where:

$$\text{Output voltage} = \text{full scale voltage} \times (\text{external voltage}/10)$$

Connection

When connecting the external voltage source to the analog connector, use shielded or twisted paired wiring.

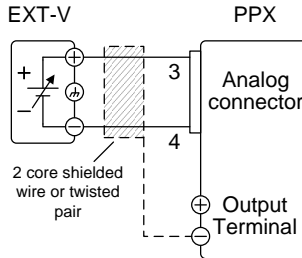

Pin3 → EXT-V (+)

Pin4 → EXT-V (-)

Wire shield → negative (-) output terminal

Connection- alt. shielding

If the wire shield needs to be grounded at the voltage source (EXT-V), then the shield cannot also be grounded at the negative (-) terminal output of the PPX power supply. This would short the output.

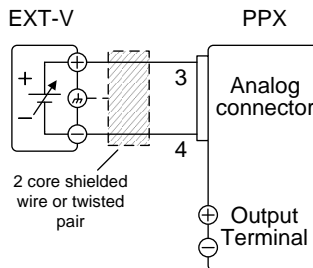

Pin3 → EXT-V (+)

Pin4 → EXT-V (-)

Wire shield → EXT-V ground (GND)

- Panel operation
1. Connect the external voltage according to the connection diagrams above.
 2. Set the CV Control as External V. Page 108
Also, set Output Type per application and turn On Output Enable.
 3. Press the Output key. The voltage can now be controlled with the External voltage. 



The input impedance for external voltage control is a high impedance OPA input.

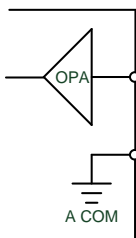

Use a stable voltage supply for the external voltage control.



CV and CC Slew Rate Priority (CVLS, CCLS) are disabled when using external voltage control. See the CVLS and CCLS Settings on page 51 & 55.



Ensure no more than 10.5 volts are input into the external voltage input.

Ensure the voltage polarity is correct when connecting the external voltage.

External Voltage Control of Current Output

Background External voltage control of the current output is accomplished using the analog control connector on the rear panel. A voltage of 0~10V is used to control the full scale current of the instrument, where:

$$\text{Output current} = \text{full scale current} \times (\text{external voltage}/10)$$

Connection When connecting the external voltage source to the analog connector, use shielded or twisted paired wiring.

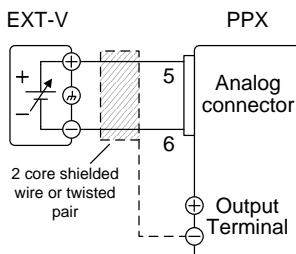

Pin5 → EXT-V (+)

Pin6 → EXT-V (-)

Wire shield → negative (-) output terminal

Connection- alt. shielding

If the wire shield needs to be grounded at the voltage source (EXT-V), then the shield cannot also be grounded at the negative (-) terminal output of the PPX power supply. This would short the output.

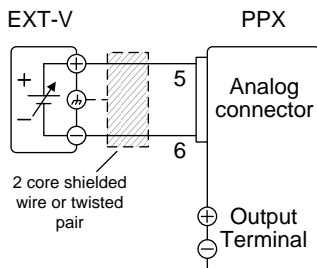

Pin5 → EXT-V (+)

Pin6 → EXT-V (-)

Wire shield → EXT-V ground (GND)

Steps

1. Connect the external voltage according to the connection diagrams above.
2. Set the CC Control as External V. Page 108
Also, set Output Type per application and turn On Output Enable.
3. Press the Output key. The current can now be controlled with the External voltage.





The input impedance for external voltage control is a high impedance OPA input.

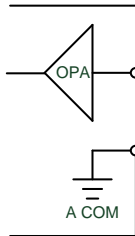

Use a stable voltage supply for the external voltage control.



CV and CC Slew Rate Priority (CVLS, CCLS) are disabled when using external voltage control. See the CVLS and CCLS Settings on page 51 & 55.



Ensure no more than 10.5 volts are input into the external voltage input.

Ensure the voltage polarity is correct when connecting the external voltage.

External Resistance Control of Voltage Output

Background

External resistance control of the voltage output is accomplished using the analog connector on the rear panel. A resistance of 0Ω~10kΩ is used to control the full scale voltage of the instrument.

The output voltage (0 to full scale) can be controlled with the external resistance from 0Ω~10kΩ.

Output voltage = full scale voltage x (external resistance/10)

Connection

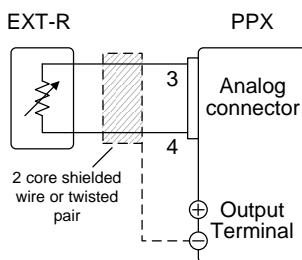

Pin3 → EXT-R

Pin4 → EXT-R

Wire shield → negative (-) output terminal

Steps

1. Connect the external resistance according to the connection diagrams above.
2. Set the CV Control as External R. Page 108
Also, set Output Type per application and turn On Output Enable.

3. Press the Output key. The voltage can now be controlled with the External resistance.



Note

Ensure the resistor(s) and cables used exceed the isolation voltage of the power supply. For example: insulation tubes with a withstand voltage higher than the power supply can be used.

When choosing an external resistor ensure the resistor can withstand a high degree of heat.



Note

CV and CC Slew Rate Priority (CVLS, CCLS) are disabled when using external resistance control. See the CVLS and CCLS Settings on page 51 & 55.

External Resistance Control of Current Output

Background

External resistance control of the current output is accomplished using the analog connector on the rear panel. A resistance of $0\Omega\sim 10k\Omega$ is used to control the full scale current of the instrument.

The output current (0 to full scale) can be controlled with the external resistance from $0\Omega\sim 10k\Omega$.

Output current = full scale current \times (external resistance/10)

Connection

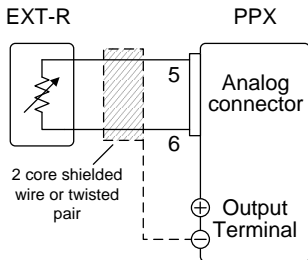

Pin5 → EXT-R

Pin6 → EXT-R

Wire shield → negative (-) output terminal

Steps

1. Connect the external resistance according to the connection diagrams above.
2. Set the CC Control as External R. Page 108
Also, set Output Type per application and turn On Output Enable.
3. Press the Output key. The current can now be controlled with the External resistance. 



Ensure the resistor(s) and cables used exceed the isolation voltage of the power supply. For example: insulation tubes with a withstand voltage higher than the power supply can be used.

When choosing an external resistor ensure the resistor can withstand a high degree of heat.



CV and CC Slew Rate Priority (CVLS, CCLS) are disabled when using external resistance control. See the CVLS and CCLS Settings on page 51 & 55.

External Control of Output

Background

The output can be turned on or off externally using a switch. The analog control connector can be set to turn the output on from a high or low signal. The voltage across pins 9 and 12 are internally pulled to +5V with 2k Ω pull-up resistor. A short (closed switch) produces a low signal.

When set to High = On, the output is turned on when the pins 9 and 12 are open.

When Low = On, the output is turned on when the pins 9 and 12 are shorted.

Connection

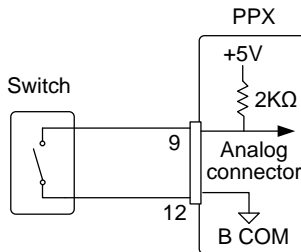

Pin9 → Switch

Pin12 → Switch

Wire shield → negative (-) output terminal

Steps

1. Connect the external switch according to the connection diagrams above.

2. Set Output Type per application to High or Low and turn On Output Enable. Page 108

3. The switch is now ready to set the output on or off.



Note

When using a switch over long distances, please use a switch relay to extend the line from the coil side of the relay.

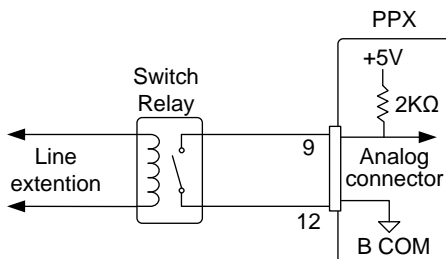

If a single switch control is to be used for multiple units, please isolate each instrument. This can be achieved by using a relay.



Warning

Ensure the cables used and the switch exceed the isolation voltage of the power supply. For example: insulation tubes with a withstand voltage higher than the power supply can be used.



Note

Output ON/OFF Delay Time (Output On/Off Dly) are disabled when the output is set to external control. See the Output Delay settings on page 108.

External Trigger In / Out

Background

Pin 10 is used for the external trigger input and pin 11 is used as the trigger output. Pin 12 is the B common for both pins.

The trigger input can be configured to perform an action such as toggling the output on/off, load a memory setting or apply a voltage/current setting when a trigger is received.

The trigger output can be configured to be active when the output is turned on/off, a voltage/current setting is changed or when a memory setting has been recalled. The trigger output pulse width can also be configured.

See page 120 for details on the trigger input and trigger output configuration settings.

Pinout	Name and Pin	Description
	B COM 12	B COM for trigger pins 10 & 11.
	TRIG OUT 11	Trigger output: approx. 4.5 V Pulse width: approx. 1ms, Output impedance: approx. 500 Ω It outputs a pulse when power output, V/I set operation or memory recall is executed.
	TRIG IN 10	A high or low level TTL signal is applied for 100 us or longer. It receives a pulse to perform actions like power output, V/I set operation or memory recall. Pulled down the internal circuit to B COM using 100kΩ.

Schematic

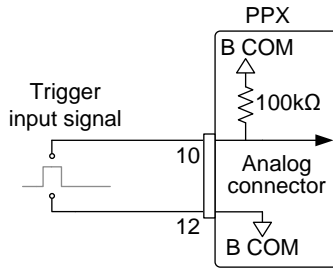

Remote Monitoring

The PPX power supplies have remote monitoring support for current and voltage output. They also support monitoring of operation and alarm status.

External monitoring of output voltage and current → from page 173

External monitoring of operation mode and alarm status → from page 175

External Voltage and Current Monitoring

Background

The analog connector is used to monitor the current (IMON) or voltage (VMON) output.

An output of 0~10V represents the voltage or current output of 0~ rated current/voltage output.

$$\text{IMON} = (\text{current output}/\text{full scale}) \times 10.$$

$$\text{VMON} = (\text{voltage output}/\text{full scale}) \times 10.$$

External voltage and current monitoring doesn't need to be enabled in the configuration settings.

VMON Connection

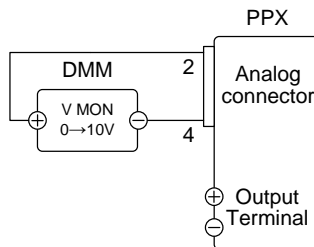

Pin4 → Neg (-)

Pin2 → Pos (+)

**IMON
Connection**

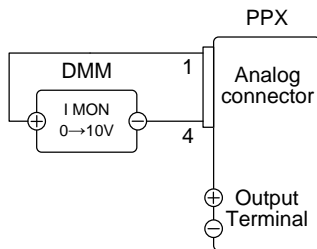

Pin4 → Neg (-)

Pin1 → Pos (+)

! Note

Maximum output impedance is 10KΩ. Ensure the sensing circuit has an input impedance greater than 1MΩ.

The monitor outputs are strictly DC and should not be used to monitor analog components such as transient voltage response or ripple etc.

! CAUTION

Ensure IMON (pin 1) and VMON (pin 2) are not shorted together. This may cause damage to the unit.

External Operation and Status Monitoring

Background The analog connector can also be used to monitor the status operation and alarm status of the instrument.

The pins are isolated from the power supply internal circuitry by photo couplers. Status Com (Pin 20) is a photo coupler emitter output, whilst pins 15~19 are photo coupler collector outputs.

A maximum of 30V and 8mA can be applied to each pin.

Pinout	Name and Pin	Description
OUT ON Status	15	On when the output is on (open-collector photocoupler output). ¹
CV Status	16	This line is On when the PPX is in CV mode (open-collector photocoupler output). ¹
PWR OFF Status	17	Outputs a low level signal when power is turned off. (open-collector photocoupler output). ¹
CC Status	18	This line is On when the PPX is in CC mode (open-collector photocoupler output). ¹
Alarm Status	19	On when a protection function (OVP, OCP, OTP or AC Alarm) has been activated or when an output shutdown signal is being applied (open-collector photocoupler output). ¹

Status COM 20 This is the common line for the status signal pins 15 to 19.

Schematic

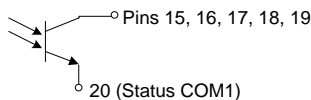

Timing diagrams

Below are 4 example timing diagrams covering a number of scenarios. Note that pins 15~19 are all active low.

CV MODE:
Output turned on

The diagram below shows the timing diagram when the output is turned on when the PPX is set to CV mode.

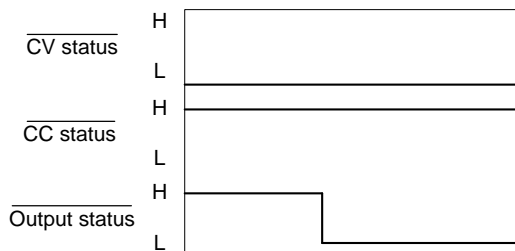

CV MODE:
Output turned off

The diagram below shows the output status lines when the output is turned off in CV mode.

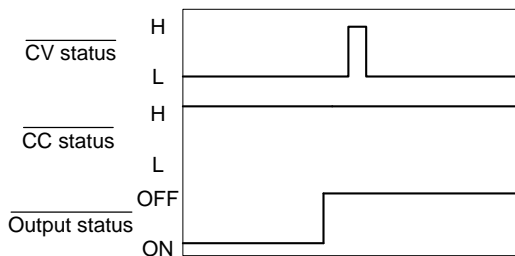

CC MODE:
Output turned on

The diagram below shows the timing diagram when the output is turned on when the PPX is set to CC mode.

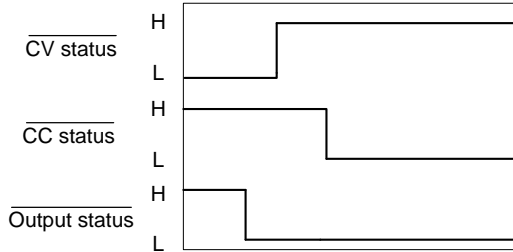

CC MODE:
Output turned off

The diagram below shows the output status lines when the output is turned off in CC mode.

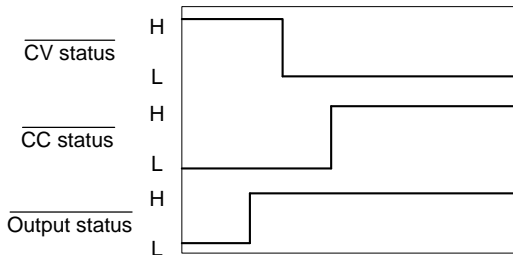

C

COMMUNICATION

INTERFACE

This chapter describes basic configuration of IEEE488.2 based remote control. For a command list, refer to the programming manual, downloadable from GW Instek website, www.gwinstek.com

Interface Configuration	179
USB Remote Interface	179
Configuration	179
USB CDC Function Check	180
GPIB Remote Interface	187
Configuration	187
GPIB Function Check	188
UART Remote Interface	192
Configure UART	192
UART Function Check	194
Multi Unit Connection	196
Multiple units Function Check	197
Configure Ethernet Connection	199
Web Server Configuration	199
Web Server Remote Control Function Check	200
Sockets Server Configuration	202
Socket Server Function Check	203



Interface Configuration

USB Remote Interface

Configuration

USB Configuration	PC side connector	Type A, host
	PPX side connector	Rear panel Type B, slave
	Speed	1.1 (full speed)
	USB Class	CDC (communications device class)

Steps

1. Connect the USB cable to the rear panel USB B port.   DEVICE
2. Set the USB setting as Auto or Full. [Page 142](#)
3. The indicator will be shown when a remote connection has been established.

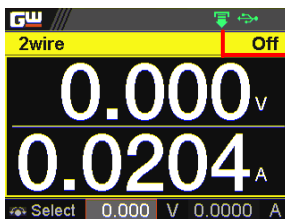

Remote Control indicator

USB CDC Function Check

Background To test the USB CDC functionality, National Instruments Measurement and Automation Explorer can be used. This program is available on the NI website, www.ni.com, via a search for the VISA Run-time Engine page, or "downloads" at the following URL, <http://www.ni.com/visa/>

Requirements Operating System: Windows XP, 7, 8,10

Functionality check

1. In case of Window 7 64 bits, once the USB Cable was connected to PC correctly for a while (around 1 min). It may show below message at the lower right area of display.

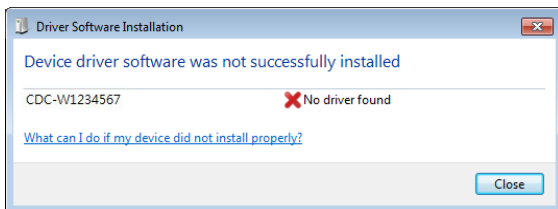

2. Open the "Run" dialog box by pressing and holding the Windows key and then press the R key ("Run").
3. Type devmgmt.msc and click "OK".

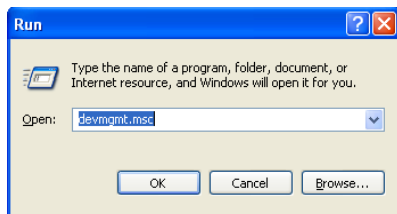

- The Device Manager will show up CDC-WXXXXXX on "Other Devices".

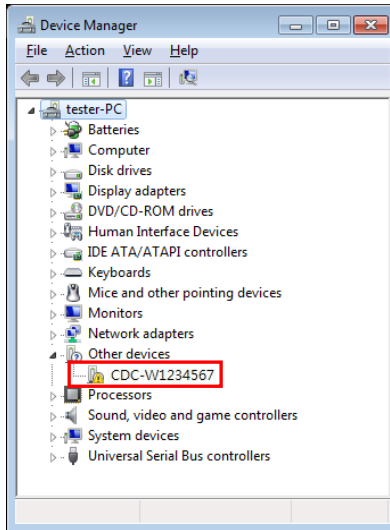

- Select the CDC-WXXXXXX and click the right button of mouse to "Update Driver Software".

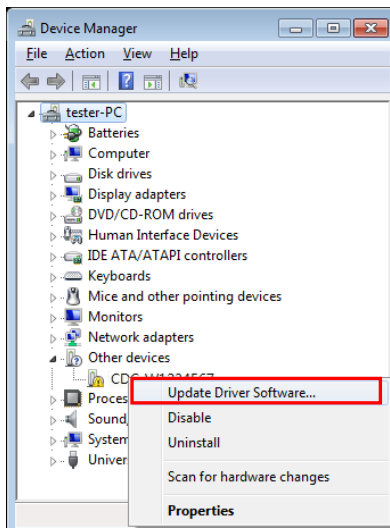

6. Select "Locate and install driver software manually."

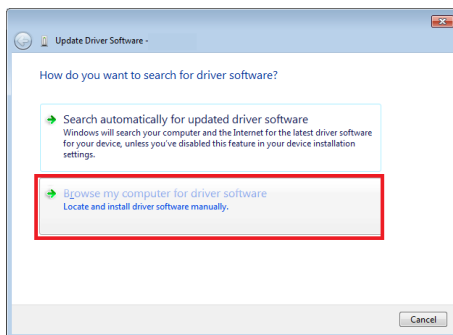

7. Indicate the driver folder to the system and then press "Next".

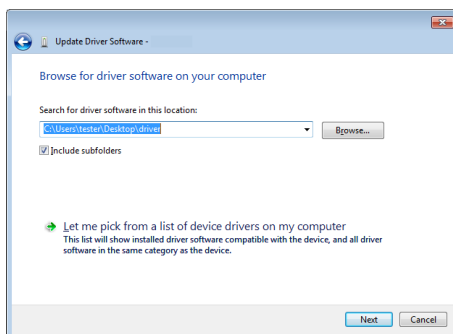

And this folder should consist of below 2 files.

gw_ppx.cat	2020/8/19 下午 0...	安全性目錄	17 KB
gw_ppx.inf	2020/8/19 上午 1...	安裝資訊	3 KB



Note

The USB driver of PPX can be downloaded from download area of PPX on the GW Instek website <http://www.gwinstek.com/en-global/Support/download>

8. Windows 7 will install the driver for a while.

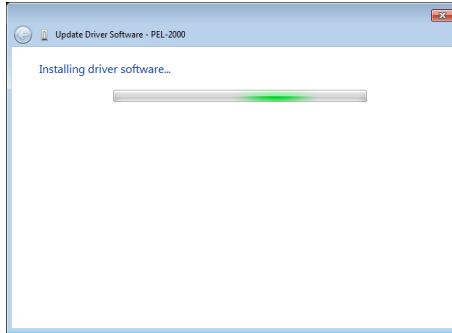

9. If everything works fine, you may get below message. And the COM53 is the USB CDC ACM port of PPX.

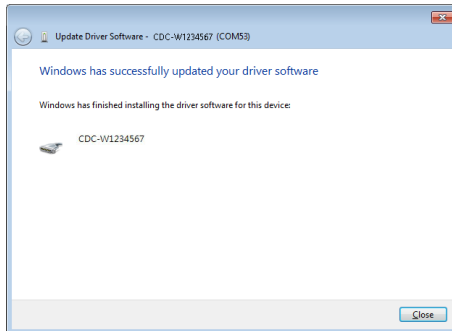

10. Double check the "Device Manager". The port should like below.

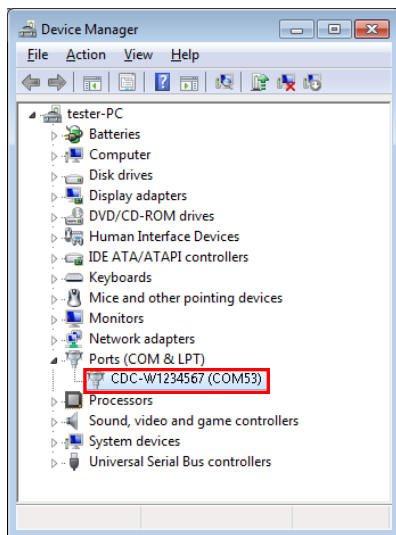

Steps 1~10 are for the USB CDC Driver installation.

11. Start the NI Measurement and Automation Explorer (MAX) program. Using Windows, press:

Start>All Programs>National Instruments>Measurement & Automation



12. From the Configuration panel access;
*My System>Devices and Interfaces>Network
Devices*

13. Click Open VISA Test Panel.



14. Click the Configuration icon,

15. Click on I/O Settings.

16. Make sure the Enable Termination Character
check box is checked, and the terminal
character is \n (Value: xA).

17. Click Apply Changes.

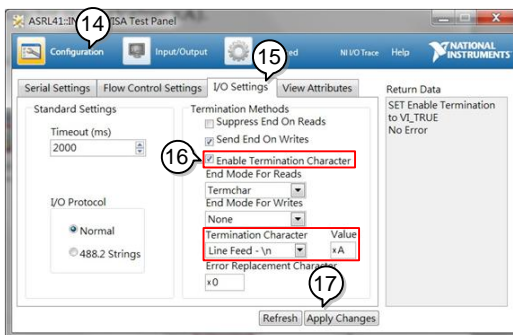

18. Click the Input/Output icon.

19. Enter *IDN? in the Select or Enter Command
dialog box if it is not already.

20. Click the Query button.

- 21. The *IDN? query will return the Manufacturer, model name, serial number and firmware version in the dialog box.

GW-INSTEK,PPX-10H01,TW123456,V0.A4

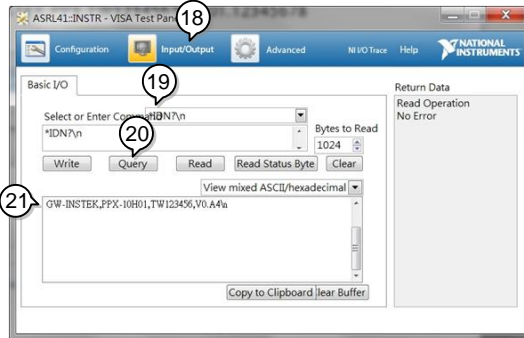

GPIB Remote Interface

Configuration

To use GPIB, the optional GPIB option (GW Instek part number: Option 1) must be installed. This is a factory installed option and cannot be installed by the end-user. Only one GPIB address can be used at a time.

- Configure GPIB
1. Ensure the PPX is off before proceeding.
 2. Connect the GPIB cable (GW Instek part number: GTL-258) from a GPIB controller to the GPIB port on the PPX.
 3. Turn the PPX on.
 4. Set the GPIB Address setting per Page 141 application.
-
5. The indicator will be shown when a remote connection has been established.

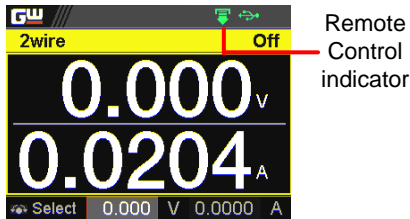

- GPIB constraints
- Maximum 15 devices altogether, 20m cable length, 2m between each device
 - Unique address assigned to each device
 - At least 2/3 of the devices turned On
 - No loop or parallel connection

GPIB Function Check

Background To test the GPIB functionality, National Instruments Measurement and Automation Explorer can be used. This program is available on the NI website, www.ni.com, via a search for the VISA Run-time Engine page, or “downloads” at the following URL, <http://www.ni.com/visa/>

Requirements Operating System: Windows XP, 7, 8, 10

Functionality check

1. Start the NI Measurement and Automation Explorer (MAX) program. Using Windows, press:

Start>All Programs>National Instruments>Measurement & Automation



2. From the Configuration panel access;

My System>Devices and Interfaces>GPIB
3. Press *Scan for Instruments*.

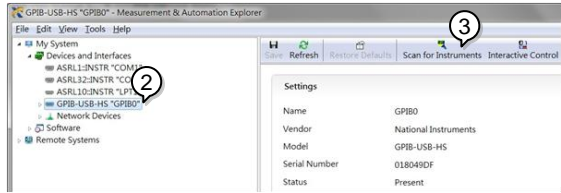

4. Select the device (GPIB address of PPX) that now appears in the *System>Devices and Interfaces > GPIB-USB-HS "GPIBX"* node.
5. Click on the *VISA Properties* tab on the bottom.
6. Click *Open Visa Test Panel*.

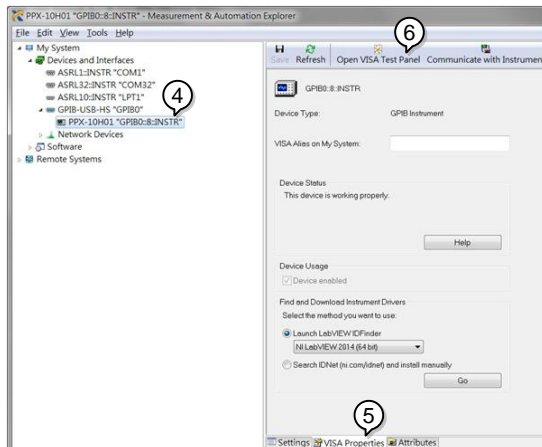

7. Click on *Configuration*.
8. Click on the *GPIB Settings* tab and confirm that the GPIB settings are correct.

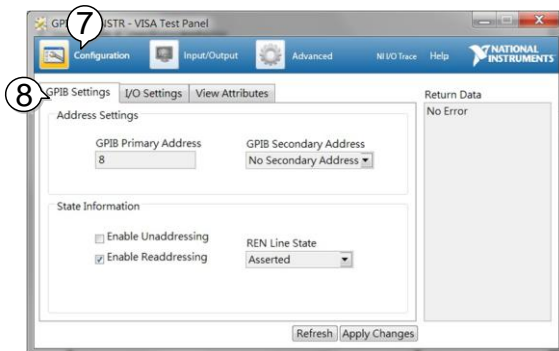

9. Click on the *I/O Settings* tab.
10. Make sure the *Enable Termination Character* check box is checked, and the terminal character is \n (Value: xA).
11. Click *Apply Changes*.

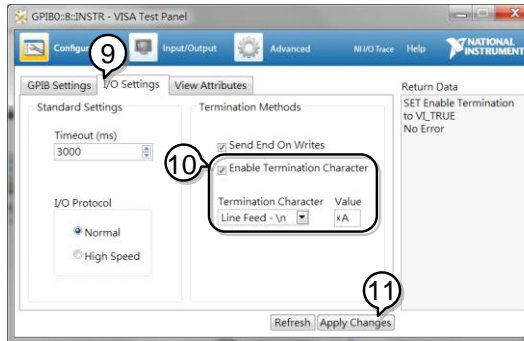

12. Click on *Input/Output*.
13. Click on the *Basic I/O* tab.
14. Enter **IDN?* in the *Select or Enter Command* drop down box.
15. Click *Query*.
16. The **IDN?* query will return the Manufacturer, model name, serial number and firmware version in the dialog box.

GW-INSTEK,PPX-10H01,TW123456,V0.A4

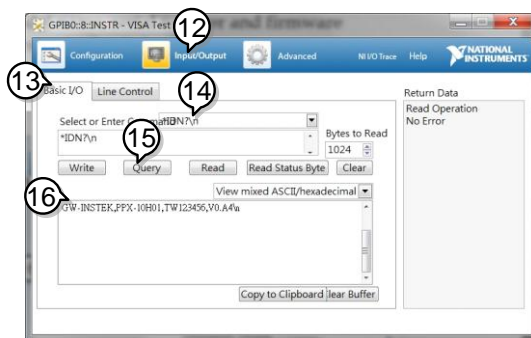

Note

For further details, please see the programming manual, available on the GW Instek web site @ www.gwinstek.com.

UART Remote Interface

Configure UART

Overview

The PPX uses the IN & OUT ports for UART communication coupled with RS232 (GW Instek part number: GTL-259) or RS485 adapters (GW Instek part number: GTL-260).

The pin outs for the adapters are shown below.

RS232 cable with DB9 & RJ-45 shielded connectors from GTL-259 connection kit	DB-9 Connector		Remote IN Port		Remarks
	Pin No.	Name	Pin No.	Name	
	Housing	Shield	Housing	Shield	
	2	RX	7	TX	Twisted pair
	3	TX	8	RX	
	5	SG	1	SG	

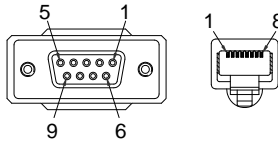

RS485 cable with DB9 & RJ-45 shielded connectors from GTL-260 connection kit

DB-9 Connector		Remote IN Port		Remarks
Pin No.	Name	Pin No.	Name	
Housing	Shield	Housing	Shield	
9	TXD -	6	RXD -	Twisted pair
8	TXD +	3	RXD +	
1	SG	1	SG	
5	RXD -	5	TXD -	Twisted pair
4	RXD +	4	TXD +	

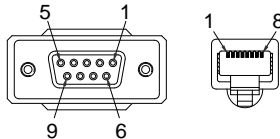

Steps

1. Connect the RS232 serial cable or RS485 serial cable to the Remote IN port on the real panel. Connect the other end of the cable to the PC.

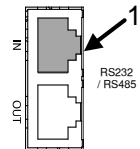

2. Select RS485 or RS232 for Mode setting. Also set UART relevant settings including Baud Rate, Data Bits, Parity, Stop Bits and Address.

Page 137

 **Note**

When RS232 Mode is selected, the Address setting is not available for assignment.

3. The indicator will be shown when a remote connection has been established.

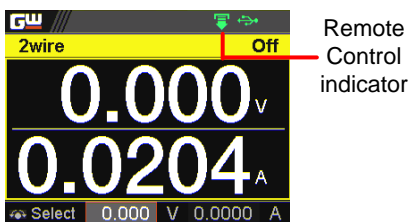

UART Function Check

Functionality check

Invoke a terminal application such as Realterm.
To check the COM port No., see the Device Manager in the PC

Run this query command via the terminal application after the instrument has been configured for UART remote control.

*idn?

This should return the Manufacturer, Model number, Serial number, and Firmware version in the following format.

GW-INSTEK,PPX-10H01,TW123456,V0.A4

Manufacturer: GW-INSTEK

Model number : PPX-10H01

Serial number : TW1234567

Firmware version : V0.A4



Note

For further details, please see the programming manual, available on the GW Instek web site @ www.gwinstek.com.

Multiple Unit Connection

The PPX power supplies can have up to 31 units daisy-chained together using the 8 pin connectors (IN OUT ports) on the rear panel. The first unit in the chain is remotely connected to a PC using GTL-260 (RS485 cable with DB9 connector). Each subsequent unit is daisy-chained to the next using a RS485 local bus.

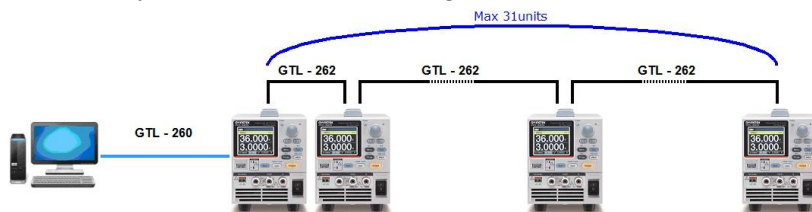

Each unit is assigned a unique address and can then be individually controlled from the host PC.

Multi Unit Connection

Operation

1. Connect the first unit's IN port to a PC using RS485 cable with DB9 & RJ-45.
2. Connect the OUT port on the first unit to the IN port of the second unit using the slave serial link cable (black plug) supplied in the GTL-262 connection kit.

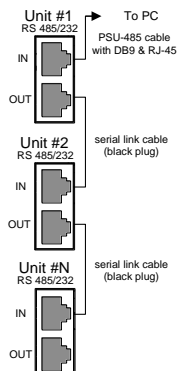

3. Power up all units.

- Set the addresses and mode of all units using UART menu. It must be a unique address identifier and mode select is RS485.

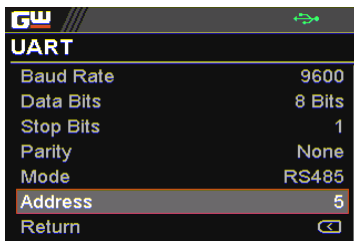

- Multiple units can be operated using SCPI commands now. See the programming manual or see the function check below for usage details.

Multiple units Function Check

Functionality
check

Invoke a terminal application such as Realterm.
To check the COM port No, see the Device
Manager in the PC.

For this function check, we will assume that the
one unit is assigned to address 0, while other is
assigned address 5.

ADR 0

OK

*IDN?

GW-INSTEK,PPX-2005,TW123456,V0.A2

VOLT 5

OK

VOLT?

+5.000

ADR is followed by address, which can be 0 to 31 and is used to access the power supply.

Selects the unit with address 0 and returns its identity string. Also, sets its volt as 5 and returns its volt in 5.

ADR 5

OK

*IDN?

GW-INSTEK,PPX-3601,TW654321,V0.A2

VOLT 10

OK

VOLT?

+10.000

ADR is followed by address, which can be 0 to 31 and is used to access the power supply.

Selects the unit with address 5 and returns its identity string. Also, sets its volt as 10 and returns its volt in 10.



Note

All setting command must return an “OK” response before any other commands are accepted. The power supply acknowledges received commands by returning an “OK” message. If an error is detected the power supply will return an error message.

For further details, please see the programming manual, available on the GW Instek web site @ www.gwinstek.com.

Configure Ethernet Connection

The Ethernet interface can be configured for a number of different applications. Ethernet can be configured for basic remote control or monitoring using a web server or it can be configured as a socket server.

The PPX series supports both DHCP connections so the instrument can be automatically connected to an existing network or alternatively, network settings can be manually configured.

Ethernet configuration	For details on how to configure the Ethernet settings, please see the configuration chapter on page 138.	
Parameters	MAC Address (display only)	Hostname (display only)
	DHCP On/Off	IP Address
	Subnet Mask	Gateway IP
	DNS Address	Web Server On/Off

Web Server Configuration

Configuration This configuration example will configure the PPX as a web server and use DHCP to automatically assign an IP address to the PPX.

1. Connect an Ethernet cable from the network to the rear panel Ethernet port.

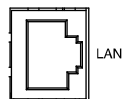

2. Turn On DHCP and Web Server Page 138 & settings. 143

3. The indicator will be shown when a remote connection has been established.

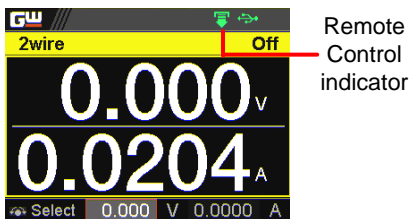

It may be necessary to cycle the power or refresh the web browser to connect to a network.

Web Server Remote Control Function Check

Functionality check

Enter the IP address of the power supply in a web browser after the instrument has been configured as a web server.

The web server allows you to monitor the function settings of the PPX.

The web browser interface appears as follows.

GW INSTEK
Simply Reliable

Visit Our Site | Support | Contact Us

PPX Series

Welcome Page | **Web Control Page** | System Information

Network Configuration: Thanks For Your Using

Measurement: Use the left menu to select the function you need.

Normal Function: Menu Home to Please refer to user manual.

External Control

Temperature Control

Analog Control

Figure of Dimensions

Sequence

Datalog

Manufacturer	GW-INSTEK
Serial Number	FW124456
Description	GW-INSTEK-PPX-3603
Firmware Version	V9_A3
System ID	0-124456
DNS Hostname	0-124456.local
IP Address	172.16.26.48
Subnet Mask	255.255.128.0
Gateway	172.16.1.254
DNS	172.16.1.252
MAC Address	08-11-23-31-12-79
DHCP State	ON
VISA/TCPIP Connect	TCP/IP: 172.16.26.48:22 RS-485: 172.16.26.48:22

Copyright 2019 © Good Will Instruments Co., Ltd All Rights Reserved.

The web browser interface allows you to access the following:

- Network configuration settings
- Measurement setting
- Normal Function setting
- External Control setting
- Temperature Control setting
- Analog Control
- Figure of Dimension
- Sequence setting
- Datalog setting

Sockets Server Configuration

Configuration This configuration example will configure the PPX socket server.

The following configuration settings will manually assign the PPX an IP address and enable the socket server. The socket server port number is fixed at 2268.

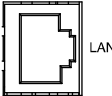
1. Connect an Ethernet cable from the network to the rear panel Ethernet port. 
2. Turn Off DHCP setting followed by setting the relevant settings including IP Address, Subnet Mask, Gateway IP and DNS Address. Page 140

3. The indicator will be shown when a remote connection has been established.

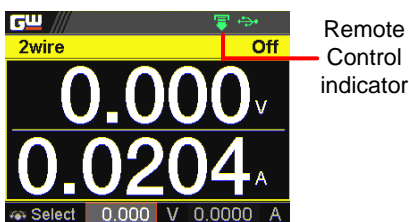

Socket Server Function Check

Background To test the socket server functionality, National Instruments Measurement and Automation Explorer can be used. This program is available on the NI website, www.ni.com, via a search for the VISA Run-time Engine page, or “downloads” at the following URL, <http://www.ni.com/visa/>

Requirements Operating System: Windows XP, 7, 8, 10

Functionality check 1. Start the NI Measurement and Automation Explorer (MAX) program. Using Windows, press:

Start>All Programs>National Instruments>Measurement & Automation



2. From the Configuration panel access;

My System>Devices and Interfaces>Network Devices

3. Press *Add New Network Device>Visa TCP/IP Resource...*

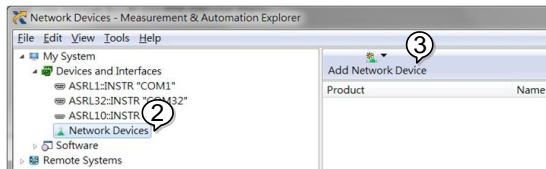

4. Select *Manual Entry of Raw Socket* from the popup window.

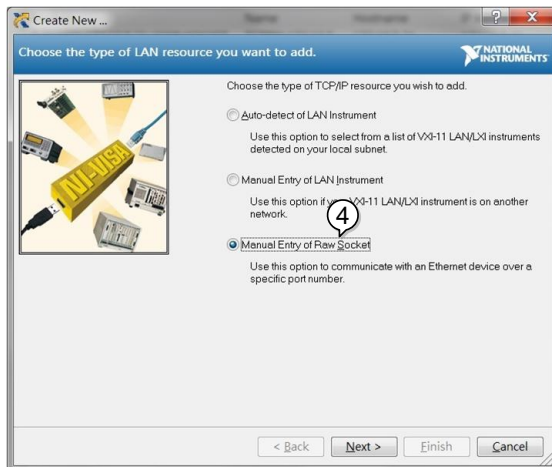

5. Enter the IP address and the port number of the PPX. The port number is fixed at 2268.
6. Click the Validate button.
7. A popup will appear if a connection is successfully established.
8. Click Next.



9. Next configure the Alias (name) of the PPX connection. In this example the Alias is: PPX_DC1

10. Click finish.



11. The IP address of the PPX will now appear under Network Devices in the configuration panel. Select this icon now.

12. Click *Open VISA Test Panel*.

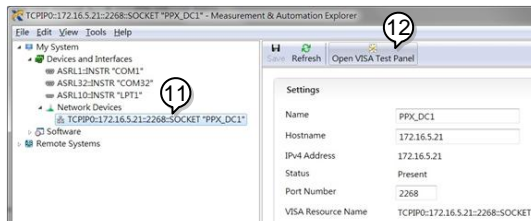

13. Click the *Configuration* icon,

14. Click on *I/O Settings*.

15. Make sure the *Enable Termination Character* check box is checked, and the terminal character is \n (Value: xA).

16. Click *Apply Changes*.

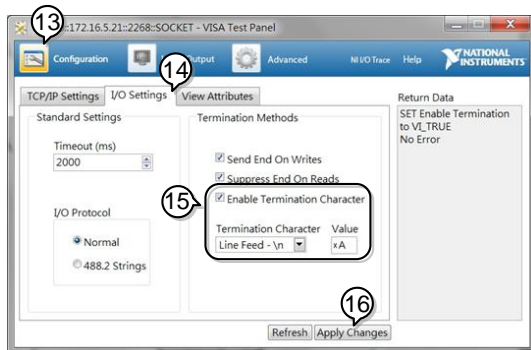

17. Click the *Input/Output* icon.

18. Enter *IDN? in the *Select or Enter Command* dialog box if it is not already.

19. Click the *Query* button.

20. The *IDN? query will return the Manufacturer, model name, serial number and firmware version in the dialog box.

GW-INSTEK,PPX-10H01,TW123456,V0.A4



 Note

For further details, please see the programming manual, available on the GW Instek web site @ www.gwinstek.com.

FAQ

- How often should the power supply be calibrated?
- The OVP voltage is triggered earlier than expected.
- Can I combine more than 1 cable together for the output wiring?
- The accuracy does not match the specification.

How often should the power supply be calibrated?

The PPX should be calibrated by an authorized service center at least every 2 years. For details regarding calibration, see your local dealer or GWInstek at www.gwinstek.com / marketing@goodwill.com.tw.

The OVP voltage is triggered earlier than expected.

When setting the OVP voltage, take into account the voltage drop from the load cables. As the OVP level is set from the output terminals and not the load terminals, the voltage at the load terminals may be slightly lower.

Can I combine more than 1 cable together for the output wiring?

Yes. Cables can be used together (in parallel) if the current capacity of a single cable is insufficient. However the withstand voltage should also be taken into account. Ensure the cables are twisted together and are the same length.

The accuracy does not match the specification.

Make sure the device is powered On for at least 30 minutes, within $23^{\circ}\text{C}\pm 5^{\circ}\text{C}$. This is necessary to stabilize the unit to match the specification.

For more information, contact your local dealer or GWInstek at www.gwinstek.com / marketing@goodwill.com.tw.

A PPENDIX

PPX Factory Default Settings

The following default settings are the factory configuration settings for the power supply.

For details on how to return to factory default settings, see page 62.

Initial	Default Setting
Output	Off
LOCK	Disabled
Voltage Set	0.000 V
Current Set	0.0000 A

Output	Default Setting
Output On Dly(Delay)	00(hour):00(minute):00.00(sec)
Output Off Dly(Delay)	00(hour):00(minute):00.00(sec)
Remote Sense	2 Wire
V/I Slew Rate	CVHS = CV high speed priority
R_V(Rising Voltage) Slew Rate	0.001 V/ms (PPX-10H01) 0.0001 V/ms (Other)
F_V(Falling Voltage) Slew Rate	0.001 V/ms (PPX-10H01) 0.0001 V/ms (Other)
R_C(Rising Current) Slew Rate	0.00001 A/ms (PPX all series)
F_C(Falling Current) Slew Rate	0.00001 A/ms (PPX all series)

Measurement	Default Setting
Measure Average	Off
Voltage Range	Auto
Current Range	Auto

EXT (External) Control	Default Setting
CV Control	Front Panel
CC Control	Front Panel
Output Type	High
Output Enable	Off

TRIG(Trigger Control)	Default Setting
Trigin Level	High
Trigin Action	None
Trigin Voltage	0.000 V
Trigin Current	0.0000 A
Trigin Memory	M1
Trigout Level	Low
Trigout Source	None
Trigout Width	1.0 ms

PWR(Power) On Config	Default Setting
Power On Status	Safe

Constant PWR(Power)	Default Setting
Control	Off
Power	$(1.05 \times V_{rate}) * (1.05 \times I_{rate})$

Temperature	Default Setting
Control	Off
Unit	°C
Output Safe	Off
Monitor	100.0 °C
Adjust	0.0 °C

Save/Recall	Default Setting
Save Mem(Memory) Set	M1
Recall Mem(Memory) Set	M1

Utility - Buzzer	Default Setting
Protect	On
Keyboard	Off

Utility - Bleeder	Default Setting
Bleeder	On

APP - AH/WH Meter (License Key)	Default Setting
Mode	Disable
AHour	999999999.999 Ah
WHour	999999999.999 Wh

Protect	Default Setting
Voltage Limit	Off
UVL	0.000 V
OVP Level	1.1 X Vrate
Current Limit	Off
OCV Level	1.1 X Irate)
OCP Delay	0.050 s

PPX Specifications

The specifications apply when the PPX is powered on for at least 30 minutes.

Input ratings (AC rms)

Model	PPX-1005	PPX-2002	PPX-2005	PPX-3601	PPX-3603	PPX-10H01
Nominal input voltage*1	100Vac / 120Vac / 220Vac / 240Vac, 50Hz / 60Hz, single phase					
Input voltage range	±10%					
Input frequency range	47Hz to 63Hz					
Max. Inrush current	≤ 25Amax	≤ 20Amax	≤ 30Amax	≤ 35Amax	≤ 40Amax	≤ 30Amax
Max. power consumption	200VA	150VA	300VA	150VA	300VA	300VA

*1. Before connecting the power plug to an AC line outlet, make sure the voltage selector switches of the bottom panel in the correct position. It might be damaged the instrument by connecting to the wrong AC line voltage.

DC mode output ratings

Model	PPX-1005	PPX-2002	PPX-2005	PPX-3601	PPX-3603	PPX-10H01	
Rating	Output voltage	10.000V	20.000V	20.000V	36.000V	36.000V	100.00V
	Output current	5.0000A	2.0000A	5.0000A	1.0000A	3.0000A	1.0000A
	Output power	50W	40W	100W	36W	108W	100W
	Setting range (105%)	0V to 10.5V	0V to 21.0V	0V to 21.0V	0V to 37.8V	0V to 37.8V	0V to 105.0V
	Setting resolution	0.2mV	0.5mV	0.5mV	1mV	1mV	2mV
	Setting accuracy (23°C±5°C)	±(0.03% of setting + 3mV)	±(0.03% of setting + 5mV)	±(0.03% of setting + 5mV)	±(0.03% of setting + 8mV)	±(0.03% of setting + 8mV)	±(0.03% of setting + 20mV)
	Line regulation*7	±(0.01% of setting + 1mV)	±(0.01% of setting + 1mV)	±(0.01% of setting + 1mV)	±(0.01% of setting + 3mV)	±(0.01% of setting + 3mV)	±(0.01% of setting + 7mV)
	Load regulation*8	±(0.01% of setting + 2mV)	±(0.01% of setting + 2mV)	±(0.01% of setting + 3mV)	±(0.01% of setting + 3mV)	±(0.01% of setting + 4mV)	±(0.01% of setting + 7mV)
	Transient response*1	<50us				<100us	
	Ripple noise (Vrms*2 / Vpp*3)	0.35mVrms / <6mVpp	0.5mVrms / <8mVpp	0.5mVrms / <8mVpp	0.8mVrms / <10mVpp	0.8mVrms / <10mVpp	1.2mVrms / <15mVpp
Rise time*4	Rated load	≤ 20ms			≤ 50ms		≤ 100ms
	No load	≤ 20ms			≤ 50ms		≤ 100ms
Fall time*5	Rated load	≤ 10ms			≤ 20ms		≤ 50ms
	No load	≤ 100ms			≤ 150ms		≤ 250ms

	Maximum remote sensing compensation voltage (single line)		1V			3V
	Temperature Coefficient (TYP.) ^{*6}		100 ppm/°C			
	Setting range (105%)	0A to 5.25A	0A to 2.1A	0A to 5.25A	0A to 1.050A	0A to 3.15A 0A to 1.050A
	Setting resolution	0.1mA	0.05mA	0.1mA	0.02mA	0.1mA 0.02mA
	Setting accuracy (23°C±5°C)	±(0.05% of setting + 3.0mA)	±(0.05% of setting + 1.0mA)	±(0.05% of setting + 3.0mA)	±(0.05% of setting + 0.5mA)	±(0.05% of setting + 1.5mA) ±(0.05% of setting + 1.0mA)
Current	Line regulation ^{*7}	±(0.02% of setting + 250uA)	±(0.02% of setting + 100uA)	±(0.02% of setting + 250uA)	±(0.02% of setting + 50uA)	±(0.02% of setting + 150uA) ±(0.02% of setting + 50uA)
	Load regulation ^{*9}	±(0.02% of setting + 250uA)	±(0.02% of setting + 100uA)	±(0.02% of setting + 250uA)	±(0.02% of setting + 50uA)	±(0.02% of setting + 150uA) ±(0.02% of setting + 50uA)
	Ripple (Arms ^{*2}) noise	2mA	1mA	2mA	400uA	1mA 1mA
	Temperature Coefficient (TYP.) ^{*6}		200 ppm/°C			

*1. Time for output voltage to recover within ±(0.1% + 10mV) of its rated output for a load change from 50% to 100% of its rated output current.

*2. Measurement frequency bandwidth is 5 Hz to 1 MHz.

*3. Measurement frequency bandwidth is 10 Hz to 20 MHz.

*4. From 10%–90% of rated output voltage, with rated resistive load.

*5. From 90%–10% of rated output voltage, with rated resistive load.

*6. Temperature coefficient: after a 30 minute warm-up.

*7. At 90–110Vac or 108–132Vac or 198–242Vac or 216–264Vac, constant load.

*8. From No-load to Full-load, constant AC input voltage.

Make sure that test leads and output terminals are well connected.

It is suggested that utilize 4-wire connection when european terminal output models are employed.

*9. For load voltage change, equal to the unit voltage rating, constant AC input voltage.

Measured value display

Model		PPX-1005	PPX-2002	PPX-2005	PPX-3601	PPX-3603	PPX-10H01
Voltage Range	Hight	10.000V	20.000V	20.000V	36.000V	36.000V	100.00V
	Low	1.0000V	2.0000V	2.0000V	3.6000V	3.6000V	10.000V
Current Range	Hight	5.0000A	2.0000A	5.0000A	1.0000A	3.0000A	1.0000A
	Mid	500.00mA	200.00mA	500.00mA	100.00mA	300.00mA	100.00mA
	Low	50.000mA	20.000mA	50.000mA	10.000mA	30.000mA	10.000mA
	L-Low	5.0000mA	2.0000mA	5.0000mA	1.0000mA	3.0000mA	1.0000mA
Measurement Resolution	Voltage(H)			1mV			10mV
	Voltage(L)			0.1mV			1mV
	Current(H)			0.1mA			0.1mA
Resolution	Current(M)			0.01mA			0.01mA
	Current(L)			0.001mA			0.001mA
	Current(LL)			0.0001mA			0.0001mA

	Voltage(H/L)	$\pm(0.03\%$ of rdg + 2mV)	$\pm(0.03\%$ of rdg + 4mV)	$\pm(0.03\%$ of rdg + 5mV)	$\pm(0.03\%$ of rdg + 6mV)	$\pm(0.03\%$ of rdg + 8mV)	$\pm(0.03\%$ of rdg + 15mV)
	Temperature Coefficient*1 (TYP.)	100 ppm/°C					
Measurement Accuracy	Current(H/M)	$\pm(0.05\%$ of rdg + 2.5mA)	$\pm(0.05\%$ of rdg + 1.0mA)	$\pm(0.05\%$ of rdg + 2.5mA)	$\pm(0.05\%$ of rdg + 0.4mA)	$\pm(0.05\%$ of rdg + 1.2mA)	$\pm(0.05\%$ of rdg + 1.0mA)
	Current(L/LL)	$\pm(0.1\%$ of rdg + 40uA)	$\pm(0.1\%$ of rdg + 24uA)	$\pm(0.1\%$ of rdg + 40uA)	$\pm(0.1\%$ of rdg + 16uA)	$\pm(0.1\%$ of rdg + 28uA)	$\pm(0.1\%$ of rdg + 24uA)
	Temperature Coefficient*1 (TYP.)	200 ppm/°C					

*1. Temperature coefficient: after a 30 minute warm-up.

Measured value display

Model	PPX-1005	PPX-2002	PPX-2005	PPX-3601	PPX-3603	PPX-10H01
Temperature Range	-200°C~+1372°C					
(K-Type Thermocouple) Resolution	0.25°C					
Accuracy	$\pm(0.5\% + 2^\circ\text{C})$					

Protection Function

Model	PPX-1005	PPX-2002	PPX-2005	PPX-3601	PPX-3603	PPX-10H01	
Over Voltage Protection (OVP)	Operation Turns the output off, displays OVP and lights ALARM						
	Setting range	0.5V to 11.0V	1.0V to 22.0V	1.0V to 22.0V	1.8V to 39.6V	1.8V to 39.6V	5.0V to 110.0V
	Setting Accuracy	$\pm(1\%$ of rating) (5% to 110% of the rated output voltage)					
Over Current Protection (OCP)	Operation Turns the output off, displays OCP and lights ALARM						
	Setting range	0.25A to 5.5A	0.1A to 2.2A	0.25A to 5.5A	0.05A to 1.1A	0.15A to 3.3A	0.05A to 1.1A
	Setting Accuracy	$\pm(1\%$ of rating) (5% to 110% of the rated output current)					
Over Temperature Protection (OTP)	Operation Turns the output off, displays OTP and lights ALARM						

Analog Control and Signal output

Model	PPX-1005	PPX-2002	PPX-2005	PPX-3601	PPX-3603	PPX-10H01
External Voltage Control output voltage	Accuracy	0% to 100% of the rated output voltage in the range of 0V to 10V				
		1% of rating				
External Voltage Control output current	Accuracy	0% to 100% of the rated output voltage in the range of 0V to 10V				
		1% of rating				
External Resistor Control output voltage	Accuracy	0% to 100% of the rated output voltage in the range of 0Ω to 10kΩ				
		1% of rating				
External Resistor Control output current	Accuracy	0% to 100% of the rated output voltage in the range of 0Ω to 10kΩ				
		1% of rating				
OUTPUT ON/OFF CONT	Output on/off control	Possible logic selections: Turn the output on using a LOW (0 V to 0.5 V) or short-circuit, turn the output off using a HIGH (4.5 V to 5 V) or open-circuit. Turn the output on using a HIGH (4.5 V to 5 V) or open-circuit, turn the output off using a LOW (0 V to 0.5 V) or short-circuit.				
	Voltage monitor (V MON)	10.00V±0.1V (at rated voltage output)				
Monitor signal output	Current monitor (I MON)	0V±0.1V (at 0V output)				
		10.00V±0.1V (at rated current output)				
Status signal Out*2	OUT ON/OFF STATUS	Turns on when the output is on				
	CV STATUS	Turns on during CV operation				
	CC STATUS	Turns on during CC operation				
	ALM STATUS	Turns on when an alarm has been activated				
	PWR ON STATUS	Turns on when the power is turned on				

*1. EXT I/O connector on the rear panel.

*2. Open collector output: Maximum voltage of 30 V and maximum current of 8 mA. The common line for the status pins is floating (isolated voltage of 60 V or less), it is isolated from the output and control circuits.

Interface Capabilities

Model	PPX-1005	PPX-2002	PPX-2005	PPX-3601	PPX-3603	PPX-10H01
LAN	MAC Address, DNS IP Address, User Password, Gateway IP Address, Instrument IP Address, Subnet Mask					
USB	Type A: Host, Type B: Slave, Speed: 1.1/2.0, USB-CDC					
RS-232/RS-485	Complies with the EIA-RS-232/RS-485 specifications (excluding the connector)					

General Specifications

Model	PPX-1005	PPX-2002	PPX-2005	PPX-3601	PPX-3603	PPX-10H01
Weight	Approx. 5.5kg					
Dimensions (mm)	107(W)×124(H)×313(D) (not including protrusions)					
Operating environment	Indoor use, Overvoltage Category II					
Operating temperature	0°C to 40°C					
Storage temperature	-20°C to 70°C					
Operating humidity	20% to 80% RH; No condensation					
Storage humidity	20% to 85% RH; No condensation					
Altitude	Maximum 2000m					
EMC	Complies with the European EMC directive 2014/30/EU for Class A test and measurement products.					
Safety	Complies with the European Low Voltage Directive 2014/35/EU and carries the CE-marking.					
Withstand voltage	Between input and chassis	No abnormalities at 1500 Vac for 1 minute.				
	Between input and output	No abnormalities at 3000 Vac for 1 minute.				
	Between output and chassis	No abnormalities at 500 Vdc for 1 minute.				
Insulation resistance	Between input and chassis	500 Vdc, 100MΩ or more				
	Between input and output	500 Vdc, 100MΩ or more				
	Between output and chassis	500 Vdc, 100MΩ or more				

PPX Dimensions

PPX Series

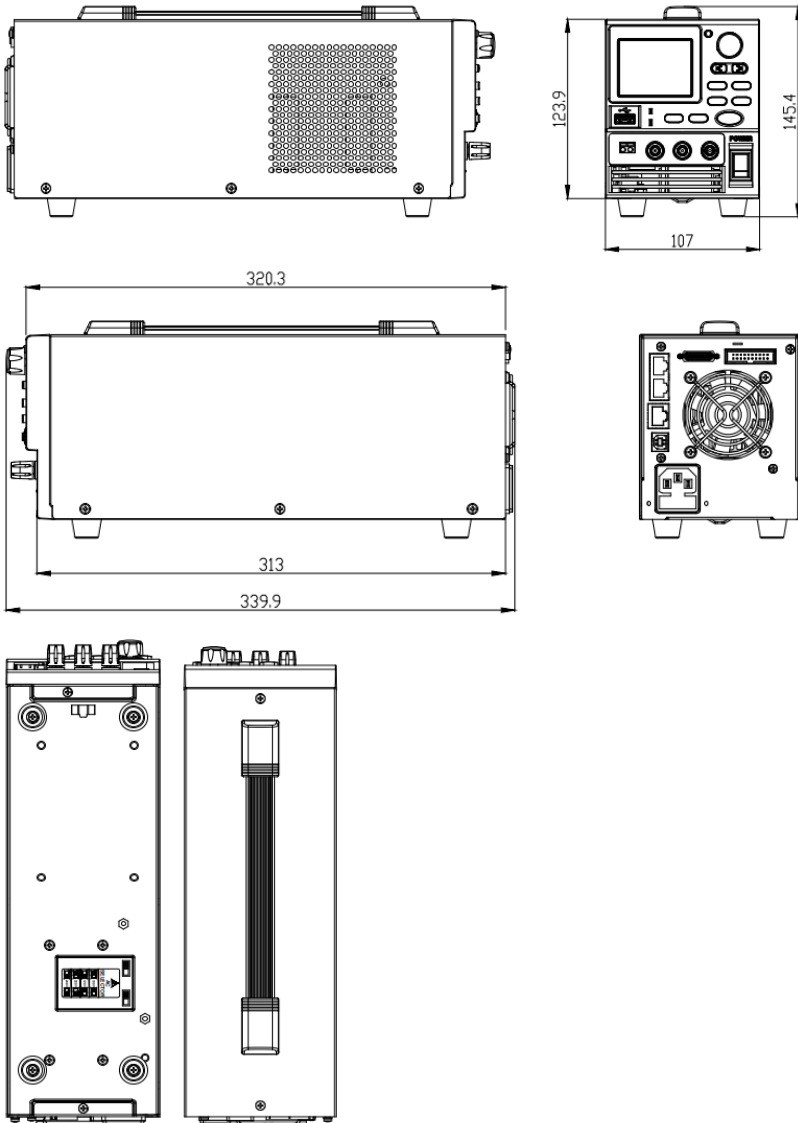

Declaration of Conformity

We

GOOD WILL INSTRUMENT CO., LTD.

declare that the below mentioned product

Type of Product: Programmable High Precision DC Power Supply

Model Number: PPX-1005 / PPX-2002 / PPX-2005 / PPX-3601 / PPX-3603 / PPX-10H01

are herewith confirmed to comply with the requirements set out in the Council Directive on the Approximation of the Law of Member States relating to EMC (2014/30/EU), LVD (2014/35/EU), WEEE (2012/19/EU) and RoHS (2011/65/EU).

For the evaluation regarding the Electromagnetic Compatibility and Low Voltage Directive, the following standards were applied:

© Electric Magnetic Compatibility Directive 2014/30/EU	
EN 61326-1 : EN 61326-2-1:	Electrical equipment for measurement, control and laboratory use — EMC requirements (2013)
Conducted and Radiated Emissions EN 55011:2016+A1:2017 Class A EN 55032:2015	Electrical Fast Transients EN 61000-4-4: 2012
Current Harmonic EN 61000-3-2:2019	Surge Immunity EN 61000-4-5: 2014+A1:2017
Voltage Fluctuation EN 61000-3-3:2013+A1:2019	Conducted Susceptibility EN 61000-4-6: 2014
Electrostatic Discharge EN 61000-4-2: 2009	Power Frequency Magnetic Field EN 61000-4-8:2010
Radiated Immunity EN 61000-4-3:2006+A1:2008+A2:2010	Voltage Dips/ Interrupts EN 61000-4-11: 2004+A1:2017
©Low Voltage Directive 2014/35/EU	
Safety Requirements	EN 61010-1:2010 / A1:2019(Third Edition)

GOODWILL INSTRUMENT CO., LTD.

No. 7-1, Jhongsing Road, Tucheng District, New Taipei City 236, Taiwan

Tel: [+886-2-2268-0389](tel:+886-2-2268-0389)

Fax: [+886-2-2268-0639](tel:+886-2-2268-0639)

Web: <http://www.gwinstek.com>

Email: marketing@goodwill.com.tw

GOODWILL INSTRUMENT (SUZHOU) CO., LTD.

No. 521, Zhujiang Road, Snd, Suzhou Jiangsu 215011, China

Tel: [+86-512-6661-7177](tel:+86-512-6661-7177)

Fax: [+86-512-6661-7277](tel:+86-512-6661-7277)

Web: <http://www.instek.com.cn>

Email: marketing@instek.com.cn

GOODWILL INSTRUMENT EURO B.V.

De Run 5427A, 5504DG Veldhoven, The Netherlands

Tel: [+31-\(0\)40-2557790](tel:+31-(0)40-2557790)

Fax: [+31-\(0\)40-2541194](tel:+31-(0)40-2541194)

Email: sales@gw-instek.eu

INDEX

Accessories	10	EN61010	
Alarm		pollution degree.....	7
description	24	Environment	
Analog connector		safety instruction	7
pin assignment	158	Ethernet	
Analog control		interface.....	199
output control.....	169, 171	sockets.....	202
overview.....	156	web server	199
remote monitoring	173	FAQ	208
resistance control - current		Ground	
output	167	symbol.....	5
resistance control - voltage		Grounding	28
output	166	How to use the instrument.....	34
status monitoring	175	Marketing	
voltage control - current output	163	contact	209
voltage control - voltage output	160	Menu Tree.....	40
Bleeder control		Model differences	9
description	23	OCP level	47
Build date		Operating area description.....	20
view	39	Operation considerations	25
Caution symbol	5	floating output	28
CC and CV mode		inrush current.....	25
description	21	pulsed loads	25
CC mode		reverse current	26
operation	55	Optional accessories	10
Cleaning the instrument.....	7	Output terminal	33
Configuration		OVP level	47
script test settings.....	75, 77	Package contents.....	10
test function settings.....	82	Panel lock.....	60
Conventions	34	Power sequence	31
CV mode		Rack mount	
operation	51	description.....	34
Declaration of conformity	219	Rear panel diagram	18
Default settings.....	210	Recall setup39, 62, 63, 66, 71, 82, 94, 98	
reset.....	38	Remote control	178
Display mode		Ethernet configuration	199
operation	59	Ethernet function check	200
Disposal instructions.....	7	GPIB configuration.....	187

GPIB function check.....	188	Slew rate	
interface configuration.....	179	description.....	22
local bus configuration.....	196	Socket server function check	180, 203
multi-unit configuration.....	196	Specifications.....	213
multi-unit function check.....	197	System version	
sockets configuration.....	202	view.....	39
sockets function check.....	180, 203	Test script	
UART configuration.....	192	Export.....	101
USB configuration.....	179	Load.....	98
USB function check.....	194	overview.....	75, 77
Remote sense connector.....	64	Run.....	94
Save setup	38, 61, 62, 66, 67, 68, 69, 132, 133	UVL level.....	47
Service operation		Warning symbol.....	5
about disassembly.....	6	Web server function check.....	200
contact.....	209		