

Programmable DC Electronic Load

PEL-2000B Series

USER MANUAL



ISO-9001 CERTIFIED MANUFACTURER

This manual contains proprietary information, which is protected by copyright. All rights are reserved. No part of this manual may be photocopied, reproduced or translated to another language without prior written consent of the Good Will company.

The information in this manual was correct at the time of printing. However, Good Will continues to improve products and reserves the right to change specification, equipment, and maintenance procedures at any time without notice.

Good Will Instrument Co., Ltd.
No. 7-1, Jhongsing Rd., Tucheng Dist., New Taipei City 236, Taiwan.

Table of Contents

SAFETY INSTRUCTIONS	6
GETTING STARTED.....	10
Main Features.....	12
Series Overview	14
Package Contents and Accessories	16
Measurement Overview	17
Front Panel Overview.....	18
Display Overview – Mainframe	23
Rear Panel Overview	27
Front Panel Overview – Load Module	30
LED Display Overview – Load Module	33
Installation	36
Load Connections	43
Frame Link Connection	53
Channel Control Connection	55
Go/NoGo Connection	58
OPERATING DESCRIPTION.....	59
Operating Mode Description	60
Group Unit Mode	70
Run Program	72
Sequence	75
OCP Test Automation	79
Parallel Dynamic Loading	80
Configurations Description.....	81
Interface and System	90
TUTORIALS	97
Local loads	98
Single Channel Load	100

Parallel Load Modules	102
Programming.....	104
Sequences	106
Frame Link.....	107
Channel Control.....	109
General Configuration Options	111
OPERATION	113
Local Mode Operation	116
Mainframe Basic Operation	122
Creating a Program Sequence	145
Edit Sequence	157
OCP Test Automation	166
Channel Configuration	172
Mainframe Configuration	198
Interface Configuration (settings)	221
UART, LAN and USB CDC Function Check	227
GPIB Function Check	230
Saving/Recalling Channels.....	232
INTERFACE.....	267
Interface Configuration	268
FAQ.....	282
APPENDIX.....	283
Fuse Replacement.....	283
Firmware Update	284
Calibration	287
Range Chart.....	288
Default Settings	293
Specifications	296
Dimensions	307
Certificate Of Compliance	310

INDEX 311

S SAFETY INSTRUCTIONS

This chapter contains important safety instructions that you must follow when operating the PEL-2000B series, and when keeping it in storage. Read the following before operating the PEL-2000B series to ensure your safety and to keep the PEL-2000B series in the best possible condition.

Safety Symbols

These safety symbols may appear in this manual or on the PEL-2000B series.



WARNING

Warning: Identifies conditions or practices that could result in injury or loss of life.



CAUTION

Caution: Identifies conditions or practices that could result in damage to the PEL-2000B series or to other properties.



DANGER High Voltage



Attention Refer to the Manual



Protective Conductor Terminal



Earth (ground) Terminal



Do not dispose electronic equipment as unsorted municipal waste. Please use a separate collection facility or contact the supplier from which this instrument was purchased.

Safety Guidelines

General Guideline



CAUTION

- Do not place any heavy object on the PEL-2000B series.
- Avoid severe impact or rough handling that leads to damaging the PEL-2000B series.
- Do not discharge static electricity to the PEL-2000B series.
- Do not block or obstruct the cooling fan vent openings.
- Do not perform measurement at circuits directly connected to Mains (Note below).
- Do not disassemble the PEL-2000B series unless you are qualified as service personnel.
- The equipment is not for measurements performed for CAT II, III and IV.

(Measurement categories) EN 61010-1 specifies the measurement categories and their requirements as follows. The PEL-2000B series falls under category I.

- Measurement category IV is for measurement performed at the source of low-voltage installation.
- Measurement category III is for measurement performed in the building installation.
- Measurement category II is for measurement performed on the circuits directly connected to the low voltage installation.
- Measurement category I is for measurements performed on circuits not directly connected to Mains.

Power Supply



WARNING

- AC Input voltage range: 100-120Vac/ 200-240Vac (90-132Vac/ 180-250Vac)
Frequency: 47~63Hz
Power rating: PEL-2004B: 250VA Max
PEL-2002B: 150VA Max
 - Connect the protective grounding conductor of the AC power cord to an earth ground, to avoid electrical shock.
-

Fuse	<ul style="list-style-type: none">• Fuse type: T3.15A/250V
 WARNING	<ul style="list-style-type: none">• Make sure the correct type of fuse is installed before power up.• To avoid fire, only replace the fuse with the specified type and rating.• Disconnect the power cord before fuse replacement.• Make sure the cause of a fuse blowout is fixed before replacing the fuse.
Cleaning the PEL-2000B	<ul style="list-style-type: none">• Disconnect the power cord before cleaning.• Use a soft cloth dampened in a solution of mild detergent and water. Do not spray any liquid.• Do not use chemicals or cleaners containing harsh material such as benzene, toluene, xylene, and acetone.
Operation Environment	<ul style="list-style-type: none">• Location: Indoor, no direct sunlight, dust free, almost non-conductive pollution (Note below)• Temperature: 0°C to 40°C• Altitude: Up to 2000m• Transient Overvoltage on the main supply is 2500V. <p>(Pollution Degree) EN 61010-1 specifies the pollution degrees and their requirements as follows. The PEL-2000B series falls under degree 2.</p> <p>Pollution refers to “addition of foreign matter, solid, liquid, or gaseous (ionized gases), that may produce a reduction of dielectric strength or surface resistivity”.</p> <ul style="list-style-type: none">• Pollution degree 1: No pollution or only dry, non-conductive pollution occurs. The pollution has no influence.• Pollution degree 2: Normally only non-conductive pollution occurs. Occasionally, however, a temporary conductivity caused by condensation must be expected.• Pollution degree 3: Conductive pollution occurs, or dry, non-conductive pollution occurs which becomes conductive due to

condensation which is expected. In such conditions, equipment is normally protected against exposure to direct sunlight, precipitation, and full wind pressure, but neither temperature nor humidity is controlled.

Storage environment

- Location: Indoor
- Relative Humidity: < 80%
- Temperature: -10°C to 70°C

Disposal

Do not dispose this instrument as unsorted municipal waste. Please use a separate collection facility or contact the supplier from which this instrument was purchased. Please make sure discarded electrical waste is properly recycled to reduce environmental impact.

GETTING STARTED

This chapter describes the features and functions of the PEL-2000B series, including the front and rear panel appearance, panel installation and connection types. Use the Tutorial section for quick access to step by step instructions on the main functions.



Main Features	12
Series Overview	14
Package Contents and Accessories	16
Measurement Overview	17
Front Panel Overview	18
Display Overview – Mainframe	23
Rear Panel Overview	27
Front Panel Overview – Load Module.....	30
LED Display Overview – Load Module.....	33
Installation	36
Load Module Installation.....	36
GPIB Installation	38
Rack Mount Installation.....	39
Channel Number.....	40
Power Up & Self Test	41
Load Connections	43

Precautions and Procedures	43
Remote (Sense) Connection	48
Single Load Connections	49
Parallel Load Connections	51
Frame Link Connection	53
Channel Control Connection	55
Go/NoGo Connection	58

Main Features

Description The PEL-2002B and PEL-2004B are multichannel programmable DC electronic load mainframes. The PEL-2002B mainframe is able to hold 2 load modules, whilst the PEL-2004B is able to hold 4. The flexible module configuration allows the mainframes to either sink multiple loads independently or large loads when used in parallel.

The PEL-2000B series support four operation modes: constant current (CC), constant voltage (CV and CV+CC), constant resistance (CR) and constant power (CP). Constant current and constant resistance mode can operate in either static or dynamic mode.

- Feature Overview**
- Flexible operation with removable load modules.
 - Multiple independent isolated channels.
 - High performance, up to 5 digit resolution.
 - High slew rate enabling a high response speed
 - High capacity when frame linked.
 - Different load module types can be used in the same mainframe.
 - Dedicated parallel mode.
 - Supports rack mount installation.
 - Supports frame link connections, with up to 4 slave units.
 - Color LCD display.
 - 120 different sets of programmable sequences.
 - Accurate load simulation using Sequences.
-

- 4 panel setups.
 - USB flash drive support.
-

Interface

- USB
 - RS-232C/RS485
 - LAN
 - GPIB (optional)
-

Series Overview

The PEL-2000B series comprises of two different Mainframes: the PEL-2002B and the PEL-2004B. The Mainframes differ by the number of load module slots that can be accommodated. The PEL-2002B has two load module slots whilst the PEL-2004B has 4. There are 4 different load module models, the PEL-2020B, PEL-2030B, PEL-2040B and PEL-2041B.

PEL-2004B Mainframe

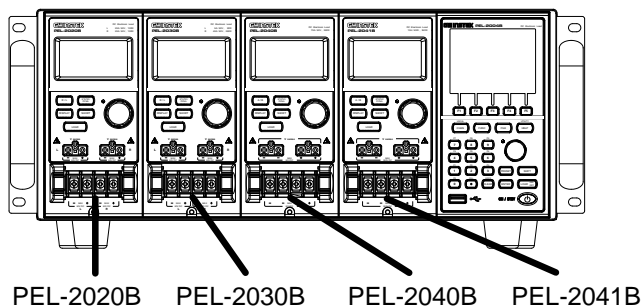

PEL-2002B Mainframe

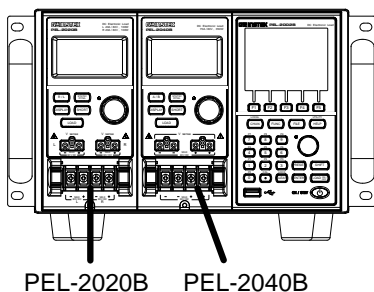

The 4 different load module models each differ in the amount of current, voltage and power and the number of channels that the load module can accommodate. The procedures in this manual will be load module model independent unless specifically stated. Below is a table showing the basic differences between each load module model. For detailed specifications, please see page 296.

Load Module	Channels	Power (W) CH L/R (low/high range)	Current (A) Range Low/High	Voltage (V)
PEL-2020B (100Wx2)	2	100/100	2/20	0-80
PEL-2030B (30/(25/250W))	2	30/(25/250)	5/4/40	0-80
PEL-2040B	1	(35/350)	7/70	0-80
PEL-2041B	1	(35/350)	1/10	0-500

Package Contents and Accessories

The PEL-2000B electronic load has a number of standard and optional accessories that can be ordered. For more information please visit the GW Instek website at www.gwinstek.com or consult your authorized distributor for details.

Standard Accessories	Description
Power Cable	Mains power cable (region dependent) (18AWGx3C,125V/10A,1.8m)
CD ROM	Contains PEL-2000B series Electronic DC Load User Manual, Programming Manual and USB Driver
GTL-120	Load cables 2X red, 2X black (per load module)
GTL-121	Remote sense cables , 1X red, 1X black (per load channel)
PEL-003	3 sets for PEL-2004B; 1 set for PEL-2002B

Options	Description
PEL-2020B	Load Module
PEL-2030B	
PEL-2040B	
PEL-2041B	
PEL-001	GPIB interface

Optional Accessories	Description
PEL-003	Panel Cover
GTL-246	USB
GTL-248	GPIB cable
GTL-249	Frame link cable
GTL-259	RS232 cable with DB9 & RJ-45
GTL-260	RS485 cable with DB9 & RJ-45

Measurement Overview

The PEL-2000B series has a number of different operating modes that are completely configurable. All the modes have customizable Go/NoGo limits, range limits, timers, slew rates, alarms and protection limits. For parallel loads, there is a dedicated Parallel configuration mode. To make tests, Programs and Sequences can be created.

Function	Description
Constant Current Mode (CC)	In constant current mode, the load module will sink a constant amount of current, regardless of the voltage.
Constant Voltage Mode (CV)	Under constant voltage mode, the voltage remains unchanged, regardless of the current.
Constant Resistance Mode (CR)	In constant resistance mode, the resistance load will remain unchanged as the voltage and current remain proportional.
Constant Power Mode (CP)	In constant power mode, the load module will ensure the power consumed is constant.
Programmable Sequences (Prog.)	The load module supports programming sequences. With up to 120 different memory settings in 12 programs with 10 sequences.
Sequences (Seq.)	Used to create load profiles to accurately simulate a load. Sequences can be created for each channel.
Group Unit Mode	Group Unit Mode enables the PEL-2000B series mainframes to easily use load modules (of the same type/rating) in parallel. Parallel mode is used in conjunction with CC or CR modes. CP and CV mode cannot be used with this mode.

Front Panel Overview

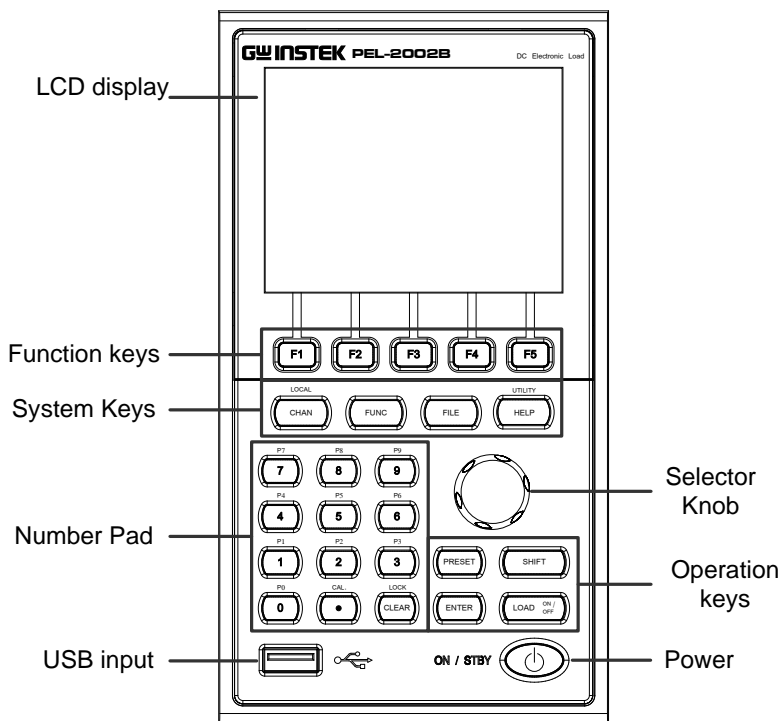



LCD display 320 by 240, TFT LCD display.

Function keys  Assigned to the menu functions on the bottom of the display.

System Keys  CHAN/LOCAL is used to select the load channel. Combined with the shift key, Local is used to activate local control (during remote control via the interface or frame link connections).

LOCAL
 Brings up the Channel Menu.

Used to activate local control mode during remote control via the interface

 + 

 Used to access the Program, Sequence or OCP automation menu.

 Used to access the File menu.

UTILITY
 Brings up the Help menu and utility menu.



UTILITY
 Provides help for the last function /key pressed.

 +  Activates the Utility Menu.

Number pad

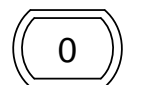
Enter numerical values, or to save/recall presets (P0-P9).

P0
 Number values.

 +  Preset numbers P0-P9.

CAL.

Decimal point and Calibration key

CAL.

Decimal point.

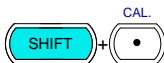
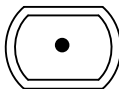

Activate calibration mode.



Note

Please note, calibration mode is not supported. Please see your distributor for calibration needs.

LOCK



Clears current values. Alternative function locks the keys and the Selector knob.

LOCK

Clears the current value.

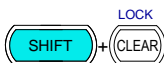

Locks all the keys and Selector knob.

USB Input



USB flash memory slot.

Selector Knob

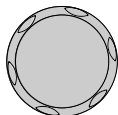

Used to select operations and to increase/decrease values.

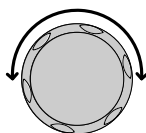

When turned left or right moves the cursor in menus or changes the selected item or value.

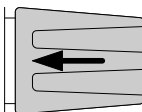

When pushed down, acts as the Enter key.

Operation Keys



Saves and recalls preset settings and values.

When pressed in combination with the number pad, Presets P0-P9 can be recalled or saved.



Inactive



Active. Used in combination with the number pad and/or shift key.

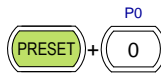

Press to recall a channel preset

Hold to save a channel preset

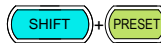

Press to recall all channel presets.

Hold to save all channel presets.



The shift key is used to access alternate functions assigned to select keys.

The shift key is also used to toggle between coarse and fine control mode when used in conjunction with the selector knob to adjust parameters.

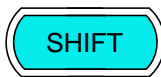

Inactive mode.

 Active. When active the shift key can be used to access the Local and Utility menus.

 Coarse control mode.

 Fine control mode

 Confirms selections.

 Turns the current load/channel on or off

 Load is currently off. (unlit)

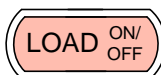
 Load is currently on. (orange light)

Power

 Turns the unit on or into standby mode.

 Standby mode.

 On.

Display Overview – Mainframe

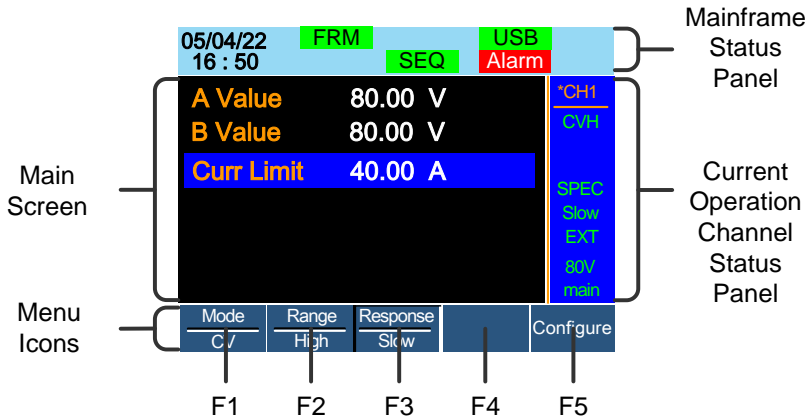

Mainframe Status Panel The Mainframe Status Panel displays the status of the Mainframe interface, programs and alarm status.

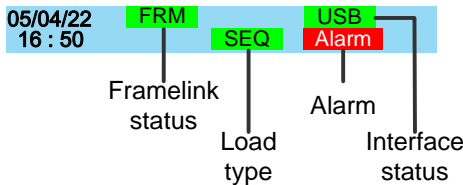

Frame Link Status

FRM	Indicates Frame Link is turned on and that the mainframe is set as either a master (FRM) or slave (FRS) unit.
FRS	

Load Type

The Load Type Icon indicates if a Sequence (SEQ) or Program (PROG) is turned on. If not then LOAD is displayed as default. When any Load type is running, their icon will turn orange.

Interface Status

The interface status icon displays which interface type is set.

Current Operation Channel Status Panel

The Current Operation Channel Status panel generally displays the status of the current channel.

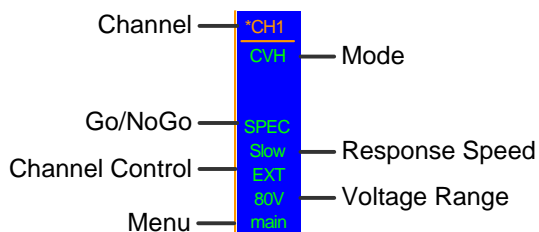

Channel	CH1~ CH8	Displays the current channel.
	*CHx	* = independent mode
	CHxS	S = Group channels Sync mode
	CHxP	P = Group channels Parallel mode

Mode Displays the current mode.

CCL	CC Static Low Range
CCH	CC Static High Range
CCDL	CC Dynamic Low Range
CCDH	CC Dynamic High Range
CRL	CR Static Low Range
CRH	CR Static High Range
CRDL	CR Dynamic Low Range
CRDH	CR Dynamic High Range
CVL	CV Static Low Range
CVH	CV Static High Range
CPL	CP Low Range
CPH	CP High Range

Go/NoGo SPEC If Go/NoGo is turned on, SPEC will be displayed.

Response Speed Slow1/
Slow2/
Slow3
Fast In CV mode the response speed will be shown, Slow or Fast.

Channel Control	EXT	When Channel Control is set to External, EXT will be displayed.
-----------------	-----	---

Voltage Range	Displays the voltage range of the current setting.
---------------	--

Menu	Shows the current menu.
------	-------------------------

- main = Chan menu
- conf = Chan→Configure menu
- s_edit = Chan→Seq.Edit menu
- file s_loop = File menu
- = Chan→Seq.Edit→Loop menu

Main Screen	Main display screen.
-------------	----------------------

Menu Icons	F1~F5	Each Menu Icon is controlled by the F1~F5 function keys directly below.
------------	-------	---

Rear Panel Overview

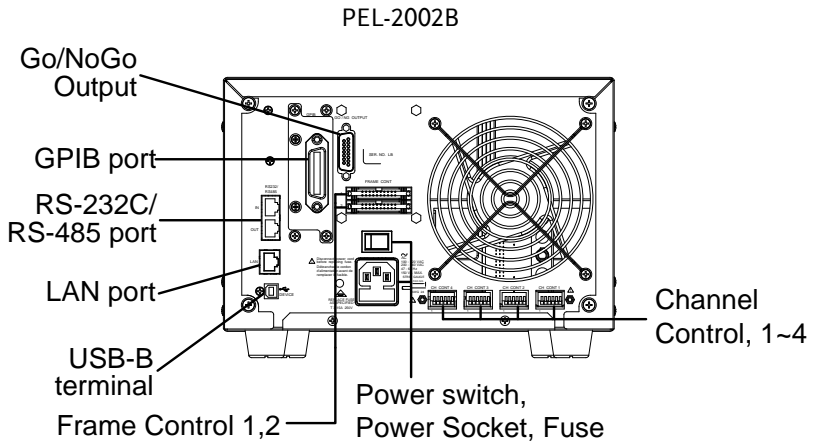
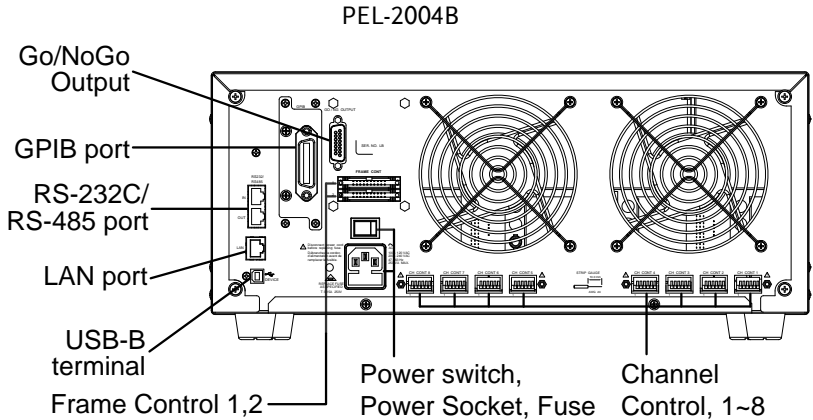

Go/NoGo Output

GO / NG OUTPUT

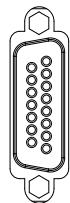

The Go/NoGo Output terminal outputs a pass (high)/fail (low) voltage for each channel.

See page 275, 58 for details.

GPIB port

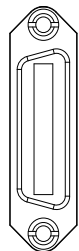

The GPIB port is used for remote control connections.

GPIB: 24-pin female

See pages 268 for remote control details.

LAN port

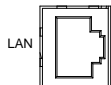

Ethernet port for controlling the PEL-2000B remotely.

See pages 237 for remote control details.

USB-B (Device) port



The USB-B (device) port, like the RS232C/RS485/GPIB/LAN port is used for remote control.

Frame Control Port

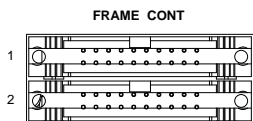

The Frame Control port is used for Frame Link connections. Mainframes are daisy-chained together. There are two Frame control ports.

1: Slave

2: Master

Connection type: MIL 20-pin connector.

For details about frame link connections see page 53, 272.

Power Switch

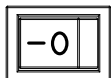

External Power Switch

Power Socket/
Fuse

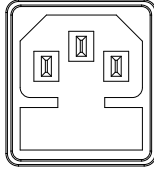

The power supply socket accepts the AC mains Voltage. The fuse holder is located below the power socket.

Power: 47~63Hz

Fuse: T3.15A/250V

For fuse replacement details see page 283.

Channel
Control port
(1~8)

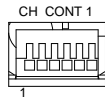

Each channel has a dedicated Channel control port to enable external monitoring and control. The channel control port has 6 wire sockets that are screw-less and self clamping.

Required wire gauge: 24 AWG

For connection or specification details see pages 55 & 270.

Remote-IN port

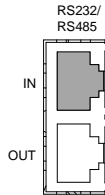

Two different types of cables can be used for RS232 or RS485-based remote control.

RS232-232: RS232 cable with DB9 connector kit.

RS485-485: RS485 cable with DB9 connector kit.

Remote-OUT
port



RJ-45 connector that is used to daisy chain power supplies with the Remote-IN port to form a communication bus.

Front Panel Overview – Load Module

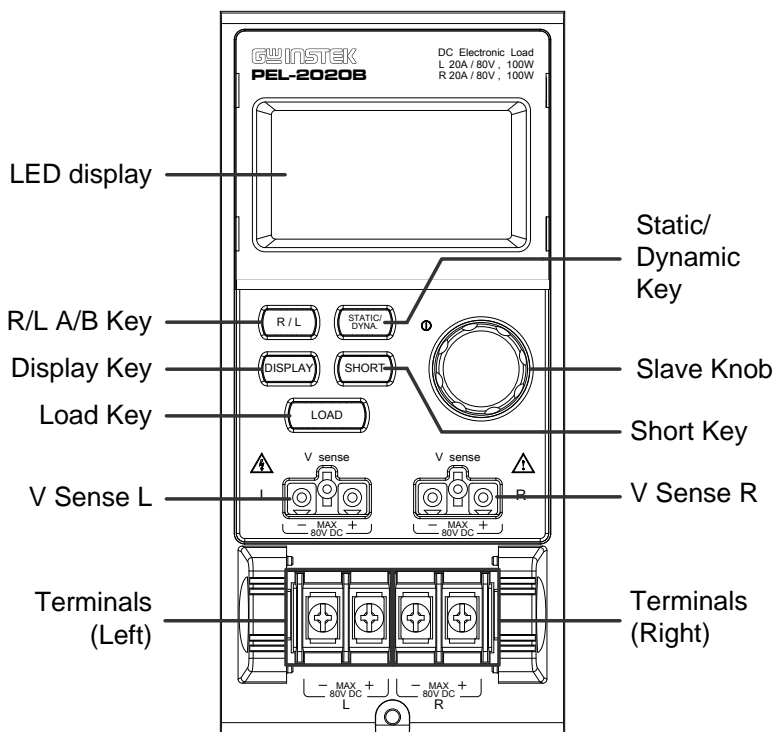

LED display 2x5 digit custom LED display.

Right/Left Key
or
A/B Key



The L/R key is used to switch between the right and left load channel on a dual channel load module. The A/B key is used to switch between A&B Values for single channel load modules.

Display Key



Used to alternate the display output on the load module.

0.0000 **A** Current

0.000 **V** Voltage

0.00 W Power

0.0 s Load time

Load Key



Activates the load for the active channel. (Right or Left)(A or B)

Left Voltage Sense

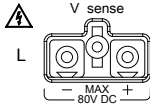

The voltage sense terminals are used when precise measurement is needed. V Sense terminals are used to compensate for voltage drops across the main terminals caused by the resistance of the load wires.

Right Voltage Sense

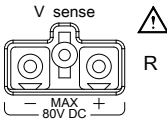

It is automatically activated when connected to a DUT.

The voltage difference between the DUT and load voltage should not exceed 2V, otherwise you will get incorrect measurement for the voltage. (applicable to all models)

Positive and Negative Terminals Left

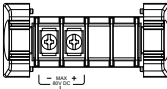

The terminals for both the left and right side of a load can draw differing amounts depending on the load module specifications.

Positive and Negative Terminals Right

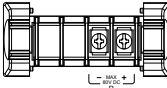

For 2 channel load modules, the left terminals are used for the 1st channel and the right terminals are used for the 2nd channel.

On single channel load modules, the left terminals are the lower (-) potential terminals, whilst the right terminals are the positive (+) potential terminals.

Static/Dynamic
Selector Key



The STATIC/DYNA. Key manually switches the load from Static (manual) to Dynamic loads.

Dynamic loads are only supported in CC and CR mode.

For more information see page 60 & 63.

Slave Knob
(Load)

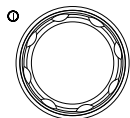

The Slave Knob is used to edit and vary parameters for the active channel on the local load.

Depending on the Mainframe setup, the Slave Knob will either only update the load (locally) or will update both the local module and the mainframe*. The Slave Knob can also be configured to display measured or set values on the local load module**.

* For more information on “Knob Type”, see page 205.

** For more information on “Slave Knob”, see page 208.

Short Key



The SHORT key is used to manually short circuit the active channel on the local active load.

The Short key can be set to enable or disable in the configure setting.

Please refer to page 180 for details.

Load on: Pressing or holding the SHORT key will short the load, depending on the short type selected.

LED Display Overview – Load Module

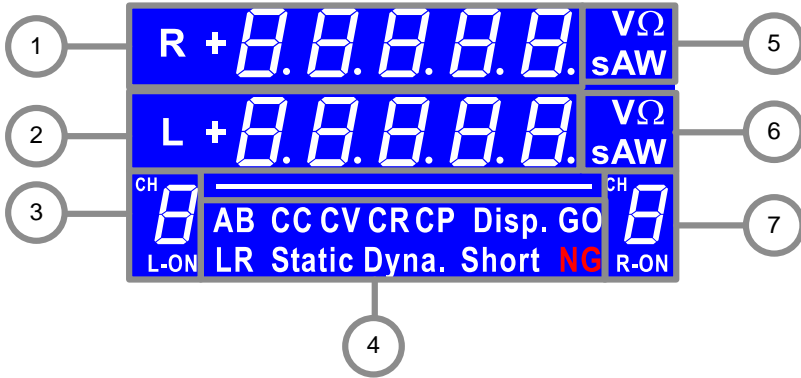

① & ②
Channel Display



R_{or}L Left and right channel indicator.



5 digit display.

③ & ⑦
Channel Number Indicator



CH 0 Indicates the channel number (1-8).

L-ON Indicates if the load is active on the load module. (Dual channel load modules)

ON Indicates if the load is on for single channel load modules.

④

Mode Indicator

The Mode Indicator LEDs will indicate what the current mode or settings are on the active channel(s).

AB CC CV CR CP Disp. GO
LR Static Dyna. Short NG

- A_{or} B** Value A or B for a single channel load module. Applies to CR, CV, CP and CC static mode only.
- CC** Constant Current Mode (CC) mode activated.
- CV** Constant Voltage Mode (CV) mode activated.
- CR** Constant Resistance Mode (CR).
- CP** Constant Power Mode (CP).
- Disp.** Display is shown on dual channel load modules when both left (L) and right (R) channel information is displayed.
- Press the Display button repeatedly to show information for both channels.
- GO** Lights up when Go/NoGo is activated and the load passes (GO) the Go/NoGo limits.
- L_{or} R** L or R will light up when the left or right channel is selected.
- Static** Lights up when in Static mode.
- Dyna.** Lights up when in Dynamic mode.
- Short** Lights up when a load is shorted.

NG Lights up when Go/NoGo is activated and the load fails (NG) the Go/NoGo limits.

⑤ & ⑥
Channel Unit
Indicators

VΩ
SAW

The Unit Indicators display the current unit.

V Voltage

Ω Resistance

A Current

W Power

S Second

Installation

The installation chapter describes how to load the different load modules, install the optional GPIB card, the rack mount kit and how to determine each channel number.

If you need to move all installed device to another location, please disassembly the modules first, and then reassembly the modules after moving to the desired location.

Load Module Installation



WARNING

To avoid static electricity, please use appropriate anti-static work practices.

Module installation

The PEL-2004B and PEL-2002B can accommodate 4 and 2 load modules, respectively. Module loads can have 1 or 2 channels. Installation of load modules is the same for both models.

Steps

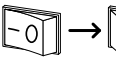
1. Ensure the mainframe is turned off from the rear panel. Disconnect the power cord. 
2. Slide the module onto the rails of an empty load slot.

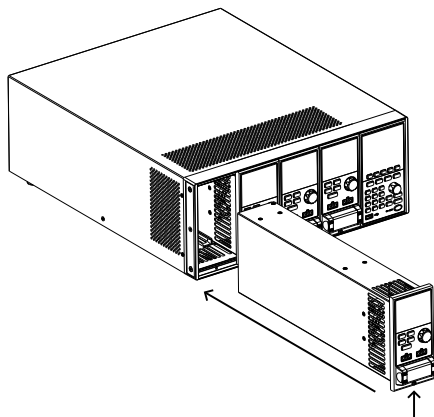

3. Use the supplied screw to fix the module to the load slot, located under the load terminals.

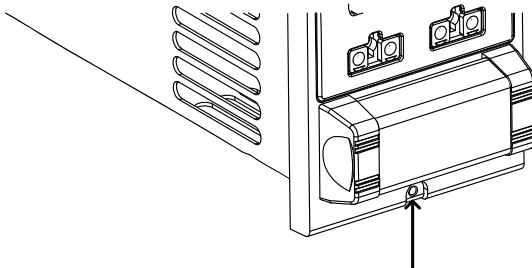

4. Install any additional modules as described above.
5. If there are any slots empty, install the supplied panel cover (part number: PEL-003). The panel cover will improve safety and increase air flow.

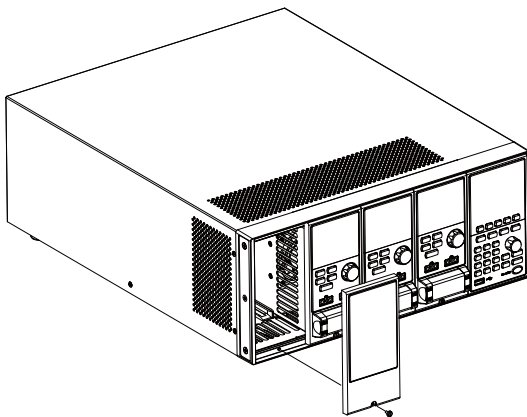

6. Use the supplied screws to fix the panel cover(s) over the load slot.

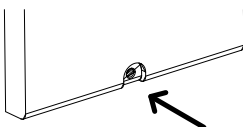

GPIB Installation



WARNING

To avoid static electricity, please use appropriate anti-static work practices.

GPIB Card installation

The PEL-2004B/PEL-2002B has GPIB as an option (part no. PEL-001).

Steps

1. Ensure the mainframe is disconnected from mains power.
2. Remove the screws from the GPIB cover plate and remove the cover plate from the rear panel.
3. Slide the GPIB card into the slot and push gently until the back plate is flush with the rear panel.

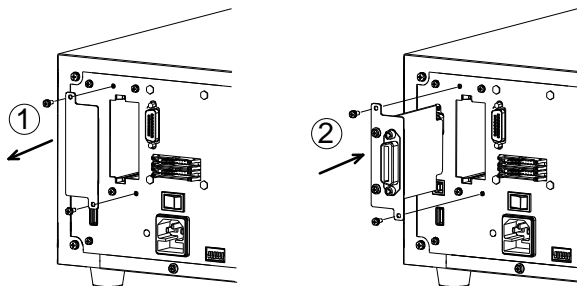

4. Use the screws that were removed from step 1 to secure the GPIB card.

Rack Mount Installation

Background The PEL-2004B can be used in a standard 19" rack mount enclosure with the optional rack mount kit (part no. 11EL-20040201). Each unit requires a rack height of 4U with a 1U space for ventilation top and bottom. The rear of the rack mount enclosure must be free of obstruction to allow heat to dissipate from the mainframe(s).

Steps

1. Screw the rack mount brackets as shown below using the supplied bolts.

PEL-2004B

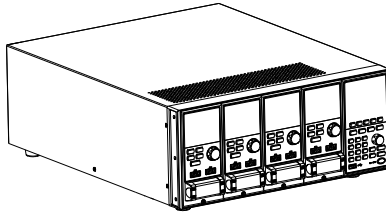

2. Insert into a standard 19" rack enclosure with at least 1U of space top and bottom for ventilation.

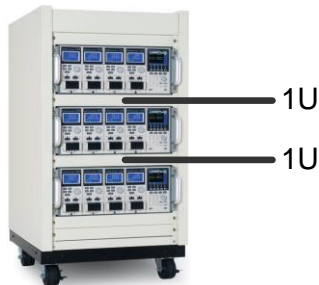

Channel Number

Description

The channel number for a module load is determined by which slot it occupies on the mainframe chassis. There can be 1 or 2 channels per slot, depending on the load module type.

The PEL-2002B has two slots; The PEL-2004B has 4 slots. Channel 1 is the farthest away from the main display panel and channel 8 (PEL-2004B) or channel 4 (PEL-2002B) is the closest to the main display panel.

Below the PEL-2004B has all 4 slots occupied with the PEL-2020B, PEL-2030B, PEL-2040B and 2135MH load modules (LM), respectively. The PEL-2020B & 2225ML have 2 channels per load module, the PEL-2040B & PEL-2041B have only 1. So the channel determination is:

LM1: CH1, CH2; LM2: CH3, CH4; LM3: CH5;
LM4: CH6.

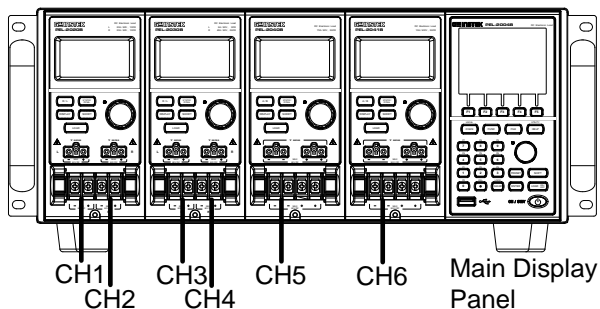

Power Up & Self Test

Panel operation

1. Connect the power cord to the power socket.

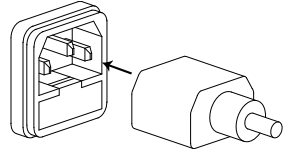

2. Turn the external power switch on.

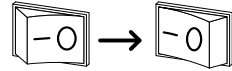

3. Hold the power button on the front panel to turn on the power.



The power button turns green from red (standby).

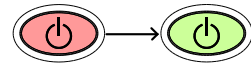

 **WARNING**

Ensure that the power outlet has a ground socket. The power outlet will have a ground connection if it is a 3 socket type.

Upon turning on, the Mainframe will perform a self-test. The self-test checks the System, followed by any attached channels.

 **NOTE**

When the firmware version of the mainframe and the slave are not identical, a message “The firmware will be updated, please access to website www.gwinstek.com to confirm the firmware version.” will appear on the mainframe.

Initial	System	Success
	CH1	Success
	CH2	Success
	CH3	Success
	CH4	Success
	CH5	Success

When the system check happens, the load modules will display each channel as it is checked, then display the current mode.

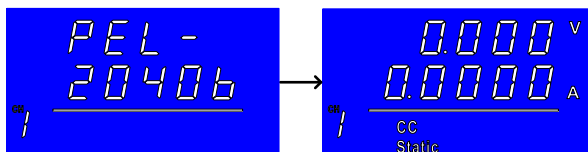

- If any of the System checks fail, please power down the load and reinstall the appropriate load module(s).
- To turn off the load, hold the power button for a few seconds.



The PEL-2000B mainframe will return to standby mode.

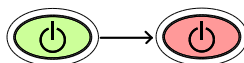

Load Connections

Precautions and Procedures

Introduction	<p data-bbox="380 339 984 438">The PEL-2000B series supports a number of different load configurations for flexible operation.</p> <ul data-bbox="380 462 984 710" style="list-style-type: none"><li data-bbox="380 462 984 502">• Single DUT, single load<li data-bbox="380 510 984 550">• Single DUT, parallel load<li data-bbox="380 558 984 598">• Multiple DUTs, multiple loads<li data-bbox="380 606 984 646">• Multiple DUTs, multiple mainframe loads<li data-bbox="380 654 984 710">• Single DUT, parallel mainframes <p data-bbox="380 726 984 821">The PEL-2000B series also supports a number of different control methods and interfaces. The connections used are described here:</p> <ul data-bbox="380 845 984 981" style="list-style-type: none"><li data-bbox="380 845 984 885">• Frame link<li data-bbox="380 893 984 933">• Channel control<li data-bbox="380 941 984 981">• Go/NoGo
Wire Gauge considerations	<p data-bbox="380 1005 984 1236">Before connecting the PEL-2000B series, wire gauge must be taken into account. Load wires must be large enough to resist overheating when a short-circuit condition occurs as well as maintain a good regulation. The size, polarity and length of a wire are all factors in determining if a wire will withstand short circuiting.</p>

Wire Selection Wires that are selected must be large enough to withstand a short circuit and limit voltage drops to no more than 2V per wire. Use the table below to help make a suitable selection.

AWG	Max Current A(Amp)
24	7.64
22	10.0
20	13.1
18	17.2
16	22.6
14	30.4
12	40.6
10	55.3

Load Line Inductance Considerations When using the PEL-2000B series, voltage drop and voltage generated due to load line inductance and current change must be taken into account. Extreme changes in voltage may exceed the minimum or maximum voltage limits. Exceeding the maximum voltage limit may damage the PEL-2000B series.

To determine the voltage generated, the following equation can be used.

$$E = L \times (\Delta I / \Delta T)$$

E= voltage generated

L=load line inductance

ΔI = change of current (A)

ΔT = time (us)

Load line inductance (L) can be approximated as 1uH per 1 meter of wire. ($\Delta I / \Delta T$) is the slew rate in A/us.

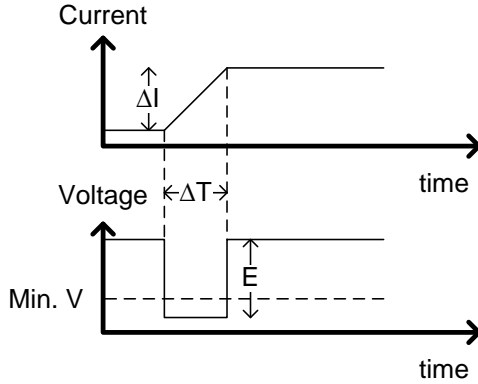

The diagram above shows how changes in current can affect voltage.

Limiting Load line inductance Load line inductance can be reduced by ensuring load wires are as short as possible and by twisting positive and negative load wires together. Current change can be limited by limiting the slew rate when switching.

“Twisted pair” will be shown on any connection diagram where the load wires should be twisted together.

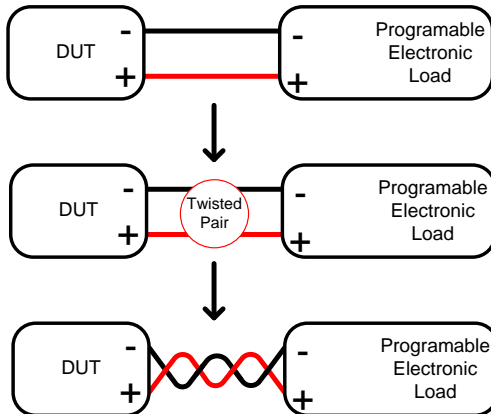

Load module considerations

The PEL-2000B series supports single and dual channel load modules.

Single channel load modules have one bank of negative terminals and one bank of positive terminals. Each terminal pair has a 40A capacity. For higher loads, each terminal can be wired in parallel to increase capacity.

Dual channel load modules have one bank of positive and negative terminals for each channel.

Single Channel Load Module

Dual Channel Load Module

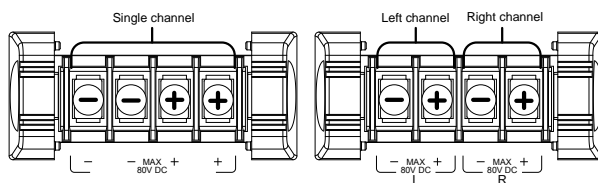

Connection

Follow the procedure below for all load connections.



CAUTION

Ensure that power is off from the load and the DUT before making any connections.

Steps

1. Carefully lift the terminal covers.
2. Connect the positive (+) terminal on the load module to the high potential output of the DUT.
3. Connect the negative (-) load terminal to the low potential output of the DUT.

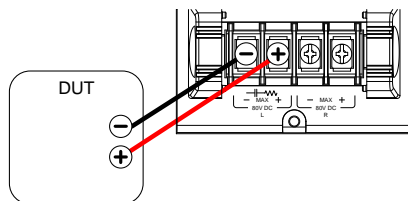

4. Close the terminal cover securely. Ensure the wires are secured properly and that the wires are not exposed when the cover is in place.

 **WARNING**

Ensure that the wires are tied or twisted together to prevent noise and inductance.

 **CAUTION**

Ensure the polarity is correct before proceeding with any connections. Using the wrong polarity could result in reverse voltage damage.

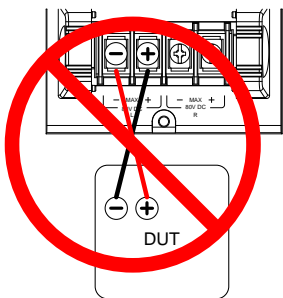

Ensure the input voltage doesn't exceed specifications. Exceeding the voltage specifications could result in damage to the instrument.

Terminal description and screw type

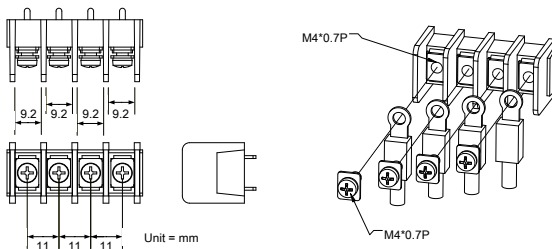

Remote (Sense) Connection

Background The electronic load modules have two voltage sense contacts: Vsense +, Vsense -. Voltage sense can be used to help compensate for long cable length. The longer the cable, the higher the potential resistance and inductance, therefore a short cable is best. Twisting the cable can help reduce induced inductance and using the Vsense terminals compensates the voltage drop seen across the load leads, especially leads with higher resistance. This is useful when used in CV, CR or CP mode.



WARNING

Vsense + must have a higher potential than Vsense -.

Connection The diagram below shows how a DUT can be connected using voltage sense. Note that the sense wires are also twisted pairs.

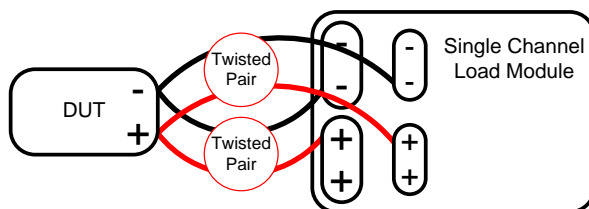

Note

The wire gauge for the sense wires should be no smaller than 16 gauge.

Input The voltage sense terminals must use a wire gauge of 16 to 14 (Diameter 1.29mm ~ 1.63mm).

Remote Sense Terminal connection The voltage sense terminals use a screw-less clamp connector. The clamp must be opened prior to inserting a wire. Use a small screwdriver to push the clamp release mechanism. Insert both wires then release the clamp mechanism.

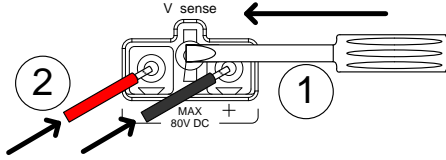

Single Load Connections

Dual Channel Load Module Connection

A dual channel load module can be used to sink two loads concurrently.

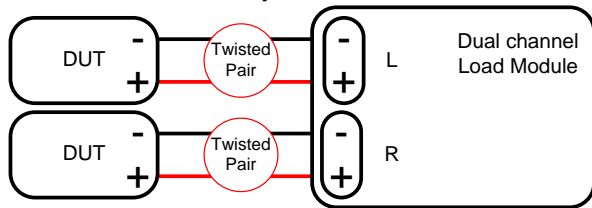

Single Channel Load Module Connection

On a single channel load module, the left terminals are both negative (-), whilst the right terminals are both positive (+). Note this also applies to the voltage sense terminals.

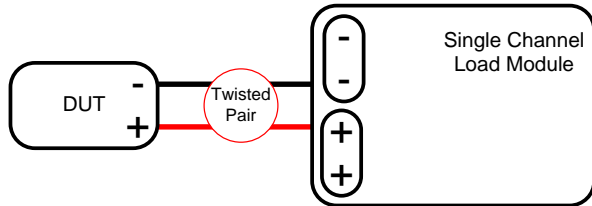

For loads exceeding 40A, both positive and both negative terminals must be used in parallel.

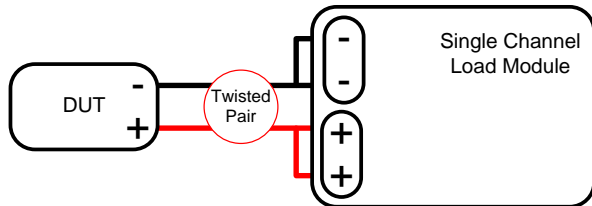

DC Connection For purely DC operation, a resistor and capacitor can be connected in parallel to the electronic load to reduce oscillation. The capacitor and resistor values are dependent on the load settings. Ensure the capacitor ripple current is within allowable limits.

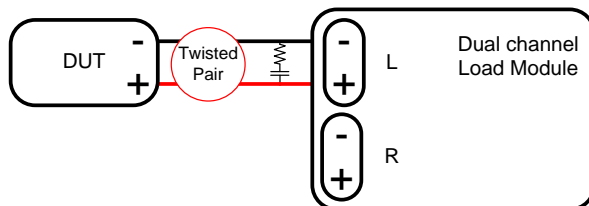

Low Voltage Connection Using the load with low voltage loads is generally limited to over 1 volt (load module dependent). In order to support low voltage loads, an auxiliary power supply is needed to boost the voltage to a range suitable for the load.

Precautions:

- Take into account the combined power of the load and auxiliary power supply.
- Make sure the auxiliary power supply is able to provide enough current.
- Take into account any noise or irregularities from the auxiliary supply.

The diagram below shows a typical connection.

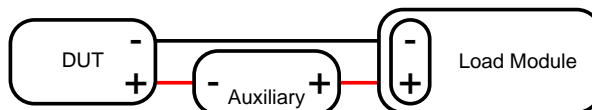

WARNING

Using an auxiliary power supply may induce reverse current. The PEL-2000B series has reverse voltage protection. For details see the protection section on page 81.

Parallel Load Connections

Parallel load modules

When the power output of a DUT exceeds the power rating of a channel or load module, the channel terminals, load modules or mainframes can be used in parallel to dissipate more power when used in CC or CR mode. Each channel will sink the amount of current specified. The total power sunk is the sum of all channels/modules. The amount of power can vary from each channel. For example if CH1 is 25A and CH2 is 20A, then the total current sunk is 45A. Parallel loads are supported for both static and dynamic loads (see page 79 for a description on parallel dynamic loading). Note that the same modules must be used when operating the parallel.

The PEL-2000B series also features a dedicated parallel configuration setting known as Group Unit. When Group Unit is turned on, load modules of the same type and rating to be used in parallel for CC and CR mode. See page 70 and 194 for more information.

Parallel load

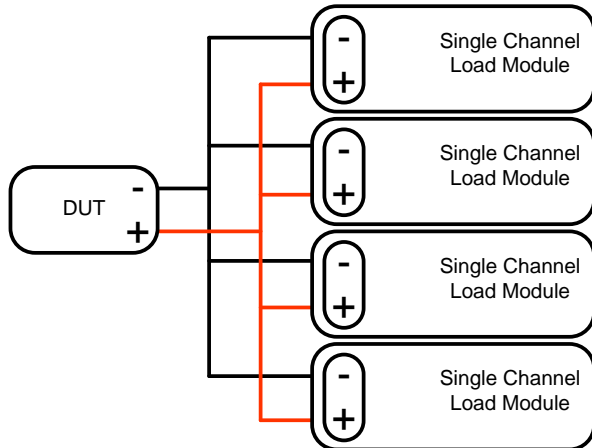



Note

Please note that the same load modules must be used in parallel.

Parallel loads using frame link connections

The PEL-2000B series mainframes can also be connected in parallel. Please note, when using a frame link connection there is a delay between the master and the slave. Please see page 53 for details.

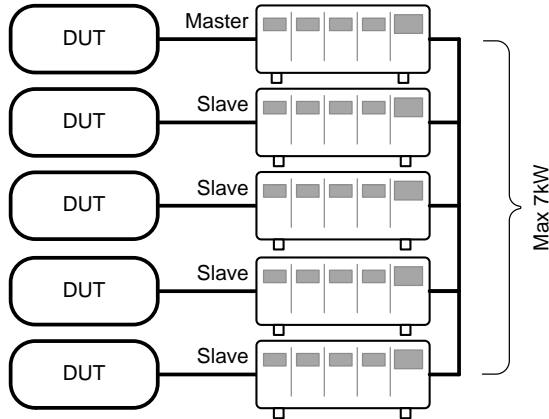

Multi-output power supply load

The PEL-2000B series is also able to sink a number of loads concurrently from multiple DUTs or sink a number of loads from the same DUT (i.e. multiple output power supply).

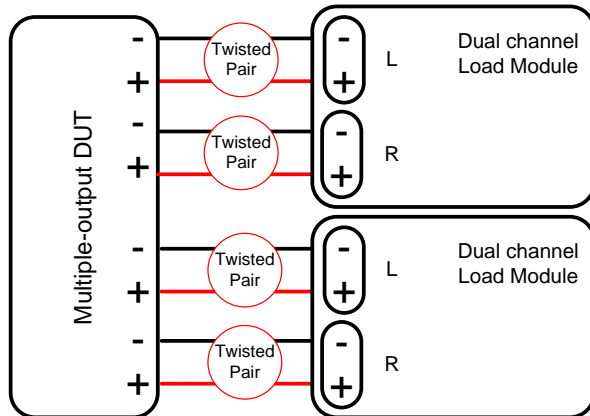

Frame Link Connection

Background

Frame link control involves connecting multiple mainframes using the frame link connections. Up to 4 slave mainframes can be connected to the master mainframe. The first mainframe (master) can be used to control the other slave frames. There is a delay time of $2\mu\text{s}$ between the master and first slave mainframe, and $4\mu\text{s}$, $6\mu\text{s}$, and $8\mu\text{s}$ to the second, third, and fourth slave mainframes, respectively. The connectors used are standard MIL 20-pin connectors. For pin arrangement, see page 272. The frame link cable (part no. GTL-249) is an optional accessory, see page 16 for details.

Frame Link Connection

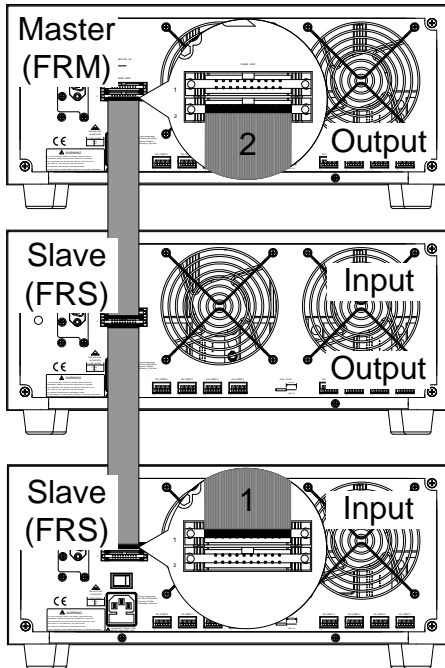

The first mainframe that is connected is the master frame; any additional frames are slave units. The ribbon cable connects to the master from connector 2, and the slave from connector 1. Each successive slave unit is connected in a cascading manner the same way.

Ensure the Mainframes are turned off before connecting the ribbon cables. Push the cable into the frame link connector. Ensure the arrows line up. The latches will close when the connection is complete. To remove, pull the latches out and connector will come out.

Insertion

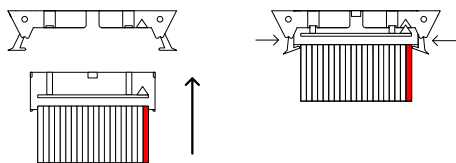

Removal

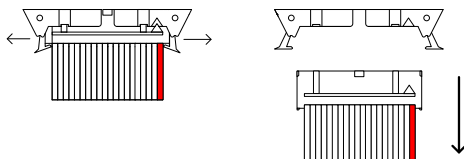

WARNING

Ensure all the mainframes are off and disconnected from mains power before connecting.

Channel Control Connection

Background

The Channel Control connectors are located on the rear panel of each mainframe. There are two channel control connectors for each load slot, one for each channel, if applicable. The channel control connector is used to externally:

- Turn on/off loads.
- Supply a reference voltage.
- Monitor the load input.

For further details on channel control and the interface see pages 86, 270.

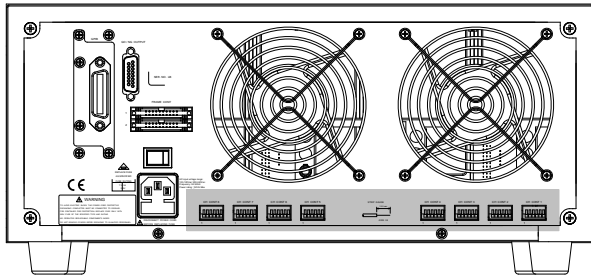

The Channel Control input/output pin layout is shown below.

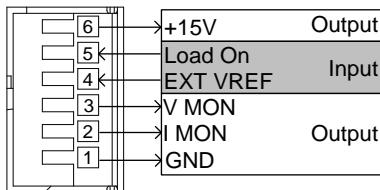

External Voltage Connection

The external voltage reference input must be between 0~10V.

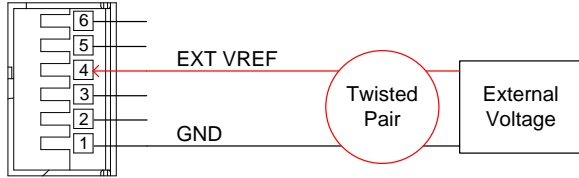

! WARNING

Ensure the external voltage reference is stable and has low noise. The External Voltage should be no more than 10V.

The input impedance of the EXT VREF pin is 500kΩ.

No more than 12 volts may be used as an external voltage. More than 12 volts may damage the load.

Load on connection

To turn a load on, an active low voltage (0-1V) must be applied across Load On (pin 5) and GND (pin 1), similarly an active high voltage (2.4-5V) must be applied to turn a load off. The Load On input must be TTL.

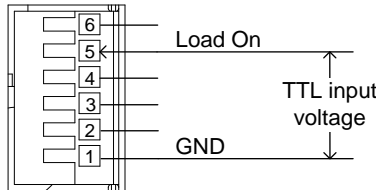

Voltage and Current Monitor Output

The Voltage Monitor Output (VMON) and Current Monitor Output (IMON) output the load input voltage and load input current as a percentage of rating current/voltage. Where 0 volts = 0% rating and 10 volts = 100% load input rating voltage or current.

The voltage monitor output is across pins 1 & 3, and the current monitor output is across pins 1 & 2. Pin 6 outputs a +15V reference voltage.

Below shows the pin configuration of the voltage and current monitor outputs.

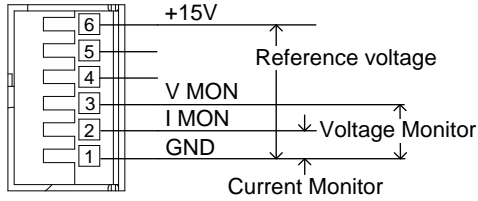

Connector Connection

The channel control connector is a screw less clamp connector. The internal clamp mechanism must be opened before a wire can be inserted. To open the internal clamp, push the button above the wire socket, to close, release the button. Ensure at least 10mm is stripped from the wire. The diagram below shows the wire insertion procedure.

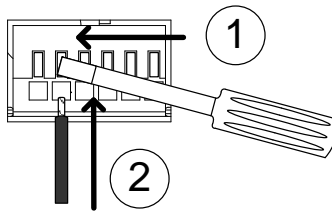

! WARNING

All connections to the channel control connector must use a 24 AWG wire gauge.

The output impedance of the V MON and I MON pins is 10kΩ.

The “+15V on pin6” used by customer application < 100mA Hold on 200mA.

Go/NoGo Connection

Background

The Go/NoGo port is a 15 socket port. Each channel has a dedicated line for a Go/NoGo output. The ports are open-collector with active high (30V) indicating a pass and active low (1.1V) as fail (an alarm). The Go/NoGo terminal is a DB-15 female.

For more details on the Go/NoGo interface see page 275.

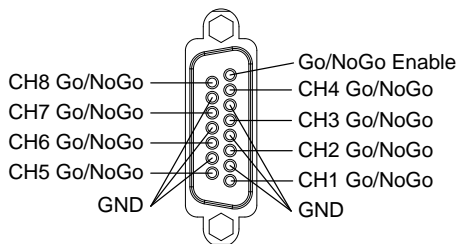

PERATING DESCRIPTION

Operating Mode Description	60
Constant Current Mode	60
Constant Resistance Mode	63
Constant Voltage Mode	65
Constant Power Mode	68
Group Unit Mode	70
Run Program	72
Sequence	75
OCP Test Automation	79
Parallel Dynamic Loading	80
Configurations Description	81
Protection Modes	81
Operating Configurations	83
Channel Control	87
Interface and System	90
Interface	90
File System	90
File Format	95

Operating Mode Description

There are four basic operating modes: constant current (CC), Constant Resistance (CR), Constant Voltage (CV/CV+CC) and Constant Power (CP). All channels operate using any of the modes. Each mode has a number of configurable options including slew rate, levels, protection modes, Go/NoGo and extensive save options.

Constant Current Mode

Background In Constant Current Mode the load units will sink the amount of current programmed. Regardless of the voltage, the current will stay the same. There are two ranges in CC mode: High and Low. There are two main modes in CC mode: Static and Dynamic. Static mode can be used for stability tests and dynamic mode can be used to test transient load conditions.

Go/NoGo is supported for both High and Low range as well as Static and Dynamic mode.

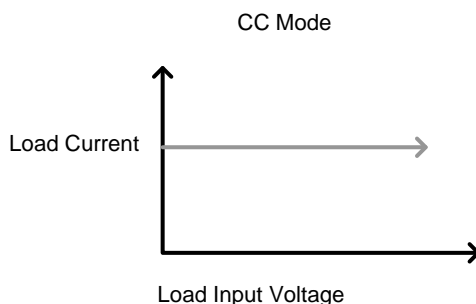

Range There are two selectable ranges for constant current mode: high and low range.

Low range has a higher resolution, but a lower range. If the current exceeds the Low Range, High range must be used.

Static Functions Static mode tests the stability of the voltage output from a power source. Single channel load modules can have two 2 current levels A (A Value) & B (B Value). A & B have the same range. Pressing the A/B key on the module load will cycle through the A and B states. Alternatively, the mainframe can select A or B Value.

Dual channel load modules only have one current level (A Value) per channel in static mode.

Static Mode:
Single Channel
Load module.

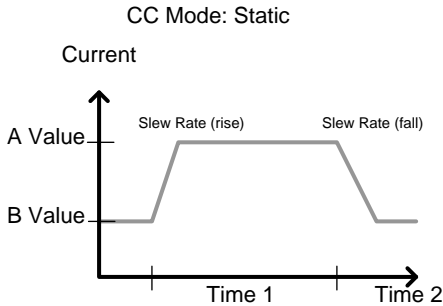

Dynamic Functions

Dynamic load functions allow you to set load levels (Level1, Level2), load time (Timer1, Timer2), and the slew rate (rising, falling). Depending on the settings, the load will switch automatically between levels 1 and 2.

Dynamic loading can be used for charge discharge cycle testing etc.

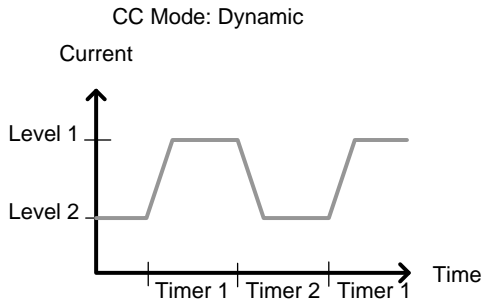

Slew rate

The slew rate is the rate at which the current will increase to a set level. There are two slew rates: rising slew rate & falling slew rate. In CC mode the slew rate is defined as A/uS.

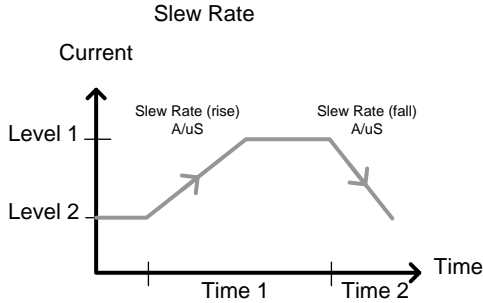

As can be seen above, the rising and falling slew rate need not be the same.

Go/NoGo

Using Go/NoGo, the Center, High and Low voltage limits can be set for both Static and Dynamic modes. A delay time of up to 1 second can also be set.

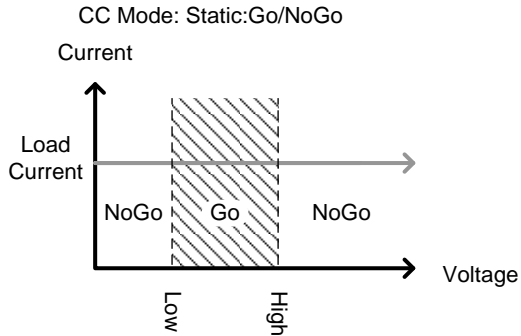

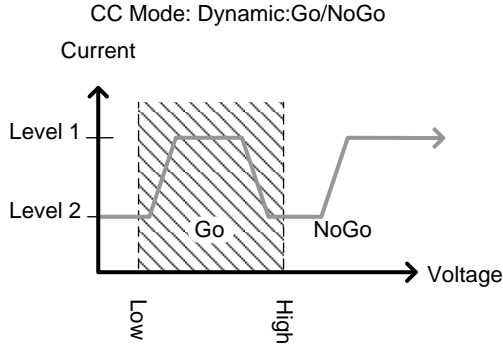

GO is specified as between the Low and High Go/NoGo limits. NoGo is specified as outside the Go/NoGo limits.

Constant Resistance Mode

Background

In Constant Resistance Mode the load units will linearly sink current and voltage to match a set resistance. CR mode has two different values (single load modules), two different ranges and rising and falling slew rates. Like CC mode, Constant resistance mode supports both dynamic and static loads. As with the other modes, Go/NoGo is supported.

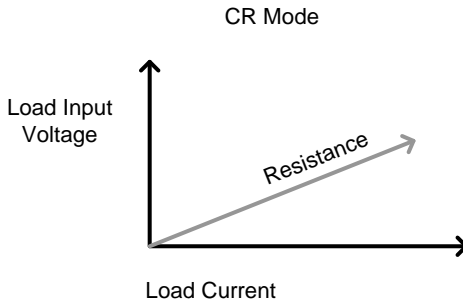

Resistance Range There are two ranges: High and Low. The Low range is used for low voltage ranges, whilst the High range uses high voltage ranges. The current range always remains in High range, regardless of the selected resistance range.

Static Functions A/B range For static mode, single channel load modules have two resistance levels. A & B have the same range. The A/B key can be used to switch between these resistance levels. Dual channel load modules only have one resistance level, A Value.

Single Load Module

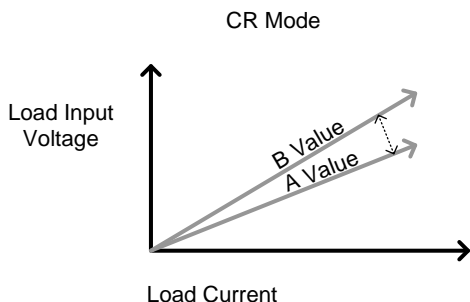

Dynamic Functions CR mode supports Dynamic loading. Dynamic load has two resistance levels (Level 1&2), and two timers (Timer 1&2) to switch between the resistance levels. Rising and falling slew rates can be set to determine the speed at which the load switches between load levels.

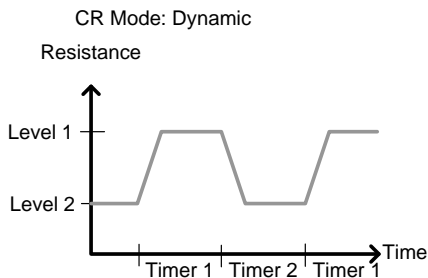

Slew Rate The rising and falling slew rate (A/uS) determines the speed at which the load levels change from A to B Value (Static mode) or from Level1 to 2 (Dynamic mode) and vice versa.

Go/NoGo Go/NoGo is also supported. Center, High and Low limits can be set as either percentages or voltage values. A delay time of up to 1 second can also be set.

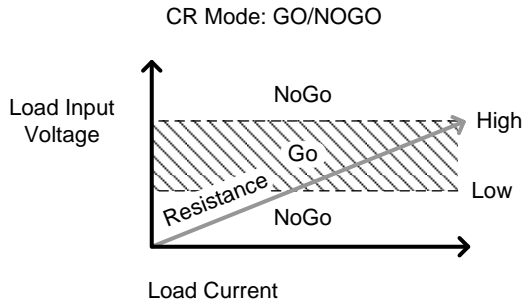

Constant Voltage Mode

Background In Constant Voltage Mode the load units will sink current whilst keeping the voltage constant.

Single channel load modules support 2 values (A Value, B Value) and have an adjustable cut-off current limit. Dual channel load modules only have A value.

Response speed can also be set to fast (Fast) or slow (Slow). The response speed relates to the slew rate of the current response.

Go/NoGo functionality is also supported either as a percentage or as a current value.

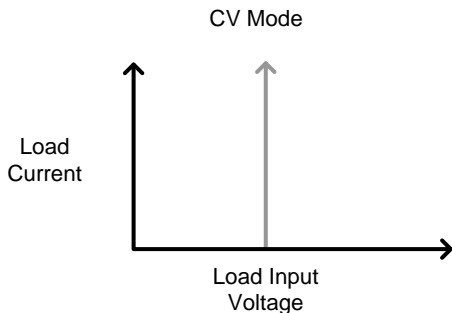

Voltage levels Two voltage levels can be set: A & B (single channel load module).

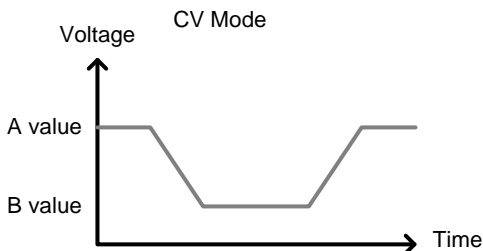

CV + CC When using CV mode, a current limit can be set for CV + CC mode.

When the voltage input is greater than A Value (load voltage) then the channel will operate in CV mode if the input current is less than the current limit. When the input current exceeds the current limit, the channel will operate in CC mode.

When the voltage input is less than A Value (load voltage) current stops flowing.

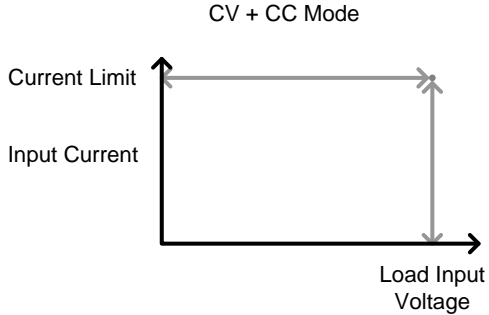

Response Speed Response speed can be set to fast, slow1, slow2 or slow3. Fast response and slow1 (slow2/slow3) response are determined by the load module specifications. Slow response speeds are suitable for large loads as quick current changes will induce induction which can cause large voltage drops. The PEL-2000B series will try to rectify any voltage drops. However if voltage drops are too large, they may cause the load to go into oscillation. Large voltage drops caused by line voltage induction may damage the machine.

Go/NoGo Go/NoGo testing can be with either current (Ampere) values (High, Low) or percentage values (Center, High %, Low %). A delay time of up to 1 second can also be set.

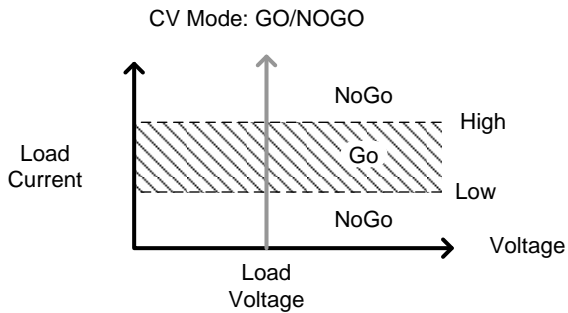

Constant Power Mode

Background

In Constant Power Mode the load units will ensure a constant power load for the power supply.

Single channel load modules support 2 values (A Value, B Value) and have an adjustable cut-off current limit. Dual channel load modules only have A value.

Constant power mode can operate in high or low range.

Go/NoGo functionality is also supported either as a percentage or as a current value.

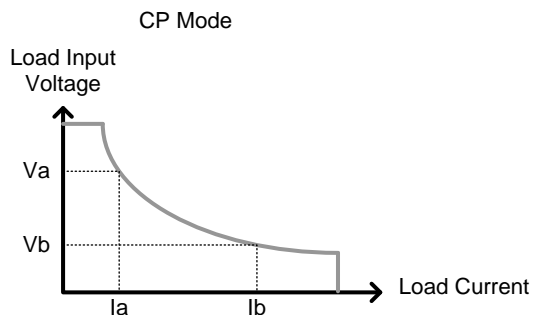

Power levels

Two power levels can be set: A & B (single channel load module).

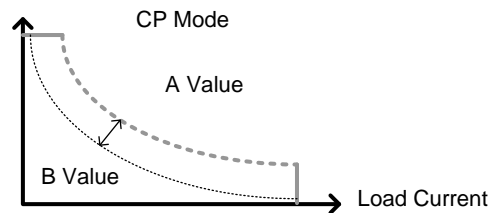

CP + CC When using CP mode, a current limit can be set for CP + CC mode.
 When the constant power current is less than current limit, the channel will operate in CP mode.
 When the constant power current exceeds the current limit, the channel will operate in CC mode.

High/Low Range There are two ranges: High and Low. The Low range is used for low power ranges, whilst the High range uses high power ranges.

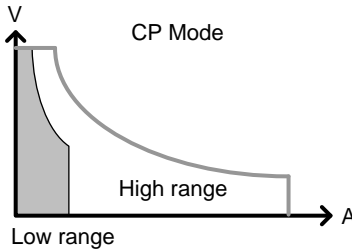

Go/NoGo Go/NoGo testing can set High and Low Current limits as a Value (in Amperes) or as a percentage. A delay time of up to 1 second can also be set.

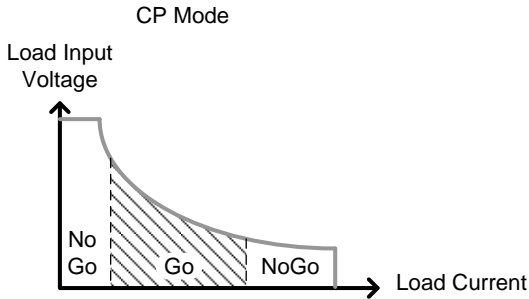

Group Unit Mode

Background The Group Unit menu allows load modules of the same type and rating to be configured as a single unit when used in parallel. This saves the hassle of configuring each channel individually.

Group Unit is only supported under CC and CR mode.

Group Unit has three configuration settings: Total Unit, Group Mode and Display Mode.

Total Unit This configuration setting sets the number units that are to be used in parallel and enables or disables the Total Unit mode.

Group Mode The Group Mode setting determines how the Current Levels/Resistance Values are set when used in parallel. There are two settings: Para and Sync.

The Para setting allows the all the parallelized load modules to be operated as a single large load module.

Sync mode allows the settings of a single unit to be synchronized across all the other parallelized load modules.

CC Example Consider 3 load modules set to CC mode in Parallel.

In CC mode the total current for all units is the sum of each unit.

$$\text{Total } I = I_1 + I_2 + I_n$$

For example, to set a total load current of 90A, the Current Level setting in Para mode would be 90A, whilst it would be 30A in Sync mode.

Para mode

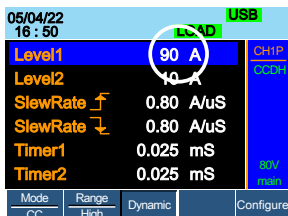

Sync Mode

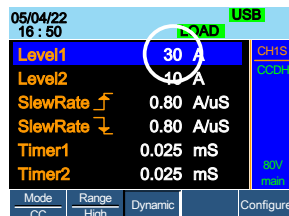

CR Example

When used in CR mode, the equation for equivalent resistance for all the parallel loads is:

$$\frac{1}{R_{e q}} = \frac{1}{R_1} + \frac{1}{R_2} + \frac{1}{R_n}$$

For example, if 2 load modules have a set resistance of 100Ω each, the equivalent resistance of the load modules would be 50Ω. The Level setting in Para mode would be 50Ω and 100Ω in Sync mode.

Para mode

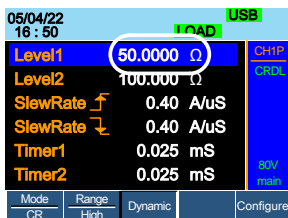

Sync Mode

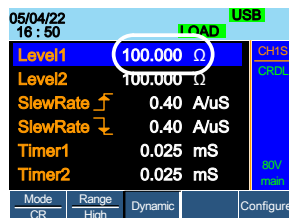

Display Mode

Display mode determines what units are displayed on the local load modules: V/I, V/W, I/W, S. The displayed units can only be controlled through this menu.

Run Program

Background The Program function on the PEL-2000B series supports a total of 12 different programs at any one time with 10 sequences to each program. Up to 12 programs can be chained together. The Program function is able to create a number of Go/NoGo tests.

Run Program is not supported in Group Mode (page 70).

Program Sequence A program sequence is simply a single load test. A program is a battery of each of these tests run in succession. Each sequence loads the settings for each channel from Memory Data (Memory MXXX). The Memory Data stores settings such as the operating mode and range for each channel. Each sequence loads all channels at the same time, unless programmed otherwise. Sequences for each channel run synchronously.

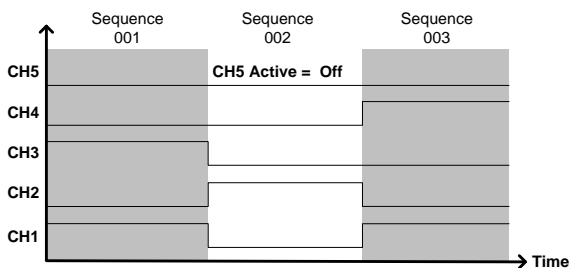

Each Sequence has a number of configuration options that apply to all the channels equally.

Sequence Item	Description
Memory	Loads the channel settings for each load module Range: M001~M120

Run	<p>Sets the running configuration for the current sequence. The sequence can be skipped, run or run manually only.</p> <p>Range: Auto Skip Manual</p>
On-Time	<p>Sets the Sequence Run On-Time</p> <p>Range: 0.1 ~ 60.0s</p>
Off-Time	<p>Sets the Sequence Off-Time</p> <p>Range: Off 0.1 ~ 60.0s</p>
Short-time	<p>Sets whether the Short-Time for the sequence.</p> <p>Range: Off 0.1s ~ On-time</p>
P/F-Time	<p>Sets the Pass/Fail time for the sequence</p> <p>Range: Off 0.1 ~ (On-Time+Off-Time)-0.1s</p>
Short Channel	<p>Selects which channel will be shorted during the sequence</p> <p>Range: CH1 ~ CH8</p>

Program

Sequences are run sequentially to create a Program. There are 10 Sequences in each Program.

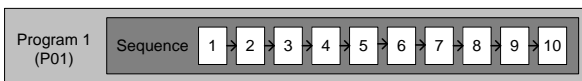

If less than 10 Sequences are desired for a Program, any additional Sequences can be skipped (not run).

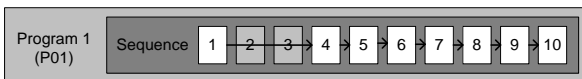

Sequence 2 & 3 are skipped.

Program Chain Any of the 12 programs can be chained together to create a Program Chain. Unlike Program Sequences, Program Chains need not be run sequentially in numerical order. Any program can be chained to any program. It is possible to chain programs into an infinite loop to continue a program indefinitely.



Above, a program chain running sequences out-of-order.

Go/NoGo Results If Go/NoGo limits have been configured, the Pass/Fail results for each channel will be displayed for all the sequences and programs.

The screenshot shows a device display with the following information:

- Top status bar: 05/04/22, 16 : 50, and a green **PROG** indicator.
- Section header: **Channel** in green.
- Table of results:

Program no.	P	S	1	2
Sequence no.	1	1	G	N
Channel	1	2	G	N
	1	3	G	N
	1	4	G	G

To the right of the table, the text "Go/NoGo" is displayed. At the bottom right of the screen is an "Exit" button.

Sequence

Background The Sequence function is used to create high resolution load simulations. Each Sequence can be configured to create a unique load profile to accurately simulate loads in real time. Sequences are only applicable for CC (Static) and CR (Static) modes.



Note

Sequences are not to be confused with the sequences used to create a program. They are not the same and cannot be used interchangeably. Sequences (SEQ memory) cannot be used in Programs and Programs cannot load Sequences.

Load Profiling The Sequence function is able to simulate a load to a high resolution. Each channel is able to change its load sink within 25 μ s ~ 60000s per point independently. When used in parallel, multiple loads can be set concurrently to simulate the loads placed on multiple output power sources.

The diagram below shows the load profile of a DUT at start-up.

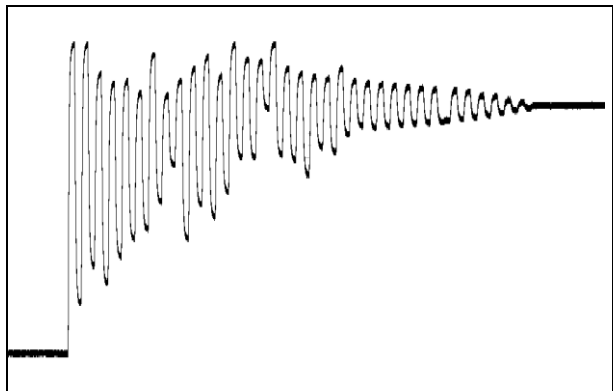

Points

Up to 120 points can be used with each Sequence. Each point can have a different duration, slew rate and value.

A new point can be inserted or deleted at any stage of a Sequence. Any new points that are inserted will have a value averaged from its neighbors as default.

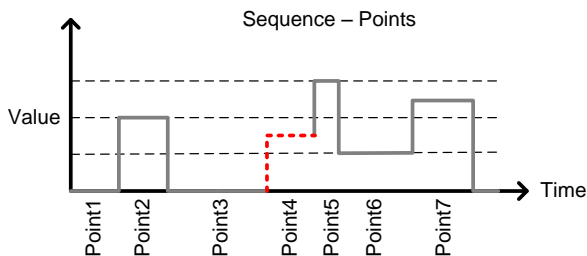

A new point is inserted after Point 3.

Loop

Sequences can be programmed to loop a number of times starting from any point in the sequence.

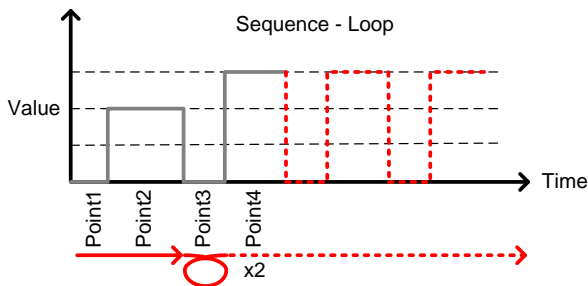

From Point3 the sequence is looped two times.

On End Of Seq. function If more than one Sequence is programmed on the mainframe, the On End Of Seq. function will hold the load current (of the selected sequence) to a designated value until all the other sequences have finished running.

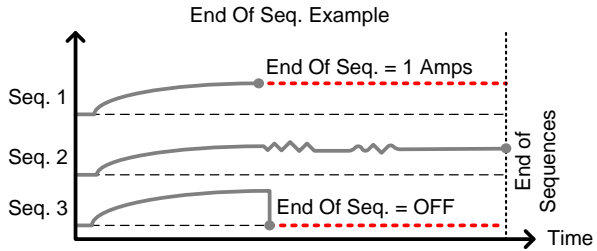

In the example above, Seq. 1 will hold the load current at 1A at the end of its sequence until the last sequence has finished. Seq. 2 is the longest sequence, and as such the End Of Seq. setting is not applicable. Seq. 3 is turned off after its sequence has finished (0 amps).

Trig Out The Trigger Out function allows a trigger sequence signal to be output from a channel via PIN 4 on Frame Link connector 1 when using Sequences. The Trig Out function is used from the Channel Duration menu.

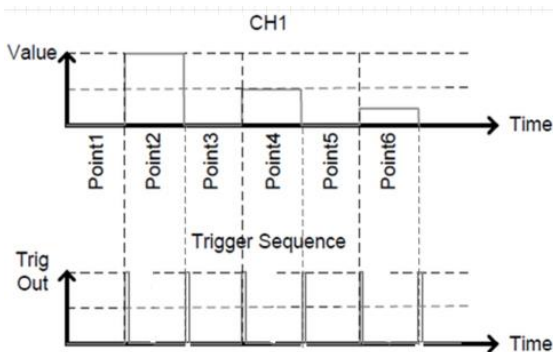

As can be seen above, a trigger sequence signal is output for every rising edge point.

Trig In The Trigger In setting allows a sequence to start after a trigger (Trig Out) has been received via the frame link connector. The Trig In setting is used for frame linked mainframes.

Channel Duration Time Setting The Channel Duration Time Setting feature allows the point time duration of one Sequence to be imported by another Sequence. If the receiving sequence doesn't have enough points, more will be created (without values).

For example, the sequences for CH1 and CH2 are shown below. CH1 has a total of 6 points with long durations, whilst CH2 has only 2 points, looped 5 times. The points from CH2 are also significantly shorter in duration.

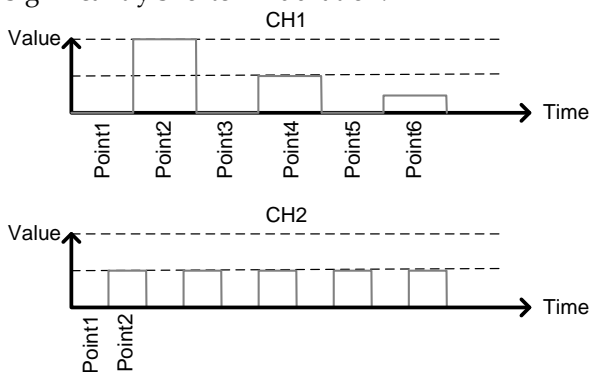

Below shows the resulting sequence when CH1 imports CH2. CH1 imports the duration time settings and number of points from CH2, but not the value data.

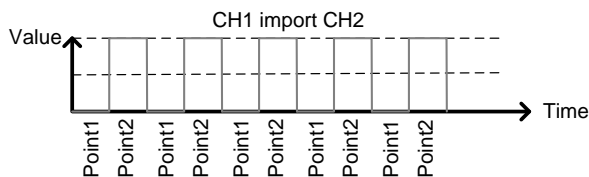

OCP Test Automation

Background The OCP test function creates an automatic test to test the over current protection of power supply products. See page 166 for operation details.

This test will test to see when the over current protection of a power supply is tripped and return the measurements for the voltage and current when the over current protection was tripped. The PEL-2000B series also has a user-defined OCP setting in the event that the power supply OCP fails.

The diagram below shows an example of the OCP Test Automation function.

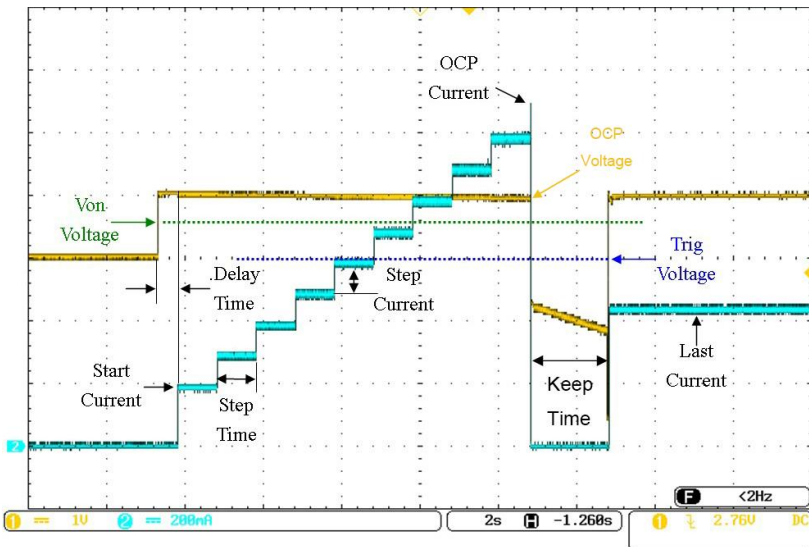

Parallel Dynamic Loading

Background

The PEL-2000B series of DC electronic loads support parallel dynamic loading. This simply means that when the load modules of a mainframe are connected in parallel and set to dynamic mode, they can perform dynamic tests synchronously following the same clock. Under dynamic mode, load current or resistance is pulsed between two preset levels. When used in parallel, higher powered outputs can be tested. This ability gives the PEL-2000B series the flexibility to perform dynamic tests over a wide range of power outputs.

For connection details see the Parallel Load Connections section on page 51.

The diagram below shows how two load modules are able to sink a higher load when used in parallel under dynamic mode.

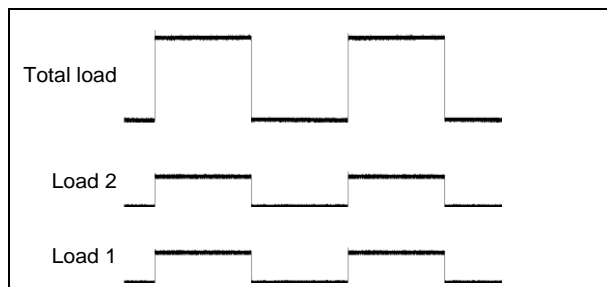

Note

The same type of load modules must be used operated in parallel.

Configurations Description

There are a number of different configurations for the PEL-2000B series including protection modes, operating configurations, and file system configurations. The Configuration Description section describes what the different configurations are used for and how they can be relevant to different operations.

Protection Modes

Background The PEL-2000B series include a number of protection modes: Over Current Protection, Over Voltage Protection, Over Power Protection, Under voltage protection and Constant Power Protection.

The protection modes are useful to protect both the load modules and the DUT(s). A buzzer can be set to notify when a protection setting has been tripped. When a protection feature is activated and has been tripped then the load unit will display an alarm. The Mainframe will also display an alarm. When an alarm has been tripped the load will stop sinking current/voltage. There are three Over load protection settings: ON, OFF and Clear.

05/04/22 16 : 50		Alarm		
OCP Level		5.075 A	CH1 CCDH	
OCP Setting		OFF		
OVP Level		81.6 V	80V Conf	
OVP Setting		ON		
OPP Level		29.75 W		
OPP Setting		OFF		
Protection	Other	Go-NoGo		Previous Menu

Over Current Protection

When a load unit is operating in CR, CV or CP mode, the unit may need over current protection to prevent excessive current being set. Over current protection stops the load from sinking more current than its recommended limit which can cause damage to the unit.

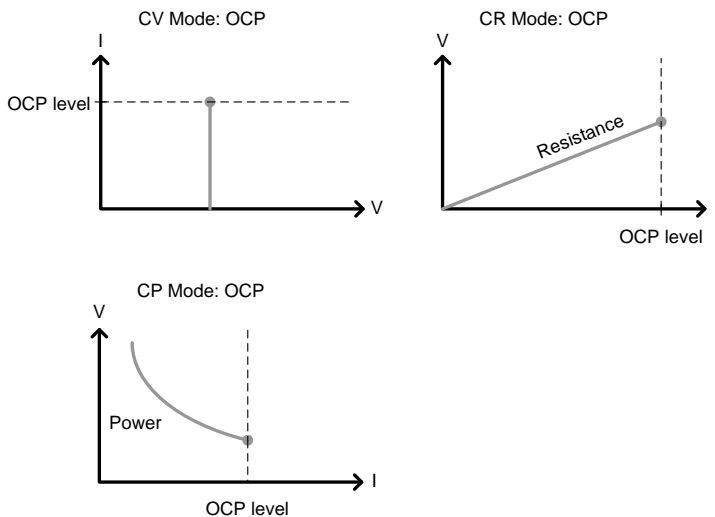

Over Voltage Protection

Over voltage protection is used to limit the amount of voltage sunk. If the OVP trips, the PEL-2000B series load will stop sinking voltage.

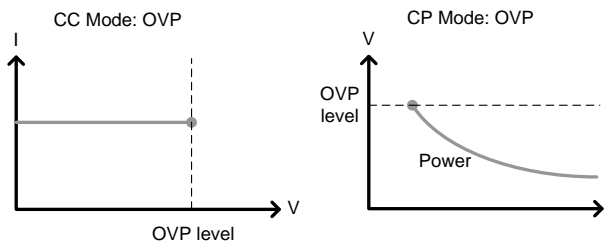

Over Power Protection

Over power protection is used to limit the amount of power sunk. When OPP is tripped power will cease to be sunk.

Reverse voltage Protection	Reverse voltage protection prevents reverse voltage damage to the PEL-2000B series up to the specified rating. When Reverse voltage protection has been tripped an alarm tone will sound until the reverse voltage is removed.
Under voltage Protection	Under voltage protection will turn off the load when the voltage drops below a set limit. UVP does not work when set to "CH CONT: External".
Constant Power Protection	Constant power protection will prevent excessive power draw.

Operating Configurations

Background	<p>There are number of operating configuration settings. Configuration settings are for the following:</p> <p>CC Vrange, Von Voltage, Von Latch, CH Cont, Independent, load D-Time, Response settings, Step resolution settings, Short settings.</p>
CC Vrange	CC Vrange (page 177) is used to set the voltage range as High or Low for CC mode. CC voltage range is dependent on the load module specifications.
Von Voltage	<p>Von Voltage is the voltage limit at which the load will start to sink current. There are two operation modes for Von Voltage: Von latched: ON and Von latched: OFF.</p> <p>Latched: ON will sink current when Von has been tripped, and will continue to sink current even if the voltage drops below the Von Voltage.</p> <p>Von Latched: OFF will sink current when Von has been tripped, but will stop sinking current when the voltage drops below the Von Voltage setting.</p>

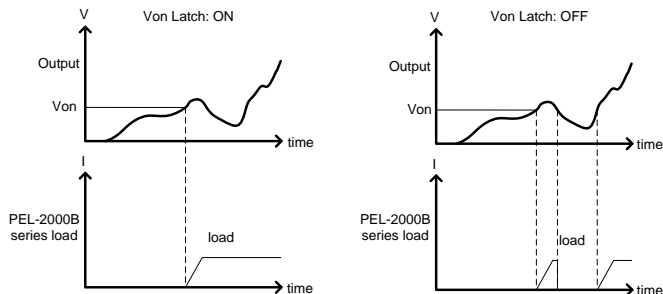

As can be seen in the diagram below, when Von-Latch is set to off, the load module will start to sink current when the Von-voltage limit has been tripped. It will stop sinking current when the output drops below the Von voltage limit.

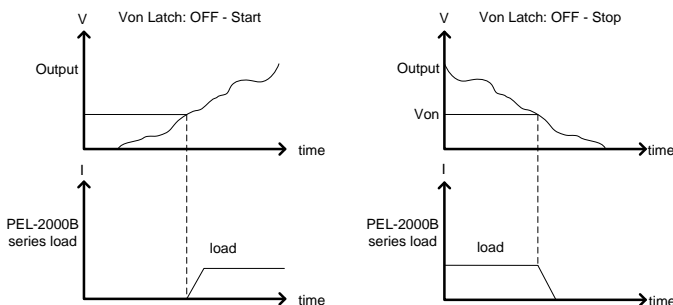

CH CONT

Channel Control. When Channel control is activated (External) it can be used to monitor the voltage and current output of the load as well as turn loads on or off remotely from the Channel Control (CH CONT) connectors located on the rear panel.

For more information about channel control, see external voltage control on page 86.

Independent

The Independent setting will allow the load modules to be controlled independently from the mainframe.

- Load D-Time** Load Delay time is used to delay activating a load (up to 10 seconds) after the load key has been pressed. However the Load D-Time setting will only work for loads that are initiated manually or when the PEL-2000B series mainframe is configured to Auto load (page 200) at run time.
- Response** The Response setting sets the bandwidth of the load to 200Hz (normal) or 20kHz (fast).

If the DUT voltage range is below 1V, set the normal bandwidth to 200Hz, and set the fast bandwidth to 20kHz. If the DUT voltage range is above 1V, set the normal or fast bandwidth to 20kHz.

The Response setting is particularly important for limiting startup current.
- Step Resolution** The current, resistance, voltage and power setting can have the step resolution configured for each channel. The step resolution refers to the step resolution of the *coarse adjustment* of these settings. The *fine adjustment* cannot be configured, see page 187 for details.

For example if the step resolution for CCH (CC high range) is .5 A, then the resolution can be incremented in .5A steps;

8.0←→8.5←→9.0←→9.5

The step resolution parameters apply to the following:

CCH Step – CC high range

CCL Step – CC low range

CRH Step – CR high range

CRL Step – CR low range

CVH Step – CV high range

CVL Step – CV low range

CPH Step - CP high range

CPL Step - CP low range

Step Resolution Range The step resolution range is dependent on the load module and the range:

Max resolution: Module dependent, see page 187

Min resolution: Module dependent, see page 187

Short Key When short mode is on, the load unit can simulate a short circuit.

Shorting can be individually set for each channel when programming sequences.

To initiate a short circuit manually, the short key is used. It can be used at any time during an operation. It will not affect the settings. After a short circuit has finished, the load unit will resume the previous operation.

The short function can be set ON or OFF. When setting to ON, the short key is enabled. When setting to OFF, the short key is disabled.

The short key can be set to toggle or hold. When pressed in toggle mode, shorts are toggled on and off. When pressed in hold mode, the key needs to be held to short the load.

The Short Safety can be used to set the short operation mode. When setting to ON, the short

function must be used in the case of Load ON. When setting to OFF, the short function can be used directly.



A short circuit may trip a protection mode if too much current is sunk.

Channel Control

Background External channel control is used with the Channel Control connectors. Each channel control connector can activate each load, monitor voltage and current and has an external voltage reference input. The voltage and current monitors output 0~100% of the rated current/voltage as a voltage of 0~10V.

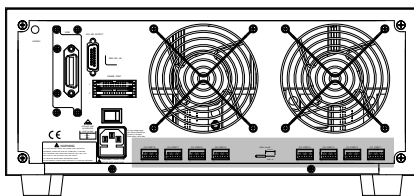

External Voltage Reference A voltage reference of 0-10V is used to represent 0-100% of the rating voltage/current of a load module. As seen below the external voltage reference and the rating voltage/current have a linear relationship. By varying the reference voltage between 0~10V the voltage/current setting will be changed accordingly.

External Voltage Control

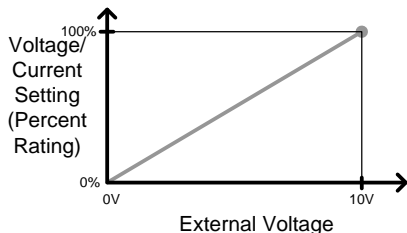

To determine the Percent Rating (voltage or current load input), use the following formula;

$$Load\ Input = \frac{External\ Voltage}{10(V)} \times Rating\ VorA$$

Where "Rating V or A" is the rating voltage/current of the load module.

Current Monitor The load current input can be externally monitored using the IMON pin of a channel control connector. The IMON pin outputs a voltage of 0~10V to represent the input current as a percentage (0~100%) of rating current.

Current Monitor

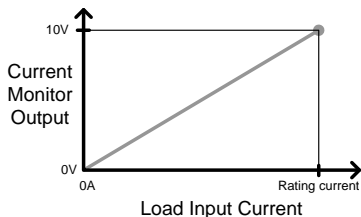

To determine the Current Monitor Output (IMON) , use the following formula;

$$IMON = \frac{Load\ input\ current}{Rating\ A} \times 10V$$

Where "Rating A" is the rating current of the load module.

Voltage Monitor The input voltage, like the load input current can be externally monitored with the channel control connectors. The VMON pin of the channel control connector outputs a voltage of 0~10V to represent the load input voltage as a percentage (0~100%) of the rating voltage.

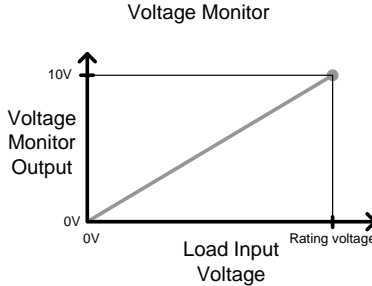

To determine the Voltage Monitor Output (VMON) , use the following formula;

$$VMON = \frac{\text{Load input voltage}}{\text{Rating V}} \times 10V$$

Where “Rating V” is the rating voltage of the load module.

Turning on the Load A load is turned on when Load On input is set to On (active low). A load is turned off when the Load On input is set to Off (active high).

When a load is turned on from the channel control interface, the load can be turned off from the mainframe, local module and via remote control. However the opposite is not true; when a load is turned off using the channel control interface, the load cannot be turned on via the mainframe, local module or via remote control.

For connections and configurations, see pages 55 and 270 respectively.

Interface and System

Interface

Background The PEL-2000B series support RS232/RS485, GPIB, LAN and USB remote frame control. Only one type of connection is supported at any one time. For more information on remote control please see the GW Instek website at www.gwinstek.com or see your local distributor about the PEL-2000B series programming manual.

For connection options and configurations see the options below.

UART configuration	Page 221
Configure UART interface	Page 277
LAN configuration	Page 280
GPIB configuration	Page 225
GPIB pin configuration	Page 268
USB configuration	Page 223

File System

Background The PEL-2000B series is able to save and recall a number of different data types for each channel:

Presets

Memory

Setup

SEQ (Sequence)

All data types can be saved and recalled to internal memory or saved to a USB flash drive.

	Each channel has its own dedicated memory for each data type. Thus files are saved/recalled for each channel and each data type.															
Preset Data	Preset data can be saved into 10 memory slots for each channel. Preset data contains the mode, range, CV response speed and Go/NoGo settings.															
	Internal Format P0~P9															
	External Format 20X0X_XX.P															
Preset Contents	Preset data contains the following data;															
	<table border="0"> <tr> <td>CHAN</td> <td>• Mode</td> <td>• Static/Dynamic</td> </tr> <tr> <td></td> <td>• Range</td> <td>• CV response speed</td> </tr> <tr> <td>Go/NoGo</td> <td>• SPEC Test</td> <td>• Entry Mode</td> </tr> <tr> <td></td> <td>• High</td> <td>• Low</td> </tr> <tr> <td></td> <td>• Center</td> <td></td> </tr> </table>	CHAN	• Mode	• Static/Dynamic		• Range	• CV response speed	Go/NoGo	• SPEC Test	• Entry Mode		• High	• Low		• Center	
CHAN	• Mode	• Static/Dynamic														
	• Range	• CV response speed														
Go/NoGo	• SPEC Test	• Entry Mode														
	• High	• Low														
	• Center															
Memory Data	Each channel can save up to 120 different Memory data types (M001~M120) into internal memory. Memory data contains general channel settings and is used when programming sequences. Memory data can be stored both internally and externally through the USB A port on the front panel of mainframe. Preset data and Memory data store the same contents.															
	Internal Format M001~M120															
	External Format 20X0X_XX.M															
Memory Contents	Memory data contains the following data;															
	<table border="0"> <tr> <td>CHAN</td> <td>• Mode</td> <td>• Static/Dynamic</td> </tr> <tr> <td></td> <td>• Range</td> <td>• CV response speed</td> </tr> <tr> <td>Go/NoGo</td> <td>• SPEC Test</td> <td>• Entry Mode</td> </tr> <tr> <td></td> <td>• High</td> <td>• Low</td> </tr> <tr> <td></td> <td>• Center</td> <td>• Delay Time</td> </tr> </table>	CHAN	• Mode	• Static/Dynamic		• Range	• CV response speed	Go/NoGo	• SPEC Test	• Entry Mode		• High	• Low		• Center	• Delay Time
CHAN	• Mode	• Static/Dynamic														
	• Range	• CV response speed														
Go/NoGo	• SPEC Test	• Entry Mode														
	• High	• Low														
	• Center	• Delay Time														

SEQ Data	<p>SEQ data contains Sequence data. SEQ data can only be saved to and from USB. SEQ refers to Sequence data, not Program sequences.</p> <hr/> <p>Internal Format N/A (Internal buffer)</p> <p>External Format 20X0X_XX.A</p> <hr/>												
SEQ Contents	<p>SEQ data contains the following data;</p> <hr/> <table border="0" style="width: 100%;"> <tr> <td style="vertical-align: top; padding-right: 20px;">Seq.Edit</td> <td> <ul style="list-style-type: none"> • No. (Points) • Slew rate ⌘ • Duration time </td> <td style="vertical-align: top; padding-left: 20px;"> <ul style="list-style-type: none"> • Value • Slew rate ↵ </td> </tr> <tr> <td style="vertical-align: top; padding-right: 20px;">Loop</td> <td> <ul style="list-style-type: none"> • Repeat • On End Load </td> <td style="vertical-align: top; padding-left: 20px;"> <ul style="list-style-type: none"> • Start of Loop • CC Vrange </td> </tr> </table> <hr/>	Seq.Edit	<ul style="list-style-type: none"> • No. (Points) • Slew rate ⌘ • Duration time 	<ul style="list-style-type: none"> • Value • Slew rate ↵ 	Loop	<ul style="list-style-type: none"> • Repeat • On End Load 	<ul style="list-style-type: none"> • Start of Loop • CC Vrange 						
Seq.Edit	<ul style="list-style-type: none"> • No. (Points) • Slew rate ⌘ • Duration time 	<ul style="list-style-type: none"> • Value • Slew rate ↵ 											
Loop	<ul style="list-style-type: none"> • Repeat • On End Load 	<ul style="list-style-type: none"> • Start of Loop • CC Vrange 											
Setup Data	<p>Setup data can be saved to 4 internal memory slots. Setup data contains Memory data, Program Sequence, Chain data, configuration settings and operation settings for every channel. Setup data can be saved to Internal memory or to USB.</p> <hr/> <p>Internal Format Setup Memory 1~4</p> <p>External Format 200X0_XX.S</p> <hr/>												
Setup Contents	<p>Setup data contains the following data;</p> <hr/> <table border="0" style="width: 100%;"> <tr> <td style="vertical-align: top; padding-right: 20px;">Program</td> <td> <ul style="list-style-type: none"> • PROG • Memory • On-Time • P/F-Time • Short Channel </td> <td style="vertical-align: top; padding-left: 20px;"> <ul style="list-style-type: none"> • SEQ (program sequence no.) • Run • Off-Time • Short-Time </td> </tr> <tr> <td style="vertical-align: top; padding-right: 20px;">Chain</td> <td> <ul style="list-style-type: none"> • Start </td> <td style="vertical-align: top; padding-left: 20px;"> <ul style="list-style-type: none"> • Program Sequence (P01~P12) </td> </tr> <tr> <td style="vertical-align: top; padding-right: 20px;">Run</td> <td> <ul style="list-style-type: none"> • Active Channel (CH01~08) </td> <td></td> </tr> <tr> <td style="vertical-align: top; padding-right: 20px;">CHAN</td> <td> <ul style="list-style-type: none"> • Mode </td> <td style="vertical-align: top; padding-left: 20px;"> <ul style="list-style-type: none"> • Static/Dynamic </td> </tr> </table>	Program	<ul style="list-style-type: none"> • PROG • Memory • On-Time • P/F-Time • Short Channel 	<ul style="list-style-type: none"> • SEQ (program sequence no.) • Run • Off-Time • Short-Time 	Chain	<ul style="list-style-type: none"> • Start 	<ul style="list-style-type: none"> • Program Sequence (P01~P12) 	Run	<ul style="list-style-type: none"> • Active Channel (CH01~08) 		CHAN	<ul style="list-style-type: none"> • Mode 	<ul style="list-style-type: none"> • Static/Dynamic
Program	<ul style="list-style-type: none"> • PROG • Memory • On-Time • P/F-Time • Short Channel 	<ul style="list-style-type: none"> • SEQ (program sequence no.) • Run • Off-Time • Short-Time 											
Chain	<ul style="list-style-type: none"> • Start 	<ul style="list-style-type: none"> • Program Sequence (P01~P12) 											
Run	<ul style="list-style-type: none"> • Active Channel (CH01~08) 												
CHAN	<ul style="list-style-type: none"> • Mode 	<ul style="list-style-type: none"> • Static/Dynamic 											

- | | | |
|---------|-------------|---------------------|
| | • Range | • CV response speed |
| Go/NoGo | • SPEC Test | • Entry Mode |
| | • High | • Low |
| | • Center | |

Save: Internal memory When saving data to internal memory, either the current channel or all the channel data can be saved. Not all data types can save the current channel or all the channel data.

Data Type	Current Ch	All Ch
Preset	✓	✓
Memory	✓	✓
SEQ	✓ (single save)	—
Setup	—	✓

Save: External memory Only SEQ, Memory and Preset data can be saved for a single channel to USB. All four data types (SEQ, Memory, Setup, Preset) can save all channels to USB.

Data Type	Current Ch	All Ch
Preset	✓	✓
Memory	✓	✓
SEQ	✓	✓
Setup	—	✓

Save/Recall USB In order to save data from a single channel to USB, data must first be saved to the internal memory. After data is saved to internal memory, all the files can be saved to USB.

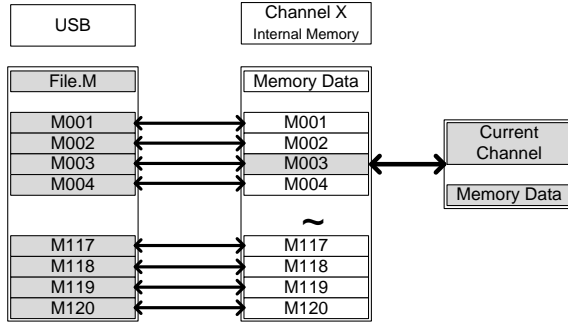

To recall saved files, the reverse is also true. Files must be recalled from the USB flash drive to internal memory. Then from internal memory the data can be recalled to each channel*.

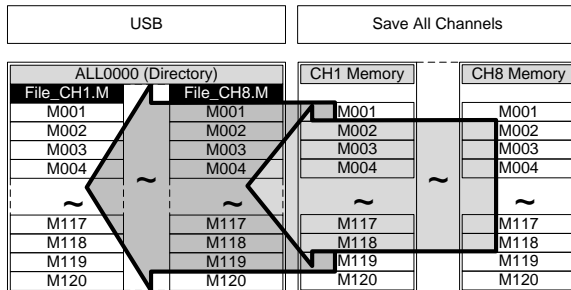

*Excluding SEQ data.

Save/Recall All The SEQ, Preset, Memory or Setup data can be saved from every channel into USB. SEQ, Preset and Memory data is saved into a directory (ALL0000-ALL0099) with a file for each channel, whilst Setup data is saved in a single file.



To recall saved files, the reverse is not true. Files must be recalled to each channel separately.

File Format

Current Channel	Filename format	
Memory data	2030R_00.M	1: PEL-2000B series Load module
Preset data		type:
SEQ data	1 2 3 4	2020 = PEL-2020B
		2030 = PEL-2030B
		2040 = PEL-2040B
		2041 = PEL-2041B
		2: Channel location or Voltage range of single channel model.
		R = Right
		L = Left
		0 = Single channel or not used
		3: Save file number:
		0 ~99
		Incremented after each consecutive save.
		4: File extension
		M = Memory data
		P = Preset data
		A= SEQ data
All Channel	Directory Format	
	ALL_0000	1: All Channel common directory name
		2: Directory number:
	1 2	0000 ~ 0099

All Channel

File Format

Memory data

Preset data

SEQ data

Setup Data

2230R_C1.M

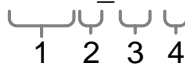

20040_00.S

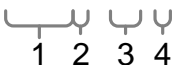

1: PEL-2000B series Load module type:

2020 = PEL-2020B

2030 = PEL-2030B

2040 = PEL-2040B,

2041 = PEL-2041B

2: Channel, Voltage range of single channel model or Mainframe indication

R = Right

L = Left

0 = Single channel

3: Channel number:

C1 = CH1

C2 = CH2

Etc.

00 = All channels (Setup data)

4: File extension

M = Memory data

P = Preset data

A= SEQ data

S= Setup data

TUTORIALS

Local loads	98
Single Channel Load	100
Parallel Load Modules	102
Programming.....	104
Sequences	106
Frame Link.....	107
Channel Control.....	109
General Configuration Options	111

Local loads

Local mode operation is useful to quickly test loads using the load module control panel rather than the mainframe control panel. Local load modules can be configured to operate independently to the mainframe. This can be useful when settings need to remain unchanged on the mainframe. Note however that the local modules cannot change the modes (CC, CV, CR, CP), only the values.

Group Unit mode is not supported for local module control.

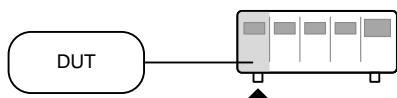

Step	Description	Details
1. Setup	Ensure the channel load is set up as desired.	Pages 36, 43
2. Channel selection	Ensure the correct channel or Value (A/B) is selected by using the R/L or A/B key.	Page 116
3. Measurement Mode selection	If in CC or CR mode, Static or Dynamic mode can be selected.	CC Pages 117, 128 CR Pages 132, 134
4. Run the Load	Press the LOAD key to start/end loading the device under test.	Page 118

Optional

5. Short configuration	Configure the SHORT settings.	Page 180
6. Display	To change the display output, use the DISPLAY key.	Page 119
7. Shorting the load	To short the load, use the SHORT key.	Page 119

- | | | |
|-----------------------------------|---|----------|
| 8. Independent load | The local load modules can be set to independent load. | Page 184 |
| 9. Independent control | Slave knobs can be configured to be independent to the mainframe. | Page 205 |
| 10. Configure Slave Knob Settings | Display Measured or Set Values with the selector knob. | Page 208 |
-

Single Channel Load

Single channel loads are used to manually test a DUT quickly or to configure channel settings for Program Sequences using the mainframe panel.



Step	Description	Details
1. Setup	Choose the appropriate load module and make sure it is installed.	Page 36
2. Connection	Connect the terminals to the DUT.	Page 43
3. Channel selection	Select the load channel on the mainframe.	Page 122
4. Measurement mode selection	Select measurement mode (CC, CV, CR, CP).	CC Page 124 CV Page 137 CR Page 130 CP Page 141
5. Range selection	Set the range to high or low (CC, CR, CV and CP mode).	CC Page 124 CR Page 131 CP Page 144
6. Mode selection	Choose Static or Dynamic mode (CC & CR mode only).	CC Pages 125, 128 CR Pages 132, 134
7. Dynamic levels (CC,CR)	Set the dynamic levels, slew rate and timers. Applicable to CC & CR mode only.	CC Page 126 CR Page 132

- | | | |
|----------------------|---|---|
| 8. Static Values | Set the A(B) Value, slew rate (CC, CR) and current limit (CV, CP) | CC Page 128
CR Page 135
CV Page 138
CP Page 142 |
| 9. Go/NoGo | Set the Go/NoGo configurations, if applicable. | Page 190 |
| 10. Protection Modes | Configure the protection modes. | Page 173 |
| 11. Run | Activate the load by pressing the load key. |  |

Optional

- | | | |
|-------------------|--|----------|
| 12. Configuration | There are number of configurations that apply to all channels. For details see the Configuration Tutorial. | Page 111 |
|-------------------|--|----------|

Parallel Load Modules

The Group Unit setting allows for a quick and easy parallel setup for load modules of the same type and rating. However, the Group Unit settings only apply for CC and CR modes.

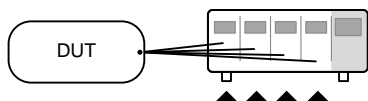

Step	Description	Details
1. Setup	Choose the appropriate load modules and make sure they are installed. All load modules must be of the same type and rating.	Page 36
2. Connection	Connect the terminals to the DUT.	Page 43
3. Group Unit mode configuration	Enable Group Unit Mode and configure.	Page 194
4. Measurement mode selection	Select measurement mode (CC, CR).	CC Page 124 CR Page 130
5. Range selection	Set the range to high or low (CC, CR mode).	CC Page 124 CR Page 131
6. Mode selection	Choose Static or Dynamic mode.	CC Pages 125, 128 CR Pages 132, 134
7. Dynamic levels	For Dynamic mode, set the dynamic levels, slew rate and timers.	CC Page 126 CR Page 132
8. Static Values	For Static mode, set the A(B) Value and slew rate.	CC Page 128 CR Page 135

9. Go/NoGo Set the Go/NoGo configurations, if applicable. Page 190

10. Protection Modes Configure the protection modes. Page 173

11. Run Activate the load by pressing the load key.



Optional

12. Configuration There are number of configurations that apply to all channels. For details see the Configuration Tutorial. Page 111

Programming

When creating a Program Sequence or Chain, all channels are used at the same time unless programmed otherwise. Program Sequences use the channel settings stored from Memory Data. Program sequences are primarily used to perform a battery of pass/fail tests on DUTs.

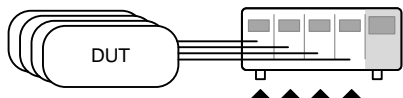

Step	Description	Details
1. Setup	Choose the appropriate load module(s).	Page 36
2. Connection	Connect the terminals to the DUT.	Page 43
3. Channel selection	Select the load channel(s) on the mainframe.	Page 122
4. Channel setup	See the “Single channel load” tutorial to configure a single channel. Do not activate the load.	Page 100
5. Save channel	Save the configured channel.	Page 227
6. Multiple channels	If multiple channels need to be configured, follow steps 1-5 for any remaining channels.	
7. Program menu	Enter the Program menu.	Page 146
8. Configure the sequence	Configure the program.	
9. Save sequences	Save the Program in the FUNC →Program menu.	
10. Program Chains	If required, Program chains can be created.	Page 149

- | | | |
|------------------|---|----------|
| 11. Save Program | Save the chain in the Chain menu. | |
| 12. Save Setup | Save everything to the internal Setup memory. | Page 235 |
| 13. Run | Run the Program Sequence/Chain. | Page 152 |

Sequences

Sequences are used to accurately simulate loads. As each Sequence is independent, Sequences are ideally suited to test multiple output power sources.

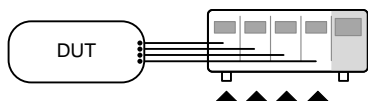

Step	Description	Details
1. Setup	Choose the appropriate load module(s).	Page 36
2. Connection	Connect the terminals to the DUT.	Page 43
3. Channel selection	Select a load channel with the mainframe.	Page 122
4. Channel setup	Create a sequence.	Page 157
5. Sequence loop	Create a sequence loop if necessary.	Page 159
6. Multiple channels	If multiple channels need to be configured, follow steps 1-5 for any remaining channels.	
7. Channel Duration menu	Edit the sequence channel duration information. Ensure that the channels containing Sequences are not set to OFF.	Page 161
8. Trigger Settings	Set Trigger Out and In channels, if appropriate.	
9. Run	Run the Sequence(s)	Page 164

Frame Link

Frame link connections are used connect up to four slave main frames to a master main frame. When using frame link connections it is possible to perform a number of operations in parallel under the control of the master unit.

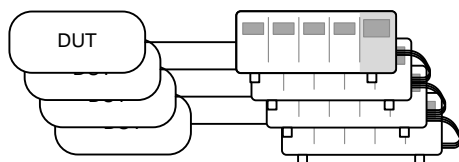

Step	Description	Details
1. Setup	Connect the mainframes together.	Page 53
2. Configure	Configure the Frame CONT to ON for all mainframes.	Page 203

05/04/22
16:50

FRM

USB

LOAD

At first both the master and slaves are independent. FRM (Frame Master) can be seen on the top panel of the each mainframe. When a mainframe is connected as a slave unit, the FRM icon will change to FRS (Frame Slave). The front panel keys are disabled on slave units when in slave mode (FRS).

Slave mode

FRM → FRS

Master/Independent

FRM

3. Program	See the tutorial sections for programming or channel configuration.	Pages 100, 102
------------	---	----------------

- 4. Run Run the loads. To run the loads, press the LOAD key on the master mainframe. To stop, press again. When the LOAD key is pressed all loads will be active.

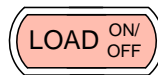

Options

- 5. Load Preset memory Load preset memory on the mainframe and all frame-linked slaves. Page 262

- 6. Load Setup Memory Load setup memory on the mainframe and all frame-linked slaves Page 261

- 7. Set slave to independent Press shift + CHAN on the slave unit to enable local control on a slave unit.

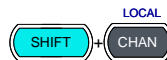

FRS → **FRM**



Note

When a load is run or memory is recalled from the master mainframe, the slave unit will return to mainframe control.

Ensure the same firmware is installed on both master and slave mainframes.

Channel Control

The Channel Control connectors on the rear panel can be used to control and monitor the status of up to 8 channels. For more information on channel control, see page 86.

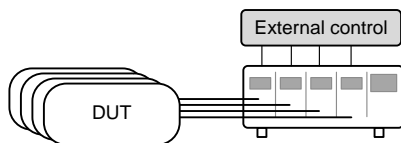

Step	Description	Details
1. Setup	Ensure the load and PEL-2000B series mainframe is turned off.	
2.	Choose the appropriate load module(s).	Page 36
3. Connection	Connect the terminals to the DUT.	Page 43
4.	Connect the channel control connectors on the rear panel.	Page 55 & 270
5.	Turn on the PEL-2000B series mainframe and DUT (load).	
6. Configure	Select the Mode* and Range* via the front panel.	CC Pages 124, 124 CV Page 137
7.	Activate channel control for each channel that will be used for external control, i.e., set CH CONT to External.	Page 182

- | | | |
|------------|--|--------------|
| 8. Run | Run the load. Turn the load on by either outputting an active low signal to the appropriate channel control connector or control connector, or press the LOAD key on the load module or mainframe**. | Page 55 & 86 |
| 9. Monitor | Use IMON and VMON to monitor the current and voltage of load outputs. | Page 86 |
| 10. End | To turn the load off, output an active high signal to the channel control connector, or press the LOAD key on the load module or mainframe**. | |

* Mode and Range cannot be configured via the Channel Control (CH CONT) interface. Mode and Range can only be configured via the front panel.

** The LOAD key cannot always be used to turn on/off the load. See page 86 for details.

General Configuration Options

There are number of different options for each channel. The different options are described below.

Options	Description	Details
1. CC Vrange	Configure the CC Voltage range from high or low.	Page 177
2. Von Voltage	Configure the Von Voltage settings.	Page 178
3. Short Settings	Configure the short key settings.	Page 180
4. CH CONT	Turn channel control on/off	Page 182
5. Independent load	Turn the load module control to dependent (via mainframe) or independent control.	Page 184
6. Delay Time	Configure the load delay time for each channel. (0-10 seconds).	Page 185
7. Clear All Protection	Clear all the Protection Alarms.	Page 176
8. Display	Adjust display settings.	Page 201
9. Control type	Configure the Knob control.	Page 205
10. Slave Knob Setting	Display Measured or Set values with the selector knob.	Page 208
11. Alarm	Configure alarm settings.	Page 206
12. Step resolution	Configure the step resolution. Applicable to CC high and low range, CR high and low range, CV high and low range and CP high and low rang.	Page 187
13. Response	Configure the Response setting.	Page 190

14. Sound

Turn the sound on/off for the mainframe IU.

Page 201

OPERATION

The PEL-2000B series operation is described in the chapters below. The sections are broken down into small operations. For thorough examples on the operation of the load, please see the tutorial section on page 98.

Local Mode Operation	116
Selecting a Channel.....	116
Selecting Static/Dynamic.....	117
Turning on the Load	118
Shorting.....	119
Display Output View	119
Editing CC/CR/CV/CP A/B Value	120
Mainframe Basic Operation	122
Help Menu	122
Channel Selection	123
Select CC Mode.....	124
Select CC Range	124
Select CC Dynamic Mode	125
Editing CC Dynamic Parameters	126
Select CC Static Mode.....	128
Editing CC Static Parameters.....	128
Set to CR Mode	130
Select CR Range	131
Select CR Dynamic Mode	132
Editing CR Dynamic Parameters	132
Select CR Static Mode.....	134
Editing CR Static Parameters.....	135
Select CV Mode.....	137
Editing CV Parameters	138
Select CV Range	139
Select CV Response Speed	140
Select CP Mode.....	141
Editing CP Parameters	142

Select CP Range	144
Creating a Program Sequence	145
Program Chains	149
Running a Program.....	152
Edit Sequence	157
Create Sequence Loop	159
Channel Duration Time Settings.....	161
Run Sequence	164
OCP Test Automation.....	166
Channel Configuration	172
Accessing the Configuration Menu.....	172
Setting (OCP/OVP/OPP/UVP)	173
Protection Clear	176
Setting the CC Voltage Range.....	177
Adjusting the Von Voltage and Latch.....	178
Configuring the Short settings	180
Configuring Channel Control	182
Configuring the Independent Setting.....	184
Configuring the Load Delay Time.....	185
Configuring Step Resolution	187
Configuring Response Time	190
Go/NoGo	191
Group Unit	194
Mainframe Configuration	198
Accessing System Information.....	198
Accessing the Load Menu	200
Adjusting the Speaker.....	201
Adjusting the Display Settings	202
Adjusting the Frame Control.....	203
Adjusting the Knob Control Type	205
Configuring Alarm Sound.....	206
Configuring Go/NoGo Alarm Sound	207
Adjusting Slave Knob Settings	208
View Language Settings.....	210
Adjusting the High Resolution	211
Adjusting the System Mode	212
Adjusting the Von Latch Clear.....	213
Adjusting the Measure Period.....	215
Adjusting the Jog Shuttle Control.....	217
Adjusting the RVP Load Off.....	218

Setting the Date and Time	219
Interface Configuration (settings)	221
Configuring UART Connection	221
Configuring USB Connection	223
Configuring the GPIB Address	225
UART, LAN and USB CDC Function Check.....	227
GPIB Function Check	230
Saving/Recalling Channels	232
Saving/Recalling Preset memory.....	234
Saving/Recalling Setup Memory	236
Setting the Default USB Path/File	238
Saving Setups to USB Memory	243
Saving/Recalling Memory Data to USB	245
Saving/Recalling Presets to USB	250
Saving/Recalling Sequences to USB	255
Quick Preset Recall/Save	260
Recall Setup Memory (Frame link).....	261
Recall Preset Memory (Frame link).....	262
Recall Factory/User's Defaults	263

Local Mode Operation

Each channel can be edited by its local load module. Depending on the configuration, local changes can be reflected on the mainframe. For this section all operations refer to knobs and buttons on the local load module panels, unless stated otherwise.

Selecting a Channel

Background	Each channel can be individually selected by using its load module panel. Changing channels on a load module only applies to dual channel load modules.
Single Channel Panel operation	Press any key on a load module to select its channel.
Dual Channel Panel Operation	For dual channel load modules, press any key on a load module that has the desired channel. Press the R/L key to cycle between the channels on the load module. L or R will be displayed on the bottom left hand to indicate which channel (left or right side) is active on the load module.



LR



Note

On single channel modules, pressing the A/B key repeatedly will change the level from A or B when in Static mode.

Channels cannot be selected in Group Unit Mode.

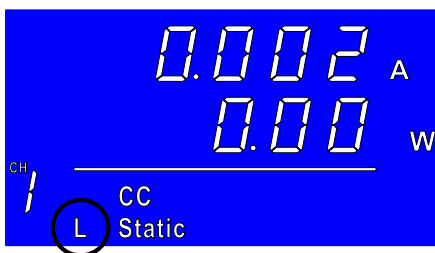

Selecting Static/Dynamic

Background Each load channel can be individually switched from Static to Dynamic using the local load module.

1. Select a channel on the load module. Page 116

Panel operation 2. Press the STATIC/DYNA. key to switch from dynamic to static mode and vice versa.



All changes will be shown on the display and depending on the configuration, reflected on the mainframe.

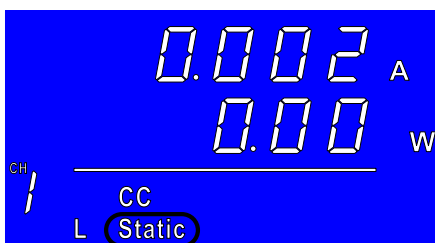

Turning on the Load

Background Loads can be individually selected to be turned on using local operation.

1. Select a channel on the load module. Page 116

Panel operation 2. Press the LOAD key to turn on the load.



Note

When a channel load is activated, the load on symbol will be displayed under the channel number.

Range

- L-ON** Left channel
- R-ON** Right channel
- ON** Single channel

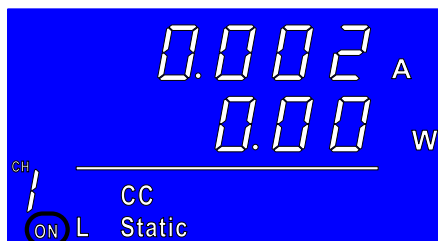

Turning the load off 3. Press the LOAD key.



Shorting

Background The Short Key is used to simulate a short circuit.

1. Configure the Short settings. Page 180
2. Select a channel on the load module. Page 116

Panel operation 3. Press the SHORT key to enter the shorting modes.

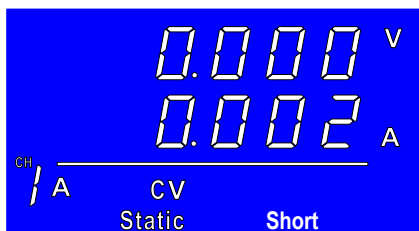

Shorting 4. a. Press the SHORT key (toggle mode).



Or

b. Hold the SHORT key (hold mode).



Note

The load cannot be shorted from the local load module in Group Unit mode.

Display Output View

Background The DISPLAY key can be used to switch the display output to different views.

Panel operation 1. Press the DISPLAY key repeatedly to switch between the different views.



V

Voltage

- A** Current
- W** Power
- S** Load on time.



Note

The Display mode cannot be changed in Group Unit mode.

Editing CC/CR/CV/CP A/B Value

Background The Slave Knob is used to edit the A Value or B Value (single channel load module) when in static mode. The Slave Knob can also operate in fine or coarse editing mode.

Panel Operation 1. Ensure the mode is in static mode. Page 117

2. Choose a channel (or choose A or B Value) by pressing the R/L or A/B key.



3. Press the Slave Knob to toggle between fine and coarse editing mode.

SEt_C = coarse mode.

SEt_F = fine mode.

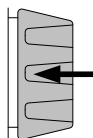

Fine mode example:

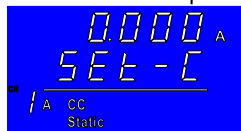

Coarse mode example:



4. Turn the Slave Knob to edit the A/B Value for the selected mode.

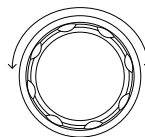



When the Slave Knob is set to “Measure”, the slave knob must be pressed first to display the values on the load module display.

Editing the A/B Value is not possible with this method in Group Unit mode.

Mainframe Basic Operation

For the Mainframe Basic Operation section, all operations refer to the knobs and keys on the main configuration panel, unless otherwise stated.

Help Menu

Background When any function key has been pressed or when a menu has been opened, the HELP key can be used to display a detailed description.

1. Press a function or system key on the front panel or open a menu.

Help Selection 2. Press the HELP key to display the built-in help.

3. Use the scroll wheel to scroll down if necessary.



05/04/22
16 : 50

File System

The system is able to save and recall a number of different data types for each channel: **Memory**, **Preset**, **Sequence** And, a data type for all channels is **Setup**.

All data types can be saved and recalled to internal memory or saved to a external

Help				Exit
On Help				

A detailed description of the function or menu item is shown.

4. Press F5 to exit.



Channel Selection

Background There are up to 2 channels per load module, depending on the model. The main display can be used to control each channel individually.



Note

When Group Unit Mode is enabled, channel selection is disabled. See page 116 for details.

Mainframe Channel selection

1. Press the CHAN button.



2. Select a channel by turning the Variable knob.

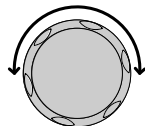

The channel selection appears highlighted in orange on the top right of the screen.

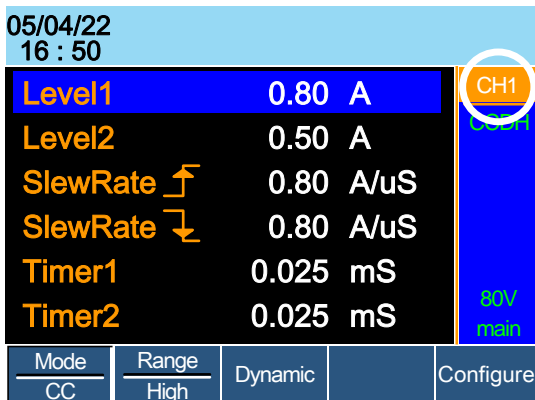

3. Press the Selector knob or Enter to confirm.

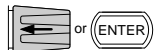

Select CC Mode

Background The PEL-2000B series loads operate in four different modes: Constant Current (CC), Constant Resistance (CR), Constant Voltage (CV), and Constant Power (CP).

When a channel is active, the F1 key can be used to switch between each operating mode.

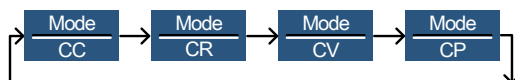

Panel Operation 1. Select a channel using the CHAN button and selector knob.



2. Press F1 repeatedly until CC mode is displayed in the display panel.



Note

Changing the operating mode will only affect the current (active) channel. Other channels will not be affected by any changes.

Select CC Range

Background Constant current mode can run in high and low range. Maximum range is dependent on the load module. Some models are only high range.

Ensure the menu is in CC Mode. See page 124.



- Panel Operation 1. Press the F2 (Range) key repeatedly until High or Low range is selected.

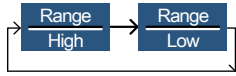

The range will be reflected in both the bottom menu system and the Current Operation Channel Status panel.



- CC Dynamic Low CCDL
- CC Dynamic High CCDH
- CC Static Low CCL
- CC Static High CCH



Note

Changing the range will only affect the current (active) channel. Other channels will not be affected by any changes.

Not all load modules support dual ranges. If only one range is supported, it is usually high range.

Select CC Dynamic Mode

Background Constant current mode can be set to dynamic or static mode. Dynamic mode is used to automatically set varying load rates.

Ensure the menu is in CC Mode. See page 124.



- Panel Operation 1. Press the F3 key until Dynamic Range mode is selected.

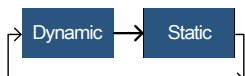
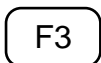



Changing from static to dynamic mode will only affect the current (active) channel.

Editing CC Dynamic Parameters

Background Dynamic Constant Current Mode has two operating current levels, slew rates and timers.

Slew rates determine the speed at which the load will change from one level to the next.

The timers determine how long the load module/channel will stay at level 1 or level 2.

Ensure the menu is in CC Dynamic Mode. See page 125.

Mode	Range	Dynamic		Configure
CC	High			

Parameters	Level1	0 ~ Setting Max A
	Level2	0 ~ Setting Max A
	SlewRate	↕ Load module dependent
	SlewRate	↕
	Timer1	0.025 ~ 30000.0 ms
	Timer2	0.025 ~ 30000.0 ms



When used in Group Unit mode, the Level1 & Level2 range is the combined rating of all the units used in Group Unit mode.

Panel Operation 1. Use the Selector knob to highlight Level1.

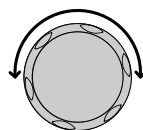

05/04/22 16 : 50			
Level1	0.80	A	CH1P CCDH 80V main
Level2	0.50	A	
SlewRate ↑	0.80	A/uS	
SlewRate ↓	0.80	A/uS	
Timer1	0.025	mS	
Timer2	0.025	mS	
Mode CC	Range High	Dynamic	Configure

2. Press the Selector knob to edit the selected level, then turn to increase or decrease the value*.

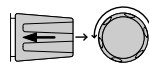

OR

Use the number pad to enter a number.



Level1 **0.80** **A**

3. Press the Selector knob or Enter to confirm selection.
4. Repeat steps 1-3 for the remaining parameters.

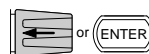

Note

Level1 & Level2 can be set for both High and Low Range.

*Press Shift to toggle between coarse and fine adjustment when editing the Level1 and Level2 parameters. See page 187 for details.

Select CC Static Mode

Background Constant current mode can be set to dynamic or static mode. Static mode is for manually varying the load for single channel load modules or to set a static load on dual channel modules.

Ensure the menu is in CC Mode. See page 123.

Mode CC	Range High	Dynamic		Configure
------------	---------------	---------	--	-----------

Panel Operation 1. Press the F3 key until Static mode is selected.

F3

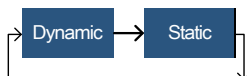

Note

Changing from static to dynamic mode will only affect the current (active) channel.

Editing CC Static Parameters

CC Values When using a single channel load module, Static Constant Current Mode has two operating current values, A&B. If a dual channel load is used, only one current value is available per channel: A Value.

If Group Unit Mode is enabled, an additional parameter, Switch Value, is available to switch from A Value to B Value.

Ensure the menu is in CC Static Mode. See page 128.

Mode CC	Range High	Static	Seq. Edit	Configure
------------	---------------	--------	--------------	-----------

Parameters	A Value	0 ~ Setting Max A
	B Value	0 ~ Setting Max A
	SlewRate	↗ Load module dependent
	SlewRate	↘
	Switch Value	A/B (Group Unit Mode only)



Note

When Group Unit Mode is enabled, the A Value & B Value range is the combined rating of all the units used in Group Unit Mode, see page 70.

- Panel Operation
1. Use the Selector knob to highlight A Value.

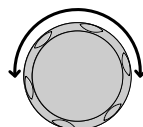

Single Channel Configuration

05/04/22 16:50		LOAD	USB	
A Value	0.80	A	CH1	
B Value	0.80	A	CH1P	
SlewRate	↗	0.80	A/uS	
SlewRate	↘	0.80	A/uS	
Mode	Range	Static	Seq. Edit	Configure
CC	High			

Group Unit Mode Configuration

05/04/22 16:50		LOAD	USB	
A Value	0.80	A	CH1P	
B Value	0.80	A	CH1P	
SlewRate	↗	0.80	A/uS	
SlewRate	↘	0.80	A/uS	
Switch Value		A		
Mode	Range	Static	Seq. Edit	Configure
CC	High			

2. Press the Selector knob to edit the selected value, then turn to increase or decrease the value*.

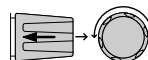

OR

Use the number pad to enter a number.



A Value **0.80** **A**

3. Press the selector knob or Enter to confirm selection.

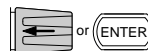

- Repeat steps 1-3 for the remaining parameters.



Note

The last Value (A Value or B Value) that is set becomes the active setting. To swap between A Value and B Value, use the A/B keys on the local load module. This is not applicable to Group Unit mode.

For Group Unit mode, use the Switch Value parameter to switch between A and B Value.

A/B Value and rising/falling SlewRate can be set for both High and Low Range.

*Press Shift to toggle between coarse and fine adjustment when editing the A Value and B Value parameters. See page 187 for details.

Set to CR Mode

Background

The PEL-2000B series load operates in four different modes, Constant Current (CC), Constant Voltage (CV), Constant Resistance (CR) and Constant Power (CP). Constant Resistance mode will maintain a constant resistive load, using variable current and voltage levels.

When a channel is active, the F1 key can be used to switch between each operating mode.

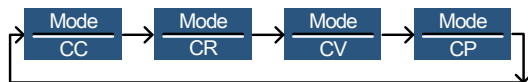
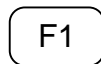

Panel Operation

- Press the CHAN button and use the selector knob to select a channel.
- Press F1 until CR mode is displayed in the display panel.

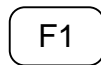

Mode CC	Range High	Dynamic		Configure
------------	---------------	---------	--	-----------



Note

Changing the operating mode will only affect the current (active) channel. Other channels will not be affected by any changes.

Select CR Range

Background Constant Resistance mode can run in high and low range. Range is dependent on the load module.

Ensure the menu is in CR Mode. See page 130.

Mode CC	Range High	Dynamic		Configure
------------	---------------	---------	--	-----------

Panel Operation 1. Press the F2 (Range) key repeatedly until High or Low range is selected.

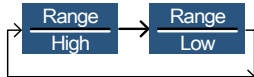

The range will be reflected in both the bottom menu system and the Current Operation Channel Status panel.

- CR Static Low CRL
- CR Static High CRH
- CR Dynamic Low CRDL
- CR Dynamic High CRDH



Note

Changing the range will only affect the current (active) channel. Other channels will not be affected by any changes.

All resistance values and slew rates are dependent on Range, i.e., A Value in low range can be different from A Value in high range.

Select CR Dynamic Mode

Background Constant Resistance mode can be set to dynamic or static mode. Dynamic mode is used to automatically set varying load rates.

Ensure the menu is in CR Mode. See page 130.



Panel Operation 1. Press F3 until Dynamic Range mode is selected.

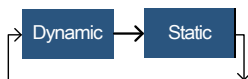
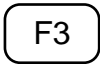

Note

Changing from static to dynamic mode will only affect the current (active) channel.

Editing CR Dynamic Parameters



CR levels Dynamic Constant Resistance Mode has two operating resistance levels, slew rates and timers.

Slew rates determine the speed at which the load will change from one level to the next.

The timers determine how long the load module/channel will stay at level 1 or level 2. See the CR operating description for details about slew rates and timers, page 63

Ensure the menu is in CR Dynamic Mode. See page 132.



Parameters	Level1	Minimum ~ Rating Ω
	Level2	Minimum ~ Rating Ω
	SlewRate 	Load module dependent
	SlewRate 	
	Timer1	0.025 ~ 30000.0ms
	Timer2	0.025 ~ 30000.0ms

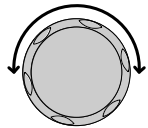

 **Note** When used in Group Unit Mode, the Level1 & Level2 range is the combined rating of all the units used in Group Unit Mode.

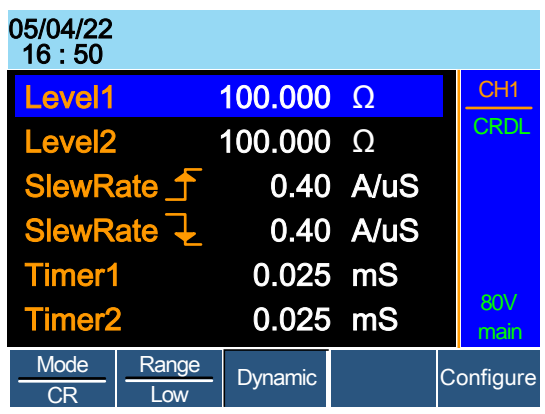
- Panel Operation 1. Use the Selector knob to highlight Level1. 

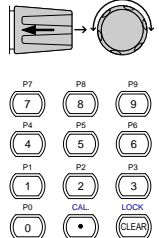

2. Press the Selector knob to edit the selected level, then turn to increase or decrease the value*.
- OR
- Use the number pad to enter a number.
- 

Level1 100.000 Ω

3. Press the Selector knob or Enter to confirm selection.  or 
4. Repeat steps 1-3 for the remaining parameters.



Note

Level1 & Level2 can be set for both High and Low Range.

*Press Shift to toggle between coarse and fine adjustment when editing the Level1 and Level2 parameters. See page 187 for details.

Select CR Static Mode

Background

Constant Resistance mode can be set to dynamic or static mode. Static mode is for manually varying the load for single channel load modules or to set a static load on dual channel modules.

Ensure the menu is in CR Mode. See page 130.

Mode	Range	Dynamic		Configure
CC	High			

Panel Operation

1. Press the F3 key until Static mode is selected.

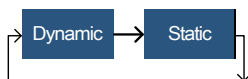
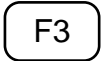

Note

Changing from static to dynamic mode will only affect the current (active) channel.



Editing CR Static Parameters

Background Single channel load modules have two resistance levels, A Value & B Value. Dual channel load modules have only one resistance level per channel, A Value.

When Group Unit Mode is enabled, an additional parameter, Switch Value, is available to switch from A Value to B Value.

Ensure the menu is in CR Static Mode. See page 134.

Mode CR	Range Low	Static	Seq. Edit	Configure
------------	--------------	--------	--------------	-----------

Parameters	A Value	Setting Min ~ Rating Ω
	B Value	Setting Min ~ Rating Ω
	SlewRate 	Load module dependent
	SlewRate 	
	Switch Value	A/B (Group Unit Mode only)



Note

When Group Unit Mode is enabled, the A Value & B Value range is the combined rating of all the units used in Group Unit Mode.

- Panel Operation**
1. Use the Selector knob to highlight A Value.

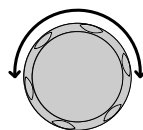

Single Channel Configuration



Group Unit Mode Configuration



- Press the Selector knob to edit A Value / B Value, then turn to increase or decrease the value*.

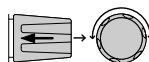

OR

Use the number pad to enter a number.



- Press the selector knob or Enter to confirm selection.
- Repeat steps 1-3 for B Value (if applicable), rising and falling SlewRate.



Note

The last Value (A Value or B Value) that is set becomes the active setting. To swap between A Value and B Value, use the A/B keys on the local load module (not applicable to Group Unit mode).

For Group Unit mode, use the Switch Value parameter to switch between A and B Value.

A/B Value and rising/falling SlewRate can be set for both High and Low Range.

*Press Shift to toggle between coarse and fine adjustment when editing the A Value and B Value parameters. See page 187 for details.

Select CV Mode

Background The PEL-2000B series electronic load operates in four different modes, Constant Current (CC), Constant Resistance (CR), Constant Voltage (CV), and Constant Power (CP).

CV Mode cannot be used with the Group Unit mode.

When a channel is active, the F1 key can be used to switch between each operating mode.

F1

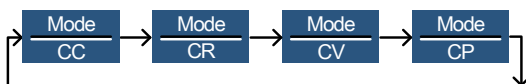

Panel Operation 1. Press the CHAN button and use the selector knob to select a channel.



2. Press F1 until CV mode is displayed in the display panel.

F1

Mode CV	Range High	Response Slow1		Configure
------------	---------------	-------------------	--	-----------



Note

Changing the operating mode will only affect the current (active) channel. Other channels will not be affected by any changes.

Editing CV Parameters

Background Constant Voltage mode can be set to a maximum limit (Curr Limit). Using the current limit enables limiting the current draw.

When using CV mode on single channel load modules, two voltage levels can be set, A Value and B Value. On a dual channel load module, only one voltage level can be set per channel: A Value.

Ensure the menu is in CV Mode. See page 137.

Mode	Range	Response		Configure
CV	High	Slow1		

Parameters	A Value	0 ~ Setting Max V
	B Value	0 ~ Setting Max V
	Curr Limit	Load module dependent

Panel Operation 1. Use the Selector knob to highlight A Value.

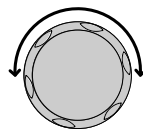

05/04/22 16 : 50				
A Value	80.00 V			CH1
B Value	80.00 V			CVH
Curr Limit	70.00 A			Slow
				80V main
Mode	Range	Response	I Mea	Configure
CV	High	Slow1	High	

2. Press the Selector knob to edit the selected value, then turn to increase or decrease the value*.

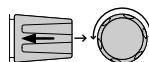

OR

Use the number pad to enter a number.



A Value

10.00

V

3. Press the selector knob or Enter to confirm selection.

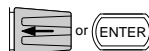

4. Repeat steps 1-3 for the remaining parameters.



Note

The last Value (A Value or B Value) that is set becomes the active setting. To swap between A Value and B Value, use the A/B keys on the local load module.

When setting the current limit, please ensure that the current limit is within the test device's limits.

A/B Value can be set for both High and Low Range.

*Press Shift to toggle between coarse and fine adjustment when editing the A Value and B Value parameters. See page 187 for details.

Select CV Range

Background

Constant Voltage mode can run in high and low range. Range is dependent on the load module.

Ensure the menu is in CV Mode. See page 144.

Mode	Range			Configure
CP	Low			

Panel Operation

1. Press the F2 (Range) key repeatedly until High or Low range is selected.



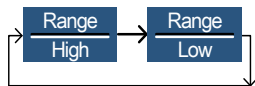

The range will be reflected in both the bottom menu system and the Current Operation Channel Status panel.



CV High Range CVH

CV Low Range CVL



Note

Changing the range will only affect the current (active) channel. Other channels will not be affected by any changes.

Select CV Response Speed

Background

Constant voltage mode has fast and slow response speeds. Quick current changes can induce line voltage, making it more difficult for the PEL-2000B series load to maintain a constant current. In these types of conditions, slow response speed is recommended.

Maximum current range is dependent on the load module type.

Ensure the menu is in CV Mode. See page 137.

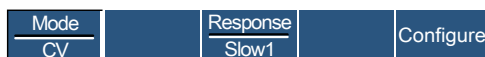

Panel Operation

1. Press F3 (Response) to switch between Fast and Slow response speeds.

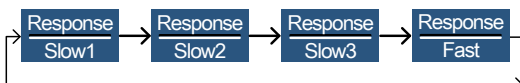

Response speed settings will be reflected in the Current Operation Channel Status panel.

CV Slow Response Slow

CV Fast Response Fast



Note

Changing the response speed will only affect the current (active) channel. Other channels will not be affected by any changes.

Select CP Mode

Background

The PEL-2000B series electronic load operates in four different modes, Constant Current (CC), Constant Resistance (CR), Constant Voltage (CV), and Constant Power (CP).

CP mode cannot be used with the dedicated Group Unit mode.

When a channel is active, the F1 key can be used to switch between each operating mode.

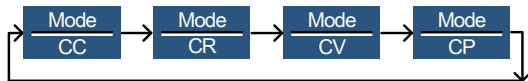
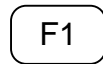

Panel Operation

1. Press the CHAN button and use the selector knob to select a channel.



2. Press F1 until CP mode is displayed in the display panel.

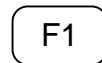

Mode	Range			Configure
CP	Low			



Note

Changing the operating mode will only affect the current (active) channel. Other channels will not be affected by any changes.

Editing CP Parameters

Background

Constant Power mode can be set to have a maximum limit (Curr Limit). Using the current limit enables limiting the current draw.

When using CP mode on a single channel load module, two power levels can be configured, A Value and B Value. On a dual channel load module, only one power level can be configured per channel: A Value.

Ensure the menu is in CP Mode. See page 137.

Mode	Range			Configure
CP	Low			

Parameters

A Value 0 ~ Setting Max W

B Value 0 ~ Setting Max W

Curr Limit Load module dependent

Panel Operation

1. Use the Selector knob to highlight A Value.

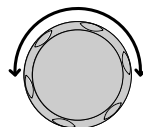



2. Press the Selector knob to edit the selected value, then turn to increase or decrease the value *.

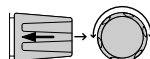

OR

Use the number pad to enter a number.



A Value 10.00 **W**

3. Press the selector knob or Enter to confirm selection.

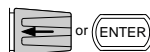

4. Repeat steps 1-3 for the remaining parameters.



Note

The last Value (A Value or B Value) that is set becomes the active setting. To swap between A Value and B Value, use the A/B keys on the local load module.

A/B Value can be set for both High and Low Range.

When setting the current limit, please ensure that the current limit is within the test device's limits.

*Press Shift to toggle between coarse and fine adjustment when editing the A Value and B Value parameters. See page 187 for details.

Select CP Range

Background Constant Power mode can run in high and low range. The maximum range is dependent on the load module. Some models are only high range.

Ensure the menu is in CP Mode. See page 137.



Panel Operation 1. Press the F2 (Range) key repeatedly until High or Low range is selected.

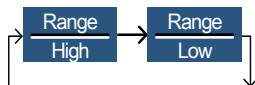

The range will be reflected in both the bottom menu system and the Current Operation Channel Status panel.

CP High Range CPH

CV Low Range CPL



Note

Changing the range will only affect the current (active) channel. Other channels will not be affected by any changes.

Not all load modules support dual ranges. If only one range is supported, it is usually high range.

Creating a Program Sequence

Background The PEL-2000B series has a total of 12 different programs and 10 sequences to each program. That totals to 120 different configurations.

Each Sequence in each program uses the settings saved from Memory Data (Memory MXXX). Memory Data contains settings such as the mode and range for each channel. Different Sequences can use the same Memory Data repeatedly. Each Sequence loads all channels at the same time, unless programmed otherwise.

Sequence1	
CH1 M001	Run
CH2 M001	On-Time
CH3 M001	Off-Time
CH4 M001	Short-Time
CH5 M001	P/F-Time
CH6 M001	Short CH1
CH7 M001	~
CH8 M001	Short CH8

Sequences are run sequentially to create a Program. There are 10 Sequences in each Program.

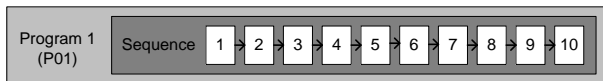

If less than 10 Sequences are desired for a Program, any additional Sequences can be skipped (not run).

Sequence 2 & 3 are skipped.

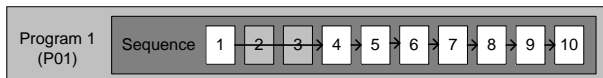

Parameters	Memory	M001~M120
	Run	Skip-Auto-Manual
	On-Time	0.1 ~ 60.0 seconds
	Off-Time	Off - 0.1 ~ 60.0 seconds
	P/F Time	Off - 0.1 ~ (On-Time+Off-Time)-0.1
	Short-Time	Off - 0.1 ~ On-Time
	Short Ch	Off - 1~ 8 (CH1~CH8)



Note

Before a program can be created, the settings for each sequence for every channel that is to be used in the program must first be pre-configured and saved into Channel Memory (MXXX).

Sequence Settings

1. Press the FUNC key then F1 (Program) to access the Program menu.



05/04/22
16 : 50
USB

LOAD

Timing Edit for Program

PROG: 01 SEQ: 01

Memory: M001	Off-Time:	Off	
Run: Skip	P/F-Time:	Off	
On-Time 0.1	Short-Time:	Off	
Short Ch: 1	2	3	4 5 6 7 8

Chain	Active Channel	Save	Recall Default
-------	----------------	------	----------------

2. Use the Selector Knob to highlight PROG:.

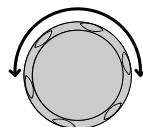

- Press the selector knob to edit PROG:, then turn to select the program number.

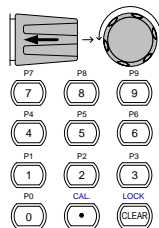

OR

Use the number pad to enter a program number.

Program: 01 ~12

- Press Enter or push the selector knob to confirm.

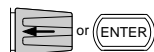

Repeat steps 2-4 to choose the sequence number (SEQ:).

Sequence: 01 ~ 10

- As sequences are executed sequentially, start at SEQ: 01.

05/04/22		LOAD		USB				
16 : 50								
Timing Edit for Program								
PROG: 01		SEQ: 01						
Memory:	M001	Off-Time:	Off					
Run:	Skip	P/F-Time:	Off					
On-Time	0.1	Short-Time:	Off					
Short Ch:	1	2	3	4	5	6	7	8
Chain	Active Channel	Save	Recall Default					

- Repeat steps 2-4 to configure the following for the current Program Sequence:

Memory: M001 ~M120

Choose which Memory data will be used for the sequence. M001 ~ M120

Run: Skip – Auto - Manual

Choose whether to run the sequence in the program automatically, skip the sequence or manually start the sequence.

On-Time: 0.1 ~ 60.0 seconds

Determines how long the sequence will run for (seconds).

Off-Time: Off – 0.1 ~ 60.0 seconds

Sets how long the sequence will stay off for (in seconds) between each sequence. Assuming Short time is not set to OFF, Off-Time will always run after On-Time.

Short Time: Off – 0.1 ~ On-Time (seconds)

Determines how long a short circuit will last (seconds). However the shorting time cannot be longer than the On-time. Short Time will start at the same time as On-time.

P/F Time: Off – 0.1 ~ (On-Time+Off-Time)-0.1 (seconds)

The Pass(P)/Fail(F) Delay Time can be set to 0.1 seconds less than the total test time. The total test time is defined as:

$$\text{On-Time} + \text{Off-Time (seconds)}$$

If Go/NoGo is turned on but the pass fail time is off, then Go/NoGo test will continue, but there will not be a specified pass/fail time window.

Short Channel: Off – 1~ 8 (CH1~CH8)

Each channel can be individually set to simulate a short circuit (CH1~8) or can have shorting disabled (Off). When Short Channel is set to Off, the channel will ignore the execution of Short-Time.

- Repeat the above steps for all ten sequences for the same (current) program.

Save Sequence

- Press F3 (Save) to save all the sequence data for all of the program.



Note

Note the program data is not yet saved into Setup Memory. If you wish to save the Program to Setup Memory see page 236.

Recall Default

- To recall the Default Program settings, press F4.



Note

If the Default is recalled, all data will be lost. This does not include the internal Setup Memory. To see the default settings, see page 293.

Timing Diagram for Single Step

Below is a timing diagram of a single step in a program.

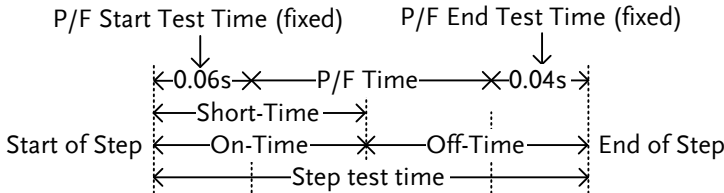

Program Chains

Background

On the PEL-2000B, there are up to 12 different programs containing 10 sequences.

If 10 sequences in a Program Sequence prove to be inadequate for testing, the PEL-2000B series can chain different programs together, effectively making a larger Program Sequence.

Unlike Program Sequences, Program Chains do not need to be run in numerical order. Up to 12 Program Sequences can be chained together

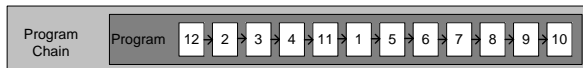

- Panel operation
1. Create 1 or more Program Sequences. Page 141
 2. If Program Sequences were created in a different session, ensure the programs have been loaded from Setup Memory. Page 236
 3. Press the FUNC key, then Program (F1), followed by Chain (F1).

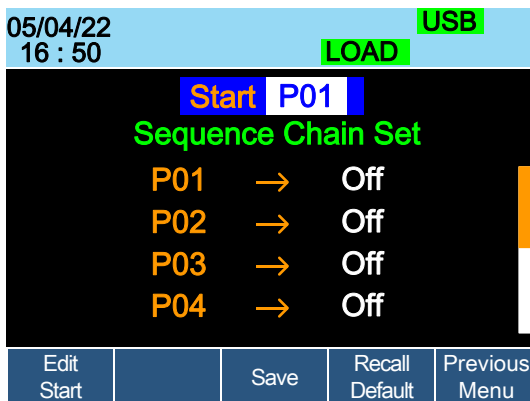
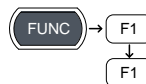

4. Press F1 (Edit Start) and use the selector knob to edit Start and confirm which Program Sequence (PXX) will start the program chain. Any Program (P01~P12) can be used to start a Program Chain.
5. Use the Selector knob to scroll down to P01 (Program 1).

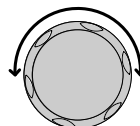
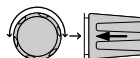

6. Use the Selector knob to choose the program that will execute after P01 (P02~P12).

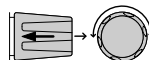

OR

Select (Off) to end the Program Chain after (P01).

OR

Select (P01) to execute after P01, this will create a continuously looping Program Chain.

P01 → Off – P01~P12

7. Repeat the above procedure to P02~P12 to complete the program chain.

The Program Chain ends at the first Program (PXX) that is followed by Off. It is possible to create continuously looping program chains.

Save Program Chain

8. Press F3 (Save) to save the program chain.

F3



Note

The Program Chain data is not yet saved into Setup Memory. If you wish to save the Program Chain to Setup Memory see page 234.

Recall Default

9. To recall the Default program chain, press F4.

F4



Note

If the Default is recalled, Start will revert to P01 and all program sequences will be set to Off.

Previous Menu

10. Press F5 (Previous Menu) to return the Sequence menu.

F5

Running a Program

Background Once a Program Chain/Program Sequence has been created, it can be executed. As Program Sequences apply to all the channels, any channels that don't need to be active (load off) can be programmed in the Active Channel menu. At Default, all channels are set to (load) Off.

EXT will be shown next to any channels set to external channel control.

- Panel operation**
1. Create 1 or more Program Sequences. Page 141
 2. Create a Program Chain. Page 149
 3. Press the FUNC key, Program (F1) and Active Channel (F2).

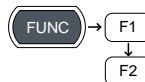

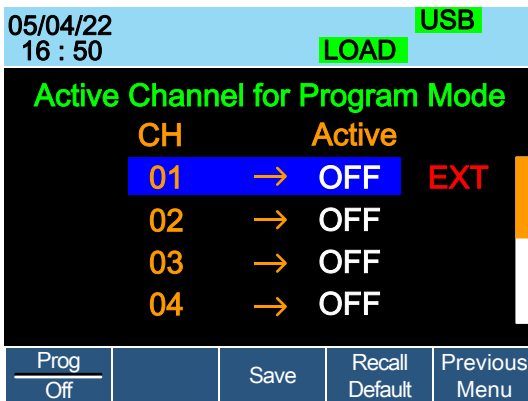

Channel 1 (CH01) will be highlighted. Note CH1 has CH CONT set to External

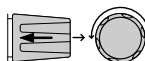

4. Edit the channel using the Selector knob.



CH 01~08: ON (activate channel) – OFF (not activated)

5. Press Enter or push the selector knob to confirm the selection.  or 

6. If needed, repeat steps 4-5 for the remainder of the channels.



Note

If all channels are Active OFF, a program cannot be run as there will be no channels active.

- Save Program 7. To save press F3.

F3

- Recall Default 8. To recall default settings press F4

F4



Note

If the Default is recalled, all channels will revert to Active OFF.

- Previous Menu 9. Press F5 (Previous Menu) to return to the Sequence menu.

F5

- Turn Program On/Off 10. Press F1 (Prog) to turn On or Off the current Program.

F1

Pressing F1 will cycle from Program On to Off.

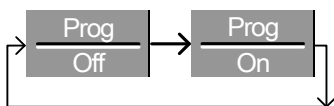

11. PROG will appear on the mainframe status panel when the program is turned on.

05/04/22
16 : 50

USB

PROG

- Run Program 12. Press the load key on the mainframe to start the Program.

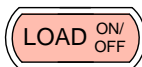

13. The Run Program screen appears, and the PROG icon turns orange.



As each sequence or program is completed the screen will update to display the active sequence/program. Notice that if a channel has been set up with Go/NoGo limits, a pass (GO) or fail (NG) will be displayed on the main display as well as the local load module display.



Note

If the Active = OFF for all the channels then “No Active Channel” will be displayed instead of channel numbers.

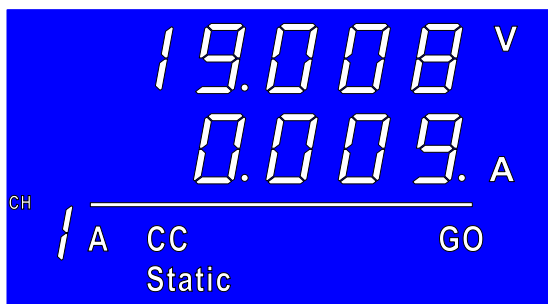

Each active load module will display the output as the program runs.

14. If Run was configured to manual in any of the program sequences, press F2 (Next) to continue the program sequence, otherwise the program will continue automatically.



15. Press F1 (Stop) at any time to abort the program when it is running.

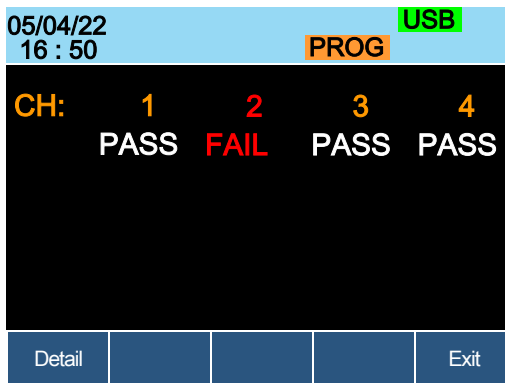

When the program has finished, the physical channels that have run will be displayed, a PASS or FAIL will be displayed if Go/NoGo testing has been set.

16. When the program has finished, press F1 to see any result details.

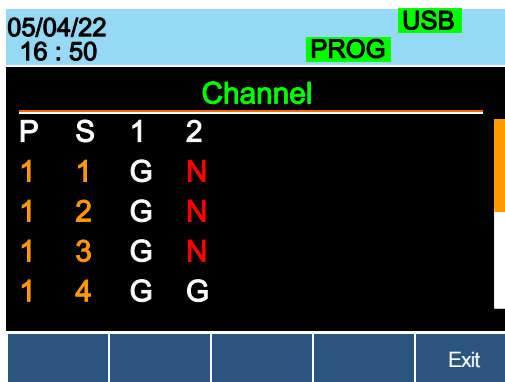

The Program (P) and Sequence (S) numbers for the Program are displayed on the left hand side and the Go/NoGo (G/N) results are displayed on the right hand side for each channel in the program.

Use the Selector knob to scroll down to view the remainder of the list if necessary.

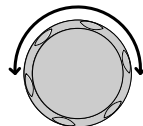

17. Press F5 to exit at any time.

A rectangular button with rounded corners containing the text "F5".

F5

Upon exiting, the previous menu before running the program will load.

Edit Sequence

Background The Sequence function can be configured to create a unique load profile to accurately simulate loads in real time for single or multiple loads. Sequence can only be used with CC static or CR static modes. For details see page 75.

Each Sequence is composed of a number of points with customizable current/resistance, slew rate and duration times. Each sequence can be looped an infinite amount of times. Sequences are only applicable for CC (Static) and CR (Static) modes.



Note

The sequence function should not be confused with program sequences. They are not the same. Program sequences cannot be used with the Sequence function and vice versa.

Parameters	Value	Setting Min ~ Setting Max Ω/A
	SlewRate	Load module dependent
	SlewRate	
	Duration Time	0.000025 ~ 60,000 seconds

- Panel operation**
1. Choose a channel and mode. Page 122, 124
 2. Press the CHAN key, F4 (Seq. Edit) to enter the Sequence Edit menu. →

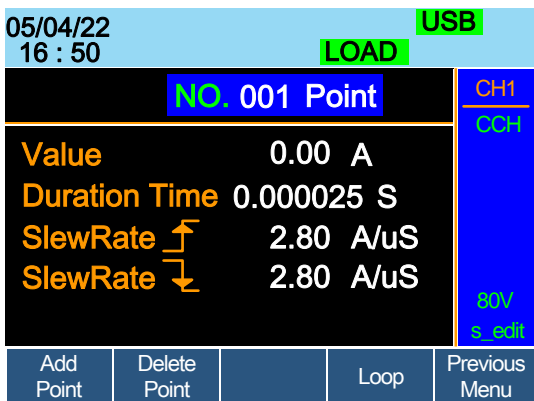

- Use the Selector knob to highlight Value.

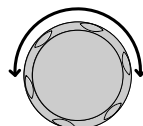

- Press the Selector knob to edit the Value, then turn to increase or decrease the value.

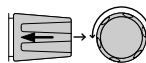

OR

- Use the number pad to enter a number.



Value **0.800** **A**

- Press the Selector knob or Enter to confirm selection.

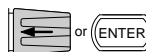

- Repeat for rising and falling Slew Rate and Duration Time.

Add Point

- To add an extra point after the current point, press Add Point (F1).

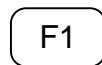

Range 001~120



Note

Add Point will insert a new point directly after the current point. The value of the current/resistance of the inserted point will be the average of the point before and after. All other settings will remain unchanged.

Delete Point

9. To delete the current point, press Delete Point (F2).



Edit previous point

10. Use the selector knob to change the current point number.

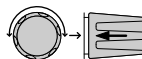

001 Point



Note

The Point number can only be changed if more points have already been added.

Save Sequence

11. Press Save (F3) to save the sequence.



Note

The save icon will only appear after a change has been made in the menu.

Create Sequence Loop

Background

Sequences can be looped a number of times. The loops can be started at any point in the sequence. The Start of Loop function determines which point will start each repeating loop.

The On End of Seq. function will hold the load current (of the selected sequence) to a designated value until all the other sequences have finished running.

CC Vrange sets the range in CC mode for Sequences. See page 75 for more details.

Ensure the menu is in the Seq. Edit menu and that a sequence has been created. See page 157

	Add Point	Delete Point	Loop	Previous Menu
Parameters	Repeat	1~9999/Infinity (0)		
	Start of Loop	001~ last point		
	On End of Seq.	OFF / Setting Min ~ Setting Max		
	CC Vrange (CC mode only)	High/Low		

- Panel operation
1. Press Loop (F4) to enter the Loop menu.

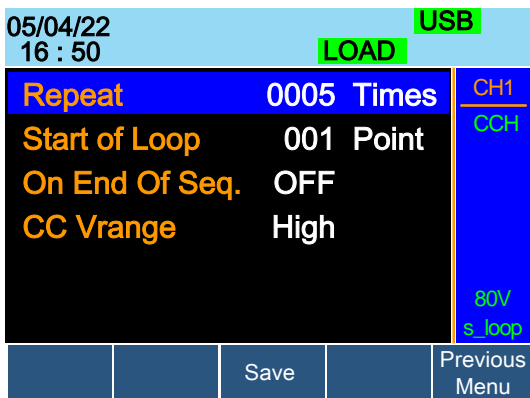
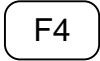

2. Use the Selector knob to highlight Repeat.

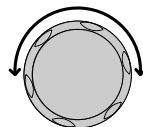

3. Press the Selector knob to edit Repeat, then turn to increase or decrease the value.

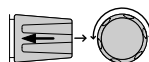

OR

4. Use the number pad to enter a number.



Select 0 to choose infinity.

Repeat 0005 Times

5. Press the Selector knob or Enter to confirm selection.

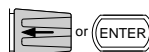

6. Repeat for the remaining parameters.

Save Loop

7. Press Save (F3) to save the loop.

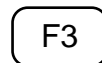

Channel Duration Time Settings

Background

Each sequence can have the timing duration data of another sequence. For example CH1's sequence can import the timing duration settings of CH2's sequence.

This is useful to quickly compare two different loads to the same timing characteristics. See page 75 for more details.

Each channel's sequence can be turned off by configuring the channel Setting to OFF. If a channel uses the same channel number, i.e. CH 01 → 01, then the duration time settings will not be altered for that channel.



At least one channel must output a Trigger Sequence Signal via PIN4 of the first frame link connector (master) if a sequence is run. For more details see page 75.

The Trigger In signal is used to start any sequence that has TRIG set to IN. The trigger input signal is input via PIN4 of the first frame link connector (slave). For more details, see page 75.

Any channels with channel control (CH CONT) set to external will be shown on the right side as EXT. See page 182 for details on setting channel control.

Parameter CH 01~08 Setting OFF ~ maximum channels
 CH 01~08 TRIG IN , OUT , IN/OUT, OFF

Ensure at least one sequence has been created and saved. Page 157

- Panel operation 1. Press FUNC, then Sequence (F2)  →  to enter the Channel Duration Time menu.

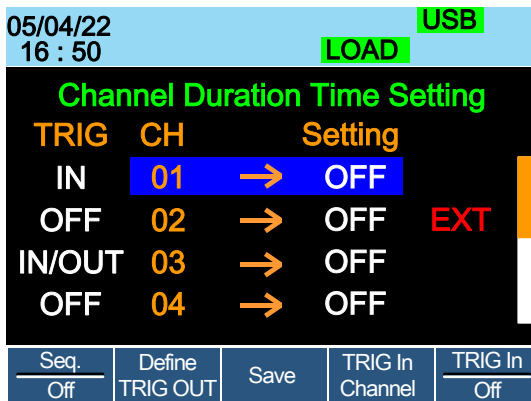

Note

CH3 is set to TRIG OUT, whilst CH1 & CH3 are set to TRIG IN. CH2 has no trigger settings and has CH CONT set to external.

2. Use the Selector knob to highlight a channel.

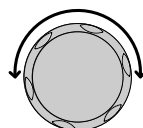

3. Press the Selector knob to edit the channel, and then turn to choose which channel's Duration Time Setting to import.

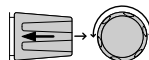

Range Ch 01~08 / OFF

01 → 01

4. Press the Selector knob or Enter to confirm selection.

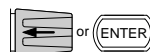

Trigger Out
Channel

5. Press Define TRIG OUT (F2) if you want the currently selected channel to output the Trigger sequence signal.

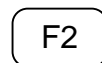

One channel must be set as the TRIG OUT channel.

Trigger In
Channel

6. Press TRIG In Channel (F4) to allow the current sequence to be triggered with the Input trigger.



Trigger In On/Off

7. To turn the Input trigger source on, press Trig In (F5).



8. Repeat the above steps for any other remaining channels.

Save settings

9. Press Save (F3) to save the settings.



Run Sequence

Background Like Programs, Sequences must be turned “ON” before they can be run.

When running a Sequence, the front panel function keys, number pad, operation keys and selector knob are disabled for the specific channel(s). The load module panel is also disabled (bar the display key) for the specific channel.

Channels that do not have a Sequence can still be edited by changing channels via the CHAN key or by using the local load module.

Ensure at least one Sequence has been created and saved. Page 157

Ensure the Channel Duration Time Settings have also been configured and that no Sequence (CH01~08) that you wish to run are set to OFF. Page 161

Panel operation 1. Press FUNC, then Sequence (F2) to enter the Channel Duration Time Setting menu. 

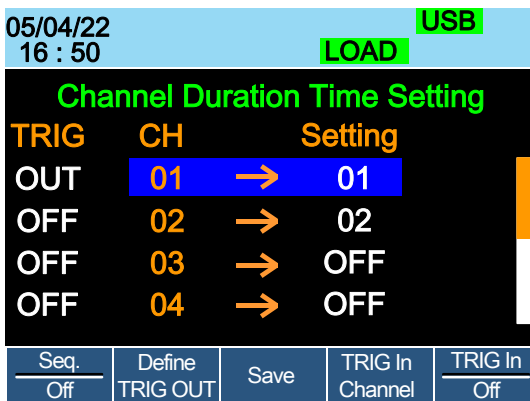

2. Press Seq. (F1) to turn on the Sequences.



3. SEQ will be displayed on the Mainframe Status panel.



4. Press the LOAD key to run all the Sequences. If a channel has TRIG set to IN, that channel will now wait for a trigger before running.

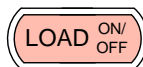

5. Run SEQ Mode will be displayed on the bottom of the display for the specific channels. On the Mainframe Status panel, SEQ will turn orange.

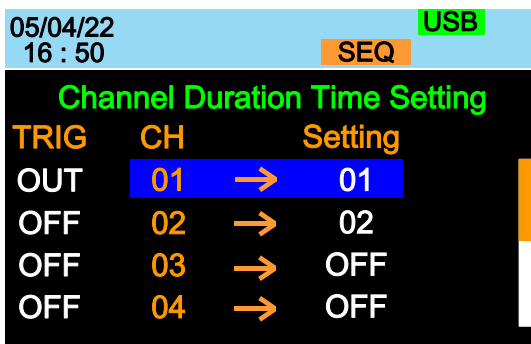

Run SEQ Mode

Stop the load

6. Press the LOAD key again or wait for the Sequence (if not infinitely looped) to end/stop the load.

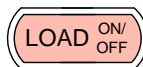

Turn off SEQ

7. Press Seq. (F1) to turn OFF the Sequence(s) when the load is not running.



Note

All UI keys/knob will be disabled for all channels that run a Sequence, bar the function keys and R/L keys.

OCP Test Automation

Background The OCP test function creates an automatic test to test the OCP of power supply products.

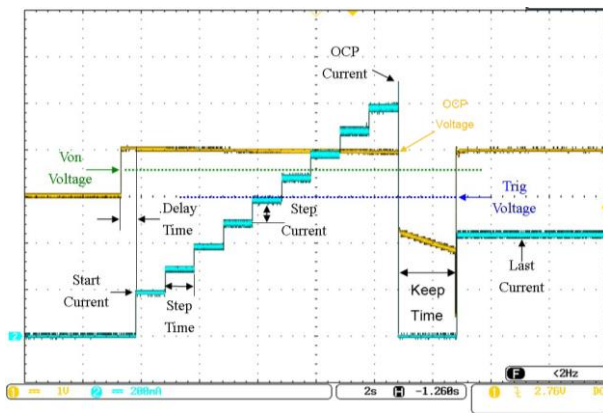

Parameters	Active Channel	Applies the setting to the load channel.
	Range	High(CC Mode High) or Low(CC Mode Low)
	Start Current(Start C)	Starting current value for the test.
	End Current(End C)	The current value that will end the test. The value must be higher than the OCP value of the DUT you are testing. This parameter is used as a fail-safe for if the over current protection of the DUT fails.
	Step Current(Step_C)	Sets the step resolution of the current.

Last Current(Last_C)	Sets the final current value after OCP has been tripped. This is the steady-state current draw after the OCP has been tripped.
Step Time(Step_T)	Sets the execution time of each step. (50mS to 1600S)
Delay Time(Delay)	The OCP testing delay time. Sets the how long to delay starting the test after the Load On key has been pressed. (0 ~ 160S)
Trig Voltage(Trig_V)	Sets the voltage trigger level needed see whether the power supply OCP has been triggered. When the power supply OCP has been triggered, its voltage output will drop. The voltage trigger level is used to test to see if the voltage output has been drop.
Keep Time(Keep_T)	Set the how long to enter the Last Current after detect the OCP.(0~160S)



Note

This mode can only be used under CC mode.

Panel operation

1. Press the FUNC key, F4 (OCP) to enter the OCP Test Automation menu.



05/04/22		FRM	USB
16 : 50		SEQ	
OCP Function		Chan: 1	
Range:	High	Step_T:	0.05
Start C:	0.000	Delay:	0.000
End C:	71.400	Trig_V:	0.0000
Step_C:	0.002	Keep_T:	0.000
Last_C:	0.000		
OCP On	Active Channel		

- Use the Selector knob to highlight the parameter you want to edit.

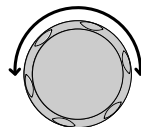

- Press the Selector knob to edit the parameter, then turn to increase or decrease the value.

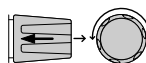

OR

Use the number pad to enter a number.



- Press the Selector knob or Enter to confirm selection.

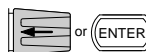

- Repeat steps 2 -4 for all the parameters.

Save the OCP Test Automation Settings

- Press Save (F3) to save the OCP Test Automation settings.

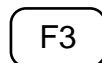

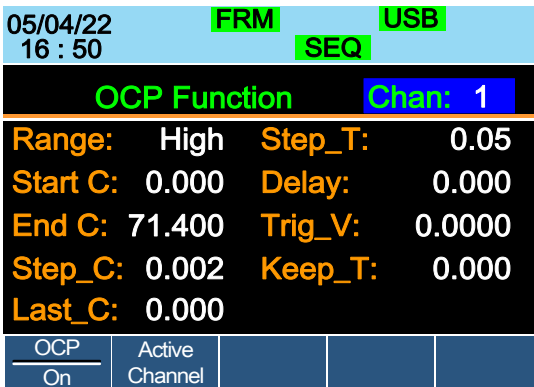

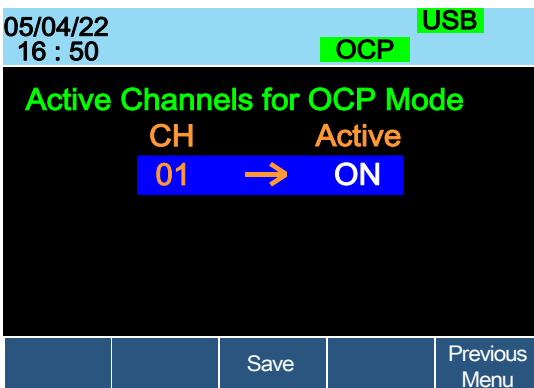
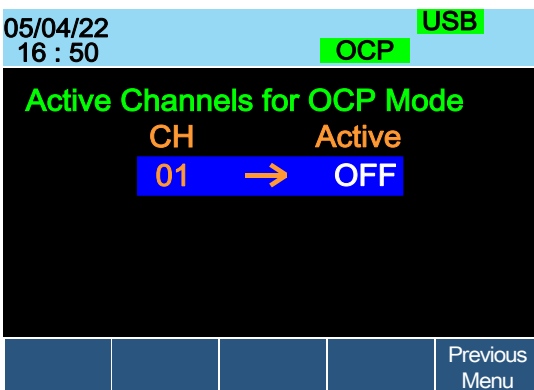

Select Active Channel

- To select the load channels for the test, press Active Channel (F2).



8. Use the selector knob to Enter key  or  to turn the Active value to ON.

Save the OCP Test Automation Channel

9. Press Save (F3) to save the OCP test automation channel.



10. Press Previous Menu (F5) to return to the OCP Test Automation menu.



11. Press OCP (F1) to turn OCP to ON.



05/04/22 16 : 50		USB	
		OCP	
OCP Function			
Chan: 1			
Range:	High	Last_C:	0.45
Start C:	0.20	Step_T:	1.00
End C:	1.50	Delay:	0.500
Step_C	0.10	Trig_V:	3.0000
OCP On	Active Channel	Save	

Save the OCP Test Automation Parameters

12. Press Save (F3) to save the OCP test automation parameters.



Start the OCP Test Automation

13. Press the Load key to start to OCP Test Automation.

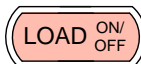

Test Results

USB
05/04/22
16 : 50
OCP

Run OCP Test

CH: 1

4.8550V
1.10A

Voltage Reading: The voltage of the DUT before the OCP was triggered.

Current Reading: The current of the DUT before the OCP was triggered.



Note

In addition to the setting the OCP test parameters as described above, the VON voltage settings must also be set according to the output characteristics of the DUT.

An OCP Test Automation example using actual current and voltage waveforms.

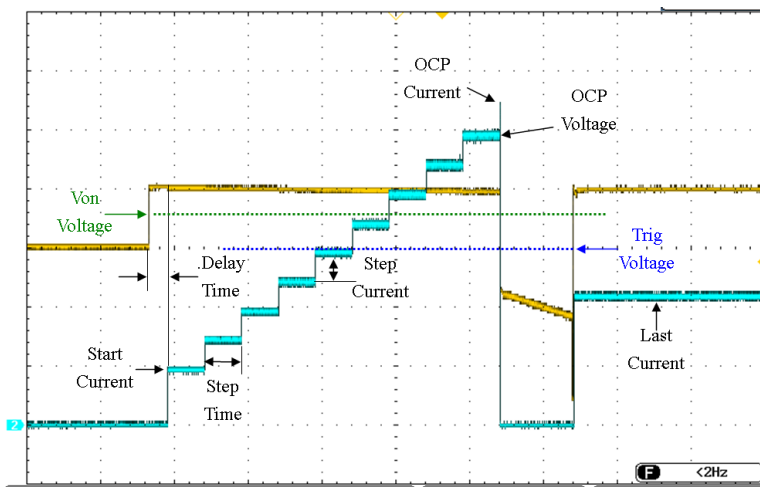



Channel Configuration

The Channel Configuration chapter describes the configuration options for individual channels. Any configuration settings that are changed only apply to the current channel, other channels will not be changed.

Accessing the Configuration Menu

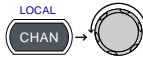
Background The configuration menu is used to access instrument settings and properties as well as set the protection levels for each channel.

- Panel operation**
1. Select the channel to be configured by pressing the CHAN key and using the Selector knob.
 
 2. Press the F5 (Configure) key to enter the configuration (Protection) menu.
 

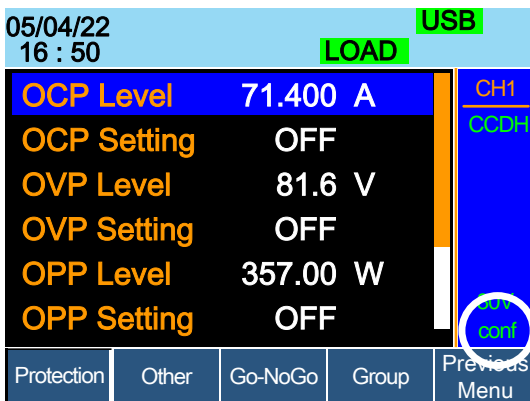

Setting (OCP/OVP/OPP/UVP)

Background Over Protection is used to set the voltage, current or power limit. In the event that the current, voltage or power exceeds the over protection settings, the load module display will show an error message and beep an alarm.

When tripped, Under Voltage Protection (UVP) will turn off the load. UVP trips when the load voltage drops below a set limit.

Only when the protection settings are set to On (XXP Setting -On) will the protection modes be active.

All protection settings can be set to 2% higher than specification rating.

Parameters	OCP Level	1.25% Rating A ~ 102% Rating A
	OCP Setting	ON/OFF/Clear
	OVP Level	1.25% Rating V ~ 102% Rating V (0.5% Rating V ~ 102% Rating V for PEL-2041B)
	OVP Setting	ON/OFF/Clear
	OPP Level	PEL-2020B : 1W ~ 102W PEL-2030B(L) : 0.9W ~ 30.6W PEL-2030B(R) : 1.25W ~ 255W PEL-2040B : 1.75W ~ 357W PEL-2041B : 1.75W ~ 357W
	OPP Setting	ON/OFF/Clear
	UVP Level	OFF ~ current using operating voltage range of slave module.
	UVP Setting	Clear
	Protection Clear	All

Panel operation Ensure the menu is the configuration menu. See page 172.

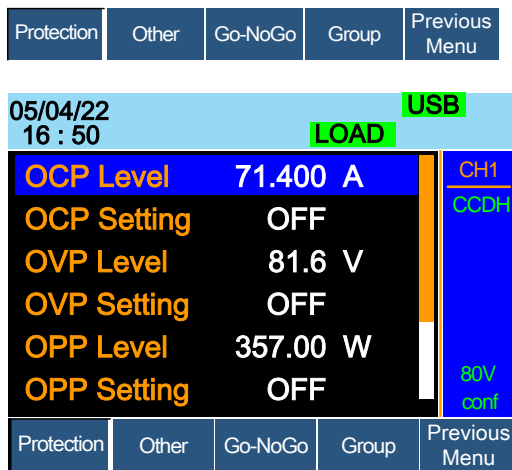

1. Use the Selector knob to highlight OCP Level.

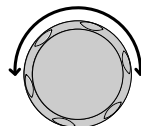

2. Press the Selector knob to edit the selected level, then turn to increase or decrease the value.

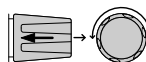

OR

3. Use the number pad to enter a number.



4. Press the Selector knob or Enter to confirm selection.

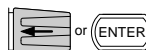

5. Use the Selector knob to highlight OCP Setting.

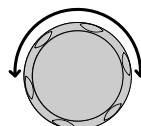

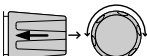
6. Use the selector knob to turn ON, OFF or CLEAR the OCP Setting. 
7. Repeat steps 1-5 for :

OCP Level	OPP Setting
OVP Level	UVP Level
OVP Setting	UVP Setting
OPP Level	

Clearing an Alarm When any of the protection settings are tripped, Alarm will be shown on the Mainframe Status Panel and an alarm tone will sound by default.



On the local load module, the protection setting that has been tripped will be displayed.

OCP	<i>0</i>	<i>C</i>	<i>P</i>
OVP	<i>0</i>	<i>U</i>	<i>P</i>
REV*	<i>r</i>	<i>E</i>	<i>U - U</i>
OPP	<i>0</i>	<i>P</i>	<i>P</i>
OTP*	<i>0</i>	<i>t</i>	<i>P</i>
CPP*	<i>C</i>	<i>P</i>	<i>P</i>
UVP	<i>U</i>	<i>U</i>	<i>P</i>

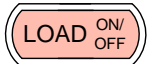
8. Turn the load off by pressing the Load key and turn off the load input. 
9. Change the XXP Setting to Clear to clear the alarm.





Note

*REV, OTP and CPP cannot be cleared using this method, the Protection Clear function must be used instead, see page 176.

See pages 58 and 275 to output alarms via the Go/NoGo output terminal.

The configuration settings only apply to the current channel.

Protection Clear

Background

When any of the protection circuits have been tripped, the Protection Clear function can be used to reset the alarms.

Alarm will be shown on the Mainframe Status Panel and an alarm tone will sound by default when any of the protection settings are tripped.

05/04/22
16 : 50

Alarm

On the local load module, the protection setting that has been tripped will be displayed.

Example: Reverse voltage protection

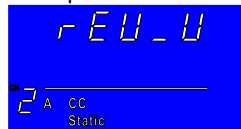

OCP	0	C	P
OVP	0	U	P
REV	r	E	U - U
OPP	0	P	P
OTP	0	t	P
CPP	C	P	P

UVP **U U P**

Panel operation Ensure the menu is in the configuration menu. See page 172.

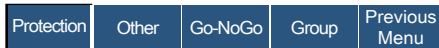

1. Turn the load off by pressing the load key if necessary.
2. Use the selector knob to scroll down to Protection Clear.

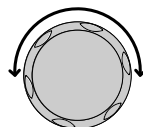
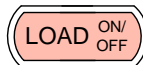

Protection Clear All

3. Press the Selector knob or Enter to clear all.

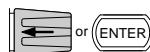

Note

The configuration settings only apply to the current channel, other channels will not be affected.

Setting the CC Voltage Range

Background The Constant Current Voltage range can be set to high or low.

Parameter CC Vrange High/Low

Panel operation Ensure the menu is in the configuration menu. See page 172.



1. Press the F2 (Other) key to enter the other menu.

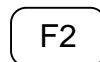

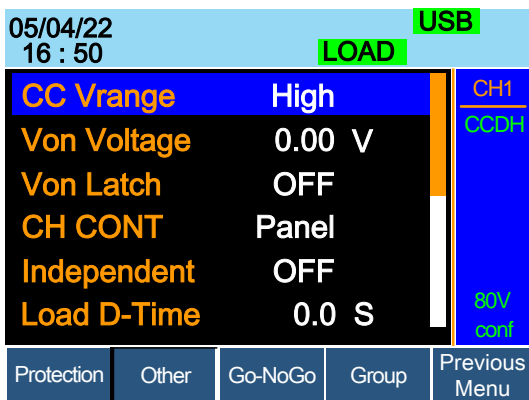

- Use the Selector knob to highlight CC Vrange.

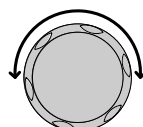

- Press the Selector knob to edit CC Vrange, then turn to increase or decrease the range.

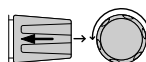

CC Vrange **High**

- Press the Selector knob or Enter to confirm selection.

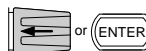

Note

The configuration settings only apply to the current channel.

Adjusting the Von Voltage and Latch

Background

The Von Voltage is the voltage point at which the load module will start to sink current. When Von latch is set to ON, the load will continue to sink current after being tripped, even if the voltage drops below the Von Voltage level. The step resolution of Von Voltage is load module dependent.

Parameters	Von Voltage	0.0~Rating volts
	Von Latch	ON/OFF

Panel operation Ensure the menu is in the configuration menu. See page 172.

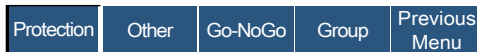

1. Press the F2 (Other) key to enter the other menu.

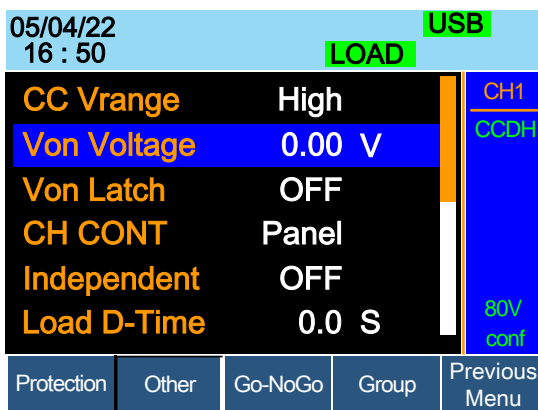

2. Use the Selector knob to highlight Von Voltage.

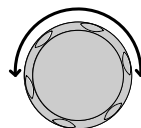

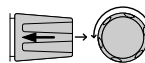

3. Press the Selector knob to edit the selected value, then turn to increase or decrease the value.



OR

Use the number pad to enter a number.



4. Press the Selector knob or Enter to confirm selection.  or 
5. Repeat steps 3 to 5 to turn Von Latch ON or OFF

For details about Von and Latch settings please see page 83.



Note

The configuration settings only apply to the current channel, other channels will not be affected.

Configuring the Short settings

Background	<p>The Short Key option is used to simulate a short circuit.</p> <p>The Short Function option is used to set whether short function is enabled or disabled.</p> <p>The Short key option can be configured to toggle (press SHORT on the load module to toggle ON or OFF) or to Hold (the SHORT key is held to short the load).</p> <p>The Short Safety option can be used to set whether short function enabled depends on Load ON or not. When setting to ON, short function enabled only when Load ON mode is enabled. When setting to OFF, short function directly enabled independent of Load ON mode.</p>	
Parameter	Short Function	ON/OFF
	Short Key	Hold/Toggle
	Short Safety	ON/OFF
Panel operation	Ensure the menu is in the configuration menu. See page 172.	

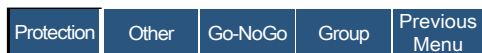

1. Press the F2 (Other) key to enter the other menu.

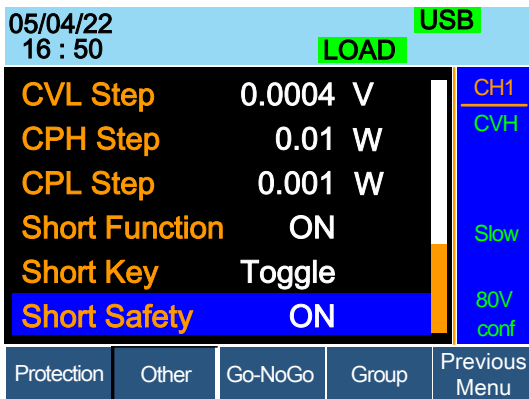

2. Use the Selector knob to highlight Short Function.

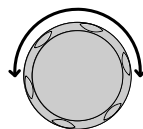

3. Press the Selector knob to edit the selected setting, turn to change the setting.

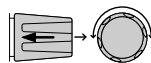

Short Function **ON**

4. Press the Selector knob or Enter to confirm selection.

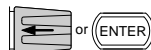

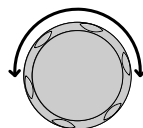

5. Use the Selector knob to highlight Short Key.



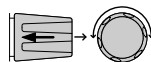

6. Press the Selector knob to edit the selected setting, turn to change the setting.



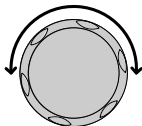

Short Key **Toggle**

7. Press the Selector knob or Enter to confirm selection.  or 

8. Use the Selector knob to highlight Short Safety. 

9. Press the Selector knob to edit the selected setting, turn to change the setting.  → 

Short Safety **ON**

10. Press the Selector knob or Enter to confirm selection.  or 

Configuring Channel Control

Background When Channel Control (CH CONT) is set to External, it will disable editing the active channel load. Instrument buttons and knobs can still be used to access the menu for the active channel or to edit other channels that do not have channel control active. This prevents settings on the active channel from being changed on the local machine. See pages 55 & 86 for details.

Parameter	CH CONT	Panel/External
------------------	---------	----------------

Panel operation Ensure the menu is in the configuration menu. See page 172.

Protection	Other	Go-NoGo	Group	Previous Menu
------------	-------	---------	-------	---------------

1. Press the F2 (Other) key to enter the other menu. 

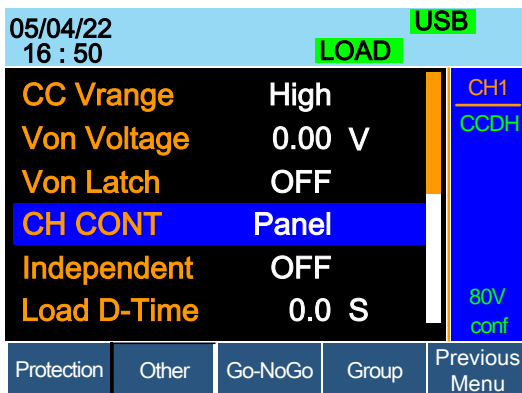

2. Use the Selector knob to highlight CH CONT.

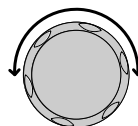

3. Press the Selector knob to edit the selected setting, turn to change the setting from Panel to External.

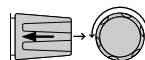

CH CONT External

4. Press the Selector knob or Enter to confirm selection.

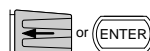

Channel control is now activated. To turn Channel Control off, CH CONT must be set to Panel again. When Channel Control is active, EXT will be displayed on the side panel for the active channel.



Note

Channel Control can only be activated on the active channel; other channels will not be affected.

Configuring the Independent Setting

Background The Independent setting allows a channel to be load independent from the mainframe. What this means is that a load module with Independent set to ON can only load from the local load module. If the LOAD ON/OFF key is pressed from the mainframe, the channel with Independent set to ON will be unaffected by the mainframe, except when running a program.

Parameter Independent ON/ OFF

Panel operation Ensure the menu is in the configuration menu. See page 172.

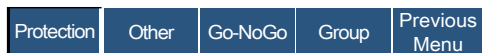

1. Press the F2 (Other) key to enter the other menu.

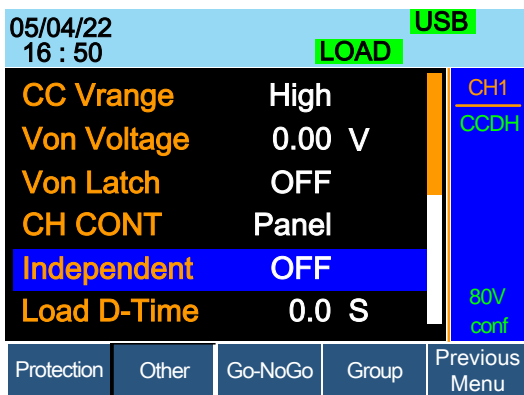
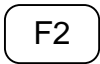

2. Use the Selector knob to highlight Independent.

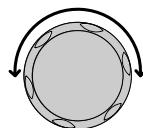

3. Press the Selector knob to edit the selected setting, turn to change the setting.

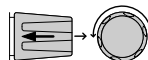

Independent **OFF**

4. Press the Selector knob or Enter to confirm selection.

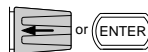

Note

When a channel has been set to independent, an asterisk (*) will be shown next to the channel number indicator in the Current Operation Channel Status panel.

The configuration settings only apply to the current channel, other channels will not be affected.



Configuring the Load Delay Time

Background The mainframe can delay loading a channel by up to 10 seconds. However the Delay Time is only applicable for manual loading. Delay Time is not applicable to Programs or Sequences.

Parameter Load D-Time 0~10 S

Panel operation Ensure the menu is the configuration menu. See page 172.

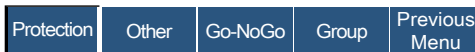

1. Press the F2 (Other) key to enter the other menu.



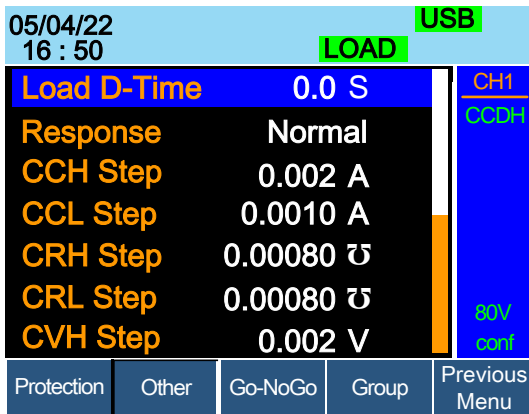

- Use the Selector knob to highlight Load D-Time.

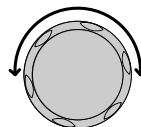

- Press the Selector knob to edit the selected setting, turn to change the setting.

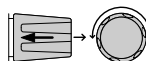

OR

Use the number pad to enter a number.



- Press the Selector knob or Enter to confirm selection.

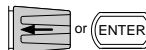

Note

The Delay Time only applies to the current channel; other channels will not be affected.

Delay time only applies when the load is manually turned on or during start up with the Auto Load On setting (page 200).

Configuring Step Resolution

Background The CC, CR, CV and CP step resolution settings can be edited in the configuration menu. These step resolution settings directly correspond to the step resolution of the coarse adjustment when setting the CC, CR, CV and CP parameters.

The minimum and maximum step resolution that can be set for each channel is dependent on the load module. For more information on step resolution see page 83.

Step Resolution		Minimum* ¹	Maximum* ²	Unit
PEL-2020B	CCH Step	HR/20000	HR/2	Amperes A
	CCL Step	LR/20000	LR/2	Amperes A
	CRH Step	HR/40000	HR/2	Siemens \bar{U}
	CRL Step	LR/40000	LR/2	Siemens \bar{U}
	CVH Step	HR/40000	HR/2	Voltage V
	CVL Step	LR/40000	LR/2	Voltage V
	CPH Step	HR/10000	HR/2	Watt W
	CPL Step	LR/10000	LR/2	Watt W
PEL-2030B (L)	CCH Step	HR/40000	HR/2	Amperes A
	CRH Step	HR/40000	HR/2	Siemens \bar{U}
	CRL Step	LR/40000	LR/2	Siemens \bar{U}
	CVH Step	HR/40000	HR/2	Voltage V
	CVL Step	LR/40000	LR/2	Voltage V
	CPH Step	HR/30000	HR/2	Watt W

PEL-2030B (R)	CCH Step	HR/40000	HR/2	Amperes A
	CCL Step	LR/40000	LR/2	Amperes A
	CRH Step	HR/40000	HR/2	Siemens Ū
	CRL Step	LR/40000	LR/2	Siemens Ū
	CVH Step	HR/40000	HR/2	Voltage V
	CVL Step	LR/40000	LR/2	Voltage V
	CPH Step	HR/25000	HR/2	Watt W
	CPL Step	LR/25000	LR/2	Watt W
PEL-2040B	CCH Step	HR/35000	HR/2	Amperes A
	CCL Step	LR/35000	LR/2	Amperes A
	CRH Step	HR/40000	HR/2	Siemens Ū
	CRL Step	LR/40000	LR/2	Siemens Ū
	CVH Step	HR/40000	HR/2	Voltage V
	CVL Step	LR/40000	LR/2	Voltage V
	CPH Step	HR/35000	HR/2	Watt W
	CPL Step	LR/35000	LR/2	Watt W
PEL-2041B	CCH Step	HR/20000	HR/2	Amperes A
	CCL Step	LR/20000	LR/2	Amperes A
	CRH Step	HR/40000	HR/2	Siemens Ū
	CRL Step	LR/40000	LR/2	Siemens Ū
	CVH Step	HR/50000	HR/2	Voltage V
	CVL Step	LR/50000	LR/2	Voltage V
	CPH Step	HR/35000	HR/2	Watt W
	CPL Step	LR/35000	LR/2	Watt W

^{*1} HR = High range rated value, LR = Low range rated value.

^{*2} Maximum value = HR (LR)/2 * 1.02.



Note

Use the Shift key to toggle between coarse and fine adjustment mode when editing the CC, CR, CV and CP values with the Selector knob on the main display. The fine adjustment resolution varies between the function and load module used.

Coarse mode:

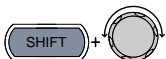

Fine mode:

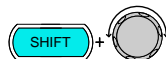

Panel operation Ensure the menu is the configuration menu. See page 172.

Protection	Other	Go-NoGo	Group	Previous Menu
------------	-------	---------	-------	---------------

1. Press the F2 (Other) key to enter the other menu.



05/04/22				USB
16 : 50				LOAD
Response	Normal			CH1
CCH Step	0.002 A			CCDF
CCL Step	0.0010 A			
CRH Step	0.00080 \bar{u}			
CRL Step	0.00080 \bar{u}			
CVH Step	0.2 V			80V conf
Protection	Other	Go-NoGo	Group	Previous Menu

2. Use the Selector knob to scroll down to highlight CCH Step.

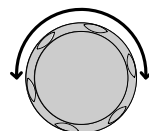

Note

CCH Step is off-screen when entering Other menu.

- Press the Selector knob to edit the selected setting, turn to change the setting.

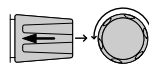

OR

- Use the number pad to enter a number.



CCP Step **0.002 A**

- Press the Selector knob or Enter to confirm selection.

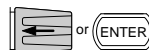

- Repeat steps 2-4 to edit the step resolution of:

CCL Step	CVH Step	CPH Step
CRH Step	CVL Step	CPL Step
CRL Step		



Note

The Step resolution settings only apply to the active channel, other channels will not be affected.

Configuring Response Time

Background The Response time setting is used to limit current draw when input voltage less than 1V. The Response setting sets the bandwidth of the load to Fast (20kHz) or as Normal (200Hz).

Parameters Response Normal, Fast

Panel operation Ensure the menu is the configuration menu. See page 172.

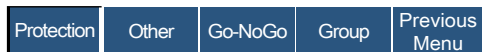

- Press the F2 (Other) key to enter the other menu.

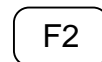

05/04/22 16 : 50		LOAD	USB
Response	Normal	CH1 CCDH	
CCH Step	0.002 A	80V conf	
CCL Step	0.0010 A		
CRH Step	0.00080 ̄		
CRL Step	0.00080 ̄		
CVH Step	0.002 V		
Protection	Other	Go-NoGo	Group
			Previous Menu

- Use the Selector knob to scroll down to highlight Response.

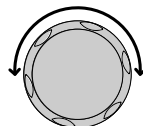

Note

Response is off-screen when entering Other menu.

Response Normal

- Press the Selector knob or Enter to confirm selection.

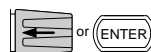

Note

The Response settings only apply to the active channel, other channels will not be affected.

Go/NoGo

Background

Go/NoGo mode is used to set threshold limits. When a load is within the limit(s) it is considered to be “Go”, when the load has exceeded the limit it is considered to be “NoGo”.

Go/NoGo limits can be set as either absolute values (Entry Mode set to “Value”) or as a percentage offset from a nominal (Center) value (Entry Mode set to “Percent”).

Go/NoGo can be used in both high and low ranges, as well as CC, CV, CR and CP Modes. The Go/NoGo status can be read using the rear Go/NoGo output.

A delay time can also be imposed for up to 1 second.



Note

Any Go/NoGo configuration only applies to the current channel with the same mode and range.

Parameters	Entry Mode	Value	Percent
CC Mode	High:	V	High: %
CR Mode	Low:	V	Low: %
			Center: V
CV Mode	High:	A	High: %
CP Mode	Low:	A	Low: %
			Center: A
Delay Time	0.0~1.0 seconds		
SPEC Test	ON/OFF		

Panel Operation Ensure the menu is in the Configuration menu. See page172.

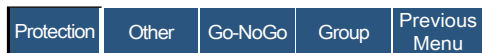

Choose Absolute/ Percentage limits 1. Press (F3) Go-NoGo to access the Go/NoGo menu.

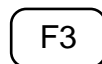

2. Use the selector knob to edit Entry Mode.

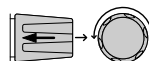

3. Choose Value for absolute limits or Percent for percentage offset limits.

Entry Mode Value

Or

Entry Mode Percent

- The menu changes according to the selection.

Value

Percent

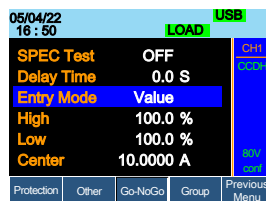
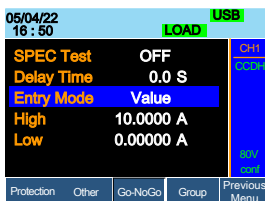

- Use the Selector knob and number pad to edit Delay time, High, Low and Center (Percent mode only).

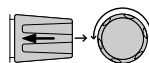

- Press the selector knob or Enter to confirm each value.

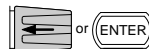

Turn Go/NoGo On/Off

- Use the Selector knob to edit Spec Test.

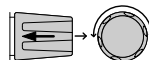

- Choose ON to turn on Go/NoGo.

SPEC Test ON

- Choose OFF to turn off Go/NoGo.

SPEC Test OFF

When SPEC test is set to ON, SPEC will be displayed in the Current Operation Channel Status panel.



Group Unit

Background

The Group Unit menu allows load modules of the same type and rating to be configured as a single unit when used in parallel. Up to 4 load modules can be used in this mode.

Operating the PEL-2000B series load modules in Group Unit mode is almost identical to using the load modules separately. The only difference is that the channel configuration only needs to be setup for channel 1 and not individually for each channel.

There are two mode types: Para and Sync. The Para setting allows the all the parallelized load modules to be operated as a single large load module. Sync mode allows the settings of a single unit to be synchronized across all the other parallelized load modules.

The Display Mode will determine which parameters are displayed on the local load modules.



Note

Only CC or CR mode can be used in Group Unit.

For the single channel load modules, PEL-2040B and PEL-2041B are fully support these two modes (Para, Sync) of group function.

The PEL-2030B does not support group function.

The dual channel of PEL-2020B does support group function partially. It can support to group 2 units of same module under the Sync mode only. That means the PEL-2020B can be 2chx100W or 1chx200W.

Ensure the same firmware used for both units.

Parameters

Total Unit 2/3/4/OFF

Group Mode Para/Sync

Display Mode V,I /V,W/I,W/S



Note

If "Total Unit: 2" is set on a 4-channel mainframe, the modules of channels 3 and 4 won't be set to the group unit function.

Panel Operation

1. Ensure current channel is selected Page 123 as the active channel.
2. Ensure the menu is in the Configuration menu. See page 172.



Parallel Setup

3. Press (F4) Group to access the Group menu.



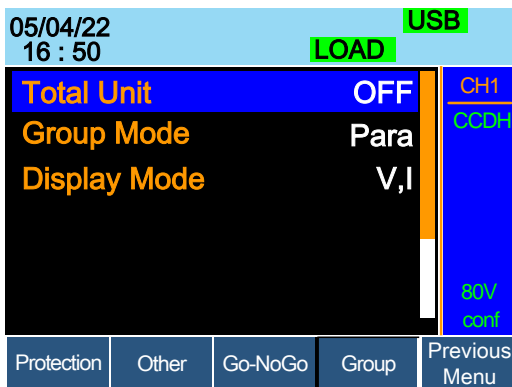

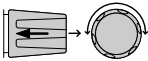
- Use the Selector knob to change Total Unit from the OFF setting to the number of parallel units. 

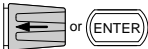

- Press the selector knob or Enter to confirm. 

Parallel Mode

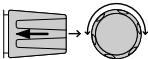
- To change the type of mode, use the Selector knob to edit Group Mode. 
- Choose Para to operate the units as a single large load module, or choose Sync to synchronize the load settings across each parallel unit.

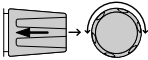

Display Mode

- Use the selector knob to change the display settings on the local load modules. 
- Choose from V, I / V, W / I,W or S.



When Para Unit is active, an indicator will be displayed on the screen. The indicator depends on the Group Mode. P will be displayed for Para Mode and S will be displayed for Sync Mode.

CHXP Para Mode

CHXS Sync Mode



The PEL-2000B is now ready to operate in Parallel Mode.

Turn Parallel
Mode Off

10. To disable Parallel Mode, use the selector knob to change Total Unit to OFF.

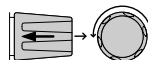

Total Unit

OFF

Mainframe Configuration

The Mainframe Configuration chapter describes configuration settings that apply to all channels and general interface settings.

Accessing System Information

Background The System Information displays the mainframe and load module(s) serial numbers.

Parameters

MainFrame Ver: Mainframe firmware version.

PEL-200X SN: Mainframe Serial number.

SlotX(Y)Ver: The version number of the Xth load module occupying the Xth slot with channel number Y.

PEL-20XX SN: The serial number and module model of the Xth load module

Y designates the channel of each installed load module. For example if dual channel load modules are installed, then Ch (1,2) will be used for the firmware and serial number.

Panel operation 1. Press the Shift Key then the Help key to access the Utility menu/System Info menu.



05/04/22		LOAD		USB
16 : 50				
MainFrame Ver: 3.XX XXXX				
PEL-2002 SN: EJXXXXXX				
Slot1(1)Ver: 3.XX				
PEL-2041 SN: EJXXXXXX				
Slot2(2)Ver: 3.XX				
PEL-2041 SN: EJXXXXXX				
System Info	Load	Interface	Time Set	Other



Note

If you have set Memo through command, you can see the Memo information by pressing System Info (F1) once again. (Please refer to the chapter contains commands “:MEMo” and “:CHANnel:MEMo” in the programming manual for details)

05/04/22		LOAD		USB
16 : 50				
MainFrame (PEL-2004B) MEMO:				
No Memo				
CH1 (PEL-2040B) MEMO:				
123				
CH2 (PEL-2040B) MEMO:				
123				
System Memo	Load	Interface	Time Set	Other



Accessing the Load Menu

Background The PEL-2000B series is able to automatically start loading from the last program or load setting.

If Auto Load On is set to Load, the last load setup used before the machine was reset will automatically start to load upon startup.

If Program is set as the Auto Load On configuration, the last program executed will start upon the next start up.

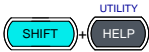
Parameters Auto Load ON/OFF
 Auto Load On Load/Program

- Panel operation**
1. Press the Shift Key then the Help key to access the Utility menu. 
 2. Press F2 (Load). 

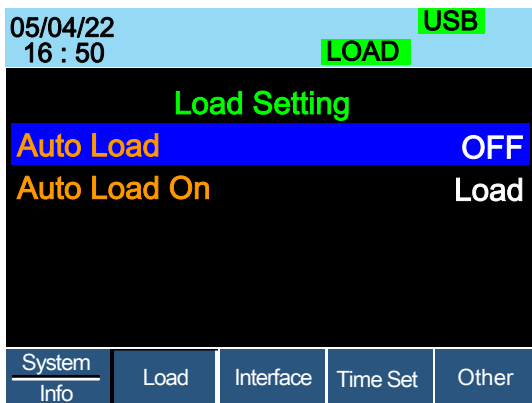

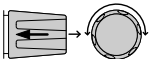
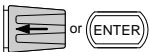
3. Press the Selector knob, then turn to choose Auto Load. 
4. Press the Selector knob or Enter to confirm selection. 

5. Scroll to Auto Load On and choose Load or Program for the next time the PEL-2002B starts up.

Adjusting the Speaker

Background The PEL-2000B series has an internal speaker for both the mainframe and load modules. The speaker function turns On/Off the sound for the UI (key presses and scrolling). The speaker setting will not alter the sound for protection alarms or Go/NoGo alarms.

Parameter Speaker ON/OFF

Panel operation 1. Press the Shift Key then the Help key to access the Utility menu.



2. Press F5 (Other Menu).

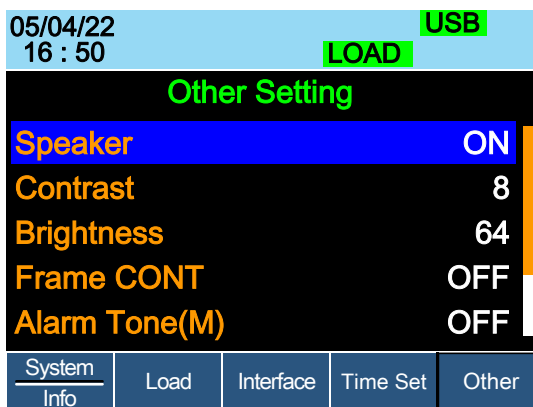

3. Use the Selector knob to highlight Speaker.

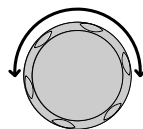

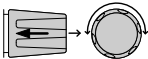
4. Press the Selector knob to edit Speaker, then turn to change from On to Off and vice versa. 

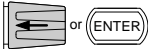

Speaker **ON**

5. Press the Selector knob or Enter to confirm selection. 

Adjusting the Display Settings

Background The PEL-2000B series has a TFT LCD display. The display brightness and contrast can be controlled via the utility menu.

Parameters	Brightness	50~90	50(low)	90(bright)
	Contrast	3~13	3(low)	13(high)

- Panel operation**
1. Press the Shift Key then the Help key to access the Utility menu. 
 2. Press F5 (Other Menu). 

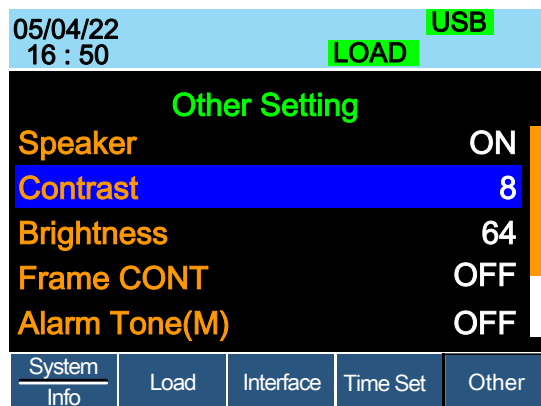

- Use the Selector knob to highlight Contrast.

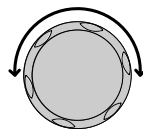

- Press the Selector knob to edit contrast, then turn to increase or decrease the value.

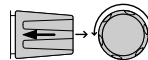

Contrast

8

- Press the Selector knob or Enter to confirm selection.

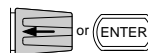

- Repeat steps 3-5 for the Brightness.

Adjusting the Frame Control

Background Frame control is used to control a number of different frame linked mainframes (slaves) with a master mainframe. For information on frame control, frame control interface and connection see pages 53 & 272.



Note

When using frame control, ensure the same firmware is installed in both master and slave units.

Parameters Frame CONT ON/OFF

Panel operation 1. Connect the mainframes using a frame link connection. Page 53.

- On the master mainframe, press the Shift Key then the Help key to access the Utility menu.

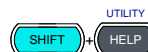

- Press F5 (Other Menu).



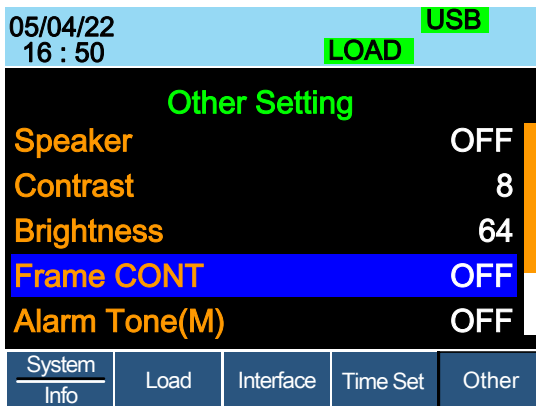

- Use the Selector knob to highlight Frame CONT.

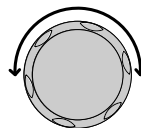

- Press the Selector knob to edit, then turn to turn Frame CONT (frame control) ON or OFF.

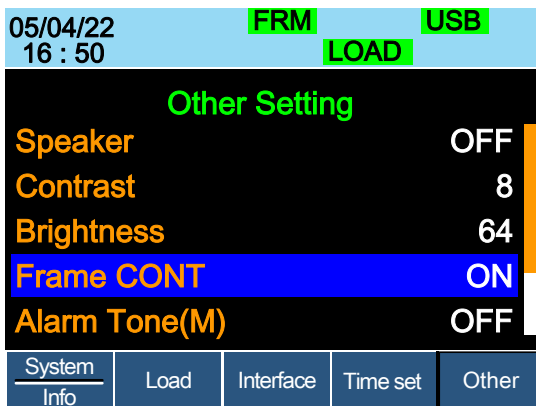
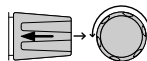

When Frame CONT is set to ON the mainframe will display FRM (Master) or FRS (Slave) on the top of the display.

- Repeat the above steps for any connected slave mainframe units.

Frame control is now ready for both master and slave mainframes.



Adjusting the Knob Control Type

Background The mainframe control knob can be set to “Update” or “Old” mode.

When setting to Update mode, rotating the mainframe knob will change the setting value of load module at the same time.

When setting to Old mode, rotating the mainframe knob won’t change the setting value of load module unless pressing the knob or Enter key.

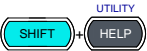
Parameter	Knob Type	Updated/Old
------------------	------------------	--------------------

- | | | |
|------------------------|--|---|
| Panel operation | 1. Press the Shift Key then the Help key to access the Utility menu. |  |
| | 2. Press F5 (Other Menu). |  |

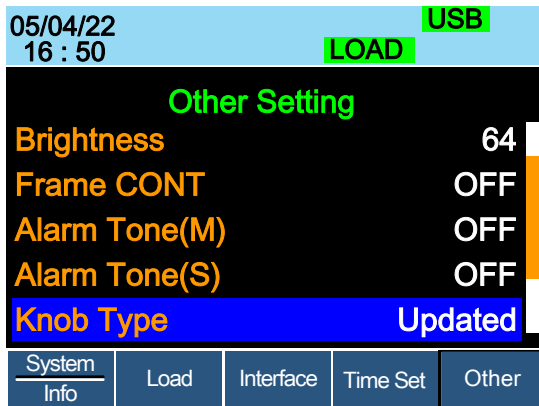

- Use the Selector knob to move the cursor down to Knob Type (below the initial screen).

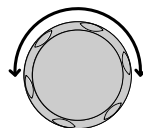

- Press the Selector knob to highlight Knob Type, then turn to change to Old/Updated.

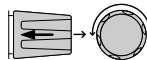

Knob Type Updated

- Press the Selector Knob or Enter to confirm selection.

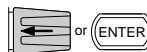

Configuring Alarm Sound

Background The PEL-2000B series has two different types of alarms, one located on the mainframe (Alarm Tone M) and one for each load module (Alarm Tone S).
Alarm Tone (M)/(S) can individually be set ON or OFF.

Parameter	Alarm Tone(M)	ON/OFF
	Alarm Tone(S)	ON/OFF

- Panel operation**
- Press the Shift Key then the Help key to access the Utility menu.
 - Press F5 (Other Menu).



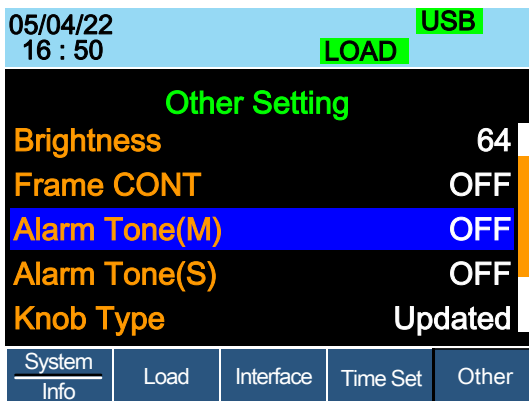

3. Use the selector knob to highlight Alarm Tone(M)

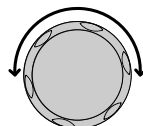

4. Press the Selector knob to select the master alarm (Alarm Tone (M)), turn to edit and press to confirm selection.

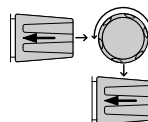

Alarm Tone(M) ON

5. Repeat the steps to edit the slave alarm (Alarm Tone(S)).

Configuring Go/NoGo Alarm Sound

Background When any Go/NoGo limits are tripped from any channel, a tone can be set as an alarm.

The Go_NoGo tone alarm settings apply to all channels.

Parameter Go_NoGo Tone ON/OFF

- Panel operation**
1. Press the Shift Key then the Help key to access the Utility menu.

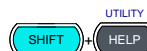

2. Press F5 (Other Menu).

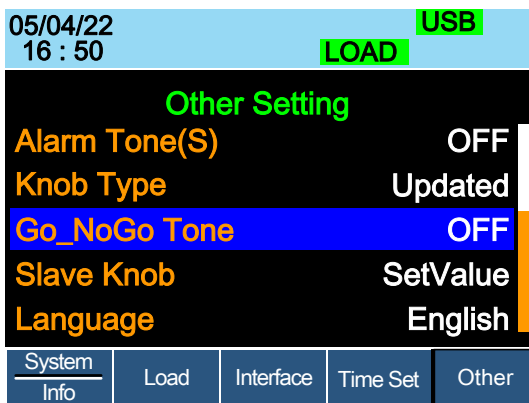

3. Use the Selector knob to move the cursor down to Go_NoGo Tone (below the initial screen).

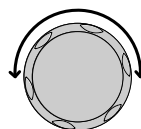

4. Press the Selector knob to highlight Go_NoGo Tone, then turn to change to ON/OFF.

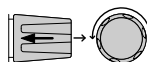

5. Press the Selector Knob or Enter to confirm selection.

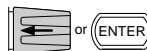

Adjusting Slave Knob Settings

Background

Channel loads can be edited using the local load module or the Mainframe. When using the slave knob to edit a load, the load module display can be set to two different types: SetValue and Measured.

When a load is ON, SetValue will always display

the set value (A Value, B Value) on the local load module display whilst “Measure” will show the actual measured value when editing the load. These settings apply to all channels.

The “Measure” setting can be temporarily disabled by pressing the Slave Knob to display the “SetValue” instead of the “Measure” value in the local load module display.

Parameter	Slave Knob	Measure/SetValue
-----------	------------	------------------

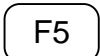
- Panel operation
1. Press the Shift Key then the Help key to access the Utility menu. 
 2. Press F5 (Other Menu). 

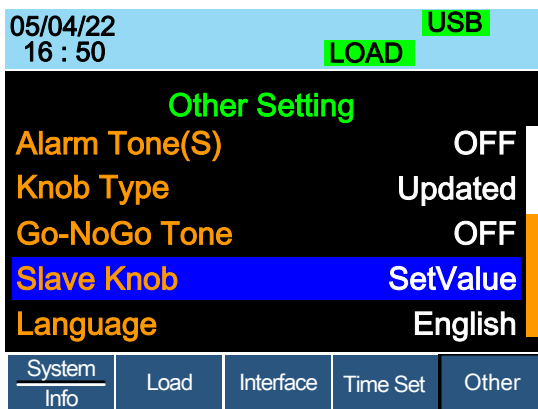

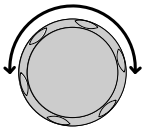
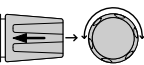
3. Use the Selector knob to move the cursor down to Slave Knob (below the initial screen). 
4. Press the Selector Knob to highlight Slave Knob, then turn to change to Measure/SetValue. 

Slave Knob **SetValue**

5. Press the Selector Knob or Enter to confirm selection.

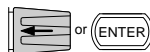

View Language Settings

Background The language settings can be viewed in the Utilities menu.

- Panel operation**
1. Press the Shift Key then the Help key to access the Utility menu.
 2. Press F5 (Other Menu).

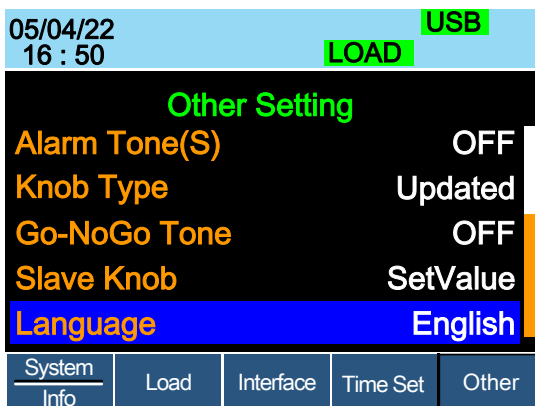

3. Use the Selector knob to move the cursor down to Language (below the initial screen).

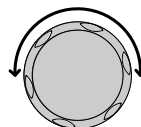

Adjusting the High Resolution

Background **ON:** When there is difference between the measured value of voltage, current or power which displayed on the module panel and the setting value, the system will fine tune the load value so that the measured value close to the setting value. The system will perform and complete this action after loading is on in one second.

OFF: The system won't perform any action when there is difference between the measured value of voltage, current or power which displayed on the module panel and the setting value.

Parameter **High Resolution** **ON/OFF**

- Panel operation**
1. Press the Shift Key then the Help key to access the Utility menu.
 2. Press F5 (Other Menu).

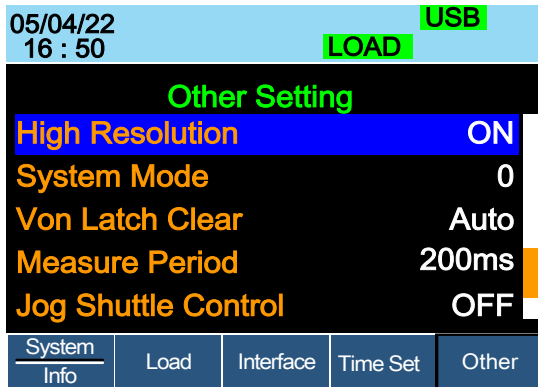
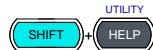

- Use the Selector knob to highlight High Resolution.

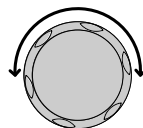

- Press the Selector knob to edit High Resolution, then turn to change from ON to OFF and vice versa.

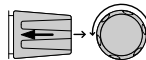

High Resolution ON

- Press the Selector knob or Enter to confirm selection.

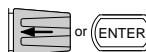

Adjusting the System Mode

Background

1: When any command is received, the Master panel will automatically enter the Remote fast mode.

0: The Master panel won't automatically enter the Remote fast mode.



Note

For details about remote mode fast/normal, please refer to command :UTILity:REMote:MODE in the programming manual.

Parameters

System Mode 0/1

Panel operation

- Press the Shift Key then the Help key to access the Utility menu.
- Press F5 (Other Menu).

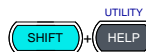

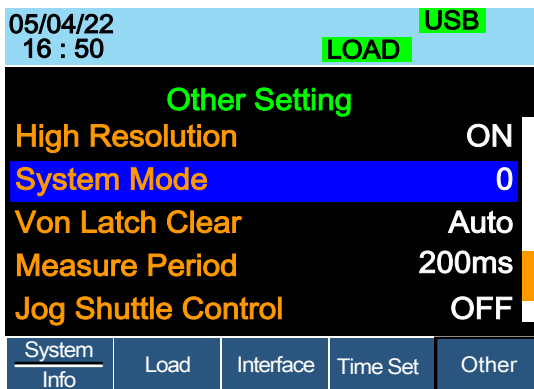

3. Use the Selector knob to highlight System Mode.

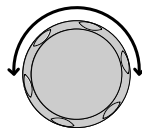

4. Press the Selector knob to edit System Mode, then turn to change from 0 to 1 and vice versa.

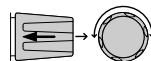

System Mode 0

5. Press the Selector knob or Enter to confirm selection.

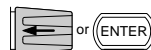

Adjusting the Von Latch Clear

Background

Auto: Load starts when the terminal voltage of module is higher than Von value. The system stops loading when the terminal voltage of module is close to 0V for more than 25ms and system is under the state of detecting Von again.

Manual: The load starts when the terminal voltage of module exceeds the Von setting value. Loading keep going even if the terminal voltage of module close to 0V.

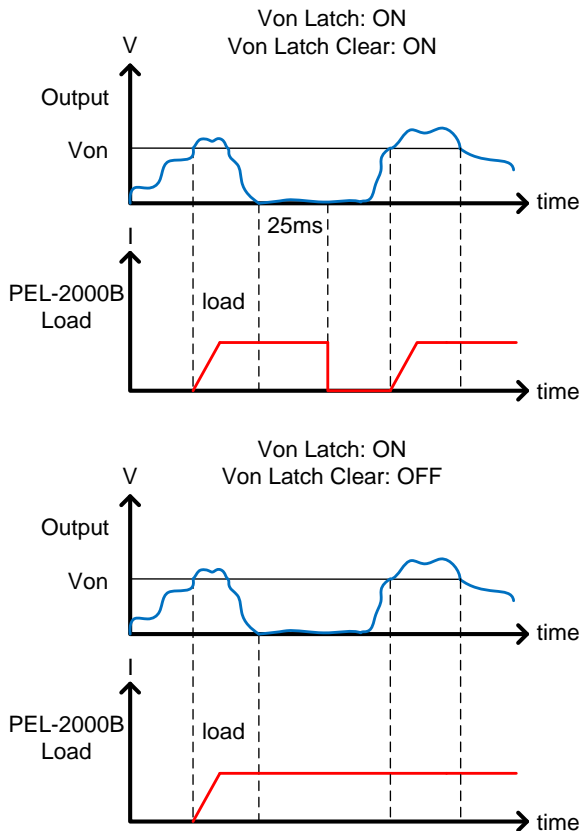

Note

This feature is only available when Von Latch is set to ON.

Parameters

Von Latch Clear Auto/Manual

Panel operation

1. Press the Shift Key then the Help key to access the Utility menu.

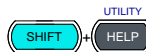

2. Press F5 (Other Menu).



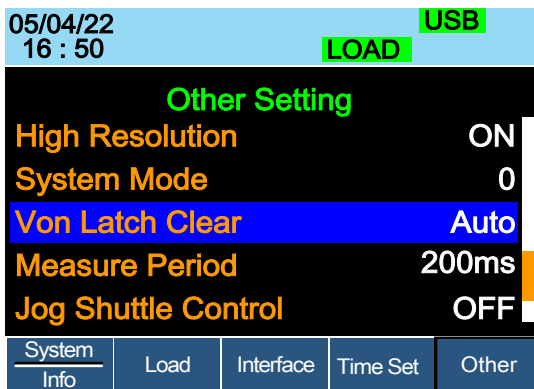

3. Use the Selector knob to highlight Von Latch Clear.

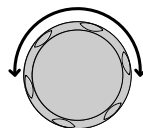

4. Press the Selector knob to edit Von Latch Clear, then turn to change from Auto to Manual and vice versa.

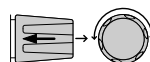

Von Latch Clear **Auto** |

5. Press the Selector knob or Enter to confirm selection.

Adjusting the Measure Period

Background You can select a measure sample rate through this setting. 200ms or 20ms are available for voltage and current sampling rate.

Parameter Measure Period 200ms/20ms

- Panel operation** 1. Press the Shift Key then the Help key to access the Utility menu.



2. Press F5 (Other Menu).

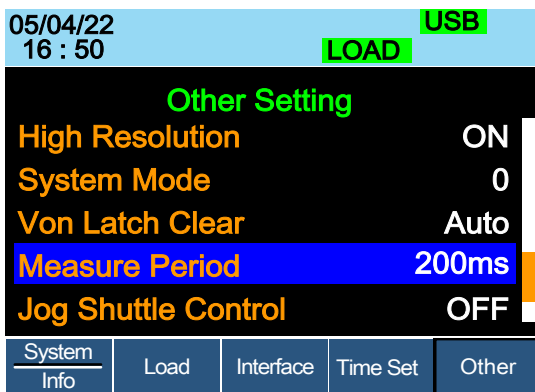

3. Use the Selector knob to highlight Measure Period.

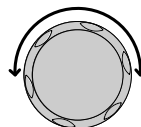

4. Press the Selector knob to edit Measure Period, then turn to change from 200ms to 20ms and vice versa.

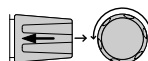

Measure Period 200ms

5. Press the Selector Knob or Enter to confirm selection.



Adjusting the Jog Shuttle Control

Background **ON:** After this setting is enabled, the settings value will be adjusted by slave knob in Jog Shuttle mode when you adjust the setting value. The interval value is adjusted according to the knob speed.

OFF: If this setting is disabled, the settings value will be adjusted by slave knob in the form of fixed compartment when you adjust the setting value.

Parameter	Jog Shuttle Control	ON/OFF
-----------	---------------------	--------

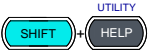
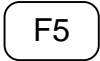
- Panel operation**
1. Press the Shift Key then the Help key to access the Utility menu. 
 2. Press F5 (Other Menu). 

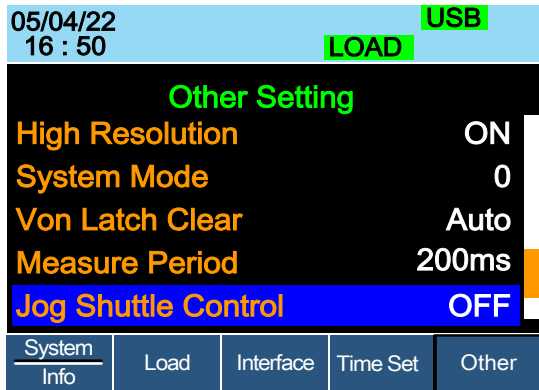

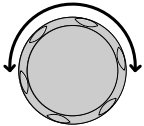
3. Use the selector knob to highlight Jog Shuttle Control 

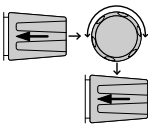
4. Press the Selector knob to edit Jog Shuttle Control, then turn to change from OFF to ON and vice versa. 

Jog Shuttle Control OFF

5. Press the Selector knob or Enter to confirm selection.

Adjusting the RVP Load Off

Background	ON: When RVP is detected, Alarm will display on the screen and stop loading. OFF: When RVP is detected, Alarm will display on the screen but loading is kept on.
------------	---

 **Note** This setting applies to all channels. But each channel independently detects RVP and performs the action of emitting alarm and stopping load.

Parameter	RVP Load Off	ON/OFF
-----------	--------------	--------

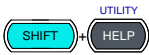
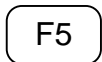
- Panel operation
1. Press the Shift Key then the Help key to access the Utility menu. 
 2. Press F5 (Other Menu). 

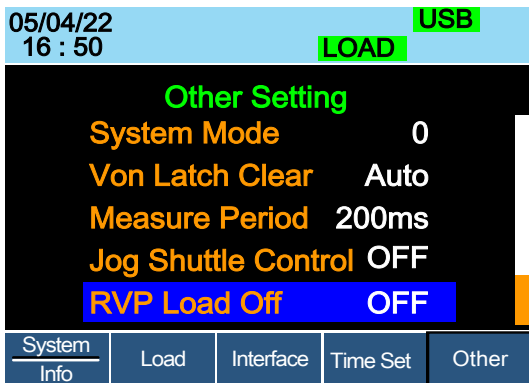

3. Use the Selector knob to highlight RVP Load Off.

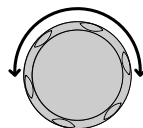

4. Press the Selector knob to edit RVP Load Off, then turn to change from OFF to ON and vice versa.

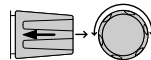

RVP Load Off OFF

5. Press the Selector Knob or Enter to confirm selection.

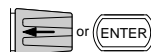

Setting the Date and Time

Description The date and time settings are used to time-stamp files when saving files.

- The date is shown on top of the display.

Parameters	Month	1~12
	Day	1~31
	Year	1990~2038
	Hour	0~23
	Minute	0~59

- Panel operation 1. Press the Shift Key then the Help key to access the Utility menu.



2. Press F4 (Date/Time Menu).



Settings: Month, Day, Year, Hour, Minute

05/04/22		RS232		
16 : 50		LOAD		
Date/Time				
Month				6
Day				15
Year				18
Hour				16
Minute				50
System Info	Load	Interface	Time Set	Other

Interface Configuration (settings)

The Interface Configuration chapter describes configuration settings that apply when using the PEL-2000B mainframe with a remote connection. There are three interface options for remote control: UART, GPIB, LAN and USB. Only one interface can be used at a time. For more details about remote control and interface connections, see the Interface section on page 267.

Configuring UART Connection

Background	When using UART a number of parameters need to be set. These include Baud rate, Stop Bit and Parity. When setting RS232/RS485 parameters, ensure they match that of the host machine.
------------	---

Parameters	Baud Rate	2400/4800/9600/19200/38400
	Stop Bit	1~2
	Parity	None/Odd/Even

UART mode	RS232 / RS485 (Switchable)
-----------	----------------------------

- | | |
|-----------------|--|
| Panel operation | 1. Press the Shift Key then the Help key to access the Utility menu. |
| | 2. Press F3 (Interface Menu). |

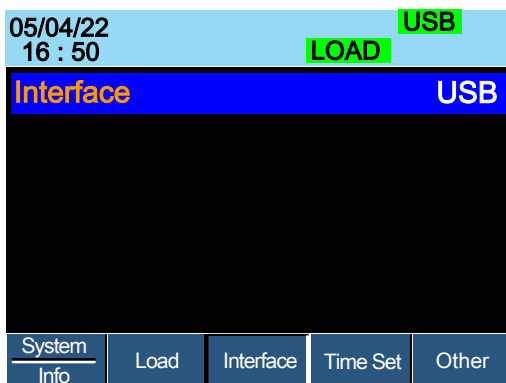
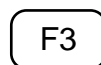
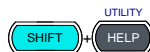

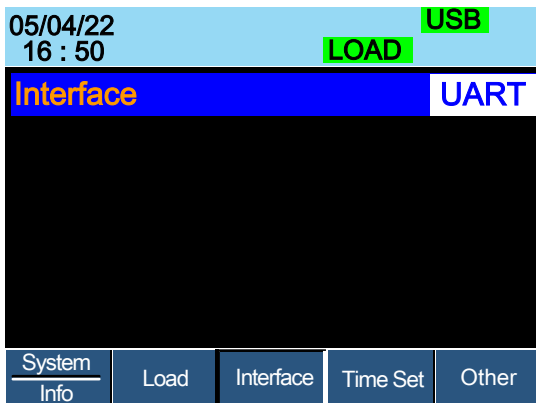

3. If the Interface is not UART, use  the Selector knob to edit Interface. 





4. Choose RS232.

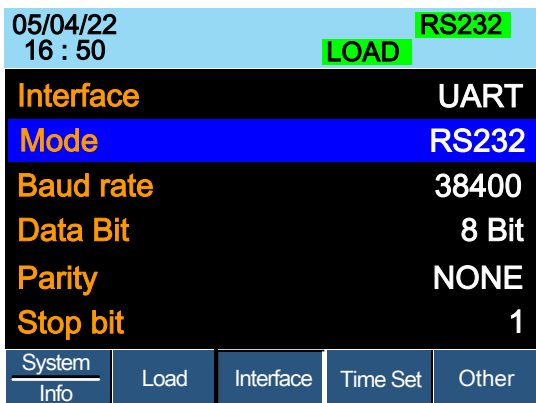

5. Press the Selector knob to confirm.  or 
6. The RS232 Menu appears.



7. Use the Selector knob to edit Baud rate, Stop Bit and Parity.  



Note



The Baud Rate, Stop Bit and Parity must match that of the host machine.

For RS232 function check, please refer to the section “UART, LAN and USB CDC function check” on page 227.

Configuring USB Connection

Background Of the three interface options, USB is the easiest to use.

USB connection	PC side connection	Type A, host
	PEL-2000B side connector	Type B, device
	Speed	1.1/2.0(full speed)

- Panel operation**
1. Press the Shift Key then the Help key to access the Utility menu.
  + 
 2. Press F3 (Interface Menu).
 

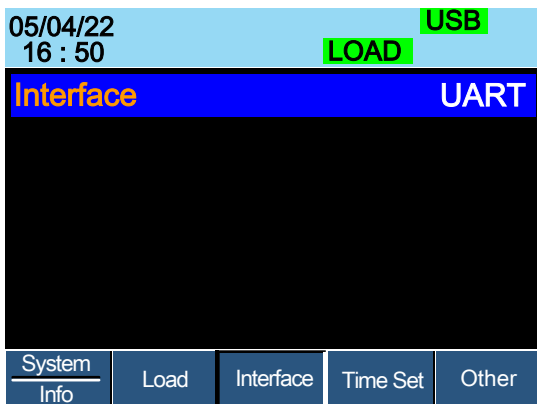

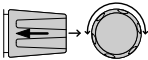
- If the Interface mode is not USB, use the Selector knob to edit Interface. 

- Choose USB.

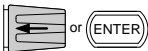

- Press the Selector knob to confirm. 

- The Interface will become USB.

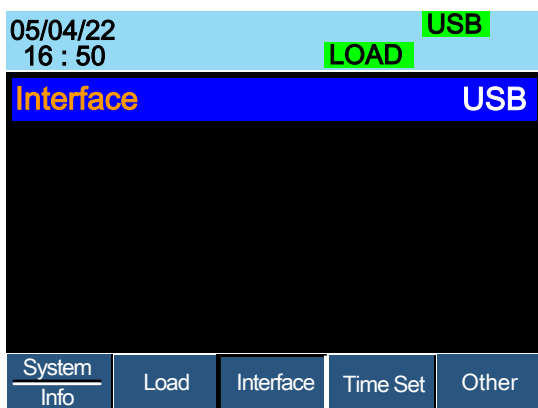

- Connect the USB cable to the USB-B slave port on the rear. 

- When the PC asks for the USB driver, select gw_pel2k.inf (downloadable from the GW Instek website, www.gwinstek.com, PEL-2000B product corner).



For USB CDC function check, please refer to the section “UART, LAN and USB CDC function check” on page 227.

Configuring the GPIB Address

Background When using GPIB, an address must be specified.

Parameters Address 01~30

Panel operation 1. Press the Shift Key then the Help key to access the Utility menu.



2. Press F3 (Interface Menu).

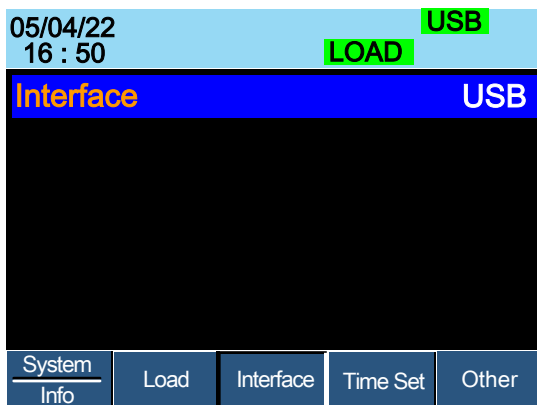
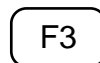

3. If the Interface mode is not GPIB, use the Selector knob to edit Interface.

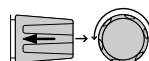

4. Choose GPIB.



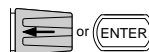

5. Press the Selector knob or Enter to confirm selection.

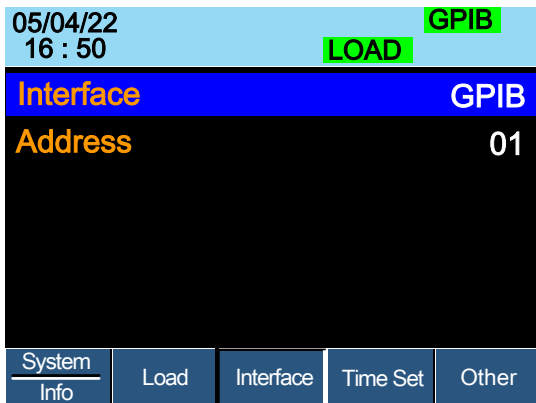

6. The GPIB menu appears.



7. Use the selector knob to edit the GPIB address.  or 

8. Edit the GPIB address.

Range 1 ~ 30

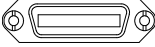
9. Connect the GPIB cable to the rear panel port: 24-pin female connector. 

- GPIB constraints
- Maximum 15 devices altogether, 20m cable length, 2m between each device
 - Unique address assigned to each device
 - At least 2/3 of the devices turned On
 - No loop or parallel connection



Note

The GPIB Address must match that of the host machine.

For GPIB function check, please refer to the section “GPIB function check” on page 230.

UART, LAN and USB CDC Function Check

Background To test the UART, LAN and USB CDC functionality, National Instruments Measurement and Automation Explorer can be used. This program is available on the NI website, www.ni.com, via a search for the VISA Run-time Engine page, or “downloads” at the following URL, <http://www.ni.com/visa/>

Requirements Operating System: Windows XP, 7, 8, 10



Note

Functionality check can only be performed after the cable connection has been completed and the PEL-2000B interface has been set.

- Functionality check**
1. Start the NI Measurement and Automation Explorer (MAX) program. Using Windows, press:
Start>All Programs>National Instruments>Measurement & Automation
 2. From the Configuration panel access, **My System>Devices and Interfaces**, select the corresponding port which is connected to PEL-2000B via USB, UART or LAN interface.
 3. In this example (NI MAX Version 18.0.0f0), we assume that PEL-2000B series is connected COM 1(ASRL1), after selecting the ASRL1::INSTR “COM1”, click the Open VISA Test Panel.

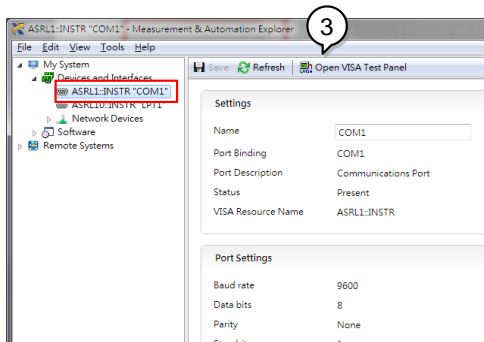

4. In the ASRL Settings page. You can see the information of Serial Settings.

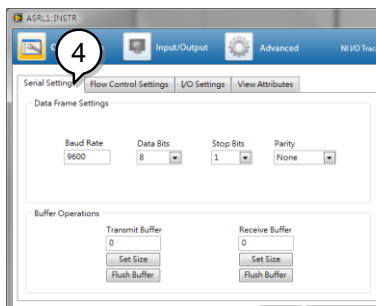

5. Click on I/O Settings.
6. Make sure the *Enable Termination Character* check box is checked, and the terminal character is \n (Value: xA).
7. Click *Apply Changes*.

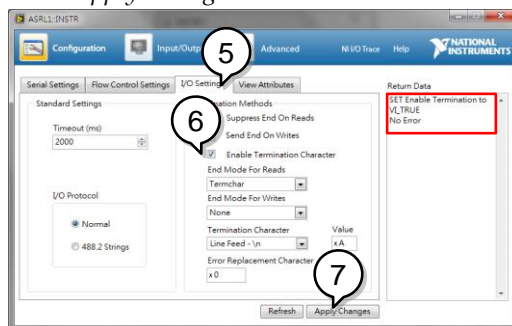

8. Click the *Input/Output* icon.
9. Enter `*IDN?\n` in the *Select or Enter Command* dialog box if it is not already.



10. Click the *Query* button.
11. The `*IDN?\n` query will return the Manufacturer, model name, serial number and firmware version in the dialog box.

GW Instek,PEL-2000B,00000001, V3.01\n

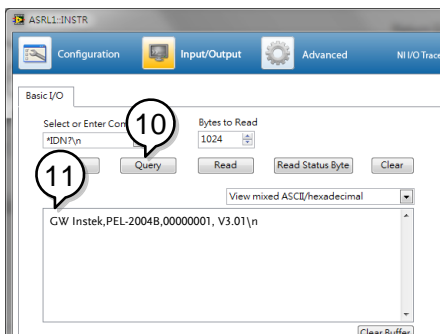

The COM port corresponding to the USB CDC will exist until the USB driver is well installed. If you want to do the USB CDC function check, the VISA resource name should be changed to the COM port which is occupied by the USB CDC protocol as a virtual com port in your system.

GPIB Function Check

Background	To test the GPIB functionality, National Instruments Measurement and Automation Explorer can be used. This program is available on the NI website, www.ni.com , via a search for the VISA Run-time Engine page, or “downloads” at the following URL, http://www.ni.com/visa/
Requirements	Operating System: Windows XP, 7, 8, 10
Functionality check	<p>Please use the National Instruments Measurement & Automation Controller software to confirm GPIB functionality.</p> <p>See the National Instrument website, http://www.ni.com for details.</p>
Operation	<ol style="list-style-type: none">1. Start the NI Measurement and Automation Explorer (MAX) program. Using Windows, press: <i>Start>All Programs>National Instruments>Measurement & Automation</i>2. From the Configuration panel access; <i>My System>Devices and Interfaces>GPIB0</i>3. Press the <i>Scan for Instruments</i> button.4. In the <i>Connected Instruments</i> panel the PEL-2000B should be detected as <i>Instrument 0</i> with the address the same as that configured on the PEL-2000B.5. Double click the <i>Instrument 0</i> icon.

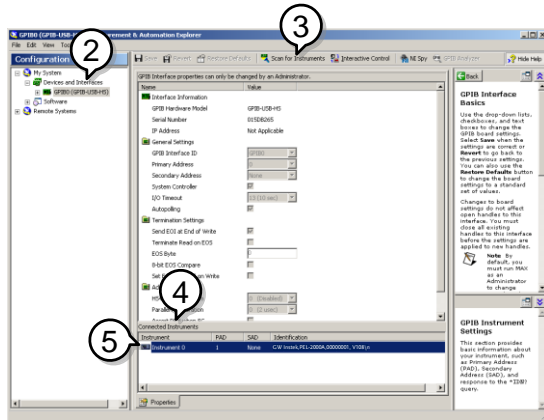

6. Click on *Communicate with Instrument*.
7. In the *NI-488.2 Communicator* window, ensure **IDN?* is written in the *Send String*: text box.

Click on the *Query* button to send the **IDN?* query to the instrument.

8. The *String Received* text box will display the query return:

GW Instek,PEL-2000B,xxxxx, xxx

(manufacturer, model, serial number, version)

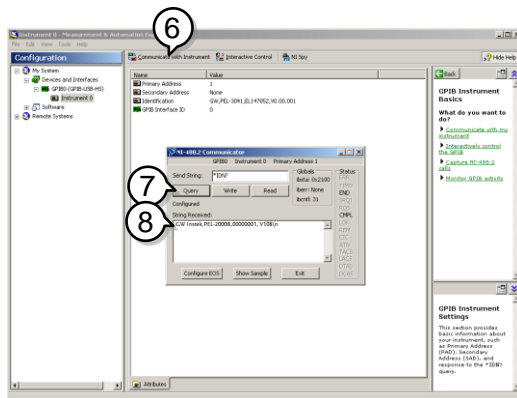

9. The function check is complete.

Saving/Recalling Channels

Background

The PEL-2000B series can save data for up to 120 different channel configurations. Each channel is represented by 120 memory slots using the onboard memory.

Memory is used in program sequences or for individual channel setups. For further details on memory, see page 90.

Panel operation

1. Press the File key.



2. Press F1 repeatedly until the Media Memory menu appears.

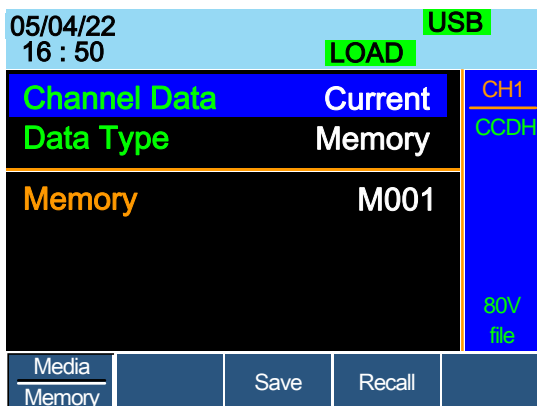

3. Use the Selector Knob to edit Channel Data and Data Type.

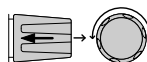

4. Choose Current or All and Memory.

Channel Data	Current
Data Type	Memory

5. Press the Selector knob to edit Memory (M001-M120)

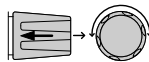

OR

Use the number pad to enter a number.



6. Press F3 to Save or F4 to Recall the memory settings.



7. A message will indicate when a save has been successful

Memory No 001 Save OK



Note

The display will revert to the channel menu after recalling memory.

Saving/Recalling Preset memory

Background The PEL-2000B series can store up to 10 presets for each channel. The presets can be saved or recalled either individually for each channel (Channel Data: Current) or at the same time (Channel Data: All), using the All option.

For further details on memory, see page 90.

Panel operation 1. Press the File key.



2. Press F1 repeatedly until the Media Memory menu appears.

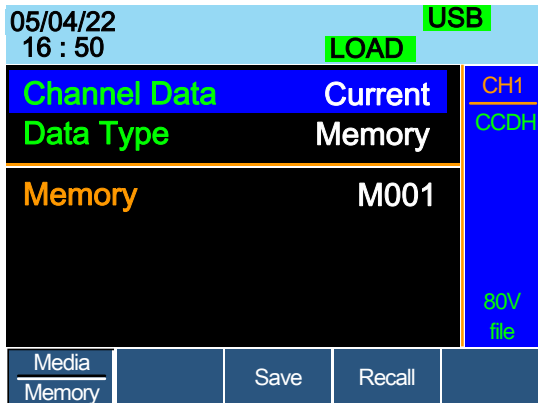

3. Use the Selector Knob to edit Channel Data and Data Type.

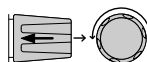

4. To save or recall only the active channel, choose Current and Preset. To save or recall all the presets choose All and Preset.

Save / Recall
Current Channel

Channel Data	Current
Data Type	Preset

Save / Recall All
Channels

Channel Data	All
Data Type	Preset

5. Press the Selector knob to edit Preset (P0-P9)

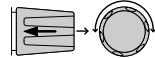

OR

Use the number pad to enter a number.

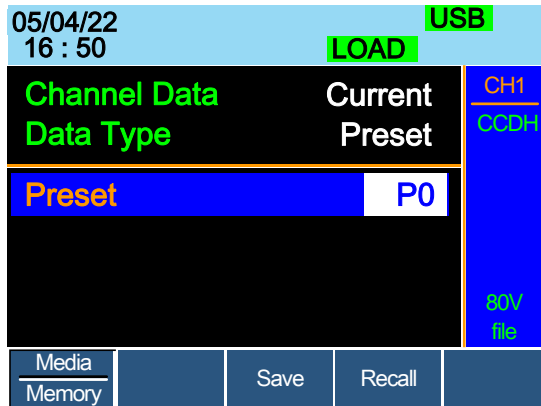
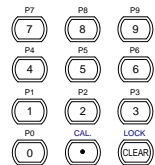

6. Press F3 to Save or F4 to Recall the Presets.

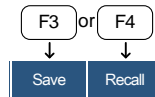

7. A message will be displayed when the save is complete.

Preset P0 Save OK



Note

The display will revert to the channel menu after recalling memory.

Saving/Recalling Setup Memory

Background The PEL-2000B series can store up to 4 different setups using the onboard memory. Each setup can be saved from the file menu. Using Setup Memory, each channel will be saved. For further details on memory, see page 90.

Panel operation 1. Press the File key.



2. Press F1 repeatedly until the Media Memory menu appears.

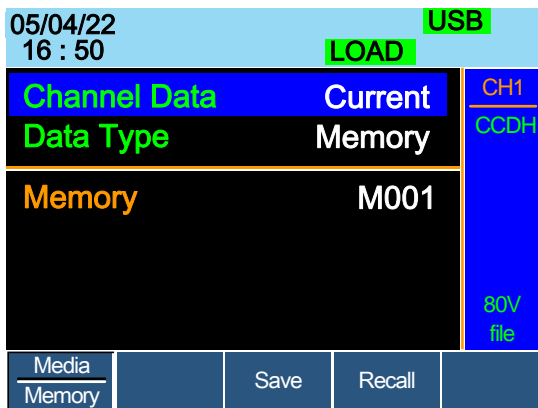

3. Use the Selector Knob to edit Channel Data and Data Type.

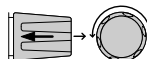

4. Choose All and Setup.



- Press the Selector knob to edit Setup Memory (1~4)

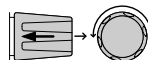

OR

Use the number pad to enter a number.

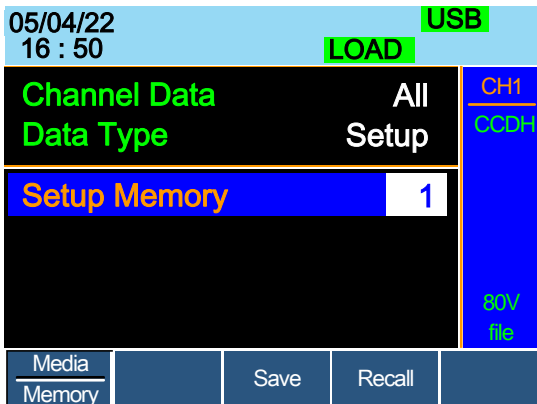

- Press F3 to Save or F4 to Recall the Setup Memory.

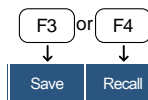

- A message will be displayed when the save/recall is complete.

Setup Memory 1 Save OK
Setup Memory 1 Recall OK

Setting the Default USB Path/File

Background When saving files to a USB memory stick the files will be saved into the root directory if a file path has not been set.

Panel operation 1. Insert a USB flash drive into the front panel USB slot. 

2. Press the File key. 

3. Press F1 repeatedly until the Media USB menu appears. 

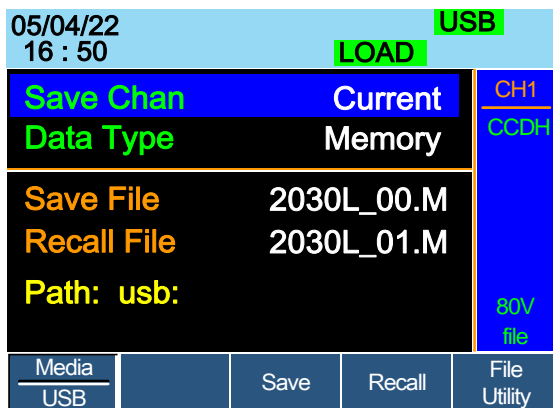

4. Press F5 (File Utility). 

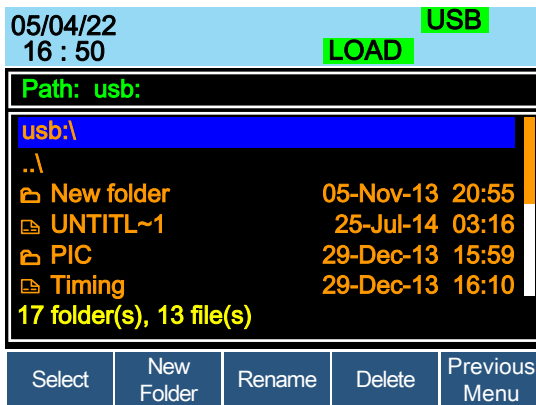

The top section (window) shows the current USB path.

There are 4 options:

- **Select;** Selects the current USB path as the default file path to save. (Step 5)
- **New Folder;** Creates a new folder (Step 7)
- **Rename;** Renames the current folder/path (Step 13)
- **Delete;** deletes the current file/path name. (Step 20)

Select Default Path

5. Use the Selector knob to highlight the new path directory

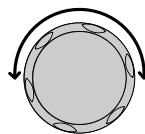

6. Press F1 (Select) to select the new default directory path.



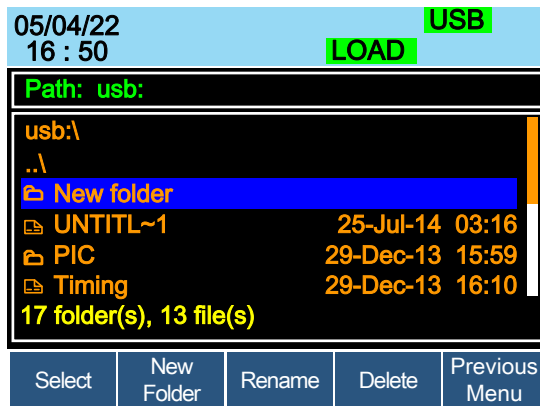

The new path will be shown in the upper Path box in green.



Create New Folder

- To create a new directory, Press F2(New Folder)

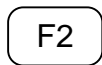

The On-Screen keyboard (OSK) appears. The directory has an 8 character size limit.

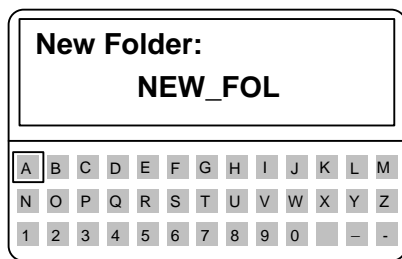

- Use the Selector knob to scroll left and right through the keys.

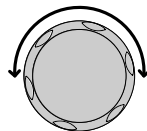

- When a key is highlighted, use the selector knob, F1 or Enter to confirm a key entry.

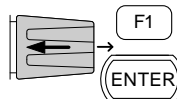

10. Use F2 (Back Space) to delete any previous entries/mistakes. F2

11. Press F3 (Save) to save the directory name. F3

12. Press F5 (Previous menu) to continue to the previous menus F5

Rename Folder

13. Use the Selector knob to highlight the file/ directory that needs to be renamed.

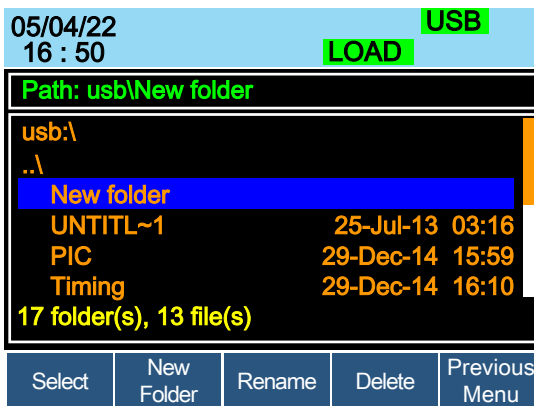
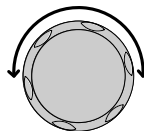

14. Press F3 (Rename) F3

The On Screen Keyboard appears



15. Use the Selector knob to scroll left and right through the keys.

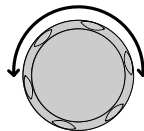

16. When a key is highlighted, use the selector knob, F1 or Enter to confirm a key entry.

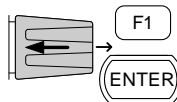

17. Use F2 (Back Space) to delete any previous entries/mistakes.



18. Press F3 (Save) to save the directory name.



19. Press F5 (Previous menu) to continue to the previous menus



Delete File Name 20. Use the Selector knob to highlight a file/directory.

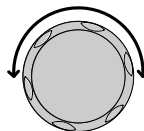

21. Press (F4) Delete.



Note

If there is any content in the folder, you cannot delete it and the message **Error! This folder may be not empty!** will be displayed on the screen.

22. To confirm deletion, press F4 again.

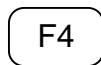

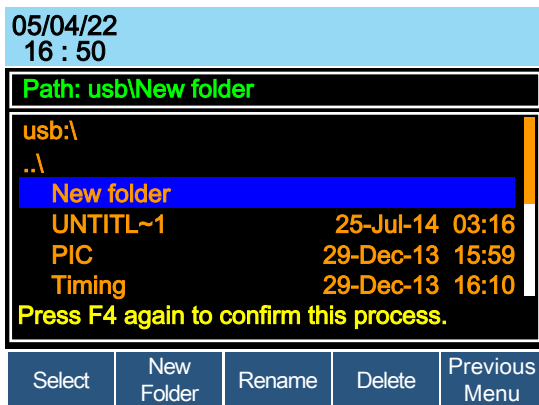



Saving Setups to USB Memory

Background Setup data contains all the channel data including Memory, Presets and Program Sequences.

There are four setups in internal memory. When saving to USB, all four setups will be saved. Conversely, when recalled, all four setups will be recalled to main memory.

The file extension *.S is used for Setup data only.

Parameters	Save File	200X0_XX.S
------------	-----------	------------

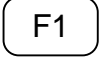
- Panel operation**
1. Insert a USB flash drive into the front panel USB slot. 
 2. Ensure the USB path has been set. Page 238.
 3. Press the File key. 
 4. Press F1 repeatedly until the Media USB menu appears. 



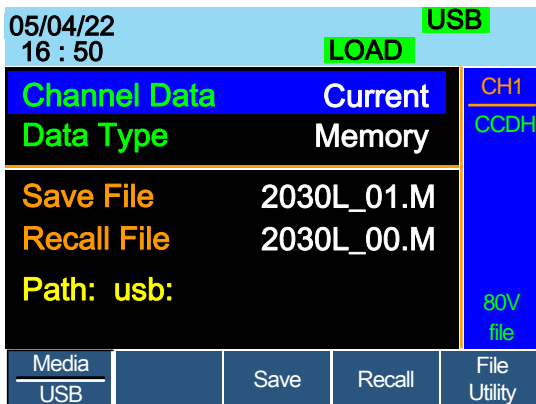

5. Use the Selector Knob to edit Save Chan and Data Type.

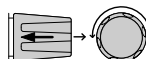

6. Choose All and Setup.

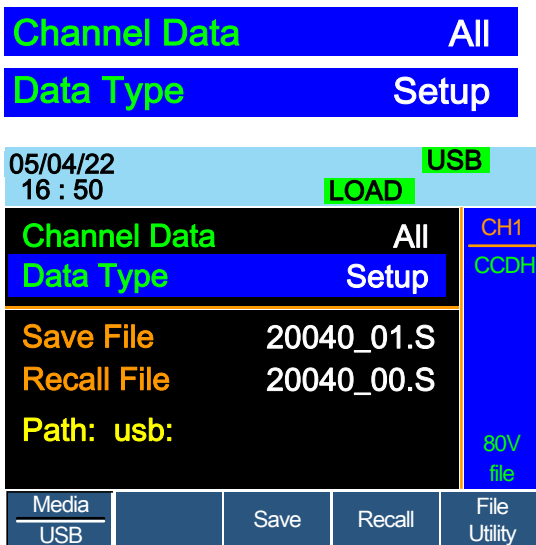

The screen will update to only show Setup files (*.S) that are available to save/recall in the root directory. Press F5 (File Utility) to select the directory to save.

Save/ Recall
Setups to USB

- Use the Selector Knob to edit Save File or Recall File. Rotating the selector knob will scroll through all the available setup files (*.S).

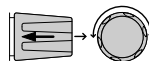

- Choose a file name.

- Press F3 (Save) to save the setup data or F4 (Recall) to recall the setup data.

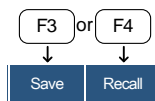

- A screen message will appear when the save/recall has completed.

20040_01.S Save Ok

20040_00.S Recall Ok



Note

Setups can only be saved if they have been saved to internal memory first. For details on how to save to internal memory see page 236.

Saving/Recalling Memory Data to USB

Background

There are two options to save or recall Memory data to a USB flash drive:

Save Chan Current: Saves the active Channel's Memory data (M001~M120) into the root directory (20XXX_XX.M). Press F5 (File Utility) to select the directory to save.



Save Chan All: Every channel's Memory data (CH1 M001~120 ~ CH8 M001~M120) will be saved into a directory (ALL00XX) as separate files for each channel (P0X0X_C1.M ~ P0X0X_C8.M).

Recall File: Recalls the selected file to the active channel's Memory. It is not possible to update all the channels at once, only one channel at a time can be recalled.

The file extension *.M is used for Memory data only.

For more information about the file structures see, page 90.

Parameters	Save Channel Data: Directory ALL0000 ~ ALL0099 All File: P0X0X_CX.M
	Save Channel Data: File: 20XXX_XX.M Current
	Recall Channel File: 20XXX_XX.M Data: Current

- Panel operation
1. Insert a USB flash drive into the front panel USB slot. 
 2. Ensure the USB path has been set. Page 238.
 3. Press the File key. 
 4. Press F1 repeatedly until the Media USB menu appears. 

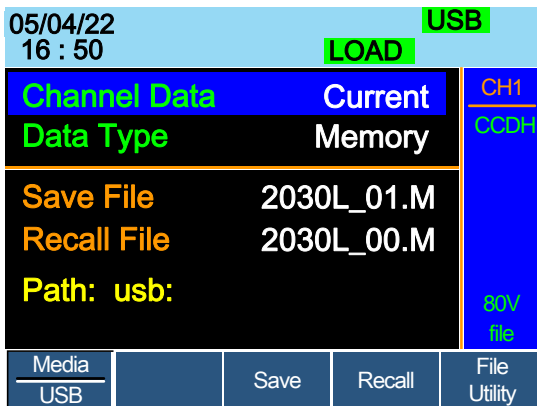

Save all Channels 5. Use the Selector knob to edit Save Chan and Data Type.

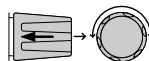

6. Choose All, and Memory

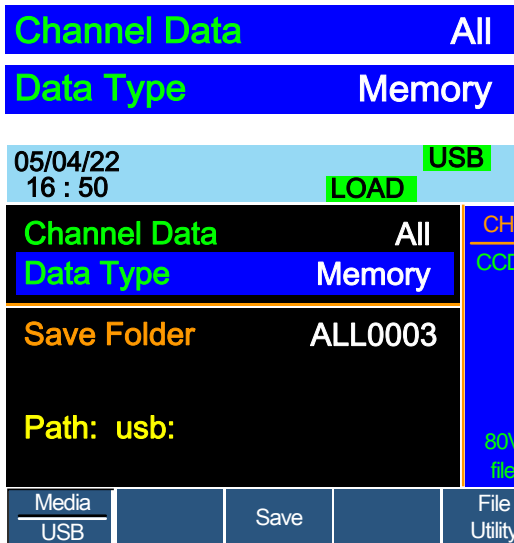

The screen updates to show Save Folder. Note it is not possible to recall all channels at once, only save.

7. Use the Selector Knob to edit Save Folder.

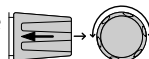

8. Choose a directory name (ALL0000 ~ ALL0099).



Note

Any used directories will not be available. It is not possible to over-write older directories. They must be deleted first.

9. Press F3 (Save)

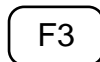

10. A screen message will be displayed when complete.

ALL0003 Save Ok

Save /Recall File 11. Use the Selector Knob to edit Save Chan and Data Type.

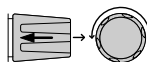

12. Choose Current and Memory.

Channel Data	Current
Data Type	Memory

05/04/22 16 : 50		LOAD	USB
Channel Data	Current	CH1 CCDH 80V file	
Data Type	Memory		
Save File	2030L_00.M		
Recall File	2020L_01.M		
Path: usb:			
Media USB	Save	Recall	File Utility

13. Use the selector knob to edit Save or Recall File.

14. Choose a file name.

15. Press F3 (Save) to save or F4 (Recall) to recall the current channel memory.

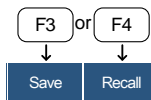

16. A save or recall message will be displayed when complete.

2030L_00.M Save Ok
2030L_00.M Recall Ok

Recall File from USB path

17. Press F5 (File Utility).
18. Use the selector knob to select path for saving memory. usb:\ALLXXXX\File: 2XXXX_XX.M

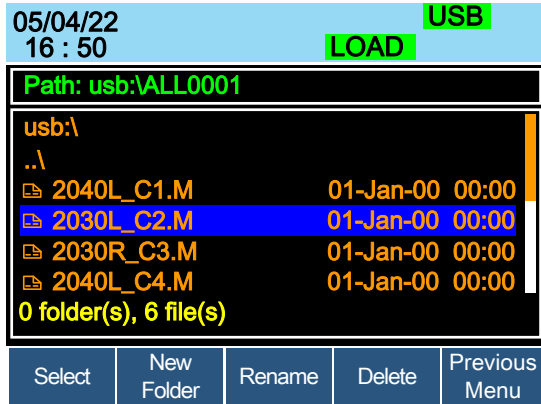

19. press the selector knob, Enter or F1
20. A recall message will be displayed when complete.

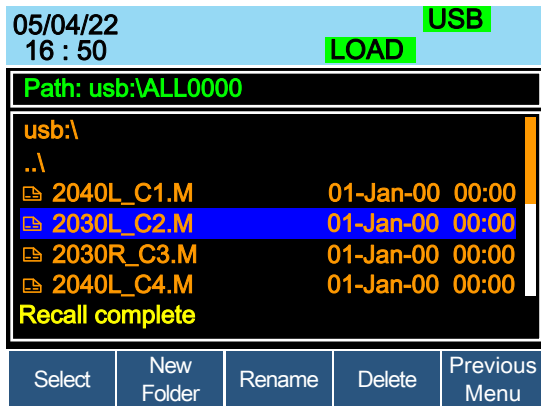

Remember only data that has been saved to internal memory will be saved to USB. Only the active channel will be saved.

If you try to recall data that originated from a different load module than the active channel, an error message will appear. The filename must reflect the active channel's load module type.

Machine Type Error

Saving/Recalling Presets to USB

Background

There are two options to save or recall Channel Presets to a USB flash drive:

Save Chan Current: Saves the active Channel's Presets (P0~P9) into the root directory (20XXX_XX.P). Press F5 (File Utility) to select the directory to save.

Save Chan All: Every channel's Presets (CH1 P0~P9 ~ CH8 P0~P9) will be saved into a directory (ALL00XX) as separate files for each channel (P0X0X_C1.P ~ P0X0X_C8.P)

Recall: Recalls the selected file to the active channel's Presets (P0~P9). It is not possible to update all the channels at once, only one channel at a time can be recalled.

The file extension *.P is used for channel Presets only.

For more information about the file structures see page 90.

Parameter	Save Channel Data: All	Directory: ALL0000 ~ ALL0099 File: P0X0X_CX.P
	Save Channel Data: Current	File: 20XXX_XX.P
	Recall Channel Data: Current	File: 20XXX_XX.P

Panel operation

1. Insert a USB flash drive into the front panel USB slot.



2. Ensure the USB path has been set. Page 238.

3. Press the File key.



4. Press F1 repeatedly until the Media USB menu appears.

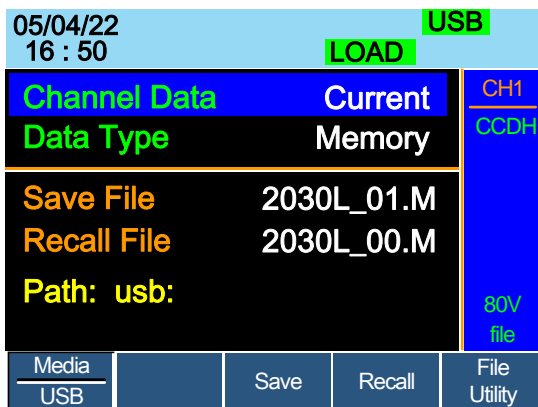
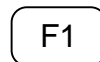

Save all Channel Presets

5. Use the Selector knob to edit Save Chan and Data Type.

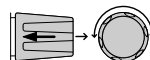

6. Choose All, and Preset



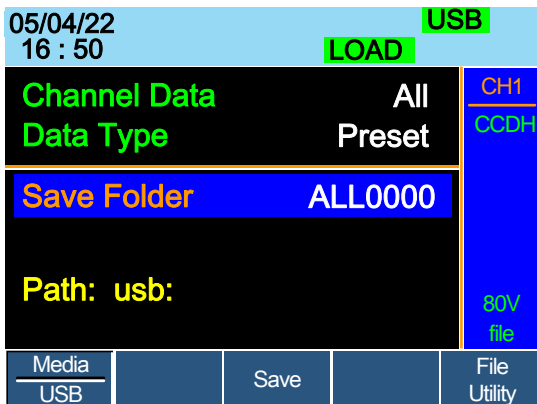

The screen updates to show Save Folder. Note it is not possible to recall all presets at once, only save.

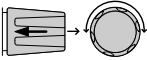
7. Use the Selector Knob to edit Save Folder. 
8. Choose a directory name (ALL0000 ~ ALL0099).

Save Folder ALL0000



Note

Any used directories will not be available. It is not possible to over- write older directories. They must be deleted first.

9. Press F3 (Save)

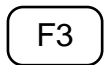

10. A screen message will be displayed when the save is complete.

ALL0001 Save Ok

11. Use the Selector Knob to edit (current channel) Save Chan and Data Type.

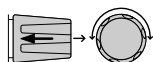

12. Choose Current and Preset.

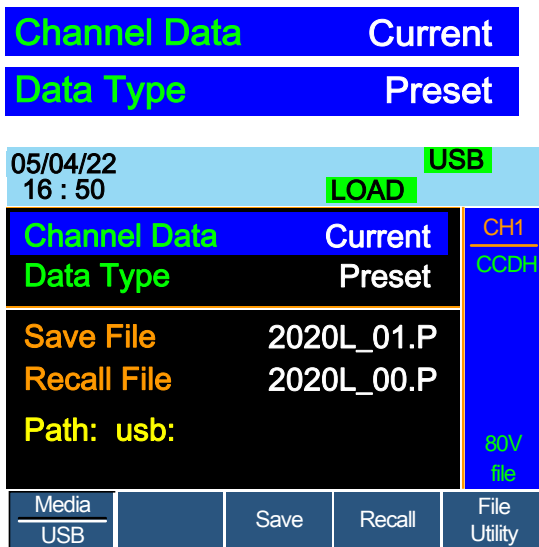

13. Use the selector knob to edit Save File or Recall file.

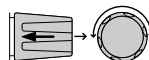

14. Choose a file name.

15. Press F3 (Save) to save or F4 (Recall) to recall the Channel Presets.

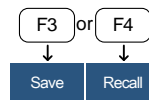

16. A message will be displayed when the save or recall has completed.

2020L_01.P Save Ok
2020L_01.P Recall Ok

Recall File from USB path

17. Press F5 (File Utility).
18. Use the selector knob to select path for saving preset. usb:\ALLXXXX\File: 20XXX_XX.P

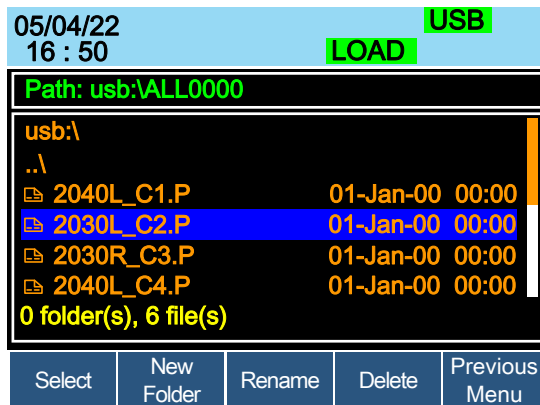

19. Press the selector knob, Enter or F1.
20. A recall message will be displayed when complete.



 Note

Remember only data that has been saved to internal memory will be saved to USB. Only the active channel presets will be saved.

If you try to recall data that originated from a different load module than the active channel, an error message will appear. The filename must reflect the active channel's load module type.

Machine Type Error

Saving/Recalling Sequences to USB

Background There are two options to save or recall Sequences to a USB flash drive. Sequences can either be saved from all channels or from the current channel only.

Save All: Every channels' sequences will be saved into a directory (ALL00XX) as separate files for each channel (20XXX_C1.A~ 20XXX_C8.A).



Save Current: The current channel's sequence will be saved into the root directory (20XXX_XX.A). Press F5 (File Utility) to select the directory to save.

Recall: Sequences can only be recalled for the current channel. It is not possible to recall all channels' Sequences at once.

The file extension *.A is used for Sequences only.

For more information about the file structures see page 90.



Parameters	Save Channel Data:Directory: ALL0000 ~ ALL0099
	All File: 20XXX_CX.A
	Save Channel Data:File: 20XXX_XX.A
Current	
Recall Channel	File: 20XXX_XX.A
Data: Current	

- Panel operation
1. Insert a USB flash drive into the front panel USB slot.  
 2. Ensure the USB path has been set. Page 238.
 3. Press the File key. 

4. Press F1 repeatedly until the Media USB menu appears. 



05/04/22 16 : 50		USB
LOAD		
Channel Data	Current	CH1
Data Type	Sequence	CCDH
Save File	2030L_01.M	
Recall File	2030L_00.M	
Path: usb:		80V file
Media USB	Save	Recall
		File Utility

- Save all Channel SEQ
5. Use the Selector knob to edit Save Chan and Data Type.  
 6. Choose All, and Sequence

Channel Data	All
Data Type	Sequence

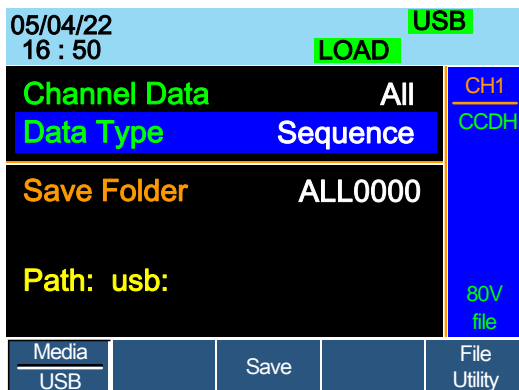

The screen updates to show Save Folder. Note it is not possible to recall all Sequence data at once, only save.

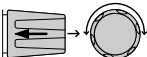
- Use the Selector Knob to edit Save Folder. 
- Choose a directory name (ALL0000~ALL0099).

Save Folder ALL0000



Note

Any used directories will not be available. It is not possible to over-write older directories. They must be deleted first.

- Press F3 (Save)

F3

- A screen message will be displayed when saving.

Save All Chan in ALL0000

- Save/Recall SEQ (current channel)
- Use the Selector Knob to edit Save Chan and Data Type.

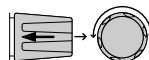

- Choose Current and Sequence.

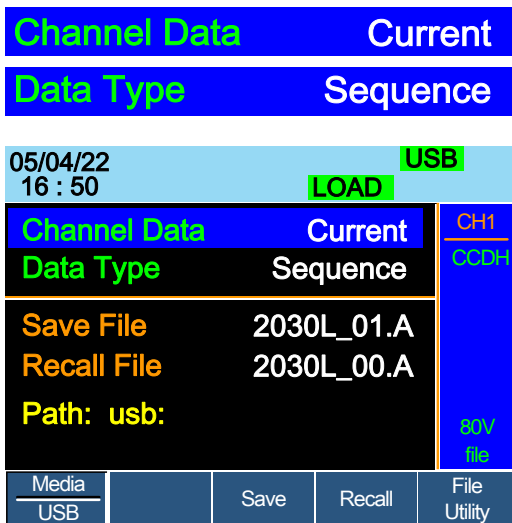

13. Use the selector knob to edit Save File or Recall File.

14. Choose a file name.

15. Press F3 (Save) to save or F4 (Recall) to recall the current channel's sequence.



16. A message will be displayed when the file is saved/recalled.

2030L_01.A Save OK
2030L_01.A Recall OK

Recall File from USB path

17. Press F5 (File Utility).

18. Use the selector knob to select path for saving sequence. usb:\ALLXXXX\File: 20XXX_XX.A

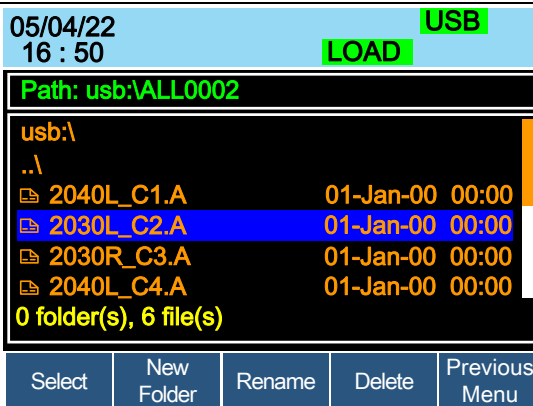

19. Press the selector knob, Enter or F1.
20. A recall message will be displayed when complete.

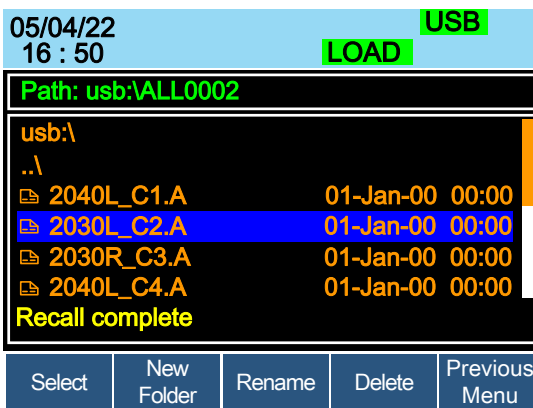

Note

Remember a sequence must first be saved to (internal) buffer before it can be saved to USB.

If you try to recall data that originated from a different load module than the active channel, an error message will appear. The filename must reflect the active channel's load module type.

Machine Type Error

Quick Preset Recall/Save

Background The PEL-2000B series mainframes have up to 10 Channel Presets (P0~P9). Quick recalling or saving presets will only be applicable to the active channel. For example, P1 on CH1 is not the same as P1 on CH2.

Parameter Presets P0 ~ P9 (current channel)

Panel Operation 1. Remove any USB devices from the front panel.

2. Select the channel you want to save Channel Presets to. Page 122.

Save Current Channel Preset 3. To save a Channel Preset, press the Preset key and hold one of the number keys (0-9) for a short time until a beep is heard.

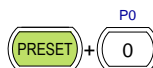

0 = P0
1 = P1 etc.

Save All Channel Presets 4. To save All Channel Presets, press the Shift key, the Preset key and hold one of the number keys (0-9) for a short time until a beep is heard.

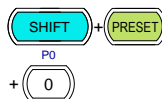

0 = P0
1 = P1 etc.

5. Press the Preset key again to deactivate it.

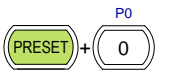
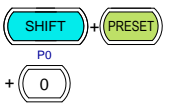
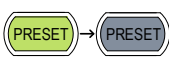

The Preset will be saved to the one of 10 presets depending on the number pressed.

Recall Current Channel Preset	<p>6. Press the Preset key and one of the number keys.</p> <p>0 = P0 1 = P0 etc.</p> <p>Only the current Channel preset will be recalled.</p>	
Recall All Channel Presets	<p>7. Press the Shift key, the Preset key and one of the number keys.</p> <p>0 = P0 1 = P0 etc.</p> <p>8. Press the Preset key again to deactivate it.</p>	 

Recall Setup Memory (Frame link).

Background A master mainframe can command all mainframes (master and slave) to recall setup memory from their internal memory. No setup data will be recalled from the master mainframe to the slave units.

Parameter Setup memory 1~4.

Panel Operation 1. On the Master mainframe, follow Page 235 the procedure for recalling setup memory for all channels.

All mainframes will update setup memory upon recall.



Note

It is necessary to save setup data before recalling both master and slave. If the setup data is not saved first, there will be no value change after recalling.

Recall Preset Memory (Frame link)

Background A master mainframe can command all units to recall preset memory from their internal memory. Only the first three preset memories (P0~P2) can be recalled.

Channel presets can be recalled via the file menu or using the quick recall feature using the number pad.

Parameters Presets P0 ~ P2 (current channel)

Panel Operation: 1. Remove any USB devices from the front panel.

Quick Keys

2. On the master mainframe, press the Shift and Preset key.

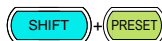

3. Press one of the number keys (0-2).



0 = P0

1 = P1 etc

The screen will flash momentarily when the presets are recalled.

Panel Operation: 4. On the master mainframe follow the procedure to recall preset memory for all channels. Page 234

File menu

The screen will flash momentarily when the presets are recalled.



Note

It is necessary to save preset data before recalling both master and slave. If preset data is not saved first, the value after recalling will be the factory default setting.

Recall Factory/User's Defaults

Background The Factory/User's defaults can be saved or recalled at any time. For details on the factory defaults please see the default settings in the appendix, page 293

Panel Operation 1. Press the File key.



2. Press F1 repeatedly until the Media Default menu appears.

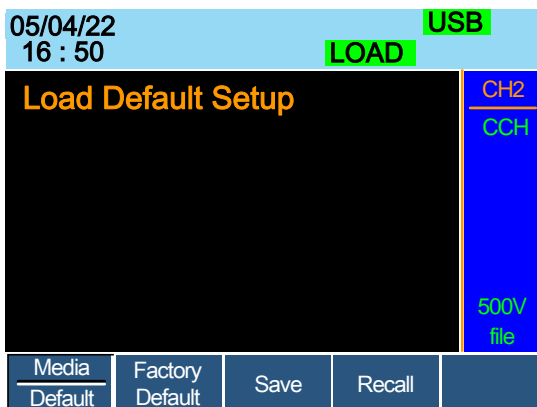

3. Press Factory Default (F2) to recall the factory default settings.



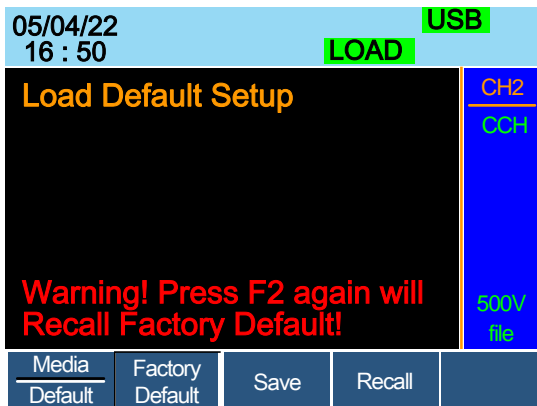

4. Press F2 again to ensure recall factory default setting F2

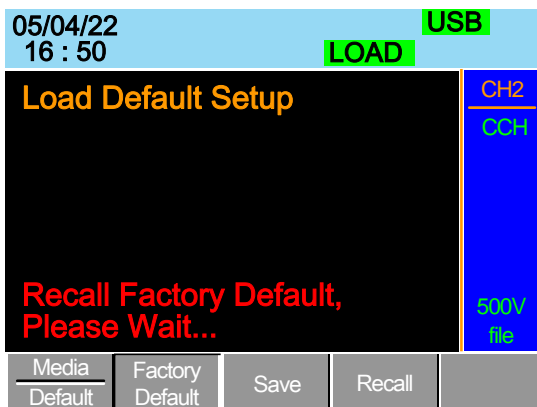

5. Wait a short time for the settings to be recalled.
6. Press Save (F3) to save the user's default. F3

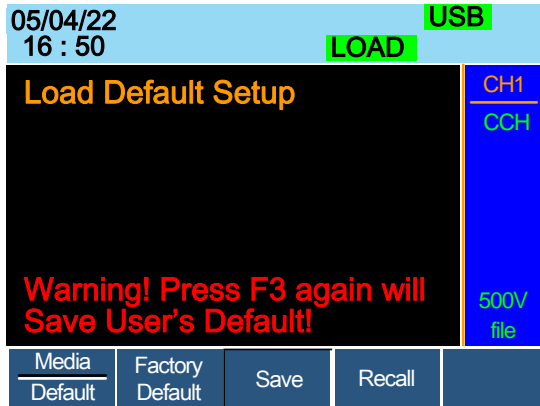

7. Press Save (F3) again to ensure save the user's default.

F3

8. Wait a short time for the settings to be saved.

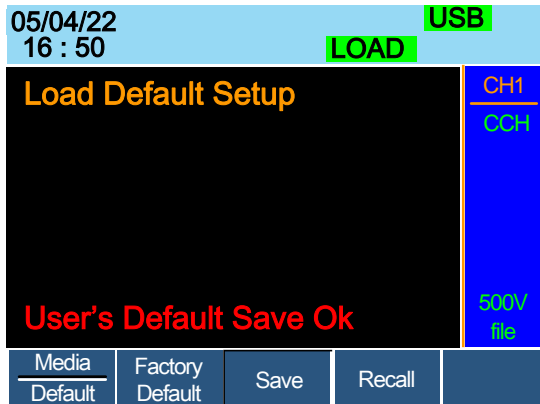

9. Press Recall (F4) to recall the user's default.

F4

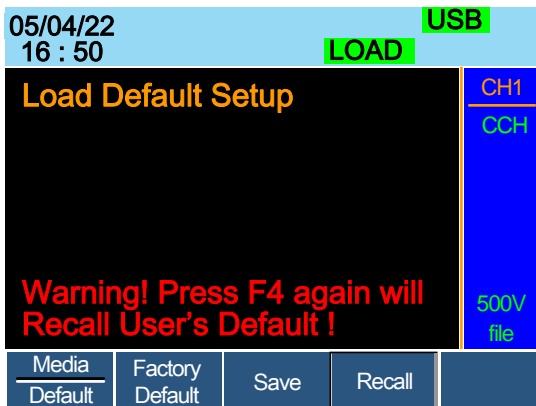

10. Press Recall (F4) to ensure recall the user's default

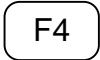

11. Wait a short time for the settings to be saved.

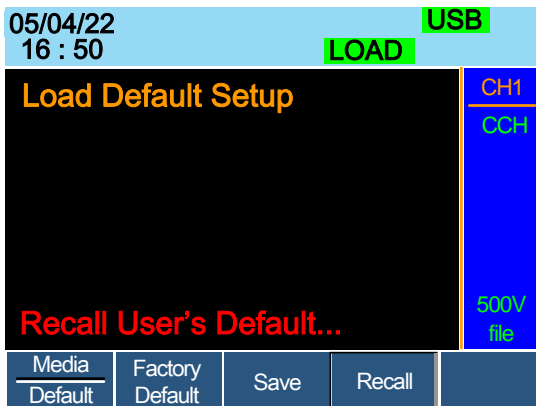

I NTERFACE

The Interface chapter details the pin configuration of the UART, LAN, GPIB, Frame Link, Channel Control and Go/NoGo interfaces.

Interface Configuration	268
Configure GPIB interface	268
Configure Channel Control interface	270
Configure Frame Link Interface	272
Configure Go/NoGo Interface	275
USB Interface Connection	276
UART Interface Configuration	277
LAN Interface Configuration	280

Interface Configuration

Configure GPIB interface

Interface function codes The interface function codes for the Electronic Load are listed as the following table.

Code	Interface function
SH1	Source Handshake capability
AH1	Acceptor Handshake capability
T5	Talker (basic talker, serial poll, unaddressed to talk on LAG)
L4	Listener (basic listener, unaddressed to listen on LAG)
SR1	Service Request capability
RL0	No Remote/Local capability
PP0	No Parallel Poll capability
DC1	Device Clear capability
DT0	No Device Trigger capability
C0	No Controller capability
E1	Open collector bus drivers
TE0	No Extended Talker capability
LE0	No Extended Listener capability

Connection Connect the GPIB cable to the rear panel port: 24-pin female connector.

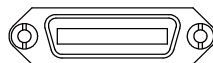

Pin assignment

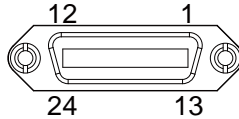

Pin1	Data line 1	Pin13	Data line 5
Pin2	Data line 2	Pin14	Data line 6
Pin3	Data line 3	Pin15	Data line 7
Pin4	Data line 4	Pin16	Data line 8
Pin5	EOI	Pin17	REN
Pin6	DAV	Pin18	Ground
Pin7	NRFD	Pin19	Ground
Pin8	NDAC	Pin20	Ground
Pin9	IFC	Pin21	Ground
Pin10	SRQ	Pin22	Ground
Pin11	ATN	Pin23	Ground
Pin12	Shield (screen)	Pin24	Signal ground

- GPIB constraints
- Maximum 15 devices altogether, 20m cable length, 2m between each device
 - Unique address assigned to each device
 - At least 2/3 of the devices turned On
 - No loop or parallel connection

Configure Channel Control interface

Channel control configuration	Connector	Screwless connector.
	Wire Gauge	22-28 AWG (24 AWG recommended).
	Wire connection	10 mm strip gauge for connection.

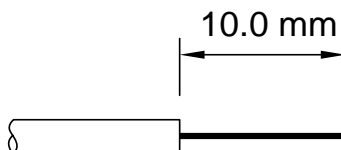

Input 0-10V.

Pin Assignment



1	GND	Negative potential of the load input terminal.
2	I MON (OUTPUT)	Load input current monitor; where 0V = 0% of input current and 10V = 100% of input current.
3	V MON (OUTPUT)	Load input voltage monitor; where 0V = 0% of input voltage and 10V = 100% of input voltage.
4	Ext Voltage ref (INPUT)	External voltage reference; Where 0V=0% of rating voltage/current and 10V = 100% of rating voltage/current. The external voltage reference is for CC and CV mode.

5 Load On

Load On Input.

Load on = Active low.

Load off = Active high. (Pin 5 of the connector is internally pulled up to 3.3V with a 10kΩ resistor when the switch is open. Thus when the switch is open, pin 5 is logically high. When the switch is closed, pin 5 is pulled down to the GND ground level, making pin 5 logically low)

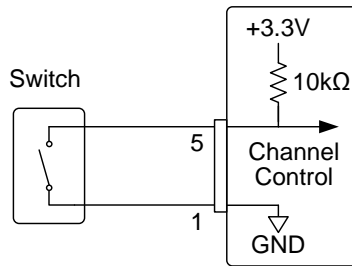

The Load On/Off determines whether the external switch is closed (low) or open (high)

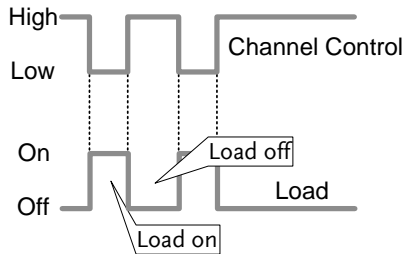

6 +15V

Internal power output. Max 50mA.

Channel Control Mode/Range Interface Constraints

Mode and Range configuration is only selected via the front panel.

Configure Frame Link Interface

Connection Connect the Frame link cable (MIL 20 pin connector) to the rear panel port: 20-pin male connector.

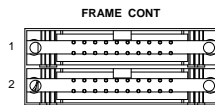

Pin assignment
(Frame link connector 1)

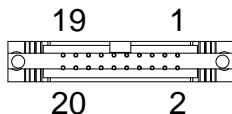

Pin number	Pin name	Description
Pin1	A	Input, Recall Preset memory 0 (All channels)
Pin2	B	Input, Recall Preset memory 1 (All channels)
Pin3	C	Input, Recall Preset memory 2 (All channels)
Pin4	TRIG_IN	Trigger input
Pin5	MEM_1	Input, Recall Setup memory 1 (All channels)
Pin6	MEM_2	Input, Recall Setup memory 2 (All channels)
Pin7	MEM_3	Input, Recall Setup memory 3 (All channels)
Pin8	MEM_4	Input, Recall Setup memory 4 (All channels)
Pin9	Enable	Input, Enable Load (On/Off), recall Preset memory (0-2) and Setup memory (1-4)

Pin10	Load On/Off	Input, Load On/Off
Pin11	N.C	No connection
Pin12	N.C	No connection
Pin13	N.C	No connection
Pin14	N.C	No connection
Pin15	Load Status	Output, load on status.
Pin16	Alarm Status	Output, alarm activated.
Pin17	+5V	Power source output, +5V, 100mA.
Pin18	N.C	No connection.
Pin19	GND	Ground
Pin20	GND	Ground

Pin assignment
(Frame link
connector 2)

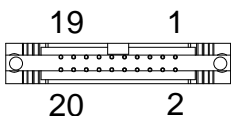

Pin number	Pin name	Description
Pin1	Sync._A	Output, Sync signal, Recall Preset memory 0 (All channels)
Pin2	Sync._B	Output, Sync signal, Recall Preset memory 1 (All channels)
Pin3	Sync._C	Output, Sync signal, Recall Preset memory 2 (All channels)
Pin4	TRIG_OUT	Trigger output

Pin5	Sync._MEM_1	Output, Sync signal, Recall Setup memory 1 (All channels)
Pin6	Sync._MEM_2	Output, Sync signal, Recall Setup memory 2 (All channels)
Pin7	Sync._MEM_3	Output, Sync signal, Recall Setup memory 3 (All channels)
Pin8	Sync._MEM_4	Output, Sync signal, Recall Setup memory 4 (All channels)
Pin9	Sync._Enable	Output, Sync signal, Enable Load (On/Off), recall Preset memory (0- 2) and Setup memory (1-4)
Pin10	Sync._Load On/Off	Output, Sync signal, Load On/Off
Pin11	N.C	No connection
Pin12	N.C	No connection
Pin13	N.C	No connection
Pin14	N.C	No connection
Pin15	Load Status	Output, load on status.
Pin16	Alarm Status	Output alarm activated.
Pin17	N.C	No connection
Pin18	+5V	Power source output, +5V, 100mA
Pin19	GND	Ground
Pin20	GND	Ground

Explanation

- Input: active low (0-1V)
active high (4-5V)

 Note Input type is internally pulled up to 5V with a 10kΩ resistor.

- Output: high (floating)
low (0-1V)

 Note Output type is internally Open collector outputs, maximum 30VDC with 1.1V saturation voltage (100mA).

- When Enable (pin9) is on (active low), the following is disabled from the mainframe: Load On/Off (pin 10) activating loads and recalling preset (pin 1-3) or setup memory (pin 5-8).

Frame Link constraints

- Maximum 5 (1 master + 4 slave units) devices can be linked altogether with a maximum cable length of 30cm for each cable.
- All the connected devices must be turned on.
- No loop or parallel connections

Configure Go/NoGo Interface

Connection Use a DSUB (DB-15 Female) connector to connect to the Go/NoGo port.

The Go/NoGo port is an output only port.

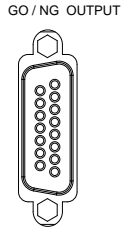

Pin assignment

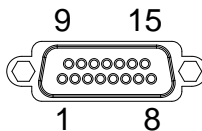

Pin1	Ch1_GO/NG	Pin9	Ch5_GO/NG
Pin2	GND	Pin10	GND
Pin3	Ch2_GO/NG	Pin11	Ch6_GO/NG
Pin4	GND	Pin12	GND
Pin5	Ch3_GO/NG	Pin13	Ch7_GO/NG
Pin6	GND	Pin14	GND
Pin7	Ch4_GO/NG	Pin15	Ch8_GO/NG
Pin8	GO/NG_Enable		

Connection Type Open collector output maximum 30VDC with 1.1V saturation voltage (100mA).

30 V DC (high)	Pass (Go) or SPEC Test: OFF
----------------	--------------------------------

1.1 V DC (low)	Fail (NoGo)
----------------	-------------

USB Interface Connection

Connection For USB remote connection, use the USB-B port on the mainframe front panel.



UART Interface Configuration

UART configuration	Connector	RJ45, Female
	Baud rate	2400, 4800, 9600, 19200, 38400
	Parity	None, Odd, Even
	Data bit	8 (fixed)
	Stop bit	1, 2

Panel operation 1. Press the Shift Key then the Help key to access the Utility menu.



2. Press the Shift Key then the Help key to access the Utility menu.



05/04/22	LOAD	RS232
16 : 50		
Interface		UART
Mode		RS232
Baud rate		38400
Data Bit		8 Bit
Parity		NONE
Stop bit		1
System Info	Load	Interface
	Time Set	Other

3. If the interface is not set to RS232, use the selector knob to change the interface to RS232.

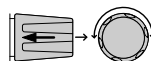

4. Edit the Baud rate, Stop bit and parity.

Baud rate 2400, 4800, 9600, 19200, 38400

Stop Bit Range 1,2

Parity Range None, Odd, Even

Connect the RS-232C to RJ45 cable to the rear panel port: RJ45 female connector.

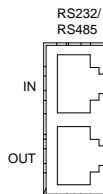

Terminal application

Invoke a terminal application such as MTTY (Multi-Threaded TTY).

- For RS-232C, set the COM port, baud rate, stop bit, data bit, and parity accordingly.

To check the COM port No. for RS-232C, see the Device Manager in the PC. For Win XP, Control panel → System → Hardware tab.

5. Ensure the terminal application has the following settings;
6. Baud rate – as per PEL-2000B settings
7. Com Port – as per PC settings (Device Manager)
8. Parity – None
9. Data bits – 8
10. Stop bits – None

Functionality check

Run this query command via the terminal.

`*idn?`

This should return the Manufacturer, Model number, Serial number, and Firmware version in the following format.

GW, PEL-2002B/2004B, 00000001, V3.01

The pin outs for the adapters are shown below.

RS232 cable with DB9 & RJ-45 shielded connectors from GTL-259 connection kit	DB-9 Connector		Remote IN Port		Remarks
	Pin No.	Name	Pin No.	Name	
	Housing	Shield	Housing	Shield	
	2	RX	7	TX	Twisted pair
	3	TX	8	RX	
5	SG	1	SG		

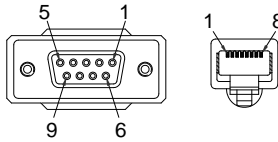

RS485 cable with DB9 & RJ-45 shielded connectors from GTL-260 connection kit	DB-9 Connector		Remote IN Port		Remarks
	Pin No.	Name	Pin No.	Name	
	Housing	Shield	Housing	Shield	
	9	TXD -	6	RXD -	Twisted pair
	8	TXD +	3	RXD +	
	1	SG	1	SG	
5	RXD -	5	TXD -	Twisted pair	
4	RXD +	4	TXD +		

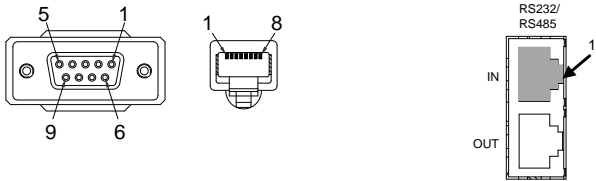

Steps

11. Connect the RS232 serial cable or RS485 serial cable to the Remote IN port on the real panel. Connect the other end of the cable to the PC.

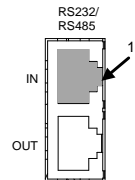

12. Select RS485 or RS232 for Mode setting. Also set UART relevant settings including Baud Rate, Data Bits, Parity, Stop Bits and Address.



Note

When RS232 Mode is selected, the Address setting is not available for assignment.

LAN Interface Configuration

Panel operation

1. Press the Shift Key then the Help key to access the Utility menu.

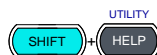

2. Press F3 (Interface Menu).

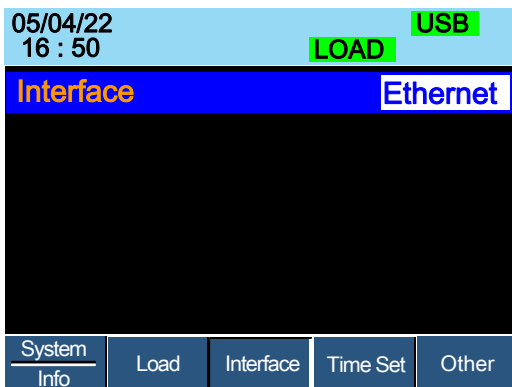

3. If the interface is not set to Ethernet, use the selector knob to change the interface to Ethernet.

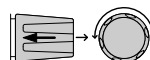

4. Choose Ethernet. Confirm that connection status turn form Offline to Online

05/04/22 16 : 50		LOAD		Ethernet	
Interface			Ethernet		
Connetion status			Offline		
MAC		24-22-00-D7-BA-CB			
DHCP		ON			
IP Address		172. 16. 5. 111			
Subnet Mask		255. 255. 128. 0			
System Info	Load	Interface	Time Set	Other	

5. Check if indicator “Ethernet” turns in green and connection status becomes online status.

05/04/22 16 : 50		LOAD		Ethernet	
Interface			Ethernet		
Connetion status			Online		
MAC		24-22-00-D7-BA-CB			
DHCP		ON			
IP Address		172. 16. 5. 111			
Subnet Mask		255. 255. 128. 0			
System Info	Load	Interface	Time Set	Other	

6. Connect the LAN RJ45 connector to the RJ45 female socket on the rear panel.

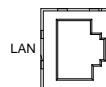

FAQ

Q1. The load voltage indicated on the load module is below expected.

A1. Ensure the load leads are as short as possible, twisted and use the appropriate wire gauge. Ensure that voltage sense is used, this can help alleviate the voltage drop across the load the leads.

Q2. When I try to start a program sequence, it will not run. “No Active Channel” is displayed.

A2. Ensure the channel(s) is activated (not set to OFF) in the FUNC→Program→Active Channel menu.

Q3. When trying to save to USB, the USB memory stick is unresponsive.

A3. Try restarting the PEL-2000B mainframe. If this fails to solve the problem, ensure the USB memory is cleanly formatted.

Q4. When I try to clear an alarm, it doesn't work.

A4. Before clearing an alarm or using the Protection Clear All function, the DUT must be turned off. After the DUT is off, the alarm(s) can be cleared.

For more information, contact your local dealer or GW Instek at www.gwinstek.com

A PPENDIX

Fuse Replacement

- Step
1. Turn off the power at the wall socket and rear panel. Remove the power cord.
 2. Remove the fuse socket using a minus driver.

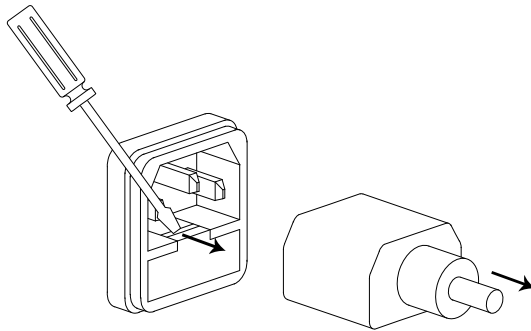

3. Replace the fuse in the holder.

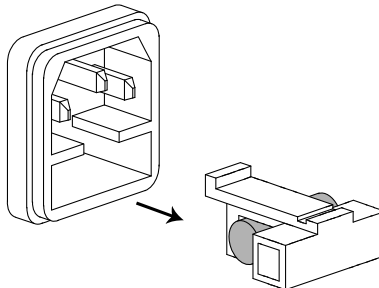

Rating T3.15A, 250V

Firmware Update

Background The PEL-2000B firmware can be easily updated using a USB memory stick. For the latest firmware please see your local GW Instek distributor or download the latest firmware from www.gwinstek.com.

File Name File: P2KAXXXX.P2K



Note

Copy the firmware file (*.P2K) into the root directory of a USB stick before proceeding with the firmware update.



WARNING

Do not turn the power off or remove the USB memory when the firmware is being read or upgraded.

Panel operation 1. Insert a USB flash drive into the front panel USB slot.

2. Press the File key.



3. Press F1 repeatedly until the Media USB menu appears.



4. Press F5 (File Utility).



5. Use the selector knob to scroll down to the firmware file (*.P2K) and press the selector knob, Enter or F1.

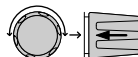

6. Press F1 to confirm the firmware upgrade.



7. Wait for the firmware upgrade to finish, a message will be displayed upon completion.

8. Turn the power Off.



Recall Factory Default

9. Turn the power On.

10. Press the File key.



11. Press F1 repeatedly until the Media Default menu appears.

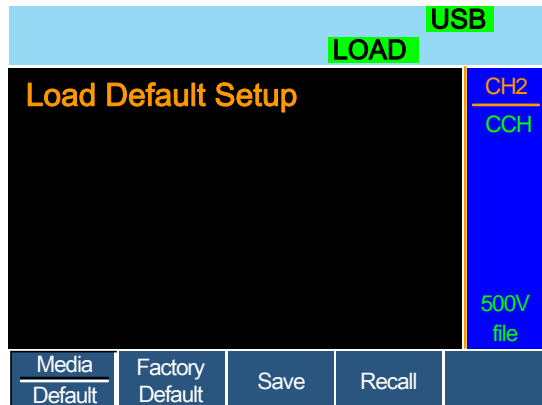
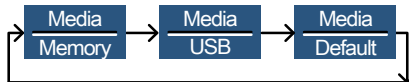
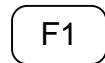

12. Press Factory Default (F2) to recall the factory default settings.

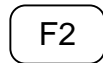

13. Firmware updating process is complete and you can use the device now.

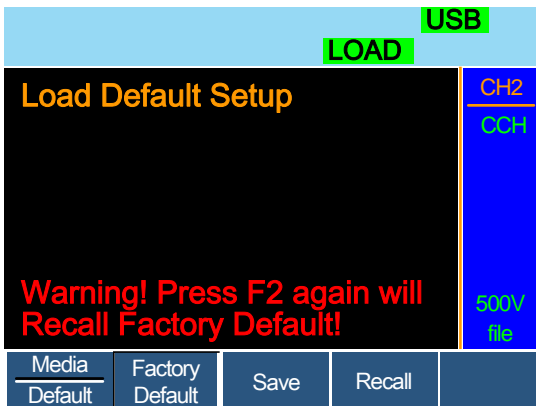

14. Press F2 again to ensure recall factory default setting F2

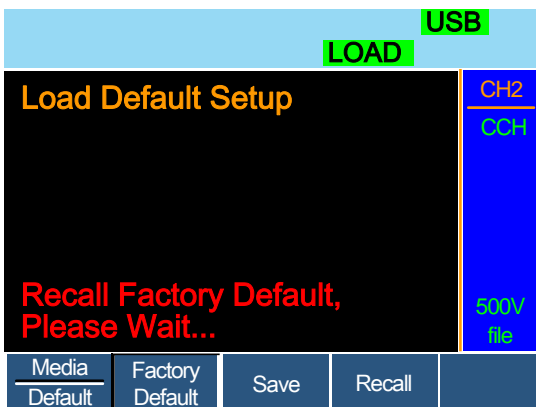

15. Wait a short time for the settings to be recalled.

Calibration

Background The PEL-2000B series load modules should be calibrated at least on a yearly basis.

GW Instek does not support End-User calibration. Please see your distributor for calibration details.

Range Chart

PEL-2020B Low Range 10W

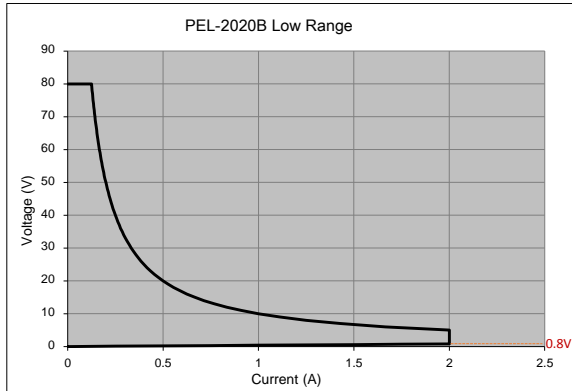

PEL-2020B High Range 100W

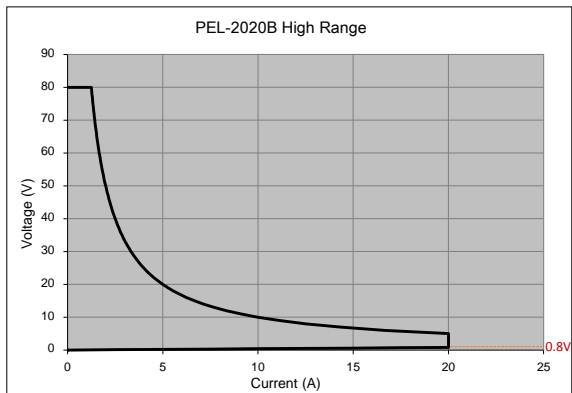

PEL-2020B CV Low Range

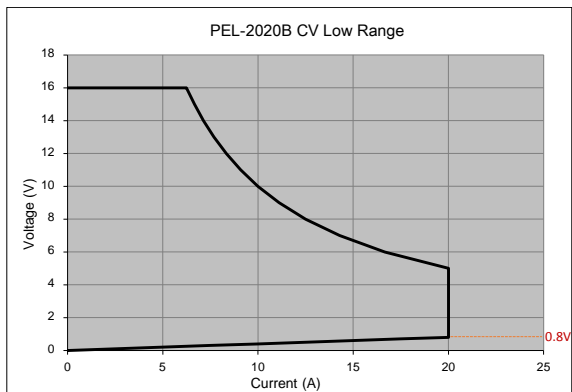

PEL-2030B (L)
High range 30W

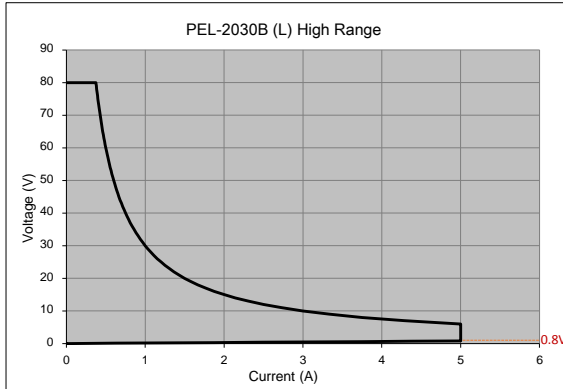

PEL-2030B (L)
CV Low Range

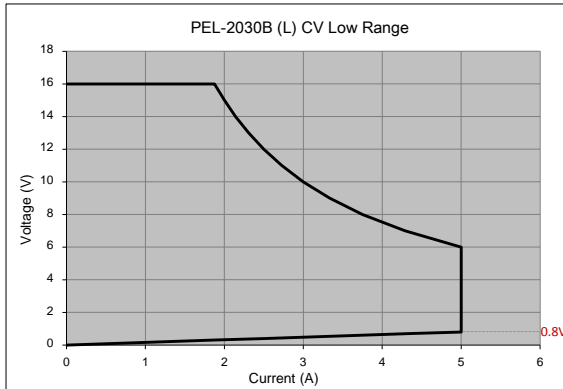

PEL-2030B (R)
Low Range 25W

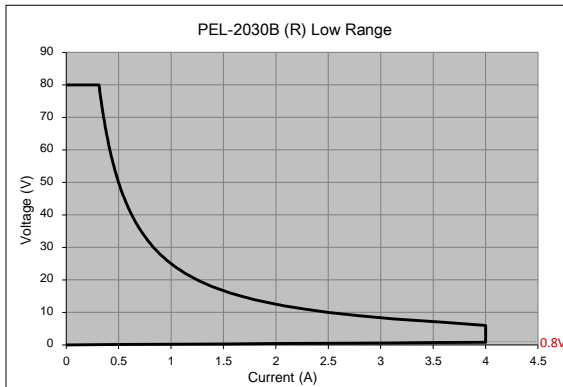

PEL-2030B (R)
High Range
250W

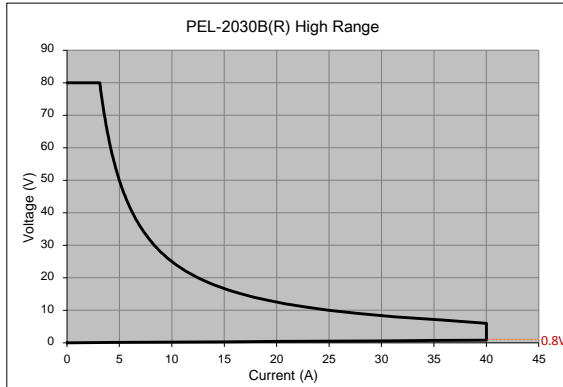

PEL-2030B (R)
CV Low Range

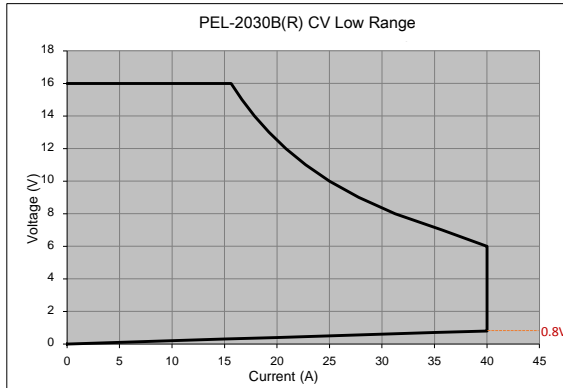

PEL-2040B Low
Range 35W

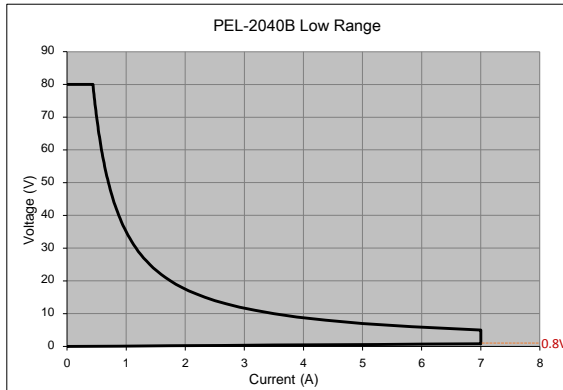

PEL-2040B High Range 350W

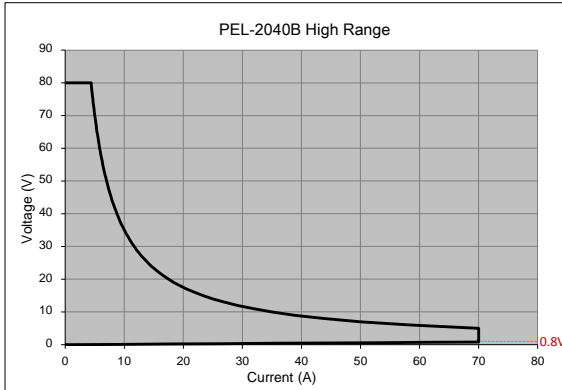

PEL-2040B CV Low Range

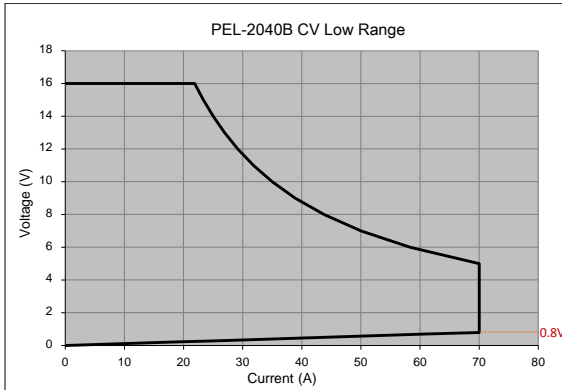

PEL-2041B Low Range 35W

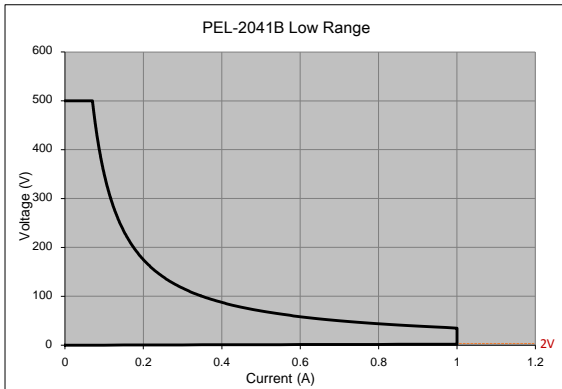

PEL-2041B High Range 350W

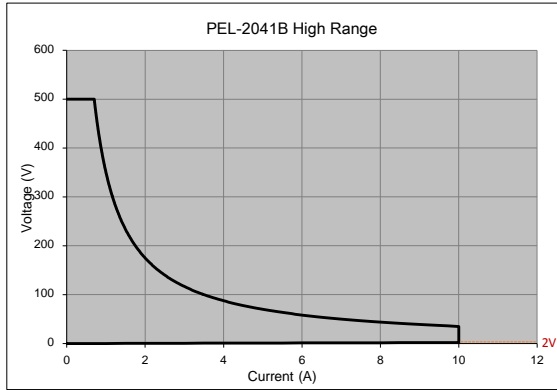

PEL-2041B CV Low Range

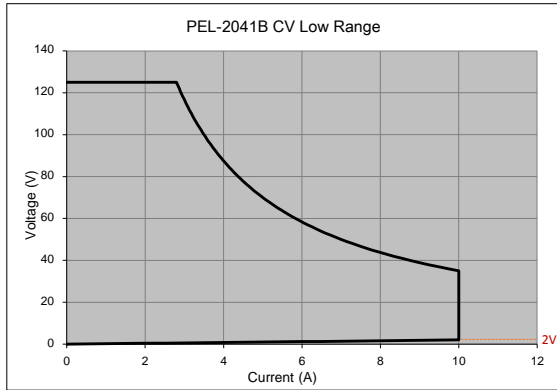

Default Settings

Menu Item		
CC Mode	Range: High A/B Value: Min A Falling Slew Rate: Max	Mode: Static Rising Slew Rate: Max
CR Mode	Range: High A/B Value: Max Ω Falling Slew Rate: Max	Mode: Static Rising Slew Rate: Max
CV Mode	Range: High A/B Value: Max V Curr Limit: Max A	Response: Slow I Meas: High
CP Mode	Range: High Curr Limit: Max A	A/B Value: Min W
CHAN-Protection	OCP Level: Max OVP Level: Max OPP Level: Max UVP Level: OFF Protection Clear: All	OCP Setting: OFF OVP Setting: OFF OPP Setting: OFF UVP Setting: Clear
CHAN- Other	CC Vrange: High Von Latch: OFF Independent: OFF Response: Fast CCL Step: Min CRL Step: Min CVL Step: Min CPL Step: Min Short Key: Toggle	Von Voltage: 0V CH CONT: Panel Load D-Time: 0.0s CCH Step: Min CRH Step: Min CVH Step: Min CPH Step: Min Short Function: ON Short Safety: ON

CHAN-Group	Total Units: OFF Display Mode: V,I	Group Mode: Para
CHAN- Seq. Edit	NO.: 001 Rising/Falling SlewRate: Max	Value: Min Duration Time: 0.000025s
CHAN- Seq. Edit - Loop	Repeat: Infinity Times On End Of Seq.: OFF A (CC mode) OFF Ω/OFF KΩ (CR mode)	Start of Loop: 001 Point CC Vrange: High
CHAN- Go/NoGo	SPEC Test: OFF Entry Mode: Value Low: Min	Delay Time: 0.0 s High: Max
FUNC- Program	PROG: 01 Memory: M001 On-Time: 0.1 P/F-Time: Off Short Channel: All channels	SEQ: 01 Run: Skip Off-Time: Off Short-Time: Off
FUNC- Program Chain	Start: P01	P01~P12→: Off
FUNC- Program- Active Channel	CH 01~08: Active: OFF	Prog: Off
FUNC- Sequence	Seq.: Off TRIG: CH1: OUT Setting: CH01~CH08: OFF	TRIG In: Off TRIG: CH2~08: OFF
FUNC- OCP	OCP: Off Range: High End C: Setting Range Max Last_C: Min Delay: Min	Chan: 1 Start C: Min Step_C: Min Step_T: Min Trig_V: Min

	Keep_T: Min	
FUNC- OCP- Active Channel	CH 01~08: Active: OFF	
FILE- Memory	Channel Data: Current Memory: M001	Data Type: Memory
FILE- USB	Channel Data: Current Save File: No File	Data Type: Memroy Recall File: No File
UTILITY- Load	Auto Load: OFF	Auto Load On: Prog
UTILITY - Interface	USB	
UTILITY - Other	Speaker: OFF Brightness: 70 Alarm (M): ON Knob Type: Updated Slave Knob: SetValue High Resolution: ON Von Latch Clear: Auto Jog Shuttle Control: OFF	Contrast: 8 Frame CONT: OFF Alarm (S): OFF Go_NoGo Tone: OFF Language: English System Mode: 0 Measure Period: 200ms RVP Load Off: OFF

Specifications

The specifications apply when the PEL-2000B series is powered on for at least 30 minutes to warm-up to a temperature of 25°C ± 5°C, unless specified otherwise.

	PEL-2002B	PEL-2004B
MODULE SLOTS	2	4

GENERAL

Operating Environment

Temperature	0°C to 40°C
Relative Humidity	0 to 85% RH
Altitude	Up to 2000m
Location	Indoor, no direct sunlight, dust free, almost non conductive pollution.

Storage Environment

Temperature	-10°C to 70°C
Relative Humidity	< 90% RH
Location	Indoor

Power Supply	AC input voltage range: 100-120Vac / 200-240Vac (90-132Vac / 180-250Vac) Frequency: 47~63Hz Power rating: PEL-2004B: 250VA Max PEL-2002B: 150VA Max Transient overvoltage on the main supply is 2500V.
--------------	---

Fuse	T3.15A/250V
Pollution degree	2
Measurement	1
Category	
Rear panel USB class	USB 2.0 full speed (CDC-ACM)
Weight	Approx. 17.1kg (Full modules) Approx. 28.4kg (Full modules)

PEL-2020B (100Wx2)

	Low	High
RANGE		
CURRENT	0~2A	0~20A
VOLTAGE	0~80V	
MIN.OPERATING	0.4V at 2A	0.8V at 20A
VOLTAGE(dc)Typ.)	0.2V at 1A	0.4V at 10A

STATIC MODE

CONSTANT CURRENT MODE

Operating Range	0~2A	0~20A
Setting Range	0~2.04A	0~20.4A
Resolution	0.1mA	1mA
Accuracy	$\pm(0.1\%set + 0.1\%F.S.^{*1})$	$\pm(0.1\%set + 0.2\%F.S.)$

CONSTANT RESISTANCE MODE

Operating Range	0.075 Ω ~300 Ω (100W/16V) 3.75 Ω ~15k Ω (100W/80V)
Setting Range	0.075 Ω ~300 Ω (100W/16V) 3.75 Ω ~15k Ω (100W/80V)
Resolution ^{*2}	0.333ms(100W/16V) 6.667 μ s(100W/80V)
Accuracy ^{*3}	300 Ω : $\pm(0.2\%set + 0.1S)$ 15k Ω : $\pm(0.1\%set + 0.01S)$

CONSTANT VOLTAGE + CONSTANT CURRENT MODE

Operating Range	1~16V	1~80V
Setting Range	0~16.32V	0~81.6V
Resolution	0.4mV	2mV
Accuracy	$\pm(0.05\%set + 0.1\%F.S.)$	
Current Setting Range	0~2.04A	0~20.4A
Resolution	0.1mA	1mA
Accuracy	$\pm(0.1\%set + 0.1\%F.S.^{*1})$	$\pm(0.1\%set + 0.2\%F.S.^{*1})$

CONSTANT POWER + CONSTANT CURRENT MODE

Operating Range	1~10W	1~100W
Setting Range	0~10.2W	0~102W
Resolution	1mW	10mW
Accuracy	$\pm(0.5\%set + 0.5\%F.S.^{*1})$	$\pm(0.5\%set + 0.5\%F.S.)$
Current Setting Range	0~2.04A	0~20.4A
Resolution	0.1mA	1mA
Accuracy	$\pm(0.1\%set + 0.1\%F.S.^{*1})$	$\pm(0.1\%set + 0.2\%F.S.^{*1})$

NOTE : ^{*1} F.S. = Full scale of H Range

^{*2} S (Siemens) is the unit of conductance, equal to one reciprocal ohm.

^{*3} Accuracy must be calculated in conductivity units.

DYNAMIC MODE

T1&T2	0.025ms ~ 10ms / Res: 1μs 10ms ~ 30s / Res: 1ms	
Accuracy	1us / 1ms ± 100ppm	

CONSTANT CURRENT MODE

Slew Rate	0.32 ~ 80mA/μs	3.2 ~ 800mA/μs
Slew Rate	0.32mA/μs	3.2mA/μs
Resolution		
Slew Rate Setting	±(10% + 15μs)	
Accuracy		
Current Setting	0~2.04A	0~20.4A
Range		
Current	0.1mA	1mA
Resolution		
Current Accuracy	±0.4% F.S.	

CONSTANT RESISTANCE MODE

Slew Rate	3.2 ~ 800mA/μs	
Slew Rate	3.2mA/μs	
Resolution		
Slew Rate Setting	±(10% + 50μs)	
Accuracy		
Resistance	0.075Ω~300Ω(100W/16V)	
Setting Range	3.75Ω~15kΩ(100W/80V)	
Resistance	0.333ms(100W/16V)	
Resolution	6.667μs(100W/80V)	
Resistance	300Ω: ±(0.5%set + 0.1S)	
Accuracy	15kΩ: ±(0.5%set + 0.01S)	

MEASUREMENT

VOLTAGE READBACK

Range	0~16V	0~80V
Resolution	0.32mV	1.6mV
Accuracy	±(0.025% read + 0.025% F.S.)	

CURRENT READBACK

Range	0~2A	0~20A
Resolution	0.04mA	0.4mA
Accuracy	±(0.05% read + 0.05% F.S. *2)	

POWER READBACK

Range	0~10W	0~100W
Accuracy	±(0.1% read + 0.1% F.S. *1)	

NOTE : *1 Power F.S. = Vrange F.S. x Irange F.S.

*2 F.S. = Full scale of H Range

PROTECTIVE

Over Power Protection

Range	1~102W
Resolution	0.5W
Accuracy	$\pm(2\% \text{ set} + 0.25\% \text{ F.S.})$

Over Current Protection

Range	0.25~20.4A
Resolution	0.05A
Accuracy	$\pm(2\% \text{ set} + 0.25\% \text{ F.S.})$

Over Voltage Protection

Range	1~81.6V
Resolution	0.2V
Accuracy	$\pm(2\% \text{ set} + 0.25\% \text{ F.S.})$

Over $\cong 85^{\circ}\text{C}$ Temperature
Protection

Rated Power Protection(CPP)

Value	110W
Accuracy	$\pm 5\% \text{ set}$

GENERAL

SHORT CIRCUIT

Current(CC)	$\cong 2.2/2\text{A}$	$\cong 22/20\text{A}$
Voltage(CV)	$\cong 0\text{V}$	
Resistance(CR)	$\cong 3.75\Omega$	$\cong 0.075\Omega$

Input Resistance 500k Ω (Typical)

(Load OFF)

Temperature 100ppm/ $^{\circ}\text{C}$

Coefficient

Weight Approx. 3.8kg

PEL-2030B (30W/250W)

RANGE	High	Low	High
CURRENT	0~5A	0~4A	0~40A
VOLTAGE	0~80V		
MIN.OPERATING	0.8V at 5A	0.4V at 4A	0.8V at 40A
VOLTAGE(dc)	0.4V at 2.5A	0.2V at 2A	0.4V at 20A

STATIC MODE

CONSTANT CURRENT MODE

Operating Range	0~5A	0~4A	0~40A
Setting Range	0~5.1A	0~4.08A	0~40.8A

Resolution	0.125mA	0.1mA	1mA
Accuracy	$\pm(0.1\% \text{set} + 0.1\% \text{F.S.})$	$\pm(0.1\% \text{set} + 0.1\% \text{F.S.}^{*1})$	$\pm(0.1\% \text{set} + 0.2\% \text{F.S.})$

CONSTANT RESISTANCE MODE

Operating Range	0.3Ω ~1.2kΩ (30W/16V) 15Ω ~60kΩ (30W/80V)	0.0375Ω ~150Ω(250W/16V) 1.875Ω ~7.5kΩ(250W/80V)	
Setting Range	0.3Ω~1.2kΩ (30W/16V) 15Ω~60kΩ (30W/80V)	0.0375Ω ~150Ω(250W/16V) 1.875Ω ~7.5kΩ(250W/80V)	
Resolution*2	83.333μs (30W/16V) 1.666μs (30W/80V)	0.666ms(250W/16V) 13.333μs(250W/80V)	
Accuracy*3	1.2kΩ: $\pm(0.2\% \text{set} + 0.1\text{S})$ 60kΩ: $\pm(0.1\% \text{set} + 0.01\text{S})$	150Ω: $\pm(0.2\% \text{set} + 0.1\text{S})$ 7.5kΩ: $\pm(0.1\% \text{set} + 0.01\text{S})$	

CONSTANT VOLTAGE + CONSTANT CURRENT MODE

Operating Range	1~16V 1~80V	1~16V	1~80V
Setting Range	0~16.32V 0~81.6V	0~16.32V	0~81.6V
Resolution	0.4mV 2mV	0.4mV	2mV
Accuracy	$\pm(0.05\% \text{set} + 0.1\% \text{F.S.})$	$\pm(0.05\% \text{set} + 0.1\% \text{F.S.})$	
Current Setting Range	0~5.1A	0~4.08A	0~40.8A
Resolution	0.125mA	0.1mA	1mA
Accuracy	$\pm(0.1\% \text{set} + 0.2\% \text{F.S.})$	$\pm(0.1\% \text{set} + 0.1\% \text{F.S.}^{*1})$	$\pm(0.1\% \text{set} + 0.2\% \text{F.S.}^{*1})$

CONSTANT POWER + CONSTANT CURRENT MODE

Operating Range	1~30W	1~25W	1~250W
Setting Range	0~30.6W	0~25.5W	0~255W
Resolution	1mV	1mV	10mV
Accuracy	$\pm(0.5\% \text{set} + 0.5\% \text{F.S.})$	$\pm(0.5\% \text{set} + 0.5\% \text{F.S.}^{*1})$	
Current Setting Range	0~5.1A	0~4.08A	0~40.8A
Resolution	0.125mA	0.1mA	1mA

Accuracy	$\pm(0.1\%set + 0.2\%F.S.)$	$\pm(0.1\%set + 0.1\%F.S.^{*1})$	$\pm(0.1\%set + 0.2\%F.S.^{*1})$
----------	-----------------------------	----------------------------------	----------------------------------

NOTE : ^{*1} F.S. = Full scale of H Range

^{*2} S (Siemens) is the unit of conductance, equal to one reciprocal ohm.

^{*3} Accuracy must be calculated in conductivity units.

DYNAMIC MODE

T1&T2	0.025ms ~ 10ms / Res: 1μs 10ms ~ 30s / Res: 1ms
-------	--

Accuracy	1us / 1ms + 100ppm
----------	--------------------

CONSTANT CURRENT MODE

Slew Rate	0.8 ~ 200mA/μs	0.64 ~ 160mA/μs	6.4 ~ 1600mA/μs
-----------	----------------	-----------------	-----------------

Slew Rate	0.8mA/μs	0.64mA/μs	6.4mA/μs
-----------	----------	-----------	----------

Resolution

Slew Rate setting	$\pm(10\% + 15\mu s)$
-------------------	-----------------------

Accuracy

Current Setting	0~5.1A	0~4.08A	0~40.8A
-----------------	--------	---------	---------

Range

Current	0.125mA	0.1mA	1mA
---------	---------	-------	-----

Resolution

Current Accuracy	$\pm 0.4\% F.S.$
------------------	------------------

CONSTANT RESISTANCE MODE

Slew Rate	0.8 ~ 200mA/μs	6.4 ~ 1600mA/μs
-----------	----------------	-----------------

Slew Rate	0.8mA/μs	6.4mA/μs
-----------	----------	----------

Resolution

Slew Rate Setting	$\pm(10\% + 50\mu s)$
-------------------	-----------------------

Accuracy

Resistance	0.3Ω~1.2kΩ	0.0375Ω ~ 150Ω(250W/16V)
------------	------------	--------------------------

Setting Range	(30W/16V)	1.875Ω ~ 7.5kΩ(250W/80V)
---------------	-----------	--------------------------

	15Ω~60kΩ	
--	----------	--

	(30W/80V)	
--	-----------	--

Resistance	83.333μs	0.666ms(250W/16V)
------------	----------	-------------------

Resolution	(30W/16V)	13.333μs(250W/80V)
------------	-----------	--------------------

	1.666μs	
--	---------	--

	(30W/80V)	
--	-----------	--

Resistance	1.2kΩ: $\pm(0.5\%set + 0.1S)$	150Ω: $\pm(0.5\%set + 0.1S)$
------------	-------------------------------	------------------------------

Accuracy	+ 0.1S)	7.5kΩ: $\pm(0.5\%set + 0.01S)$
----------	---------	--------------------------------

	60kΩ: $\pm(0.5\%set + 0.01S)$	
--	-------------------------------	--

	+ 0.01S)	
--	----------	--

MEASUREMENT

VOLTAGE READBACK

Range	0~16V	0~80V	0~16V	0~80V
Resolution	0.32mV	1.6mV	0.32mV	1.6mV
Accuracy	±(0.025% read + 0.025% F.S.)			

CURRENT READBACK

Range	0~5A	0~4A	0~40A
Resolution	0.1mA	0.08mA	0.8mA
Accuracy	±(0.05% read + 0.05% F.S.*2)		

POWER READBACK

Range	0~30W	0~25W	0~250W
Accuracy	±(0.1% read + 0.1% F.S.*1)		±(0.1% read + 0.1% F.S.*1)

NOTE : *1 Power F.S. = Vrange F.S. x Irange F.S.

*2 F.S. = Full scale of H Range

PROTECTIVE

Over Power Protection

Range	0.9~30.6W	1.25~255W
Resolution	0.15W	1.25W
Accuracy	±(2%set + 0.25%F.S.)	

Over Current Protection

Range	0.0625~5.1A	0.5~40.8A
Resolution	0.0125A	0.1A
Accuracy	±(2%set + 0.25%F.S.)	

Over Voltage Protection

Range	1~81.6V
Resolution	0.2V
Accuracy	±(2%set + 0.25%F.S.)

Over Temperature Protection

≒85°C

Rated Power Protection(CPP)

Value	33W	275W
Accuracy	±5%set	

GENERAL

SHORT CIRCUIT

Current(CC)	≒5.5/5A	≒4.4/4A	≒44/40A
Voltage(CV)	≒0V		
Resistance(CR)	≒15Ω	≒0.3Ω	≒1.875Ω
			≒0.0375Ω

Input Resistance 500kΩ(Typical)

(Load OFF)

Temperature Coefficient	100ppm/°C
Weight	Approx. 3.8kg

	PEL-2040B		PEL-2041B	
RANGE	Low	High	Low	High
CURRENT	0~7A	0~70A	0~1A	0~10A
VOLTAGE	0~80V		0~500V	
MIN.OPERATING VOLTAGE(dc)Typ.)	0.4V at 7A	0.8V at 70A	1V at 1A	2V at 10A
	0.2V at 3.5A	0.4V at 35A	0.5V at 0.5A	1V at 5A

STATIC MODE

CONSTANT CURRENT MODE

Operating Range	0~7A	0~70A	0~1A	0~10A
Setting Range	0~7.14A	0~71.4A	0~1.02A	0~10.2A
Resolution	0.2mA	2mA	0.05mA	0.5mA
Accuracy	±(0.1%set + 0.1%F.S.*1) ±(0.1%set + 0.2%F.S.) ±(0.1%set + 0.1%F.S.*1) ±(0.1%set + 0.2%F.S.)			

CONSTANT RESISTANCE MODE

Operating Range	0.025Ω~100Ω(350W/16V)	1.25Ω~5kΩ(350W/125V)	1.25Ω~5kΩ(350W/80V)	50Ω~200kΩ(350W/500V)
Setting Range	0.025Ω~100Ω(350W/16V)	1.25Ω~5kΩ(350W/125V)	1.25Ω~5kΩ(350W/80V)	50Ω~200kΩ(350W/500V)
Resolution*2	1mS(350W/16V)	20μS(350W/125V)	20μS(350W/80V)	0.5μS(350W/500V)
Accuracy*3	100Ω: ±(0.2%set + 0.1S)	5kΩ: ±(0.2%set + 0.02S)	5kΩ: ±(0.1%set + 0.01S)	200kΩ: ±(0.1%set + 0.005S)

CONSTANT VOLTAGE + CONSTANT CURRENT MODE

Operating Range	1~16V	1~80V	2.5~125V	2.5~500V
Setting Range	0~16.32V	0~81.6V	0~127.5V	0~510V
Resolution	0.4mV	2mV	2.5mV	10mV
Accuracy	±(0.05%set + 0.1%F.S.) ±(0.05%set + 0.1%F.S.)			
Current Setting Range	0~7.14A	0~71.4A	0~1.02A	0~10.2A
Resolution	0.2mA	2mA	0.05mA	0.5mA
Accuracy	±(0.1%set + 0.1%F.S.*1) ±(0.1%set + 0.2%F.S.*1) ±(0.1%set + 0.1%F.S.*1) ±(0.1%set + 0.2%F.S.*1)			

CONSTANT POWER + CONSTANT CURRENT MODE

Operating Range	1~35W	1~350W	1~35W	1~350W
Setting Range	0~35.7W	0~357W	0~35.7W	0~357W

Resolution	1mW	10mW	1mW	10mW
Accuracy	$\pm(0.5\%set + 0.5\%F.S.^{*1})$	$\pm(0.5\%set + 0.5\%F.S.)$	$\pm(0.5\%set + 0.2\%F.S.^{*1})$	$\pm(0.5\%set + 0.5\%F.S.)$
Current Setting Range	0~7.14A	0~71.4A	0~1.02A	0~10.2A
Resolution	0.2mA	2mA	0.05mA	0.5mA
Accuracy	$\pm(0.1\%set + 0.1\%F.S.^{*1})$	$\pm(0.1\%set + 0.2\%F.S.^{*1})$	$\pm(0.1\%set + 0.1\%F.S.^{*1})$	$\pm(0.1\%set + 0.2\%F.S.^{*1})$

NOTE : ^{*1} F.S. = Full scale of H Range

^{*2} S (Siemens) is the unit of conductance, equal to one reciprocal ohm.

^{*3} Accuracy must be calculated in conductivity units.

DYNAMIC MODE

T1&T2	0.025ms~10ms/Res: 1μs 10ms ~ 30s / Res: 1ms
Accuracy	1us / 1ms ± 100ppm

CONSTANT CURRENT MODE

Slew Rate	0.001 ~ 0.28A/μs	0.01 ~ 2.8A/μs	0.16 ~ 40mA/μs	1.6 ~ 400mA/μs
Slew Rate	0.001A/μs	0.01A/μs	0.16mA/μs	1.6mA/μs
Resolution				
Slew Rate Setting Accuracy	±(10% + 15us)			
Current Setting Range	0~7.14A	0~71.4A	0~1.02A	0~10.2A
Current Resolution	0.2mA	2mA	0.05mA	0.5mA
Current Accuracy	±0.4% F.S.		±0.4% F.S.	

CONSTANT RESISTANCE MODE

Slew Rate	0.01 ~ 2.8A/μs	1.6 ~ 400mA/μs
Slew Rate	0.01A/μs	1.6mA/μs
Resolution		
Slew Rate Setting Accuracy	±(10% + 50μs)	
Resistance Setting Range	0.025Ω~100Ω(350W/16V)	1.25Ω~5kΩ(350W/125V)
Resistance Setting Range	1.25Ω~5kΩ(350W/80V)	50Ω~200kΩ(350W/500V)
Resistance Resolution	1ms(350W/16V)	20μs(350W/125V)
Resistance Resolution	20μSs(350W/80V)	0.5μs(350W/500V)
Resistance Accuracy	100Ω: ±(0.5%set + 0.1S)	5KΩ: ±(0.5%set + 0.02S)
Resistance Accuracy	5kΩ: ±(0.5%set + 0.01S)	200kΩ: ±(0.5%set + 0.005S)

MEASUREMENT

VOLTAGE READBACK

Range	0~16V	0~80V	0~125V	0~500V
Resolution	0.32mV	1.6mV	2.5mV	10mV
Accuracy	$\pm(0.025\% \text{ read} + 0.025\% \text{ F.S.})$			

CURRENT READBACK

Range	0~7A	0~70A	0~1A	0~10A
Resolution	0.14mA	1.4mA	0.02mA	0.2mA
Accuracy	$\pm(0.05\% \text{ read} + 0.05\% \text{ F.S.}^{*2})$			

POWER READBACK

Range	0~35W	0~350W	0~35W	0~350W
Accuracy	$\pm(0.1\% \text{ read} + 0.1\% \text{ F.S.}^{*1})$			

NOTE : ^{*1} Power F.S. = Vrange F.S. x Irange F.S.

^{*2} F.S. = Full scale of H Range

PROTECTIVE

Over Power Protection

Range	1.75~357W		
Resolution	1.75W		
Accuracy	$\pm(2\% \text{ set} + 0.25\% \text{ F.S.})$		

Over Current Protection

Range	0.875~71.4A	0.125~10.2A
Resolution	0.175A	0.025A
Accuracy	$\pm(2\% \text{ set} + 0.25\% \text{ F.S.})$	

Over Voltage Protection

Range	1~81.6V	2.5~510V
Resolution	0.2V	1.25V
Accuracy	$\pm(2\% \text{ set} + 0.25\% \text{ F.S.})$	

Over $\cong 85^{\circ}\text{C}$

Temperature
Protection

Rated Power Protection(CPP)

Value	385W
Accuracy	$\pm 5\% \text{ set}$

GENERAL

SHORT CIRCUIT

Current(CC)	$\cong 7.7/7\text{A}$	$\cong 77/70\text{A}$	$\cong 1.1/1\text{A}$	$\cong 11/10\text{A}$
Voltage(CV)	$\cong 0\text{V}$			
Resistance(CR)	$\cong 1.25\Omega$	$\cong 0.025\Omega$	$\cong 50\Omega$	$\cong 1.25\Omega$

Input Resistance (Load OFF)	500k Ω (Typical)
Temperature Coefficient	100ppm/ $^{\circ}$ C
Weight	Approx. 3.8kg

Dimensions

PEL-2002B

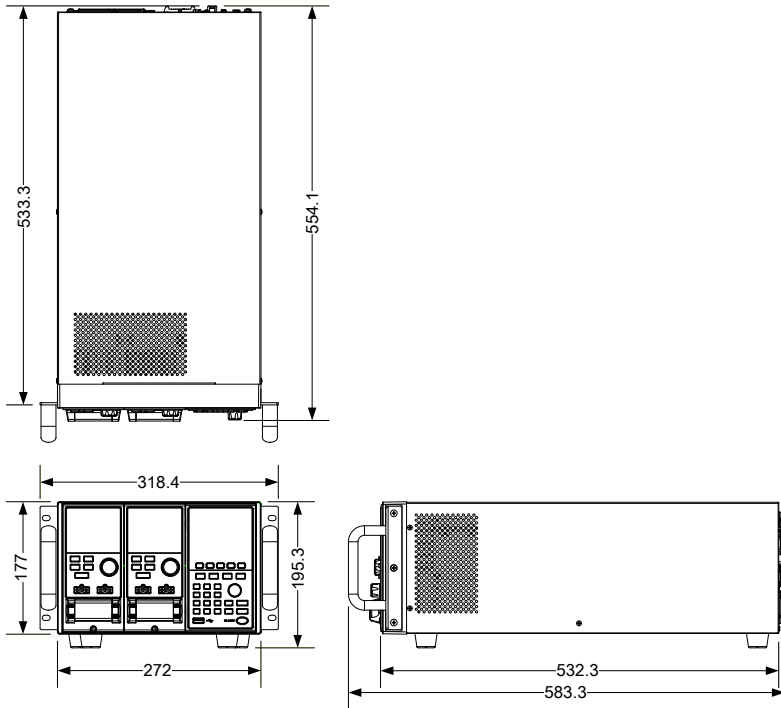

PEL-2004B

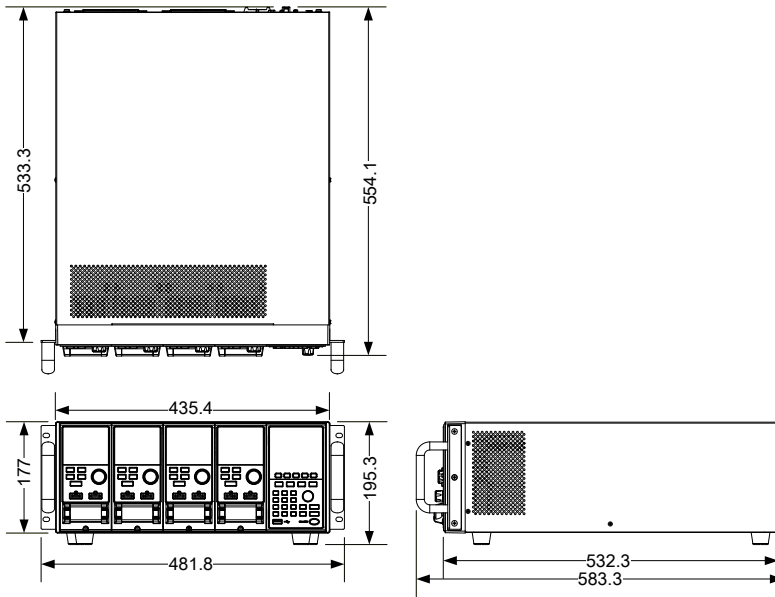

PEL-2020B/PEL-2030B/PEL-2040B/PEL-2041B

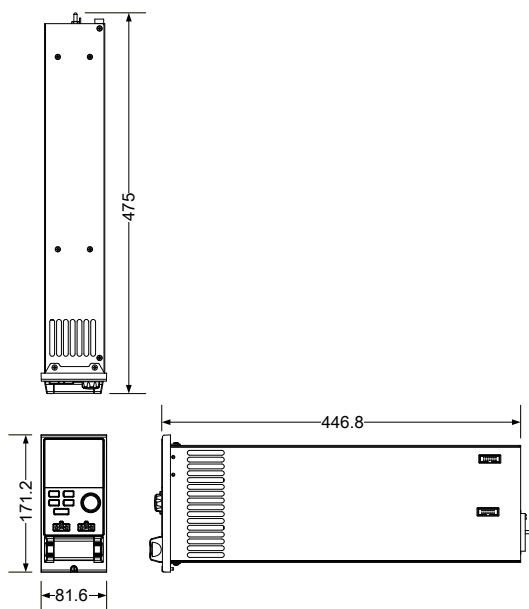

Certificate Of Compliance

We

GOOD WILL INSTRUMENT CO., LTD.

declare that the CE marking mentioned product

satisfies all the technical relations application to the product within the scope of council:

Directive: EMC; LVD; WEEE; RoHS

The product is in conformity with the following standards or other normative documents:

© EMC	
EN 61326-1	Electrical equipment for measurement, control and laboratory use -- EMC requirements
Conducted & Radiated Emission EN 55011 / EN 55032	Electrical Fast Transients EN 61000-4-4
Current Harmonics EN 61000-3-2 / EN 61000-3-12	Surge Immunity EN 61000-4-5
Voltage Fluctuations EN 61000-3-3 / EN 61000-3-11	Conducted Susceptibility EN 61000-4-6
Electrostatic Discharge EN 61000-4-2	Power Frequency Magnetic Field EN 61000-4-8
Radiated Immunity EN 61000-4-3	Voltage Dip/ Interruption EN 61000-4-11 / EN 61000-4-34
© Safety	
EN 61010-1 :	Safety requirements for electrical equipment for measurement, control, and laboratory use - Part 1: General requirements

GOODWILL INSTRUMENT CO., LTD.

No. 7-1, Jhongsing Road, Tucheng District, New Taipei City 236, Taiwan

Tel: [+886-2-2268-0389](tel:+886-2-2268-0389)

Fax: [+886-2-2268-0639](tel:+886-2-2268-0639)

Web: <http://www.gwinstek.com>

Email: marketing@goodwill.com.tw

GOODWILL INSTRUMENT (SUZHOU) CO., LTD.

No. 521, Zhujiang Road, Snd, Suzhou Jiangsu 215011, China

Tel: [+86-512-6661-7177](tel:+86-512-6661-7177)

Fax: [+86-512-6661-7277](tel:+86-512-6661-7277)

Web: <http://www.instek.com.cn>

Email: marketing@instek.com.cn

GOODWILL INSTRUMENT EURO B.V.

De Run 5427A, 5504DG Veldhoven, The Netherlands

Tel: [+31-\(0\)40-2557790](tel:+31-(0)40-2557790)

Fax: [+31-\(0\)40-2541194](tel:+31-(0)40-2541194)

Email: sales@gw-instek.eu

I NDEX

- Alarm configuration206, 217
- All Chan save/recall
 - description94
- Baud rate configuration.....221
- Brightness & contrast....202, 212
- Calibration287
- Calibration key19
- CC vrange mode description.83
- CC+CV mode.....66
- Channel configuration
 - CC voltage range..... 177
 - Go/NoGo mode 191
 - Go/NoGo On/Off.....193
 - Independent setting.....184
 - Load delay time.....185
 - Parallel mode 194
 - Protection All Clear..... 176
 - Response time..... 190
 - SPEC test ON/OFF 193
 - Step resolution..... 187
- Channel configuration
 - Configuration menu..... 172
 - OCP/OCV/OPP..... 173
- Channel configuration
 - Von voltage configuration . 178
- Channel configuration
 - Short..... 180
- Channel configuration
 - channel control 182
- Channel control configuration182, 270
- Channel control connection...55
- Channel control description ..87
- Channel control mode
 - description84
- Channel duration time
 - settings mode description..78
- Cleaning the instrument.....8
- Clear key20
- Configuration mode
 - description81
- Connection
 - Channel control.....55
 - Frame link.....53
 - Go/NoGo control58
 - Remote sense.....48
 - Wire gauge44
 - Wire Inductance.....44
- Connection procedure46
- Constant power mode
 - description68
- Constant Resistance mode
 - description63
- Constant voltage + constant
 - current mode description...66
- Constant voltage mode
 - description65
- Declaration of conformity310
- Default Settings293
- Delay time mode description 85
- Dimensions307
- Display key30
- Display settings202, 212
- Disposal instructions9
- Dynamic constant current
 - mode description61
- Dynamic loads Constant
 - Resistance mode description64
- EN61010
 - measurement category7
 - Pollution degree.....8
- Enter key22
- Environment
 - operation.....8
 - Storage9

External memory save description.....	93	Language Settings	210
External voltage mode description.....	87	List of features	12
Features.....	12	Load (module) key	31
File format mode description	95	Load connections.....	43
Firmware update	284	Load Connections	
Frame control configuration	203, 212, 214, 215	Auxiliary voltage connection	50
Frame Link configuration....	272	DC Connection	50
Frame link connection	53	Dual channel load module ...	49
Front panel overview	18	Low voltage connections.....	50
Function Keys	18	Multiple output power source	52
Fuse		Parallel load modules	51
rating.....	8	Parallel loads.....	51
Fuse replacement.....	283	Parallel mainframes	52
Go/NoGo Alarm Sound.....	207	Precautions.....	43
Go/NoGo connection	58	Single channel load module.	49
Go/NoGo constant current mode description.....	62	Single load	49
Go/NoGo constant Resistance mode description.....	65	Load delay time configuration	185
Go/NoGo constant voltage mode description.....	67	Load D-Time mode	
Go/NoGo interface configuration.....	275	description.....	85
GPIB card installation.....	38	Load key	22
GPIB configuration.....	225, 269	Load Menu	200
Independent configuration .	184	Load module installation	36
Independent mode description	84	Load module Overview.....	30
Installation		Load profiling description	75
GPIB card	38	Load terminals	31
Load module.....	36	Load wire induction.....	44
Rack mount.....	39	Load wiring	45
Interface configuration	268	Local operation	
Baud Rate	221	A&B Value.....	116
GPIB.....	225	Channel selection	116
Interface menu.....	221	coarse mode	120
RS232	221	Display.....	119
USB configuration.....	223	Dynamic	117
Internal memory save description.....	93	Editing the load	120
Knob configuration	205, 215	fine mode.....	120
		Load	118
		Operation.....	116
		R/L keys	116
		Shorting	119
		Static.....	117
		Lock key.....	20
		Mainframe configuration	
		alarm sound	206, 217

- Brightness & contrast.. 202, 212
- Configuration menu..... 198
- Frame control 203, 212, 214, 218
- Go/NoGo Tone 207
- Knob type 205, 215
- Language 210
- Load menu 200
- Slave knob 208, 218
- Speaker 201, 211
- System Info..... 198
- Utility menu 198
- Mainframe operation
 - CC Dynamic mode..... 125
 - CC Mode..... 124
 - CC Range..... 124
 - CC Static Values..... 128
 - Channel duration time
 - settings 161
 - Channel Selection..... 122, 123
 - CP Current limit 142
 - CP mode 141
 - CP Power values..... 142
 - CP range 139, 144
 - CR Range..... 131
 - CR Static Parameters..... 135
 - CR Dynamic mode 132
 - CR mode 130
 - CR Static mode 134
 - CV Current limit..... 138
 - CV mode 137
 - CV response speed 140
 - CV Voltage values 138
 - Edit Sequence..... 157
 - OCP test automation..... 166
 - Program chain..... 149
 - Program Execution..... 152
 - Program Sequences 145
 - Programming..... 145
 - Recall default chain..... 151
 - Recall default sequence 149
 - Run Sequence..... 164
 - Save chain..... 151
 - Save Program chain 151
 - Save sequence 149
 - Sequence loop 159
 - Trig out 161
 - Measurement types..... 16, 17
 - Memory data description..... 91
 - Number pad..... 19
 - OCP test automation..... 166
 - OCP Test Automation
 - description 79
 - Operating configurations
 - mode description 83
 - Operating Description 59
 - Operating Modes
 - Channel duration time
 - settings..... 78
 - Configuration..... 81
 - Configuration - Over current
 - protection 82
 - Configuration - Over power
 - protection 82
 - Configuration - Over voltage
 - protection 82
 - Constant current - Go/NoGo62
 - Constant current - Slew rate 62
 - Constant current -Dynamic . 61
 - Constant current -static..... 61
 - Constant Power..... 68
 - Constant Resistance..... 63
 - Constant Resistance -
 - Dynamic loading..... 64
 - Constant Resistance - Slew
 - rate 65
 - Constant Resistance
 - Go/NoGo 65
 - Constant Voltage 65
 - Constant Voltage - Response
 - speed 67
 - Constant Voltage + Constant
 - Current Mode 66
 - Constant Voltage -Go/NoGo67
 - Constant Voltage -levels..... 66
 - External Voltage Control 87
 - File format 95
 - File System..... 90
 - Go/NoGo 74

Interface.....	90	Parallel Dynamic loading	
Memory data	91	description.....	80
Operating Configuration s -		pass/fail test	
Von Voltage.....	83	multiple step tutorial	98
Operating Configurations....	83	Power key	22
Operating Configurations -		Power supply	
CC vrange.....	83	Safety information.....	7
Operating Configurations -		Power up	41
independent	84	Power up sequence	41
Operating Configurations -		Preset data description	91
Load D-Time	85	Preset key	21
Operating Configurations -		Program Chain mode	
Short	86	description.....	74
Operating Configurations -		Program mode description ...	72
Step Resolution	85	Protection All clear.....	176
Parallel Dynamic Loading ...	80	Quick save Presets to internal	
Preset data.....	91	memory.....	260
Program Chain	74	R/L key	30
Reverse voltage protection ..	83	Rack mount installation.....	39
Run Program	72	Range Chart.....	288
save/recall All Chan.....	94	Recall factory defaults.....	263
SEQ data.....	92	Recall Memory data to USB	245
Sequences.....	75	Recall Presets - Framelink ...	262
Setup data	92	Recall Setups - Framelink	261
Trig Out.....	77	Remote control	
USB save/recall.....	94	sockets function check	227, 230
Operation		UART configuration	279
Contents	113	Remote control function check	
Local load.....	116	GPIB.....	230
Operation Environment	8	Remote sense connections....	48
Operation keys.....	21	Response speed constant	
Over Current mode		voltage mode description..	67
description.....	82	Response time.....	190
Over power mode description	82	Reverse voltage protection....	83
Over protection		RS232 configuration	221
configuration	173	Safety Instructions.....	6
Over voltage mode		Safety symbols	6
description.....	82	Save Memory data.....	232
Overview	14	Save Memory data to USB...	245
Display Overview	23	Save Preset memory.....	234
Front panel.....	18	Save presets to USB	250
LED display	33	Save Sequences to USB	255
Load module.....	30		
Rear Panel	27		

- Save setup memory.....236
- Save setup to USB243
- Save to internal memory232, 238
- Save to internal setup memory236
- Save/Recall
 - default USB path 238
 - FrameLink Preset Recall..... 262
 - FrameLink Setup Recall..... 261
 - Preset memory 234
 - Quick save Presets to internal memory 260
 - Recall factory defaults 263
 - Recall Memory data to USB245
 - Save Memory data to USB.. 245
 - Save Preset Memory 234
 - Save presets to USB.....250
 - Save SEQ (Sequences) to USB255
 - Save setup to USB..... 243
 - Save to internal Memory 238
 - Save to setup Memory 236
 - Setup memory..... 236
 - USB path..... 238
- Save/Recall
 - Memory data..... 232
 - Save to internal Memory 232
- Selector Knob.....20
- SEQ data description92
- Sequence editing/creating...157
- Sequence mode description...75
- Sequences mode description .72
- service contance point282
- Setting the date and time219
- Setup data description.....92
- Shift key.....21
- Short configuration180
- Short key32
- Shorting mode description86
- Slave knob
 - settings..... 208, 218
- Slave knob
 - description..... 32
- Slew rage constant current
 - mode description62
- Slew rate Constant Resistance
 - mode description65
- Socket server function check227, 230
- Speaker Settings201, 211
- Specifications296
- Static constant current mode
 - description61
- Static/ Dynamic key32
- Step resolution.....187
- Step Resolution mode
 - description85
- Storage Environment.....9
- System Info198
- System Keys.....18
- Terminals.....31
- Trig out161
- Trig out mode description77
- Tutorials
 - Channel control.....109
 - Frame link.....107
 - General configuration options111
 - Local load98
 - Parallel load.....102
 - Program106
 - Single load100
- Tutorials
 - Basic Operation.....97
- Twisted pair description45
- USB configuration.....223
- USB path.....238
- USB remote interface
 - connection.....276
- USB save/recall description ..94
- Utility Menu.....198
- Voltage levels constant
 - voltage mode description ..66
- Voltage sense terminal31
- Von voltage configuration ...178
- Von voltage mode description83
- Wire Connections.....43
- Wire gauge.....43
- Wire induction.....44

Wiring procedure..... 46