

Handheld Digital Storage Oscilloscope with DMM

GDS-200 and GDS-300 Series

USER MANUAL



ISO-9001 CERTIFIED MANUFACTURER

GW INSTEK

This manual contains proprietary information, which is protected by copyright. All rights are reserved. No part of this manual may be photocopied, reproduced or translated to another language without prior written consent of Good Will company.

The information in this manual was correct at the time of printing. However, Good Will continues to improve products and reserves the rights to change specification, equipment, and maintenance procedures at any time without notice.

Good Will Instrument Co., Ltd.
No. 7-1, Jhongsing Rd., Tucheng Dist., New Taipei City 236, Taiwan.

Table of Contents

SAFETY INSTRUCTIONS	5
GETTING STARTED	10
GDS-200 and GDS-300 Series Overview	12
Appearance	15
Initial Setup	30
OPERATION	37
Gesture Control	41
Common Menu UI Elements	47
Vertical Menu Operation	50
Trigger Menu Operation	66
Trigger Setting	68
Run Mode	80
Cursor Measurements	83
Automatic Measurements	87
Drop-Down Menu	95
Utility Menu	97
Acquire Menu	108
Display Menu	113
Go-NoGo Menu	119
Save Operations	125
Recall Operations	136
File Manager	140
DMM Mode	144
EE APPs	155
REMOTE CONTROL CONFIG	166
Interface Configuration	167
FAQ	173

APPENDIX	175
Firmware Update	177
Fuse Replacement	178
Resistor Standards	179
GDS-200/300 Default Settings	182
GDS-200/300 Specifications	183
GDS-200/300 Dimensions	188
Declaration of Conformity	189
 INDEX.....	 190

S SAFETY INSTRUCTIONS

This chapter contains important safety instructions that you must follow during operation and storage. Read the following before any operation to insure your safety and to keep the instrument in the best possible condition.

Safety Symbols

These safety symbols may appear in this manual or on the instrument.



WARNING

Warning: Identifies conditions or practices that could result in injury or loss of life.



CAUTION

Caution: Identifies conditions or practices that could result in damage to the instrument or to other properties.



DANGER High Voltage



Attention Refer to the Manual



Do not dispose electronic equipment as unsorted municipal waste. Please use a separate collection facility or contact the supplier from which this instrument was purchased.

Safety Guidelines

General Guideline



CAUTION

- Do not place any heavy object on the instrument.
- Avoid severe impact or rough handling that leads to damaging the instrument.
- Do not discharge static electricity to the instrument.
- Use only mating connectors, not bare wires, for the terminals.
- Do not block the cooling fan opening.
- Do not disassemble the instrument unless you are qualified.
- Do not use sharp objects or press with undue force on the touch screen display.
- Do not apply more than 300Vrms (CAT II, DSO inputs); 600V (CAT II, DMM inputs) or 300V (CAT III, DMM inputs).

(Measurement categories) EN61010-1:2010, EN61010-2-030 and EN61010-2-033 specify the measurement categories and their requirements as follows. The GDS-200/300 falls under category II & III.

- Measurement category IV is for measurement performed at the source of low-voltage installation.
 - Measurement category III is for measurement performed in the building installation.
 - Measurement category II is for measurement performed on the circuits directly connected to the low voltage installation.
 - Measurement category 0 is for measurements performed on circuits not directly connected to Mains.
-

AC Adapter
Power Supply
(AC Mains)



WARNING

- AC Input voltage range: 100VAC-240VAC
- Frequency: 47Hz-63Hz
- Output: 12 DCV, 36W Max
- To avoid electrical shock connect the protective grounding conductor of the AC power cord to an earth ground.

Power Supply
(DC)

- DC Input voltage range (10.5-13.5 V DC, 3A)

Cleaning the
Instrument

- Disconnect the power cord before cleaning.
- Use a soft cloth dampened in a solution of mild detergent and water. Do not spray any liquid.
- Do not use chemicals containing harsh material such as benzene, toluene, xylene, and acetone.

Operation
Environment

- Location: Indoor, no direct sunlight, dust free, almost non-conductive pollution (Note below)
- Relative Humidity: 20%- 85%
- Altitude: < 2000m
- Temperature: 0°C to 50°C

(Pollution Degree) EN 61010-1:2010 specifies the pollution degrees and their requirements as follows. The instrument falls under degree 2.

Pollution refers to “addition of foreign matter, solid, liquid, or gaseous (ionized gases), that may produce a reduction of dielectric strength or surface resistivity”.

- Pollution degree 1: No pollution or only dry, non-conductive pollution occurs. The pollution has no influence.
- Pollution degree 2: Normally only non-conductive pollution occurs. Occasionally, however, a temporary conductivity caused by condensation must be expected.
- Pollution degree 3: Conductive pollution occurs, or dry, non-conductive pollution occurs which becomes conductive due to condensation which is expected. In such conditions, equipment is normally protected against exposure to direct sunlight, precipitation, and full wind pressure, but neither temperature nor humidity is controlled.

Storage environment

- Location: Indoor
 - Temperature: -25°C to 70°C
 - Relative Humidity: <90%
-

Disposal

Do not dispose this instrument as unsorted municipal waste. Please use a separate collection facility or contact the supplier from which this instrument was purchased. Please make sure discarded electrical waste is properly recycled to reduce environmental impact.

Battery

- Type: Rechargeable Li-ion polymer
 - Model: FT8862103P
 - Manufacturer: Chinese Precision Technology (Assembled in China)
 - Rating: 7.4Vdc \approx , 6100mAh (45 Watt)
-

**Battery Caution**

- The internal battery should not be replaced by the end-user. Please return the unit back to your local dealer for assistance.
 - Never allow the battery to come in contact with fire or water.
 - Discard used batteries according to the manufacturer's instructions or local laws.
 - Read the manual before use.
-

Power cord for the United Kingdom

When using the instrument in the United Kingdom, make sure the power cord meets the following safety instructions.

NOTE: This lead/appliance must only be wired by competent persons



WARNING: THIS APPLIANCE MUST BE EARTHED

IMPORTANT: The wires in this lead are coloured in accordance with the following code:

Green/ Yellow:	Earth
Blue:	Neutral
Brown:	Live (Phase)



As the colours of the wires in main leads may not correspond with the coloured marking identified in your plug/appliance, proceed as follows:

The wire which is coloured Green & Yellow must be connected to the Earth terminal marked with either the letter E, the earth symbol  or coloured Green/Green & Yellow.

The wire which is coloured Blue must be connected to the terminal which is marked with the letter N or coloured Blue or Black.

The wire which is coloured Brown must be connected to the terminal marked with the letter L or P or coloured Brown or Red.

If in doubt, consult the instructions provided with the equipment or contact the supplier.

This cable/appliance should be protected by a suitably rated and approved HBC mains fuse: refer to the rating information on the equipment and/or user instructions for details. As a guide, a cable of 0.75mm² should be protected by a 3A or 5A fuse. Larger conductors would normally require 13A types, depending on the connection method used.

Any exposed wiring from a cable, plug or connection that is engaged in a live socket is extremely hazardous. If a cable or plug is deemed hazardous, turn off the mains power and remove the cable, any fuses and fuse assemblies. All hazardous wiring must be immediately destroyed and replaced in accordance to the above standard.

G ETTING STARTED

This chapter will allow you to quickly set up a GDS-200 or GDS-300 series oscilloscope and run over the basic operation and features.

Before you can get started, you will need to check the package contents (standard accessories, page 14). After the contents are checked the Overview section will describe all the major features and functions of the oscilloscopes in the GDS-200 and GDS-300 series. The Appearance section will go over the front, rear and side panels of the instrument. The Display Overview will give a brief introduction to the display and how the display changes depending on the current function, orientation or mode. Lastly the Getting Started section will explain how to turn on the instrument, explain how to set up the instrument, and go over the gestures and operating conventions that are used with the capacitive touch panel on the unit.



GDS-200 and GDS-300 Series Overview	12
Series Lineup	12
Main Features	12
Accessories.....	14
Appearance	15
GDS-200/300 Front Panel.....	15
Rear Panel	17
Interface Panel.....	18
BNC Panel.....	20
Display Overview.....	21
Horizontal	21
Vertical.....	22
How to Use the Touch Interface.....	25
Help Menu.....	28
Initial Setup	30
Power Up.....	30
USB Driver Installation	31
Tilting the Stand.....	32
Setting the System Date & Time	33
Setting the Language	34
Switching Horizontal and Vertical View.....	34
Compensating a Probe	34

GDS-200 and GDS-300 Series Overview

Series Lineup

There are 6 models in the series, divided by DSO bandwidth, DSO memory depth, DMM digit resolution and the DMM temperature function.

Model name	Bandwidth	Memory depth	DMM Resolution	Temperature measurement
GDS-207	70MHz	1M points per channel	3½	No
GDS-210	100MHz			
GDS-220	200MHz			
GDS-307	70MHz	5M points per channel	4½	Yes
GDS-310	100MHz			
GDS-320	200MHz			

Note: Throughout the user manual, when we are referring to any of the models generically, we will write “GDS”, “GDS-200” or “GDS-300”, unless explicitly stated otherwise.

Main Features

- Performance
- 1 G Sa/s sampling rate max
 - 70/100/200MHz bandwidth
 - Acquisition memory: 5Mpts for GDS-300 series; 1Mpts for GDS-200 series
 - Max 300Vrms (CAT II, DSO); 600V (CAT II) or 300V (CAT III) for DMM
 - 30,000 Waveforms can be replayed

- Features
- Simultaneous DMM and DSO operation
 - Portrait and landscape modes
 - Large 800 × 480 TFT panel and capacitive touch panel
 - 7.4V/6100mAH battery for up to 4 hours operation
 - Support for differential probes
 - Handy APPs – EE calculator, Resistance calculator, Attenuation calculator
 - Shielded BNC terminals
 - DSO Features
 - X-Y mode
 - Go/No Go
 - 36 automatic measurement functions
 - Trend plot
 - Edge, Alt, Video and Pulse trigger functions
 - FFT, FFTrms, +, -, /, * math functions
 - Replay function
 - DMM Features
 - 50,000 counts
 - DCV, DCA, ACV, ACA, R, Diode, Continuity, Temperature
 - Fuse protection for the current ports
-
- Interface
- Mini-B USB device port

Accessories

Standard Accessories	Part number	Description
		Certificate of calibration
		User manual CD
	GAP-001	AC-DC adapter
	GTP-150B-2	150MHz Probe. for GDS-207 /307, GDS-210 /310
	GTP-250B-2	250MHz Probe. for GDS-220 /320
	GTL-207	Multimeter test lead x1
	GSC-010	Soft carrying case (large)
	GSC-011	Protection bag (small)
	GWS-001	Wrist strap
Optional Accessories	Part number	Description
	GDP-040D	Dual-channel Differential Probe, Only for GDS-200/300
	GTL-253	Type A - Mini-B USB cable
	GCL-001	Vertical Calibration cable
	GPF-700	Protective film for LCD screen
Download	Name	Description
	dso_vpo.inf	USB driver

Appearance

GDS-200/300 Front Panel

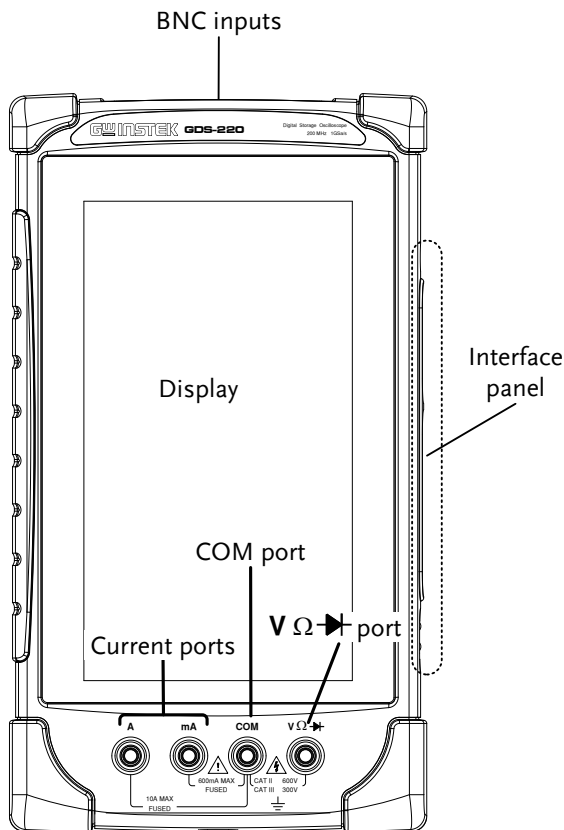

Display Color LCD screen, 800 x 480, capacitive touch.

Interface Panel The interface panel holds a number of different interfaces such as the input power socket, USB device port and the options power port. See page 18 for details.

DMM Ports

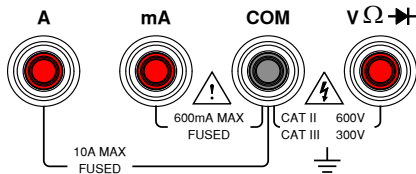

mA Accepts up to 600mA.
Fuse protection: 1A.

A Accepts up to 10A.
Fuse protection: 10A

COM Com port

v Ω → Voltage, Resistance and Diode port.

Max voltage: 600V

Rear Panel

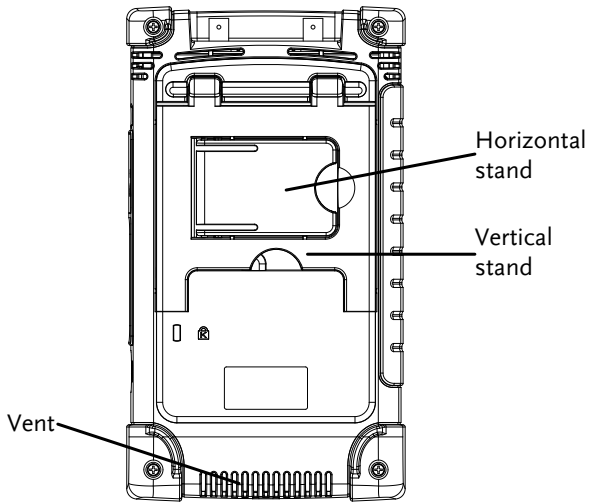

Vent Do not block the vent opening.

Vertical Stand Use the vertical stand to position the unit vertically.

Horizontal Stand Use the horizontal stand to use the unit horizontally.

Interface Panel

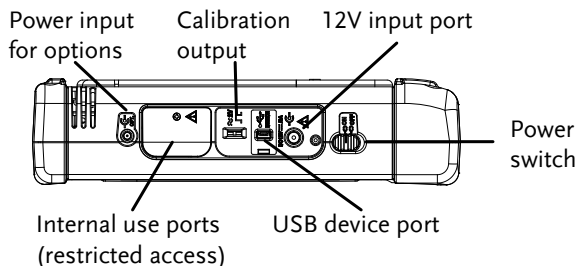

Power Switch



Power switch to turn the unit on or off.

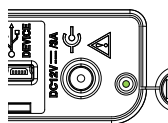

DC input. This port is used for charging the internal lithium battery. Accepts power from the supplied AC-DC power adapter.

Input Voltage: 10.5V - 13.5V

Input Current: At least 3.5A.

USB Device Port

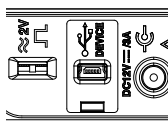

Mini-B USB device port. This port is used access the internal 120MB flash memory. When connected to a PC, the GDS-200/300 will be recognized as an external hard disk.

Calibration Port

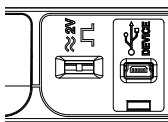

The calibration port is used to output a 2Vpk-pk 1kHz square wave for probe calibration purposes.

Internal Use Port

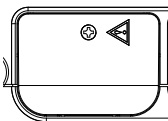

This panel houses two ports that are for internal use only. Use of these ports are restricted and not for end-user use.

External Power
Port.

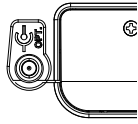

This port supplies power for optional accessories such as the differential probe option (GW part number: GDP-040D)

Voltage output: 5V

Current output: 250mA

BNC Panel

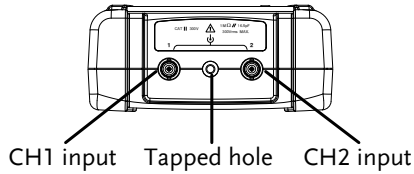

CH1, CH2 Inputs Channel 1 and channel 2 BNC inputs.

Input impedance: $1M\Omega$

Input Capacitance: 16.5pF

Max voltage: 300V max (CAT II)

Tapped Hole

The tapped hole is used to secure the differential probe option to the GDS-200/300. See the differential probe manual for details.

Display Overview

Horizontal

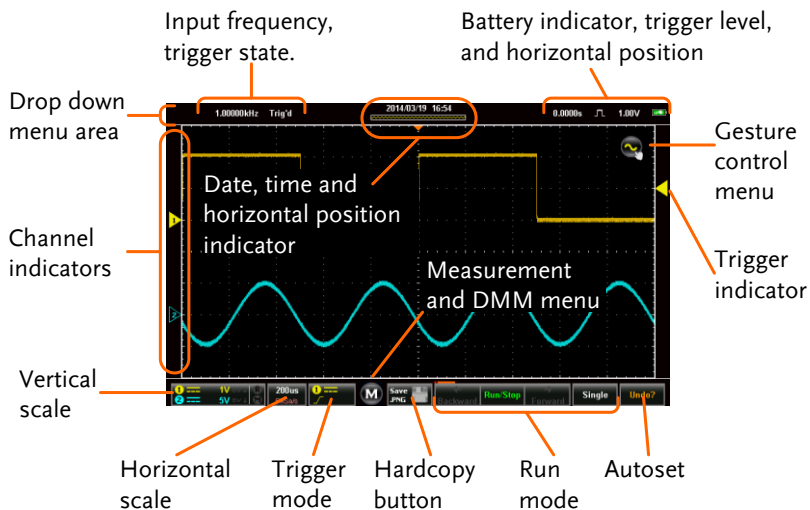

Vertical

In order: Input frequency, trigger state, time, horizontal position, acquisition mode, trigger level, battery indicator.

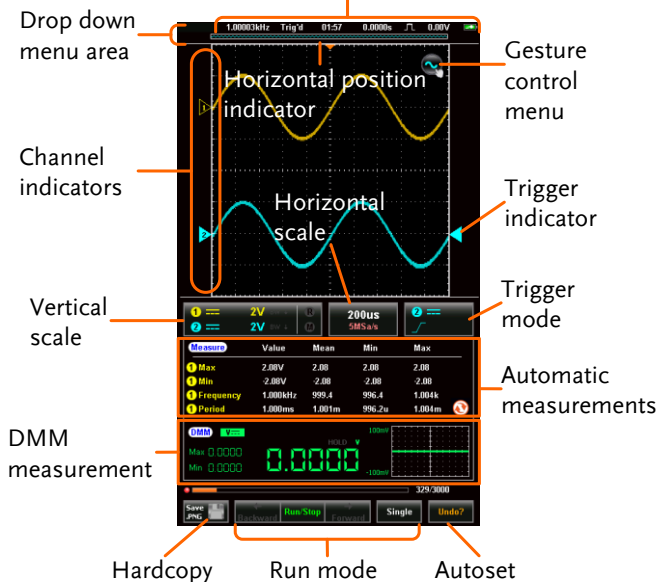

Input Frequency	Displays the triggered signal frequency.
Trigger State	Indicates the trigger state: Trig'd (triggered) Stop <2Hz
Date and Time	Displays the date (horizontal only) and time. See page 33 to set the time.
Horizontal Position	Shows the horizontal position.
Acquisition Mode	Displays the acquisition mode (Sample, Peak Detect, Average)

Horizontal Window Indicator	Shows the current horizontal scale and position in relation to the record length.
Drop Down Menu Area	Tapping anywhere in the title bar will trigger the drop down menu.
Gesture Control Menu	The gesture control menu allows you to configure whether the touch gestures control the input waveforms or the cursors. This menu will also turn the cursor display on or off.
Channel Indicators	The channel indicator shows the vertical position of each active channel.
Trigger Indicator	Selects the trigger input channel and selects the trigger source.
Vertical Scale	Shows the vertical scale of each active channel. Indicates whether any of the reference or math channels are activated.
Horizontal Scale	Indicates the horizontal scale and the sampling rate.
Trigger Mode	Shows and configures the trigger settings.
Automatic Measurements	Shows the automatic measurements. The automatic measurements can be minimized or hidden when used in the horizontal mode.
DMM Measurements	Shows the DMM measurements. When in the horizontal view the DMM measurements can be minimized or even hidden.
Hardcopy Key	The Hardcopy key is used as a quick-save key either for image screenshots, waveforms, setup files or all of the above.

Run Mode (Backward, Run/Stop, Forward, Single)	The Run/Stop key is used to start/stop acquiring samples. The Forward/Backward keys step backward/forward through each consecutively sampled waveform. The Single key puts the trigger into single mode.
Autoset	The Autoset function automatically configures the panel settings to position the input signal to the best viewing condition.

How to Use the Touch Interface

Background

Unlike other oscilloscopes or digital multimeters, the GDS-200 and GDS-300 Series have no physical hardware keys, therefore operation is completely controlled using the capacitive touch screen. Using a capacitive touch screen is a new interface paradigm for DSOs; the gestures and general user interface is easier to use and more intuitive than traditional DSO interfaces. Before you begin to use these instruments, we highly recommend you take a few moments to get to know the basic gestures and interface conventions.

Basic Gestures

There are a few basic gestures that can be used to operate the GDS-200/GDS-300. When asked to perform a gesture throughout the user manual, you can refer to the gestures below.

Tap / Press

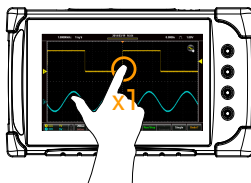

Tap/Press once to select an item.

The gesture will be recognized after you lift your finger off the display.

Long Press / Tap & Hold



Press and hold an item until a sub-menu system or secondary option appears.

Swipe

Horizontally swipe on the screen.

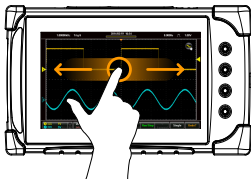

Scroll

Drag your finger vertically on the screen to scroll.

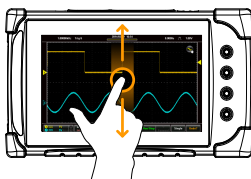

Pinch In

Pinch the screen to zoom out (make the waveforms smaller), or spread your fingers apart to zoom in (make the waveforms larger).

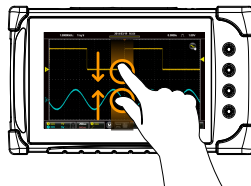

Pinch Out



Drag and drop



Drag an item to an option and let go*.

*The drag and drop gesture is usually used in the Horizontal, Vertical or Trigger menu to manually set a positional value.

Help Menu

Background

If at any time you are not sure how to use a particular function, the help icon can be used to put an overlay on the screen to show the basic function of each icon.

Steps

Tap the title bar on the top of the LCD display to bring up the Drop Down menu.

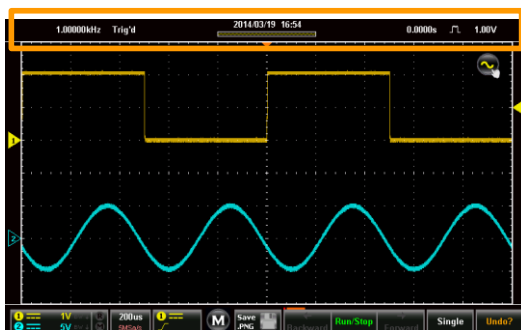

Tap on the Utility icon.



Tap on the Help option in the Utility menu.

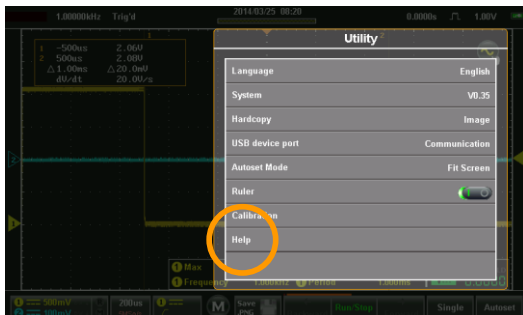

The help screen overlay is shown on the display. There are three help screens. Use the numbered icons, **1**, **2**, **3**, to view the corresponding help screen. Use the exit icon  to exit from the help screen.

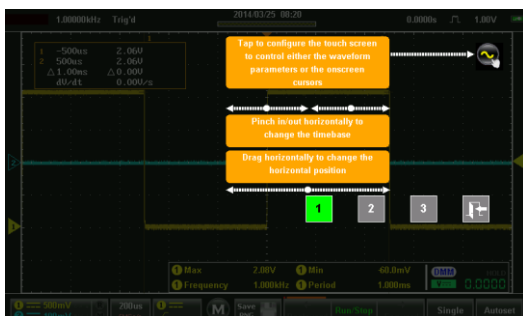

Initial Setup

This chapter should be used to set up the instrument when used for the first time or if the firmware has been updated.

Power Up

Requirements	Before the unit is powered up for the first time, it is recommended that the unit is first fully charged.
--------------	-----------------------------------------------------------------------------------------------------------

- | | |
|-------|----------------------------------------------------------------------------------------------------------------------------------------------------------------------------------------------------------------------------------------------------------------------------------------------------------------------------------|
| Steps | <ol style="list-style-type: none">1. Plug the AC-DC power pack into the mains outlet.2. Connect the 12V plug into the 12V socket on the interface panel of the GDS-200/300.3. The unit will begin charging. An orange battery indicator light indicates charging, while green indicates charged. |
|-------|----------------------------------------------------------------------------------------------------------------------------------------------------------------------------------------------------------------------------------------------------------------------------------------------------------------------------------|

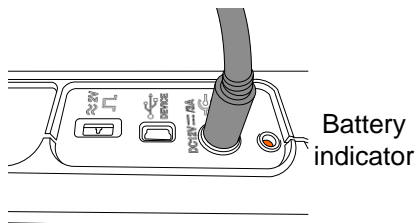

4. Slide the power switch to the ON position, located on the interface panel.

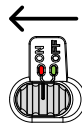

5. The unit will turn on in a short while.

- The battery indicator  is shown on the top right-hand corner of the main display.

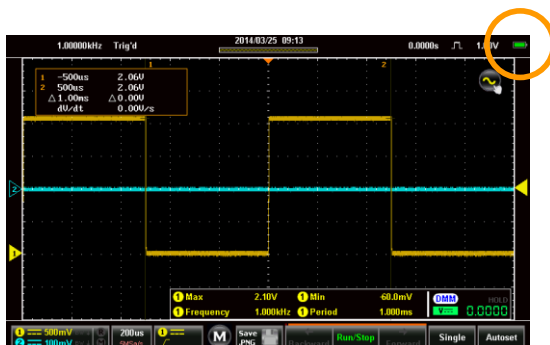

USB Driver Installation

- | | |
|--------------|------------------------------------------------------------------------------------------------------------------------------------------------------------------------------------------------------------------------------------------------------------------------------------------------------------------------------------------------------------------------------------------------------------------------------------------------------------------------------------------------------------------------------------------------------------------|
| Background | The GDS-200/300 has a USB device driver that should be installed to get the most out of the unit. |
| Installation | <ol style="list-style-type: none"> 1. Turn off the GDS-200/300. 2. When the PC is on, connect the USB cable from the GDS-200/300 to the PC. 3. Turn the GDS-200/300 on. 4. Access the Menu tray by pressing the title bar. Go to Utility>USB device port and set the device port to Communication. 5. The PC will now recognize the unit as a new device and ask to search for the driver. 6. Direct the driver installation wizard to the USB device driver (dso_vpo.inf) on the User Manual CD. |

7. The GDS-200/300 will now be recognized as a virtual com port (VCP).

Tilting the Stand

Horizontal



To tilt the stand horizontally, pull the catch from the smaller of the two stands.

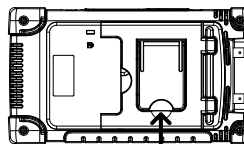

Pull this catch

Vertical



To tilt the stand vertically, release the catch from the larger of the stands.

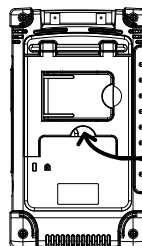

Pull this catch

Setting the System Date & Time

Background The GDS-200/300 will keep the date and time settings saved so long as the battery is not allowed to fully discharge.

1. Access the Menu tray by tapping the title bar.
2. Press Utility>System>Date&Time.

The Date&Time menu will appear.

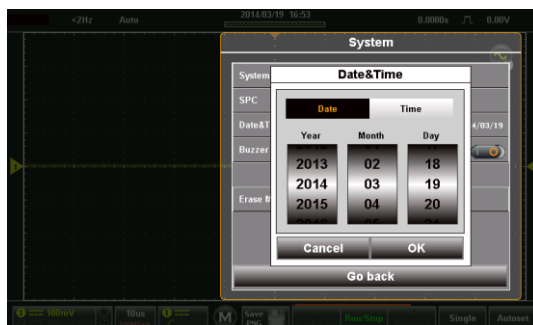

3. To set the date, press Date and use the number picker to set the year, month and day.
 4. To set the time, press Time and use the number picker to set the hour and minute.
 5. Press OK to save the date and time settings.
-



Note

The date and time settings only remain saved if the battery is not fully drained. However, if the unit shuts down due to insufficient battery power, there will usually still be enough battery power to keep the internal clock running for sometime.

Setting the Language

Background The GDS-200/300 menu system can be set to display a number of languages.

1. Access the Menu tray by tapping the title bar.
2. Press Utility>System>Language.

The Language menu will appear.

3. To set the language, press your preferred language.

Switching Horizontal and Vertical View

Background By default the GDS-200/300 is set to the vertical view.

- Switch View**
1. Tap the title bar to access the Menu tray.
 2. Press the  icon to toggle between horizontal and vertical view.





Compensating a Probe

Background To demonstrate connecting the probes, we will use the 1kHz calibration signal on the interface panel and compensate the probe from this signal.

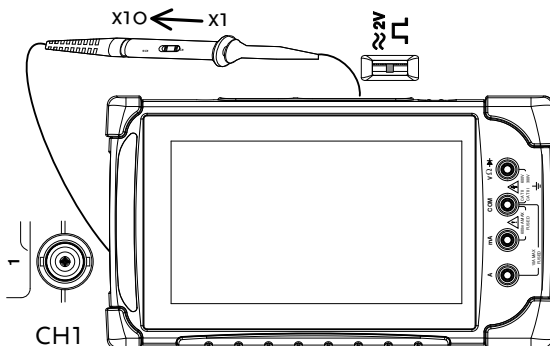
- Connection**
1. Connect a probe to the CH1 BNC terminals.

2. Set the probe attenuation to x10 on the probe.
3. Connect the probe to the 2V calibration signal. The calibration signal outputs a 1kHz, 2Vpp square wave signal.



4. Press the  vertical icon.
5. Select  CH1, if it is not already selected.
6. Press the  option icon.
7. Press Probe and set the probe to 10X.
8. Exit from the Vertical menu (tap anywhere outside the Vertical menu).
9. Press the  Autoset button on the bottom corner of the screen.
10. The calibration signal is displayed on the screen.
11. Tap the title bar to access the Menu tray.
12. Press Display>Type and select Vector as the

interpolation type.

13. Turn the adjust point on the probe until the probe is properly compensated.

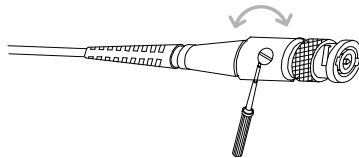
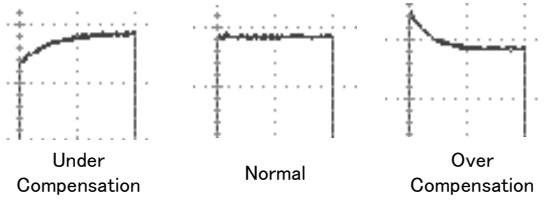

OPERATION

Gesture Control.....	41
Select a Channel, Math or Reference Waveform.....	41
Set the Vertical Position of the Selected Waveform	42
Set the Vertical Scale of the Selected Waveform.....	43
Set the Horizontal Position	44
Set the Horizontal Scale.....	45
Select the Trigger Source and the Trigger Level.....	46
Common Menu UI Elements.....	47
Radio Check Boxes.....	47
Toggle Switches.....	47
Sliding Scales.....	47
Value Picker.....	48
Keyboards and Keypads	48
Vertical Menu Operation	50
Vertical Icon Overview	50
Entering the Vertical Menu	51
Channel or Reference/Math Waveform Selection and Activation	51
Vertical Scale and Position	52
Vertical Options – Channel.....	53
Vertical Options – Reference Waveforms.....	56
Vertical Options – Math	56
Horizontal Position	59
Horizontal Expansion	60
Zoom	63
Trigger Menu Operation	66
Trigger Icon Overview.....	66
Entering the Trigger Menu.....	67
Trigger Setting.....	68
Trigger Types.....	68

Trigger Parameters and Settings	69
Trigger Mode.....	71
Forced Trigger.....	72
Alternate Trigger.....	72
Trigger Level	73
Edge Trigger.....	74
Pulse Trigger.....	76
Video Trigger	77
Autoset	78
Run Mode	80
Run/Stop and Single Key Overview.....	80
Run/Stop Mode.....	81
Single Mode	82
Cursor Measurements	83
Using Cursors.....	83
Automatic Measurements.....	87
Measurement Types.....	87
Viewing Automatic Measurements.....	90
Selecting an Automatic Measurement.....	91
Automatic Measurement Options	93
Drop-Down Menu.....	95
Opening the Drop-down Menu.....	95
Return to Default Settings.....	95
Panel Lock	96
Utility Menu	97
Accessing the Utility Menu.....	97
Set the Language.....	97
View System Information.....	98
Signal Path Compensation.....	99
Setting the System Date & Time	100
Touch Sounds	101
Erase Memory.....	101
Configure the Hardcopy Function	101
Configure USB Device Port.....	103
Configure Autoset Mode	104
Set Ruler.....	105
Calibration	106

Acquire Menu	108
Accessing the Acquisition Menu.....	108
Select Acquisition Mode	109
Show Waveform in XY Mode	110
Set the Record Length.....	111
Set the Interpolation.....	112
Display Menu	113
Accessing the Display Menu	113
Display the Waveform as Dots or Vectors	113
Set the Level of Persistence.....	114
Set the Waveform Intensity.....	115
Set the Graticule Intensity	116
Set the Graticule Type.....	117
Set the Brightness Level.....	118
Go-NoGo Menu	119
Accessing the Go-NoGo Menu.....	119
Configuring the Go-NoGo Menu	119
Running a Go-NoGo Test	123
Save Operations	125
Accessing the Save Menu.....	125
Saving and Configuring Image Files.....	126
Saving and Configuring Waveform Files	129
Saving and Configuring Setups	132
Saving and Configuring Images, Waveforms and Setups All at Once.....	134
Recall Operations	136
Accessing the Recall Menu	136
Recalling Waveform Files	136
Recalling Setups	139
File Manager	140
Accessing the File Manager	140
Navigating the File System	141
DMM Mode	144
Accessing the Multimeter	144
Multimeter Display Overview	146
AC/DC Voltage Measurement	146

Current Measurement	147
Resistance Measurement.....	149
Diode Measurement	150
Continuity Measurement.....	152
Temperature Measurement.....	153

EE APPs 155

Accessing the EE Apps	155
Attenuator Calculator.....	156
Advanced DMM.....	157
Calculator.....	160
QR Code Link App.....	161
Resistance Calculator.....	161

Gesture Control

This chapter will go over all of the basic touch gestures that are available using the default settings. The touch gestures cover all the most frequently used operations that an engineer uses, allowing the GDS-200/300 to operate completely without panel keys or knobs.



Note

The gestures described below are only applicable if “Waveform” is selected as the gesture control method. See page 83 for details.

Select a Channel, Math or Reference Waveform

Background Any channel, math waveform or reference waveform that has already been turned on can be selected from the left of the grid. See page 51 to turn on a waveform, math function or waveform.

Steps To select the active waveform, tap the desired channel, math or reference indicator.

When selected, the icon will become a solid triangle.

Example

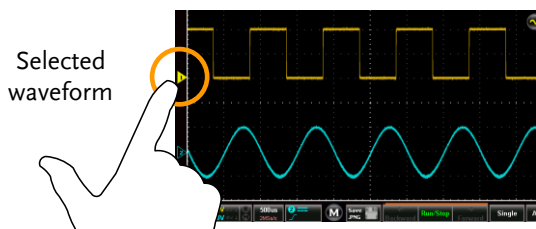

Set the Vertical Position of the Selected Waveform

Background The touch screen can be used to conveniently set the vertical position of the selected waveform.

Steps Swipe the screen vertically to set the vertical position of the selected waveform.

The vertical position will also be shown in a popup window.

The waveform will automatically snap to the zero position at each crossing. To move past the zero position, use the swipe gesture again.

Tapping the upper or lower part of the screen will also increase/decrease the vertical position.

Example

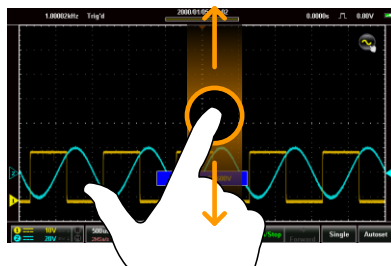

Set the Vertical Scale of the Selected Waveform

Background The touch screen can be used to conveniently set the vertical scale of the selected waveform. To set other vertical scale options, see from page 53

Steps Pinch in/out vertically to set the vertical scale of the selected waveform.

A scale indicator will popup to show the current scale in relation to full vertical scale range.

When the scale indicator appears, simply tapping the upper or lower half of the screen will also change the vertical scale.

The vertical scale (as a value) is shown in the bottom left-hand side of the display.

Example

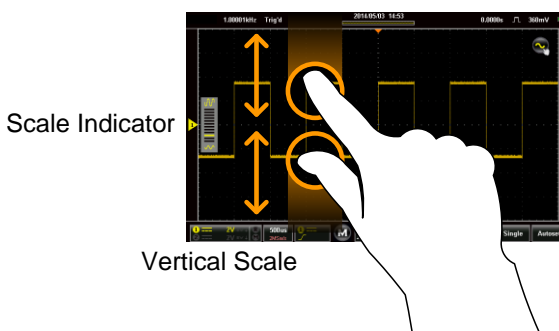

Set the Horizontal Position

Background The touch screen can be used to conveniently set the horizontal position.

Steps Swipe the screen horizontally to set the horizontal position of the displayed waveforms.

The horizontal indicator is a solid orange triangle at the top to the grid.

The horizontal position (as a value) is shown at the top of the grid.

The waveform will automatically snap to the zero position at each crossing. To move past the zero position, use the swipe gesture again.

Example

Horizontal Position

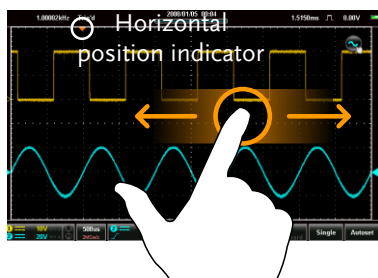

Set the Horizontal Scale

Background The touch screen can be used to conveniently set the horizontal scale of the displayed waveforms. To set other horizontal scale options, see page 60.

Steps Pinch in/out horizontally to set the horizontal scale of the display.

A scale indicator will popup to show the current scale in relation to full horizontal scale range.

When the scale indicator appears, simply tapping the left or right-half of the screen will also change the horizontal scale.

The horizontal scale (as a value) is shown in the bottom left-hand side of the display.

Example

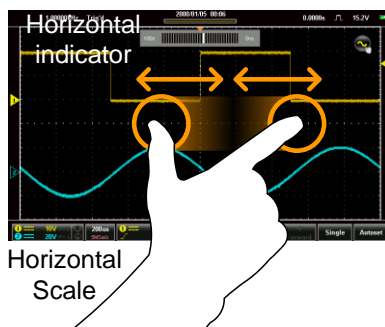

Select the Trigger Source and the Trigger Level

Background The touch screen can be used to conveniently select the trigger source as well as set the trigger level.

Select Trigger Source Tap on the trigger level indicator to toggle between trigger sources.

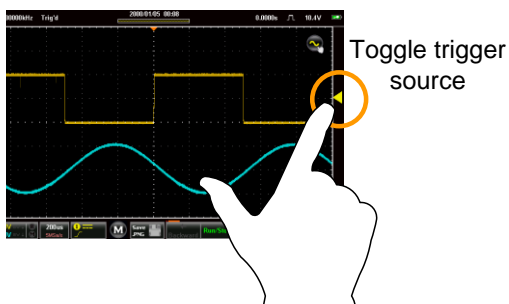

Set the Trigger Level Swipe the screen to the right of the grid to set the trigger level with the currently selected source.

The trigger level will also be shown in a popup window.

Example

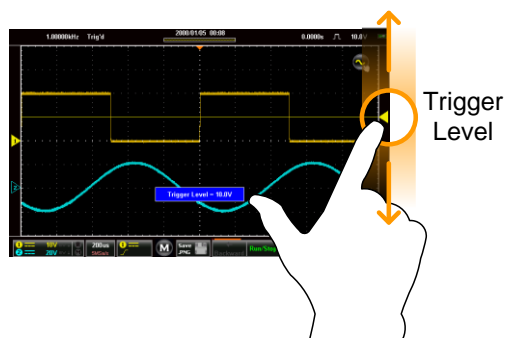

Common Menu UI Elements

This section will give a brief overview of some of the common UI elements that are used to select parameters and values in menus. Not all of the UI elements look the same but will have similar functions. User interface elements that are not shown below will be specifically shown in the user manual.

Radio Check Boxes

Background A radio checkbox allows a single option to be selected.

Example

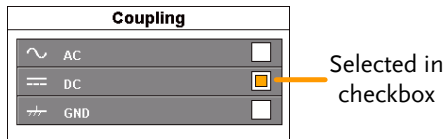

Toggle Switches

Background Toggle switches are used to turn options on or off.

Example

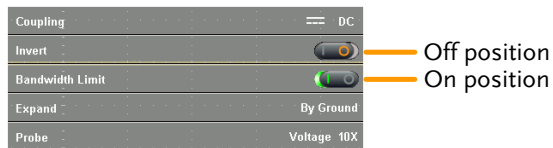

Sliding Scales

Background Sliders are used to quickly enter a value, on a sliding scale. They are usually accompanied by some common preset value buttons.

Example

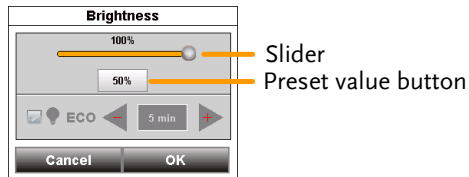

Value Picker

Background Value pickers are used to enter discrete values. They are usually accompanied by some common preset value buttons.

Example

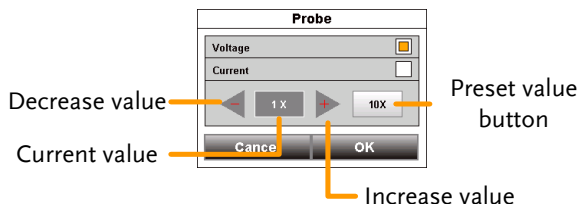

Keyboards and Keypads

Background Software keyboards and keypads are used to enter specific values. Keyboards are used to enter letters and numbers, such as making text notes or files names. Keypads are used to enter values, such as the horizontal position.

Example: keypad

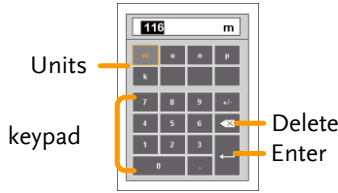

When using a keypad:

- Select the unit
- Enter the value using the keypad
- Press Enter to confirm the entered value.

Example:
Keyboard

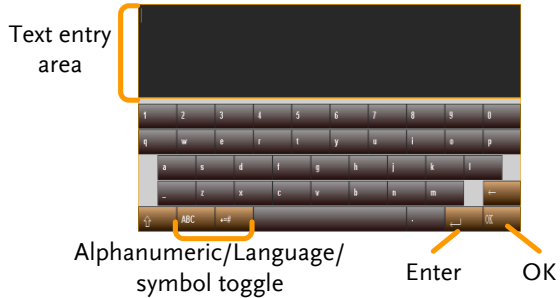

When using the keyboard:

- The text entry area will display the text that is entered.
- The +=# key will bring up a symbol keyboard
- The ABC/Language key will bring up the alphanumeric or native language keyboard.
- Press Enter to go to the next line.
- Press OK to finish entering the text.

Vertical Menu Operation

The vertical menu controls the vertical scale and position, channel activation, coupling, expansion modes and probe settings.

Vertical Icon Overview

Major settings that have been set in the vertical menu will be reflected in the Vertical icon.

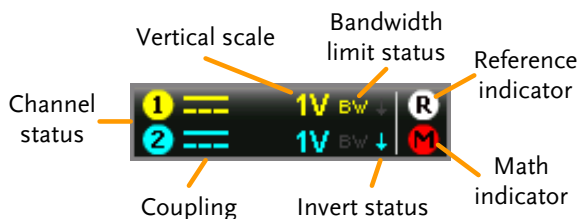

Item	Description
Channel Status	Indicates if a channel is turned on.
Coupling	Indicates DC, AC or GND coupling.
Vertical Scale	Indicates the vertical scale.
Bandwidth Limit Status	Indicates the bandwidth limit is turned on for that channel.
Invert Status	Indicates that the channel waveform is inverted.
Reference Indicator	Indicates that either R1 or R2 is turned on.
Math Indicator	Indicates that the Math function is turned on.

Entering the Vertical Menu

- Steps
1. Press the vertical icon to bring up the vertical menu.
 2. The Vertical Menu appears.



Vertical icon

Channel or Reference/Math Waveform Selection and Activation

Turning a Channel On

From the vertical menu press the icon of the desired channel, reference waveform or math waveform to turn the channel on or to select the channel as the active channel.

- When activated the channel icon will be colored.
- The active channel will have an orange ring around the channel icon.
- Channels that are turned off will be grayed-out.

Example

Selected/active channel Disabled channels

Activated channels

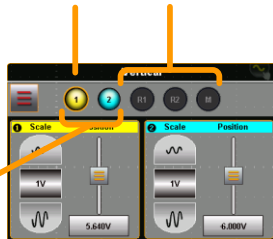

Vertical Scale and Position

Background

The vertical scale and position can be configured in the vertical menu in addition to the using the touch gestures.

Touch Control

Select the desired channel, reference waveform or math function. Page 41



Note

Position: When using touch control, the waveform will automatically snap to the zero position at each crossing. To move past the zero position, use the swipe gesture again.

Menu Control

1. Use the scale picker to set the vertical scale for the selected channel.
2. Use the position slider to set the vertical position for the selected channel.
3. To set the vertical position to 0, drag from the Vertical Position key and drop to the "Set to 0" option.
4. To manually set the vertical position, drag from the Vertical Position key and drop to the keyboard icon. Type in the value for the vertical position with the keypad that appears.

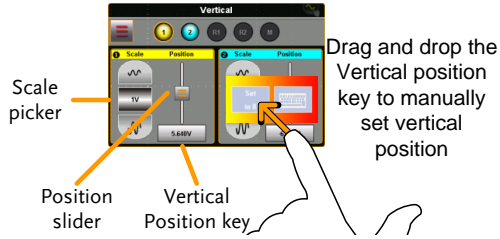

Vertical Options – Channel

Background The Options menu in the Vertical menu allows you to set the coupling, invert waveforms, turn the bandwidth limit on, set the expansion mode and set the probe attenuation.

- Setup**
1. Select a channel by tapping on the corresponding channel icon. Page 51
 2. Press the Options  icon to bring up the vertical options.

The vertical options for the selected channel/waveform will be displayed.

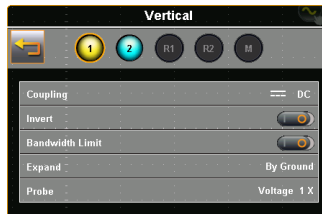

- Coupling**
1. Press Coupling to set the coupling for the selected channel.
 2. Choose the coupling type in the Coupling menu that appears.

Coupling DC, AC, GND

Invert Press the Invert toggle switch to invert the waveform for the selected channel.

Bandwidth Limit Press the Bandwidth Limit toggle switch to turn the bandwidth limit on or off.

Bandwidth limit 20MHz, Off

Expand When the voltage scale is changed, the Expand function designates whether the signal expands from the center of the signal or from the signal ground level. Expand by Center can be used to easily see if a signal has a voltage bias. Expand by Ground is the default setting.

1. Press the Expand key to set the expand mode for all the displayed waveforms.
2. Choose the expansion type in the Expand menu that appears.

Expand By Center, By Ground

Example

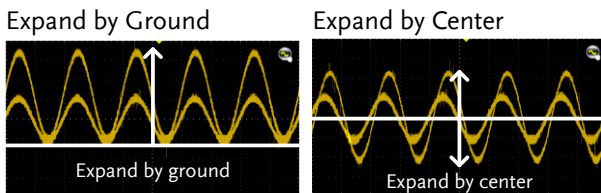



Note

If the vertical scale is changed when the Expand function is set to ground, the signal will expand from the ground level. The ground level position does not change when the vertical scale is changed.

If the vertical scale is changed when the Expand function is set to center, the signal will expand from the center of the waveform window. The ground level position will suit to match the signal position.

Probe

This menu sets the probe attenuation and the probe type.

Press Probe and set the probe parameters for the chosen channel in the Probe menu that appears.

Probe Type	Voltage, Current
Probe attenuation	0.001X - 1000X (1-2-5 step resolution) 10X (preset)

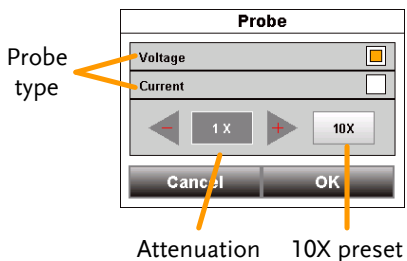

Probe type

Attenuation 10X preset

Vertical Options – Reference Waveforms

Background The Options menu in the Vertical menu allows you to view the selected reference waveform sample rate, record length and creation date.

- Setup**
1. Select a reference by tapping on the corresponding R1 or R2 icon. Page 51
 2. Press the Options  icon to bring up the vertical options.

The data for the selected reference waveform will be displayed.



Note

The reference waveforms can only be recalled if they have been saved first.

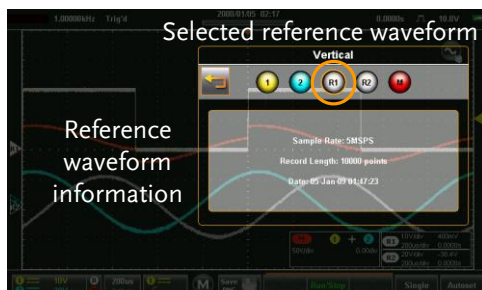

Vertical Options – Math

Background When Math (M) is selected, the Options menu in the Vertical menu allows you to set the math mode, source operators, units and windowing function.

- Setup
1. Select the math channel by selecting Page 51 the M icon.
 2. Press the Options  icon to bring up the math settings.

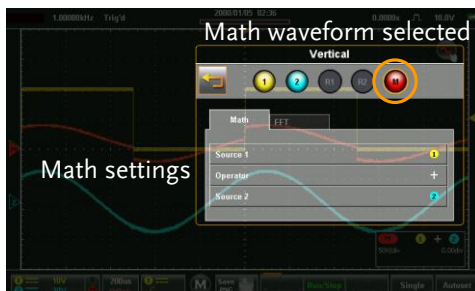

- Math
1. Press the Math tab to reveal the math options.
 2. From the Math tab select the sources and the math operator.

Source 1	CH1, CH2, Ref1, Ref2
Operator	+, -, ×, ÷
Source 2	CH1, CH2, Ref1, Ref2

- FFT
1. Press the FFT tab to reveal the FFT math options.
 2. From the FFT tab select the source, units and FFT window function.

Source 1	CH1, CH2, Ref1, Ref2
Operator	dBV RMS, Linear RMS
Window	Hanning, Rectangular, Hamming, Blackman

Example

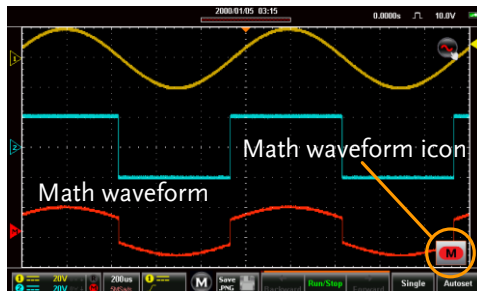

Math details

The Math **M** icon can be expanded to show the sources, volt/div and offset of the Math function. Press the Math icon to toggle between the collapsed and expanded Math icon.

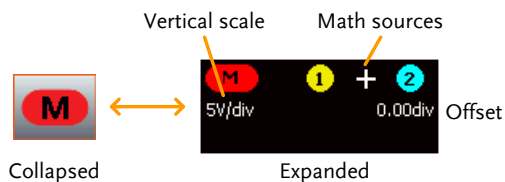

Horizontal Position

Background The horizontal scale and position can be configured in the Horizontal menu in addition to the using the touch gestures.

- Menu Control**
1. Press the  Horizontal key to access the Horizontal menu.
 2. Press Main to set the scope to the main window mode.

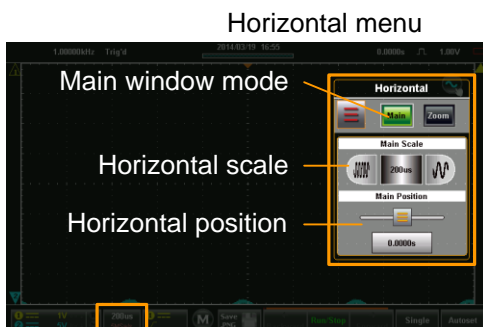

3. From the Main horizontal menu the horizontal scale and position can be configured.
4. Use the scale picker to set the horizontal scale.
5. Use the position slider to set the horizontal position.
6. To set the horizontal position to 0, drag from the Horizontal Position key and drop to the "Set to 0" option.

- To manually set the horizontal position, drag from the Horizontal Position key and drop to the keyboard icon. Type in the value for the horizontal position with the keypad that appears.

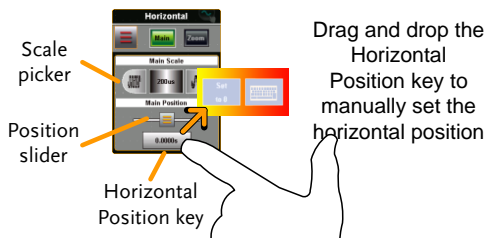

- Touch Control
- Swipe the screen to set the horizontal position. Page 44
 - Use a pinch gesture to increase or decrease the horizontal scale. Page 45



Position: When using the touch screen to set the horizontal position, it will automatically snap to the zero position at each crossing. To move past the zero position, use the swipe gesture again.

Horizontal Expansion

Background

The Options menu in the Horizontal/Zoom menu allows you to set the horizontal expansion mode.

There are two horizontal expansion options: By Center and By Trigger Position.

By Center Scales the waveform from the center of the display.

By Trigger Position Scales the waveform from the trigger position.

- Steps
1. Access the Horizontal or Zoom menu. Page 59 or 63
 2. Press the Options  icon to bring up the Horizontal options menu.

The expansion settings will be displayed.

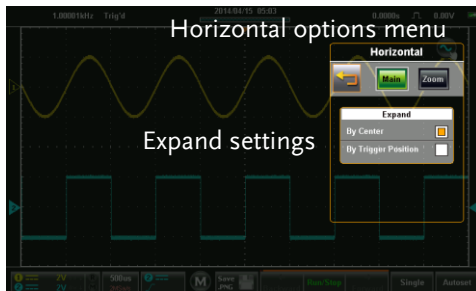

3. Choose the expansion type in the Expand menu that appears.

Expand By Center, By Trigger Position

Example: By Center

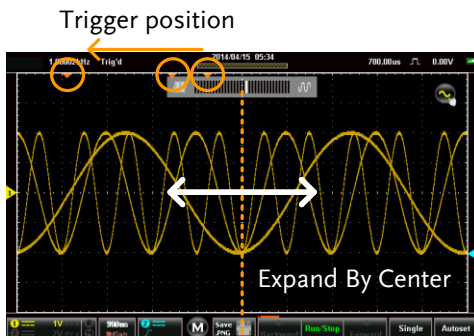

Example: By
Trigger Position

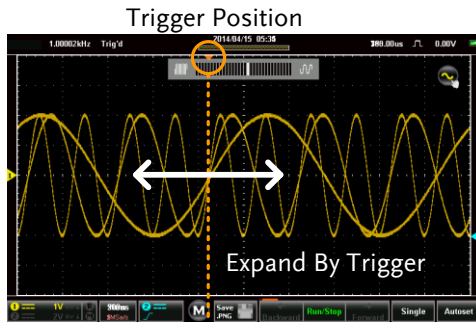

Zoom

Background The Zoom menu can be accessed from the Horizontal menu.

- Setup**
1. Press the  Horizontal key to access the Horizontal menu.
 2. Press Zoom to set the scope to Zoom window mode.

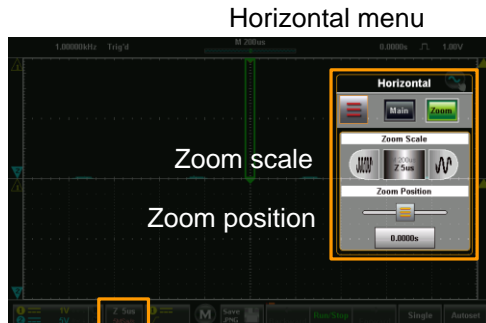

Horizontal icon

3. From the Zoom horizontal menu the zoom scale and zoom position can be configured.

- Menu Control
1. Use the scale picker to set the horizontal scale for the zoom window.
 2. Use the position slider to set the horizontal position for the zoom window.
 3. To set the zoom position to 0, drag from the Zoom Position key and drop to the "Set to 0" option.
 4. To manually set the zoom position, drag from the Zoom Position key and drop to the keyboard icon. Type in the value for the zoom position with the keypad that appears.

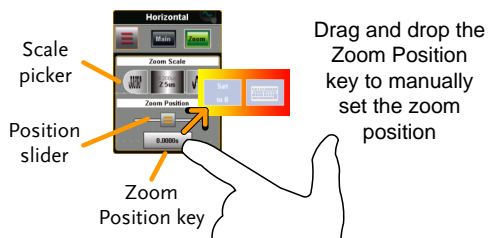

- Touch Control
1. The zoom window can be zoomed in and out using a horizontal pinch.

- The horizontal position of the zoom window can be moved by swiping the screen left or right.

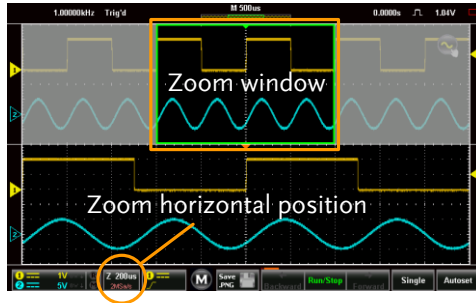

Position: In the main display, the zoom window will automatically snap to the zero position at each crossing. To move past the zero position, use the swipe gesture again.

Trigger Menu Operation

The Trigger menu controls the trigger position, trigger type and trigger modes.

Trigger Icon Overview

The settings that have been set in the Trigger menu will be reflected in the Trigger Menu Icon.

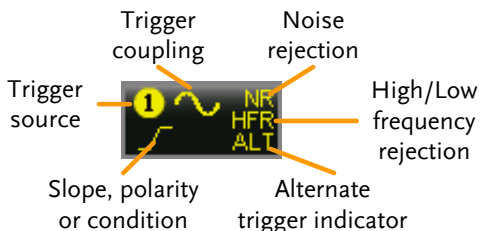

Item	Description						
Trigger Source	Shows the trigger source channel. CH1, CH2						
Trigger Coupling	Shows the trigger coupling. AC Coupling, DC Coupling						
Noise Rejection	Indicates that noise rejection is activated						
Frequency rejection	Indicates that high or low frequency rejection is activated. HFR = high frequency rejection LFR = low frequency rejection						
Alternate trigger indicator	Indicates that the alternate trigger is activated.						
Slope, polarity or condition	This area will display the current trigger conditions: <table border="1" style="margin-left: 20px;"> <tr> <td>Edge</td> <td>Rising slope, Falling slope, Either slope</td> </tr> <tr> <td>Pulse</td> <td>Falling edge, Rising edge</td> </tr> <tr> <td>Video</td> <td>NTSC, PAL, SECAM</td> </tr> </table>	Edge	Rising slope, Falling slope, Either slope	Pulse	Falling edge, Rising edge	Video	NTSC, PAL, SECAM
Edge	Rising slope, Falling slope, Either slope						
Pulse	Falling edge, Rising edge						
Video	NTSC, PAL, SECAM						

Entering the Trigger Menu

Steps

1. Press the  Trigger icon to bring up the Trigger menu.
2. The Trigger menu appears.

Example

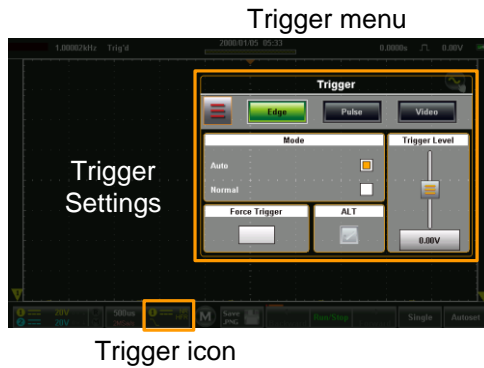

Trigger Setting

Trigger Types

The trigger configures the conditions for when the GDS-200/300 captures a waveform.

Edge The edge trigger is the simplest trigger type. An edge trigger triggers when the signal crosses an amplitude threshold with either a positive or negative slope.



Pulse Width Triggers when the pulse width of the signal is less than, equal, not equal or greater than a specified pulse width.

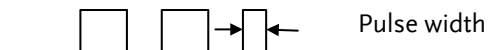

Video Extracts a sync pulse from a video format signal, and triggers on a specific line or field.

Trigger Parameters and Settings

The following trigger parameters apply to all the trigger types unless stated otherwise.

Mode	Auto	The GDS-200/300 generates an internal trigger if there is no trigger event, to make sure waveforms are constantly updated regardless of trigger events. Select this mode especially when viewing rolling waveforms at slower timebases.
	Normal	The GDS-200/300 only acquires a waveform when triggered.
	(Single)	Pressing the Single  button will acquire a single waveform. (This mode is not selectable from the Trigger menu. See page 82 for details)
Force Trigger		This setting will force a trigger to be generated when pressed. This setting is useful if triggering a waveform is difficult.
ALT		Alternates the source between channel 1 and channel 2.
Trigger level	Level	Used to manually adjust the trigger level for the current source.
	TTL (1.4V)	Sets the trigger level to 1.4V, suitable for triggering on TTL signals.
	ECL (-1.3V)	Sets the trigger to -1.3V. This is suitable for ECL circuits.

	50%	Sets the trigger level to 50% of the waveform amplitude.
Source	CH1, CH2	Channel 1 or channel 2 input.
Coupling (Edge, Pulse only)	DC	Sets the coupling to DC.
	AC	Sets the coupling to AC.
Slope (Edge only)	Rising	Trigger on rising edge.
	Falling	Trigger on falling edge.
	Either	Trigger on either rising or falling edge.
Reject	Off	Frequency rejection turned off.
	LFR	Low frequency rejection.
	HFR	High frequency rejection.
	NR	Noise rejection
Holdoff	Holdoff	Sets the holdoff time. The holdoff time delays triggering the next waveform for a set amount of time after triggering.
Polarity (Pulse)	Positive polarity	Positive polarity (triggered on the high to low transition)
	Negative polarity	Negative polarity (triggered on the low to high transition)
Polarity (Video)	Positive polarity	Positive polarity.
	Negative polarity	Negative polarity.
Trigger When (Pulse)	=	Equal to.
	>	Longer than.
	<	Shorter than.
	≠	Not equal to.

	When	Pulse width (10ns - 10s)
Standard	NTSC	National Television System Committee
	PAL	Phase Alternate by Line
	SECAM	SEquential Couleur A Memoire
Trigger On	Field1	Sets the trigger point to a line on field1 (odd).
	Field2	Sets the trigger point to a line on field2 (even).
	All Fields	Trigger on all fields.
	All Lines	Trigger on all lines.

Trigger Mode

Background The trigger mode can be set to Normal or Auto (untriggered roll). The triggering mode applies to all the trigger types. See page 69.

From the Trigger menu, set the Mode to Auto or Normal.

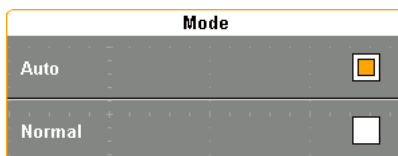

Forced Trigger

Background

If the input waveforms are not triggered, they can be force triggered using the Force Trigger button.

From the Trigger menu, press the Force Trigger button. The scope will trigger immediately.



Alternate Trigger

Background

The Alternate trigger allows the scope to trigger alternatively between CH1 and CH2.

From the Trigger menu, press the ALT button. A check will indicate if the ALT function is active. The ALT function applies to all the trigger types.



Trigger Level

Background The trigger level can be set using touch gestures or from the trigger level.

Touch Control

1. Select the trigger source from the side of the graticule.
2. Swipe up and down from the right side of the graticule to set the trigger level for the selected trigger source.

Menu Control

1. From the Trigger menu use the Trigger Level slider to set the trigger level.
2. To set the trigger level to 50%, drag from the Trigger Level button and drop to the "Set to 50%" option.
3. To manually set the trigger level, drag from the Trigger Level button and drop to the keyboard icon. Type in the value for the trigger level with the keypad that appears.

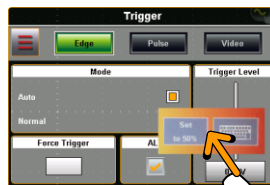



Trigger Level
button

Drag and drop the
Trigger Level
button to
manually set the
trigger level

Edge Trigger

Background The Edge trigger allows you to acquire a waveform on a rising or falling edge.

- Setup**
1. Press the Edge  button. Page 67
 2. Press the Options  icon to bring up the Trigger options for the Edge trigger.

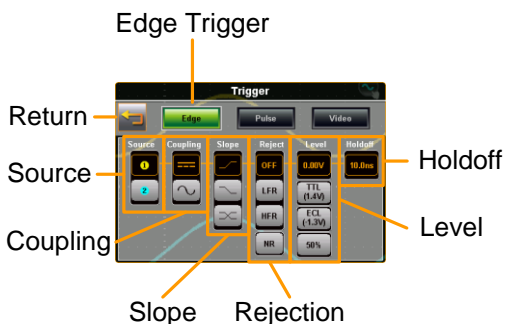

3. Select the appropriate parameters. See page 69 for a description of each parameter.

Source	CH1, CH2
Coupling	DC, AC
Slope	Rising, falling, either
Reject	Off, low frequency rejection, high frequency rejection, noise rejection
Level	0.00V, TTL(1.4V), ECL(-1.3V), 50%
Holdoff	10ns - 10s

Example

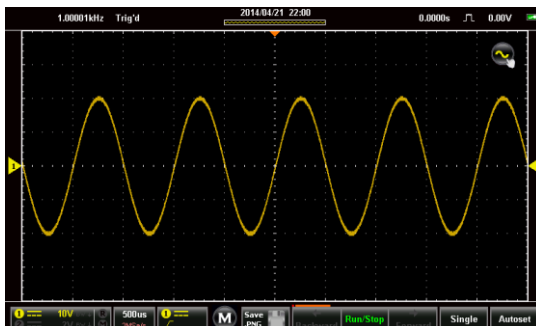

Pulse Trigger

Background The Pulse trigger allows you to acquire a waveform on a rising or falling pulse of a defined width.

Setup 1. Press the Pulse  button. Page 67

2. Press the Options  icon to bring up the Trigger options for the Pulse trigger.

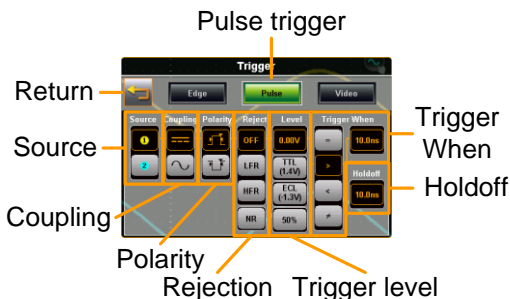

3. Select the appropriate parameters. See page 69 for a description of each parameter.

Source	CH1, CH2
Coupling	DC, AC
Polarity	Positive, negative
Reject	Off, low frequency rejection, high frequency rejection, noise rejection
Level	0.00V, TTL(1.4V), ECL(-1.3V), 50%
Trigger When	Equal, greater than, less than, not equal to. (Time: 10ns - 10s)
Holdoff	10ns - 10s

Example

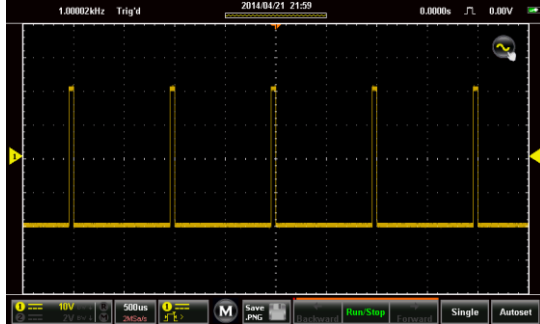



Video Trigger

Background

The Video trigger allows you to acquire PAL, NTSC and SECAM video signals. The GDS-200/300 can trigger on any line or field.

Setup

1. Press the Video  button. Page 67
2. Press the Options  icon to bring up the Trigger options for the Video trigger.

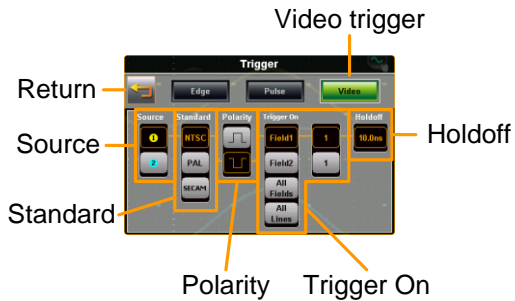

3. Select the appropriate parameters. See page 69 for a description of each parameter.

Source	CH1, CH2
Standard	NTSC, PAL, SECAM
Polarity	Positive, negative
Trigger On	Field 1 (line 1- 263), Field 2 (line 1 - 262), All Field, All Lines
Level	0.00V, TTL(1.4V), ECL(-1.3V), 50%
Holdoff	10ns - 10s

Example

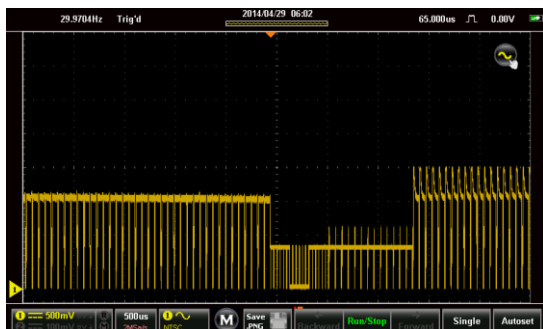

Autoset

Background

The Autoset function will automatically choose the best timebase and vertical scale for the activated waveforms. The Fit Screen and AC Priority settings position the input signal to the best viewing condition.



 Note

Note the Autoset function is only applicable when the input is equal or greater than 30mV & 20Hz.

Autoset Settings	Descriptions
Fit Screen	Fit Screen mode will fit the waveform to the best scale, including any DC components (offset).

AC Priority AC Priority mode will scale the waveform to the screen by removing any DC component.

Steps

1. From the main display press the  Autoset key.
 2. The waveform will appear on the display.
 3. For a few seconds you will have the option to press  Undo? to undo the autoset configuration.
-

Autoset Mode

1. Long press Autoset to bring up the Autoset Mode menu.
2. Press the appropriate check-box to select Fit Screen or AC Priority.

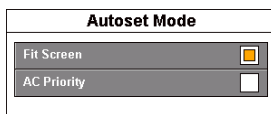

The Autoset Mode menu can also be accessed via the Utility menu, see page 104 for details.

Run Mode

The scope has three main running modes, Run, Stop and Single.

Run mode continuously captures (triggered) waveforms in a FIFO buffer. Each waveform that is captured can be replayed when the scope is in the Stop mode. The number of waveforms that are captured depends on the sample rate and the memory length.

Stop mode stops capturing waveforms and allows you to view any waveform that was previously captured in the Run mode.

Single mode captures a single waveform as soon as the trigger conditions are met.

Run/Stop and Single Key Overview

The Run/Stop key shows the Run/Stop status, the record progress of the captured waveforms and the navigation keys for navigating captured waveforms when in the Stop mode.



Item	Description
Record Indicator	The Record indicator blinks when the scope is triggering.
Progress Bar	The Progress bar indicates the record progress.
Step Forward	Steps to the next captured waveform when the scope is in Stop mode.
Step Backward	Steps to the previous captured waveform when the scope is in Stop mode.
Run/Stop Key	Toggles the scope between Run and Stop mode.
Single Key	Turns on the Single Trigger mode.

Run/Stop Mode

Background	<p>By default the scope is in Run mode as soon as it is turned on.</p> <p>The Run/Stop key is shown in green when the scope is in Run mode and red when it is in Stop mode.</p>
Toggle Modes	<p>Press the Run/Stop key to toggle between Run and Stop modes.</p>
Record Navigation	<ol style="list-style-type: none">1. Put the scope into Run mode (described above).2. After the desired number of samples has been recorded, toggle the scope to Stop mode by pressing the Run/Stop key.3. Use the Backward and Forward keys to navigate to the desired waveform sample.4. When the Backward or Forward keys are used a slider will appear allowing you to quickly navigate to the desired sample. The slider will disappear after a short while of inactivity.5. The slider can be pinned/unpinned from the menu bar by toggling the pin icon.

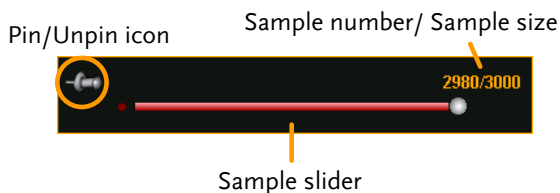

Example

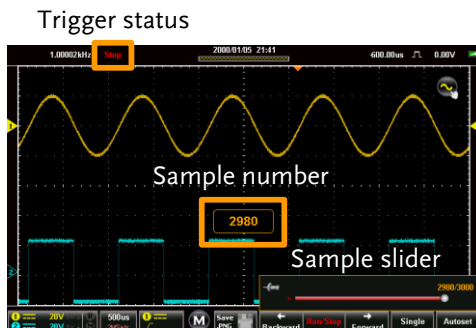

Single Mode

Single Mode

Simply press the **Single** key to set the scope to single trigger mode.

The scope will capture a waveform when the trigger conditions are met. This is useful for intermittent signals.

Cursor Measurements

Horizontal or vertical cursors are used to show the position and values of waveform measurements and math operation results. These results cover voltage, time, frequency and other math operations. When the cursors (horizontal or combined) are activated, they will be shown on the main display unless turned off.

Using Cursors

Background	The Gesture Control icon is used to toggle the touch screen controls between Waveform controls and Cursor controls. The Cursor Display must be activated to use and see the cursor measurements.
------------	--------------------------------------------------------------------------------------------------------------------------------------------------------------------------------------------------

- Steps
1. Press the Gesture Control icon, located in the top corner of the graticule.

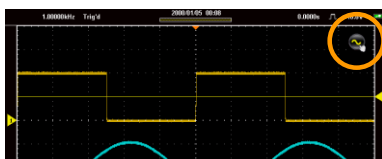

2. Set the Gesture Control to Horizontal or Combined Cursor control.
3. Turn Cursor Display on.

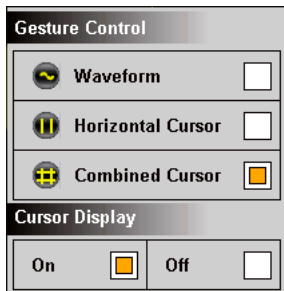

4. Cursors will now appear on the display for the currently selected channel, 2 lined cursors for the Horizontal Cursor option and 4 lined cursors for the Combined Cursor option.
5. The cursor measurements will appear in a window in the top left-hand side.

Horizontal: 

1	250us	2.02V
2	1.73ms	0.00V
Δ	1.48ms	Δ 2.02V
	dV/dt	-1.36KV/s

Cursor 1, 2 Time/frequency, voltage/current at crossing.
 Δ Delta (difference between cursors) dV/dt or dI/dt.

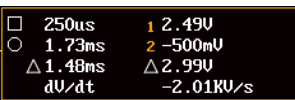
Combined: 

□	250us	1 2.49V
○	1.73ms	2 -500mV
Δ	1.48ms	Δ 2.99V
	dV/dt	-2.01KV/s

□ , ○ Time/Frequency: Cursor 1, cursor 2

Cursor 1, 2 Voltage/Current : Cursor 1, cursor 2
 Δ Delta (difference between cursors) dV/dt or dI/dt.

- Pressing the cursor window will toggle the horizontal reading between frequency and time.

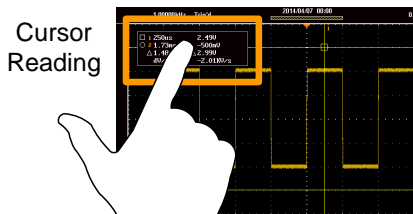

Moving the Cursors

- To move the cursors horizontally, touch and swipe a cursor line horizontally to the desired position.
- To move the cursors vertically, touch and swipe a cursor line vertically to the desired position.

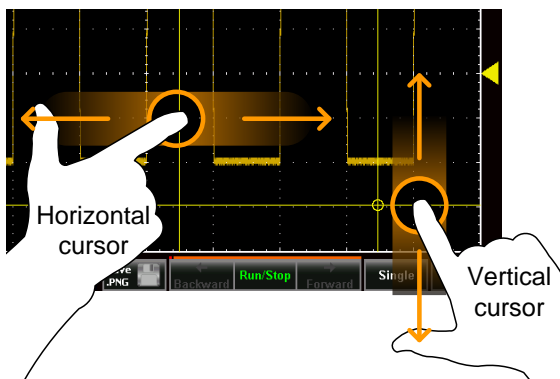

- Return the Gesture Control back to Waveform after the cursors have been positioned. See step 3 above to turn Gesture Control off.

Linking the Cursors

- To link the distance between the cursors (lock the delta value) so that the horizontal cursors or vertical cursors move together, press and hold either Horizontal Cursor or Combined Cursor in the Gesture Control window as shown in step 4.

The Horizontal Cursor and Combined Cursor options will show a “link” icon on the left-hand side when the cursors are linked.

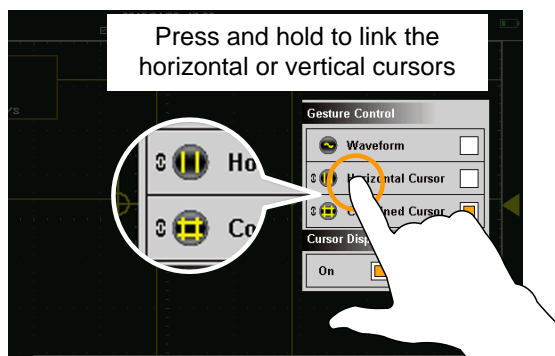







Automatic Measurements



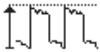
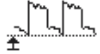
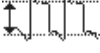

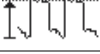

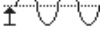
Up to 4 automatic measurements can be calculated from the trigger configuration conditions each time a waveform is captured.

The automatic measurements can be based on the entire record length, the area of the waveform displayed on-screen or from a gated region bound by the onscreen cursors.





Measurement Types







Amplitude Measurements

	Pk-Pk	Difference between positive and negative peak. (=max - min)
	Max	Positive peak.
	Min	Negative peak.
	Amplitude	Difference between the global high value and the global low value, measured over the entire waveform or gated region. (=high - low)
	High	Global high voltage.
	Low	Global low voltage.
	Mean	The arithmetic mean value is calculated for all data samples as specified by the Gating option.
	Cycle Mean	The arithmetic mean value is calculated for all data samples within the first cycle found in the gated region.
	RMS	The root mean square of all data samples specified by the Gating option.







	Cycle RMS	The root mean square value is calculated for all data samples within the first cycle found in the gated region.
	Area	Measures the positive area of the waveform and subtracts it from the negative area. The ground level determines the division between positive and negative areas.
	Cycle Area	The Summation based on all data samples within the first cycle found in the gated region.
	ROVShoot	Rise overshoot.
	FOVShoot	Fall overshoot.
	RPREShoot	Rise preshoot.
	FPREShoot	Fall preshoot.



Time Measurements

	Frequency	Frequency of the waveform.
	Period	Waveform cycle time. (=1/Freq)
	Rise Time	The time required for the leading edge of the first pulse to rise from the low reference value to the high reference value.
	Fall Time	The time required for the falling edge of the first pulse to fall from the high reference value to the low reference value.
	+Width	Positive pulse width.

	-Width	Negative pulse width.
	Duty Cycle	Ratio of signal pulse compared with whole cycle. =100x (Pulse Width/Cycle)
	+Pulses	Measures the number of positive pulses.
	-Pulses	Measures the number of negative pulses.
	+Edges	Measures the number of positive edges.
	-Edges	Measures the number of negative edges.

Delay Measurement

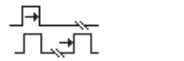
	FRR	Time between: Source 1 first rising edge and Source 2 first rising edge.
	FRF	Time between: Source 1 first rising edge and Source 2 first falling edge.
	FFR	Time between: Source 1 first falling edge and Source 2 first rising edge.
	FFF	Time between: Source 1 first falling edge and Source 2 first falling edge.
	LRR	Time between: Source 1 first rising edge and Source 2 last rising edge.
	LRF	Time between: Source 1 first rising edge and Source 2 last falling edge.

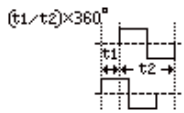
	LFR	Time between: Source 1 first falling edge and Source 2 last rising edge.
	LFF	Time between: Source 1 first falling edge and Source 2 last falling edge.
	Phase	The phase difference of two signals, calculated in degrees. $\frac{t1}{t2} \times 360^\circ$

Viewing Automatic Measurements

Background

There are two different display options for automatic measurements. A minimized and a maximized view*.

The minimized view will display the real-time measurement results.

The maximized view will display the real-time, mean, minimum and maximum measurement results.



*The minimized view is only applicable in the landscape viewing mode. The vertical viewing mode displays automatic measurements in the maximized view by default and will always be displayed on screen.

- Steps
1. Press the M (Measure) icon in the menu bar at the bottom of the display.
 2. The minimized view will appear above the menu bar.
 3. To toggle between the minimized and maximized view, tap anywhere within the area that the automatic measurements are displayed.
 4. To remove the automatic measurements from the display*, press the M (Measure) icon again in the menu bar.

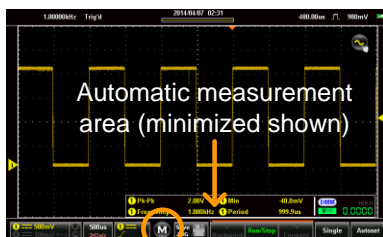

Measure icon

Selecting an Automatic Measurement

- Background
- Automatic measurements can be accessed from the drop down menu or from the menu bar at the bottom of the screen.

Steps

1. Make sure the automatic measurements are visible at the bottom of the display.
2. From the Menu Bar: Long-press anywhere within the area that the automatic measurements are displayed to bring up the Measurement menu.

OR

From the Drop Down Menu: Press the top of the screen to access the drop down menu. From the Menu tray, select the Measure icon.



Long press

3. Select a measurement slot (from 1 of 4 quadrants).
4. Select a measurement category (Amplitude, Time, Delay).

5. Select an automatic measurement from the selected category.

Tip: Tapping the bottom of the selection window will display the next group of automatic measurements for the category.

6. To select the source for the selected automatic measurement, long-press the measurement selection. Select the source from the submenu that appears.

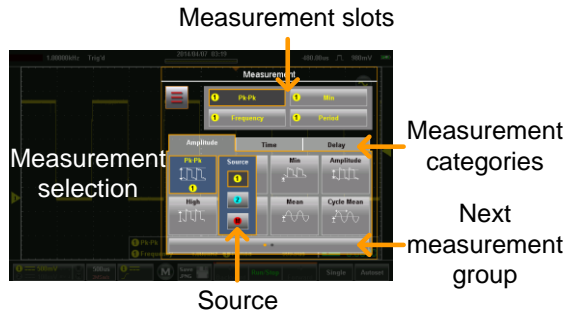

Automatic Measurement Options

Background The Option menu will limit the bounds of the automatic measurements to the entire record length, to the screen graticule or to the onscreen cursors. For measurement statistics, the mean number of samples can also be set. The default number of samples is set to 2.

Steps 1. Access the Measurement menu. Page 91

2. Press the Options  icon to bring up the options menu.
3. From the Options menu select the measurement gating:
 Gating Off (Full Record), Screen, Between Cursors
4. For Statistics, select the number of mean samples. The number of samples is used to calculate the Mean measurement for when the automatic measurements are displayed in the maximized mode.

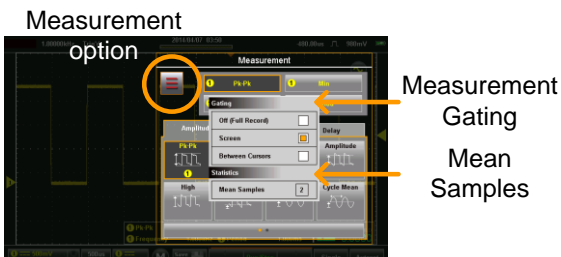

Drop-Down Menu

The Drop-down menu is split into the Menu tray and the App tray. The Menu tray contains all the configuration settings and other miscellaneous functions not directly related to the operation. The App tray contains a number of EE apps that can be used as supplementary tools for the GDS-200/300.

Opening the Drop-down Menu

Background From the main screen, press the title bar to bring up the Drop-down menu.

The Drop-down menu will be displayed. To return to the main display, press anyway outside of the drop down menu system.



Press anywhere outside to exit

Return to Default Settings

Background

The  Default icon will allow you to return the scope to the factory default settings. See page 182 for a list of the factory default settings.

Steps	<p>Press the Default icon from the Menu tray.</p> <ul style="list-style-type: none"> • The default settings will be restored immediately.
-------	----------------------------------------------------------------------------------------------------------------------------------------------------------

Panel Lock

Background	The panel lock can be used to prevent any settings from being inadvertently changed.
------------	--------------------------------------------------------------------------------------

Activate Panel Lock	<p>Press the Lock icon from the Menu tray.</p> <ul style="list-style-type: none"> • The panel lock will appear at the bottom of the screen.
---------------------	------------------------------------------------------------------------------------------------------------------------------------------------------------

Disable Panel Lock	<p>Press and hold the Padlock icon.</p> <ul style="list-style-type: none"> • Wait for the progress bar to finish before letting go • “Panel locked” will be displayed when the screen is touched anywhere other than the Padlock button.
--------------------	------------------------------------------------------------------------------------------------------------------------------------------------------------------------------------------------------------------------------------------------------------------

Example

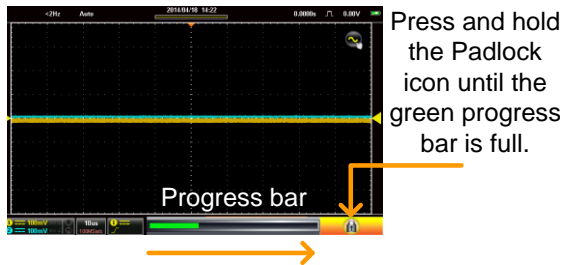

Utility Menu

The Utility Menu configures a number of general system settings such as the System language, Hardcopy settings, USB device port settings, Calibration and other settings.

Accessing the Utility Menu

From the main screen, press the title bar to bring up the Drop Down menu. Press the Utility icon to show the Utility menu.



Set the Language

Background	The Language menu selects the system language.
Steps	From the Utility menu, press Language and select your preferred language.
	Note: The languages available may vary from that shown.

View System Information

Background

The system information displays the model name, serial number, firmware version, FPGA revision and GW Instek website address.

- A QR code for the serial number is also shown.

Steps

From the Utility menu, press System>System Information.

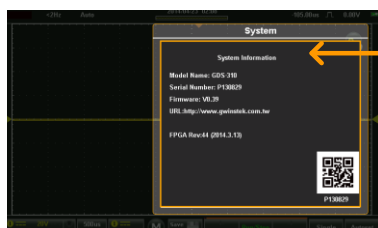

System
information

Signal Path Compensation

Background Signal Path Compensation (SPC) is used to compensate the internal signal path due to ambient temperature and long term drift. SPC is able to optimize the accuracy of the oscilloscope with respect to the ambient temperature and signal drift.



Ensure the scope has been warmed up for at least 10 minutes before performing signal path compensation.

- Steps**
1. From the Utility menu, press System>SPC.
 2. Disconnect all probes/cables from CH1 & CH2 when prompted and then press OK.
 - The calibration items will show sequentially at the bottom of the display.
 - "Calibration Successful!", will be shown after each channel has been calibrated. It takes ~1minute per channel.

Setting the System Date & Time

Background The GDS-200/300 will keep the date and time settings saved so long as the battery is not allowed to fully discharged.

1. Press Utility>System>Date&Time.

The Date&Time menu will appear.

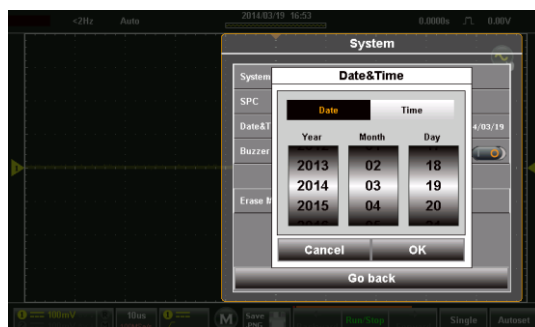

2. To set the date, press Date and use the number picker to set the year, month and day.
 3. To set the time, press Time and use the number picker to set the hour and minute.
 4. Press OK to save the date and time settings.
-



The date and time settings only remain saved if the battery is not fully drained. However, if the unit shuts down due to insufficient battery power, there will usually still be enough battery power to keep the internal clock running for sometime.

Touch Sounds

Background When turned on, the Touch Sounds function will produce a buzzer sound when a button is pressed on the touch screen. By default the buzzer sound is turned off.

Press Utility>System>Touch Sounds and toggle Touch Sounds on/off.

Erase Memory

Background The Erase Memory function will delete all waveform and setup files from the internal memory.

Press Utility>System>Erase Memory and press OK to erase the memory.

Configure the Hardcopy Function

Background The Hardcopy function is a quick save function. Each time the Hardcopy Save key is pressed, according to the Hardcopy setting, an image, waveform or setup file is saved.

Steps

1. From the Utility menu, press Hardcopy and select the save function for the Hardcopy function.
2. The Hardcopy Save key  can now be used to save the item configured with the Hardcopy function.
3. See the Save Operations and Recall Operations chapters for the file format details, see page 125&136.

Hardcopy Image, Waveform, Setup, All

Configure USB Device Port

Background The setting, “USB device port” in the Utility menu determines whether the internal storage is seen as an internal or external drive. When set to Disk Drive, the internal storage can be accessed via a USB connection to a PC or via a USB OTG cable on a smart phone. When the USB device port is set to Communication, the unit can be used for remote control.



Note

When connected to a PC via the Mini-B USB port, the USB device port must be set to Communication in order to save files. See page 125.

Steps From the Utility menu, press USB device port and select the USB interface type.

USB device port Communication, Disk Drive



Note

A Note about USB OTG:

- USB OTG functionality is only supported on some smartphones/tablets running the android operating system.
 - If your smartphone/tablet supports USB OTG, a file manager that supports USB OTG as well as a USB OTG cable are also needed.
 - To use USB OTG, connect the GTL-253 Type A - Mini-B USB cable to the USB OTG cable. Connect the OTG cable to the smart phone. The GDS-200/300 should now be visible on the smartphone’s file manager.
-

Configure Autoset Mode

Background There are two operating modes for the Autoset function: Fit Screen Mode and AC Priority Mode. Fit Screen Mode will fit the waveform to the best scale, including any DC components (offset). AC Priority mode will scale the waveform to the screen by removing any DC component.

Steps From the Utility menu, press Autoset Mode and select the mode.

Autoset Mode Fit Screen Priority, AC Priority

Example 2VPP signal with 2V DC offset

Fit Screen

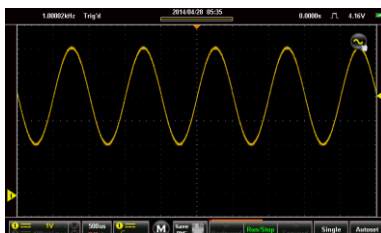

AC Priority

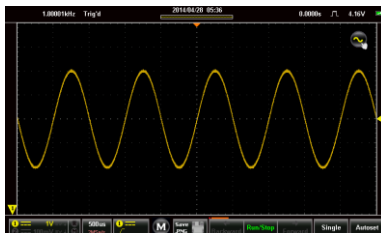

Set Ruler

Background The Ruler function adds a scale to the graticule. Note this mode only functions in the vertical view. See page 34 to set the display to the vertical mode.

Steps From the Utility menu, press Ruler to toggle the Ruler function on/off.

Ruler On, Off

Example

Ruler scale

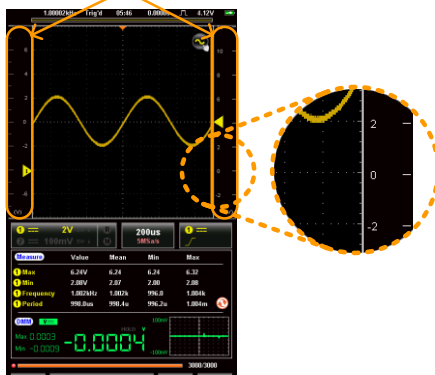

Calibration

Background The Calibration menu allows you to perform vertical calibration on the oscilloscope channels.

- Steps**
1. From the Utility menu, press Calibration>Vertical Calibration to start vertical calibration.
 2. A prompt will appear asking you to connect the CAL output to CH1.
 3. Connect the Vertical Calibration cable, GCL-001, to the input in the restricted panel* on the interface panel and to CH1.

*You may need to use a Philips head screwdriver to remove the panel.

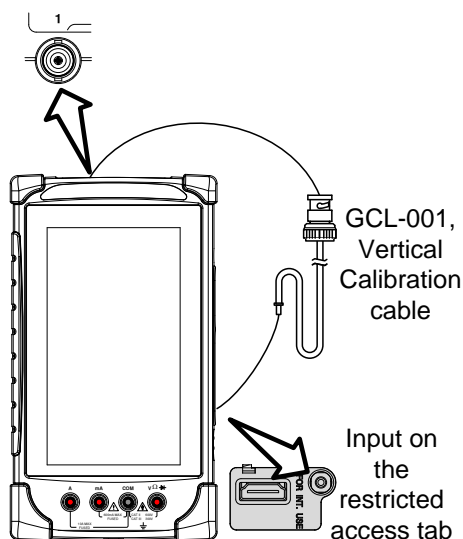

4. Press OK to start the CH1 calibration.

5. Repeat the above steps for CH2.
6. Reset the scope when the calibration has finished.



Vertical
Calibration
menu

Acquire Menu

The Acquire Menu sets the acquisition mode, channel mapping (XY mode), record length and the sample interpolation type.

Accessing the Acquisition Menu

From the main screen, press the title bar to bring up the Drop Down menu. Press the Acquire icon to show the Acquire menu



Select Acquisition Mode

Background The acquisition process samples the analog input signals and converts them into digital formats for internal processing. The acquisition mode determines how the samples are used to reconstruct a waveform.

Modes

Sample	This is the default acquisition mode. Every sample from each acquisition is used.
--------	-----------------------------------------------------------------------------------

Peak Detect	Only the minimum and maximum value pairs for each acquisition interval (bucket) are used. This mode is useful for catching abnormal glitches in the signal.
-------------	-------------------------------------------------------------------------------------------------------------------------------------------------------------

Average	Multiple acquired data is averaged. This mode is useful for drawing a noise-free waveform. Average Setting: 2, 4, 8, 16, 32, 64, 128, 256
---------	----------------------------------------------------------------------------------------------------------------------------------------------

Steps From the Acquire menu, press Mode and select an option. When a mode has been selected, press OK.

Mode: Sample, Peak Detect, Average

Example Sample Peak Detect Average (256)



Show Waveform in XY Mode

Background The XY mode maps the input of channel 1 to the input of channel 2. This mode is useful for observing the phase relationship between waveforms.

XY mode can also be used with cursors, see page 83 to turn cursors on.

- Connection**
1. Connect channel 1 to the X-axis source.
 2. Connect channel 2 to the Y-axis source.

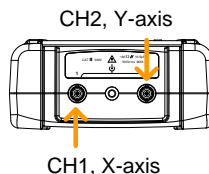

3. Activate both channel 1 and channel 2. Page 41

- Steps**
1. From the Acquire menu toggle XY mode on.
 1. The X-Y mode will appear.

Example

X-Y cursor measurements

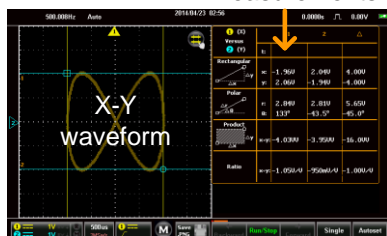

Set the Record Length

Background The number of samples that can be stored is set by the record length. Record length is important in an oscilloscope as it allows longer waveforms to be recorded and/or allows higher sampling rates to be achieved when equivalent time sampling is used.

Record Length

1k	30,000 waveforms max
10k	3,000 waveforms max
100k	300 waveforms max
1M	20 waveforms max
5M	4 waveforms max

Steps From the Acquire menu, press Record Length and select the record length.

Record Length 1k, 10k, 100k, 1M, 5M

Example

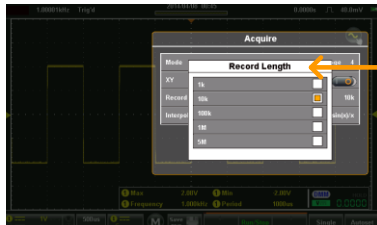

Record Length menu

Set the Interpolation

Background The GDS-200/GDS-300 has two types of interpolation modes: ET (Equivalent Time) and Sin(x)/x interpolation. Equivalent time sampling is able to achieve a sample rate of 20GSa/s when sampling periodic waveforms. Sin(x)/x interpolation uses a sinc interpolation formula to reconstruct a continuous signal between sampled points.

Sin(x)/x Samples of data are used to reconstruct a single waveform. Sin(x)/x sampling should be used when the time base is fast or if single shot events need to be captured.

Equivalent-time sampling Sampled data is accumulated a number of times to reconstruct a single waveform. This increases the sampling rate, but can only be used for repetitive signals. This mode is usually used when the time base is too fast for real-time sampling.

Steps From the Acquire menu, press Interpolation and select the interpolation method.

Interpolation ET, sin(x)/x

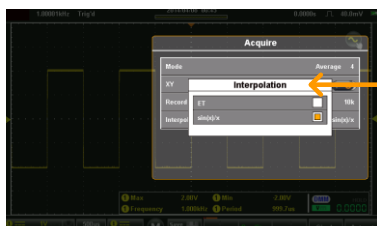

Interpolation menu

Display Menu

The Display Menu defines how the waveforms and parameters appear on the display.

Accessing the Display Menu

From the main screen, press the title bar to bring up the Drop Down menu. Press the Display icon to show the Display menu



Display the Waveform as Dots or Vectors

Background

When the waveform is displayed on screen, it can be displayed as dots or vectors.

Modes

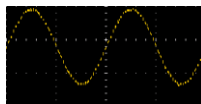

Dots: Only sampled dots are displayed.

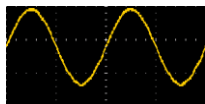

Vectors: Both the sampled dots and the connecting line are displayed.

Steps

From the Display menu press Type and select the display mode.

Type Vectors, Dots

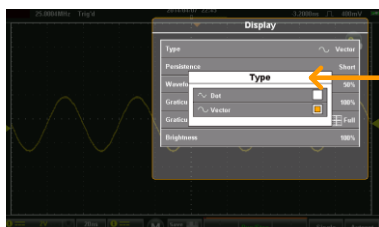

Type
Menu

Set the Level of Persistence

Background

The Persistence function allows the GDS-200/GDS-300 to mimic the trace of a traditional analog oscilloscope. A waveform trace can be configured to “persist” for a designated amount of time.

Steps

From the Display menu press Persistence and set the level of persistence with the slider or the preset keys.

Persistence Off, Short, Medium, Long,
 Infinite

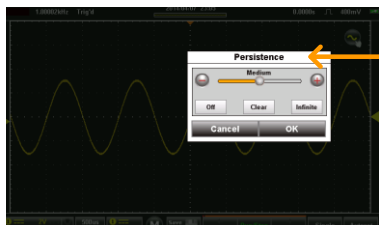

Persistence
Menu

Set the Waveform Intensity

Background The intensity level of a signal can also be set to mimic the intensity of an analog oscilloscope by setting the digital intensity level.

Steps From the Display menu press Waveform Intensity and select the intensity level.
Waveform Intensity 0 - 100%



Waveform
Intensity
Menu

Set the Graticule Intensity

Background The graticule intensity level can also be configured.

Steps From the Display menu press Graticule Intensity and select the intensity level.

Graticule Intensity 0 - 100%

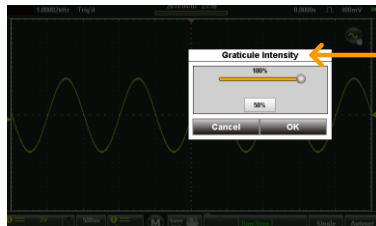

Graticule
Intensity
Menu

Set the Graticule Type

Background There are 4 types of selectable graticule.

Steps From the Display menu press Graticule and select the graticule type.



Full: Shows the full grid; X and Y axis for each division.



Grid: Show the full grid without the X and Y axis.



Cross Hair: Shows only the center X and Y frame.



Frame: Shows only the outer frame.

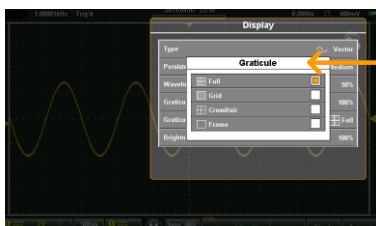

Graticule Menu

Set the Brightness Level

Background The Brightness menu sets the display brightness and the display power management, known as ECO mode. ECO mode turns the brightness down after a set amount of time until the display is touched again.

Steps From the Display menu press Brightness and select the brightness level and set the ECO mode time.

Brightness 0 - 100%

ECO Mode 1, 2, 5, 10, 30 minutes

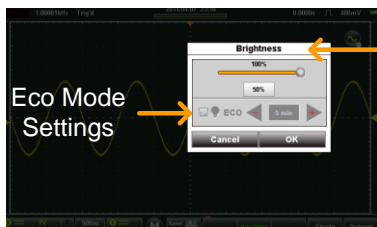

Eco Mode
Settings

Brightness
Menu

Go-NoGo Menu

A Go-NoGo test checks if a waveform fits inside a user-specified maximum and minimum boundary. Boundary templates can be automatically created from a source channel or created manually using the touch screen. Boundary tolerances and violation conditions can also be set.

Accessing the Go-NoGo Menu

From the main screen, press the title bar to bring up the Drop Down menu. Press the Go-NoGo icon to show the Go-NoGo menu



Configuring the Go-NoGo Menu

Source 1. Press the Source option to set the source waveform.

Source CH1, CH2

Condition 2. Press NoGo When to set the NoGo conditions.

- Enter Sets the NoGo condition to when the input signal stays within the limit boundary.
- Exit Sets the NoGo condition to when the input signal exceeds the limit boundary.

Violating 3. Press Violating to set the NoGo Action. This setting determines the action of the scope when the NoGo When setting is true.

- Stop The waveform stops when the conditions are violated.
- Stop Beep The waveform stops and a beep will be output when the conditions are violated.
- Continue Ignore violations and continue to monitor the signal.
- Continue Beep Output a beep when a violation occurs, but continue to monitor the signal.

Turn Go-NoGo On 4. Press Go-NoGo and turn Go-NoGo on.

An upper and lower template will appear on the display as Ref1 and Ref2, respectively.

The Template Edit option will now be available in the Go-NoGo menu.

- Template Edit 5. The Template Edit option configures the upper and lower template based on the source channel selected above.
6. Select either the Max/Min or the Auto option

Max/Min	Individually sets the offset for the upper and lower templates. These are based on the ground level of the source channel.
Auto	Sets the tolerance for the upper and lower template an equal distance from the source channel. This is set to 0.4% by default.

- Save Template 7. To save or recall a template, press the Option button when in the Template Edit menu.

For the Max/Min option, there are a number of recall options:

From	Allows you to recall either an internally saved reference waveform (Wave 1 - Wave 2), or to recall a reference waveform using the file manager.
To	Recall the waveform to R1 (upper template) or R2 (lower template).
Recall	Recalls the selected reference waveform to the corresponding template.

Save options:

Save Max to R1	Saves the Max template to reference 1.
Save Min to R2	Saves the Min template to reference 2.

For the Auto option, there is a single save option, there is not a recall option:

Save Template Saves both the upper and lower template to R1 and R2 respectively.

Max/Min Example

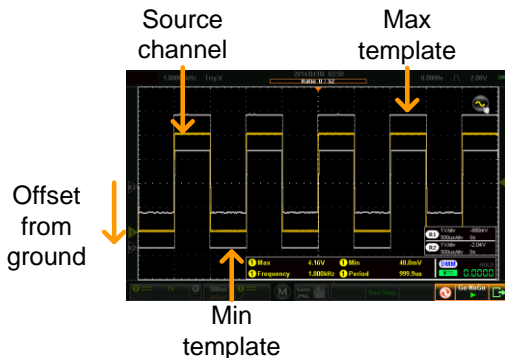

Auto Template

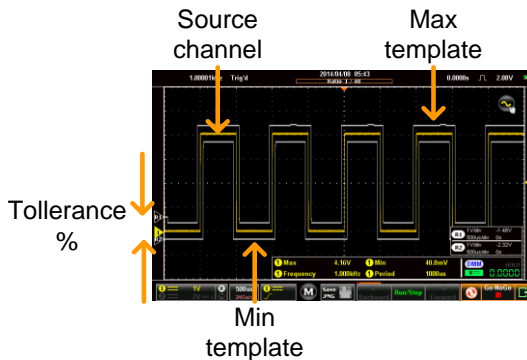

Running a Go-NoGo Test

Background

The Go-NoGo controls are located at the bottom left-hand corner of the screen. The Fail/Total ratio (Violations/Number of Tests) is shown in the title bar.

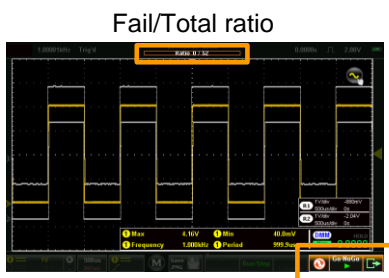

Go-NoGo controls

Run Go-NoGo Test

1. Toggle the Go-NoGo button from pause to play.



The test will run continuously until the test is stopped.

Pressing the Go-NoGo button again will stop the test and toggle the button back to pause.

If the Violating setting was set to Stop or Stop Beep, press the Go-NoGo button again to restart the test after it has stopped.

- Results
2. When Go-NoGo is running, the Fail/Total ratio is displayed in the title bar. The first digit represents the number of failed tests, and the second digit represents the number of tests.

When the test has stopped the scope goes into the Stop mode (page 81) allowing you to step through each acquisition with the Go-NoGo template overlay.

- Reset Go-NoGo
3. To reset the Go-NoGo test, press the Reset button .
-

- Exit Go-NoGo Testing
4. To exit from Go-NoGo testing press the Exit button .
-

Save Operations

The Save function configures the save file destination, file format and in the case of image files, the on-screen items that should be saved.



Note

When connected to a PC, files can only be saved if the USB mode is configured to “Communication”. See page 103 for details.

Accessing the Save Menu

From the main screen, press the title bar to bring up the Drop Down menu. Press the Save icon to show the Save menu.



Saving and Configuring Image Files

Background Image files can be saved to the internal memory in a number of file formats. Custom notes can also be saved with the image file. The brief mode allows Custom notes can also be attached to image files or on-screen items such as automatic measurements and trigger positions can be saved as extra data in the image file using the Brief Mode.

Image File Items	Destination	Selects the save file destination.
	File Format	Selects the image file format.
	Brief Mode	Embeds data into the image file.
	Note	Saves a note with the same filename as the image file is corresponds to.

- Save Image**
1. From the Save menu, press the Image tab.
 2. To save, press the Save button at the bottom of the image tab.

The file will be saved into the configured file path. See below for the configuration details.



- Destination**
3. Press Destination to set the save file destination. There are two options:

File Manager	Goes to the file manager to set the save-file path or to create new folders. See page 140 for details on using the file manager.
Rename	<p>By default, files are saved in the format DSXXXX.PNG, where XXXX is a number starting at 0001 that is incremented each time an image file is saved. This default save-filename can be changed using the Rename option.</p> <p>This option will allow you to rename the default file name using the on-screen keyboard.</p>

File Format	4. Press File Format to select the save file format:				
	<table border="0" style="margin-left: 40px;"> <tr> <td style="padding-right: 20px;">BMP</td> <td>Sets the image format to bitmap.</td> </tr> <tr> <td style="padding-right: 20px;">PNG</td> <td>Sets the image format to PNG (default format)</td> </tr> </table>	BMP	Sets the image format to bitmap.	PNG	Sets the image format to PNG (default format)
BMP	Sets the image format to bitmap.				
PNG	Sets the image format to PNG (default format)				

- Adding Notes (Text file)
5. To add Notes, Brief Mode must be turned off. When the Brief Mode is turned off, the Note option will be available.
 6. Press Note. The on-screen keyboard will appear. Enter your note and press OK when finished*. See page 48 for details on using the on-screen keyboard.

When the image file is saved, the note will be saved as text file (*.txt) into the same file path and with the same base filename as the image file.

*Multilanguage notes are possible if the system language is not English.

Brief Mode Brief mode adds a series of user-selectable data to the bottom of an image file. It also reverts the normally black background into a white background for easy printing.

7. Toggle Brief Mode on.
8. Press Brief Mode Setting to set what data gets saved to the image file:

Date&Time	Saves the date and time.
Vertical	Saves the vertical scale, coupling, DC mode and bandwidth limit of all the active channels.
Horizontal	Saves the horizontal position and scale.
Trigger	Saves the trigger channel, coupling, slope, frequency rejection, Noise rejection, trigger level and other data associated with the selected trigger type.
Cursor	Saves the cursor position to the image file.
Cursor Measure	Saves the cursor information overlay to the image file.
Measure	Saves automatic measurements and DMM measurement readings.
Note	Adds a user-created note at the bottom of the image file. Note: Multilanguage notes are possible if the system language is not English.

- To preview the image file before saving, press the Preview button.

Example Image File with Brief Mode = On

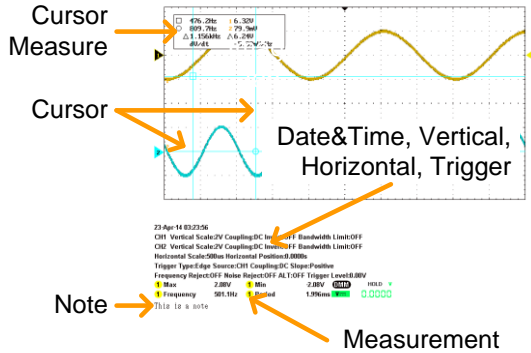

Saving and Configuring Waveform Files

Background Each displayed waveform can be saved either separately or together in a folder for later recall. Waveforms can be saved from any of the source channels, reference channels or math waveform.

Waveform File Items	From	Selects the waveform source
	Destination	Selects the destination to save the waveform.

- Save Waveform**
- From the Save menu, press the Waveform tab.
 - To save, press the Save button at the bottom of the Waveform tab.

The file will be saved into the configured file path with the configured file format. See below for the configuration details.



Save button

- | | |
|------|-------------------------------------------------------------------------------------------------------------------------------------------------------------------------------------------------------------------------------------------------------------------------------------------------------------------------------------------------------------------------------------------------------|
| From | <p>3. Use the From option to select the source waveform:</p> <ul style="list-style-type: none"> 1 Channel 1 2 Channel 2 M Math source R1 Reference waveform 1 R2 Reference waveform 2 All Displayed Saves all the displayed waveforms into a directory, ALXXXX, where XXXX is a number that is incremented each time a save is performed. |
|------|-------------------------------------------------------------------------------------------------------------------------------------------------------------------------------------------------------------------------------------------------------------------------------------------------------------------------------------------------------------------------------------------------------|

- | | |
|-------------|----------------------------------------------------------------------------------------------------------------------------------------------------------------------------------------------------------------------------------------------------------------------------------------------------------------------------------------------------------------------------------------------------------------|
| Destination | <p>4. If only a single source waveform is to be saved, the following destination options are available:</p> <ul style="list-style-type: none"> Wave1 Wave1 - Wave20 Ref R1 - R2 File Pressing File will allow you to either set the file path or rename the file from the default of DSXXXX.LSF, where XXXXX is a number that is incremented each time the waveform is saved. |
|-------------|----------------------------------------------------------------------------------------------------------------------------------------------------------------------------------------------------------------------------------------------------------------------------------------------------------------------------------------------------------------------------------------------------------------|

5. If All Displayed waveforms are to be saved, then the following destination options are available:

File Manager Pressing File will allow you to change the file path from the root directory of the internal disk.

Rename Pressing Rename will allow you to rename the default directory from ALXXXX.

File Format

6. Press File Format to select the save file format:

LSF Internal file format. This format saves and recalls waveforms the fastest.

Fast CSV Comma separated values. Allows the waveforms to be saved in a format that is readable by spreadsheets.



Note

Fast CSV files can only be recalled if the record length is 1k or 10k.

Adding Notes

A text file note can be added to the same file path as the saved waveform file.

7. Press Note. The on-screen keyboard will appear. Enter your note and press OK when finished. See page 48 for details on using the on-screen keyboard.

When the waveform file is saved, the note will be saved as a text file (*.txt) into the same file path and with the same base filename as the image file.

For example if the waveform is saved as DS001.lsf then the note will be saved as DS001_LSF.txt.

Saving and Configuring Setups

Background Setup files can be saved so that the instrument state can be recalled at a later time.

Setup File Items **Destination** Selects the save file destination.

- Save Setup**
1. From the Save menu, press the Setup tab.
 2. To save, press the Save button at the bottom of the Setup tab.

The file will be saved into the configured destination. See below for the configuration details.

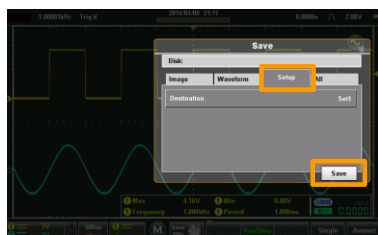

Setup tab

Save button

Destination 3. Press Destination to set the destination:

Set Set 1 - Set 20

Press Edit label to set a label for the selected setup slot.

File

Pressing File will allow you to either set the file path or rename the file from the default of DSXXXX.SET, where XXXX is a number that is incremented each time the waveform is saved.

Saving and Configuring Images, Waveforms and Setups All at Once

Background Images, Waveforms and Setup files can all be saved at the same time into a directory at the same time using the All option.

All File Contents All the files are saved, by default, to a directory named AXXXX, where XXXX is a number that is incremented each time a save operation is performed.

AXXXX.PNG	Image file
AXXCH1/2.LSF	Waveform save file
DSXXXX.SET	Setup up file

- Save All**
1. From the Save menu, press the All tab.
 2. To save, press the Save button at the bottom of the All tab.

An image file, setup file and waveform files will be saved into the configured destination. See below for the configuration details.

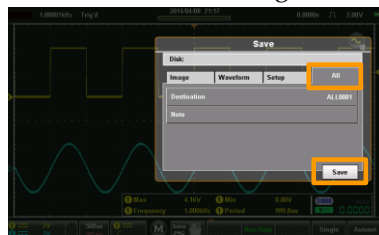

All tab

Save button

- Destination**
3. Press Destination to set the destination:

- File Manager Goes to the file manager to set the save-file path or to create new folders. See page 140 for details on using the file manager.
- Rename By default, files are saved into a directory called AXXXX, where XXXX is a number starting at 0001 that is incremented each time a save operation is performed. This option will allow you to rename the default directory name using the on-screen keyboard.

Recall Operations

The Recall function configures the save file destination, file format and in the case of image files, the on-screen items that should be saved.



Note

Files can only be recalled if the USB port is configured to “Communication”. See page 103 for details.

Accessing the Recall Menu

From the main screen, press the title bar to bring up the Drop Down menu. Press the Recall icon to show the Recall menu.



Recalling Waveform Files

Background

Waveforms can be recalled from either the internal memory slots (wave1 - wave20) or files saved in the LSF or CSV file formats.

Waveform Recall Items	From	Selects the source waveform.
	To	Selects the destination to recall to.
	File Format	Selects the file format to recall.

- Recall Waveform
1. From the Recall menu, press the Waveform tab.
 2. To recall, press the Recall button at the bottom of the Waveform tab.

The waveform will be recalled from the configured file path/source and recalled to one of the reference waveforms. See below for configuration details.

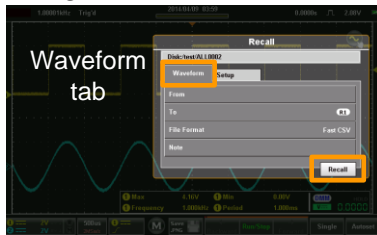

Recall button

- From
3. The From option selects the source waveform:
 - Wave Wave 1 - Wave 20
A label can also be set for the recalled waveform.
 - File *.LSF and *.CSV files can be recalled from the file manager.

- To
4. The To option selects where to recall the waveform:
 - R1, R2 Reference 1, reference 2

File Format 5. Chooses the file format that is to be recalled. This option will determine whether *.LSF or *.CSV files are shown in the From option.

LSF Internal file format.

CSV Comma separated values.



Note

Fast CSV files can only be recalled if the record length is 1k or 10k.

View & Edit
Notes

If a note for the selected file has been saved, the Note option will display the contents of the note. Pressing the Note option will allow you to edit the note.

6. Press Note. The on-screen keyboard will appear. The note can now be edited.

Note that the waveform note can be edited even after if it is recalled.

Recalling Setups

Background Setup files can be recalled from the internal Set (setup) memories or from the internal disk.

Setup Recall Items From Selects the source setup.

- Recall Setup
1. From the Recall menu, press the Setup tab.
 2. To recall, press the Recall button at the bottom of the Setup tab.

The setup will be recalled from the configured source. See below for the configuration details.

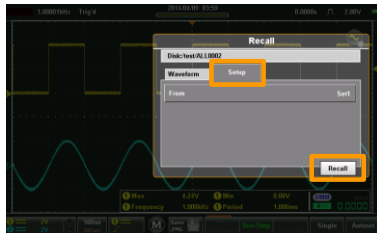

Setup tab

Recall button

From 3. Press From to set the source:

Set Set 1 - Set 20

Press Edit label to set a label for the selected setup slot.

File Pressing File will allow you to select a source file (XXXX.SET) from the internal disk.

File Manager

The file manager is used to navigate the internal file system, create new folders or to delete files.

Accessing the File Manager

From the main screen, press the title bar to bring up the Drop Down menu. Press the File Manager icon to show the File Manager.



Navigating the File System

Background

The following diagram will show the file manager functions.

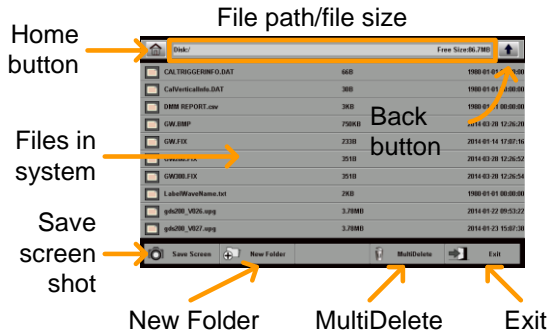

Home button	Goes back to the root directory.
Back button	Goes back to the previous directory.
Save screen shot	Saves a screen shot of the file manager.
New Folder	Creates a new folder.
MultiDelete	Allows you to delete multiple files at the once.
Exit	Exits the file manager.

- Navigation
1. Scroll up and down to view files that are out of view.
 2. Select a folder to enter a directory.
 3. Press the Back button to return to the previous directory.
 - Selecting an image file will allow you to preview the image.
 - Selecting a text(note) file will preview the message.
 - Selecting an *.UPG (upgrade) file will allow you to upgrade the firmware.

- Create Folder
4. Press the New Folder button to create a new file.
 - Enter the name of the new folder using the popup keyboard.

- Delete or Rename Files
5. Long press the file that you want to delete or rename.
 - Choose to Delete or Rename the file from the popup that appears.

- MultDelete
- The MultiDelete button allows you to delete multiple files at once.
6. Press the MultiDelete button.
 7. Select the files that you want to delete by marking the relevant checkboxes.
 8. After the checkboxes are marked, press Delete, then OK to confirm.

- Save Screenshot
- Press Save Screen to save a screenshot of the file system.

Exit

Press Exit to exit from the file system.

DMM Mode

The DMM function can be used simultaneously with the DSO function. The DMM function is a basic digital multimeter. By default the DMM measurements are hidden in landscape mode. In the vertical display mode the DMM functions and measurements are displayed on the bottom of the screen automatically.

Accessing the Multimeter

There are two methods to access the DMM. Most of these instructions assume that the scope is in the vertical mode. See page 34 to switch to the vertical mode.

First Method: From the main screen, press the title bar to bring up the Drop Down menu. Press the DMM icon to show the multimeter settings.

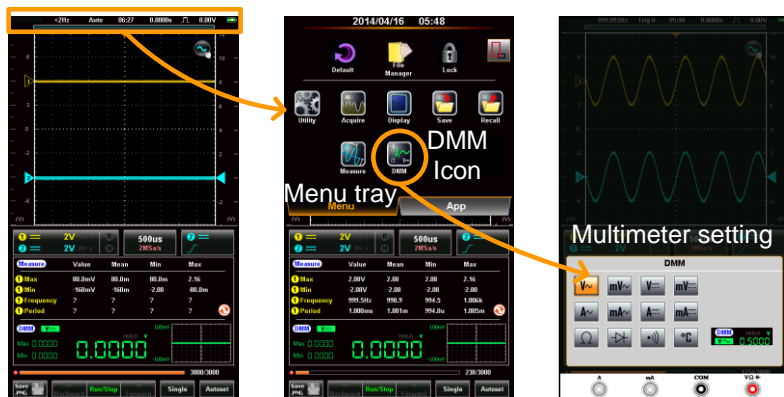

Second Method:

Vertical Orientation: Press and hold the DMM area for a short while to directly bring up the multimeter settings.

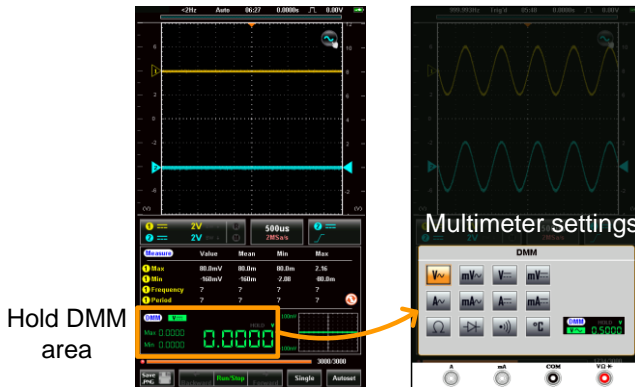

Horizontal Orientation: Press the Measure button to reveal the DMM area*. Press and hold the DMM area for a few seconds to bring up the multimeter settings.

*The DMM area can be expanded/collapsed by pressing once on the DMM area.

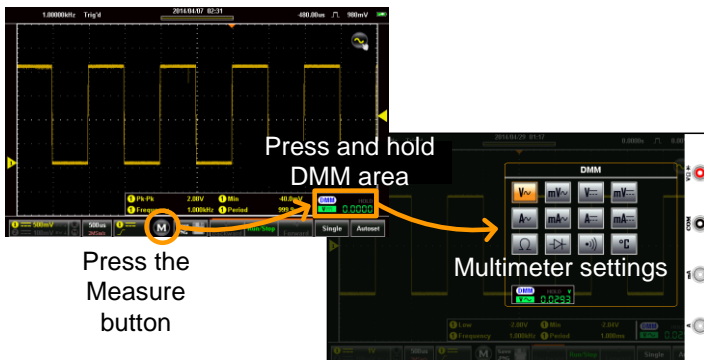

Multimeter Display Overview

The DMM display will show the measurement mode, max, min and current measurement, and a trend plot (vertical view only) of the last 120 measurements. Please note that in the horizontal view, the DMM display is only fully shown in the expanded view, see above for details.

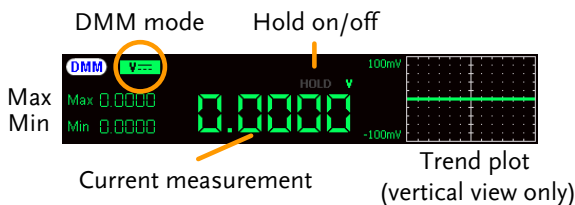

AC/DC Voltage Measurement

Background

The GDS-200/300 can measure up to 600V (CAT II) or 300V (CAT III).

Connection

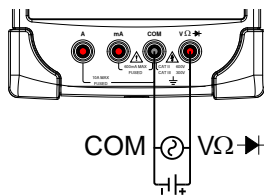

Steps

1. From the multimeter settings choose ACV, ACmV, DCV or DCmV.

ACV =

ACmV =

DCV =

DCmV =

- The selected mode will be previewed in the lower corner.

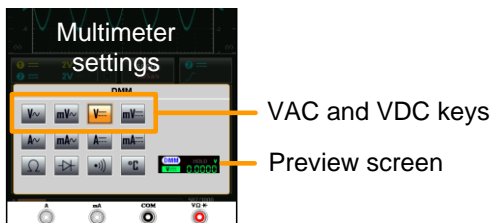

- Press anywhere outside of the multimeter settings area to return to the main display.

Example

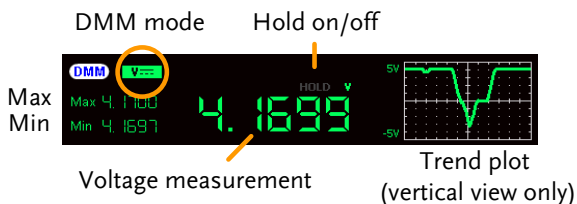

 Note

To prevent the internal circuits from burning out, the unit will prevent you from switching voltage ranges during measurement when the input is greater than 10V. To switch ranges, first disconnect the probes from the DUT.

Current Measurement

Back Ground The GDS-200/300 can measure AC and DC current from two input terminals, depending on the current range. There is a 10A input for $I \leq 10A$, and a mA terminal for $I \leq 600mA$.

Connection

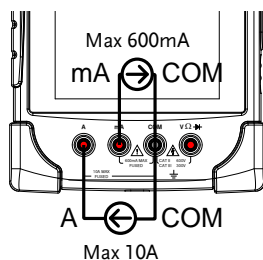

Steps

1. From the multimeter settings choose ACA, ACmA, DCA or DCmA. Ensure that no more than the 600mA is input into the mA port.

ACA =

ACmA =

DCA =

DCmA =

2. The selected mode will be previewed in the lower corner.

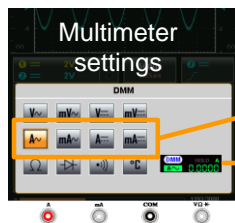

Note

Ensure that no more than 600mA is input into the mA port. Failure to do so will blow the fuse. See page 178 to replace the fuse.

3. Press anywhere outside of the multimeter settings area to return to the main display.

Example

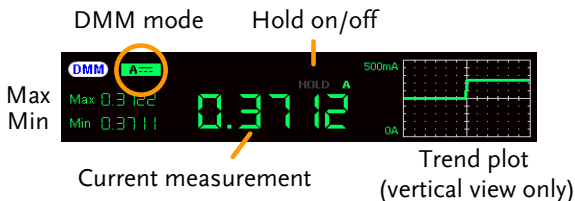

Resistance Measurement

Back Ground

The GDS-200/300 can measure resistance up to 4 counts.

Connection

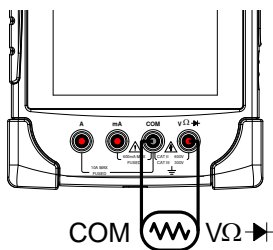

Steps

1. From the multimeter settings choose the resistance measurement.

Resistance =

- The selected mode will be previewed in the lower corner.

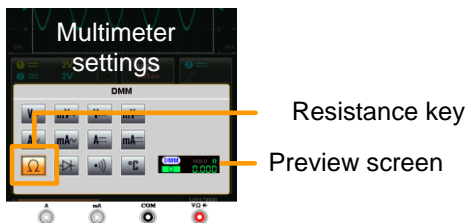

- Press anywhere outside of the multimeter settings area to return to the main display.

Example

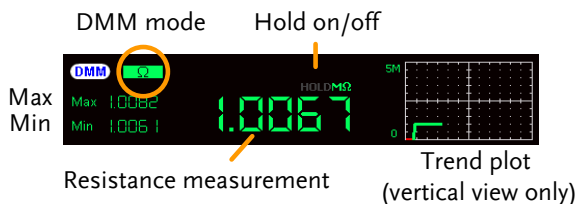

Diode Measurement

Back Ground

The diode test checks the forward bias characteristics of a diode by running a constant forward bias current through the DUT and measuring the forward voltage drop.

Connection

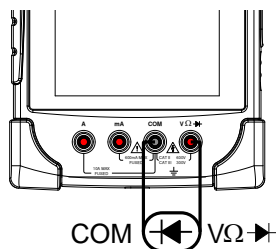

Steps

1. From the multimeter settings choose the diode measurement.

Diode = 

2. The selected mode will be previewed in the lower corner.

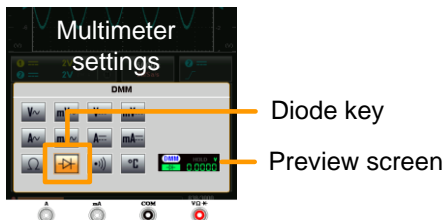

3. Press anywhere outside of the multimeter settings area to return to the main display.
4. OPEN will be displayed when the diode passes the diode test.



Note

Ensure the diode polarity is correct before performing the diode measurement.

Example

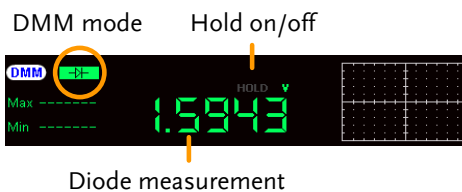

Continuity Measurement

Back Ground The continuity test checks that the resistance in the DUT is low enough to be considered continuous (of a conductive nature). The continuity threshold level is set to $<15\Omega$.

Connection

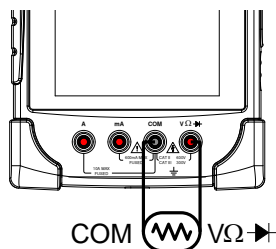

Steps

1. From the multimeter settings choose the continuity measurement.

Continuity =

2. The selected mode will be previewed in the lower corner.

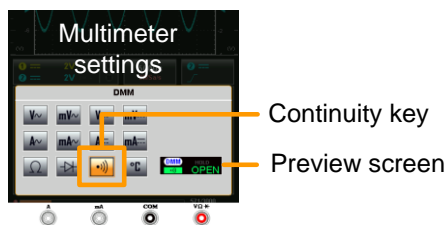

3. Press anywhere outside of the multimeter settings area to return to the main display.
4. The approximate resistance will be displayed when there is continuity present in the connection.

OPEN will be displayed if continuity is not present.

Example

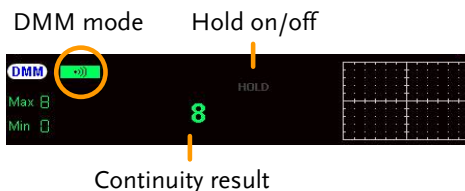

Temperature Measurement

Back Ground

The GDS-300 can measure temperature using a thermocouple. To measure temperature, the DMM accepts a thermocouple input and calculates the temperature from the voltage fluctuation. The thermocouple type is taken into consideration. Temperature measurement is only supported on the GDS-300.



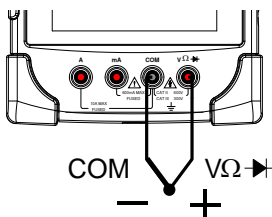

Please see the specifications on page 186 for the thermocouple specifications.

Connection



Steps

1. From the multimeter settings choose the temperature measurement.
 - Pressing the Temperature button will toggle between °C and °F.

Temperature =  / 

2. Next, select the thermocouple type.

Thermocouple = B E, J, K, N, R, S, T

3. The selected mode will be previewed in the lower corner.



Thermocouple type
Preview screen

Temperature key/toggle
temperature unit

4. Press anywhere outside of the multimeter settings area to return to the main display.

Example

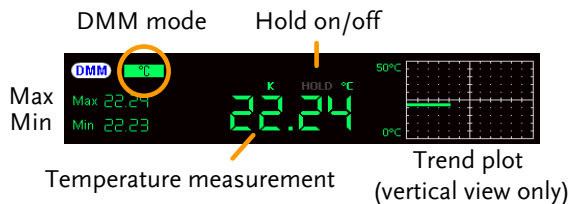

Note

To set the thermocouple reference junction temperature, the Advanced DMM app needs to be used. Please see page 157.

EE APPs

The GDS-200/300 has a number of handy engineering apps built-in. The following apps are available by default:

Attenuation Calculator, Resistance Calculator, Calculator, Advanced DMM, Template Editor and QR-Code Link.

Accessing the EE Apps

From the main screen, press the title bar to bring up the Drop Down menu. Press the App tray to show the EE Apps menu tray.



Attenuation Calculator

Background The attenuation calculator calculates the resistor values of 5 common attenuator circuits. The only input required is the attenuation required (dB), the system impedance (Z_0) and the resistor accuracy (Standard E6 - E192).

Example

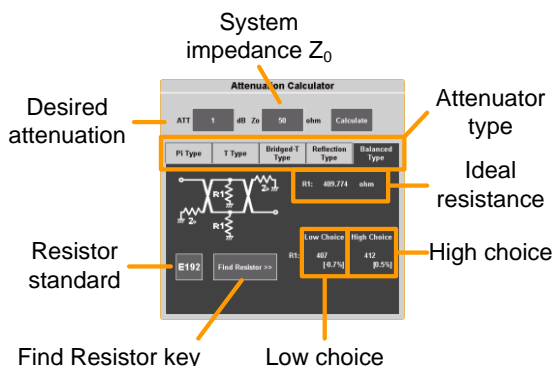

- Steps**
1. From the EE Apps tray select the Attenuation Calculator icon.
 2. In the ATT field enter the attenuation required in dB.
 3. In the Z_0 field input the system impedance in ohms. This value is typically 50Ω.
 4. Select the type of attenuator circuit.
 Circuit: Pi Type, T Type, Bridged-T Type, Reflection Type, Balanced Type

5. Press Calculate. This will calculate the exact resistance values required for the desired attenuation and system impedance
6. Press the EXXX button to select the resistor standard.
7. Press Find Resistor to find the resistors that most closely match the ideal resistance values calculated in step 5.
 - The best high and best low resistors are shown along with the percentage offset from the ideal value.

Advanced DMM

Background

The Advanced DMM is similar to the regular DMM mode, however it is full screen and includes an advanced trend plot that can log up to 400 measurements. The trend plot is able to log from 40 seconds to 6 hours worth of measurements.

Example

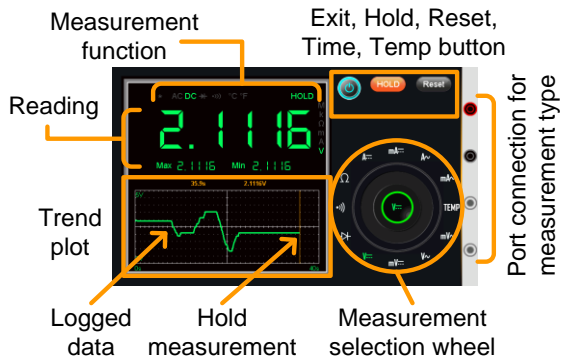



Note

Please see the DMM chapter for details on the different measurement modes and connections. See from page 144.

Select
Measurement

1. From the EE Apps tray select the Advanced DMM icon.
 2. From the measurement selection wheel select the measurement type.
 3. The current measurement, minimum and maximum measurement will be shown as soon as the measurement type is selected.
-



Note

*See step 9 to set the temperature units, thermocouple type and reference junction temperature.

Logging

4. Data is automatically logged as soon as a measurement function is selected. Logged data is plotted as a green line in the trend plot.
 5. Press the Time button and select the logging time. Press OK to confirm the logging duration time.
 6. The time is shown as the X-axis of the trend plot.
Time: 40s, 3m, 6m, 15m, 30m, 1hr, 3hr, 6hr
 7. To pause the measurement and data logging, press the Hold button.
 8. To reset the logging, press the Reset button.
-

Temperature Measurement Background	When a thermocouple is connected to the GDS-200/300, the temperature difference between the thermocouple lead and the input terminals should be taken into account and cancelled out; otherwise an erroneous temperature will be calculated. This temperature difference is the junction temperature, and for the GDS-200/300 this is equal to the ambient temperature.
Temperature Configuration	<ol style="list-style-type: none">9. From the measurement wheel select TEMP.10. Press the Temp button above the measurement wheel. A setting screen will appear.11. Select the temperature units in the Temperature Units selection box: Temperature Units: Celsius, Fahrenheit12. Under Types, select the thermocouple type: Types: B, E, J, K, N, R, S, T13. Set the reference junction temperature, using the Ambient Temperature setting: Ambient temperature: 0°C ~ 50°C14. Press OK to confirm the settings.
Exit	To exit from the Advanced DMM app, press the Exit button. The advanced DMM will retain its state even after exiting, allowing data logging to continue.

Calculator

Background The Calculator function is a convenient scientific calculator especially suited to electronic calculations.

Example



Keypad

- Steps**
1. From the EE Apps tray select the Calculator app.
 2. Using the keypad, enter the desired equation.
 - The equations follow standard order of operations.
 - The equation will appear on the top left-hand side.
 3. Press the Equals button to perform the calculation
 - The answer will appear in the bottom right-hand side.

QR Code Link App

Background

The QR Code Link app displays QR codes for commonly used websites relating to the GDS-200/300. The GW Instek webpage is included as an example.

To use the QR Code Link app, download a QR code reader app for your smartphone and read the QR codes from the QR Code Link app.

Example

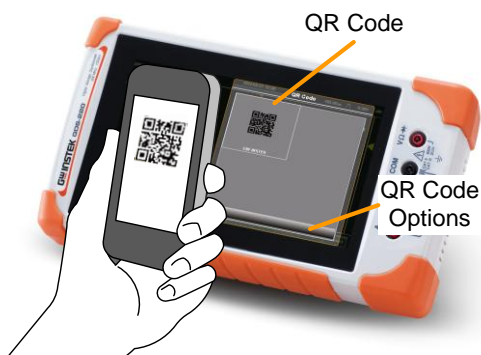

Resistance Calculator

Background

The resistance calculator can calculate the value of a resistor based on the band code. The calculator can also calculate the resistance of SMD resistors based on the 3/4 digit SMD code, EIA-96 (1%) or 2/5/10% code.

See page 179 for information on the various resistor codes.

Standard Resistor 1. From the EE Apps tray select the Resistance Calculator icon.

2. Press the Color Code button for standard pin-type resistors.
3. Select the 4 band or 5 band tab.
4. Press each of the colored bands in succession and choose the appropriate color for each band from the pop-up window.

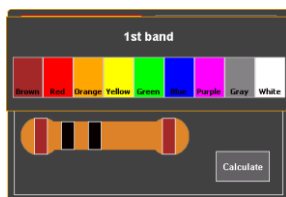

5. Press Calculate to calculate the value of the resistor.

Example:
Color Code

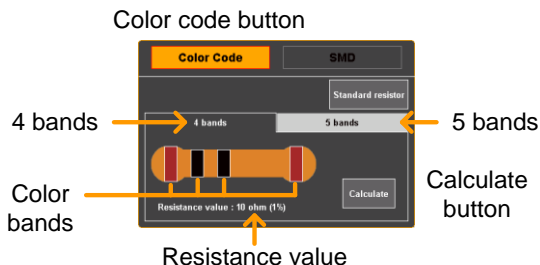

SMD Resistor
Values

1. SMD resistor values can be calculated in one of 3 ways; using a 3 or 4 digit code, using EIA-96 code or using 2%/5%/10% code.
2. Press the SMD button to select SMD resistors.
3. Select the tab corresponding to code used on the SMD.

SMD 3-digit/4-digit code
 EIA-96
 2%, 5%, 10%

4. Press the SMD code button and enter the SMD code in the pop-up window.
5. Press Calculate to calculate the value of the SMD resistor.

Example:
 SMD

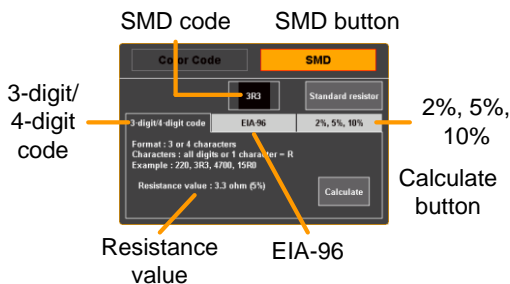

Template Editor

Background

The Template Editor function can be used for Go-NoGo testing. Templates can be edited from existing templates created from the Go-NoGo function or drawn directly from the touch screen.

See page 119 for details on using the Go-NoGo function.

Example

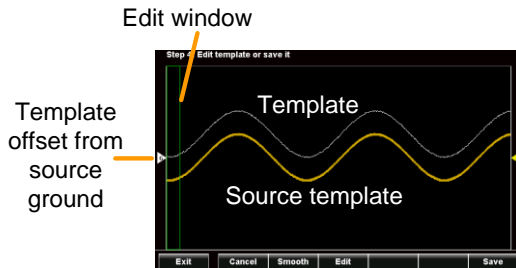

Steps

1. From the EE Apps tray select the Template Editor icon.
2. Select "Draw New Template" or "Load template from...".
 - Draw New Template Draw a template freehand
 - Load Template from... Uses a previously saved waveform as a template

3. Select a source channel and press Next.
4. If "Draw New Template" was selected, simply trace a template (from left to right) on the screen using the source as guide. The template will be created from a number of points.
 - Press Clear to redo the template drawing.
 - Press Undo to delete the last trace point.
 - After the points have been drawn, touching any point on the screen will return the vertical value.

Press Next when the template is drawn.

5. After the template is first drawn/loaded, the template offset can be edited by swiping the screen up or down from the left of the graticule.
6. To edit the template further, swipe the screen

left and right to position the green edit window and press the Edit button.

- Each point within the edit window can now be edited to a fine scale by drawing on the screen.
 - Press OK when done.
7. To smooth the template press the Smooth button.
 - Points will be removed to smooth the template.
 8. To save the template, press the Save button.
 - Choose to save the template to Ref1, Ref2 or as an *.LSF file.
 9. After saving, you will be given the option to: edit a new template, go directly to the Go-NoGo function or to exit from the Template editor.

REMOTE CONTROL

CONFIG

This chapter describes basic configuration for remote control. For a command list, refer to the programming manual downloadable from the GWInstek website, www.gwinstek.com

Interface Configuration	167
Configure USB Interface	167
Remote Control Function Check	168
Using Realterm to Establish a Remote Connection.....	169

Interface Configuration

The GDS-200/300 uses the USB device port for remote control. When using the remote control function, the GDS-200/300 acts as a virtual COM port (VCP).



Note

New drivers can be downloaded from the GW Instek website, www.gwinstek.com.

Configure USB Interface

Configuration	PC side connection	Type A, host port
	GDS side connection	Type Mini-B, device port
Background	The GDS's USB device port needs to be configured to the "Communication" mode to enable the remote connection.	
Configuration	<ol style="list-style-type: none"> 1. Connect the PC to the GDS-200/300 using the supplied USB-A to USB Mini-B cable. 2. From the Drop Down menu press the Utility icon>USB device port and select Communication. (See page 103). 3. When the PC asks for the USB driver, select the USB driver included on the accompanying User Manual CD or download the driver from the GW Instek website, www.gwinstek.com. The driver automatically sets the GDS-200/300 as a virtual COM port. 4. The DSO should now be ready for remote control. See page 168 for the remote control function check. 	

Remote Control Function Check

Functionality
check

Invoke a terminal application such as Realterm.

In the terminal program, set the COM port, baud rate, stop bit, data bit and parity to match the settings for the virtual COM port of the DSO.

To check the COM settings of the DSO in Windows, see the Windows Device Manager. For example, in WinXP go to the Control panel → System → Hardware tab.



Note

If you are not familiar with using a terminal application to send/receive remote commands, please page 169 (Using Realterm to Establish a Remote Connection) for more information.

Run this query command via the terminal after the instrument has been configured for USB remote control (page 167).

*idn?

This should return the Manufacturer, Model number, Serial number, and Firmware version in the following format.

- GW,GDS-310, XXXXXXXX, VX.XX
-



Note

For further details, please see the programming manual, available on the GW Instek web site @ www.gwinstek.com.

Using Realterm to Establish a Remote Connection

Background Realterm is a terminal program that can be used to communicate with a device attached to the serial port of a PC or via an emulated serial port via USB.

The following instructions apply to version 2.0.0.70. Even though Realterm is used as an example to establish a remote connection, any terminal program can be used that has similar functionality.



Note

Realterm can be downloaded on Sourceforge.net free of charge.

For more information please see <http://realterm.sourceforge.net/>

- Operation**
1. Download Realterm and install according to the instructions on the Realterm website.
 2. Connect the GDS-200/300 via USB to a PC and configure for remote control connection (page 167).
 3. Make note of the baud rate, stop bits and parity of the VCP driver.

Go to the Windows device manager and find the COM port number for the connection. For example, go to the Start menu > Control Panel > Device Manager

Double click the *Ports* icon to reveal the connected serial port devices and the COM port for each connected device.

The baud rate, stop bit and parity settings can be viewed by right-clicking the connected device and selecting the *Properties* option.

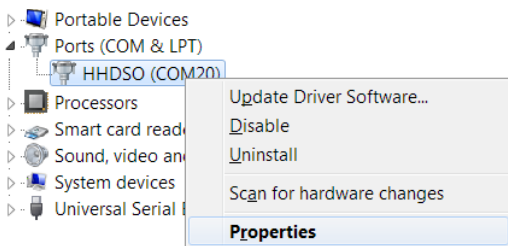

4. Start Realterm on the PC as an administrator.
Click:
Start menu>All Programs>RealTerm>realterm

Tip: to run as an administrator, you can right click the Realterm icon in the Windows Start menu and select the *Run as Administrator* option.

5. After Realterm has started, click on the *Port* tab.

Enter the *Baud*, *Parity*, *Data bits*, *Stop bits* and *Port* number configuration for the connection.

The *Hardware Flow Control* and *Software Flow Control* options can be left at the default settings.

Press *Open* to connect to the GDS-200/300.

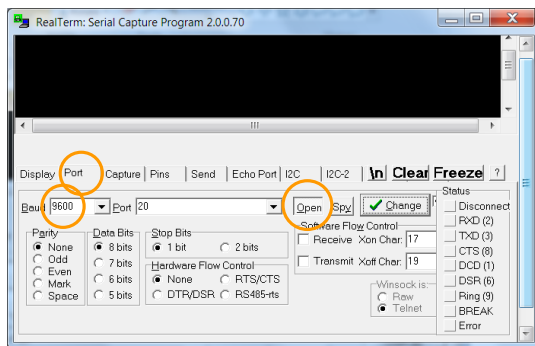

- Click on the *Send* tab.

In the *EOL* configuration, check on the *+CR* and *+LF* check boxes.

Enter the query:

**idn?*

Click on *Send ASCII*.

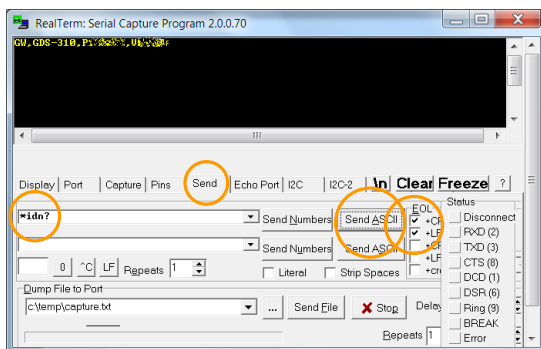

- The terminal display will return the following:

GW, GDS-310, XXXXXXXX, VX.XX

(manufacturer, model, serial number, version)

- If Realterm fails to connect to the unit, please check all the cables and settings and try again.

F AQ

- I connected the signal but it does not appear on the display.
- I want to remove the measurement or FFT results from the display.
- The waveform does not update (frozen).
- The probe waveform is distorted.
- Autoset does not catch the signal well.
- The date and time settings are not correct.
- The accuracy does not match the specification.

I connected the signal but it does not appear on the display.

Make sure you have activated the channel by accessing the vertical menu. You can tell if the channel is activated if its channel indicator is to the left of the graticule. See page 51 to activate a channel.

I want to remove the measurement or FFT results from the display.

In the vertical display mode there is no way to remove the automatic measurements from the display. However in the horizontal display mode the automatic measurements can be removed by pressing the M (Measure) icon in the bottom of the display. See page 90 for further details.

The waveform does not update (frozen).

Press the Run/Stop key to unfreeze the waveform. See page 80 for details.

If this does not help, the trigger mode might be set to Single. Press the Run/Stop key to change out from Single mode.

The probe waveform is distorted.

You might need to compensate the probe. For details, see page 34.

Autoset does not catch the signal well.

The Autoset function cannot catch signals under 30mV or 20Hz. Please manually set the trigger conditions. See page 78 for Autoset details.

The date and time settings are not correct.

For date and time setting details, please see page 33. If it does not help, the battery may be flat. Charge the instrument.

The accuracy does not match the specification.

Make sure the device is powered On for at least 30 minutes, within +20°C-+30°C. This is necessary to stabilize the unit to match the specification.

For more information, contact your local dealer or GWInstek at www.gwinstek.com / marketing@goodwill.com.tw.

A PPENDIX

The Appendix contains basic maintenance, miscellaneous information and the device specifications.

Firmware Update	177
Fuse Replacement	178
Resistor Standards	179
Resistor Standards.....	179
Standard Resistor Code.....	179
3 or 4 Digit SMD Resistor Standards.....	180
EIA-96 Code	180
First Two Digits	180
Multiplier	181
2%, 5%, 10% Code.....	181
Multiplier	181
Last Two Digits	181
GDS-200/300 Default Settings	182
GDS-200/300 Specifications	183
Scope Specifications	183
Vertical.....	183
Signal Acquisition.....	183
Trigger.....	183
Horizontal	184
X-Y Mode.....	184
Cursors and Measurement	184
Miscellaneous	184
Battery.....	184
Probe Compensation	184
Interface.....	184
Display	185
Power Adapter.....	185
Dimensions and Weight.....	185

DMM Specifications.....	185
Basic.....	185
DC Voltage.....	185
DC Current.....	186
AC Voltage.....	186
AC Current*.....	186
Resistance*.....	186
Diode Test.....	186
Temperature (Thermocouple)*.....	186
Continuity Beeper.....	186
Continuity Beeper.....	187
GDS-200/300 Dimensions.....	188
Declaration of Conformity.....	189

Firmware Update

Background

The GDS-200/GDS-300 firmware can be upgraded by copying the new firmware to the internal memory and installing it.

New firmware can be downloaded on the GW Instek website.

1. From the Utility menu set the USB device port to Disk Drive. See page 103 for details.
2. The GDS-200/300 will be accessible to the windows file explorer. Copy the firmware file to the root directory of the GDS-200/GDS-300.
3. From the Utility menu set the USB device port back to the Communication setting.
4. From the File Manager, select the firmware file (tap the file name). See page 140 for details.
5. From the popup window select OK to update.
 - Do not turn the scope off during the update.
 - If using the battery power, ensure that there is adequate power before starting the update.
6. Cycle the power off and on after being prompted.

Fuse Replacement

Background The GDS-200/300 has fuse protection for both current ports, a 10A and a 1A fuse.

Fuse Type 1A: T1A 500V
 10A: T10A 500V

- Steps**
1. Turn the power switch off on the GDS-200/300.
 2. Remove the 4 screws that hold the back panel in place.

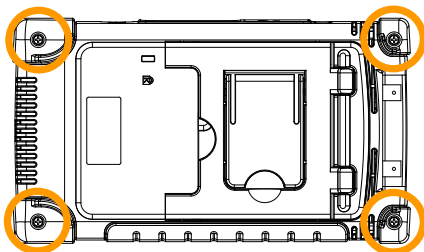

3. Remove the back panel carefully. You will need a case opening tool to pry open the case after the screws are removed.
 Note: the fan wiring is connected to the back panel.
4. Replace the fuse that has been blown, as shown below (bottom right-hand side).

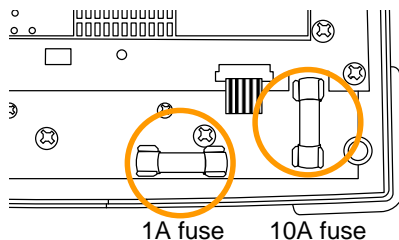

Resistor Standards

Resistor Standards

Standard	Tolerance	Standard	Tolerance
E6	20%	E48	2%
E12	10%	E96	1%
E24	5%	E192	0.5%

Standard Resistor Code

Standard resistors use colored bands to represent the value of the resistor. To read 4-colored bands, the first two digits represent the base value, the third is a multiplier and the last band is the tolerance. For a 5-colored band, the first 3 digits represent the base value, the 4th digit is the multiplier and the last digit is the tolerance.

Band color	Base digits	Multiplier	Tolerance
Black	0	10^0	-
Brown	1	10^1	$\pm 1\%$
Red	2	10^2	$\pm 2\%$
Orange	3	10^3	-
Yellow	4	10^4	-
Green	5	10^5	-
Blue	6	10^6	-
Violet	7	10^7	-
Grey	8	10^8	-
White	9	10^9	-
Silver	-	10^{-2}	$\pm 10\%$
Gold	-	10^{-1}	$\pm 5\%$

Example: 4 bands, Brown, Black, Black, Brown:

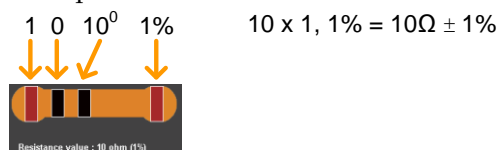

3 or 4 Digit SMD Resistor Standards

For 3 or 4 digit SMD codes, the first 2 or 3 digits represent the base value and the last digit represents the multiplier. The letter R is used as a decimal point.

Example1: The code 220 equals 22Ω.

Example2: The code 12R0 equals 12.0Ω.

EIA-96 Code

The EIA-96 standard is a 3 letter code. The first 2 digits codify a base value and the last digit is a letter that codifies a multiplier. EIA-96 code is used for tolerances of 1%.

First Two Digits

Code	Value	Code	Value	Code	Value	Code	Value	Code	Value	Code	Value
01	100	17	147	33	215	49	316	65	464	81	681
02	102	18	150	34	221	50	324	66	475	82	698
03	105	19	154	35	226	51	332	67	487	83	715
04	107	20	158	36	232	52	340	68	499	84	732
05	110	21	162	37	237	53	348	69	511	85	750
06	113	22	165	38	243	54	357	70	523	86	768
07	115	23	169	39	249	55	365	71	536	87	787
08	118	24	174	40	255	56	374	72	549	88	806
09	121	25	178	41	261	57	383	73	562	89	825
10	124	26	182	42	267	58	392	74	576	90	845
11	127	27	187	43	274	59	402	75	590	91	866
12	130	28	191	44	280	60	412	76	604	92	887
13	133	29	196	45	287	61	422	77	619	93	909
14	137	30	200	46	294	62	432	78	634	94	931
15	140	31	205	47	301	63	442	79	649	95	953
16	143	32	210	48	309	64	453	80	665	96	976

Multiplier

Letter Code	Multiplier	Letter Code	Multiplier
F	10 ⁵	B	10 ¹
E	10 ⁴	A	10 ⁰
D	10 ³	X or S	10 ⁻¹
C	10 ²	Y or R	10 ⁻²

Example: 01A = 100Ω

2%, 5%, 10% Code

A variation to the EIA-96 standard is also used for tolerances of 2%, 5% or 10%. This variation also uses a 3 letter code. The first digit codifies the multiplier and the last two digits codify the base value.

Multiplier

The multiplier is the same as the EIA-96 standard.

Letter Code	Multiplier	Letter Code	Multiplier
F	10 ⁵	B	10 ¹
E	10 ⁴	A	10 ⁰
D	10 ³	X or S	10 ⁻¹
C	10 ²	Y or R	10 ⁻²

Last Two Digits

2% Tolerance				5% Tolerance				10% Tolerance	
Code	Value	Code	Value	Code	Value	Code	Value	Code	Value
01	100	13	330	25	100	37	330	49	100
02	110	14	360	26	110	38	360	50	120
03	120	15	390	27	120	39	390	51	150
04	130	16	430	28	130	40	430	52	180
05	150	17	470	29	150	41	470	53	220
06	160	18	510	30	160	42	510	54	270
07	180	19	560	31	180	43	560	55	330
08	200	20	620	32	200	44	620	56	390
09	220	21	680	33	220	45	680	57	470
10	240	22	750	34	240	46	750	58	560
11	270	23	820	35	270	47	820	59	680
12	300	24	910	36	300	48	910	60	820

Example: A22 = 22Ω

GDS-200/300 Default Settings

The following default settings are the factory configuration settings for the GDS-200/300.

To return the factory default setting, press the Default  icon from the Drop Down menu. See page 95 to access the Drop Down menu.

Function Group	Default Settings	
Acquire	Mode: Sample Interpolation: Sin(x)/x Record length: 10k	XY: Off Sample rate: 100MSa/s
Display	Mode: Vector Waveform intensity: 50% Brightness: 80% (ECO:On)	Persistence: Short Graticule intensity: 50% Graticule: Full
Channel	Scale: 100mV/Div Coupling: DC Invert: Off Expand: By ground Probe: voltage	CH1: On Impedance: 1MΩ Bandwidth limit: Off Position: 0.00V Probe attenuation: 1x
Cursor	Horizontal cursor: Off	Vertical cursor: Off
Measure	Source: CH1 Display: Off	Gating: Screen Mean & Std Dev Samples: 2
Horizontal	Scale: 10us/Div	Position: 0.000s
Math	Source1: CH1 Source2: CH2 Unit/Div: 200mV	Operator: + Position: 0.00 Div Math: Off
Trigger	Type: Edge Coupling: DC Rejection: Off Slope: Positive Mode: Auto	Source: CH1 Alternative: Off Noise Rejection: Off Level: 0.00V Holdoff: 10.0ns
Utility	Hardcopy: Save image	File format: PNG

GDS-200/300 Specifications

The specifications apply when the GDS-200/GDS-300 is powered on for at least 30 minutes.

Scope Specifications

Vertical

Channel	2 (BNC-Shield)
Input Impedance	1M Ω
Maximum Input	CATII 300VRMs
Input Coupling	AC, DC, GND
Bandwidth	DC-70/100/200MHz (-3dB)
Rise Time	<5ns / 3.5ns / 1.75ns approx.
Sensitivity	2mV/div-10V/div (1-2-5 increments)
Accuracy	$\pm(3\% \times \text{Readout} + 0.1 \text{ div} + 1 \text{ mV})$
Bandwidth Limit	20MHz(-3dB)
Polarity	Normal, Invert
Offset Position Range	2mV/div-50mV/div : $\pm 0.4\text{V}$ 100mV/div-500mV/div : $\pm 4\text{V}$ 1V/div-5V/div : $\pm 40\text{V}$ 10V/div : $\pm 300\text{V}$

Signal Acquisition

Realtime Sample Rate	1GSa/s
Memory Depth	5M points per channel (GDS-307/310/320) 1M points per channel (GDS-207/210/220)
Acquisition Mode	Average: 2-256 waveforms Peak detect: 10ns sin(x)/x or ET
Replay wfms.	30,000 wfms

Trigger

Source	Ch1 or Ch2
Trigger Mode	Auto, Normal, Single, Force
Trigger Type	Edge, Pulse width, Video, Alternative
Trigger Holdoff	10ns - 10s
Coupling	AC, DC, LFR, HFR, NR

Sensitivity	DC - 25MHz: approx. 0.5div or 5mV 25MHz - 70/100/200MHz: approx. 1.5div or 15mV
-------------	------------------------------------------------------------------------------------

Horizontal

Range	5ns-100s/Div (1-2-5 increments)
Roll	100ms/div - 100s/div
Pre-Trigger	10 div max.
Post-Trigger	1,000 div max (depend on time base)
Accuracy	±20ppm over any > 1ms time interval

X-Y Mode

Phase Shift	±3° at 100kHz
-------------	---------------

Cursors and Measurement

Cursors	Voltage difference between cursors(ΔV), time difference between cursors(ΔT), frequency measure($1/\Delta T$)
Auto-measurement	36 sets
Auto-counter	6 digits. Range: 2Hz to rated bandwidth
Autoset	Available

Miscellaneous

Multi-language Menu	Available
On-line Help	Available
Time and Clock	Available

Battery

Battery Power	Li-polymer 6100mA/hr, 7.4V (Built-in)
Charge Time	2.0 hour (75%)
Operation Time	4.1 hours, depending on the operating conditions.

Probe Compensation

	2V, 1kHz, 50% Duty cycle
--	--------------------------

Interface

USB	USB Device (Isolated)
Internal Flash Disk	120MB

Display

Type	7 Inch
Display Resolution	480 x 800
Display Orientation	Landscape and Portrait
Backlight Control	Manual adjustable & ECO mode
Touch Panel	Capacitive

Power Adapter

Line Voltage	AC 100V-240V, 47-63Hz, Power Consumption 40W
DC Output	12V/3A, double shielded wire cable

Dimensions and Weight

Weight	1.5kg
Dimensions	HxWxD (mm) 240.2mm x 136.0mm x 59.7 mm

DMM Specifications

Basic

Reading	50,000 counts, 4½ digits (GDS-307/310/320) 3½ digits (GDS-207/210/220)
Voltage Input	CAT II 600VRMS, CAT III 300VRMS

Below are the basic conditions required to operate the DMM within specifications:

- * Calibration: Yearly.
- * Operating Temperature Specification: 18~28°C (64.4~82.4°F).
- * Relative humidity: 80%. (Non condensing)
- * Accuracy: ± (% of Reading + Digits).
- * AC measurement are based on a 50% duty cycle.

DC Voltage*

Range	50mV, 500mV, 5V, 50V, 500V, 1000V, 6 ranges
Accuracy	GDS-307/310/320: 50mV, 500mV, 5V, 50V, 500V: ±(0.05% + 5 digits); 1000V: ±(0.1% + 10 digits) GDS-207/210/220: 50mV, 500mV, 5V, 50V, 500V, 1000V: ±(0.1% + 10 digits)
Input Impedance	10MΩ

* Measure range: > 50μV

DC Current

Range	50mA, 500mA, 10A, 3 ranges
Accuracy	GDS-307/310/320: 50mA, 500mA: $\pm(0.1\% + 0.05\text{mA})$; 10A: $\pm(0.5\% + 50\text{mA})$ GDS-207/210/220: 50mA, 500mA: $\pm(0.5\% + 0.05\text{mA})$; 10A: $\pm(0.5\% + 50\text{mA})$

AC Voltage

Range	50mV, 500mV, 5V, 50V, 700V 5 ranges
Accuracy	50mV, 500mV, 5V, 50V, 700V: $\pm(1.5\% + 15 \text{ digits})$ at 50Hz-1kHz

* Amplitude greater than 0.2% of the full scale reading.

AC Current*

Range	50mA, 500mA, 10A 3 ranges
Accuracy	50mA, 500mA: $\pm(1.5\% + 0.05\text{mA})$ at 50Hz-1kHz; 10A: $\pm(3\% + 50\text{mA})$ at 50Hz-1kHz

* Measure range: >10mA

Resistance*

Range	500 Ω , 5k Ω , 50k Ω , 500k Ω , 5M Ω , 5 range
Accuracy	500 Ω , 5k Ω , 50k Ω , 500k Ω : $\pm(0.3\% + 3 \text{ digits})$; 5M Ω : $\pm(0.5\% + 5 \text{ digits})$

* Measure range: 50 Ω to 5M Ω

Diode Test

Maximum forward voltage 1.5V, Open voltage 2.8V

Temperature (Thermocouple)*

Range	-50°C - + 1000°C
Resolution	0.1°C
Thermocouple	B, E, J, K, N, R, S, T

* Specifications do not include probe accuracy. Temperature specifications only apply to the GDS-307/310/320.

Continuity Beeper

< 15 Ω

Continuity Beeper

Functions	Auto Range, Max, Min, Hold, Trend plot
-----------	----------------------------------------

GDS-200/300 Dimensions

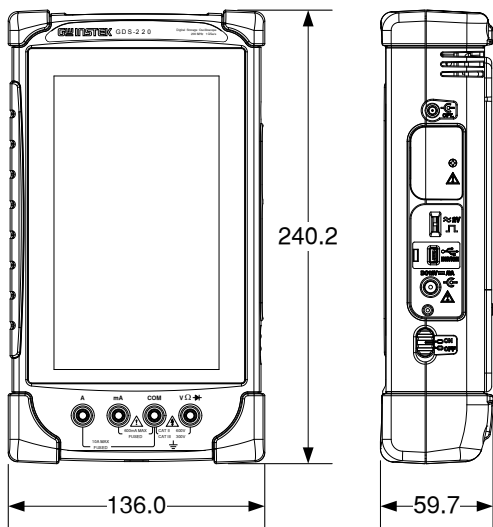
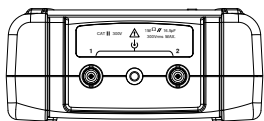

Declaration of Conformity

We

GOOD WILL INSTRUMENT CO., LTD.

declare that the below mentioned product

Type of Product: Compact digital Storage Oscilloscope and multimeter

Model Number: GDS-207, GDS-210, GDS-220, GDS-307, GDS-210, GDS-320

are herewith confirmed to comply with the requirements set out in the Council Directive on the Approximation of the Laws of the Member States relating to Electromagnetic Compatibility (2014/30/EU) and Low Voltage Directive (2014/35/EU).

For the evaluation regarding the Electromagnetic Compatibility and Low Voltage Directive, the following standards were applied:

© EMC	
EN 61326-1: EN 61326-2-1: EN 61326 2 2:	Electrical equipment for measurement, control and laboratory use -- EMC requirements (2013)
Conducted & Radiated Emission EN 55011: 2009+A1: 2010	Electrical Fast Transients EN 61000-4-4: 2012
Current Harmonics EN 61000-3-2: 2006+A1: 2009+A2: 2009	Surge Immunity EN 61000 4 5: 2006
Voltage Fluctuations EN 61000-3-3: 2008	Conducted Susceptibility EN 61000-4-6: 2009
Electrostatic Discharge EN 61000-4-2: 2009	Power Frequency Magnetic Field EN 61000-4-8: 2010
Radiated Immunity EN 61000-4-3: 2006+A1: 2008+A2:2010	Voltage Dip/ Interruption EN 61000-4-11: 2004
Low Voltage Equipment Directive 2014/35/EU	
Safety Requirements	EN 61010-1: 2010 (Third Edition) EN 61010-2-030: 2010 (First Edition) EN 61010-2-033: 2012 (First Edition)

GOODWILL INSTRUMENT CO., LTD.

No. 7-1, Jhongsing Road, Tucheng District, New Taipei City 236, Taiwan

Tel: [+886-2-2268-0389](tel:+886-2-2268-0389)

Fax: [+886-2-2268-0639](tel:+886-2-2268-0639)

Web: <http://www.gwinstek.com>

Email: marketing@goodwill.com.tw

GOODWILL INSTRUMENT (SUZHOU) CO., LTD.

No. 521, Zhujiang Road, Snd, Suzhou Jiansu 215011, China

Tel: [+86-512-6661-7177](tel:+86-512-6661-7177)

Fax: [+86-512-6661-7277](tel:+86-512-6661-7277)

Web: <http://www.instek.com.cn>

Email: marketing@instek.com.cn

GOODWILL INSTRUMENT EURO B.V.

De Run 5427A, 5504DG Veldhoven, The Netherlands

Tel: [+31-\(0\)40-2557790](tel:+31-(0)40-2557790)

Fax: [+31-\(0\)40-2541194](tel:+31-(0)40-2541194)

Email: sales@gw_instek.eu

INDEX

Accessories.....	14	Environment	
Advanced DMM	157	Safety instruction.....	7
Amplitude measurements.....	87	Erase memory.....	101
Area measurements.....	88	Erase Memory.....	101
Attenuation calculator.....	156	FAQ	173
Autoset configuration.....	104	File manager.....	140
Battery		Firmware update.....	177
Safety instruction.....	8	Frequency measurements.....	88
BNC Panel.....	20	Front panel diagram.....	15
Brightness.....	118	Fuse replacement.....	178
Buzzer.....	101	Gesture control	41
Calculator.....	160	Gestures.....	25
Calibration.....	106	Go-NoGo	119
Caution symbol.....	5	Running a test.....	123
Cleaning the instrument.....	7	Graticule.....	117
Common UI elements	47	Hardcopy configuration.....	101
Declaration of conformity.....	189	Help menu.....	28
Default settings.....	95	Horizontal orientation.....	34
Default settings list.....	182	Initial setup	30
Delay measurements.....	89	Date & time.....	33
Delete files.....	142	Language.....	34
Delete folders.....	142	Power up.....	30
Dimensions.....	188	Screen orientation.....	34
Display Overview.....	21	Stand.....	32
Disposal instructions.....	8	Intensity	
DMM.....	144	Graticule.....	116
Continuity.....	152	Waveform.....	115
Current.....	148	Interface configuration.....	167
Diode.....	150	Interface panel diagram.....	18
Resistance.....	149	Language.....	97
Temperature.....	153	Link cursors.....	86
Voltage.....	146	List of features.....	12
EE Apps.....	155	Mean measurements.....	87
EIA-96 codes	180	Model differences.....	12
EN61010		Operation	
measurement category.....	6	Acquisition.....	108
Pollution degree.....	7	Acquisition mode.....	109

ALT trigger.....	72	Peak measurements.....	87
Automatic measurement options	93	Peak to peak measurement.....	87
Automatic measurements.....	87	Power on/off	
Automatic measurements types	87	Safety instruction.....	7
Autoset.....	78	Probe compensation.....	34
Autoset configuration.....	104	Pulse measurements.....	88
Channel selection.....	51	QR code link app.....	161
Cursor operation.....	83	Rear panel diagram.....	17
Display.....	113	Recall.....	136
Display dots.....	113	Setup.....	139
Display vectors.....	113	Waveforms.....	136
Drop-down menu.....	95	Remote control.....	167
Edge trigger.....	74	Remote control function check	168
Force trigger.....	72	Realterm.....	169
Gesture control.....	41	Rename files.....	142
Horizontal expansion.....	61	Resistance calculator.....	161
Horizontal position.....	59	Resistor codes.....	179
Intensisty.....	115	Resistor standards.....	179
Interpolation.....	112	RMS measurements.....	87
Math.....	57	Ruler.....	105
Panel lock.....	96	Save.....	125
Panel lock.....	96	All.....	134
Persistence.....	114	Images.....	126
Pulse trigger.....	76	Setups.....	132
Record length.....	111	Waveforms.....	129
Reference waveforms.....	56	Service operation	
Run mode.....	80	About disassembly.....	6
Selecting automatic		contact.....	174
measurements.....	91	SMD codes.....	180
Single trigger mode.....	82	SPC.....	99
Touch sounds.....	101	Specifications.....	183
Trigger.....	66	System date & time.....	100
Trigger level.....	73	System date and time.....	33, 100
Trigger mode.....	71	System information.....	98
Trigger parameters.....	69	Template Editor.....	163
Trigger settings.....	68	Thermocouple junction	
UI elements.....	47	temperature.....	159
USB device port.....	103	Touch sounds.....	101
Utility menu.....	97	UK power cord.....	9
Vertical menu.....	50	Updating the firmware.....	177
Vertical options.....	53	USB device port.....	103
Vertical scale.....	52	USB driver installation.....	31
Video trigger.....	77	USB OTG.....	103
View automatic measurements.	90	Vertical orientation.....	34
XY mode.....	110	Warning symbol.....	5
Zoom.....	63		
Overshoot measurements.....	88		
Overview			
Using the touch interface.....	25		