

Multi-output DC Power Supply

GPE-1326/2323/3323/4323 Series

USER MANUAL

GW INSTEK PART NO. 82GP343230E01



ISO-9001 CERTIFIED MANUFACTURER

GW INSTEK

This manual contains proprietary information, which is protected by copyrights. All rights are reserved. No part of this manual may be photocopied, reproduced or translated to another language without prior written consent of Good Will company.

The information in this manual was correct at the time of printing. However, Good Will continues to improve products and reserves the rights to change specification, equipment, and maintenance procedures at any time without notice.

Table of Contents

SAFETY INSTRUCTIONS	5
OVERVIEW	10
Introduction.....	10
Series Lineup / Main Features	12
Principle of Operation	13
Front Panel Overview	15
Rear Panel Overview	23
CV/CC Crossover Characteristics	24
SETUP	25
Power Up	25
Load Cable Connection	26
Output On/Off.....	27
Select CH1/CH2 series or parallel mode	27
Switch between Channels.....	28
Setting Voltage Lock from Front Panel .	29
Set the output state at startup	29
Set the displayed digit resolution for the voltage/current	30
Remote Control Setting.....	31
OPERATION	32
CH1/CH2 Independent Mode	32
CH3 Independent Mode.....	34
CH4 Independent Mode.....	36
CH1/CH2 Series Tracking Mode.....	38
CH1/CH2 Parallel Tracking Mode	42
FAQ	44

A PPENDIX.....	45
Fuse Replacement	45
Specifications	46
Declaration of Conformity	48
I NDEX.....	49

S SAFETY INSTRUCTIONS

This chapter contains important safety instructions that you must follow when operating the GPE-1326/2323/3323/4323 series and when keeping it in storage. Read the following before any operation to insure your safety and to keep the best condition for the GPE-1326/2323/3323/4323 series.

Safety Symbols

These safety symbols may appear in this manual or on the GPE-1326/2323/3323/4323 series.



WARNING

Warning: Identifies conditions or practices that could result in injury or loss of life.



CAUTION

Caution: Identifies conditions or practices that could result in damage to the GPE-1326/2323/3323/4323 series or to other properties.



DANGER High Voltage



Attention Refer to the Manual



Protective Conductor Terminal



Earth (ground) Terminal



Do not dispose electronic equipment as unsorted municipal waste. Please use a separate collection facility or contact the supplier from which this instrument was purchased.

Safety Guidelines

General Guidelines



CAUTION

- Do not place any heavy object on the device.
- Avoid severe impacts or rough handling that leads to damaging the device.
- Do not discharge static electricity to the device.
- Do not block or obstruct the cooling fan vent opening.
- Do not perform measurement at circuits directly connected to Mains (see note below).
- Do not disassemble the device unless you are qualified as service personnel.

(Measurement categories) EN 61010-1:2010 specifies the measurement categories and their requirements as follows. The GPE-1326/2323/3323/4323 series falls under category I.

- Measurement category IV is for measurement performed at the source of low-voltage installation.
- Measurement category III is for measurement performed in the building installation.
- Measurement category II is for measurement performed on the circuits directly connected to the low voltage installation.
- Measurement category I is for measurements performed on circuits not directly connected to Mains.

Power Supply



WARNING

- AC Input voltage:
100V/120V/220V±10%, 230VAC +10%/-6%,
50/60Hz
 - Connect the protective grounding conductor of the AC power cord to an earth ground, to avoid electrical shock.
-

Fuse

**WARNING**

- Fuse type:
100V/120V: T6.3A/250V
220V/230V: T3.15A/250V
 - Make sure the correct type of fuse is installed before power up.
 - To ensure fire protection, replace the fuse only with the specified type and rating.
 - Disconnect the power cord before fuse replacement.
 - Make sure the cause of fuse blowout is fixed before fuse replacement.
-

Cleaning the device

- Disconnect the power cord before cleaning.
 - Use a soft cloth dampened in a solution of mild detergent and water. Do not spray any liquid.
 - Do not use chemicals or cleaners containing harsh products such as benzene, toluene, xylene, and acetone.
-

Operation Environment

- Location: Indoor, no direct sunlight, dust free, almost non-conductive pollution (note below)
 - Relative Humidity: < 80%
 - Altitude: < 2000m
 - Temperature: 0°C to 40°C
-

(Pollution Degree) EN 61010-1:2010 specifies the pollution degrees and their requirements as follows. The GPE-1326/2323/3323/4323 series falls under degree 2.

Pollution refers to “addition of foreign matter, solid, liquid, or gaseous (ionized gases), that may produce a reduction of dielectric strength or surface resistivity”.

- Pollution degree 1: No pollution or only dry, non-conductive pollution occurs. The pollution has no influence.
 - Pollution degree 2: Normally only non-conductive pollution occurs. Occasionally, however, a temporary conductivity caused by condensation must be expected.
 - Pollution degree 3: Conductive pollution occurs, or dry, non-conductive pollution occurs which becomes conductive due to condensation which is expected. In such conditions, equipment is normally protected against exposure to direct sunlight, precipitation, and full wind pressure, but neither temperature nor humidity is controlled.
-

Storage environment

- Location: Indoor
 - Relative Humidity: < 70%
 - Temperature: -10°C to 70°C
-

Disposal



Do not dispose this instrument as unsorted municipal waste. Please use a separate collection facility or contact the supplier from which this instrument was purchased. Please make sure discarded electrical waste is properly recycled to reduce environmental impact.

Power cord for the United Kingdom

When using the GPE-1326/2323/3323/4323 series in the United Kingdom, make sure the power cord meets the following safety instructions.

NOTE: This lead/appliance must only be wired by competent persons



WARNING: THIS APPLIANCE MUST BE EARTHED

IMPORTANT: The wires in this lead are coloured in accordance with the following code:

Green/ Yellow:	Earth
Blue:	Neutral
Brown:	Live (Phase)



As the colours of the wires in main leads may not correspond with the colours marking identified in your plug/appliance, proceed as follows:

The wire which is coloured Green & Yellow must be connected to the Earth terminal marked with the letter E or by the earth symbol \oplus or coloured Green or Green & Yellow.

The wire which is coloured Blue must be connected to the terminal which is marked with the letter N or coloured Blue or Black.

The wire which is coloured Brown must be connected to the terminal marked with the letter L or P or coloured Brown or Red.

If in doubt, consult the instructions provided with the equipment or contact the supplier.

This cable/appliance should be protected by a suitably rated and approved HBC mains fuse: refer to the rating information on the equipment and/or user instructions for details. As a guide, cable of 0.75mm² should be protected by a 3A or 5A fuse. Larger conductors would normally require 13A types, depending on the connection method used.

Any moulded mains connector that requires removal /replacement must be destroyed by removal of any fuse & fuse carrier and disposed of immediately, as a plug with bared wires is hazardous if a engaged in live socket. Any re-wiring must be carried out in accordance with the information detailed on this label.

OVERVIEW

This chapter describes the GPE-1326/ 2323/ 3323/ 4323 series in a nutshell, including its main features and front/ rear panel introduction. After going through the overview, follow the Setup chapter (page 25) to properly power up and set operation environment.

Introduction

Overview

The GPE-1326/2323/3323/4323 series regulated DC power supply series are light weight, adjustable, multifunctional work stations. The GPE-1326 has a single independent adjustable voltage output (Coarse and fine). The remote voltage compensation function is activated for large changes in current output. The GPE-2323 has a 2 independent adjustable voltage outputs. The GPE-3323 has three independent outputs: two with adjustable voltage levels and one with fixed level 5V. The GPE-4323 has four independent voltage outputs that are all fully adjustable. The series can be used for logic circuits where various output voltage or current are needed, and for tracking mode definition systems where plus and minus voltages with insignificant error are required.

Independent / Series Tracking / Parallel Tracking	The three output modes of GPE-2323/3323/4323 series, independent, series tracking and parallel tracking can be selected through pressing the TRACKING key on the front panel. In the independent mode, the output voltage and current of each channel are controlled separately. In the tracking modes, both the CH1 and CH2 outputs are automatically connected in series or parallel. CH1 is master and CH2 is slave; no need to connect output leads. In the series mode, the output voltage is doubled; in the parallel mode, the output current is doubled. The isolation degree, from output terminal to chassis or from output terminal to output terminal, is 500V
Constant Voltage/ Constant Current	Each output channel works in constant voltage (CV) or constant current (CC) mode. Even at the maximum output current, a fully rated, continuously adjustable output voltage is provided. For a big load, the power supply can be used as a CV source; while for a small load, a CC source. When in the CV mode (independent or tracking mode), output current (overload or short circuit) can be controlled via the front panel. When in the CC mode (independent mode only), the maximum (ceiling) output voltage can be controlled via the front panel. The power supply will automatically cross over from CV to CC operation when the output current reaches the target value. The power supply will automatically cross over from CC to CV when the output voltage reaches the target value. For more details about CV/CC mode operation, see page 24.

Automatic tracking mode	The front panel display (CH1, CH2) shows the output voltage or current. When operating in the tracking mode, the power supply will automatically connect to the auto-tracking mode. For more details about CH1/CH2 Series Tracking Mode, see page 38
-------------------------	--

Series Lineup / Main Features

Main Features

Performance	<ul style="list-style-type: none">• Low noise: Temperature controlled cooling fan• Compact size, light weight
Operation	<ul style="list-style-type: none">• Constant Voltage / Constant Current operation• Series Tracking / Parallel Tracking operation• Output On/Off control• Multi-output: GPE-1326: 32V/6A x1; GPE-2323: 32V/3A x2; GPE-3323: 32V/3A x2, 5V/5A x 1 GPE-4323: 32V/3A x2, 5V/1A x1, 15V/1A x1• Coarse and fine Voltage/Current control(GPE-1326)• Output voltage compensation control (GPE-1326)• Function for locking the setting voltage (CH1/CH2)• Output voltage/ current setting view• Set the displayed digit resolution for the voltage & current output.
Protection	<ul style="list-style-type: none">• Overload protection• Reverse polarity protection• Inadvertent voltage setting protection
Interface	<ul style="list-style-type: none">• Remote control (Output ON/OFF)

Principle of Operation

- Overview The power supply consists of the following.
- AC input circuit
 - Transformer
 - Bias power supply including rectifier, filter, pre-regulator and reference voltage source
 - Main regulator circuit including the main rectifier and filter, series regulator, current comparator, voltage comparator, reference voltage amplifier, remote device and relay control circuit

The block diagram below shows the CH1 circuit arrangement. The single phase input power is connected to the transformer through the input circuit. Details of each part are described in the next page.

Block diagram

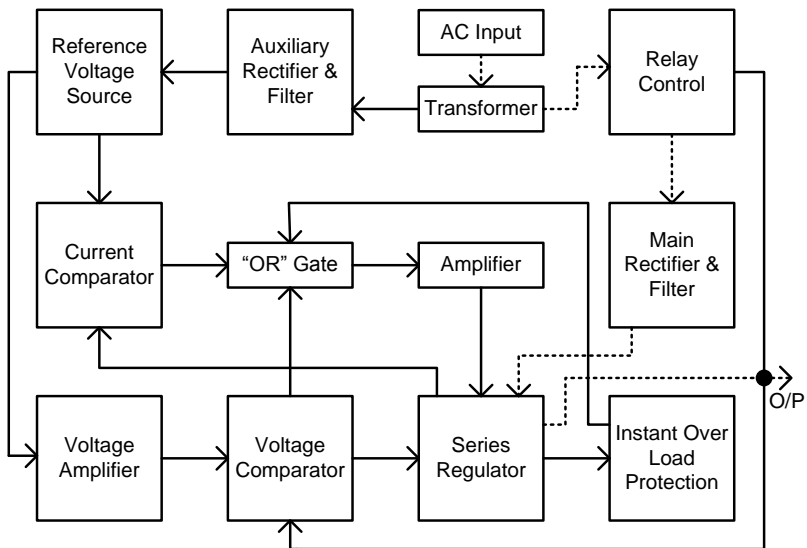

Auxiliary Rectifier	The auxiliary rectifiers D120~ D123 provide bias voltage filtered by the capacitors C120 and C121, for the pre-regulators U150 and U151. They provide a regulated voltage for other modules.
Main Rectifier	The main rectifier is a full wave bridge rectifier. It provides the power after the rectifier is filtered by the capacitor C101, and then regulated via a series-wound regulator, which is finally delivered to the output terminal.
Current Limiter	U151 is a comparator amplifier which compares the reference voltage to the feedback voltage, and then delivers it to Q151, which then calibrates the output voltage.
Overvoltage	U131 is a comparator which activates when the unit is overloaded and it controls the output of U132 to turn off the output and inform the user.

Front Panel Overview

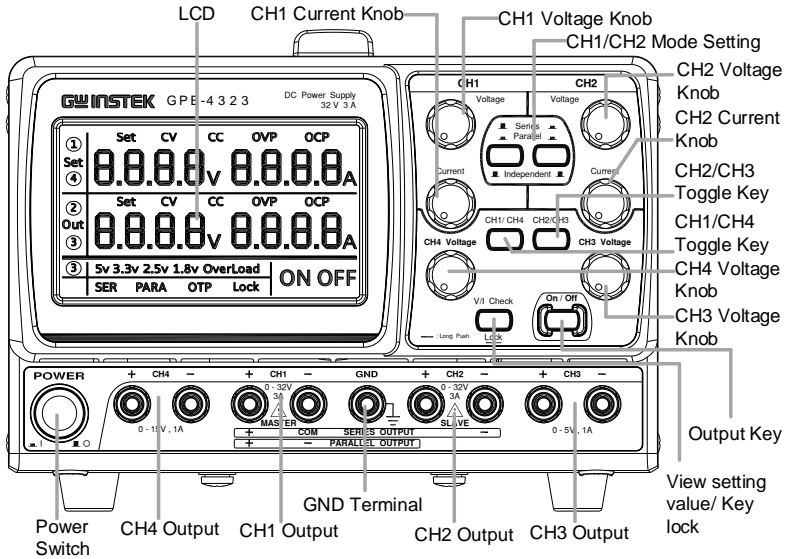

The figure above is the front view of the GPE-4323. For views of other models, please refer to physical device or see the panel overview for the other models on page 22.

Display

CH1/CH4 parameter display area (parameter settings for the GPE-1326)

① Set CV CC OVP OCP
 ④ 0.0.0.0V 0.0.0.0A

CH2/CH3 parameter display area (parameter readings for the GPE-1326)

② Out CV CC OVP OCP
 ③ 0.0.0.0V 0.0.0.0A

CH3 parameter display area for the GPE-3323

③ | 5v OverLoad

Status display area

SER PARA OTP Lock

Output status display

ON OFF

Voltmeter

Displays output voltage of each channel.

GPE-4323: CH1/CH4 and CH2/CH3

GPE-2323/3323: CH1 and CH2

GPE-1326: Voltage setting/readback

3 digits:

0.0.0v

4 digits:

0.0.0.0v

CH3

5v

display:

(GPE-3323)

Ammeter

Displays output current of each channel.

GPE-4323: CH1/CH4 and CH2/CH3

GPE-2323/3323: CH1 and CH2

GPE-1326: Current setting/readback

3 digits:

0.0.0A

4 digits:

0.0.0.0A

CV/CC/OVP indicators for CH1/4	CV	CC	You can view the constant current, constant voltage or OVP status for CH1 or CH4, depending on which CH1 (① icon appears on the leaf-hand side of the LCD display.) or CH4 (④) is selected. Each state is valid only when the output is ON. When output is OFF, the display is turns off.
CV/CC/OVP indicators for CH2/3	CV	CC	You can view the constant current, constant voltage or OVP status for CH2 or CH3, depending on which CH2 (② icon appears on the leaf-hand side of the LCD display.) or CH3 (③) is selected. Each state is valid only when the output is ON. When output is OFF, the display is turns off.
View setting value	Set		When output is ON, you can view the voltage/ current setting value depending on the channel be selected. The GPE-1326 display both reading and setting values simultaneously without pressing this function key. When the output is on, you can view the voltage/current setting depending on which channel is selected. The GPE-1326 displays both the reading and the setting values simultaneously without pressing this function key.
Channel indicator	① ② ③ ④		Indicates the currently selected channel. The GPE-1326 doesn't have such display.

Output status of
CH3 in the GPE-
3323

OverLoad

When the output current is over
range, the overloaded indicator
Overload will be lit on the LCD
display.

Control Panel

CH1/CH2

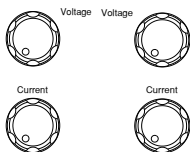

Sets the voltage/current for the GPE-2323/3323/4323.

CH3/CH4

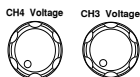

Sets the voltage for the GPE-4323.

Single Channel

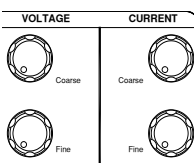

Sets the GPE-1326 voltage and current. It has coarse and fine adjustment features. The fine-tune range is about 1/10th of the present setting value.

CH1/3 and CH2/4

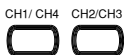

Views the channel settings or readback values for GPE-4323 voltage/current. Press the CH1/3 or CH2/4 key to toggle the view for the corresponding channels in the display.

Parallel/Series Keys

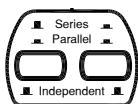

Activates parallel/series tracking operation. For details, see page 38. The corresponding channel will be displayed on the LCD display. The GPE-1326 doesn't have this function.

View setting value/ Key lock



When the output is ON, you can view the voltage/current settings of each channel by pressing this key. The corresponding channel will be displayed on the LCD display. Press and hold the key to lock and unlock the panel keys (except OUTPUT). For more information, please refer to page 29.

Output Key



Turns the output on or off. For more details, see page 27.

Power Switch



Turns On or Off the main power. For the power up sequence, see page 25.

Terminals

GND Terminal

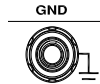

Accepts a grounding wire.

CH1 Output

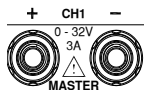

Outputs CH1 voltage and current.

CH2 Output

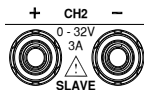

Outputs CH2 voltage and current.

CH3 Output

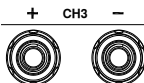

Outputs CH3 voltage and current.

CH4 Output

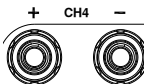

Outputs CH4 voltage and current.

The GPE-1326
Output terminal

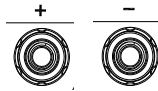

Output voltage and current

The GPE-1326
Sense terminal

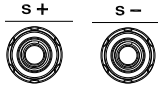

Remote sense terminals

Front views of the other three models:

GPE-1326

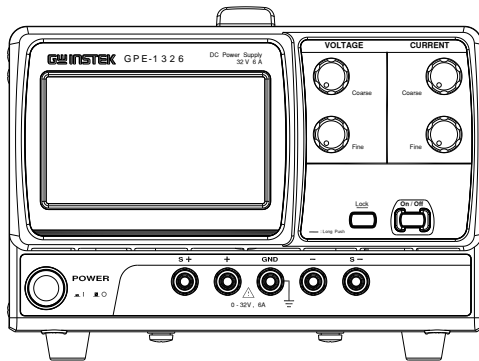

GPE-2323

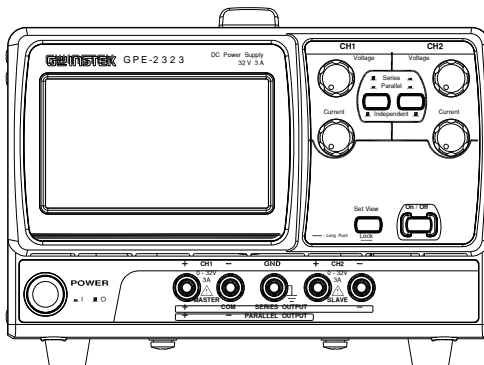

GPE-3323

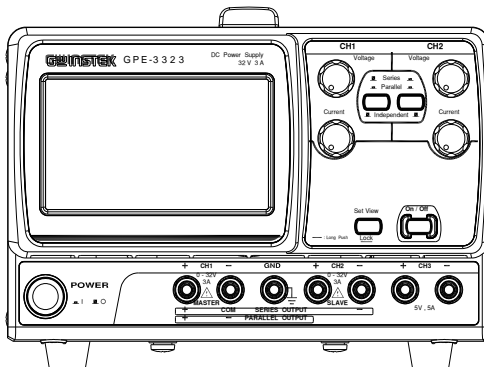

Rear Panel Overview

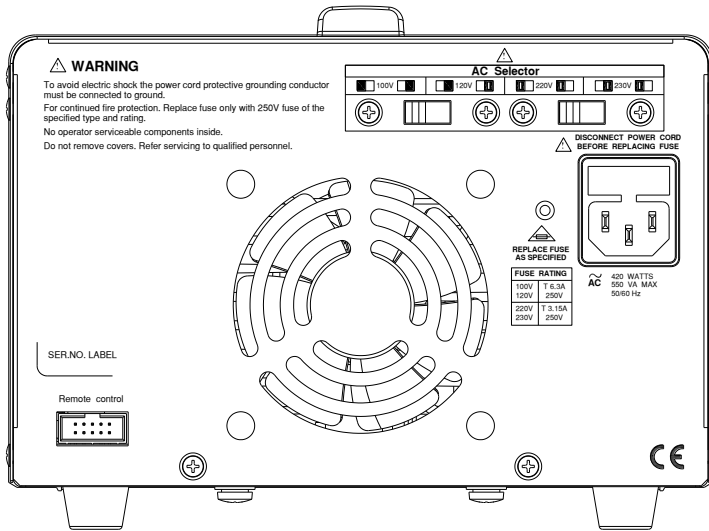

Remote Control Terminal



For more information about the remote control terminal, please see page 30.

Power Cord / Fuse Socket

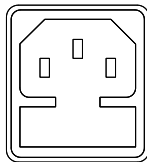

The power cord socket accepts the AC mains. For power up details, see page 25.

The fuse holder contains the AC mains fuse. For fuse replacement details, see page 45.

AC Selector

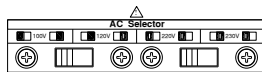

Selects AC input voltage: 100V/ 120V/ 220V/ 230V; 50~60Hz.

CV/CC Crossover Characteristics

Background The GPE-1326/2323/3323/4323 series automatically switch between constant voltage mode (CV) and constant current mode (CC), according to load condition.

CV mode When the current level is smaller than the output setting, the GPE-1326/2323/3323/4323 series operates in Constant Voltage mode. The indicator for the corresponding channel appears on the LCD. The Voltage level is kept at the setting and the Current level fluctuates according to the load condition until it reaches the output current setting.

CC mode When the current level reaches the output setting, the GPE-1326/2323/3323/4323 series starts operating in Constant Current mode. The indicator for the corresponding channel appears on the LCD. The Current level is kept at the setting but the Voltage level becomes lower than the setting, in order to suppress the output power level from overload. When the current level becomes lower than the setting, the GPE-1326/2323/3323/4323 series goes back to the Constant Voltage mode.

Diagram

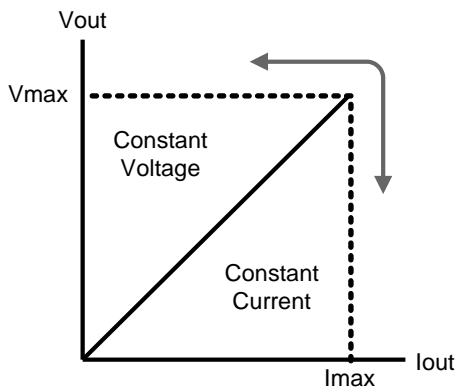

SETUP

This chapter describes how to properly power up and configure the GPE-1326/2323/3323/4323 series before operation.

Power Up

Select AC voltage Before powering up the power supply, select the AC input voltage from the rear panel.

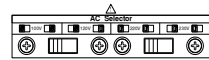

Connect AC power cord Connect the AC power cord to the rear panel socket.

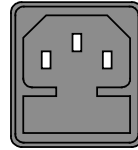

Power On Press the power switch to turn on the power. The display will first display all the LCD segments before showing settings for each channel.



Power switch Press the power switch again to turn off the power.



Load Cable Connection

Standard accessories (GTL-104A, GTL-105A)

1. Turn the terminal counterclockwise and loosen the screw.
2. Insert the cable terminal.
3. Turn the terminal clockwise and tighten the screw.

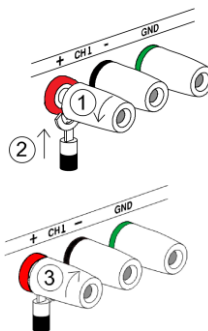

Banana plug

Insert the plug into the socket.

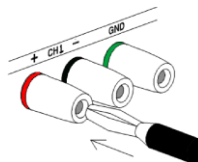

Wire type

When using load cables other than the attached, make sure they have enough current capacity for minimizing cable loss and load line impedance. Voltage drop across a wire should not exceed 0.5V. The following list is the wire current rating at 450A/cm².

Wire size (AWG)	Maximum current (A)
20	2.5
18	4
16	6
14	10
12	16

Output On/Off

Panel operation Press the Output key to turn on all outputs in each channel.

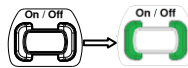

Push the Output key again to turn off all outputs. The **OFF** icon will become lit on the LCD display.

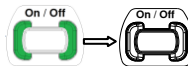

Automatic output off Any of the following actions during output on automatically turns it off.

- Change the operation mode between independent / series tracking / parallel tracking
- When OVP is activated on a channel (except CH3 on the GPE-3323)
- When the lock function is disabled.
- When toggling to remote control

Select CH1/CH2 series or parallel mode

Background / Connection

When you need to output a higher voltage or current through the GPE-2323/3323/4323 series can be connected in series or parallel to achieve it. When connecting in series, the output voltage is twice than that of a single channel. When connecting in parallel, the output current is twice than that of a single channel. For details, please see page 38 through to 42.





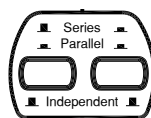

Panel operation

You can toggle the connection mode of CH1/ CH2 by using different combinations of the mode selection key.



- For the independent mode, the right key is not pressed

■ Independent ■

- Toggle to parallel mode when both keys are pressed.  Parallel 
- Right key is pressed and the left key is not pressed in series mode.  Series 
- When CH1 / CH2 is in the series or parallel mode, the corresponding series or parallel icon appears on the LCD display.  

Switch between Channels

Background / Connection This feature is only available for the GPE-4323. The voltage and current settings and readback values for 2 channels can be displayed on the LCD display simultaneously. To check and view the relevant information for the other channels, you need to switch channels. Please follow the steps listed below to switch between channels.

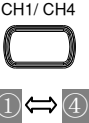
Panel operation Press the CH1/4 key to toggle between CH1 and CH4. The activated channel will be shown on the channel indicator. 

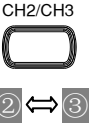
Press the CH2/3 key to toggle between CH2 and CH3. The activated channel will be shown on the channel indicator. 

Setting Voltage Lock from Front Panel

Background / Connection The lock function of the GPE-1326/ 2323/ 3323/ 4323 series can be used when you need to keep the output voltage constant to avoid the load from being damaged due to inadvertent operation. The voltage lock takes the present channel settings as the reference levels. The voltage lock function only applies to CH1 & CH2.

Panel operation Press the LOCK key (for more than 2 seconds) to lock the voltage knob operation for CH1 & CH2 in the front panel. The **Lock** icon will become lit.



To unlock, press the LOCK key for more than 2 seconds. The **Lock** icon will then turn off and the output turns off as well.



- The OUTPUT key is not affected by the lock operation.
- It is normal for the output voltage to have a fluctuation of around 20mV after the voltage settings are locked.



Set the output state at startup

Background / Connection Through the following steps, you can set the output state of the GPE-1326/2323/3323/4323 series at its next startup. There are two choices, ON and OFF available for selection.

Panel operation

1. Press and hold the Output key and turn on the power until the **On** or **OFF** icon flashes on the LCD display.



2. Press the "Set View" key to select.



3. Press the "ON/OFF" key to confirm.



Note

By default the output is set to OFF at startup.

Set the displayed digit resolution for the voltage/current

Background / Connection

The GPE-1326/2323/3323/4323 series can set the displayed digit resolution for the voltage and current settings/readings to 3 or 4 digits at startup.

Panel operation

1. Press and hold the "Set View" key and turn the power until on the decimal point for the CH1 voltage flashes on the LCD display.

Set View



2. Press the "Set View" key to select the number of displayed digits.

Set View



3. Press the "ON/OFF" key to confirm the selection.



Note

By default the number of displayed digits is set to four.

Remote Control Setting

Background /
Connection

Through the "Remote Control" terminal, the GPE-1326/2323/3323/4323 series can turn the power on or off.

Remote control

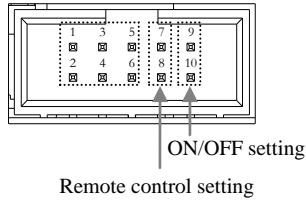

Panel operation

1. Short pins 7 and 8 (remote control setting). This will put the power state (ON/OFF) under remote control. At this moment, the **On** / **OFF** icon flashes on the LCD display.



2. Output control :

- Pin 9 & 10 Open: ON state.
- Pin 9 & 10 Short: OFF state.



 Warring

The remote control terminal can only be controlled by shorting (external relay or jumper shunt) /opening the pins. Voltage cannot be applied to the pins. It is strictly prohibited to short pins 5 & 7 or 6 & 8. Pin 1~6 must be set to open.

OPERATION

CH1/CH2 Independent Mode

Background / Connection

CH1 and CH2 outputs work independent of each other.

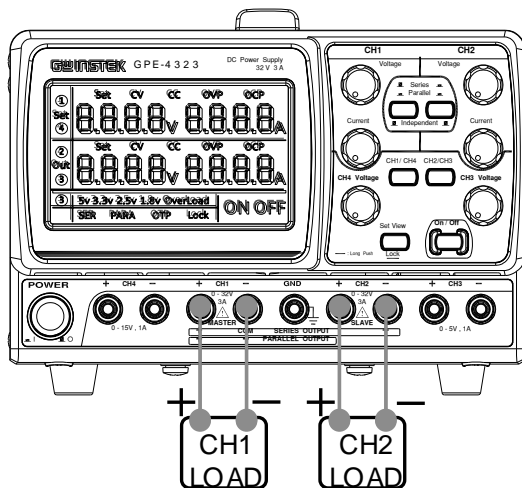

Output rating 0 ~ 32V/0~3A for each channel

Panel operation

1. Make sure the Series/Parallel key is not activated (both the **SER** and **PARA** icons are off). ■ Independent ■

2. Connect the load to the front panel terminals, CH1 +/-, CH2 +/-.

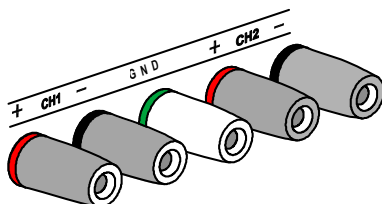

3. Use the voltage and current knob to set the CH1 output voltage and current.

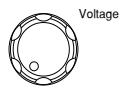

4. Use the voltage and current knob to set the CH2 output voltage and current.

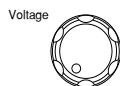

5. Press the Output key to turn on the output. The Output key will be lit and the **ON** icon will appear on the LCD display. The **CV** or **CC** icon appears on the LCD to indicate the output status for each channel.

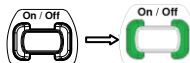

CH3 Independent Mode

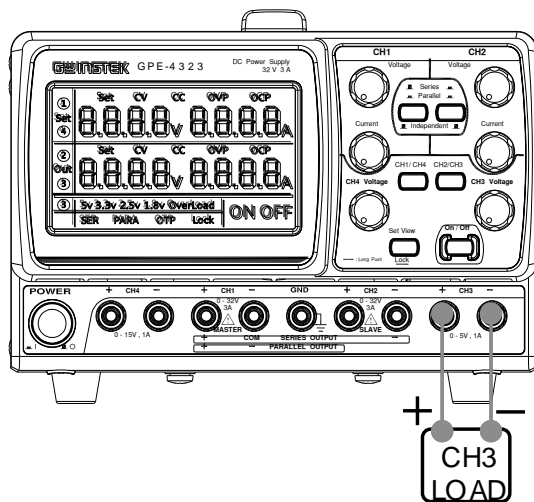

Output rating GPE-3323 : 5V, 5A Max
 GPE-4323 : 0~5V,1A Max.

No Series/Parallel Tracking CH3 doesn't have series/parallel tracking mode. Also, the CH3 output is not affected by the CH1 and CH2 modes.

Panel operation 1. Connect the load to the front panel CH3 +/- terminal.

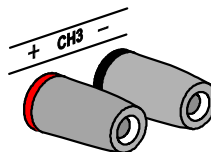

2. Select the output voltage
 For GPE-3323: 5V.

For GPE-4323:
 Use the voltage and current knobs to set the voltage and current.

CH3 Voltage



You can check the setting of the GPE-4323 by using the CH2/CH3 key to toggle to CH3 (③ appears on the LCD display).



3. Press the Output key to turn on the output. The Output key will be lit.

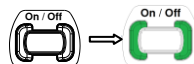

OVERLOAD

GPE-3323: When the output current level exceeds 5.2A, the overload icon appears on the LCD display and CH3 operation mode switches from constant voltage to constant current.



CV → CC

GPE-4323: When the output current level exceeds the setting value, the CV icon changes to the CC icon on the LCD display. This indicates that CH3 has switched from constant voltage to constant current.

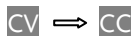

CH4 Independent Mode

Background / Connection The mode is used only for the GPE-4323

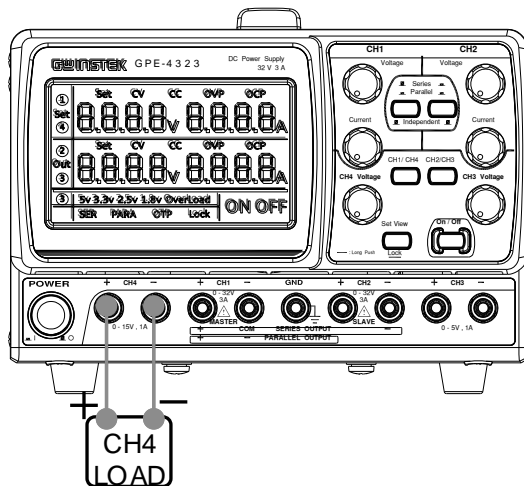

Output rating 0~15V/1A max

No Series/Parallel Tracking CH4 doesn't have series/parallel tracking mode. The CH4 output is not affected by the CH1 and CH2 modes.

Panel operation 1. Connect the load to the front panel CH4 +/- terminal.

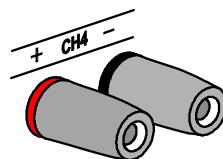

2. Use the voltage knobs to set the voltage and current.



You can use the CH1/CH4 key to toggle to CH4 (4) appears on the LCD display) to check the setting value.



3. Press the Output key to turn on the output. The Output key will be lit.

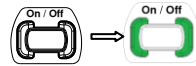

CV → CC

When the output current level exceeds the setting value, the CV icon changes to the CC icon on the LCD display. This indicates that CH4 has switched from constant voltage to constant current.

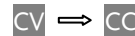

CH1/CH2 Series Tracking Mode

Background Series tracking operation allows the GPE-2323/3323/4323 to combine the output by internally connecting CH1 (Master) and CH2 (Slave) in series. CH1 (Master) controls the combined output voltage/current level which is set independently.

The following describes two types of configurations, depending on how common ground is used.

Series Tracking without Common Terminal

Connection

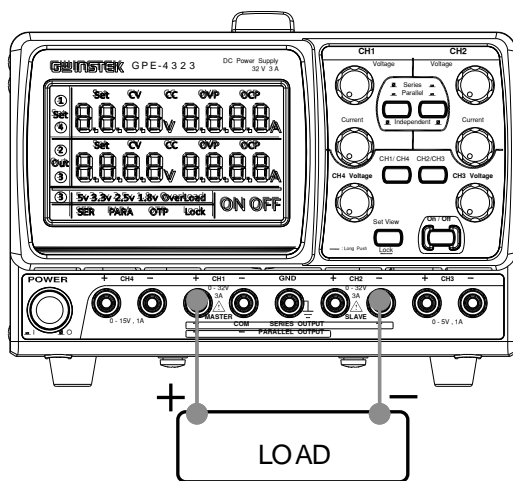

Output rating 0 ~ 64V/0 ~ 3A

1. Press the Series/Parallel key to activate the series tracking mode. The **SER** icon will be lit on the LCD display.

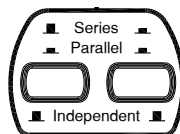

2. Connect the load to the front panel terminals, CH1+ & CH2- (Single supply).

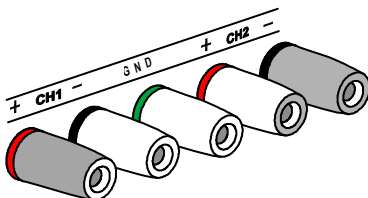

3. Use the current knob to set the CH2 output current to the maximum level.



4. Use the voltage and current knob to set the CH1 output voltage and current level.

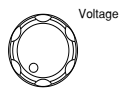

5. Press the Output key to turn on the output. The Output key will be lit.

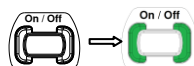

6. Refer to the CH1 (Master) meter and indicators for the output level and CV/CC status.

Output voltage level Double the reading on the CH1 voltage meter.

Output current level CH1 meter reading shows the output current.

Series Tracking with Common Terminal

Connection

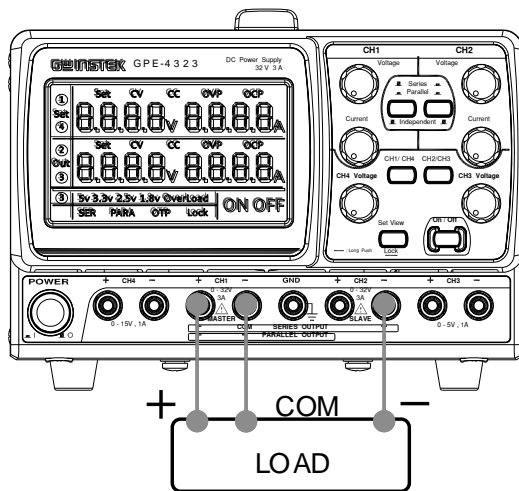

Output rating 0~32V/0~3A for CH1 ~ COM



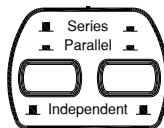

0~32V/0~3A for CH2 ~ COM

1. Press the Series/Parallel key to activate the series tracking mode. The **SER** icon will be lit on the LCD display.

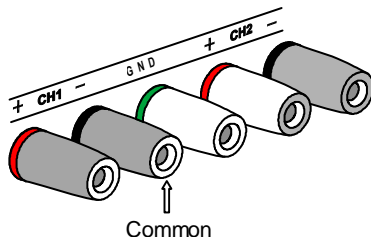

2. Connect the load to the front panel terminals, CH1+ & CH2-. Use the CH1 (-) terminal as the common line connection.



3. Use the CH1 voltage knob to set the master & slave output voltage (the same level for both channels). 
4. Use the CH1 current knob to set the master output current. 
5. Use the CH2 current knob to set the slave output current. 
6. Press the Output key to turn on the output. The Output key will be lit. 
7. Refer to the CH1 (Master) meter and indicators for the output level and CV/CC status.

CH1 (Master) voltage level	CH1 meter reading shows the output voltage.
CH1 (Master) current level	CH1 meter reading shows the output current.
8. Refer to the CH1/CH2 meter and CH2 indicators for the output level and CV/CC status.

CH2 (Slave) voltage level	The CH2 meter reading shows the output voltage.
CH2 (Slave) current level	The CH2 meter reading shows the output current.

CH1/CH2 Parallel Tracking Mode

Background / Connection

Parallel tracking operation allows the GPE-2323/3323/4323 to combine the output by internally connecting CH1 (Master) and CH2 (Slave) in parallel. CH1 (Master) controls the combined output voltage/current level.

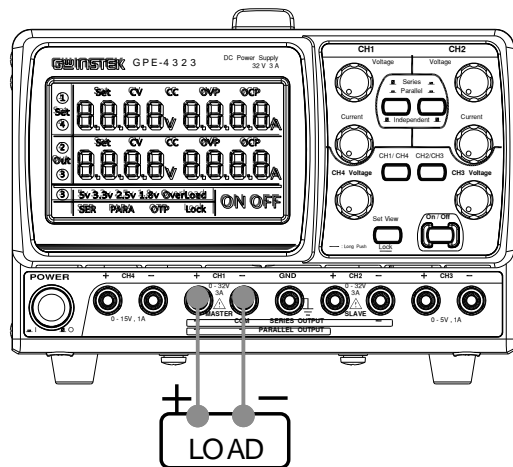

Output rating 0 ~ 32V/0 ~ 6A

1. Press the Series/Parallel key to activate the parallel tracking mode. The **PARA** icon will be lit on the LCD display.

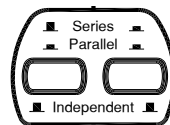

2. Connect the load to the CH1 +/- terminals.

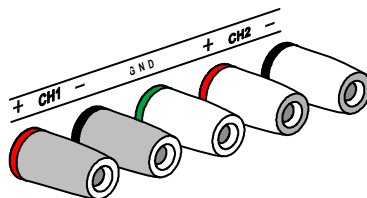

3. Use the CH1 voltage and current knobs to set the output voltage and current. CH2 control function is disabled.

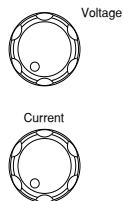

4. Press the Output key to turn on the output. The Output key will be lit.

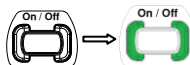

5. The operating mode of CH2 will appear as the **CC** icon on the LCD display.

6. Refer to the CH1 meter and indicator for the output level and CV/CC status.

Output voltage level The CH1 meter reading shows the output voltage.

Output current level Double the amount of CH1 current meter reading.

FAQ

Q1. I pressed the panel lock key but the output still turns on/off.

A1. For safety reasons the output key is not affected by the panel key lock feature.

Q2. The CH3 overload indicator turned on – is this an error?

A2. No, it simply means that the CH3 output current reached the maximum 5.2A and the operation mode turned from CV (constant voltage) to CC (constant current). You can continue using the power supply, although reducing the output load is recommended.

Q3. The specifications do not match the real accuracies.

A3. Make sure that the power supply is powered on for at least 30 minutes, within +20°C ~ +30°C.

For more information, contact your local dealer or GWInstek at www.gwinstek.com.tw / marketing@goodwill.com.tw.

A PPENDIX

Fuse Replacement

Steps

1. Take off the power cord and remove the fuse socket using a minus driver.

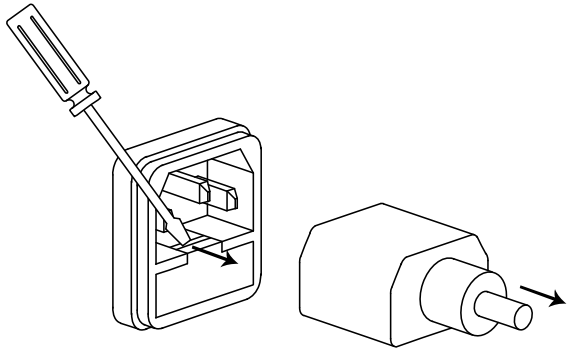

2. Replace the fuse in the holder.

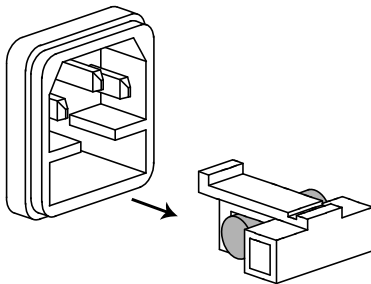

Rating

- 100V/120V:T6.3A/250V
- 220V/230V:T3.15A/250V

Specifications

The specifications apply when the GPE-1326/2323/3323/4323 series are powered on for at least 30 minutes under +20°C - +30°C.

Output Ratings	CH1/CH2	0 ~ 32V / 0 ~ 3A
	Independent	0 ~ 32V / 0 ~ 6A(GPE-1326)
	CH1/CH2	0 ~ 64V / 0 ~ 3A
	Series	
	CH1/CH2	0 ~ 32V / 0 ~ 6A
	Parallel	
Voltage Regulation	CH3	5V, 5A(GPE-3323) 0~5V, 1A(GPE-4323)
	CH4	0~15V,1A
	Line	≤ 0.01% + 3mV
	Load	≤ 0.01% + 3mV (rating current ≤ 3A) ≤ 0.02% + 5mV (rating current > 3A)
	Ripple & Noise	≤ 1mVrms (5Hz ~ 1MHz)
	Recovery Time	≤ 100μs (50% load change, minimum load 0.5A)
Current Regulation	Temperature Coefficient	≤ 300ppm/°C
	Line	≤ 0.2% + 3mA
	Load	≤ 0.2% + 3mA
Tracking Operation	Ripple & Noise	≤ 3mArms
	Tracking Error	≤ 0.1% + 10mV of Master (0~32V) (No Load, with load add load regulation≤100mV))
	Parallel Regulation	Line: ≤ 0.01% + 3mV Load: ≤ 0.01% + 3mV (rating current ≤ 3A) Load: ≤ 0.02% + 5mV (rating current > 3A)
	Series Regulation	Line: ≤ 0.01% + 5mV Load: ≤ 100mV
Meter Resolution	Voltage	10mV or 100mV
	current	1mA or 10mA 2mA or 10mA (GPE-1326)

Display	LCD	4.3" single color LCD display
	Ammeter	3.200A full scale, 4 digits or 3 digits 6.200A full scale, 4 digits or 3 digits (GPE-1326)
	Voltmeter	33.00V full scale, 4 digits or 3 digits
Accuracy	Setting/	Voltage: \pm (0.1% of reading + 30mV) (4digits)
	Read back	\pm (0.1% of reading + 200mV) (3digits)
	Accuracy	Current: \pm (0.3% of reading + 6mA) (4digits)
		\pm (0.3% of reading + 20mA) (3digits)
CH3 on the GDE-3323	Output Voltage	5V, \pm 5%
	Output Current	5A
	Line	\leq 3mV
	Load	\leq 10mV
	Ripple & Noise	\leq 2mVrms (5Hz ~ 1MHz)
Insulation	Chassis and Terminal	20M Ω or above (DC 500V)
	Chassis and AC cord	30M Ω or above (DC 500V)
Operation Environment	Indoor use, Altitude: \leq 2000m Ambient temperature: 0 ~ 40°C Relative humidity: \leq 80% Installation category: II Pollution degree: 2	
Storage Environment	Ambient temperature: -10 ~ 70°C Relative humidity: \leq 70%	
Power Source	AC 100V/120V/220V \pm 10%, 230V+10%/-6%, 50/60Hz	
Accessories	User manual	x1
	Test lead: Non-European	GPE-1326: GTL-104A x1 ,GTL-105A x1 GPE-2323: GTL-104A x2 GPE-3323: GTL-104A x3 GPE-4323: GTL-104A x2 ,GTL-105A x2
	Test lead: European	GPE-1326: GTL-204A x 1 , GTL-203A x 1 GPE-2323: GTL-204A x 2 GPE-3323: GTL-204A x 3 GPE-4323: GTL-204A x 2 , GTL-203A x 2
	Dimensions	210 (W) x 155 (H) x 306 (D) mm
	Weight	Approx. 8.7kg
	Specifications listed above are specifications under the "Unlock" state.	

Declaration of Conformity

We

GOOD WILL INSTRUMENT CO., LTD.

No.7-1, Jhongsing Road., Tucheng Dist., New Taipei City 236, Taiwan.

GOOD WILL INSTRUMENT (SUZHOU) CO., LTD.

No. 69 Lushan Road, Suzhou New District Jiangu, China.

declare that the below mentioned product

Type of Product: **DC Power Supply**

Model Number: GPE-1326 / GPE-2323 / GPE-3323 / GPE-4323

are herewith confirmed to comply with the requirements set out in the Council Directive on the Approximation of the Law of Member States relating to Electromagnetic Compatibility (2004/108/EC and 2014/30/EU) and Low Voltage Directive (2006/95/EC and 2014/35/EU).

For the evaluation regarding the Electromagnetic Compatibility and Low Voltage Directive, the following standards were applied:

© EMC	
EN 61326-1: EN 61326-2-1:	Electrical equipment for measurement, control and laboratory use -- EMC requirements (2013)
Conducted & Radiated Emission EN 55011: 2009+A1:2010	Electrostatic Discharge EN 61000-4-2: 2009
Current Harmonics EN 61000-3-2: 2014	Radiated Immunity EN 61000-4-3: 2006+A1:2008+A2:2010
Voltage Fluctuations EN 61000-3-3: 2013	Electrical Fast Transients EN 61000-4-4: 2012
-----	Surge Immunity EN 61000-4-5: 2006
-----	Conducted Susceptibility EN 61000-4-6: 2014
-----	Power Frequency Magnetic Field EN 61000-4-8: 2010
-----	Voltage Dip/ Interruption EN 61000-4-11: 2004

Low Voltage Equipment Directive 2006/95/EC and 2014/35/EU	
Safety Requirements	EN 61010-1: 2010

INDEX

Automatic out off	27	Block diagram	13
Banana plug	26	List of features	12
Caution symbol.....	5	Operation theory.....	13
CC/CV	35	Technology overview	10
CC/CV indicator	37	Ground symbol	5
Cleaning the instrument.....	7	Load connection.....	26
Common terminal, series		Operation mode	
tracking	38	Independent	32
Cooling fan.....	23	Parallel Tracking.....	42
safety instruction	6	Series Tracking	38
CV/CC		Specifications.....	46
CH1/CH2 indicator	33	Output current setting	
CH3 indicator.....	35	Manual	33
CH4 indicator.....	37	Output on/off	
Operation theory	11, 24	FAQ.....	44
Declaration of conformity ...	48	manual.....	27
Disposal instructions	8	Output voltage setting	
EN61010		Manual	33
Measurement category	6	Over load indicator.....	35
Pollution degree	8	Power supply	
Environment		Safety instruction	6
Operation.....	7	Setup.....	25
Specification	47	Socket overview	23
Storage	8	Specification.....	47
Front panel		Protective ground symbol	5
Lock (manual).....	29	remote output control	
Overview	16	terminal overview.....	23
Fuse		Service operation	
Rating.....	45	About disassembly	6
Replacement.....	45	Contact	44
Safety instruction.....	7	tracking mode	
GPE series		parallel.....	29, 30, 31

Tracking mode	Warning symbol	5
Operation theory	Wire, load.....	26
UK power cord		9