

# PW6001

# HIOKI

PW6001-01    PW6001-11  
PW6001-02    PW6001-12  
PW6001-03    PW6001-13  
PW6001-04    PW6001-14  
PW6001-05    PW6001-15  
PW6001-06    PW6001-16

Instruction Manual

# POWER ANALYZER



**!** Be sure to read this manual before using the instrument.

▶ p.11

**✓** When using the instrument for the first time

Part Names and Functions ▶ p.21

Preparing for Measurement ▶ p.35

Viewing Measured Values ▶ p.51

**📖** Troubleshooting

Maintenance and Service ▶ p.253

Troubleshooting ▶ p.257

Error Displays ▶ p.259

# EN

Apr. 2021 Revised edition 8  
PW6001A961-08 21-04H





# Contents

Measurement Process .....	1
System Architecture.....	2
Example Measurement Setups.....	3
Introduction.....	5
Verifying Package Contents .....	7
■ Options .....	8
Safety Information .....	11
Operating Precautions .....	13

## 1 Overview 19

1.1 Product Overview.....	19
1.2 Features .....	19
1.3 Part Names and Functions.....	21
1.4 Basic Operation (Screen Display and Layout).....	27
■ Screen Operation.....	27
■ Common Screen Display .....	30
■ Measurement Screen Display.....	31
■ Screen Layouts.....	32

## 2 Preparing for Measurement 35

2.1 After Purchase.....	35
■ Wrapping voltage cords in spiral tubes.....	35
2.2 Inspecting the Instrument before Use.....	36
2.3 Connecting the Power Cord.....	37
2.4 Connecting the Voltage Cords.....	37
2.5 Connecting the Current Sensors..	38
■ Connecting a current sensor to the Probe1 terminal .....	39
■ Connecting a current sensor to the Probe2 terminal .....	40
■ If the measurement range exceeds (using a VT and CT) .....	41
2.6 Turning the Instrument On/Off.....	42
2.7 Setting the Connection Mode and Current Sensors.....	43
2.8 Connecting the Instrument to the Measurement Lines (Zero-adjustment).....	45
■ Zero-adjustment and degaussing (DMAG).....	45
■ Connecting the voltage cords to the measurement lines .....	46
■ Connecting the current sensor to the measurement lines .....	46
■ Using the quick configuration function.....	47
2.9 Verifying Proper Connections (Connection Check) .....	49

## 3 Viewing Measured Values 51

3.1 Displaying Measured Values.....	51
■ Selecting display parameters.....	51
3.2 Viewing Power Measured Values and Changing Measurement Conditions .....	54
■ Displaying power measured values .....	54
■ Displaying voltage and current .....	55
■ Setting the ranges.....	55
■ Configuring zero-suppression.....	58
■ Setting the data update rate .....	59
■ Setting the synchronization source.....	60
■ Setting the low-pass filter (LPF).....	61
■ Configuring frequency measurement.....	62
■ Setting the frequency source .....	62
■ Setting the measurement upper limit frequency and the lower limit frequency .....	63
■ Setting the rectifier.....	64
■ Configuring scaling (when using a VT [PT] or CT) .....	64
3.3 Viewing Integration Values.....	65
■ Displaying integration values .....	65
■ Setting the integration mode.....	68
■ Using manual integration .....	69
■ Performing integration while using the time control function.....	70
3.4 Viewing Harmonic Measured Values.....	71
■ Displaying harmonics.....	71
■ Setting the harmonic measurement mode..	74
■ Setting the THD calculation method .....	75
■ THD calculation order .....	75
■ Setting the grouping method.....	76
3.5 Viewing Measured Values for Power Factor and Loss.....	77
■ Displaying efficiency and loss.....	77
■ Setting the calculation formulas for efficiency and loss .....	78
■ Example measurements .....	79
3.6 Viewing Motor Measured Values (Motor Analysis and D/A-equipped Models) .....	82
■ Displaying motor measured values.....	82
■ Performing zero-adjustment of motor input .....	83
■ Setting motor input.....	84
■ Measuring a motor's electrical angle .....	91
■ Detecting the motor's direction of rotation ..	93

<b>4</b>	<b>Viewing Waveforms</b>	<b>95</b>
4.1	Displaying Waveforms	95
■	Displaying waveforms on the WAVE screen	95
■	Displaying waveforms and measured values on the WAVE+VALUE screen	96
■	Initializing the display position	96
4.2	Changing the Waveform Display and Configuring Recording	98
■	Vertical axis zoom factor and display position settings	98
■	Time axis setting	99
■	Detailed display settings	101
■	Vertical axis scale display	101
■	Trigger settings	102
4.3	Recording Waveforms	104
■	Recording a waveform continuously	104
■	Recording a waveform once	104
■	Activating the trigger manually	104
4.4	Analyzing Displayed Waveforms	105
■	Viewing displayed waveform values (Cursor measurement)	105
■	Enlarging waveforms (zoom function)	106
4.5	Viewing FFT Analysis Results	107
■	Displaying waveforms and FFT analysis results	107
■	Changing the window size and position	108
■	Displaying FFT analysis results as values	110
■	Turning the display of FFT analysis results on and off	110
■	Setting the lower limit frequency for the FFT peak value display	111
■	Setting the window function	112
■	Changing the scale of the vertical axis on the FFT analysis results display	113
<b>5</b>	<b>Using the Instrument's Functionality</b>	<b>115</b>
5.1	Time Control Function	115
■	Interval time control	115
■	Timer time control	115
■	Actual time control	115
5.2	Averaging Function	117
■	Simple average (ADD)	117
■	Exponential average (EXP)	117
5.3	Hold and Peak Hold Functions	119
■	Hold function	119
■	Peak hold function	121
5.4	Delta Conversion Function	124
■	$\Delta$ -Y conversion	124
■	Y- $\Delta$ conversion	125
5.5	Selecting the Power Calculation Formula	126
5.6	Current Sensor Phase Shift Function	127
5.7	User-defined Calculations (UDF)	129
5.8	Simple Graph Function	131
■	D/A monitor graph	131
■	Detailed display settings	132
■	Vertical axis scale display	132
■	X-Y plot function	133
■	Vertical axis/horizontal axis scale settings, integration full-scale setting	135
<b>6</b>	<b>Changing System Settings</b>	<b>137</b>
■	Checking and changing settings	137
■	Correcting the touch panel	138
6.1	Initializing the Instrument	138
■	System reset	138
■	Boot key reset	138
6.2	Default Settings	139
<b>7</b>	<b>Saving Data and Manipulating Files</b>	<b>141</b>
7.1	Inserting and Removing USB Flash Drives	141
7.2	File Operations Screen	143
7.3	Saving Measurement Data	144
■	Setting which measurement parameters to save	144
■	Manually saving measurement data	146
■	Automatically saving measurement data	147
■	Automatic save operation using time control	149
7.4	Saving Waveform Data	150
7.5	Saving FFT Data	152
7.6	Saving Screenshots	154
7.7	Saving Settings Data	155
7.8	Loading Screenshots	156
7.9	Loading Settings Data	156
7.10	File and Folder Operations	157
■	Creating a folder	157
■	Deleting files and folders	157
■	Changing the name of a file or folder	158
■	Copying files	158
■	Formatting a USB flash drive	158
7.11	Measured Value Data Format	159
■	Header structure	159
■	Status data	162
■	Measured value data format	164
7.12	Waveform Binary Data Format	165

■ Data format .....	165		
<b>8 Connecting External Devices</b>	<b>171</b>		
8.1 Synchronization Interface (Two-instrument Synchronized Measurement)	171		
■ Connecting 2 instruments with the L6000 Optical Connection Cable .....	172		
8.2 Using D/A Output (Motor Analysis and D/A-equipped Models Only) (Analog and Waveform Output)	175		
■ Connecting an application-specific device to the instrument.....	175		
■ Selecting output parameters.....	177		
■ Output rates.....	180		
■ Examples of D/A output .....	182		
8.3 Using Motor Analysis (Motor Analysis and D/A-equipped Models Only)	184		
■ Connecting a torque meter and tachometer.....	184		
8.4 Controlling Integration with External Signals .....	187		
8.5 Connecting an LR8410 Link-compatible Logger .....	190		
<b>9 Connecting the Instrument to a Computer</b>	<b>191</b>		
9.1 Using the LAN Interface .....	192		
■ Configuring LAN settings and building a network environment .....	192		
■ Connecting the LAN cable .....	194		
■ Controlling the instrument remotely with an Internet browser.....	195		
9.2 Performing Instrument File Operations from a Computer (Using FTP)	197		
■ Using FTP to connect to the instrument ...	198		
■ Performing file operations with FTP.....	199		
9.3 Using GP-IB .....	200		
■ Connecting the GP-IB cable .....	201		
■ Setting the GP-IB address .....	201		
9.4 Using RS-232C .....	202		
■ Configuring the D-sub 9-pin connector .....	203		
■ Connecting the RS-232C cable .....	204		
9.5 Canceling the Remote State (Reverting to the Local State) .....	205		
<b>10 Specifications</b>	<b>207</b>		
10.1 General Specifications .....	207		
10.2 Basic Specifications .....	208		
10.3 Functional Specifications.....	223		
10.4 Measurement Parameter Detailed Specifications.....	233		
10.5 Calculation Formula Specifications.....	241		
<b>11 Maintenance and Service</b>	<b>253</b>		
11.1 Repairs, Inspections, and Cleaning .....	253		
11.2 Disposing of the Instrument .....	255		
■ Removing the lithium battery .....	255		
11.3 Replacement Parts and Their Service Lives .....	256		
■ Replacing the fuse.....	256		
<b>12 Troubleshooting</b>	<b>257</b>		
12.1 Frequently Asked Questions.....	257		
12.2 Error Displays.....	259		
■ Startup errors and operating errors .....	259		
■ Control errors.....	259		
■ USB flash drive and file operation errors .....	261		
<b>Appendix</b>	<b>Appx.1</b>		
Appx. 1 Rack-mounting the Instrument .....	Appx.1		
■ Rack-mounting hardware.....	Appx.1		
■ Installation instructions .....	Appx.4		
Appx. 2 Outline Drawings .....	Appx.6		
<b>Index</b>	<b>Ind.1</b>		



# Measurement Process

Be sure to read “Operating Precautions” (p. 13) before use.

## Setting up the instrument

- “Instrument placement” (p. 14)
  - “2.1 After Purchase” (p. 35)
  - “2.2 Inspecting the Instrument before Use” (p. 36)
  - Be sure to inspect the instrument before connecting it or turning it on.
  - “2.3 Connecting the Power Cord” (p. 37)
  - “2.6 Turning the Instrument On/Off” (p. 42)
- To ensure accurate measurement, allow a warm-up period of at least 30 minutes to elapse after turning on the instrument before performing zero-adjustment.

## Connecting the instrument

- “2.7 Setting the Connection Mode and Current Sensors” (p. 43)
- Be sure to perform zero-adjustment before connecting the instrument.
- “2.8 Connecting the Instrument to the Measurement Lines (Zero-adjustment)” (p. 45)
- “2.9 Verifying Proper Connections (Connection Check)” (p. 49)

## Setting the measurement conditions

- “3 Viewing Measured Values”(p. 51)
- “4 Viewing Waveforms”(p. 95)

## Viewing measured values

- “3 Viewing Measured Values”(p. 51)
- “4 Viewing Waveforms”(p. 95)

## Saving data

- “Manually saving measurement data” (p. 146)
- Saving data with actual time control (p. 149)
- Saving data with timer control (p. 149)
- Saving data with interval control (p. 149)
- USB flash drive and the instrument’s internal memory (p. 141)

## Analyzing data

- “8 Connecting External Devices”(p. 171)
- “9 Connecting the Instrument to a Computer”(p. 191)

# System Architecture

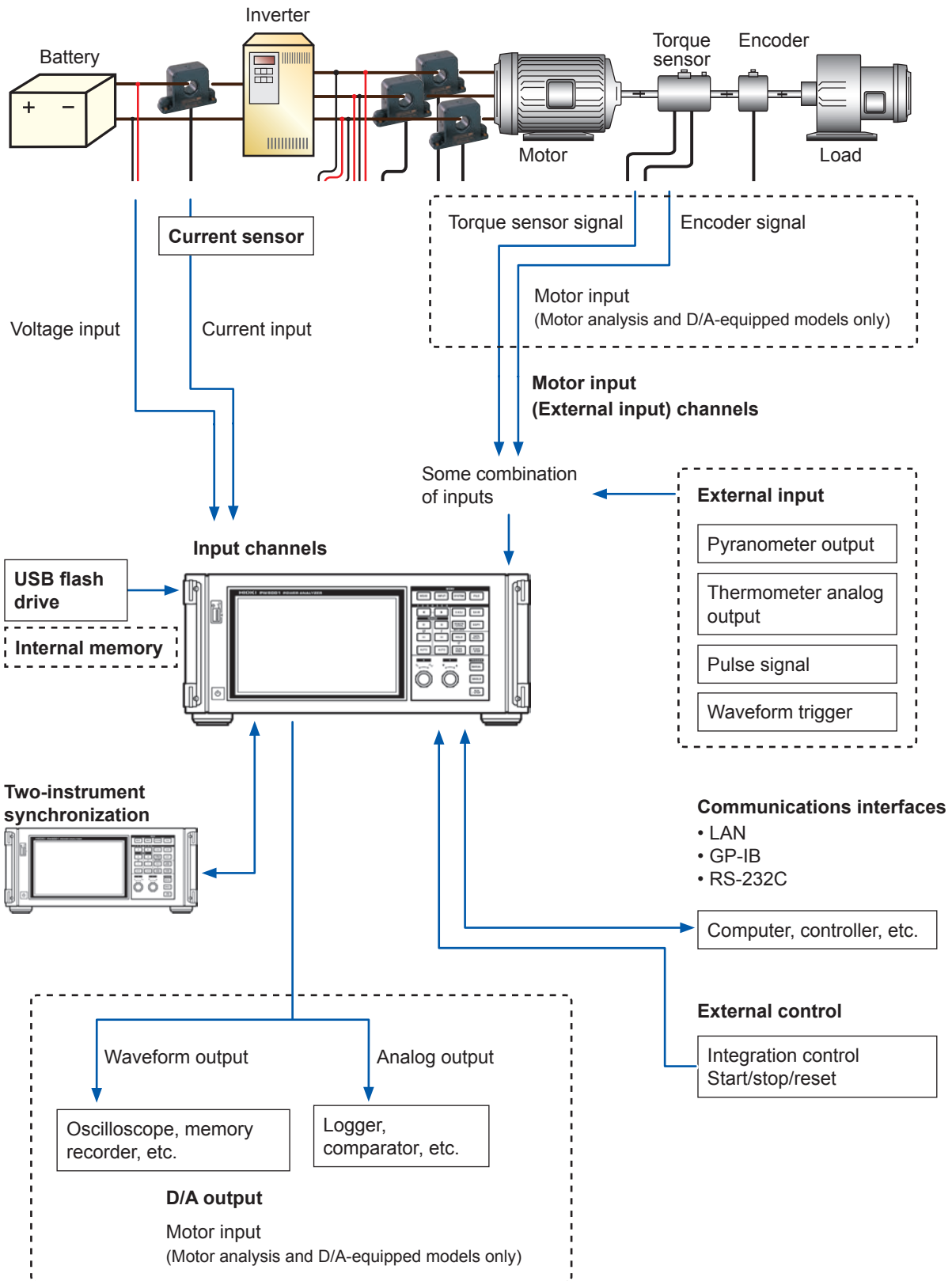



# Example Measurement Setups

## Conversion efficiency measurement of inverters with built-in SiC

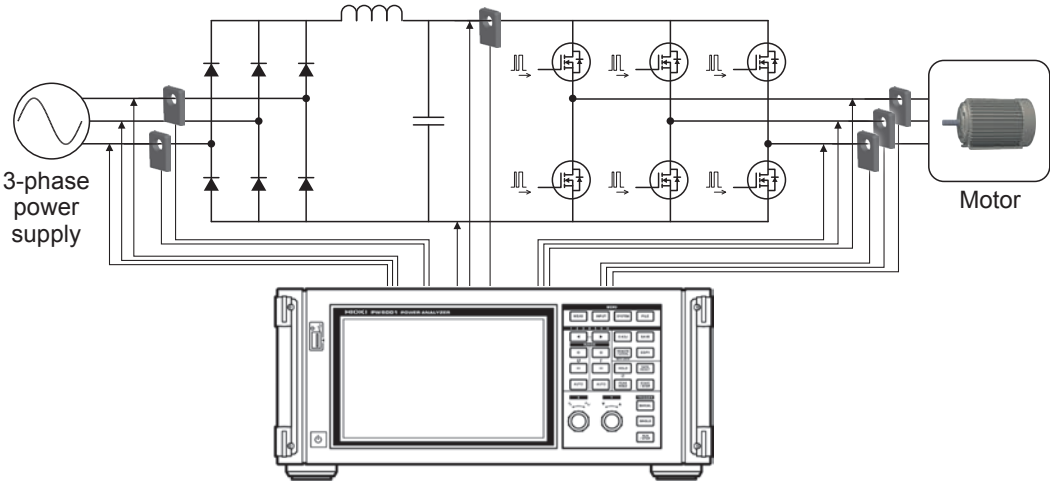

## Measuring the efficiency of PV power conditioners

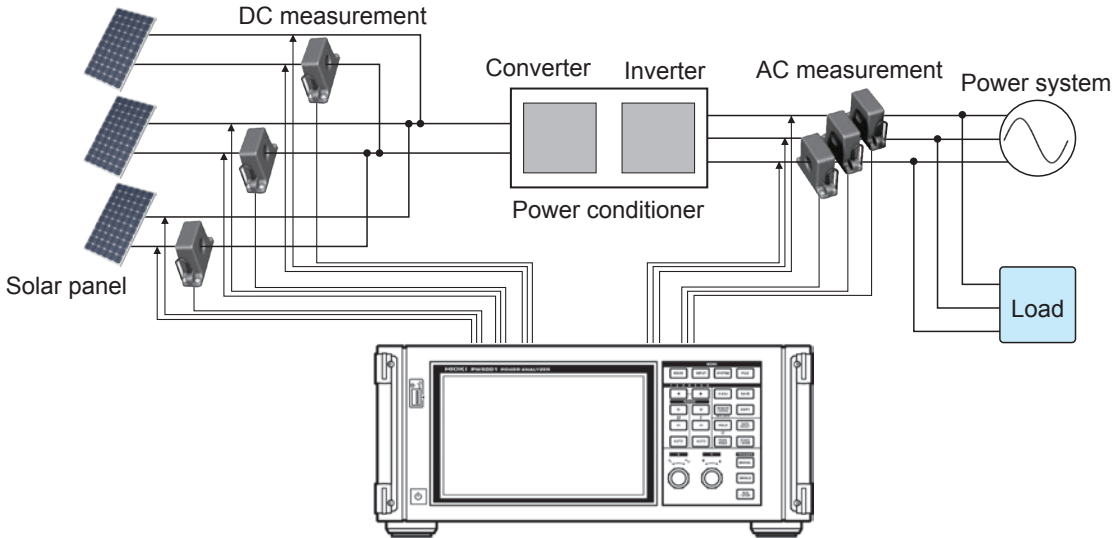

## EV/HEV motor analysis

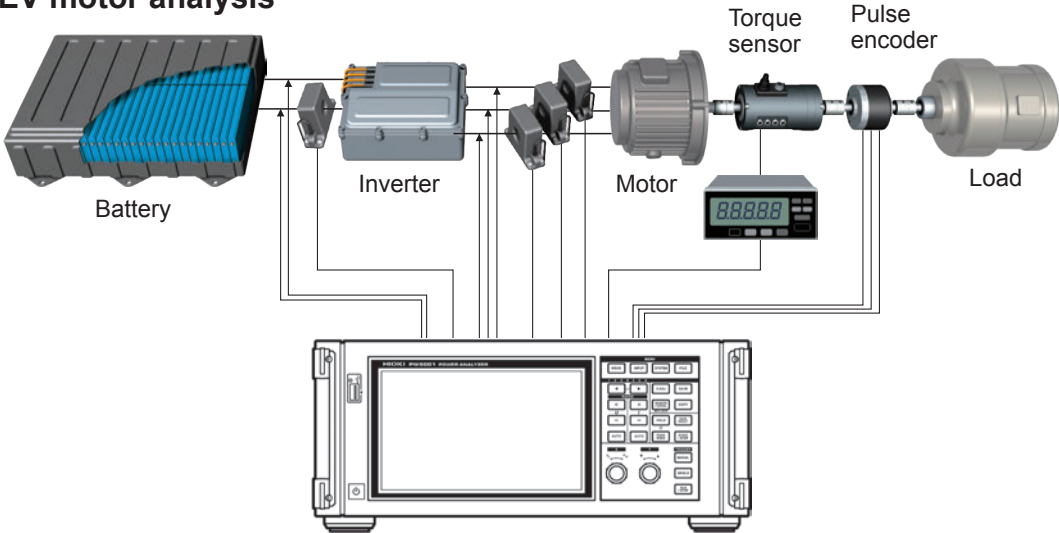



## Introduction

Thank you for purchasing the Hioki PW6001 Power Analyzer. To obtain maximum performance from the instrument, please read the instruction manual first, and keep it handy for future reference.

Following manuals are provided along with the instrument. See manuals relevant to your purpose. The latest version can be downloaded from Hioki's website.

Type	Manual contents	Printed edition	Downloadable edition
Instruction Manual (this manual)	Includes precautions related to the operation of the instrument and information about connection methods, operation methods, functionality, specifications, and related topics.	✓	✓ (PW6001A961-xx.pdf)
Communication Command Instruction Manual	Includes information about the communications commands that are used to control the instrument.	-	✓ (PW6001A964-xx.pdf)
PW Communicator Instruction Manual	Includes information about how to install and use the dedicated application, its specifications, and related topics.	-	✓ (PW_Communicator_en.pdf)

- One or more clamp-on sensors, AC/DC current sensors, or other sensors are required in order to provide current input to the instrument. (These devices are referred to collectively as “current sensor(s)” in this manual.) For more information, see the instruction manual for the current sensor(s) you are using.
- One or more voltage cords (voltage measurement option) or other similar cords are required in order to provide voltage input to the instrument. The instrument's voltage input terminals use standard  $\phi$  4 mm CAT II (1000 V) or CAT III (600 V) compatible safety banana connectors. Provide voltage cords as appropriate for your application.

### Trademarks

- Microsoft, Windows and Internet Explorer are either registered trademarks or trademarks of Microsoft Corporation in the United States and other countries.
- The Bluetooth® word mark and logos are registered trademarks owned by Bluetooth SIG, Inc. and any use of such marks by Hioki E.E. Corporation is under license. Other trademarks and trade names are those of their respective owners.

## Product model numbers

Right side

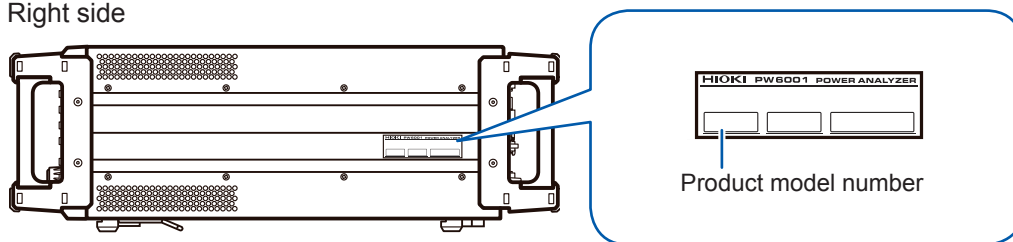

Product model number	Number of input channels	Additional functionality
PW6001-01	1	n/a
PW6001-02	2	n/a
PW6001-03	3	n/a
PW6001-04	4	n/a
PW6001-05	5	n/a
PW6001-06	6	n/a

PW6001-11	1	Motor analysis and D/A output
PW6001-12	2	Motor analysis and D/A output
PW6001-13	3	Motor analysis and D/A output
PW6001-14	4	Motor analysis and D/A output
PW6001-15	5	Motor analysis and D/A output
PW6001-16	6	Motor analysis and D/A output

In this manual, models equipped with motor analysis and D/A output functionality are referred to as “motor analysis and D/A-equipped models.”

## Verifying Package Contents

Once you have received the instrument, verify that it has not suffered any damage during shipment before using it. Pay particular attention to accessories, panel switches, and terminals. If you discover any damage or find that the instrument does not operate as stipulated in its specifications, please contact your authorized Hioki distributor or reseller. When transporting the instrument, use the original packaging.

Verify that the packaging includes all contents.

- PW6001 Power Analyzer

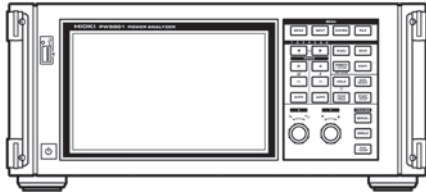

- Instruction manual (This document)
- Power cord
- D-sub 25-pin connector  
(Motor analysis and D/A-equipped models only)









## Options

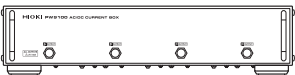
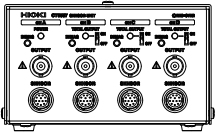

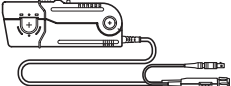
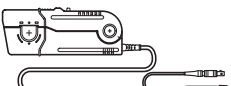
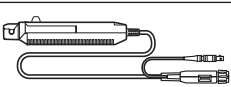

The following options are available for the product. Contact your authorized Hioki distributor or reseller when ordering.

### Current measurement options

<b>CT6841</b>	AC/DC Current Probe (20 A)	
<b>CT6843</b>	AC/DC Current Probe (200 A)	
<b>CT6844</b>	AC/DC Current Probe (500 A)	
<b>CT6845</b>	AC/DC Current Probe (500 A)	
<b>CT6846</b>	AC/DC Current Probe (1000 A)	
<b>CT6862</b>	AC/DC Current Sensor (50 A)	
<b>CT6863</b>	AC/DC Current Sensor (200 A)	
<b>CT6875</b>	AC/DC Current Sensor (500 A) Cable length: 3 m	
<b>CT6875-01</b>	AC/DC Current Sensor (500 A) Cable length: 10 m	
<b>CT6876</b>	AC/DC Current Sensor (1000 A) Cable length: 3 m	
<b>CT6876-01</b>	AC/DC Current Sensor (1000 A) Cable length: 10 m	
<b>CT6877</b>	AC/DC Current Sensor (2000 A) Cable length: 3 m	
<b>CT6877-01</b>	AC/DC Current Sensor (2000 A) Cable length: 10 m	
<b>CT6904</b>	AC/DC Current Sensor (500 A)	

<b>PW9100</b>	AC/DC Current Box (50 A)	
<b>CT9557</b>	Sensor Unit (Sensor power supply with 4-channel addition function)	
<b>CT9900</b>	Conversion Cable (PL23 receptacle/ME15W plug)	
<b>CT9904</b>	Conversion Cable (For connecting the CT9557)	
<b>3273-50</b>	Clamp On Probe (30 A)	
<b>3274</b>	Clamp On Probe (150 A)	
<b>3275</b>	Clamp On Probe (500 A)	
<b>3276</b>	Clamp On Probe (30 A)	
<b>CT6700</b>	Current Probe (5 A)	
<b>CT6701</b>	Current Probe (5 A)	

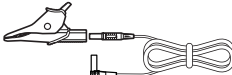
**Voltage measurement options**

<b>L9438-50</b>	Voltage Cord (banana connector/banana connector; red and black × 1 ea.; cord length: approx. 3 m) CAT III 1000 V, 10 A / CAT IV 600 V, 10 A	
<b>L1000</b>	Voltage Cord (banana connector/banana connector; red, yellow, blue, and gray × 1 ea.; black × 4; cord length: approx. 3 m with alligator clips) CAT III 1000 V, 10 A / CAT IV 600 V, 10 A	
<b>L9257</b>	Connection Cord (banana connector/banana connector; red and black × 1 ea.; cord length: approx. 1.2 m with alligator clips) CAT III 1000 V, 10 A / CAT IV 600 V, 10 A	
<b>L1021-01</b>	Patch Cord (branches to banana connectors/ banana connector; red × 1; cord length: approx. 0.5 m; for branching voltage input) CAT III 1000 V, 10 A / CAT IV 600 V, 10 A	

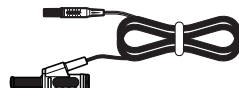
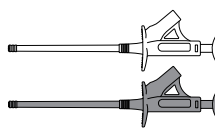
<b>L1021-02</b>	Patch Cord (branches to banana connectors/ banana connector; black × 1; cord length: approx. 0.5 m; for branching voltage input) CAT III 1000 V, 10 A / CAT IV 600 V, 10 A	
<b>L9243</b>	Grabber Clip (red and black × 1 ea.) CAT II 1000 V, 1 A	

**Connection options**

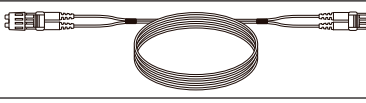
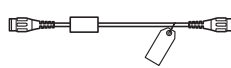
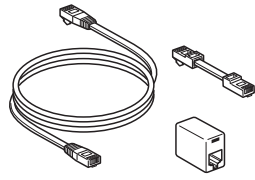
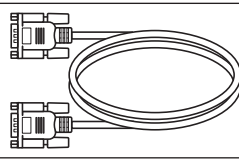
<b>L6000</b>	Optical Connection Cable (10 m)	
<b>L9217</b>	Connection Cord (isolated BNC; 1.7 m; for motor input) CAT II 600 V, 0.2 A / CAT III 300 V, 0.2 A	
<b>9642</b>	LAN Cable (CAT 5e with cross conversion connector; 5 m)	
<b>9637</b>	RS-232C Cable (9-pin/9-pin; cross; 1.8 m)	
<b>9151-02</b>	GP-IB Connector Cable (2 m)	
<b>9444</b>	Connection Cable (for external control use; 9-pin/9-pin; straight; 1.5 m)	

**Other options**

<b>Special-order</b>	Rack mount hardware (for EIA or JIS)
<b>Special-order</b>	Carrying case (rigid trunk type; with casters)



## Safety Information

The PW6001 has been designed and tested in accordance with the IEC 61010 safety standard and shipped in a safe state. However, failure to adhere to the precautionary information and follow the instructions provided in this instruction manual may render safety-related functionality provided by the instrument inoperable.

Before using the instrument, be sure to carefully review the following important safety information.

### **DANGER**



**Improper use of the instrument may result in bodily injury or equipment damage. Read this instruction manual carefully and ensure that you understand its contents before operating the instrument.**







### **WARNING**







**Electricity poses a number of hazards, including electric shock, overheating, fire, and arc discharge (caused by a short). Individuals using an electrical measuring instrument for the first time should be supervised by a technician who has experience in electrical measurement.**

### Safety-related notations



This manual classifies safety information on the basis of the severity of the associated risk and hazard level using the following categories.

 <b>DANGER</b>	Indicates an imminent hazard that could lead to serious injury or death.
 <b>WARNING</b>	Indicates a hazard that could lead to serious injury or death.
 <b>CAUTION</b>	Indicates a hazard that could lead to minor injury or that could be expected to result in equipment or other damage.
<b>IMPORTANT</b>	Indicates information or content that is especially important to keep in mind when operating the instrument or performing maintenance work.
	Indicates a high-voltage hazard. Warns that failure to verify safety or improper use of the instrument could lead to electric shock, burns, or death.
	Indicates an action that you must refrain from performing.
	Indicates an action that you must perform.
<b>*</b>	Indicates that there is additional information below.
<b>p.</b>	Indicates a reference page number.
<b>[ ]</b>	Key names are enclosed in parentheses.
<b>ON</b>	Text shown on the instrument's screen is formatted in bold.
Unless otherwise noted, the term "Windows" is used in this manual to refer to Windows XP, Windows Vista, and Windows 7.	

### Symbols displayed on the instrument

	Indicates the need for caution or a hazard. When this symbol is displayed on the instrument, refer to the corresponding section of the instruction manual.
	Indicates the ground terminal.
	Indicates AC (Alternating Current)
	Indicates the power supply's "on" and "off" positions.

### Symbols related to standards

	Indicates the Waste Electrical and Electronic Equipment Directive (WEEE Directive) in EU member states.
	Indicates that the product conforms to regulations set out by the EC Directive.

### Accuracy

We define measurement tolerances in terms of f.s. (full scale), rdg. (reading) and dgt. (digit) values, with the following meanings:

<b>f.s.</b>	(Maximum display value) The maximum displayable value. This is usually the name of the currently selected range.
<b>rdg.</b>	(Reading or displayed value) The value currently being measured and indicated on the measuring instrument.
<b>dgt.</b>	(Resolution) The smallest displayable unit on a digital measuring instrument, i.e., the input value that causes the digital display to show a "1" as the least-significant digit.

### Measurement categories

To ensure safe operation of measurement instruments, IEC 61010 establishes safety standards for various electrical environments, categorized as CAT II to CAT IV, and called measurement categories.

## ! DANGER



- **Never use a measuring instrument whose measurement category is lower than the location in which it will be used. Doing so may result in a serious accident.**
- **Never use a measuring instrument with no category labeling in a CAT II to CAT IV measurement category. Doing so may result in a serious accident.**

The PW6001 conforms to the safety requirements for CAT II (1000 V) and CAT III (600 V) measuring instruments.

CAT II: When directly measuring the electrical outlet receptacles of the primary electrical circuits in equipment connected to an AC electrical outlet by a power cord (portable tools, household appliances, etc.)

CAT III: When measuring the primary electrical circuits of heavy equipment (fixed installations) connected directly to the distribution panel, and feeders from the distribution panel to outlets

CAT IV: When measuring the circuit from the service drop to the service entrance, and to the power meter and primary overcurrent protection device (distribution panel)

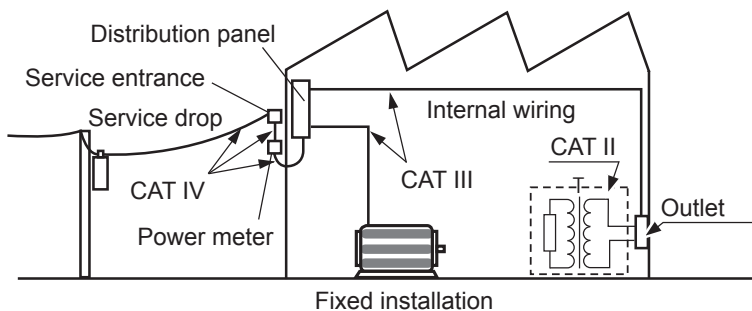

## Operating Precautions

Please observe the following precautions to ensure that you can use the instrument safely and fully utilize its functionality.

### Checking the instrument before use

Before using the instrument, check the instrument for any damage that may have been sustained while in storage or transit, inspect it, and verify that it is operating properly. If you discover any malfunction or damage, contact your authorized Hioki distributor or reseller.

#### **DANGER**



**Damage to voltage cords or the instrument may result in electric shock. Check voltage cords for worn insulation and exposed metal before use. If you find damage, replace the cords with those specified by our company. Failure to do so may result in electric shock.**

#### **WARNING**



**To prevent electric shock, verify that the white or red portion of the cable (insulation layers) are not exposed. If any color is visible from the inside of the cable, do not use the instrument.**

### Installation

Installing the instrument in inappropriate locations may cause a malfunction of instrument or may give rise to an accident. Avoid the following locations.

#### **WARNING**



- Exposed to direct sunlight or high temperature
- Exposed to corrosive or combustible gases
- Exposed to water, oil, chemicals, or solvents
- Exposed to high humidity or condensation
- Exposed to a strong electromagnetic field or electrostatic charge
- Exposed to high quantities of dust particles
- Near induction heating systems (such as high-frequency induction heating systems and IH cooking equipment)
- Susceptible to vibration

#### **CAUTION**



- Do not place the instrument on an unstable bench or inclined surface. Doing so may cause the instrument to fall off the surface or to fall over, resulting in bodily injury or equipment damage.
- Do not use an uninterruptible power supply (UPS) or a DC-AC inverter that produces rectangular waves or pseudo-sine-wave output to power the instrument. Doing so may damage the instrument.

### Instrument placement

- Place the instrument right-side up.
- Do not block the instrument's air vents.
- Leave at least 20 mm of space on every surface other than the underside to keep the instrument's temperature from rising.  
Leave at least 15 mm of space underneath the instrument (the height of its feet).  
See "1.3 Part Names and Functions" (p. 21).

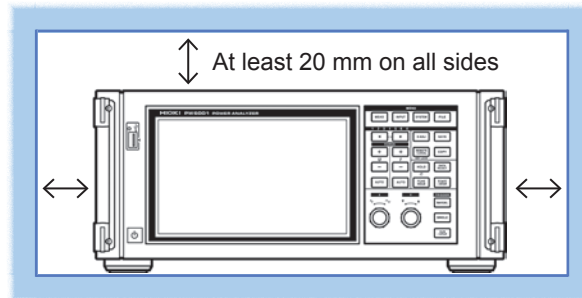

### Handling of the instrument

#### **DANGER**



To prevent electric shock, never remove the instrument's enclosure. There are high-voltage and high-temperature parts inside the instrument.

#### **CAUTION**



- To prevent damage to the instrument, avoid exposing it to vibration or mechanical shock when transporting or otherwise handling it. Exercise particular care not to drop the instrument.
- If the instrument malfunctions or displays an error during use, consult "12 Troubleshooting" (p. 257) and then contact your authorized Hioki distributor or reseller.
- Carry the instrument using its handle after disconnecting all cords and removing the USB flash drive.
- Use a common ground for both the instrument and the device to be connected. Using different ground circuits will result in a potential difference between the instrument's ground and the ground of the device to be connected. If the cable is connected while such a potential difference exists, it may result in equipment malfunction or failure.
- Before connecting or disconnecting any cable, always turn off the instrument and the device to be connected. Failure to do so could result in equipment malfunction or damage.
- After connecting the cable, tighten the screws on the connector securely. Failure to secure the connector could result in equipment malfunction or damage.



- Do not press down on the touch panel with excessive force or use hard or sharp objects to press down on the touch panel. Doing so may result in equipment damage.

This instrument may cause interference if used in residential areas. Such use must be avoided unless the user takes special measures to reduce electromagnetic emissions to prevent interference to the reception of radio and television broadcasts.

## Cord and current sensor handling

### DANGER



- Always connect voltage cords and current sensors to the secondary side of a circuit breaker. The secondary side will be protected by the breaker in the event of a short. Do not measure the primary side of a circuit breaker as it will carry a larger current, increasing the amount of damage in the event of a short-circuit.
- When using the instrument, always use the designated power cord. Use of a power cord other than the designated cord may result in fire.



- Connect current sensors and voltage cords to the instrument before connecting them to a live measurement line. Observe the following precautions to prevent short-circuits and electric shock:
  - Do not place the metal part of the tips of voltage cord clips across two measurement lines at the same time. Never touch the metal part of the tips of voltage cord clips.
- When a current sensor is in the open position, do not place the metal part of its clamp tip across two measurement lines at the same time or use the sensor on a bare conductor.
  - Do not connect voltage cords unnecessarily.



- To prevent short-circuit or bodily injury, use current sensors with circuits whose voltage is less than or equal to the sensor's maximum rated input-to-ground voltage. Do not use current sensors with bare conductors. (For more information about a current sensor's maximum rated input-to-ground voltage, refer to its instruction manual.)

### WARNING



- When using an AC/DC Current Sensor such as the CT6862, it is necessary to cut the measurement line in order to route it through the sensor. To prevent an electric shock or short-circuit, turn off all equipment before connecting the sensor.
- To prevent an electric shock or short-circuit, use the designated voltage cords to connect the measurement lines to the instrument's voltage input terminals.

### CAUTION



- To ensure safety, use only voltage cords designated by our company.
- To prevent a break in instrument wiring, grip the plug (not the cord) when unplugging the power cord from an outlet or disconnecting it from the instrument.
- Exercise caution as conductors being measured may become hot.



- To avoid damaging cord insulation, do not step on cords or allow them to be pinched between other objects.
- If a voltage cord melts, its metal conductor may be exposed. Do not use a cord whose metal conductor is exposed. Doing so may result in electric shock, burns, or other injury.
- Do not drop current sensors or subject them to mechanical shock. Doing so may damage the core joint and adversely impact measurement. When disconnecting a connector, always release the lock and then grip the connector to pull it out. Pulling on connectors with excessive force before releasing the lock or pulling on cables will cause damage to connectors. (p. 38)
- Do not connect or disconnect connectors while the instrument is on or while a sensor is clamped to the conductor being measured. Doing so may damage the instrument or current sensor.

## Handling of the L6000 Optical Connection Cable

### ⚠ WARNING

When connecting an L6000 Optical Connection Cable that is already connected to an operating optical output to the instrument, never look directly at the tip of the cable or observe it with a device such as a magnifying glass. Doing so may adversely affect your eyes or damage your vision.

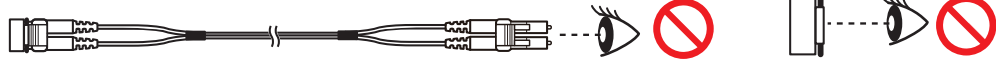

### ⚠ CAUTION



- When connecting an L6000 Optical Connection Cable to the instrument, exercise care to ensure that there is no dirt or dust in the optical connector. In particular, exercise caution concerning the end face (ferrule). Accurate measurement may be impossible if the cable is connected while there is dirt or other foreign matter on the face, or if the face is scratched or otherwise damaged.
- The instrument's two-instrument synchronization connector and the L6000 Optical Connection Cable's optical connector are precisely machined parts. When not in use, always attach the included dust cap to each.

- When cleaning the center of an optical connector, do not apply excessive force to the cleaning cloth. Doing so may damage the connector, preventing it from performing to specifications.

- To prevent damage to the L6000 Optical Connection Cable, observe the following precautions:

- Do not insert the optical connector at an angle.
- Do not pull on the cable with excessive force.

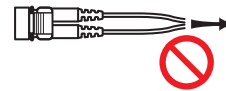
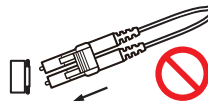

- Do not bend the cable at the neck of the optical connector.
- Do not allow the cable to become kinked.

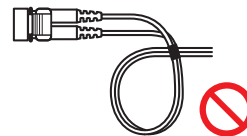
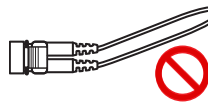

- Do not bend or twist the cable.
- Do not touch the end face (ferrule).

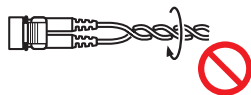

- Clean the optical connector end face (ferrule) of the L6000 Optical Connection Cable each time it is connected.
- To clean the L6000 Optical Connection Cable's optical connectors, use a commercially available cleaner designed for optical connectors.

## Before connecting the instrument

### DANGER

- Do not measure voltages that exceed the rating indicated on the instrument labeling or the measurement range listed in the specifications. Doing so may result in damage to the instrument or bodily injury.
- The maximum rated input-to-ground voltages for the instrument's voltage inputs are as follows:  
 CAT II: 1000 V DC, 1000 V AC rms  
 CAT III: 600 V DC, 600 V AC rms  
 Do not measure a voltage in excess of these limits. Doing so may result in damage to the instrument or bodily injury.
- The Probe1 and Probe2 terminals are not isolated. These input terminals are provided for use with optional current sensors only. Connections of input other than output from an optional current sensor may damage the instrument or result in bodily injury.
- To avoid electric shock and instrument damage, do not input a voltage in excess of the maximum input voltage to the instrument's external input terminals.

### WARNING

- Before turning on the instrument, verify that the supply voltage being used is the same as that noted on the instrument's power inlet. Use of a voltage outside the specified supply voltage range may result in damage to the instrument or an electrical accident.
- To avoid an electric shock or short-circuit, verify that all connections have been made securely. Loose terminals may result in increased contact resistance, causing overheating, equipment burnout, or fire.
- Connect voltage cords to input terminals securely. Loose terminals may result in increased contact resistance, causing overheating, equipment burnout, or fire.

### CAUTION

-  To ensure safety, always disconnect the power cord from the instrument and isolate the instrument from the power supply completely when not in use.

## Measurement precautions

### WARNING

-  If you notice smoke, an unusual sound, an unusual odor, or other anomaly, halt measurement immediately, disconnect measurement lines, turn off the instrument, unplug the power cord from the outlet, and disconnect the instrument from the measurement target. Then contact your authorized Hioki distributor or reseller. Continued use may result in fire or electric shock.

## Precautions when transporting the instrument

### CAUTION



- To transport the instrument safely, use the packing box and cushioning material in which the product was shipped from Hioki. However, do not use the packing box if it is torn or deformed, and do not use the cushioning material if it has been crushed. If you are unable to use the packing box and cushioning materials in which the product was shipped from Hioki, consult your authorized Hioki distributor or reseller.
- Be sure to disconnect any voltage cords and current sensors as well as power cords from the instrument before packing it. When transporting, avoid dropping or other excessive impact.
- Pack the instrument so that it will not be damaged during shipment and note the nature of the malfunction. Damage occurred during transportation is not covered by warranty.



## 1.1 Product Overview

The PW6001 series of power analyzers comprises models with simultaneous measurement capabilities for targets ranging from one 1-phase/2-wire circuit to two 3-phase/4-wire circuits, enabling them to accommodate a variety of measurement lines. Variants offer from one to six channels.

- **For use in the development and evaluation of increasingly efficient inverter motors**
  - The PW6001 can perform high-precision, high-stability, wideband inverter power measurement that is highly reproducible.
  - The instrument can perform electrical angle measurement, which is a necessary part of motor analysis.
  - When connected to a high-precision torque meter and encoder, the instrument can measure motor efficiency.
- **For use in the development and evaluation of alternative energy technologies, including solar power, wind power, and fuel cells**
  - The PW6001 can simultaneously measure AC power and DC power at a high level of precision and calculate efficiency.
  - The instrument can measure power drawn from the grid, power sold to the grid, and power by consumption/generation by means of DC mode and RMS mode current and power integration.
- **For use in the measurement of high-frequency power in wireless power feeds and DC/DC converters**
  - The PW6001 can measure power at frequencies of up to 1 MHz.
  - The instrument can measure and analyze harmonic distortion of switching waveforms at frequencies of up to 300 kHz.

## 1.2 Features

- **Simultaneous measurement of multiple circuits incorporating various types of power lines (p.43)**
  - For 3-phase/3-wire circuits, users can select a Hioki model 3193-compatible 3V3A connection or a Hioki model PW3390 and 3390-compatible 3P3W3M connection in addition to the two-wattmeter method. The 3P3W3M connection is particularly well suited to measuring power with inverter motors that have high-frequency leak current.
- **High accuracy and highly stable circuitry for high measurement reproducibility (p.77)**

The instrument delivers best-in-class basic accuracy and DC accuracy for active power and therefore provides support for DC/AC conversion efficiency with high-accuracy measurement performance.
- **High-bandwidth, high-speed opto-isolated sampling**
  - The PW6001 can measure increasingly high-speed switching waveforms accurately thanks to wideband voltage and current input circuits (DC, 0.1 Hz to 2 MHz) and 5 MS/s, 18-bit high-speed, high-resolution sampling capability.
  - Thanks to its use of voltage inputs that use new optical devices to implement isolation with a high dielectric strength, the instrument delivers a CMRR of 80 dB (at 100 kHz), enabling it to aggressively reject high-frequency common-mode noise when measuring inverters.
- **Support for a variety of current sensors (p.38)**
  - In addition to conventional power measurement sensors, the PW6001 supports wideband current probes designed for use with megahertz-order frequencies.
  - The instrument ships standard with a power supply for 3270 series clamp-on probes.

● **New functionality to take full advantage of current sensor performance (p.127)**

The instrument's phase compensation calculations can correct current sensor's high-frequency phase characteristics.

● **Complete six-channel + dual mode harmonic analysis function (p.71)**

The PW6001 supports simultaneous harmonic analysis for all channels. By performing simultaneous harmonic analysis for multiple circuits with different frequencies, the instrument can perform simultaneous harmonic analysis for both the primary and secondary sides of an inverter.

● **Waveform observation functionality on par with that of an oscilloscope (p.95)**

The PW6001 can record waveforms of up to 100 sec. in duration (10 kS/s sampling) or 10 sec. in duration (at 100 kS/S sampling) thanks to its large waveform storage memory (1 Mword × 6 voltage/current channels).

● **Standard USB flash drive support and large internal memory (p.141)**

- Thanks to its large, 64 MB internal memory capacity, the PW6001 can continuously record data for numerous parameters even when using a high-speed interval.
- Data can be saved directly on a USB flash drive, screens can be copied to a USB flash drive, and data can be copied from the internal memory to a USB flash drive.

● **Easy-to-understand touch panel and key operation (p.21)**

- The PW6001 can be controlled using either dedicated hardware keys or an easy-to-understand touch panel.
- Comments can be entered on the touch panel when saving screen copies and measurement data.

● **Robust motor analysis functionality (option) (p.184)**

- When fed output from a torque meter and tachometer, the PW6001 can measure motor power and motor efficiency.
- The instrument supports A-phase/B-phase pulse output from a rotary encoder as rotation input and can detect the direction of rotation.
- It also supports Z-phase output from the encoder and can measure the motor's electrical angle.
- A single PW6001 can simultaneously accept two sets of torque and RPM input, leveraging its six channels of input to allow simultaneous analysis of two motors.
- The instrument can simultaneously display either the torque waveform or the encoder pulse waveform along with voltage and current waveforms.
- Since all inputs are functionally isolated, they can be used for two-channel voltage measurement at up to ±10 V or pulse waveform measurement across four channels at up to 1 MHz.

● **High-speed D/A output with waveform capability (option) (p.175)**

The PW6001 incorporates 20 channels of D/A output, enabling it to generate analog output for 20 user-selected measurement parameters.

- When using waveform output mode, voltage and current waveforms for the number of channels with which the instrument is equipped are output in order at 1 MS/s and 16 bits. Safe, isolated voltage and current waveforms can be input to another waveform measuring instrument for analysis.

● **High-performance remote synchronization function using optical fiber (p.171)**

- Optical fiber can be connected to the synchronization interface to enable synchronized measurement at multiple locations with different instrument power supply potentials.
- Up to two instruments separated by up to 500 m can be synchronized to perform measurement.

● **Dedicated communications application software (downloadable from Hioki's website) (p.191)**

- A dedicated PC application that can control the instrument remotely, acquire data in real time, and display it on the screen can be downloaded free of charge from our website.
- The following communications interfaces are supported: LAN, GP-IB, RS-232C.

# 1.3 Part Names and Functions

## Front

### USB flash drive interface (p.141)

Connect a USB flash drive to save measurement data, settings, screenshots, and other data. This interface does not support use of a mouse, keyboard, or other device.

### Display

Touch the touch panel to display measured values and change settings.

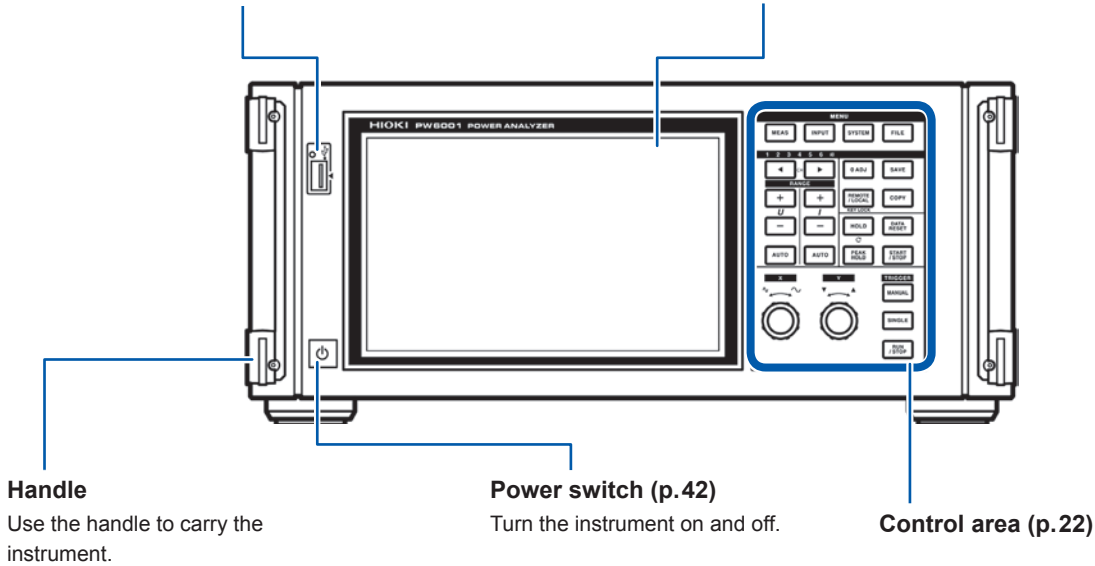

- Both key operation and touch panel operation are completely disabled while the key lock function is active, with the exception of key operation used to cancel the key lock state (p.23).
- The key lock state will persist even if the instrument's power is cycled.

## Instrument operation

The instrument is controlled by means of the **MENU** keys and rotary knobs in the control area and the display's touch panel.

	Operation	Description
Touch		Touch the touch panel.
Press		Press a control key.
Turn		Turn a rotary knob.

**Control area**

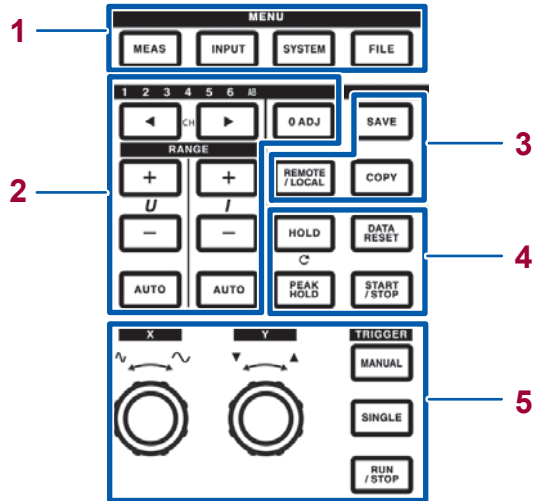

**1 MENU keys (switching screens)**

Pressing a key causes the selected key to light up and the screen to change to the selected screen.



**[MEAS]** key (p.32)

Displays the Measurement screen.

The Measurement screen is used to display measured values and waveforms.



**[INPUT]** key (p.33)

Displays the Input Settings screen.

The Input Settings screen is used to configure settings related to input, connections, measurement, and calculations.



**[SYSTEM]** key (p.137)

Displays the System Settings screen.

The System Settings screen is used to configure settings related to time control, interfaces, and overall instrument parameters.



**[FILE]** key (p.141)

Displays the File Operations screen.

The File Operations screen is used to manipulate files.

**2 Channel indicator LED**



- Lights up to indicate the input channel to which the **[RANGE]** key and setting indicators apply.

- Channels that have been grouped into a connection based on connection settings will light up at the same time.

- The **AB** LED corresponds to CH A and CH B on motor analysis and D/A-equipped models.



**[CH]** keys

- Used to switch the channel whose channel indicator LED is lit up.

- Used to switch the channel on the Basic Settings screen and Harmonic screen.

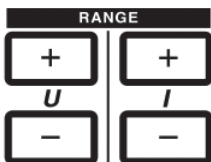

**[RANGE]** keys

- The **U [+/-]** keys change the voltage range, while the **I [+/-]** keys change the current range.

- Changes apply to the channel whose channel indicator LED is lit up.

- When the **AB** LED is lit up, the **U** buttons apply to CH A analog input, while the **I** buttons apply to CH B analog input.

- When the **[AUTO]** key is lit up, AUTO range operation is canceled when the range is changed.



**[AUTO]** keys

- The **U [AUTO]** key enables the AUTO range function for voltage, while the **I [AUTO]** key enables the AUTO range function for current. The key will light up. It will go out if pressed again, and the range will be fixed to the current setting at that time.
- Changes apply to the channel whose channel indicator LED is lit up.



**[0ADJ]** key (p.45)

Performs zero adjustment for the input channel.

3

**[SAVE] key**

Saves the measurement data at the time the key is pressed to the USB flash drive.

**[COPY] key**

Saves a screenshot of the screen at the time the key is pressed to the USB flash drive.

**[REMOTE/LOCAL] key (key lock)**

- Lights up when in the remote state for GP-IB communications. Pressing the key again will return to the local state, causing the light to turn off.
- Pressing and holding the key for 3 sec. or more will enable the key lock function, causing the key lock icon to be displayed on the screen. Pressing and holding the key again for 3 sec. or more will cancel the key lock, causing the light to turn off.

4

**Measurement control keys**

The measurement control keys function primarily to control power measurement functions. They do not affect the waveform display.

**[HOLD] key**

- Toggles the hold function on and off. The key lights up when the hold function is on.
- Pressing the **[HOLD]** key while the peak hold function is on will clear the peak hold data.

**[PEAK HOLD] key**

- Toggles the peak hold function on and off. The key lights up when the peak hold function is on.
- Pressing the **[PEAK HOLD]** key while the hold function is on will update the hold data.

**[DATA RESET] key**

- Resets integration data.
- The key functions while the **[START/STOP]** key is lit up (red).

**[START/STOP] key**

- Controls starting and stopping of the integration and automatic save functions.
- It lights up when operation starts (green) and when operation stops (red).
- It turns off when the **[DATA RESET]** key is pressed.

## 5 Waveform control keys (rotary knobs)

The waveform control keys function primarily to control waveform capture. They operate independently of the instrument's power measurement functionality.



### [MANUAL] key (manual trigger function)

- Forcibly applies a trigger while waiting for a trigger.
- The trigger is applied when the key is pressed, causing recording to start.



### [SINGLE] key

- Performs one waveform capture.
- The key lights up (green) when pressed. Once the trigger is applied and the waveform captured, it turns off.

Lit up (green)	The instrument is waiting for a trigger. Recording will start when the trigger is applied.	
Off	[RUN/STOP]: Lit up (red)	Recording will stop once data has been recorded for the recording length.
		Pressing [RUN/STOP] while the instrument is waiting for a trigger will cause recording to stop.



### [RUN/STOP] key

- Causes waveform to be recorded continuously.
- The key lights up (turns green) when pressed and then turns red when pressed again.

Lit up (green)	The instrument enters the trigger standby state. Recording will start when the trigger is applied. The instrument will repeatedly wait for a trigger.
Lit up (red)	Recording will stop.



### Rotary knobs

- The rotary knobs function primarily to zoom waveforms in or out and to change the position or cursor.
- They are also used with certain settings to vary (increase/decrease) values.
- Each knob operates as appropriate when turned or pressed while lit up but does nothing if the light is off.

Back

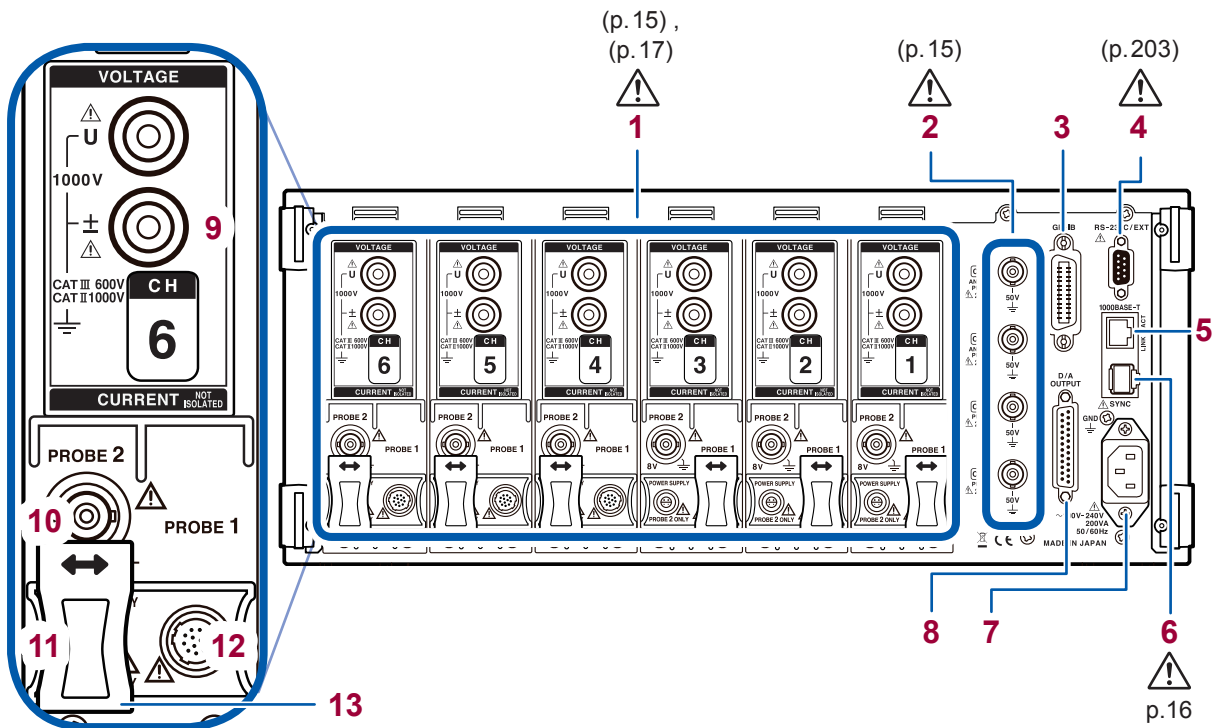

1

Overview

<b>1</b> Input channels 1 through 6	Insert up to six channels in the form of units that accept input of voltage and current for one phase of power.
<b>2</b> Motor input (external input) channels (p. 82)	(Motor analysis and D/A-equipped models only) • Measure motor efficiency. • Input torque sensor and tachometer output to measure motor output.
<b>3</b> GP-IB connector (p. 200)	• Control the instrument remotely using GP-IB. • Transfer data to a computer.
<b>4</b> D-sub 9-pin connector (p. 203)	• Control the instrument remotely from a computer or controller via serial RS-232C communications. • Control starting and stopping of integration with a contact switch.
<b>5</b> LAN connector (p. 192)	• Control the instrument remotely over a LAN. • Acquire data.
<b>6</b> Two-instrument synchronization connector (p. 171)	Perform measurements using two synchronized instruments.
<b>7</b> Power inlet (p. 37)	Connect the included power cord.
<b>8</b> D/A output connector (p. 175)	(Motor analysis and D/A-equipped models only) • Input the instrument's output into a recorder to record data over an extended period of time. • Input to an oscilloscope to observe the waveform.
<b>9</b> Voltage input terminal (p. 37)	Connect a Hioki-designated voltage cord.
<b>10</b> Probe2 terminal (p. 40)	Connect a Hioki 3270 series current probe for wideband current measurement.
<b>11</b> Probe2 power supply terminal (p. 40)	Connect a 3270 series current probe.
<b>12</b> Probe1 terminal (p. 39)	Connect a CT6800 series current sensor for high-precision current measurement.
<b>13</b> Sliding cover	Slide open the cover to select the current sensor being used.

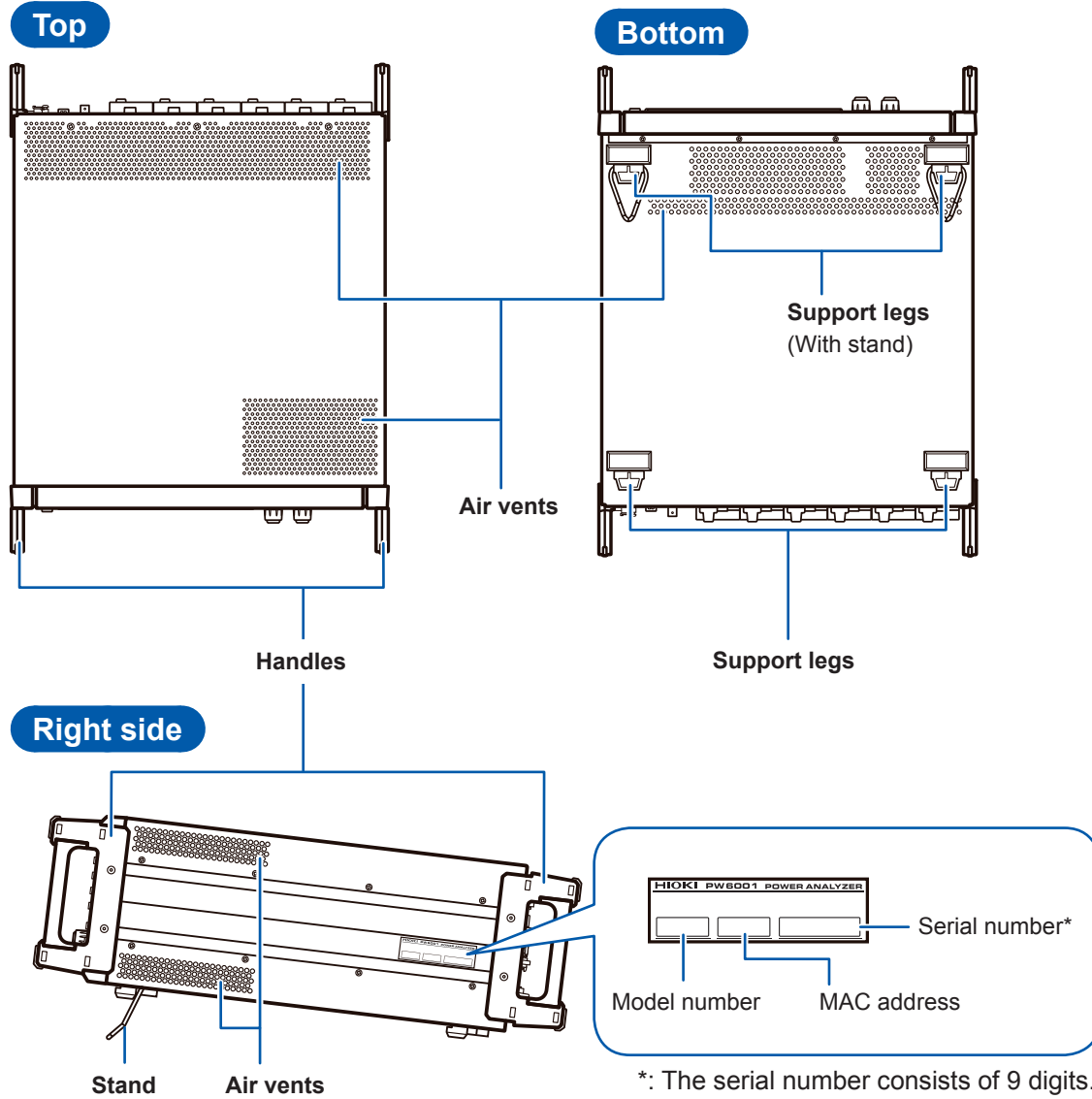

\*: The serial number consists of 9 digits. The first two (from the left) indicate the year of manufacture, and the next two indicate the month of manufacture. Required for production control. Do not peel off the label.

**⚠ CAUTION**



Do not subject the instrument to excessive force from above while using the stand. Doing so may damage the stand.

Leave at least 20 mm of space on every surface other than the underside to keep the instrument's temperature from rising. Leave at least 15 mm of space underneath the instrument (the height of its feet).



# 1.4 Basic Operation (Screen Display and Layout)

## Screen Operation

### 1 Switching screens (p.32)

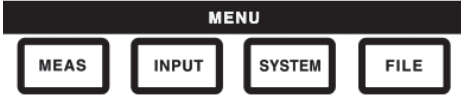

### 2 Selecting the display screen

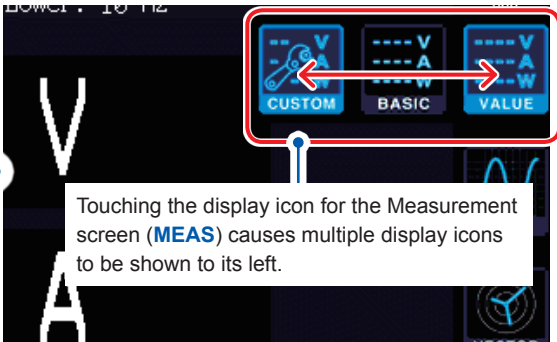
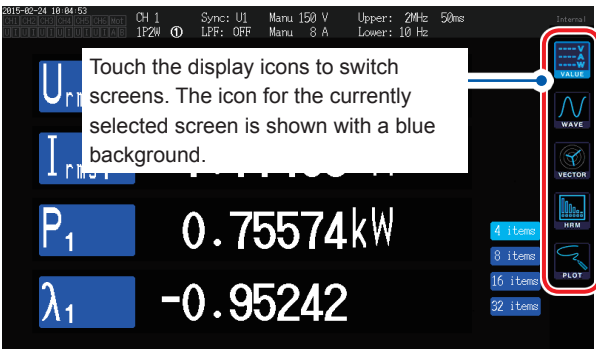

### 3 Changing display contents and settings

Touch active areas of the screen to control it.

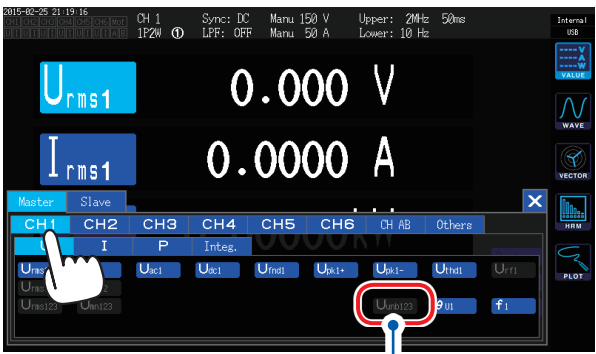

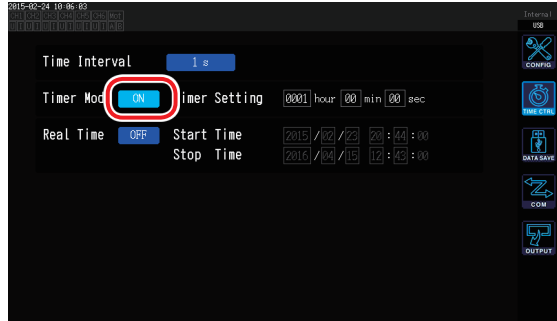
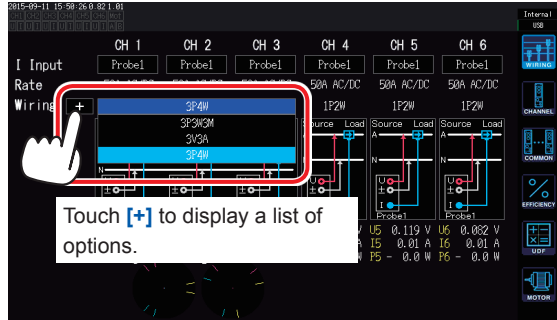
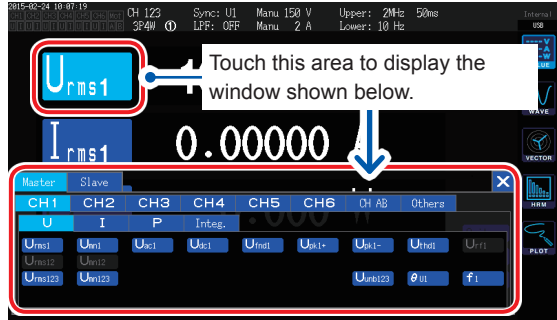
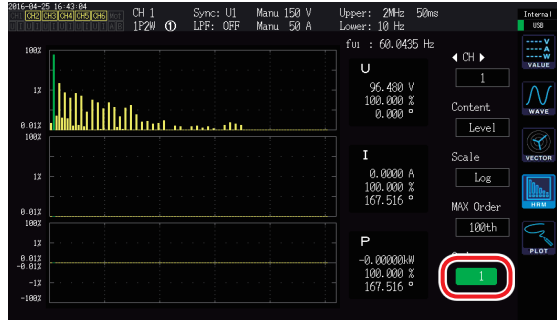
Screen	Description
	<p><b>ON/OFF</b></p> <p>Touch the button to toggle it between the “on” and “off” states.</p>
	<p><b>Combo box</b></p> <p>Touch an option to select it. Touching outside the list of options will close the list without changing the setting.</p>
	<p><b>Window (p.29)</b></p> <ul style="list-style-type: none"> <li>While the window is being displayed, the control area and touch panel keys outside the window may be temporarily disabled.</li> <li>Once you have finished configuring the settings as desired, touch <b>[x]</b> to close the window.</li> </ul> <p>There are three types of window:</p> <ul style="list-style-type: none"> <li>Parameter selection windows (p.52)</li> <li>Keyboard windows</li> <li>Numeric keypad windows</li> </ul>
	<p><b>Changing values with rotary knobs</b></p> <p>Touch the screen. When the edge of one of the instrument’s rotary knobs lights up, you can turn that knob to change the value or manipulate the waveform.</p> <p>“Instrument operation” (p.21)</p>

### Keyboard windows

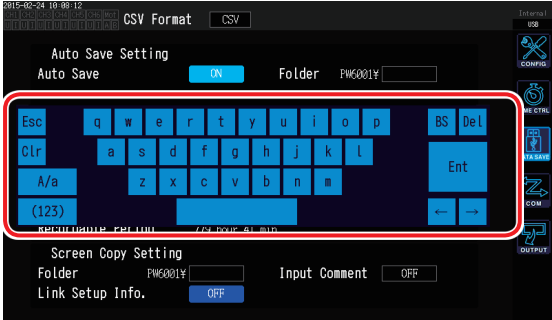
Screen	Description
	<p>Enter comments, units, and folder names using the keyboard.</p> <p>While this window is open, you can only touch inside the window.</p>

<b>Esc</b>	Cancels text entry and closes the window.
<b>Clr</b>	Clears all entered text.
<b>A/a</b>	Toggles between uppercase and lowercase keyboards.
<b>(123)</b>	Switches among letters, numbers, and symbols.
<b>BS</b>	Deletes the character before the cursor position.
<b>Del</b>	Deletes the character at the cursor position.
<b>Ent</b>	Accepts the entered text and closes the window.
<b>← →</b>	Moves the cursor position left and right.

### Numeric keypad windows

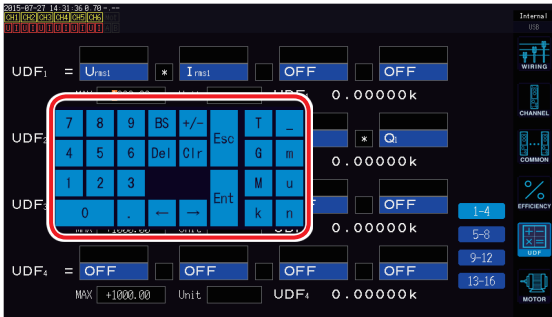
Screen	Description
	<p>Enter numerical values.</p> <p>While this window is open, you can only touch inside the window.</p>

<b>Esc</b>	Cancels text entry and closes the window.
<b>Clr</b>	Clears all entered text.
<b>BS</b>	Deletes the number before the cursor position.
<b>Del</b>	Deletes the number at the cursor position.
<b>Ent</b>	Accepts the entered numbers and closes the window.
<b>← →</b>	Moves the cursor position left and right.
<b>+/-</b>	This button is displayed when a sign can be entered.
<b>T, G, M, k, _ , m, u, n</b>	These buttons are displayed when a prefix such as k (kilo) or M (mega) can be entered. Choosing [ _ ] will clear the prefix. These buttons are displayed when a prefix cannot be entered.

## Common Screen Display

The following is an example screen. Actual screens vary depending on the instrument's settings. This section describes the screen elements that are shown on all screens.

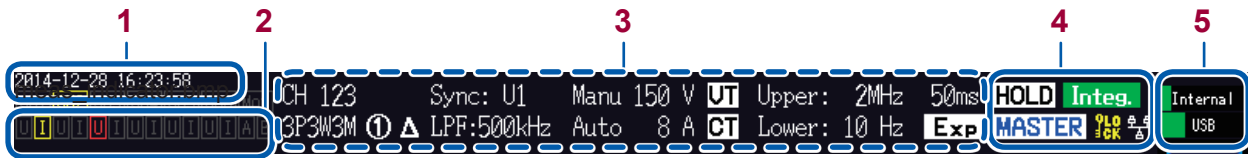

### 1 Time display

Displays the time (year, month, date, hours, minutes, seconds).

Displays the synchronization state and range-/peak-over state for each input channel.

- In the example to the left, CH2 is in the synchronization unlocked state.

<b>CH1 to CH6</b>	Input channels	Gray	Channel(s) with which instrument is not equipped
<b>Mot</b>	Motor input channels	Yellow	Channel(s) in the synchronization unlocked state

### 2

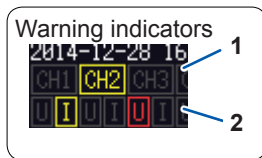

- In the lower portion of the display, the range-/peak-over state for **[U]** and **[I]** or **[A]** and **[B]** is shown for each channel.

<b>U</b>	Voltage input	<b>A</b>	CH A analog DC input	Gray	Normal measurement
<b>I</b>	Current input	<b>B</b>	CH B analog DC input	Yellow	Range-over
				Red	Peak-over

In the above example, CH1 current input is in the range-over state, while CH3 voltage input is in the peak-over state.

### 3 Setting indicators

See "Measurement Screen Display" (p.31)

Operating state indicators

### 4

<b>HOLD</b>	Lights up when in the hold state.	<b>Integ.</b>	Indicates the integration function's operating state. Yellow: Standby Green: Integration in progress Red: Integration stopped
<b>PEAK</b>	Lights up when in the peak hold state.	<b>LO BK</b>	Lights up when in the key lock state.
<b>MASTER</b>	Lights up when serving as the master during two-instrument synchronization operation.	<b>LAN</b>	Lights up when connected to a network via the LAN interface.
<b>SLAVE</b>	Lights up when serving as the slave during two-instrument synchronization operation.		

### 5 Media indicators

Displays usage of the internal memory and USB flash drive using level meters. The indicators will turn red when utilization reaches 95%.

## Measurement Screen Display

The following is an example screen. Actual screens vary depending on the instrument's settings. This section describes screen displays that are shown only on the Measurement screen. This area provides what are known as setting indicators.

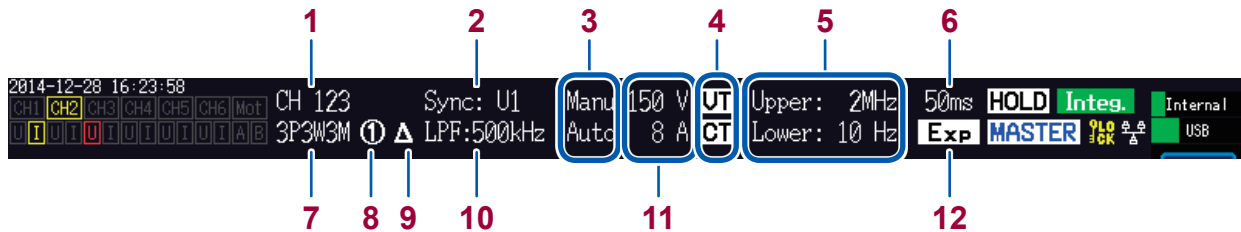

<b>1</b>	Combined channels	Displays channels that have been combined as part of the same connection.	
<b>2</b>	Synchronization source	Displays the setting for the source that determines the period (zero-cross) that serves as the basis for measurement.	
<b>3</b>	Auto-range operation	<b>Auto</b>	Auto-range function on
		<b>Manu</b>	Auto-range function off
		The top row indicates the voltage setting, while the bottom row indicates the current setting.	
<b>4</b>	Scaling	Shown when the VT ratio and CT ratio have been set.	
<b>5</b>	Measurement upper limit and lower limit frequencies	<b>Upper</b>	Measurement upper limit frequency setting
		<b>Lower</b>	Measurement lower limit frequency setting
<b>6</b>	Data update rate	Displays the data update rate setting.	
<b>7</b>	Connection mode	Displays the set connection mode. Sets the method for combining channels in a connection pattern and the connection mode according to the measurement lines.	
<b>8</b>	Current sensor connection terminals	<b>1</b>	When Probe1 is selected as the current sensor
		<b>2</b>	When Probe2 is selected as the current sensor
<b>9</b>	Delta conversion setting	<b>Δ</b>	Delta conversion on
		<b>No display</b>	Delta conversion off
<b>10</b>	LPF	Displays the low-pass filter setting.	
<b>11</b>	Range	Displays the set range. The top number indicates the voltage range, while the bottom number indicates the current range.	
<b>12</b>	Averaging	Displays the averaging setting.	
		<b>Add</b>	Simple averaging
		<b>Exp</b>	Exponential averaging
		<b>No display</b>	Off







## Screen Layouts

### Measurement screen (displayed with [MEAS] key)







<b>VALUE</b> Measured Value screen	<b>BASIC</b> Basic display	Displays power measured values for each channel and motor input measured values for each connection.
	<b>CUSTOM</b> Selection display	Displays measured values for user-selected basic measurement parameters.
<b>WAVE</b> Waveform screen	<b>WAVE</b> Waveform display	Displays voltage, current, and motor input waveforms.
	<b>WAVE + ZOOM</b> Waveform + zoom display	Displays an enlarged view of the waveform.
	<b>WAVE + VALUE</b> Waveform + measured value display	Displays numerical measured values for 12 parameters together with waveforms.
	<b>WAVE + FFT</b> Waveform + FFT analysis	Performs FFT analysis based on the waveform and displays the analysis results.
<b>VECTOR</b> Vector screen	<b>VECTOR 1</b> 1 vector	Displays the user-selected order component of a harmonic measured value as a numerical value and vector.
	<b>VECTOR 2</b> 2 vector	Displays vectors for two user-selected connections.
<b>HRM</b> Harmonic screen	<b>LIST</b> List display	Displays the user-selected harmonic measurement parameter as a list of values.
	<b>BAR GRAPH</b> Graph display	Displays harmonic data for the user-selected channel as bar graphs for voltage, current, and active power.
<b>PLOT</b> Plot screen	<b>D/A MONITOR</b> D/A monitor display	Displays the selected D/A output parameters as a graph and as values.
	<b>X-Y PLOT</b> X-Y Plot display	Creates and displays a total of two XY graphs for the four selected parameters.

## Input screen (displayed with the **[INPUT]** key)

	<b>WIRING</b> Connection settings	Allows the user to set the connection pattern that determines how input channels will be combined based on the measurement lines.
	<b>CHANNEL</b> Channel-specific settings	Allows the user to set detailed measurement conditions for each connection selected based on the connection pattern.
	<b>COMMON</b> Common input settings	Allows the user to set measurement conditions that are used by (that apply to) all channels.
	<b>EFFICIENCY</b> Efficiency calculation settings	Allows the user to set the formula to use to calculate efficiency.
	<b>UDF</b> User-defined calculation settings	Allows you to set a calculation formula combining measured values from the instrument along with values and functions.
	<b>MOTOR</b> Motor input settings	Allows the user to configure motor input.

## System Settings screen (displayed with the **[SYSTEM]** key)

	<b>CONFIG</b> System settings	Allows the user to review and configure the system environment.
	<b>TIME CTRL</b> Time control settings	Allows the user to configure time control.
	<b>DATA SAVE</b> Data save settings	Allows the user to configure how data is saved on the USB flash drive and in the instrument's internal memory.
	<b>COM</b> Communications settings	Allows the user to configure the communications interface.
	<b>OUTPUT</b> D/A output settings	Allows the user to configure settings related to D/A output.

## File Operations screen (displayed with the **[FILE]** key)

The File Operations screen is used to manipulate files on the USB flash drive and to save and load settings files.





# 2

# Preparing for Measurement

## 2.1 After Purchase

Complete the following tasks before using the instrument to make measurements.

### Wrapping voltage cords in spiral tubes

The L9438-50 Voltage Cord comes with five spiral tubes. Use each of these tubes to wrap two cords (red and black) as necessary.

#### You will need

##### L9438-50 Voltage Cord

The following supplies are included:

Banana/banana cord × 2

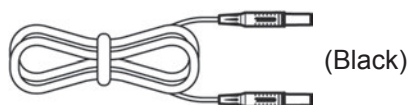
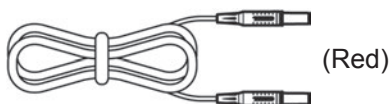

Alligator clip × 2



Spiral tube (for wrapping cords) × 5

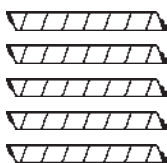

#### Attaching the spiral tubes

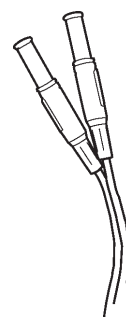

#### 1 Align two cords (red and black).

Align the ends of two cords (red and black) so that they can be wrapped easily.

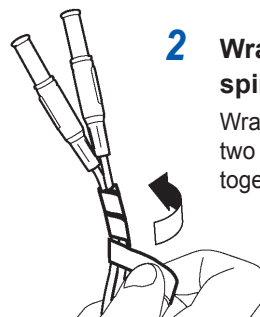

#### 2 Wrap the cords with a spiral tube.

Wrap the spiral tube around the two cords so that they are held together.

The set comes with five spiral tubes. Use them at an appropriate interval.

Example: With five spiral tubes attached

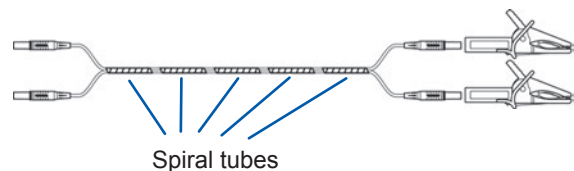

# 2

## 2.2 Inspecting the Instrument before Use

Be sure to read “Operating Precautions” (p. 13) before use.

Before using the instrument, check the instrument for any damage that may have been sustained while in storage or transit, inspect it, and verify that it is operating properly. If you discover any malfunction or damage, contact your authorized Hioki distributor or reseller.

### Inspecting accessories and options

Inspection item	Action
Is the power cord's insulation worn, or is any metal exposed?	If you find any damage, do not use the instrument as the damage may result in an electric shock or short-circuit. The instrument will not be able to perform normal measurement in its current state. Contact your authorized Hioki distributor or reseller.
Is the current sensor clamp cracked or otherwise damaged?	

### Inspecting the instrument

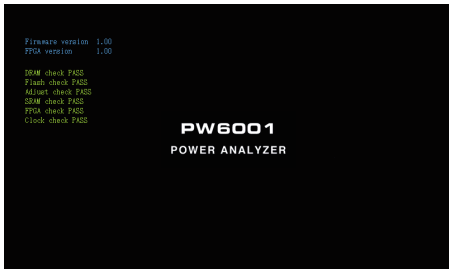
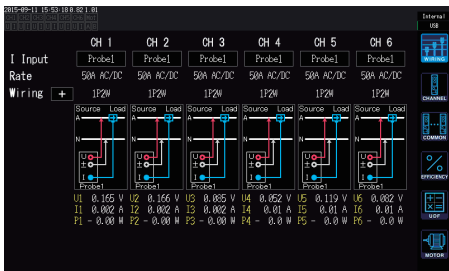
Inspection item	Action
Is the instrument damaged?	If you find any damage, have the instrument repaired.
<p>Does the instrument display the self-test screen (showing the model number and version) when it is turned on? (The version shown will depend on the most recent version of firmware installed at the time the screen is displayed.)</p> <p>Display when the instrument is turned on</p> 	If the screen is not displayed, the power cord may have a break in it, or the instrument's internal circuitry may be damaged. Contact your authorized Hioki distributor or reseller.
<p>After the self-test is complete, does the instrument display <b>[WIRING]</b> on the Input screen or the screen that was being shown when it was last turned off?</p> <p><b>[WIRING]</b></p> 	If the screen is not displayed, the instrument's internal circuitry may be damaged. Contact your authorized Hioki distributor or reseller.
Is the instrument's time accurate?	Set the instrument's time to the current time “Changing System Settings” (p. 137).

## 2.3 Connecting the Power Cord

Turn off the instrument's power before connecting or disconnecting its power cord.

- 1 Verify that the instrument's power switch is in the "off" position.
- 2 Connect the power cord to the instrument's power inlet after verifying that the supply voltage falls within the instrument's rated range (100 V to 240 V AC)

Rear

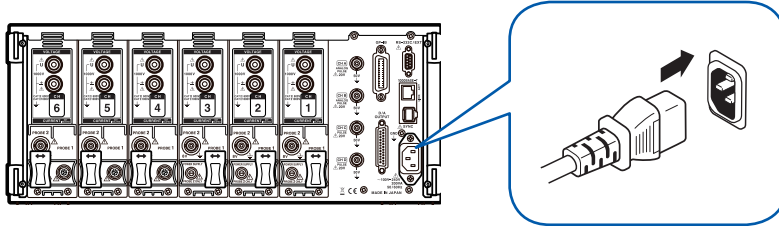

- 3 Connect the power cord's plug to an outlet.

## 2.4 Connecting the Voltage Cords

Be sure to read "Operating Precautions" (p. 13) before connecting any voltage cords. Connect the optional voltage cords to the instrument's voltage input terminals. (Connect as many cords as are required by the measurement lines and connection type.) See "2.8 Connecting the Instrument to the Measurement Lines (Zero-adjustment)" (p. 45).

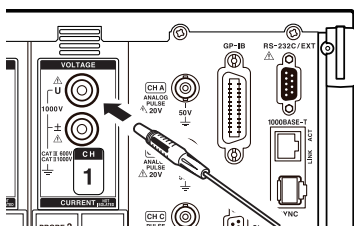

Connect a voltage cord of the same color to the voltage input terminal's channel label.

*Insert the plug as far as it will go.*

## 2.5 Connecting the Current Sensors

Be sure to read “Operating Precautions” (p. 13) before connecting any current sensors. For detailed specifications and instructions for the current sensors being used, refer to the instruction manual that came with each device.

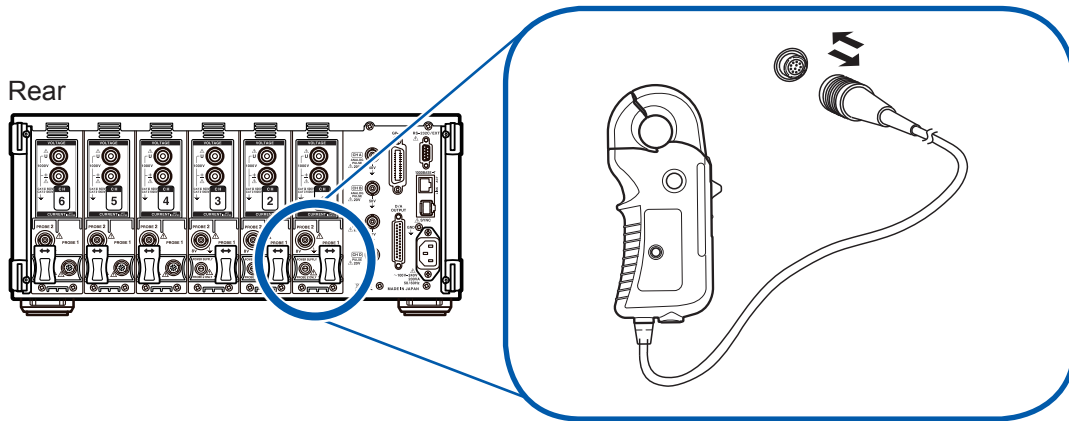

The instrument provides two dedicated terminals for current sensors: Probe1 and Probe2. Use the Probe1 terminal when performing high-precision current measurement with the model 9709 and CT6860 series of AC/DC Current Sensors or the CT6840 series of AC/DC Current Probes. Use the Probe2 terminal when performing wideband current measurement with the 3270 series of Clamp On Probes. Connect each sensor after moving the sliding cover.

Current sensors cannot be connected to both Probe1 and Probe2 on the same channel.

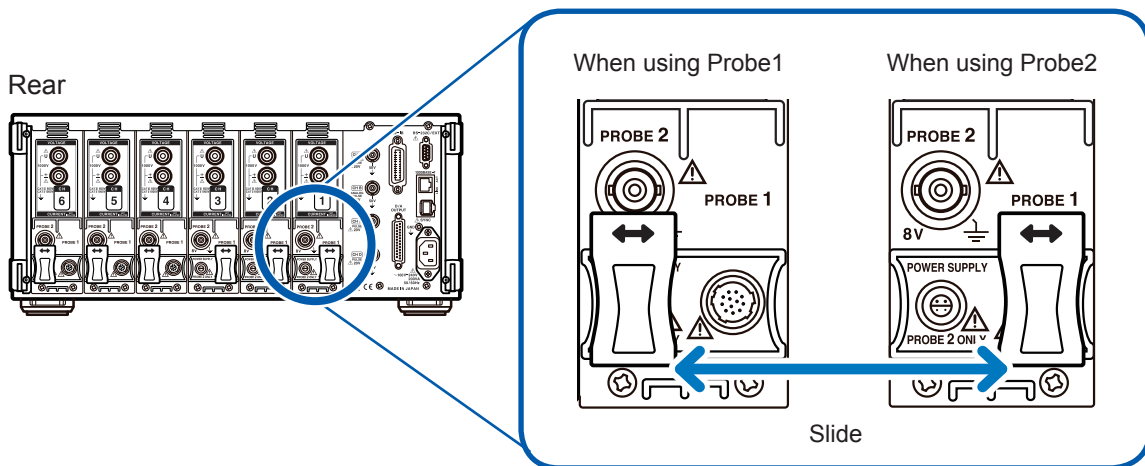

## Connecting a current sensor to the Probe1 terminal

### ⚠ CAUTION



Do not connect or disconnect any current sensors while the instrument is on. Doing so may damage the current sensors.

#### Connecting a current sensor

- 1 Align the guides on the connector.
- 2 Insert the connector straight until it locks in place.

The instrument will automatically detect the type of current sensor being used.

Align the connector so that the wide part is at the top of the instrument.

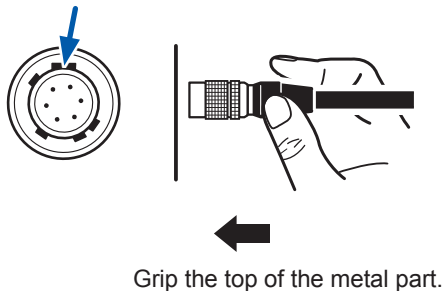

#### Disconnecting a current sensor

- 1 Grip the metal part of the connector and slide it towards you.
- 2 Pull out the connector.

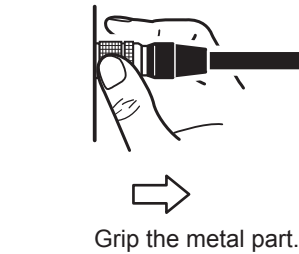

Current sensors in the model 9709, CT6860, and CT6840 series are available in two variants. Model numbers ending with -05 have a metal connector, while those that do not end in -05 have a black plastic connector. Models with a metal connector can be connected directly to the Probe 1 terminal.

Current sensors with a black plastic connector whose model numbers do not end with -05 can be connected to the Probe1 terminal using the optional CT9900 Conversion Cable.

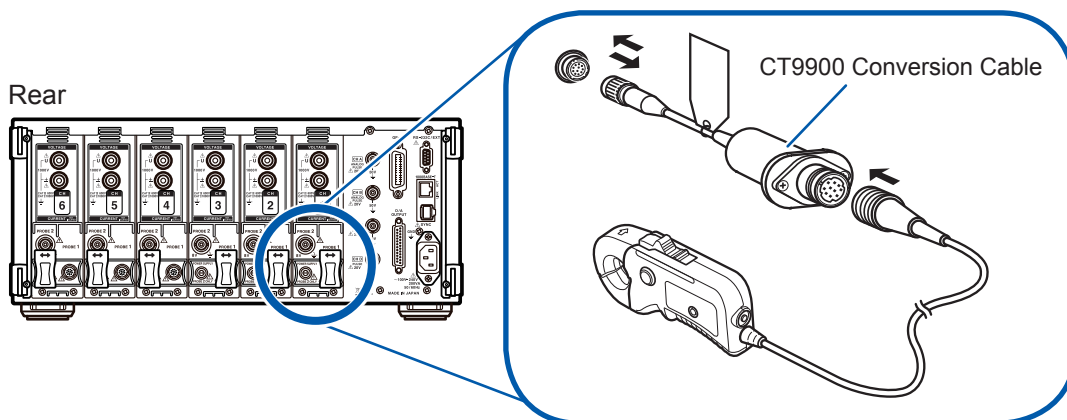

When the CT6865 (rated for 1000 A) is connected with the CT9900 Conversion Cable, it will be recognized by the instrument as a 500 A AC/DC sensor. Use the sensor with the CT ratio set to 2.00.

## Connecting a current sensor to the Probe2 terminal

### Connecting a current sensor

- 1** Align the recessed part of the 3270 series termination connector with the protruding part of the Probe2 terminal (BNC connector) and insert the connector.
- 2** Twist the connector to the right to lock it in place.

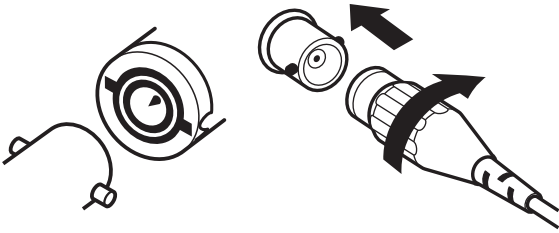

- 3** Align the guide position of the 3270 series power supply cable's plug with the Probe2 power supply terminal.
- 4** Insert the connector straight until it locks in place with a clicking sound.

### Disconnecting a current sensor

- 1** Twist 3270 series termination connector to the left.  
The lock will disengage.
- 2** Pull out the connector.

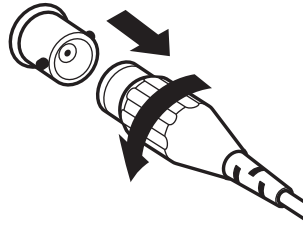

Although the instrument can accommodate up to six channels of 3270 series current probes, it may not be possible to measure the current on the channel in question if a current in excess of the rating is input. If this occurs, immediately remove the current sensors for all channels from the measurement lines and turn off the instrument.

## If the measurement range exceeds (using a VT and CT)

Use an external instrumentation-use voltage transformer (VT [PT]) or instrumentation-use current transformer (CT). The VT ratio and CT ratio can be set on the instrument to allow primary-side input values to be read directly. See “Configuring scaling (when using a VT [PT] or CT)” (p.64).

### DANGER



Do not touch the VT (PT), CT, or instrument input terminals while in the connected state. Doing so may result in electric shock or bodily injury due to the presence of exposed live parts.

### WARNING



- When using an external VT (PT), do not short the secondary side. Applying a voltage to the primary side while in the shorted state may cause a large current to flow to the secondary side, resulting in equipment damage or fire.
- When using an external CT, do not leave the secondary side open. If a current flows to the primary side while in the open state, a high voltage may result on the secondary side, resulting in extreme danger.
- When using a VT (PT) and CT, one secondary-side terminal should be grounded for safety.

#### IMPORTANT

The phase difference between the external VT (PT) and CT may introduce a large error component into power measurements. If you wish to make more accurate power measurements, use a VT (PT) and CT with a small phase error in the frequency band of the circuit being used.

## 2.6 Turning the Instrument On/Off

Be sure to read “Operating Precautions” (p. 13) before turning on the instrument. Connect the power cord, voltage cords, and current sensors before tuning on the instrument.

To ensure accurate measurement, allow a warm-up period of at least 30 minutes to elapse after turning on the instrument before performing zero-adjustment. See “2.8 Connecting the Instrument to the Measurement Lines (Zero-adjustment)” (p.45).

Front

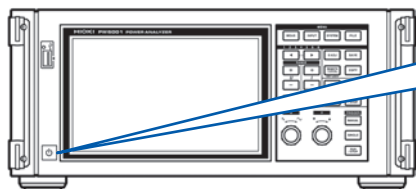

ON/OFF



### Turning on the instrument

#### Turn on the power switch.

The instrument will perform a self-test. (This process will take about 10 seconds.) See “2.2 Inspecting the Instrument before Use” (p.36).

Once the self-test is finished, the Input screen’s **WIRING** page will be displayed (default setting).

If the startup screen is set to **LAST** (p.36), the screen when the instrument was last turned off will be displayed.

### IMPORTANT

If an issue is found with any of the self-test steps, the startup process will stop on the self-test screen. If the process stops again after you cycle the power, the instrument is malfunctioning. Perform the following steps:

1. Stop measurement, cut off the supply of power to the measurement lines or disconnect the voltage cords and current sensors from the measurement lines, and turn off the instrument.
2. Disconnect the power cord and all wiring connections.
3. Contact your authorized Hioki distributor or reseller.

### Turning off the instrument

#### Turn off the power switch.

### CAUTION



Do not turn off the instrument while the voltage cords and current sensors are still connected to measurement lines. Doing so may damage the instrument.



## 2.7 Setting the Connection Mode and Current Sensors

This section describes how to set the connection mode based on the number of channels with which the instrument is equipped and the measurement lines.

First, select a connection pattern from the seven available choices.

Then, for a two-channel combination, select either 1P3W or 3P3W2M. For a three-channel combination, select 3P3W3M, 3V3A, or 3P4W.

	CH1	CH2	CH3	CH4	CH5	CH6
Pattern 1	1P2W	1P2W	1P2W	1P2W	1P2W	1P2W
Pattern 2	1P3W / 3P3W2M		1P2W	1P2W	1P2W	1P2W
Pattern 3	1P3W / 3P3W2M		1P2W	1P3W / 3P3W2M		1P2W
Pattern 4	1P3W / 3P3W2M		1P3W / 3P3W2M		1P3W / 3P3W2M	
Pattern 5	3P3W3M / 3V3A / 3P4W			1P2W	1P2W	1P2W
Pattern 6	3P3W3M / 3V3A / 3P4W			1P3W / 3P3W2M		1P2W
Pattern 7	3P3W3M / 3V3A / 3P4W			3P3W3M / 3V3A / 3P4W		

The available connection patterns will vary with the number of channels with which the instrument is equipped. Only the connection patterns for which a check mark (✓) is shown in the following table can be chosen. However, when combining multiple channels, the same current sensor model must be connected to each.

Number of instrument channels	1	2	3	4	5	6
Pattern 1	✓	✓	✓	✓	✓	✓
Pattern 2	–	✓	✓	✓	✓	✓
Pattern 3	–	–	–	–	–	✓
Pattern 4	–	–	–	✓	–	✓
Pattern 5	–	–	✓	✓	✓	✓
Pattern 6	–	–	–	–	✓	✓
Pattern 7	–	–	–	–	–	✓

### Connections

A connection diagram is provided in the specifications (p.248).

Connection		Description
1P2W	1-phase/ 2-wire	Select this connection when measuring a DC line. The current sensor can be connected to either the source or ground terminal. The connection diagram includes an example of both.
1P3W	1-phase/ 3-wire	–
3P3W2M	3-phase/ 3-wire	Select this connection when using the two-wattmeter method with two channels to measure a 3-phase delta connection line. It enables accurate measurement of active power even when the waveform is distorted due to an unbalanced state. Apparent power, reactive power, and power factor values for unbalanced lines may differ from corresponding values obtained from other measuring instruments. In this case, use a 3V3A or 3P3W3M connection.
3V3A	3-phase/ 3-wire	Select this connection when using the two-wattmeter method with three channels to measure a 3-phase delta connection line when compatibility with legacy power meters such as the 3193 is a priority. It allows accurate measurement of not only active power, but also apparent and reactive power and power factor even with unbalanced lines.
3P3W3M	3-phase/ 3-wire	Select this connection when using the three-wattmeter method with three channels to measure a 3-phase delta connection line. It allows accurate measurement even when the 3V3A connection yields an error due to large high-frequency component leak current when measuring a PWM inverter, making it well suited to motor power measurement.
3P4W	3-phase/ 4-wire	Select this connection when using the three-wattmeter method with three channels to measure a 3-phase Y (star) connection line.

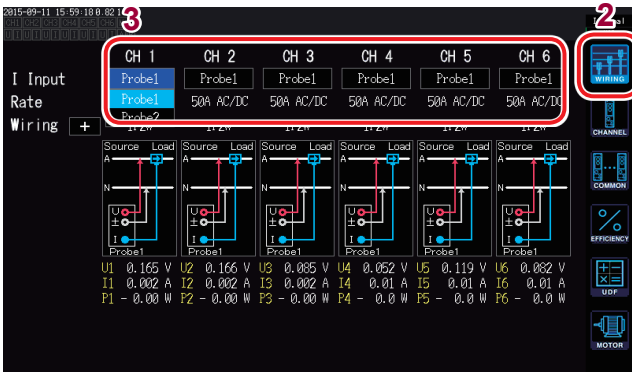

- 1 Press the **[INPUT]** key.
- 2 Touch **[WIRING]**.
- 3 Set the current sensor you wish to use for each channel.

Probe 1	Select when connecting the current sensor to the Probe1 terminal. The rate will be set automatically.
Probe 2	Select when connecting the current sensor to the Probe2 terminal. Touch <b>Rate</b> and select the connected current sensor's rate or model.

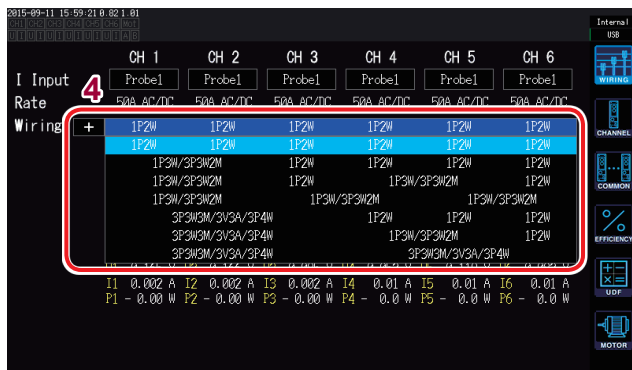

- 4 Touch **[+]** and set the connection pattern.

- 5 If using a combination of two or more channels, set the connections.

Once you accept the settings by touching the connection mode, a connection diagram for the selected connection mode will be displayed.

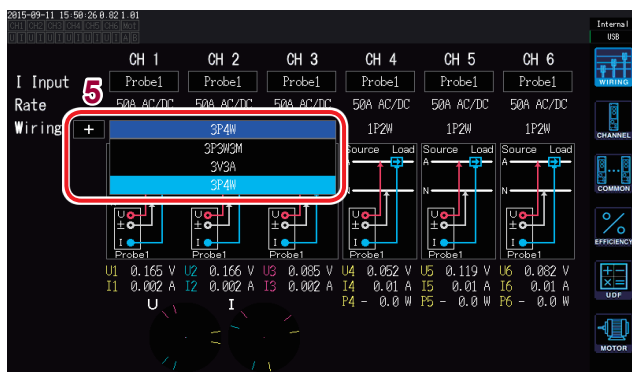

- When measuring a power line using multiple channels, the same current sensor model must be used for each line.  
(For example, when measuring a 3-phase/4-wire line, the same current sensor must be connected to each of channels 1 through 3.)
- When using a current sensor whose sensor rating can be switched, for example the model 9272-10, use the same rating for the same line.
- When selecting a connection pattern that uses multiple channels, the parameters that can be set for each channel (voltage range, etc.) will be set to the same values as for the first channel.

## 2.8 Connecting the Instrument to the Measurement Lines (Zero-adjustment)

Be sure to read “Operating Precautions” (p. 13) before connecting the instrument to the measurement lines. In addition, be sure to perform zero-adjustment before connecting the instrument.

Next, connect the voltage cords and current sensors to the measurement lines as indicated in the connection diagram shown on the instrument’s screen. To ensure accurate measurement, connect the instrument exactly as shown in the diagram. The connection diagram will be displayed when you select the connection mode.

See “2.7 Setting the Connection Mode and Current Sensors” (p. 43).

### IMPORTANT

The phases are labeled as “A,” “B,” and “C” on the connection diagram screen. Connect the instrument based on whatever names you are using, for example “R/S/T” or “U/V/W” as appropriate.

2

Preparing for Measurement

### Zero-adjustment and degaussing (DMAG)

To ensure that the instrument satisfies its accuracy specifications, perform zero-adjustment of voltage and current measured values after allowing the instrument to warm up for about 30 minutes or more. If a current sensor that can measure both AC and DC currents is connected, the current sensor will be degaussed (DMAG) at the same time.



#### 1 Press the [MEAS] key.

If CH1 through CH6 is lit up, zero-adjustment will be performed for voltage and current. If the AB indicator is lit up, zero-adjustment will be performed for the motor input channels.



The displayed channel will change each time ◀▶ is pressed.

#### 2 Press [0ADJ].

A confirmation dialog box will be displayed.

#### 3 Accept input on the confirmation dialog box.

Yes	Performs zero-adjustment.
No	Cancels zero-adjustment.

The screen will display “Now adjusting...” and the process will be complete in about 30 seconds.

- Perform zero-adjustment after connecting the current sensors to the instrument. (Adjustment of current measured values must include the current sensors.)
- When a current sensor for which zero-adjustment can be performed using a zero-adjustment knob or other switch, adjust the current sensor first and then perform zero-adjustment with the instrument.
- Perform zero-adjustment before connecting the instrument to the measurement lines. (Zero-adjustment must be performed without any voltage or current input.)
- To ensure precise measurement, it is recommended to perform zero-adjustment at an ambient temperature that falls within the specified range.
- Zero-adjustment is performed for all ranges and for all input channels at the same time.
- Do not turn off the instrument during zero-adjustment. Doing so will cause the settings to be initialized.

## Connecting the voltage cords to the measurement lines

Example: Secondary side of a circuit breaker

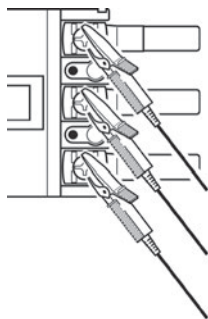

Clip the cords securely to a metal part such as a screw or busbar on the power supply side.

L9438-50 Voltage Cord

## Connecting the current sensor to the measurement lines

### IMPORTANT

Clamp the sensor so that the current direction mark faces the load side.

Clamp the sensor to only one conductor. If you simultaneously clamp a sensor to two (1-phase) or three (2-phase) wires, the instrument will not be able to make a measurement.

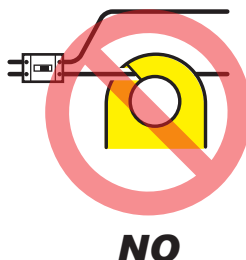
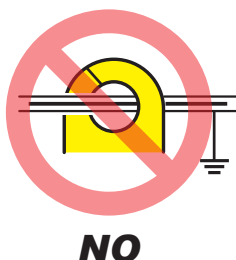
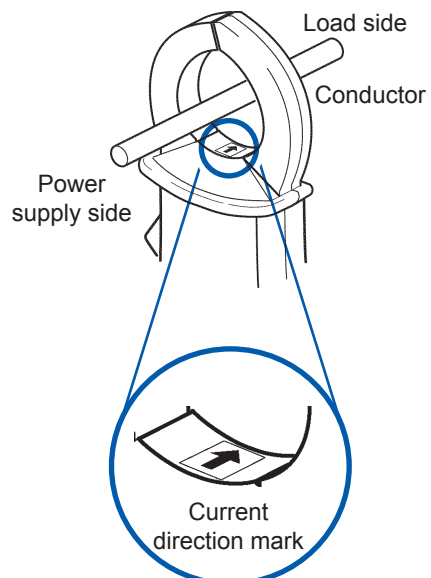
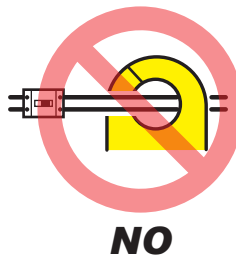

## Using the quick configuration function

The following settings will be configured with representative values according to the selected line type: synchronization source, voltage and current auto-range, measurement upper and lower limit frequencies, integration mode, rectifier, and LPF. This functionality is useful when you are using the instrument for the first time or when you need to measure lines that differ from those measured last.

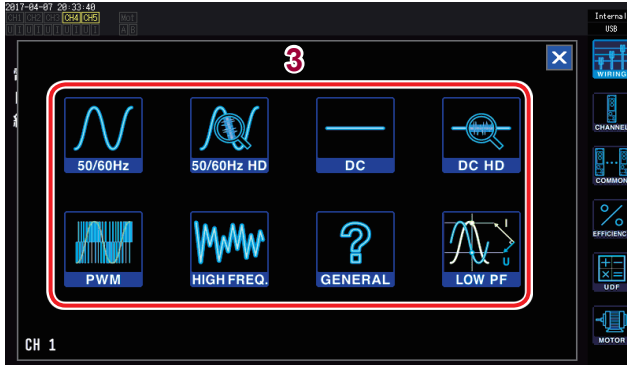

- 1 Press the **[INPUT]** key.
- 2 Touch **WIRING**.
- 3 Touch the connection diagram for the lines being measured and set the measurement line type. A confirmation dialog box will be displayed.
- 4 Confirm the settings on the confirmation dialog box.

Yes	Performs quick configuration.
No	Cancels quick configuration.

<b>50/60 Hz</b>	Use to measure a commercial power line over a broad range of frequencies.
<b>50/60 Hz HD</b>	<ul style="list-style-type: none"> <li>Use to measure a commercial power line at high definition.</li> <li>Use when measuring a line whose current level varies greatly with a single range. It is especially effective at providing higher resolution with low-level input.</li> </ul>
<b>DC</b>	<ul style="list-style-type: none"> <li>Use to measure a DC line over a broad range of frequencies.</li> <li>This setting can only be selected when using the 1P2W connection mode.</li> </ul>
<b>DC HD</b>	<ul style="list-style-type: none"> <li>Use to measure a DC line at high definition.</li> <li>Use when measuring a line whose current level varies greatly with a single range. It is especially effective at providing higher resolution with low-level input.</li> <li>Can only be selected when using the 1P2W connection mode.</li> </ul>
<b>PWM</b>	<ul style="list-style-type: none"> <li>Use to measure a PWM line.</li> <li>A fundamental frequency of 1 Hz to 1kHz is used so that it does not synchronize with the carrier frequency of 1 kHz or greater.</li> <li>It is recommended to use the sensor phase correction function to facilitate more accurate measurement.</li> </ul>
<b>HIGH FREQ.</b>	<ul style="list-style-type: none"> <li>Use to measure a high-frequency source with a frequency of at least 10 kHz.</li> <li>It is recommended to use the sensor phase correction function to facilitate more accurate measurement.</li> </ul>
<b>GENERAL</b>	<ul style="list-style-type: none"> <li>Use to measure lines other than those listed above.</li> <li>It is recommended to use the sensor phase correction function to facilitate more accurate measurement.</li> </ul>
<b>LOW PF</b>	<ul style="list-style-type: none"> <li>Use to measure the power consumption of inductive loads (at low power factors) such as transformers and inductors.</li> <li>It is recommended to use the sensor phase correction function to facilitate more accurate measurement.</li> </ul>

## Connecting the Instrument to the Measurement Lines (Zero-adjustment)

### Settings

	Synchronization source	Auto range	Upper limit frequency	Lower limit frequency	Integration mode	Rectifier (U/I)	LPF
50/60 Hz	Voltage	Auto	100 Hz	10 Hz	RMS	RMS/RMS	OFF
50/60 Hz HD	Voltage	Manual	100 Hz	10 Hz	RMS	RMS/RMS	50 kHz
DC	DC	Auto	100 Hz	10 Hz	DC	RMS/RMS	OFF
DC HD	DC	Manual	100 Hz	10 Hz	DC	RMS/RMS	5 kHz
PWM	Voltage	Auto	1 kHz	1 Hz	RMS	MEAN/RMS	OFF
HIGH FREQ.	Voltage	Auto	2 MHz	10 kHz	RMS	RMS/RMS	OFF
GENERAL	Voltage	Auto	2 MHz	0.1 Hz	RMS	RMS/RMS	OFF
LOW PF	Voltage	Auto	2 MHz	1 Hz	RMS	RMS/RMS	OFF

Check settings before starting measurement and change values as needed.

## 2.9 Verifying Proper Connections (Connection Check)

To ensure accurate measurement, it is necessary to verify that the voltage cords and current sensors are connected properly to the measurement lines. Based on the measured values and vectors, you can check whether the instrument has been connected properly.

### 1P2W connection

Verify that the measured values are shown.

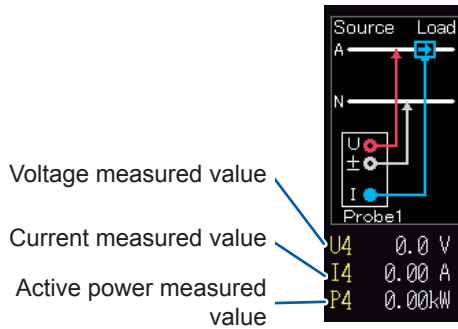

### Connection other than 1P2W

- Verify that the measured values are shown.
- Verify that the vector lines are shown within the range.

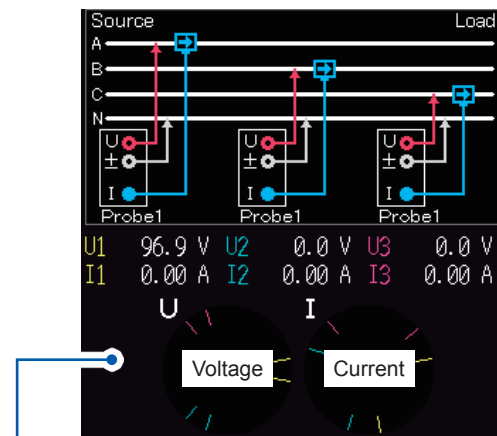

Vector line range  
 Vector lines are displayed using the same colors as the connection diagram lines.

Problem	Things to check
The voltage measured value is too high or too low.	<ul style="list-style-type: none"> <li>• Have the voltage cord connectors been inserted firmly into the instrument's voltage input terminals? (p.37)</li> <li>• Have the voltage cords been connected properly? (p.46)</li> </ul>
The current measured value is not appropriate.	<ul style="list-style-type: none"> <li>• Have the current sensor connectors been inserted firmly into the instrument's current sensor input terminals? (p.38)</li> <li>• Have the current sensors been connected properly? (p.46)</li> <li>• Does the <b>Probe1/Probe2</b> setting match the terminal into which the current sensor connector has been inserted? (p.38)</li> </ul>
The active power measured value is negative.	<ul style="list-style-type: none"> <li>• Have the voltage cords been connected properly? (p.46)</li> <li>• Have the current sensors been connected with the direction mark facing the load side?</li> </ul>
The active power is not displayed (i.e., is shown as zero).	<ul style="list-style-type: none"> <li>• Turn off the zero-suppression setting.</li> </ul>
The vector arrow is too short, or the vector lengths differ.	<p><b>Voltage vector:</b>                      Have the voltage cords been connected properly? (p.46)</p> <p><b>Current vector:</b></p> <ul style="list-style-type: none"> <li>• Have the current sensors been connected properly? (p.46)</li> <li>• Are the connected current sensors appropriate for the measurement line currents?</li> <li>• Has the <b>synchronization source</b> been set properly?</li> </ul>
The vector direction (phase) and color differ.	<ul style="list-style-type: none"> <li>• Have the voltage cords and current sensors been connected to the appropriate terminals? (See the connection diagram.)</li> </ul>

- The indication range used in vector diagrams assumes an inductive load (from a motor, etc.).
- Vectors may exceed the range when the power factor approaches 0 or when measuring a capacitive load.
- The active power P measured value for individual channels may be negative for 3P3W2M and 3V3A lines.





# 3 Viewing Measured Values

All measurement data is displayed on the Measurement screen. If the **[MEAS]** key is not lit up, press the **[MEAS]** key to activate the Measurement screen.

## 3.1 Displaying Measured Values

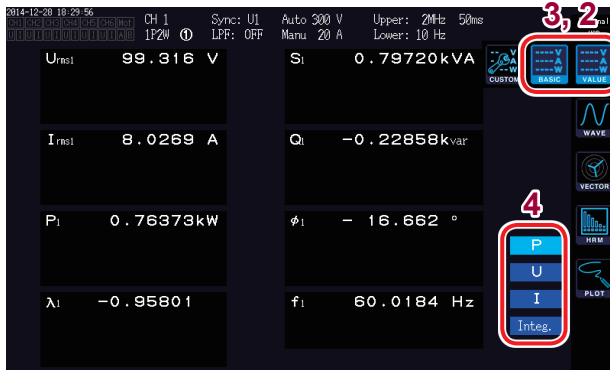

1 Press the **[MEAS]** key.

2 Touch **VALUE**.

3 Touch **BASIC**.

**CUSTOM** See "Selecting display parameters" (p.51).

4 Touch one of the screen patterns.

### Selecting display parameters

The **CUSTOM** screen allows you to select any combination of the basic measurement parameters being measured and display them on a single screen.

#### 4-parameter display

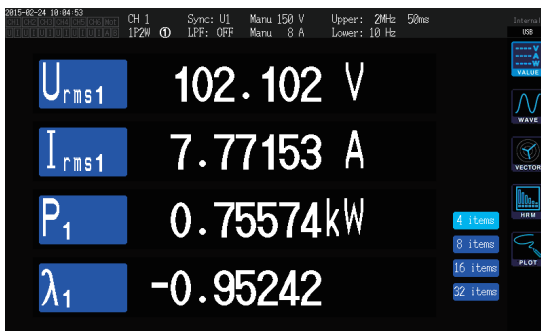

#### 8-parameter display

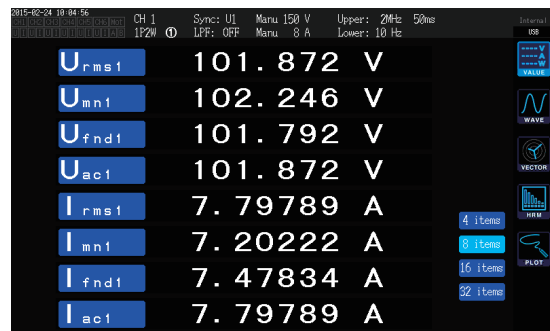

#### 16-parameter display

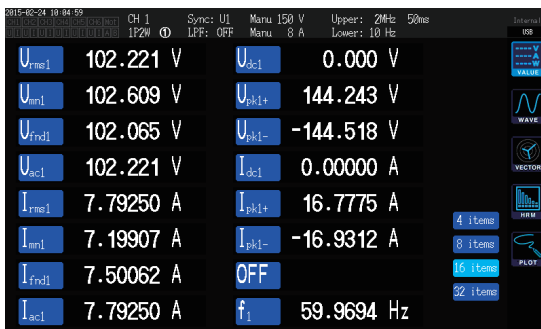

#### 32-parameter display

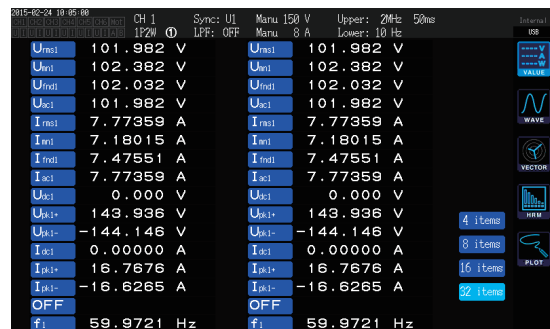

Touch the name of parameter to open the basic measurement parameter selection window. Touch to select the parameters to display.

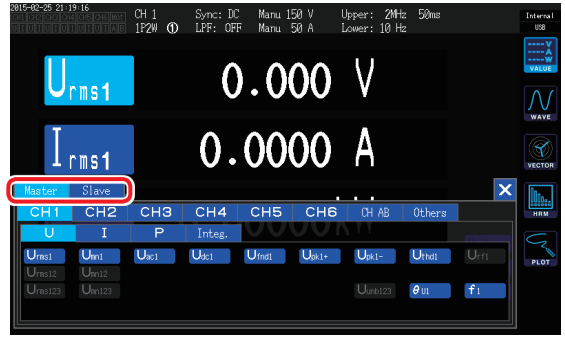
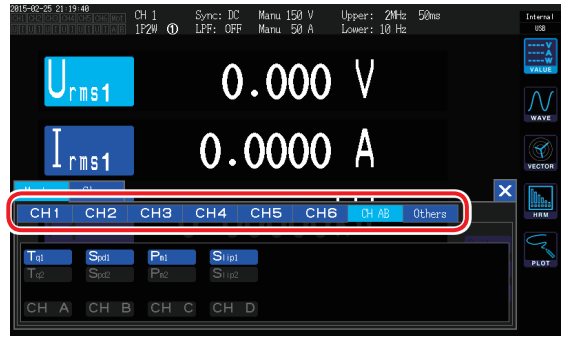
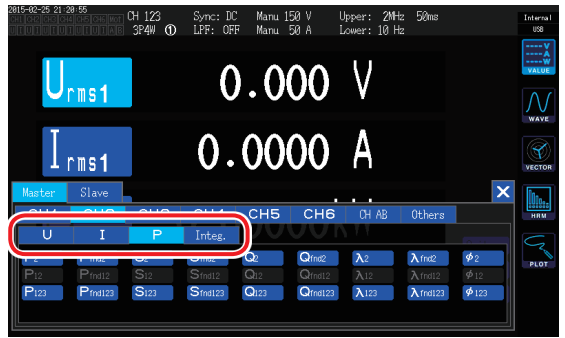
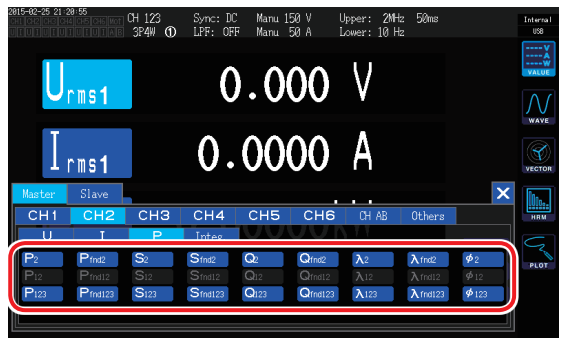
Screen	Description
	<p>1. When operating in the two-instrument synchronization function's numerical synchronization mode, selects whether to display <b>Master</b> or <b>Slave</b> first.</p>
	<p>2. Selects the channel.</p> <p>Select <b>CH AB</b> for motor analysis parameters or <b>Others</b> for parameters set as calculation formulas.</p>
	<p>3. Selects the <b>U</b>, <b>I</b>, <b>P</b>, and <b>Integ.</b> parameters for CH1 to CH6.</p>
	<p>4. Touching a parameter in the list of parameters to select it.</p> <p><b>Closing the window</b> Touch the <b>x</b> button at the top right of the window.</p>

### Effective measurement range and display range

In general, the instrument's effective measurement range (the range in which measurement accuracy is guaranteed) is 1% to 110% of the measurement range. The instrument's display range is defined as the zero-suppression range to 150% (for the 1500 V range, 100%) of the measurement range.

See "10.4 Measurement Parameter Detailed Specifications"(p.233).

Exceeding either of these ranges will trigger the following display, which indicates an over-range event.



The value display area will be left blank when **OFF** is selected as the display parameter and when the selected parameter is invalid due to the values of other settings.

Example: Selecting P123 while using the 3P4W setting and then reverting the connection mode to 1P2W so that P123 is invalid, etc.



When input of 0.5% or less of the measurement range is measured, the measured value may remain zero and not change. If you wish to display low-level measured values, set the zero-suppression setting to 0.1% or **OFF**.

See "Configuring zero-suppression"(p.58).

## 3.2 Viewing Power Measured Values and Changing Measurement Conditions

The Basic screen is used to view power measured values for each measurement line. The screen provides functionality for listing power measured values by set connection and displaying detailed measured values for voltage and current. You can change the displayed channels using the channel control keys as well as the voltage and current range.

Touch the measured value icon and select the Basic screen.

Select **P** (Power screen), **U** (Voltage screen), **I** (Current screen), or **Integ.** (Integration screen) from the screen icons.

### Displaying power measured values

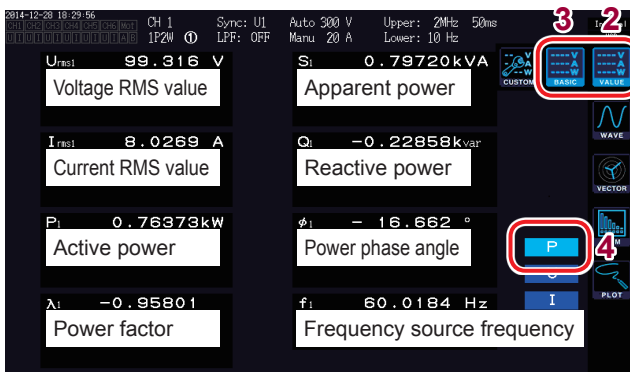

1 Press the [MEAS] key.

2 Touch VALUE.

3 Touch BASIC.

4 Touch P.

5 Switch the displayed channel using the [CH] </> keys.

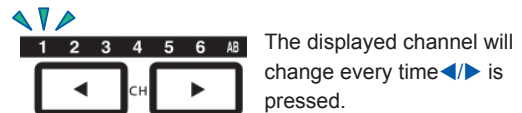

- Depending on the rectifier setting, mean value rectifier RMS equivalent values (mean values) will be displayed in the voltage RMS value (U<sub>rms</sub>) and current RMS value (I<sub>rms</sub>) display areas. See "Setting the rectifier" (p. 64).
- The polarity sign for power factor (λ), reactive power (Q), and power phase angle (φ) indicates the lead/lag polarity, with no sign indicating lag and a negative sign indicating lead.
- The polarity sign for fundamental wave power factor (λ<sub>fnd</sub>) and fundamental wave reactive power (Q<sub>fnd</sub>), which are calculated using harmonic measured values, indicates the sign of the calculation, which is the opposite of the signs of power factor (λ) and reactive power (Q) (when using the Type1 power calculation formula). See "Calculation Formula Specifications" (p. 241)
- The polarity sign for power factor, reactive power, and power phase angle may not stabilize when there is a large difference between the voltage and current levels or when the power phase angle approaches 0°.
- Active power (P), reactive power (Q), apparent power (S), and power factor (λ) are undefined for all channels when using a 3P3W2M or 3V3A connection. Use only the sum value\*.
- Measured values may be displayed for channels without input due to the effects of surrounding noise.

\* When using a connection other than 1P2W, power measured value calculated as the sum of measured values for at least two channels (for example, P123, S456, Q34, etc.).

## Displaying voltage and current

Example: Voltage

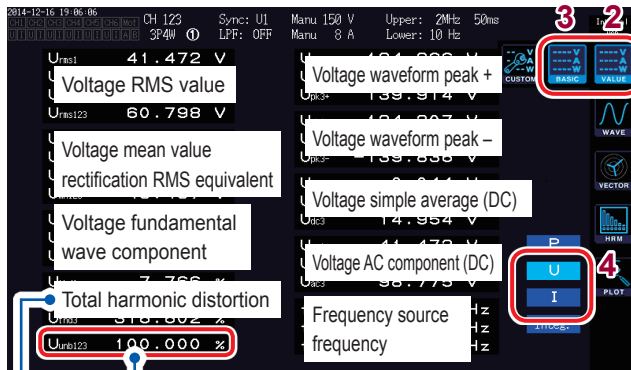

When the connection mode is 3V3A, 3P3W3M, or 3P4W, the unbalance rate  $U_{unb} / I_{unb}$  [%] will be displayed.

When DC has been selected as the integration mode, the ripple rate will be displayed instead of the total harmonic distortion.

- 1 Press the [MEAS] key.
- 2 Touch VALUE.
- 3 Touch BASIC.
- 4 Touch U (voltage) or I (current).
- 5 Switch the displayed channel using the [CH] ◀▶ keys.

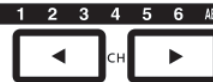

The displayed channel will change every time ◀▶ is pressed.

## Setting the ranges

Set the optimal voltage range and current range according to the measurement target's voltage and current. To ensure precise measurement, select the smallest range that is larger than the input level for both voltage and current.

### ⚠ DANGER



- If the maximum input voltage or maximum input current is exceeded, halt measurement immediately, disconnect the measurement line power supply, and disconnect the instrument from the measurement lines.
- Continuing measurement after the maximum input has been exceeded may damage the instrument and result in bodily injury.

### ⚠ WARNING



- The maximum input voltage is 1000 V  $\pm$ 2000 V<sub>peak</sub> (10 ms or less). Avoid measuring voltages in excess of this voltage as doing so may damage the instrument and result in bodily injury.
- Do not input a current in excess of the current sensor's maximum input current as doing so may damage the instrument and result in bodily injury.

## Range settings on the Measurement screen

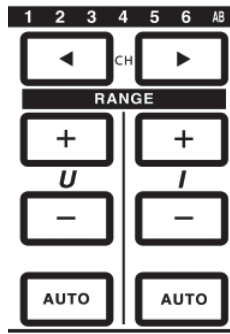

1 Select the channel you wish to change with the [CH] ◀▶ keys (it will light up).

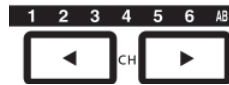

The displayed channel will change every time ◀▶ is pressed.

2 Manipulate the range with the [RANGE] key and the [AUTO] key. See “1.3 Part Names and Functions”(p.21).

## Auto range and manual range operation

The instrument provides the following two range control methods:

<b>Manual range</b> ([AUTO] key off)	Allows the operator to set the range as desired. (Press the [+] and [-] keys under [RANGE] for both voltage U and current I until the desired range is shown.)
<b>Auto range</b> ([AUTO] key lit up)	Sets the optimal voltage and current range for each connection automatically based on the input. (Press the [AUTO] keys under [RANGE].)

## Display of ranges

The voltage and current ranges are displayed in the settings indicator area at the following position on the Measurement screen at all times. The range and other information displayed are for the channel whose LED is lit up.

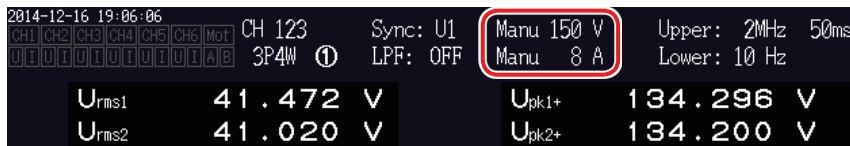

## Power range

The power range is used to measure active power P, apparent power S, and reactive power Q. The power range is determined as follows based on the voltage range, current range, and connection. See “Power range breakdown”(p.238).

Example: For active power P (same applies to S and Q)	Power range
P1/P2/P3/P4/P5/P6	Voltage range × current range
P12/P34/P45/P56	2 × voltage range × current range
P123/P456 (3V3A, 3P3W3M)	2 × voltage range × current range
P123/P456 (3P4W)	3 × voltage range × current range

## Setting the range on the Input Settings screen

When using a connection other than 1P2W that combines multiple channels, all combined channels are forced to use the same range.

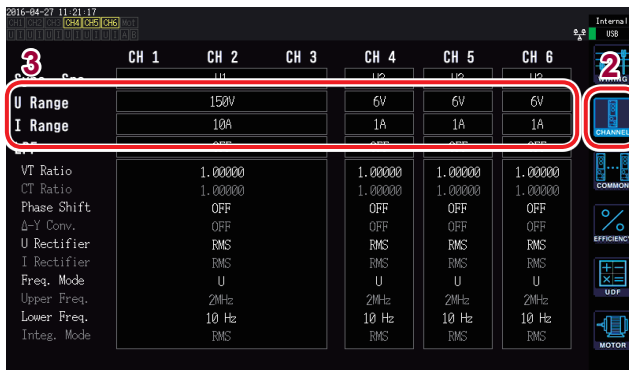

- 1 Press the [INPUT] key.
- 2 Touch CHANNEL.
- 3 Touch the connection's U Range or I Range as desired and select the desired setting.

## Auto-range breadth

This setting changes the auto-range operation pattern.

### Narrow (Default setting)

- Select when you wish to perform measurements with a high level of precision using the optimal range at all times.
- The range is increased by one if the peak value is exceeded (peak-over) for the connection or if there is an RMS value that is greater than or equal to 105% f.s.
- The range is lowered by one if all RMS values for the connection are less than 40% f.s. (However, the range is not lowered if the peak value would be exceeded with the lower range.)

### Wide

- Select when the range is switched frequently due to large fluctuations.
- The range is increased by one if the peak value is exceeded for the connection or if there is an RMS value that is greater than or equal to 110% f.s.
- The range is lowered by two if all RMS values for the connection are less than 10% f.s. (However, the range is not lowered if the peak value would be exceeded with the lower range.)

When  $\Delta$ -Y conversion is enabled, the range reduction is determined by multiplying the range by  $[1/\sqrt{3}]$  (multiplying by approximately 0.57735).

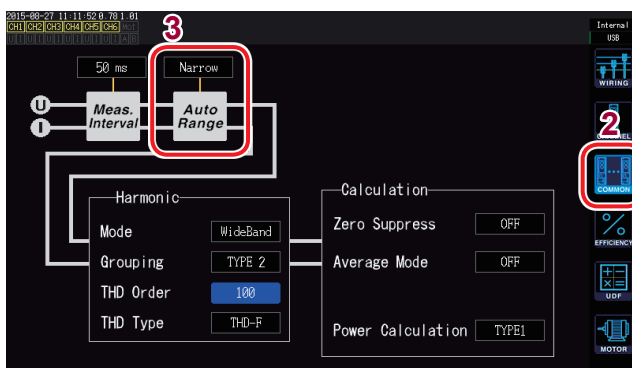

- 1 Press the [INPUT] key.
- 2 Touch COMMON.
- 3 Touch Auto Range.

- If the range continues to be switched frequently after you set the Auto-range to Wide, it is recommended to set the range manually. See "Setting the ranges"(p.55).
- When integration starts, the ranges at that point will be fixed, and auto-range operation will be canceled.

## Configuring zero-suppression

Values that are less than the set value relative to the measurement range are treated as zero. Set this setting to **OFF** if you wish to measure input that is low relative to the range.

**OFF**

Disables zero-suppression.

**0.1% f.s., 0.5% f.s.**

Treats values that are less than the set value relative to the range as zero.

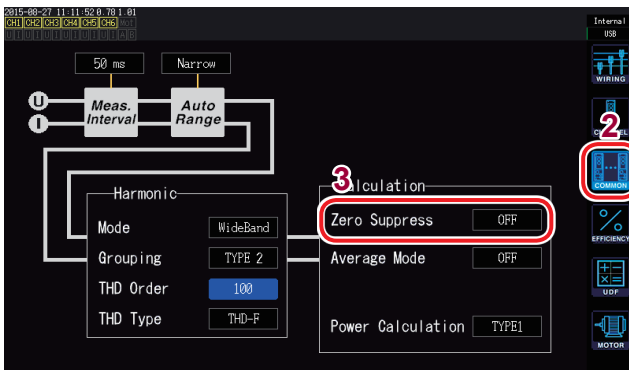

- 1 Press the **[INPUT]** key.
- 2 Touch **COMMON**.
- 3 Touch **Zero Suppress** and select the desired setting.



## Setting the data update rate

Set the interval at which to calculate measured values from the voltage and current waveforms and update measurement data.

<b>10 ms</b>	Select this setting when you wish to measure high-speed power fluctuations. Even when 10 ms is selected, harmonic analysis operates at 50 ms. When this setting is selected, you will be unable to use the two-instrument synchronization function's numerical synchronization mode. For frequencies lower than 100 Hz, an update rate that is a whole-number multiple of 10 ms may be used.
<b>50 ms (Default setting)</b>	Select this setting for general operation. It balances speed and accuracy. For frequencies lower than 20 Hz, an update rate that is a whole-number multiple of 50 ms may be used.
<b>200 ms</b>	Select this setting when large fluctuations prevent measured values from stabilizing with the 50 ms setting. Select this setting when using IEC mode during harmonic measurement. The data update rate will be approximately the same as the display update rate. For frequencies lower than 5 Hz, an update rate that is a whole-number multiple of 200 ms may be used.

Data acquired via communications functionality, analog data generated by D/A output, and data saved using the interval save function will be updated using the update interval set here.

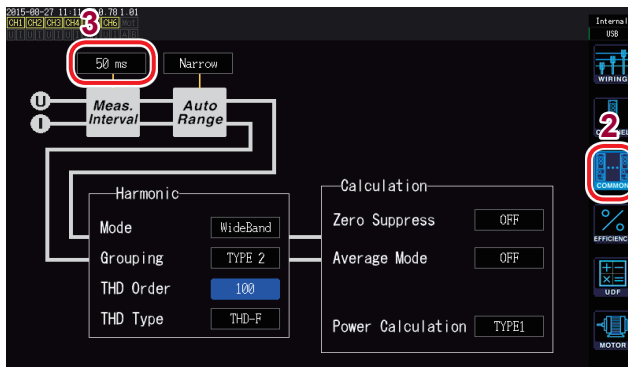

- 1 Press the [INPUT] key.
- 2 Touch **COMMON**.
- 3 Touch **Meas. Interval** to switch the setting.

- The setting cannot be changed by connection or channel.
- The display update rate is fixed at approximately 200 ms, regardless of this setting.
- If selecting 200 ms does not cause measured values to stabilize, use in combination with the averaging function.
- To obtain D/A output similar to the smooth analog output generated by the previous 3193 model, select 10 ms and use in combination with the averaging function's exponential averaging mode.

## Setting the synchronization source

This section describes how to set the source for each connection, which determines the period (zero-cross interval) that serves as the basis for various calculations. In general use, select the measurement channel's voltage for channels measuring AC current or DC for channels measuring DC current. If using the instrument to make measurements based on pulses in a motor analysis application or to measure electrical angle, select **Ext**\*<sup>1</sup>.

Select **Zph**\*<sup>2</sup> if you wish to obtain measurement results that are synchronized to one cycle of the motor's mechanical angle during motor analysis.

Select CH C or CH D\*<sup>3</sup> if you wish to perform measurement that is synchronized to an external signal (pulse input).

\*1: **Ext** can only be selected when RPM input is set to pulse and the pulse count has been set to a whole-number multiple of the number of motor pole pairs (half the motor pole number) on D/A-equipped models. Note that Ext2 can only be selected when the motor analysis operating mode is set to **Dual**. (p.84)

\*2: **Zph** can only be selected when the operating mode on a motor analysis and D/A-equipped model is set to **Single** and the CH D measurement parameter to Origin (Zph. Stands for "Z-phase").

\*3: CH C and CH D can only be selected when the operating mode on a motor analysis and D/A-equipped model is set to **Indiv**.

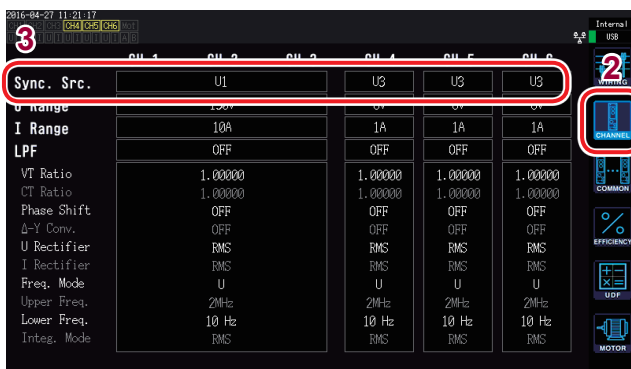

1 Press the **[INPUT]** key.

2 Touch **CHANNEL**.

3 Touch the **Sync. Src.** for the connection.

<b>Sync.Src.</b> (Synchronization source)	U1 to U6 (default setting), I1 to I6, DC, Ext1, Ext2, Zph., CH C, CH D
--	--

The set synchronization source will be displayed by the **Sync** setting indicator at the top of the Measurement screen.

- The same synchronization source will be set for each channel's voltage and current.
- The same synchronization source will be used for each channel's harmonic measurement.
- For channels measuring AC current, select input with the same frequency as the measurement channel's frequency as the synchronization source. If the frequency of the signal selected as the synchronization source differs significantly from the measurement channel's frequency, the instrument may display a frequency that differs from the input, and measured values may become unstable.
- Segments for which **DC** has been selected will be matched with the data update rate (10 ms, 50 ms, 200 ms). If AC input is measured using the **DC** setting, the display value may fluctuate, making accurate measurement impossible.
- If a frequency that is lower than the measurement lower limit frequency setting or higher than the measurement upper limit frequency setting is input as the synchronization source while the synchronization source is set to a setting other than **DC**, the instrument may display a frequency that differs from the input, and measured values may become unstable.
- Selecting Ext1 or Ext2 makes it easier to achieve synchronization when the motor's RPM varies over short periods of time, making it useful in power analysis. (p.91)
- Selecting Zph. allows you to perform harmonic analysis based on one motor revolution (one cycle of the mechanical angle).

- Since the zero-cross interval cannot be acquired when the synchronization source for a channel to which DC is being input is set to voltage or current, the instrument will operate with a synchronization frequency equivalent to approximately one period of the measurement lower limit frequency.
- Synchronization unlock may occur for frequencies lying close to the measurement lower limit frequency setting, causing measured values to become unstable.
- By inputting a pulse signal to the CH C or CH D motor analysis and D/A output option and then selecting CH C or CH D as the synchronization source, you can set the measurement timing as desired. Note that the rising edge of the input pulse is detected for both CH C and CH D.

## Synchronization unlock

Channels that cannot be synchronized to the synchronization source will experience synchronization unlock, preventing accurate measurement. Check synchronization source input. The synchronization unlock state will be indicated by a warning indicator. See “1.4 Basic Operation (Screen Display and Layout)”(p.27).

## Setting the low-pass filter (LPF)

The instrument provides a low-pass filter function to limit the frequency band. This filter can be used to eliminate frequency components and unnecessary external noise components that exceed the set frequency.

The frequencies listed below can be chosen as the low-pass filter’s cutoff frequency, which can be set independently for each connection.

<b>Frequency</b>	500 Hz, 1 kHz, 5 kHz, 10 kHz, 50 kHz, 100 kHz, 500 kHz, OFF
------------------	---

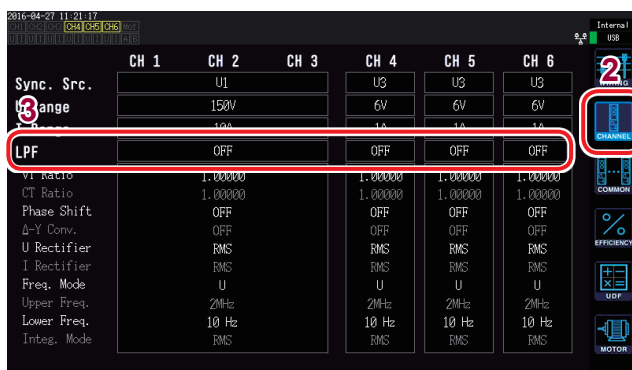

1 Press the **[INPUT]** key.

2 Touch **CHANNEL**.

3 Touch **LPF** for the connection you wish to configure and select the desired setting.

The set low-pass filter will be displayed by the **LPF** setting indicator at the top of the Measurement screen.

## Configuring frequency measurement

The instrument allows you to select **U** or **I** for each input connection in order to simultaneously measure multiple circuits' frequency values. Frequency measurement includes a measurement lower limit frequency setting and a measurement upper limit frequency setting so that you can limit the range of frequencies you wish to measure for each connection. When measuring waveforms with multiple frequency components such as a PWM waveform's fundamental frequency and carrier frequency, configure the settings based on the input frequencies you wish to measure.

### Frequency measurement display format

The position of the decimal point for frequency measured values is varied automatically as shown below based on the frequency:

- 0.10000 Hz to 9.99999 Hz, 9.9000 Hz to 99.9999 Hz, 99.000 Hz to 999.999 Hz,
- 0.99000 kHz to 9.99999 kHz, 9.900 kHz to 99.9999 kHz, 99.000 kHz to 999.999 kHz,
- 0.99000 MHz to 2.00000 MHz

### Setting the frequency source

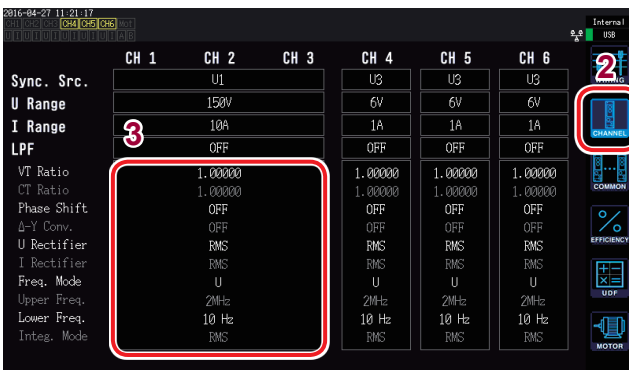

- 1 Press the **[INPUT]** key.
- 2 Touch **CHANNEL**.
- 3 Touch the channel detailed display area.

Detailed settings for each channel will be displayed.

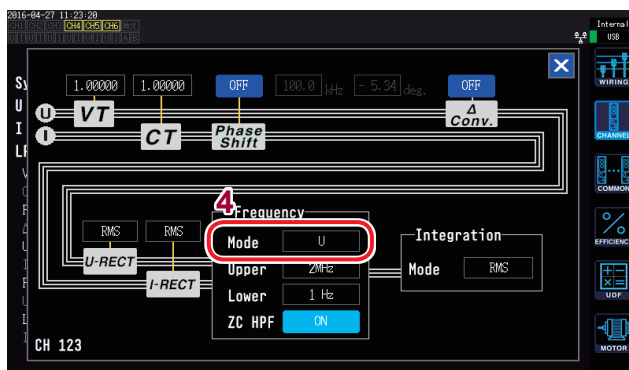

- 4 Touch **Mode** in the frequency area and select the desired setting.

## Setting the measurement upper limit frequency and the lower limit frequency

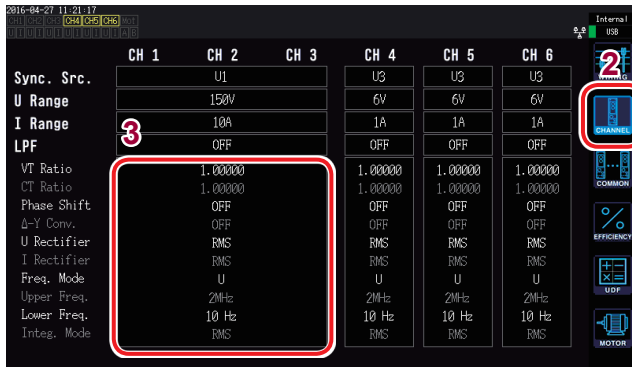

- 1 Press the **[INPUT]** key.
- 2 Touch **CHANNEL**.
- 3 Touch the channel detailed display area.  
Detailed settings for each channel will be displayed.

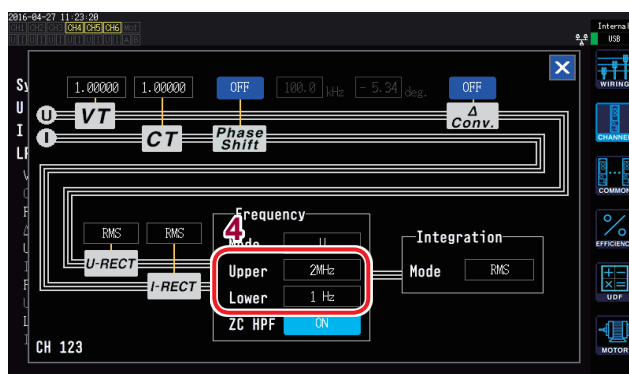

- 4 Touch **Upper** and **Lower** in the frequency area and select the desired setting.

<b>Measurement upper limit frequency (Upper)</b>	100 Hz, 500 Hz, 1 kHz, 5 kHz, 10 kHz, 50 kHz, 100 kHz, 500 kHz, 2 MHz
<b>Measurement lower limit frequency (Lower)</b>	0.1 Hz, 1 Hz, 10 Hz, 100 Hz, 1 kHz, 10 kHz, 100 kHz

- Accuracy for frequency measurement is guaranteed for sine wave input that is greater than or equal to 30% of the frequency source voltage or current measurement range. The instrument may not be able to measure input outside that range.
- When receiving input at a frequency that is lower than the data update rate setting's period, the data update rate will vary with the input frequency.
- The instrument may display a frequency that differs from the input if a frequency that is significantly higher than the measurement upper limit frequency or a frequency that is lower than the measurement lower limit frequency is input.
- If the frequency of the signal selected as the synchronization source differs significantly from the measurement channel's frequency, the instrument may display a frequency that differs from the input, and measured values may become unstable, regardless of the measurement upper limit frequency setting and the measurement lower limit frequency setting.  
See "Setting the synchronization source" (p.60).

### Zero-cross high pass filter (ZC HPF)

- This high pass filter setting is used to detect waveform zero-cross events.
- When the measurement lower limit frequency setting is **0.1 Hz** or **1 Hz**, the ZC HPF setting can be turned on or off. For other settings, it is fixed to **ON**.
- If the frequency does not stabilize while measuring low frequencies, changing this setting to **OFF** may cause the frequency to stabilize.
- Set the ZC HPF to **ON** while measuring ripple current.

## Setting the rectifier

This section describes how to select the voltage value and current value rectifiers used to calculate apparent power, reactive power, and power factor. Two rectifier settings are available and can be selected independently for each connection's voltage and current.

<b>RMS</b> (default setting)	True RMS Select this setting for ordinary use.
<b>MEAN</b>	Mean value rectification RMS equivalent In general, this setting is only used when measuring line voltage with a PWM waveform on the secondary side of an inverter.

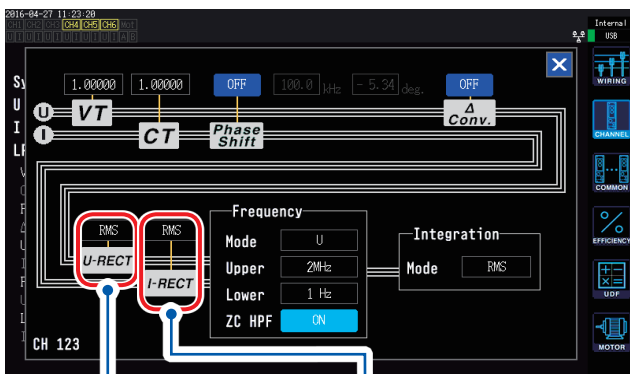

Voltage rectifier

Current rectifier

Touch **U-RECT** or **I-RECT** and select the desired rectifier.

## Configuring scaling (when using a VT [PT] or CT)

This section describes how to set the ratio (VT ratio, CT ratio) when using an external VT (PT) or CT. When a VT ratio or CT ratio has been set, **VT** or **CT** will be displayed with the setting indicators at the top of the Measurement screen.

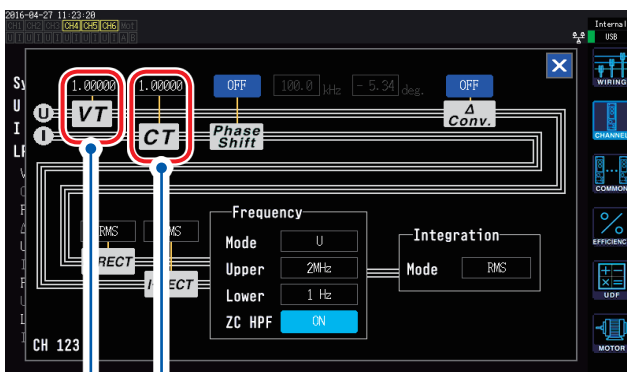

VT ratio

CT ratio

Touch **VT** or **CT** and use the “Numeric keypad windows”(p.29) to enter the desired value.

The valid input range is 0.00001 to 9999.99. The settings cannot be configured such that  $(VT \times CT)$  is greater than  $1.0E+06$ .

When a VT ratio has been set, all voltage measurement parameters, including voltage peak values, harmonics, and waveforms, and all measured values for power measurement parameters calculated using voltage will be multiplied by the set ratio.

When a CT ratio has been set, all current measurement parameters, including current peak values, harmonics, and waveforms, and all measured values for power measurement parameters calculated using current will be multiplied by the set ratio.

When set to OFF, a ratio of 1.00000 is used.

## 3.3 Viewing Integration Values

### Displaying integration values

The instrument simultaneously integrates the current (I) and active power (P) for all channels and displays positive, negative, and total values.

### Displaying integration information

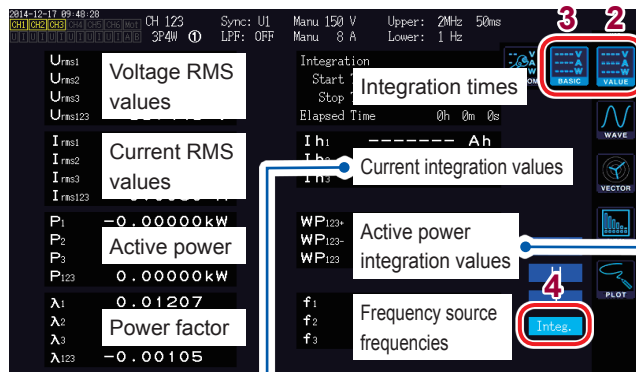

- 1 Press the [MEAS] key.
- 2 Touch VALUE.
- 3 Touch BASIC.
- 4 Touch Integ.
- 5 Switch the displayed channel using the [CH] ◀▶ keys.

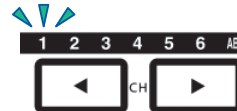

The displayed channel will change every time ◀▶ is pressed.

Ih1+	Positive-direction current integration value for CH1*
Ih1-	Negative-direction current integration value for CH1*
Ih1	Total current integration value for CH1

WP1+	Positive-direction active power integration value for CH1
WP1-	Negative-direction active power integration value for CH1
WP1	Total active power integration value for CH1

\*Displayed only when the integration mode is set to DC.

- The parameters that can be integrated vary with the connection mode and the integration mode. See "Setting the Connection Mode and Current Sensors"(p.43) and "Setting the integration mode"(p.68).
- This information can also be selected and displayed on the **CUSTOM** screen. See "Displaying Measured Values"(p.51).

### Before starting integration

- 1 **Set the time.**  
See "Set the time" (p. 137).
- 2 **Set the integration mode.**  
See "Setting the integration mode"(p.68).
- 3 **Set the necessary control times (interval time, timer time, and actual time control time).**  
See "Performing integration while using the time control function"(p.70).  
Set the time settings to OFF when performing integration manually or with an external signal.
- 4 **When saving data to a USB flash drive or the instrument's internal memory or generating D/A output, configure associated settings.**  
See "Formatting a USB flash drive"(p.158) and "8.2 Using D/A Output (Motor Analysis and D/A-equipped Models Only) (Analog and Waveform Output)"(p.175).

## Starting and stopping integration and resetting integration values

These operations can be performed using the instrument's control keys, external signals, or communications.

Always reset integration values when changing settings.

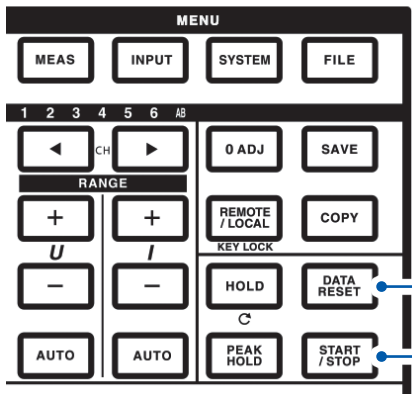

When integration is in the stopped state (the **[START/STOP]** key will be red), pressing the **[DATA RESET]** key will cause integration values to be reset.

Start integration:	Press once. The key will turn green.
Stop integration*:	Press again. The key will turn red.

\*When using the timer control or actual-time control settings, integration will stop automatically at the set end time.



**Precautions when starting and stopping integration and resetting integration values**

- Control using LAN communications can be performed using the same procedure on the remote control application window.  
See “9 Connecting the Instrument to a Computer”(p.191).
- Integration will stop automatically when the integration time reaches its maximum value of 9999 hr. 59 min. 59 sec.
- Starting and stopping of integration and resetting of integration values performed using the instrument’s control keys or external control apply to all parameters being integrated.
- The following parameters can be integrated depending on the connection mode and integration mode:

Mode	Parameters that can be integrated
1P2W, DC mode	Ih+, Ih-, Ih, WP+, WP-, WP
1P2W	Ih, WP+, WP-, WP
1P3W, 3P3W (When using CH1, CH2)	Ih1, Ih2, WP12+, WP12-, WP12
3V3A, 3P3W3M, 3P4W (When using CH1, CH2, CH3)	Ih1, Ih2, Ih3, WP123+, WP123-, WP123

- Integration of each channel’s calculation results is timed based on the data update rate. Consequently, integration values may differ from those of an instrument whose response speed, sampling speed, or calculation methods differ.
- When integration begins, parameters that are set to the auto range are fixed to the range at that point in time. Set ranges as desired so that an over-range event does not occur.
- In current integration, the instantaneous current is integrated when the integration mode is DC mode, and RMS values are integrated when the integration mode is RMS mode.
- In power integration, the instantaneous power is integrated when the integration mode is DC mode, and active power is integrated when the integration mode is RMS mode.
- While integration is being performed (including when the instrument is in standby mode during actual time control integration), the instrument will not accept any settings changes other than screen changes and hold/peak hold function operation.
- Although the display is held during hold operation, integration operation continues internally. However, D/A output consists of display data.
- The integration display is not affected by peak hold operation.
- If a power outage occurs while integration is being performed, integration values will be reset, and integration operation will stop.

## Setting the integration mode

This section describes how to set the integration mode for each channel. The following two integration modes are available and can be selected separately for each connection.

### DC mode

- Integrates instantaneous current values and instantaneous power values by polarity for each sampling period.
- Can be selected only when the connection mode is 1P2W.
- Integrates six parameters for current (Ih+, Ih-, Ih) and active power (WP+, WP-, WP) simultaneously.

### RMS mode

- Integrates current RMS values and active power values for each data update rate interval.
- Only active power is integrated by polarity.

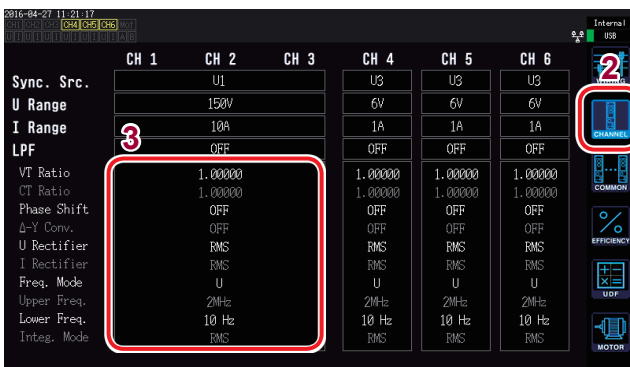

- 1 Press the **[INPUT]** key.
- 2 Touch **CHANNEL**.
- 3 Touch the channel detailed display area.  
Detailed settings for each channel will be displayed.
- 4 Touch the **Integration** setting and select the desired mode.

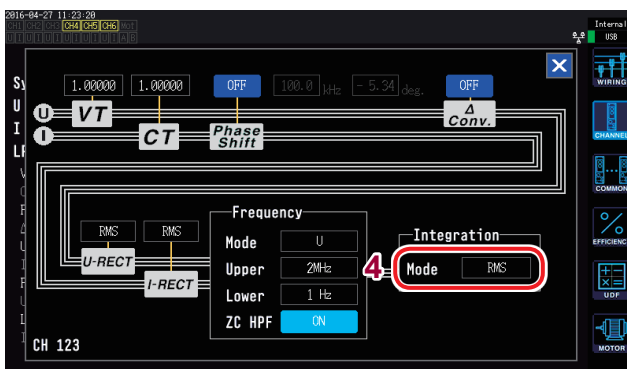

## Using manual integration

This section describes how to start and stop integration manually.

### Manual integration operation

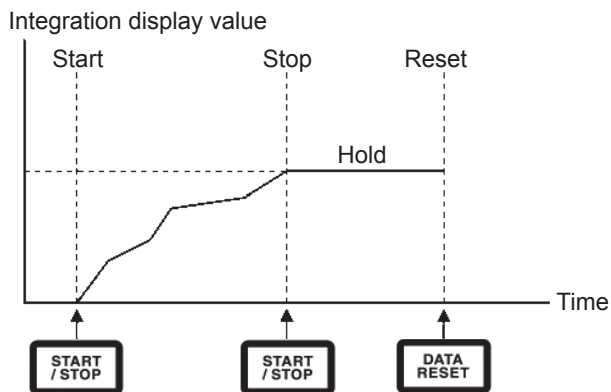

### Cumulative integration operation

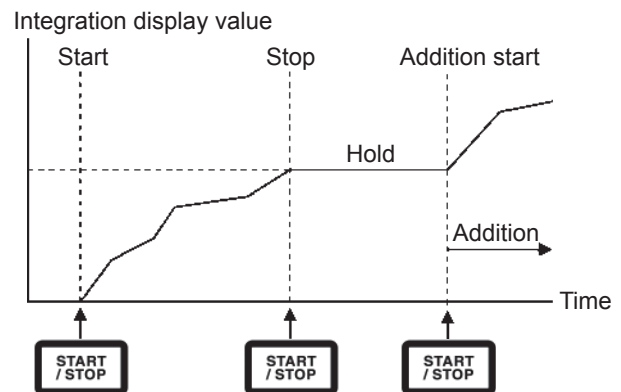

### Before starting integration

Set the interval time, timer time, and actual time control to **OFF**.

See “Performing integration while using the time control function”(p.70).

### Starting integration

Press the **[START/STOP]** key.

The **[START/STOP]** key will turn green, and the **Integ.** indicator at the top of the screen will turn green to indicate that integration is being performed.

### Stopping integration

Press the **[START/STOP]** key again.

The **[START/STOP]** key will turn red, and the **Integ.** indicator at the top of the screen will turn red.

### Performing cumulative integration (integration by adding values to previous integration values)

Press the **[START/STOP]** key again.

The **[START/STOP]** key will turn green, and the **Integ.** indicator at the top of the screen will turn green.

### Resetting integration values

Stop integration and press the **[DATA RESET]** key.

## Performing integration while using the time control function

If you set the timer time and actual time control time in advance and then press the **[START/STOP]** key, you can start and stop integration at the set times.

The following three time settings can be used to control integration:

### Manual integration setting

Start integration	Press the <b>[START/STOP]</b> key.
Stop integration	Press the <b>[START/STOP]</b> key again.

See “Using manual integration”(p.69).

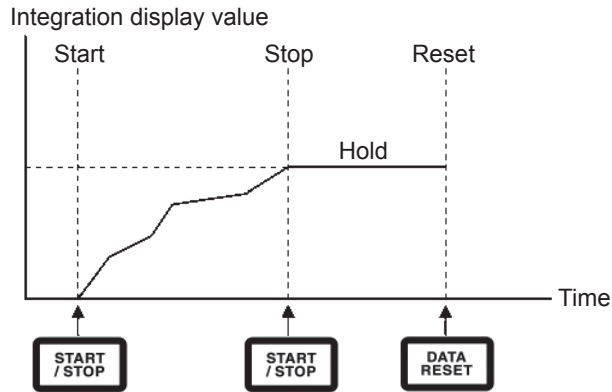

### Timer integration setting

Start integration	Press the <b>[START/STOP]</b> key.
Stop integration	Integration will stop automatically once values have been integrated for the set timer time.

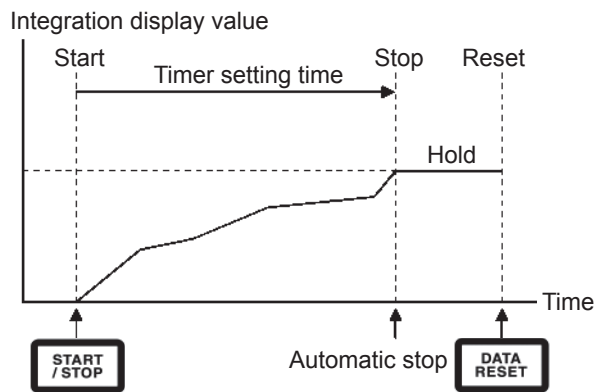

### Actual time control integration setting

Start integration, stop integration	Press the <b>[START/STOP]</b> key places the instrument in the standby state. Integration will then start and stop at the set start time and stop time. To stop integration while the instrument is in the standby state, press the <b>[START/STOP]</b> key again.
-------------------------------------	--

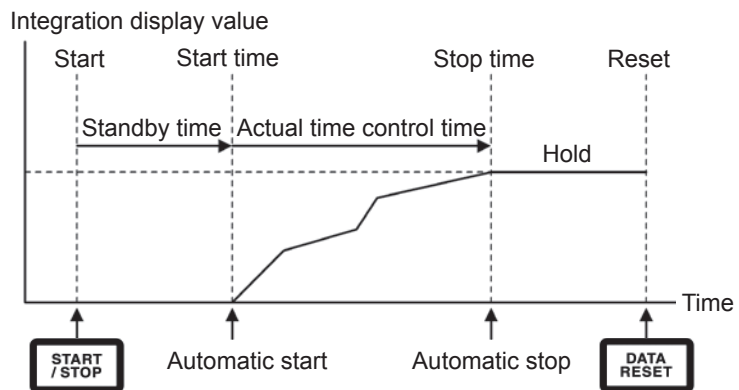

#### Operation in the hold state or peak hold state

- When an interval time has been set, the display will be updated at the set interval time.
- When a timer time or actual time control time has been set, the instrument will display the final data once the set time has elapsed.

## 3.4 Viewing Harmonic Measured Values

The instrument includes harmonic measurement functionality as a standard feature and can provide harmonic measured values that are synchronous with power measured values for all channels. These harmonic measured values are used to calculate the fundamental wave component (fnd value) and total harmonic distortion (THD), which are included in the instrument's basic measurement parameters. See "10.5 Calculation Formula Specifications"(p.241).

### Displaying harmonics

Harmonics can be displayed using a bar graph, list, or vectors.

#### Displaying a harmonics bar graph

Harmonic analysis is performed on the voltage, current, and active power values for the same channel, and the results are displayed as a bar graph. Numerical data for the display order is also displayed at the same time.

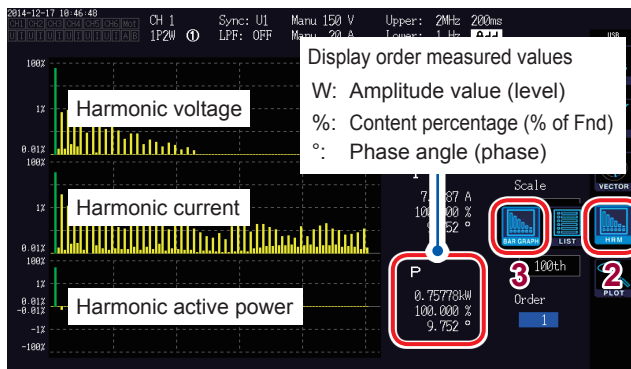

- 1 Press the **[MEAS]** key.
- 2 Touch **HRM**.
- 3 Touch **BAR GRAPH**.
- 4 Switch the displayed channel using the **[CH] </>** keys.

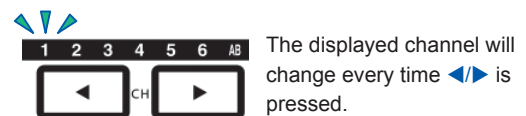

- The vertical axis scale is displayed as a percentage of the range when the amplitude value is selected.
- When the phase angle is selected, a gray bar may be displayed to indicate that the corresponding amplitude value is small (0.01% or less of the range).

#### Changing the display settings and display order

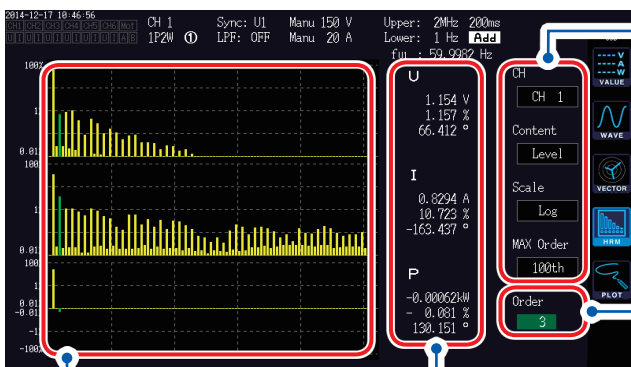

Changing the display settings  
Touch each setting and change it as desired.

Changing the display order  
Touching the order value will cause the Y rotary knob (vertical axis display position setting) to turn green.

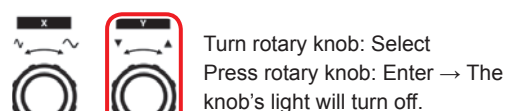

Measured values for the selected order are displayed here.

The bar graph for the selected order will turn green.

## Displaying a harmonics list

This section describes how to display the results of harmonic analysis as a numerical list for each parameter.

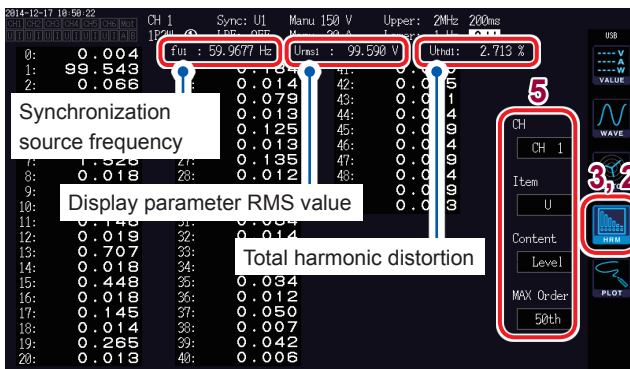

- 1 Press the **[MEAS]** key.
- 2 Touch **HRM**.
- 3 Touch **LIST**.
- 4 Switch the displayed channel using the **[CH]** **◀▶** keys.

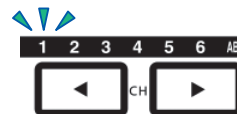

The displayed channel will change every time **◀▶** is pressed.

- 5 Touch a parameter to select it.

The same settings apply to the bar graph screen and the list screen.

Display setting	Settings	Description						
<b>CH</b>	Example: For a 3P4W connection CH1, CH2, CH3, CH123	Changes the display channel within the same connection. To display a different connection, switch the channel lit up on the channel display LED shown by <b>CH</b> .						
<b>Item</b>	<table border="1"> <tr> <td>U</td> <td>Voltage</td> </tr> <tr> <td>I</td> <td>Current</td> </tr> <tr> <td>P</td> <td>Active power</td> </tr> </table>	U	Voltage	I	Current	P	Active power	Changes the displayed measurement parameter (list only). If a SUM value such as CH123 has been selected with the CH setting, only the <b>P</b> setting will be available to select.
U	Voltage							
I	Current							
P	Active power							
<b>Content</b>	<table border="1"> <tr> <td>Level</td> <td>Amplitude value</td> </tr> <tr> <td>% of Fnd</td> <td>Content percentage</td> </tr> <tr> <td>Phase</td> <td>Phase angle</td> </tr> </table>	Level	Amplitude value	% of Fnd	Content percentage	Phase	Phase angle	Changes the displayed content. The phase angle for harmonic active power refers to the harmonic voltage/current phase difference.
Level	Amplitude value							
% of Fnd	Content percentage							
Phase	Phase angle							
<b>Scale</b>	<table border="1"> <tr> <td>Log</td> <td>Logarithmic display</td> </tr> <tr> <td>Linear</td> <td>Linear display</td> </tr> </table> <p>(Can be displayed down to small levels.)</p>	Log	Logarithmic display	Linear	Linear display	Changes the vertical axis display (bar graph only). Only <b>Linear</b> can be selected when the display content is set to phase angle.		
Log	Logarithmic display							
Linear	Linear display							
<b>MAX Order</b>	25th, 50th, 100th	Changes the maximum display order. The instrument may not be able to display data up to the set maximum order depending on the synchronization frequency being measured. See "Maximum analysis order and the window wave number" (p.215).						

## Displaying harmonic vectors

This section describes how to display the voltage, current, and phase angle for each harmonic order as a vector graph.

<b>VECTOR1</b>	Displays vectors for all channels on a single vector graph.
<b>VECTOR2</b>	Displays the graphs for the selected connections on two vector graphs.

### VECTOR1 display

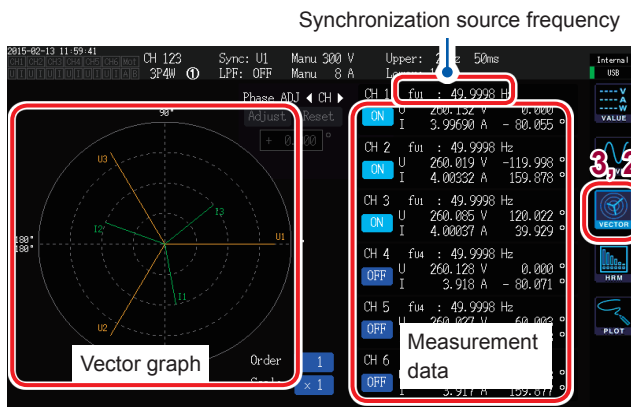

- 1 Press the **[MEAS]** key.
- 2 Touch **VECTOR**.
- 3 Touch **VECTOR1**.

3

Viewing Measured Values

### Changing the display settings

Touch the channel you wish to display to toggle it on and off.



#### Changing the display order

Touching the Order value will cause the Y rotary knob (vertical axis display position setting) to turn green. The order can be changed with the rotary knob.

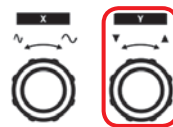

Turn rotary knob: Select  
Press rotary knob: Enter → The knob's light will turn off.

#### Changing the zoom factor

Touching the scale value will cause the Y rotary knob (vertical axis display position setting) to turn green. Change the zoom factor with the rotary knob.

When the display order (Order) is a value other than 1, the display area will turn red to indicate that the vector being displayed is not the fundamental wave vector.

### VECTOR2 display

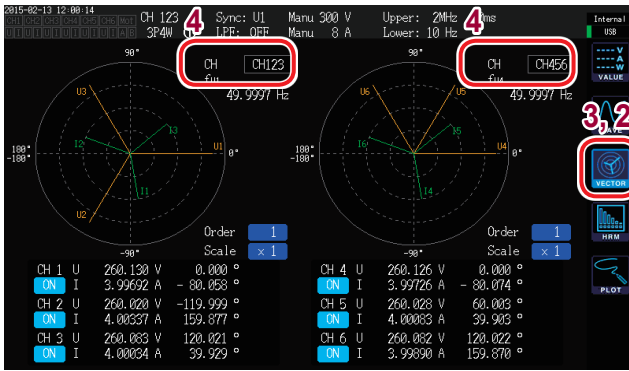

- 1 Press the **[MEAS]** key.
- 2 Touch **VECTOR**.
- 3 Touch **VECTOR2**.
- 4 Set the connections whose vectors you wish to display on the left and right graphs.

### Setting the harmonic measurement mode

The following two harmonic measurement modes are available:

#### IEC

- This mode is the IEC standard mode.
- When the measurement line's frequency is 50 Hz or 60 Hz, harmonic measurement complies with the IEC 61000-4-7:2002 standard.
- Even when the data update rate setting is 10 ms or 50 ms, harmonic measured values will be updated at a 200 ms interval.
- Harmonic measurement will not be performed if the frequency being measured falls outside the range of 45 Hz to 66 Hz.
- Analysis can be performed up to the 50th order.

#### WideBand (Default setting)

- This mode is the wideband mode.
- It can be used with a wide range of frequencies from 0.1 Hz to 300 kHz.
- The analysis order varies with the frequency being measured.
- When the data update rate is 10 ms, harmonic measured values will be updated at a 50 ms interval.

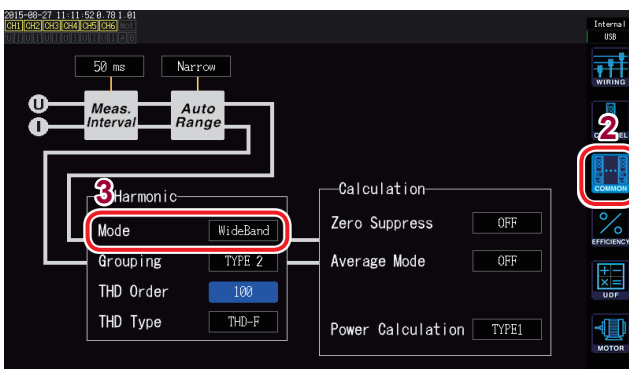

- 1 Press the **[INPUT]** key.
- 2 Touch **COMMON**.
- 3 Touch **Mode** under **Harmonic** and select the desired measurement mode.

- This setting cannot be changed by connection or channel.
- The harmonic synchronization source is the same as the synchronization source used to measure power for the same connection.
- Accurate harmonic measurement is not possible when the frequency of the input signal set as the synchronization source fluctuates or when the input signal exhibits a low level relative to the range.



## Setting the THD calculation method

This section describes how to set the total harmonic distortion (THD) calculation method. You can select whether to use the THD-F or THD-R method as well as the maximum order to which to calculate THD. This setting is valid for all voltage and current harmonic measurement for all channels.

### THD calculation method

<b>THD-F (Default setting)</b>	Ratio of the total harmonic component to the fundamental wave This setting is typically used in applications such as IEC standard-compliant measurement.
<b>THD-R</b>	Ratio of the total harmonic component to the total harmonic component including the fundamental wave This setting yields a lower value than THD-F for waveforms with a large amount of distortion.

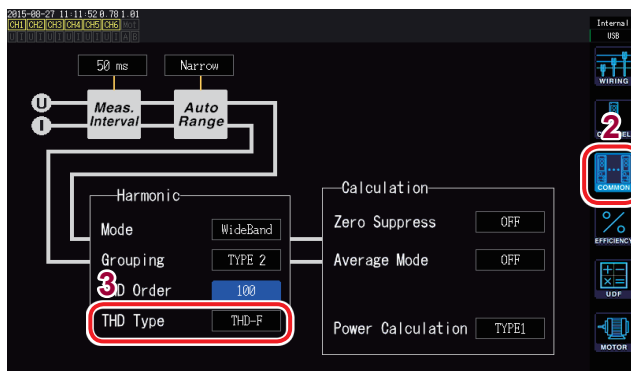

- 1 Press the [INPUT] key.
- 2 Touch **COMMON**.
- 3 Touch **THD Type** and select the desired method.

#### What is THD?

Total harmonic distortion is a measurement of the amount of harmonic distortion in a signal.

## THD calculation order

This section describes how to set the upper limit order to which to calculate the total harmonic component.

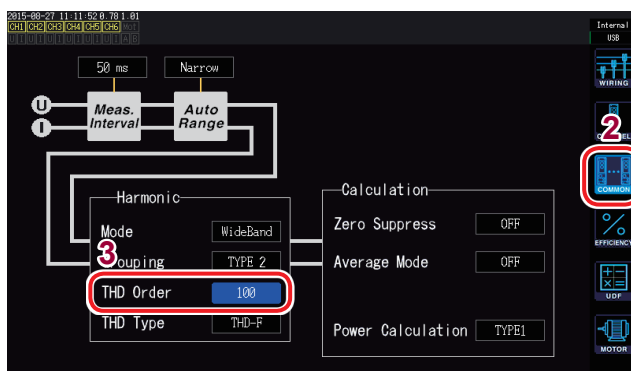

- 1 Press the [INPUT] key.
- 2 Touch **COMMON**.
- 3 Touch [THD order] and change the setting using the rotary knob (from 2nd order to 100th order).

Touching the order value will cause the Y rotary knob (vertical axis display position setting) to turn green.

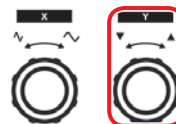

Turn rotary knob: Select  
Press rotary knob: Enter →  
The knob's light will turn off.

- If the analysis order does not reach the set upper limit value due to the harmonic measurement mode and fundamental frequency, the calculation will be performed using the analysis order as the upper limit.
- Harmonic measurement values displayed in list and graph form and harmonic measured values obtained via the instrument's communications functionality are not constrained by the upper limit order set here.

## Setting the grouping method

This section describes how to set the intermediate harmonic calculation method for harmonic measured values.

<b>OFF</b>	Treats only whole-number multiples of the fundamental wave as the harmonic for the order in question.
<b>TYPE1 (Default setting)</b>	Treats the harmonic sub-group as the harmonic for the order in question. This setting provides compatibility with the Hioki PW3198's harmonic measurement functionality.
<b>TYPE2</b>	Treats the harmonic group as the harmonic for the order in question.

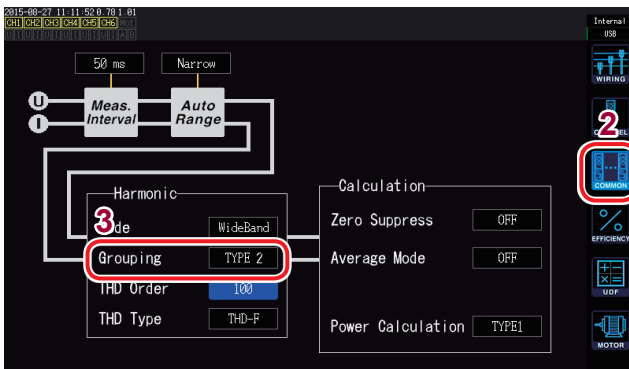

- 1 Press the **[INPUT]** key.
- 2 Touch **COMMON**.
- 3 Touch **Grouping** and select the desired calculation method.

### What is grouping?

In harmonic measurement, the window wave number is determined based on the harmonic mode and the fundamental wave frequency. When the window wave number is a value other than 1, there is a spectrum line (output bin) for a number (window wave number - 1) that is proportional to the window wave number in the harmonic component that is a whole-number multiple ( $n$  multiple) of the fundamental wave, and that is known as the intermediate harmonic (inter-order harmonic). Since measured values yielded by harmonic measurement differ depending on how this intermediate harmonic is treated, IEC and other standards define grouping rules.

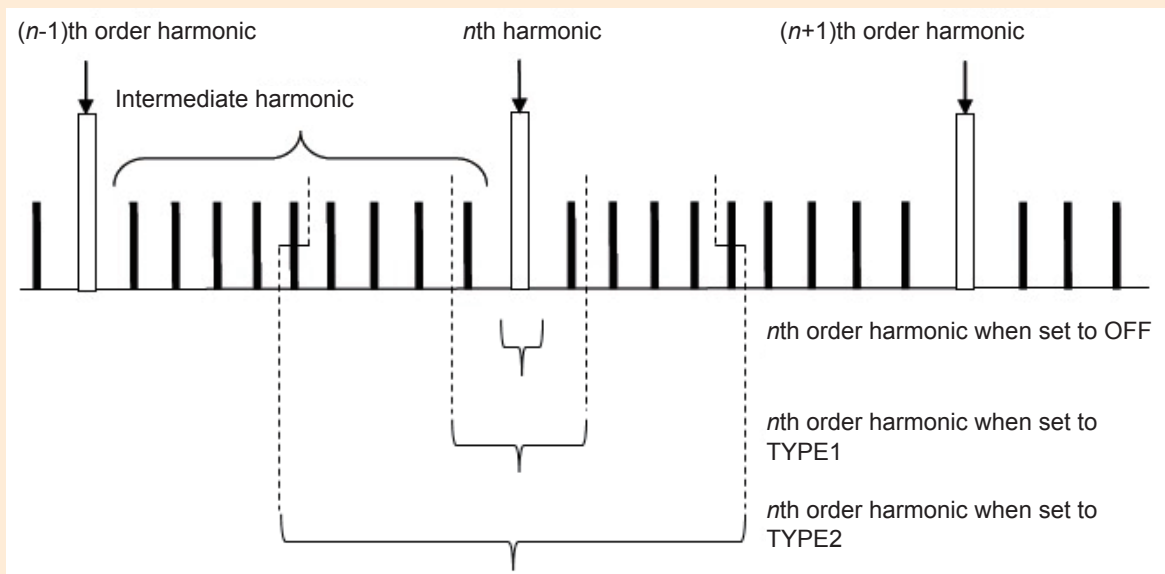

In general, the TYPE1 range is known as the harmonic sub-group, and the TYPE2 range is known as the harmonic group. The output pin within the range can be calculated by means of the average-of-squares method. If no intermediate harmonic exists, or the window wave number is 1 in wideband mode, measured values will agree regardless of what grouping method has been chosen. If an intermediate harmonic exists, harmonic measured values will generally exhibit the following relationship to this setting:  
 $OFF < TYPE1 < TYPE2$

## 3.5 Viewing Measured Values for Power Factor and Loss

The instrument can calculate and display efficiency  $\eta$  [%] and loss [W] using active power values and motor power values. For example, a single instrument can simultaneously calculate efficiency and loss across the input and output sides of a power conversion device such as an inverter or power conditioner, or the efficiency, loss, and total efficiency across a motor's inputs and outputs. Alternatively, the two-instrument synchronization function can be used to allow the master instrument to calculate the efficiency and loss for the slave instrument's power measured values.

### Displaying efficiency and loss



- 1 Press the [MEAS] key.
- 2 Touch VALUE.
- 3 Touch CUSTOM.
- 4 Select the screen pattern.

3

Viewing Measured Values

### Selecting basic measurement parameters

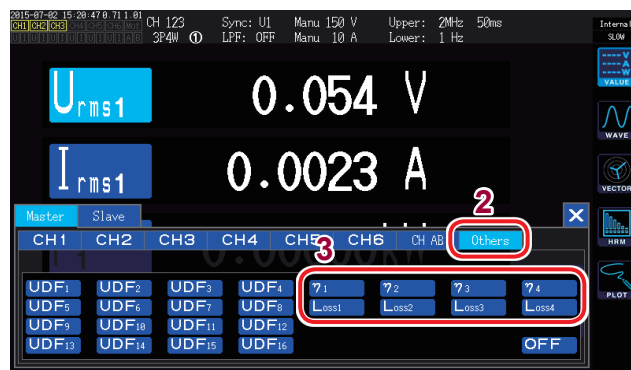

- 1 Touch the parameter name and select the desired display parameter.  
The basic measurement parameter selection window will open.  
  
When using the two-instrument synchronization function's value synchronization mode, first select whether the parameter will be measured using the master instrument or the slave instrument.
- 2 Touch Others.
- 3 Select one of  $\eta_1$  to  $\eta_4$  (efficiency) or Loss1 to Loss4 (loss).

## Setting the calculation formulas for efficiency and loss

This section describes how to set one formula each for calculating efficiency ( $\eta 1$  to  $\eta 4$ ) and loss (**Loss1** to **Loss4**).

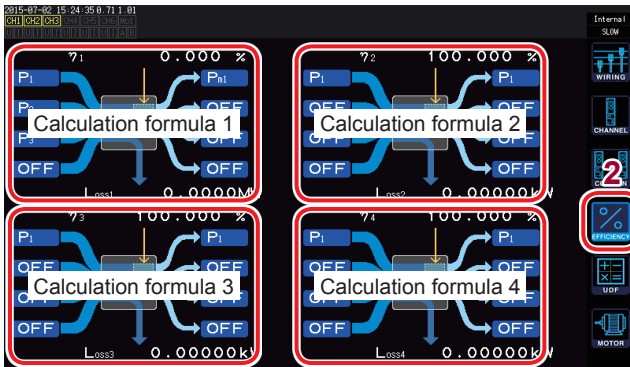

- 1 Press the **[INPUT]** key.
- 2 Touch **EFFICIENCY**.
- 3 Select the input and output parameters for the calculation formula.

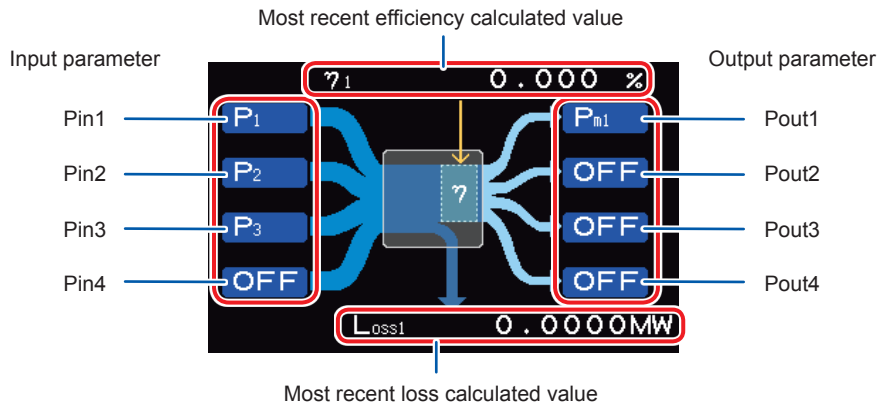

Select the input-side power measured value on the left and the output-side power measured value on the right for each figure on the screen. Up to four inputs and outputs can be selected for each efficiency calculation formula. Efficiency is calculated using the sum of the four.

$$\text{Input side: } P_{in} = P_{in1} + P_{in2} + P_{in3} + P_{in4}$$

$$\text{Output side: } P_{out} = P_{out1} + P_{out2} + P_{out3} + P_{out4}$$

$$\eta: 100 \times |P_{out}| / |P_{in}|$$

$$\text{Loss: } |P_{in}| - |P_{out}|$$

- Motor power ( $P_m$ ) measurement can only be selected on motor analysis and D/A-equipped models. Motor analysis and D/A-equipped models without power ( $P_m$ ) measurement cannot perform this calculation. See “Setting motor input”(p.84).
- Measured values may exhibit variations when measuring loads characterized by severe fluctuation or transient variations. In this case, reduce the data update rate (to 200 ms) and combine with the averaging function’s simple averaging mode.
- When either the input or output is DC, variation in efficiency measured values can be limited by using the same synchronization source setting for the channel used for DC measurement as for the AC side.
- Calculations across connections with different power ranges are performed using data for the larger of the two power ranges.
- Calculations across connections with different synchronization sources are performed using the most recent data at the time of calculation.

## Example measurements

This section illustrates some example efficiency and loss measurements. When performing actual measurements, read “2 Preparing for Measurement”(p.35) before connecting and configuring the instrument.

### Measuring the efficiency and loss of a power conditioner (PCS)

Example: Inputs 3 DC channels from 3 solar panel strings and outputs power to a 3-phase line

#### Connection example

You will need

- L9438-50 Voltage Cord × 6
- CT6863 AC/DC Current Sensor × 6

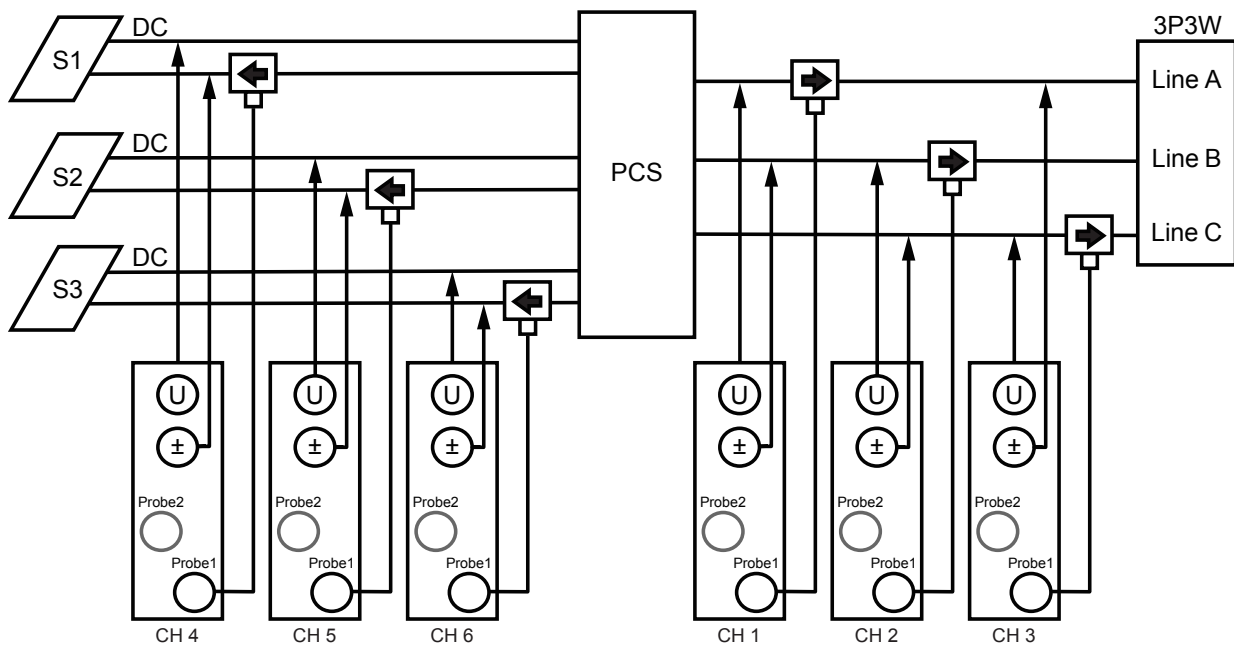

#### Connection settings

	CH 1	CH 2	CH 3	CH 4	CH 5	CH 6
Sync. Src.	U1			DC	DC	DC
U Range	600V			600V	600V	600V
I Range	200A			200A	200A	200A
LPF	OFF			OFF	OFF	OFF
VT Ratio	1.00000			1.00000	1.00000	1.00000
CT Ratio	1.00000			1.00000	1.00000	1.00000
Phase Shift	ON			OFF	OFF	OFF
Δ-Y Conv.	ON			OFF	OFF	OFF
U Rectifier	RMS			RMS	RMS	RMS
I Rectifier	RMS			RMS	RMS	RMS
Freq. Mode	U			U	U	U
Upper Freq.	100 Hz			100 Hz	100 Hz	100 Hz
Lower Freq.	10 Hz			10 Hz	10 Hz	10 Hz
Integ. Mode	RMS			DC	DC	DC

Connection pattern: Pattern 5  
3P3W3M + 1P2W × 3CH

**Calculation formula settings**

Use only  $\eta_1$  and Loss1.

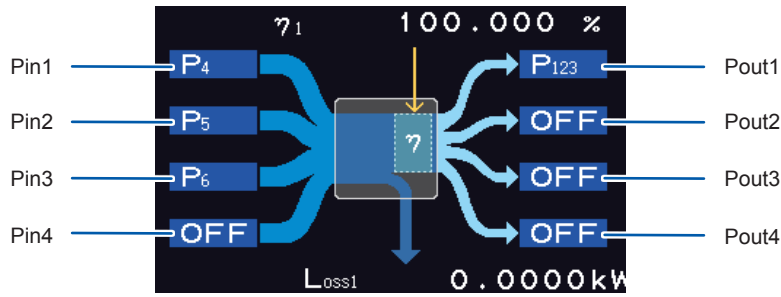

**Measuring the efficiency and loss of an inverter device and motor**

Example: When inputting the input side of an inverter to the instrument’s CH1 to CH3, the output side of the inverter to the instrument’s CH4 to CH6, analog output from a tachometer to the instrument’s CH B rotation signal terminal, and analog output from a torque meter to the instrument’s CH A torque signal input terminal

See “8.3 Using Motor Analysis (Motor Analysis and D/A-equipped Models Only)”(p. 184).

Use a torque meter and tachometer with extremely fast analog output response times.

**Connection example**

You will need (assuming use of a motor analysis and D/A-equipped model)

- L9438-50 Voltage Cord × 6
- 9709 AC/DC Current Sensor × 6
- Tachometer × 1
- Torque meter × 1
- L9217 Connection Cord × 2

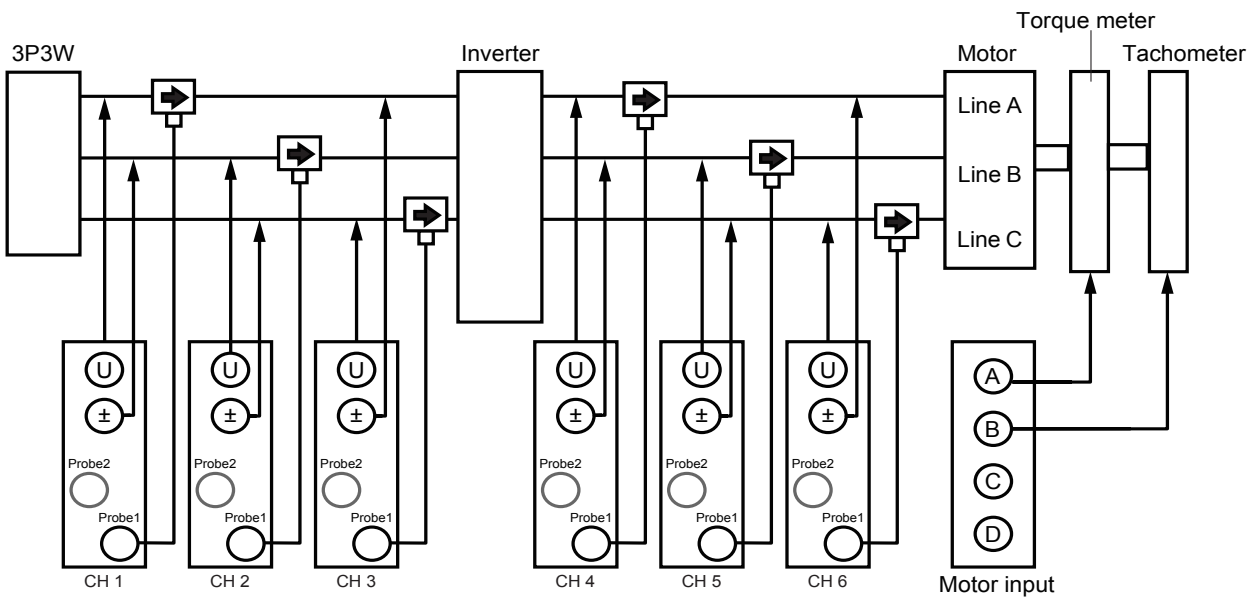

### Connection mode settings

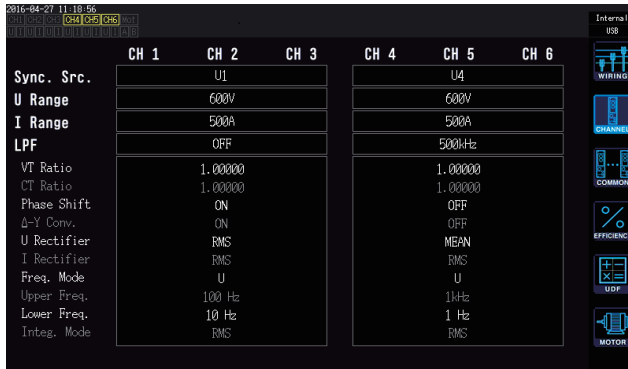

Connection pattern: Pattern 7  
3P3W3M × 2 circuits

### Calculation formula settings

Use  $\eta_1$  to  $\eta_3$  and  $L_{loss1}$  to  $L_{loss3}$ .

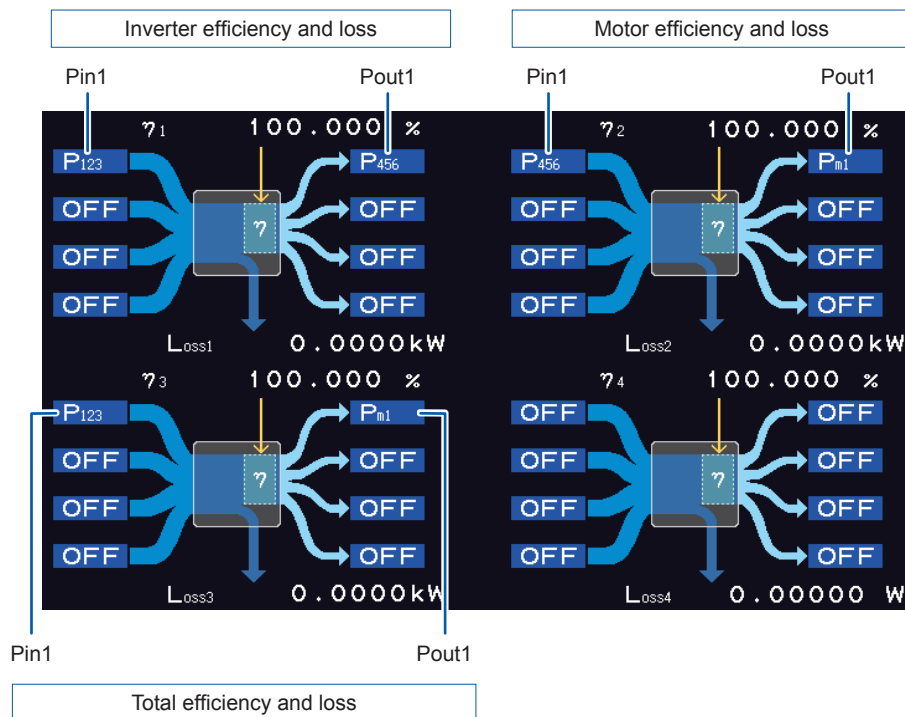

## 3.6 Viewing Motor Measured Values (Motor Analysis and D/A-equipped Models)

Motor analysis and D/A-equipped models of the instrument can perform motor analysis when used in combination with an external torque sensor and tachometer. In addition, the motor inputs used in motor analysis can be used as two-channel independent analog DC inputs and four-channel pulse inputs, which can also be used as waveform measurement triggers. See “Trigger settings”(p. 102).

### Displaying motor measured values

#### Displaying motor measured values on the BASIC screen

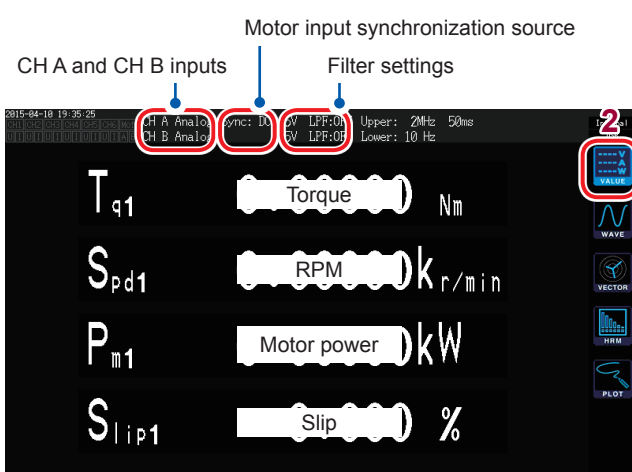

- 1 Press the [MEAS] key.
- 2 Touch VALUE.
- 3 Switch the channel to AB using the [CH] <math>\leftarrow\rightarrow</math> keys.

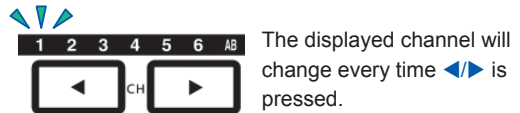

The following information will be displayed at the top of the screen when displaying motor input:

CH A, CH B input	Displays the input settings for CH A and CH B on the top and bottom, respectively. The display will indicate Analog, Freq, or Pulse.
Motor input synchronization source	Displays the source setting used to display the period (zero-cross) that serves as the basis for measurement. During dual-mode operation, this information will be shown on two lines.
Filter settings	Displays the range and filter setting for CH A and CH B on the top and bottom, respectively. When using the Analog setting, the display will indicate whether the range or the filter is on or off. When using the Freq or Pulse setting, the display will indicate the filter type (Weak/Strong/OFF).

#### When the motor input operating mode is set to Dual

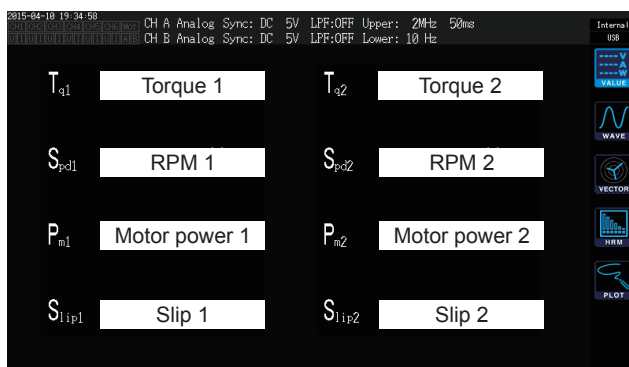



## Displaying motor measured values on the CUSTOM screen

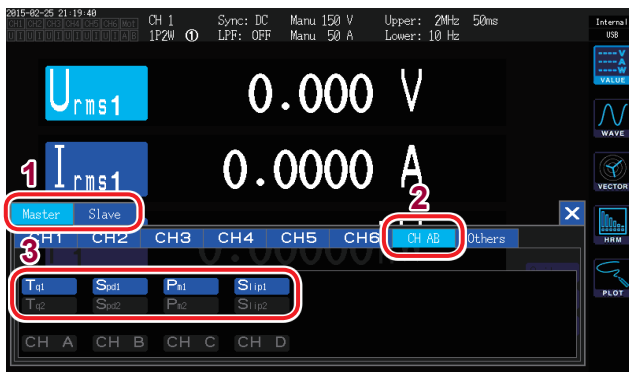

- 1 When using the two-instrument synchronization function's numerical synchronization mode, select whether to display the master's parameter or the slave's parameter first.
- 2 Touch CH AB.
- 3 Select the parameter to display.

Tq	Torque value
Spd	RPM
Pm	Motor power
Slip	Slip

## Performing zero-adjustment of motor input

In the following circumstances, perform zero-adjustment to eliminate errors caused by input signal offsets:

- When an analog DC voltage is being input to CH A or CH B
- When torque is being input using frequency

In the following circumstances, perform zero-adjustment while the instrument is receiving zero input for the torque and RPM signals:

- When a torque value is displayed even though no torque is occurring
- When an RPM value is displayed even though no rotation is occurring

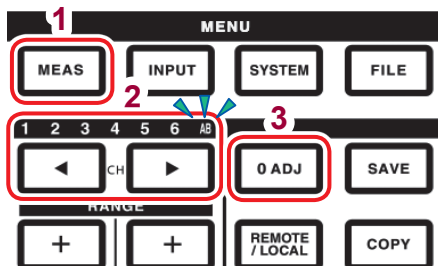

- 1 Press the [MEAS] key.
- 2 Switch the channel to AB using the [CH] <math>\leftarrow/\rightarrow</math> keys.

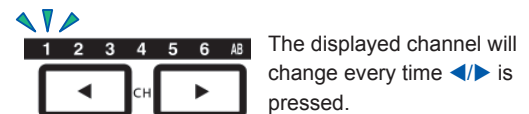

- 3 Press the [0ADJ] key.
- 4 Accept the settings on the confirmation dialog box.

Yes	Performs zero-adjustment.
No	Cancels the operation.

- You can also perform motor input zero-adjustment by pressing the [0ADJ] key while the AB channel display LED is lit up on any MEAS screen.
- Zero-adjustment cannot be performed for CH C, CH D, or CH A/CH B if set as pulse input.
- Zero-adjustment can be performed within an input range of  $\pm 10\%$  f.s. Compensation cannot be performed while the instrument is receiving input outside that range.
- Do not turn off the instrument during zero-adjustment. Doing so will cause the settings to be initialized.

## Setting motor input

Connect the torque sensor and tachometer as described in “8.3 Using Motor Analysis (Motor Analysis and D/ A-equipped Models Only)”(p. 184). Configure the motor analysis settings based on those connections.

### Setting the operating mode

Set the motor analysis operating mode to one of the following three options:

<b>Single motor (Single)</b> (Default setting)	This mode is used to measure one motor circuit. It can perform advanced analysis such as electrical angle measurement and forward/reverse operation detection.
<b>Dual motor (Dual)</b>	This mode is used to simultaneously measure two motor circuits. Two circuits of torque and RPM input are connected to, and measured simultaneously by, the instrument.
<b>Independent input (Indiv.)</b>	This mode uses motor input as independent analog DC input and pulse input.

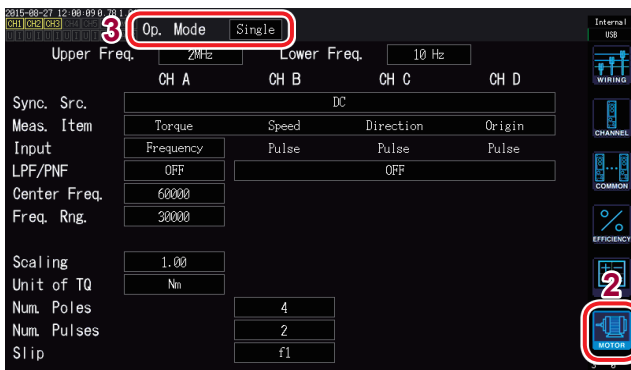

- 1 Press the **[INPUT]** key.
- 2 Touch **MOTOR**.
- 3 Touch **Op. Mode** and select the desired mode.

### When the operating mode is set to dual motor (Dual)

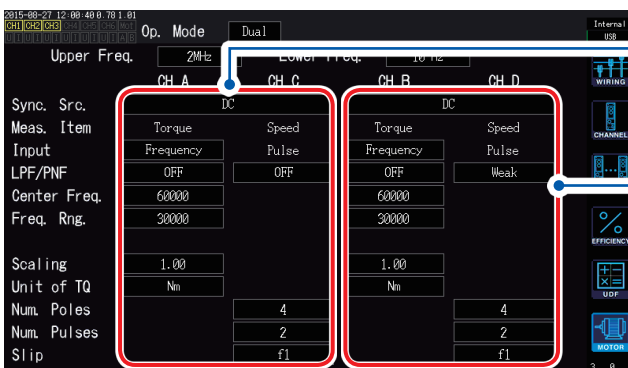

- Motor 1 settings  
Combination of CH A and CH C
- Motor 2 settings  
Combination of CH B and CH D

## Setting the upper limit frequency and lower limit frequency

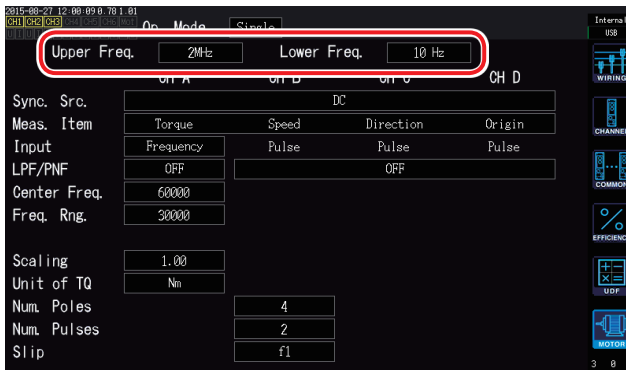

When inputting a pulse signal to the instrument's motor input, set upper and lower limits for the pulse frequency.

Upper limit frequency (Upper Freq.)	<p><b>100 Hz, 500 Hz, 1 kHz, 5 kHz, 10 kHz, 50 kHz, 100 kHz, 500 kHz, 2 MHz</b></p> <p>Sets the lowest frequency that exceeds the maximum frequency of the input pulse signal. When using <b>Independent input (Indiv.)</b> mode, this value is used as the upper limit value for D/A output.</p> <p>When using <b>Single motor (Single)</b> or <b>Dual motor (Dual)</b> mode, this value is used as the pulse frequency that is used to calculate the upper limit value for the RPM and motor power displays and for D/A output.</p> $\text{RPM upper limit value} = \frac{60 \times \text{set upper limit frequency}}{\text{Pulse count setting}}$ $\text{Motor power upper limit value} = \text{Maximum torque value} \times \frac{2 \times \pi \times \text{RPM upper limit value}}{60}$
Lower limit frequency (Lower Freq.)	<p><b>0.1 Hz, 1 Hz, 10 Hz, 100 Hz</b></p> <p>Sets the lower limit frequency at which to measure the input pulse signal. This value is also used as the lower limit frequency for measurement when the synchronization source is set to <b>Ext1</b>, <b>Ext2</b>, <b>Zph</b>, <b>CH C</b>, or <b>CH D</b>.</p>

## Setting the motor synchronization source

This section describes how to set the source that determines the period that serves as the basis for calculating motor analysis parameters. Motor analysis parameters are measured using intervals of the source selected here.

See "Setting the synchronization source"(p.60).

<b>Syn. Src.</b> (Synchronization source)	U1 to U6, I1 to I6, DC (default setting), Ext1, Ext2, Zph., CH C, CH D
--	--

The set motor synchronization source is displayed under **Sync** at the top of the Motor screen.

- The interval when **DC** is selected matches the data update rate (10 ms, 50 ms, 200 ms).
- When measuring motor efficiency under a fluctuating load, select the same synchronization source as for the motor input measurement channel. Efficiency can be measured more accurately by using the same calculation interval for motor input and motor output.

## Setting measurement parameters

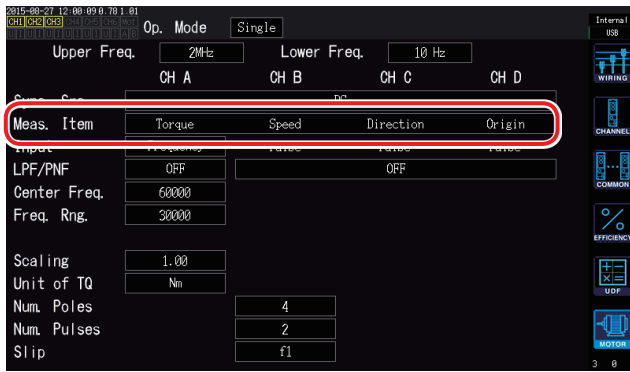

Set how to use CH A through CH D in single motor (Single) mode. You can select from the following four patterns:

	CH A	CH B	CH C	CH D
<b>1</b>	Torque (Torque)	RPM (Speed)	Direction of rotation (Direction)	Origin signal (Origin)
<b>2</b>	Torque (Torque)	RPM (Speed)	Direction of rotation (Direction)	Unused (Off)
<b>3</b>	Torque (Torque)	RPM (Speed)	Unused (Off)	Origin signal (Origin)
<b>4 (Default setting)</b>	Torque (Torque)	RPM (Speed)	Unused (Off)	Unused (Off)

- Measurement parameters cannot be set when using dual motor (Dual) mode or independent input (Indiv.) mode.
- When CH D is set to the origin signal (Origin), Zph. can be selected as the synchronization source.

## Setting the low-pass filter (LPF)

You can turn the low-pass filter on or off to eliminate high-frequency noise when the CH A or CH B input is set to analog DC. Set the filter to **ON** if external noise in analog DC input destabilizes measurement. The LPF setting has no effect on input when input is not set to analog DC input.

## Setting the pulse noise filter (PNF)

You can set the pulse noise filter to eliminate pulse noise from CH C and CH D and when CH A and CH B input are set to either Pulse or Frequency. Use this setting when the measured values for frequency or RPM data input using a pulse signal are unstable due to noise.

<b>Pulse noise filter</b>	OFF (Default setting), Weak, Strong
---------------------------	-------------------------------------

- The filter does not affect channels whose input is set to analog DC.
- The instrument will not be able to detect pulses of 500 kHz or greater when set to **Weak** or 50 kHz or greater when set to **Strong**.

## Setting the slip input frequency source

Parameter	Settings	Description
Slip	f1, f2, f3, f4, f5, f6	Sets the frequency of the measurement channel input to the motor in order to calculate the motor's slip.

Slip calculation formula

$$\text{r/min} = 100 \times \frac{2 \times 60 \times \text{input frequency} - |\text{RPM}| \times \text{pole number setting}}{2 \times 60 \times \text{input frequency}}$$

Select the voltage or current supplied to the motor, whichever is more stable, as the input frequency source.

## Setting the torque input

Parameter	Settings	Description
Input setting	Selects the type of signal used by the torque sensor connected to the instrument.	
	Analog	For sensors that output a DC voltage signal proportional to the torque
	Frequency	For sensors that output a frequency signal proportional to the torque

The available settings will vary as described below depending on the selected setting.

### When Analog is selected

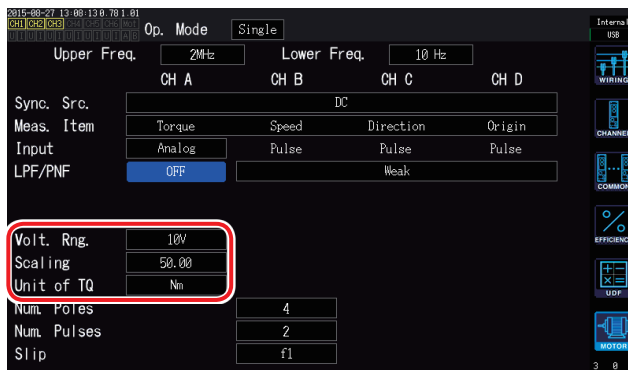

When **Torque input** is set to **Analog**, set the following three settings based on the sensor: **Volt. Rng. (voltage range)**, **Scaling (scale value)**, and **Unit of TQ (torque unit)**.

Example: For a torque sensor with a rated torque of 500 N·m and an output scale of ±10 V

<b>Volt. Rng.</b>	10 V
<b>Scaling</b>	50.00
<b>Unit of TQ</b>	Nm

Parameter	Settings	Description
<b>Volt. Rng.</b> (voltage range)	1 V range, 5 V range, 10 V range	Select according to the output voltage of the torque sensor being connected to the instrument.
		The torque input voltage range can also be set with the voltage range keys while the AB channel indicator LED is lit up.
<b>Scaling</b> (scale value)	Set to a value from <b>0.01</b> to <b>9999.99</b> .	Enter using the numeric keypad window.
	Torque measured values are displayed as the result of multiplying the input voltage by the scaling value. Set the torque value per 1 V of output from the connected torque sensor in conjunction with the <b>Unit of TQ</b> setting. (Scaling value = Torque sensor rated torque value / Output full-scale voltage value) In the example, the scaling value would be 50. (50 = 500 N·m / 10)	
<b>Unit of TQ</b> (torque unit)	Set based on the connected torque sensor.	
	<b>mNm</b>	Select if the connected torque sensor's output rate is 1 mN·m to 999 mN·m per 1 V.
	<b>Nm</b>	Select if the connected torque sensor's output rate is 1 N·m to 999 N·m per 1 V.
	<b>kNm</b>	Select if the connected torque sensor's output rate is 1 kN·m to 999 kN·m per 1 V.

**When Frequency is selected**

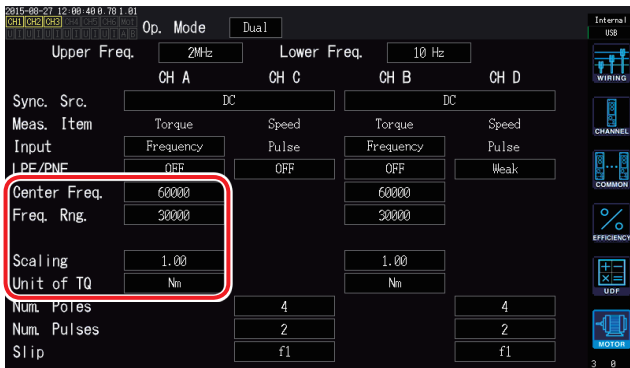

If the **Input** is set to **Frequency**, set the following four parameters based on the sensor: **Center Freq.**, **Freq. Rng.**, **Scaling**, and **Unit of TQ**.

Example 1: For a torque sensor with a rated torque of 500 N·m and output of 60 kHz ±20 kHz

<b>Center Freq.</b>	60000
<b>Freq. Rng.</b>	20000
<b>Scaling</b>	500.00
<b>Unit of TQ</b>	Nm

Example 2: For a torque sensor with a rated torque of 2 kN·m, positive rated torque of 15 kHz, and negative rated torque of 5 kHz

<b>Center Freq.</b>	10000
<b>Freq. Rng.</b>	50000
<b>Scaling</b>	2.00
<b>Unit of TQ</b>	kNm

Parameter	Settings	Description
<b>Unit of TQ (torque unit)</b>	<b>mNm, Nm, kNm</b>	Set according to the torque sensor being connected to the instrument.
<b>Scaling (scale value)</b>	Set to a value from <b>0.01</b> to <b>9999.99</b> .	Set to the rated torque of the connected torque sensor in conjunction with the torque unit setting.
<b>Center Freq. Freq. Range</b>	Set to a value from 1 kHz to 500 kHz in 1 Hz steps.	Set the center frequency to the center frequency corresponding to a torque value of 0. Also set the frequency range to the difference between the frequency corresponding to the sensor rated torque and the center frequency. The settings must satisfy the following constraints: (Center frequency + frequency range) ≤ 500 kHz (Center frequency - frequency range) ≥ 1 kHz

### Setting rotation signal input

Parameter	Settings	Description
	Selects the type of rotation signal being connected.	
<b>Input</b>	<b>Analog</b>	For a DC voltage signal that is proportional to the RPM. This setting is only used for measurement parameter pattern 4.
	<b>Pulse</b>	For a pulse signal that is proportional to the RPM

The setting parameters vary with the selected input setting.

#### When **Analog** is selected



If the **Input** is set to **Analog**, set the **Volt. Rng. (voltage range)** and **Scaling (scale value)** based on the rotation signal.

Parameter	Settings	Description
<b>Volt. Rng. (voltage range)</b>	<b>1 V range, 5 V range, 10 V range</b>	Select according to the output voltage of the rotation signal being connected to the instrument. The rotation signal input voltage range can also be set with the current range keys while the AB channel indicator LED is lit up.
<b>Scaling (scale value)</b>	Set to a value from <b>0.01</b> to <b>99999.9</b> .	Enter using the numeric keypad window.
	RPM measured values are displayed as the result of multiplying the input voltage by the scaling value. Set the value per 1 V of output for the connected rotation signal.	

When **Pulse** is selected

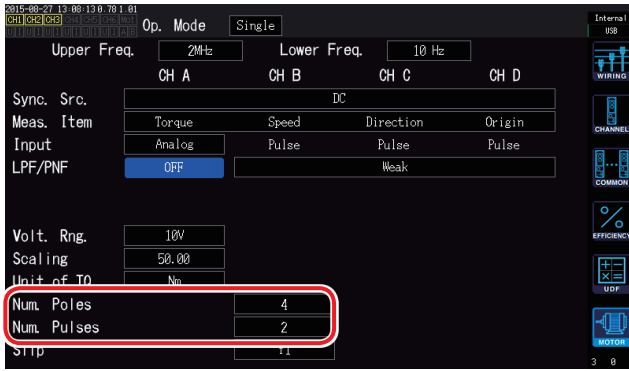

Parameter	Settings	Description
<b>Num. Poles (motor pole number)</b>	Set to the pole number for the motor being measured (an even number from <b>2</b> to <b>254</b> ).	This value is used in slip calculation and to convert the RPM signal as a frequency corresponding to the mechanical angle to a frequency corresponding to the electrical angle.
		Enter using the numeric keypad window.
<b>Num. Pulses (pulse count)</b>	Set to the number of pulses per mechanical angle rotation ( <b>1</b> to <b>60000</b> ).	If an incremental-type rotary encoder with 1000 pulses per rotation is connected, set to 1000.
		Enter using the numeric keypad window.
		Setting this parameter to a whole number that is half of the motor's pole number setting will enable selection of Ext as the synchronization source.



## Measuring a motor's electrical angle

When a pulse signal is used as rotation signal input, you can view changes in the voltage and current phase using the pulse as the reference by setting the **Sync. Src** (synchronization source) for input channels 1 through 6 to **Ext1** or **Ext2**.

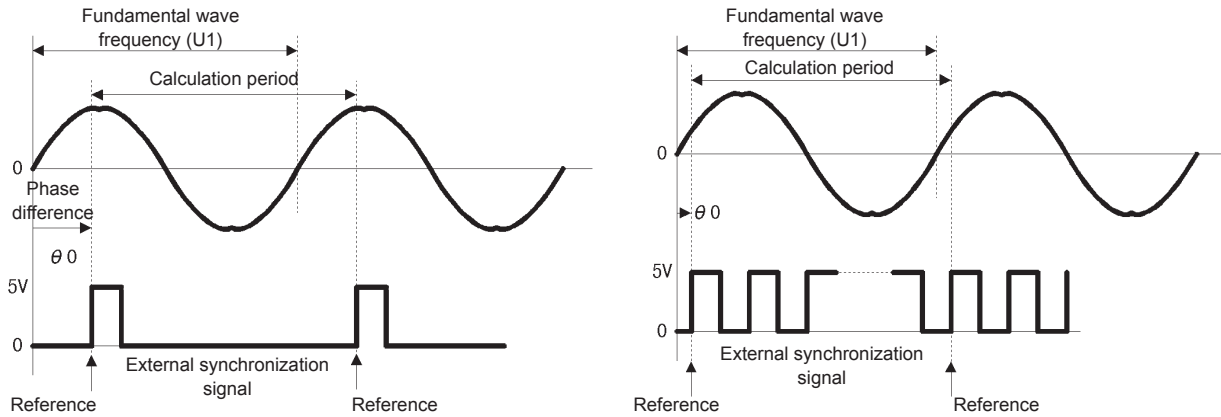

### When measuring the electrical angle using multiple pulses

- It is recommended to use the origin signal (Z-phase). When the origin signal (Z-phase) is used, the reference pulse is determined based on the origin signal, allowing phase measurement to be carried out using a fixed pulse as the reference at all times.
- When not using the origin signal (Z-phase), the pulse that serves as the reference is determined during synchronization. If synchronization is lost, a different pulse may be used as the reference each time resynchronization is performed.

- Performing harmonic analysis in synchronization with the rotation signal input pulse requires a pulse count that is a whole-number multiple of the input frequency. For example, a four-pole motor would require a pulse count that is a whole-number multiple of 2, while a six-pole motor would require a pulse count that is a whole-number multiple of 3.
- When measuring a motor that uses a Y connection internally with a 3P3W3M connection, the phase voltage and phase current phase angles can be measured by using the  $\Delta$ -Y conversion function.

## Phase zero-adjustment (PHASE ADJ)

This section describes how to perform zero-adjustment to correct the phase difference between the synchronization source's pulse and the voltage fundamental wave component of the connected first channel.

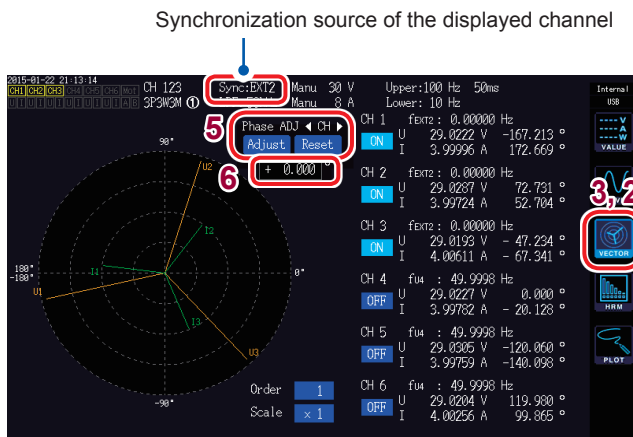

- 1 Press the **[MEAS]** key.
- 2 Touch **VECTOR**.
- 3 Select the Vector screen (**VECTOR1**).
- 4 Select the channel for which to perform phase angle zero-adjustment with the **[CH]** keys

To obtain the correction value according to the input

- 5 Touch **Adjust** under **Phase ADJ**.

To enter a user-defined correction value

- 6 Touch the correction value display area, and enter a correction value with the numeric keypad window.

- Phase zero-adjustment can only be performed when the **Sync. Src.** (synchronization source) is set to **Ext1** or **Ext2**. Initiating the function has no effect when other settings are in use.
- Initiating the function has no effect when the instrument is in the synchronization unlocked state.
- The correction value has a setting range of  $-180^{\circ}$  to  $180^{\circ}$ . For the environments where phase angles are expressed as numbers between  $0^{\circ}$  and  $360^{\circ}$ , convert a correction value into a number between  $-180^{\circ}$  to  $180^{\circ}$  and enter it.
- The correction display area indicates the present correction value for the phase zero-adjustment. Touching **Adjust** can replace the existing correction value with the displayed value.
- The set phase zero adjustment correction value will be subtracted from pulse-based voltage and current phase measured values.
- Compensation values will be maintained even if the instrument is turned off.
- Touching **Reset** will clear the compensation values and revert to operation in which the instrument displays the phase difference with the pulse being used as the reference.
- Compensation values will be cleared if the system is reset.

## Example of electrical angle measurement

- 1 With the motor is an un-energized state, operate the motor from the load side and measure the inductive voltage that occurs across the motor's input terminals.
- 2 Perform phase zero-adjustment.  
Zero-adjustment will zero out the phase difference between the fundamental wave component of the inductive voltage waveform input to U1 and the pulse signal.
- 3 Energize and operate the motor.  
Voltage and current phase angles measured with the instrument will indicate electrical angle based on the inductive voltage phase.

Because the phase difference includes the effects of the rotation input signal's pulse waveform and the instrument's internal circuit delay, it will appear as measurement error when measuring a frequency that differs greatly from the frequency at which phase zero adjustment was performed.

## Detecting the motor's direction of rotation

If an incremental-type rotary encoder's A-phase pulse and B-phase pulse are input to the rotation signal CH B and CH C input terminals, it is possible to detect the direction in which the shaft is rotating and to assign the corresponding polarity sign to the RPM value.

Direction of rotation is detected when Pattern 1 or Pattern 2 is selected for the measurement parameters. Direction of rotation is judged based on the level of the other pulse (high/low) when the A-phase pulse and B-phase pulse rising and falling edges are detected.

### Forward operation

RPM polarity sign: +

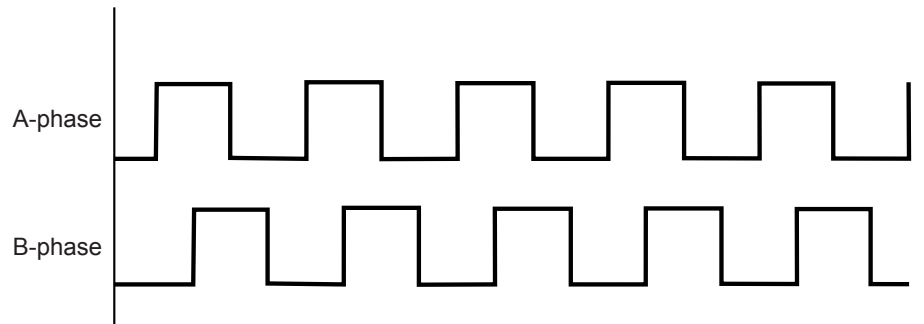

### Backward operation

RPM polarity sign: -

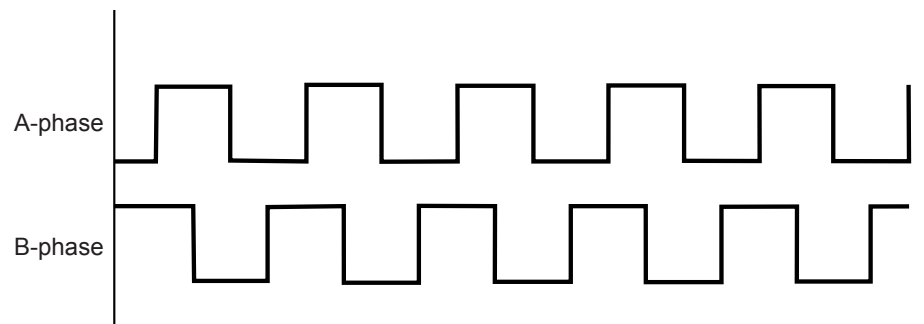

The detected direction of rotation is reflected in the polarity sign that is assigned to RPM measured values as well as to motor power (Pm) measured values.

Setting Zph. as the synchronization source for input channel 1 through 6 while a pulse signal is being provided as rotation signal input and the origin signal (Origin) is being input to CH D allows you to view voltage and current measured values based on one motor rotation (one cycle of the mechanical angle).

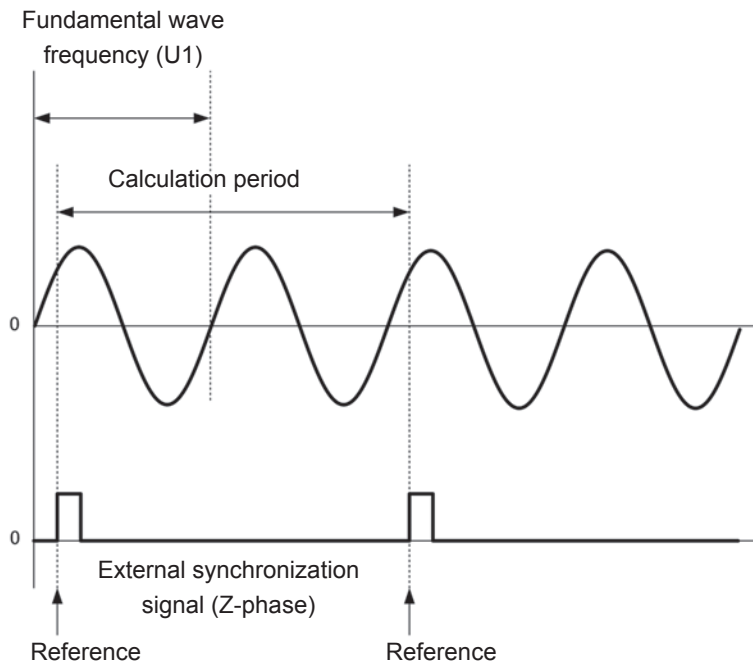

Example for a 4-pole motor

- Since one motor rotation is always used as the calculation period regardless of the number of poles the motor has, measurements can be performed by averaging the variations for each pole that are caused by the motor's mechanical characteristics.
- Fundamental wave measured values appear as  $n$ th order for voltage and current harmonic measured values, where  $n$  is defined as "number of motor poles / 2." Subsequently, the  $n$ th-order harmonics for voltage and current appear as "number of motor poles /  $2 \times n$ ."
- The voltage and current fundamental frequency is measured to obtain voltage and current frequency measured values.
- This capability is available when the motor analysis operating mode (p.84) is set to Single.
- Provide input as appropriate based on the CH A through CH D measurement parameters (p.86). In addition to inputting the origin signal to CH D (Z-phase pulse), it is necessary that the rotation signals be properly input to CH B (A-phase pulse) and CH C (B-phase pulse when using direction).
- To use another pulse as the calculation period reference instead of the pulse output from a rotary encoder, it is recommended to set the motor analysis operating mode to Indiv. and then to set CH C or CH D as the synchronization source for input channels 1 through 6. Input the reference pulse as the selected synchronization source.

# 4 Viewing Waveforms

The instrument can display the voltage and current waveforms measured by all channels, along with motor input waveforms. Since the waveform display is completely independent of power measurement, the operations described in this chapter have no effect on power or harmonic measured values.

## 4.1 Displaying Waveforms

### Displaying waveforms on the WAVE screen

The WAVE screen displays only waveforms.

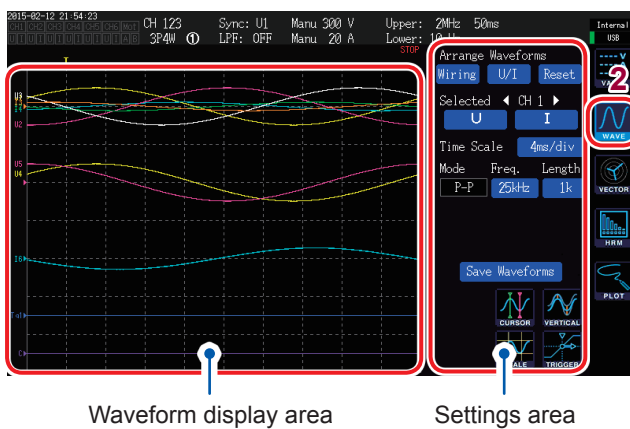

Waveform display area

Settings area

1 Press the **[MEAS]** key.

2 Touch **WAVE**.

3 Press the **[RUN/STOP]** key.  
(**[RUN/STOP]**: Turns green.)

Waveform recording will start, and the screen display will be updated.  
(Recording will start if a trigger is activated [p. 104].)

4 Press the **[RUN/STOP]** key again.  
(**[RUN/STOP]**: Turns red.)

Waveform recording and screen display updates will stop.

### Waveform recording status display

The waveform recording status display provides useful information in the event that it takes time for the instrument to display waveforms or that waveforms are not displayed.

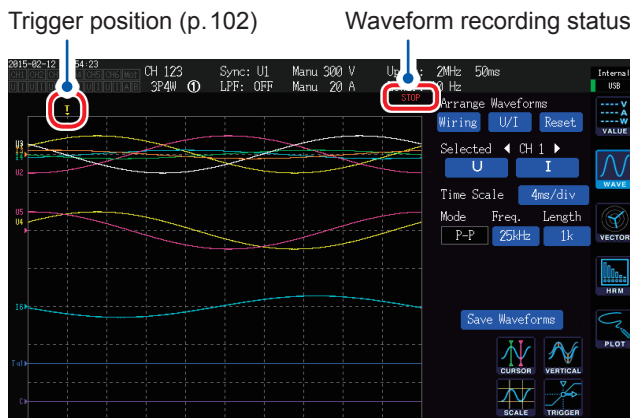

Trigger position (p. 102)

Waveform recording status

Display	Description of status
STOP	Recording has stopped.
WAIT	The instrument is in the trigger standby state.
PTR	The instrument is recording pre-trigger waveforms.
STRG	The instrument is recording post-trigger waveforms.
CMP	The instrument is creating waveforms for display.
ABRT	The instrument is performing processing to stop waveform recording.

## Displaying waveforms and measured values on the WAVE+VALUE screen

The **WAVE+VALUE** screen displays waveforms and measured values.

Waveform display area

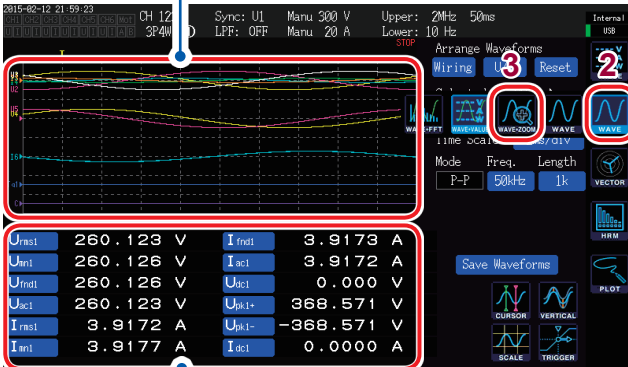

Measured value display area

- Timing of recording and measured value measurement for the displayed waveform is not synchronized.
- Pressing the **[HOLD]** key will stop only display updates for measured values. Waveform recording will not stop.

- 1 Press the **[MEAS]** key.
- 2 Touch **WAVE**.
- 3 Touch **WAVE+VALUE**.
- 4 Press the **[RUN/STOP]** key.  
(**[RUN/STOP]**: Turns green.)

The waveforms will be displayed on the screen.

(Recording will start if the trigger is activated [p. 104].)

- 5 Press the **[RUN/STOP]** key again.  
(**[RUN/STOP]**: Turns red.)

Display of the waveforms will stop.

You can choose 12 basic measurement parameters to display in the measured value display area.

See “Selecting display parameters” (p. 51).

## Initializing the display position

The vertical axis display position in the waveform display area can be initialized using any of three patterns.



- 1 Under **Arrange Waveforms**, touch one of the patterns.  
A confirmation dialog box will be displayed.
- 2 Select whether to initialize the display position.

Yes	Initializes the display positions.
No	Cancels the initialization.

**Wiring**

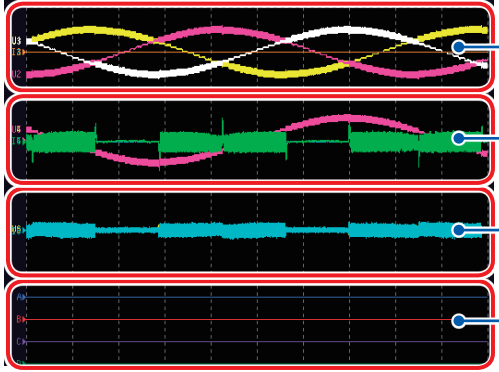

Voltage and current waveforms for the first connection

Voltage and current waveforms for the second connection

Voltage and current waveforms for the third connection

Motor input waveforms

The voltage and current waveforms for each connection are shown at the same position. The positions vary with the connection pattern.

**U/I**

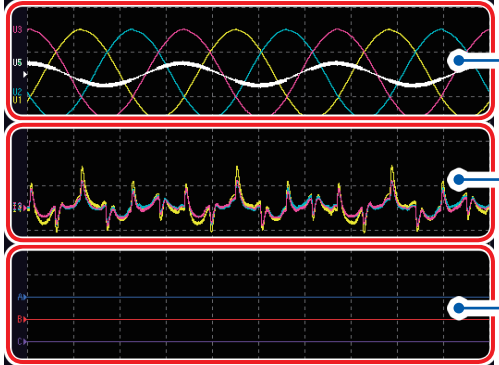

Voltage waveforms

Current waveforms

Motor input waveforms

The voltage waveforms are shown at the top of the area, and the current waveforms are shown at the bottom of the area.

**Reset**

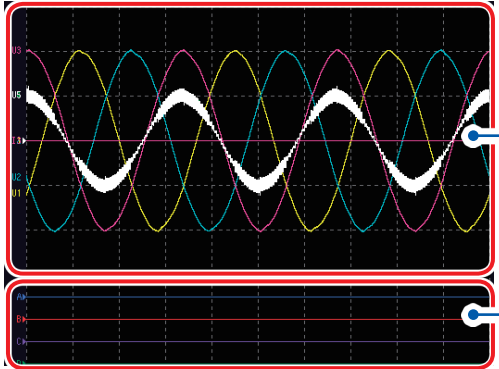

Voltage/current waveforms

Motor input waveforms

The voltage and current waveforms for all channels are shown at the same position.

- The vertical axis is positioned relative to the zero position of each input.
- The display zoom factor for the vertical axis is adjusted based on the range and the size of the area's vertical axis.
- For models not equipped with motor input, nothing is displayed in the motor input waveform area.

## 4.2 Changing the Waveform Display and Configuring Recording

### Vertical axis zoom factor and display position settings

This section describes how to set the zoom factor and display position for the waveform vertical axis.

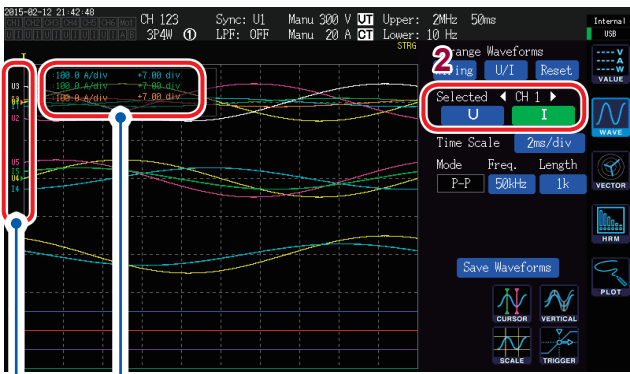

The div. display range and display position for the parameter being changed will be displayed.

The parameter name for each waveform will be displayed.

- These settings apply to all parameters for the channel whose LED is lit up.  
To change settings for individual parameters: See "Detailed display settings" (p. 101)
- The zoom factor can be set within the range listed below. (The choices are not shown on the screen.)  
1/10×, 1/9×, 1/8×, 1/7×, 1/6×, 1/5×, 1/4×, 1/3×, 2/5×, 1/2×, 5/9×, 5/8×, 2/3×, 5/7×, 4/5×, 1×, 10/9×, 5/4×, 4/3×, 10/7×, 5/3×, 2×, 20/9×, 5/2×, 10/3×, 4×, 5×, 20/3×, 8×, 10×, 25/2×, 50/3×, 20×, 25×, 40×, 50×, 100×, 200×

- 1 Select the channel whose vertical axis zoom factor and display position you wish to change with the [CH] ◀▶ keys.

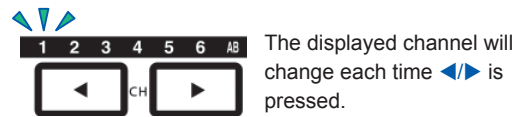

- 2 Touch U, I, A, B, or CD to configure the settings for the corresponding axis.

U	Voltage waveforms
I	Current waveforms
A, B, CD	Motor input waveforms (When AB is selected as the channel)

(X rotary knob/Y rotary knob: Turns green.)

- 3 Configure the settings with the X rotary knob and Y rotary knob.

X rotary knob: Vertical axis zoom factor  
Y rotary knob: Vertical axis display position

(When you press the Y rotary knob, the color of the knob's light will change from green to red, and the speed with which the zoom region moves will increase. Pressing the knob again will cause the color of the knob's light to change back to green and the speed with which the zoom region moves to revert to its original value.)



## Time axis setting

This section describes how to set the waveform's time axis using the time axis (**Time Scale**), storage mode (**Mode**), sampling speed (**Freq.**), and recording length (**Length**) settings. The set time axis will be displayed under **Time Scale**.

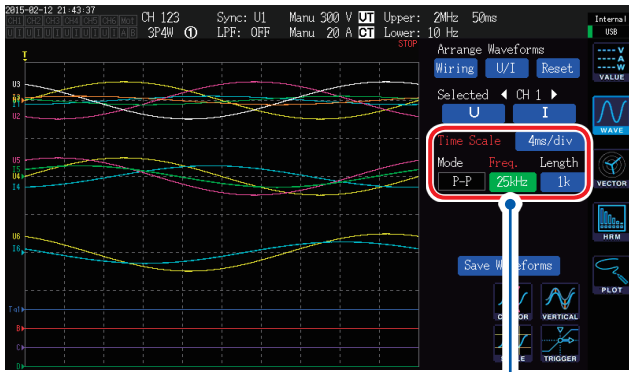

Touch each parameter to select it.

The motor's analog waveform sampling speed is 50 kS/s. If the sampling speed setting is faster than 50 kS/s, it will be supplemented and displayed using the same value.

When the settings are changed from those of the displayed waveform, parameters whose waveform and settings differ will be displayed in red.

Parameter	Available selections	Description
<b>Time Scale</b> (Time axis)	<b>20 μs/div, 40 μs/div, 100 μs/div, 200 μs/div, 400 μs/div, 500 μs/div, 1 ms/div, 2 ms/div, 4 ms/div, 5 ms/div, 10 ms/div, 20 ms/div, 40 ms/div, 50 ms/div, 100 ms/div, 200 ms/div, 400 ms/div, 500 ms/div, 1s/div, 2 s/div, 4 s/div, 5 s/div, 10 s/div MHz, 2.5 MHz</b>	Setting method: (X rotary knob: Turns green.) Turn rotary knob: Select Press rotary knob: Enter → The knob's light will turn off. When the knob is rotated to select a time scale, settings will be forcibly changed to maximize the sampling frequency and storage length.
<b>Mode</b> (Storage mode)	<b>P-P</b>	Saves a 5 MS/s waveform using peak-peak compression (p.99). Even if the sampling speed is lowered, it will be possible to reproduce an accurate waveform that retains waveform peak information. Triggers will apply to the waveform after peak-peak compression.
	<b>DECI</b>	Saves a 5 MS/s waveform after thinning at the set sampling speed (using decimation in frequency). Depending on the measured waveform, aliasing (p. 100) may occur. This operation is similar to that of a standard oscilloscope.
<b>Freq.</b> (Sampling speed)	<b>5 MHz, 2.5 MHz, 1 MHz, 500 kHz, 250 kHz, 100 kHz, 50 kHz, 25 kHz, 10 kHz</b>	Setting method: (X rotary knob: Turns green.) Turn rotary knob: Select Press rotary knob: Enter → The knob's light will turn off.
<b>Length</b> (Recording length)	<b>1k, 5k, 10k, 50k, 100k, 500k, 1M</b> (Unit: Words)	1k = 1000 sampled data points 1 sampled data point = 1 word

Once waveforms have been recorded for the set recording length at the set sampling speed, they are displayed. If recording takes 4 sec. or more due to the sampling speed and recording length settings, the instrument will display waveforms in real time as they are recorded.

## Peak-peak compression

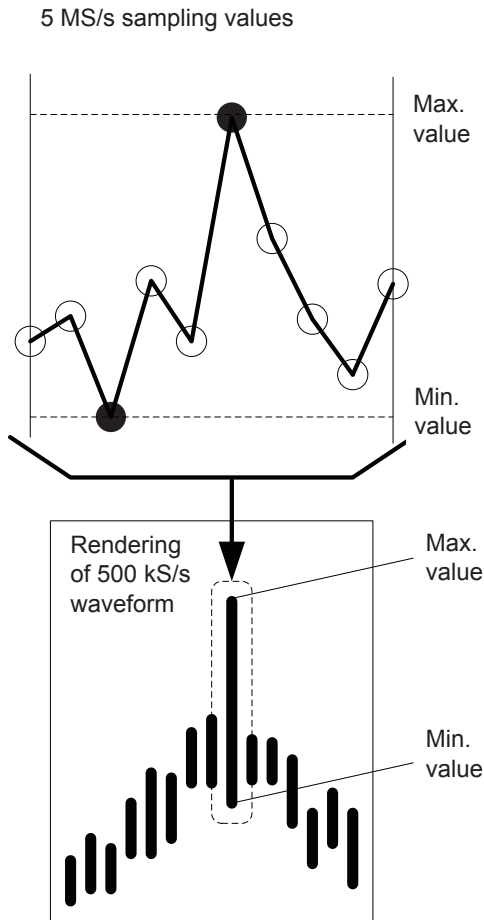

When a 5 MS/s waveform is subject to peak-peak compression to yield a 500 kS/s waveform

The instrument always samples data at 5 Ms/s internally, even when the sampling speed has been changed. When the sampling speed is lowered, the method used to save the maximum and minimum values in a given interval instead of simply thinning the 5 MS/s waveform is known as peak-peak compression.

By using this method, it is possible to obtain an accurate waveform that retains peak information for the pre-compression waveform even if the sampling speed is lowered. Concerning the number of data points in the saved waveform data, two pieces of data (the maximum and minimum values as shown in the figure to the left) are saved for each point.

## Aliasing

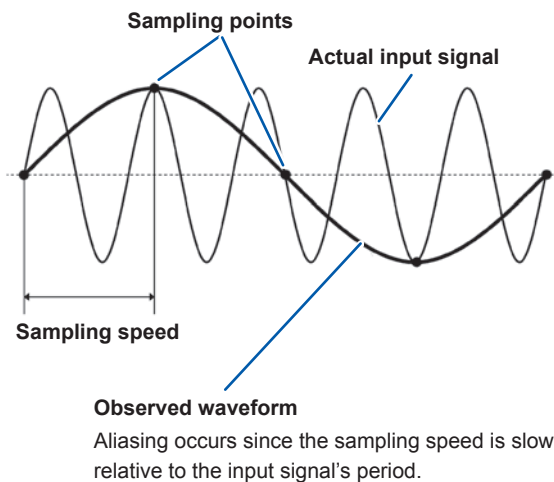

When changes in the signal being measured occur faster than the sampling speed, slow signal changes that do not exist are recorded around a boundary consisting of a given frequency. This phenomenon is known as aliasing.

## Detailed display settings

This section describes how to turn the display on and off and how to configure detailed settings such as the vertical axis zoom factor and vertical axis display position for individual waveform parameters.

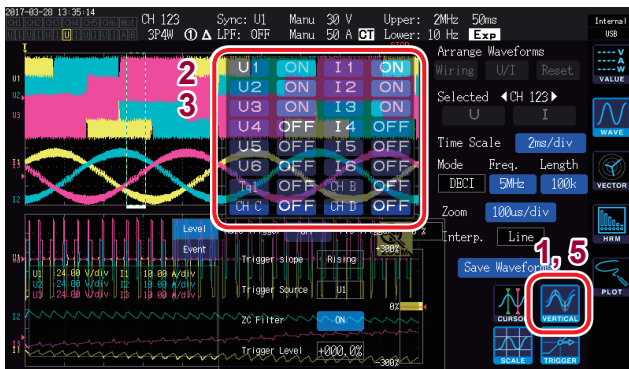

### 1 Touch **VERTICAL**.

A detailed display settings window will open.

### To turn the display on or off

### 2 Touch **ON** or **OFF** for each display parameter to toggle its display.

### To set the vertical axis zoom factor and vertical axis display position

### 3 Touch a parameter.

(X rotary knob/Y rotary knob: Turns green.)

### 4 Configure the settings with the X rotary knob and the Y rotary knob.

X rotary knob: Vertical axis zoom factor  
Y rotary knob: Vertical axis display position

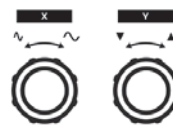

Turn rotary knob: Select  
Press rotary knob: Enter →  
The knob's light will turn off.

### 5 Touch **VERTICAL**.

The window will close.

4

Viewing Waveforms

## Vertical axis scale display

This section describes how to display a list of vertical axis scales for all displayable waveforms.

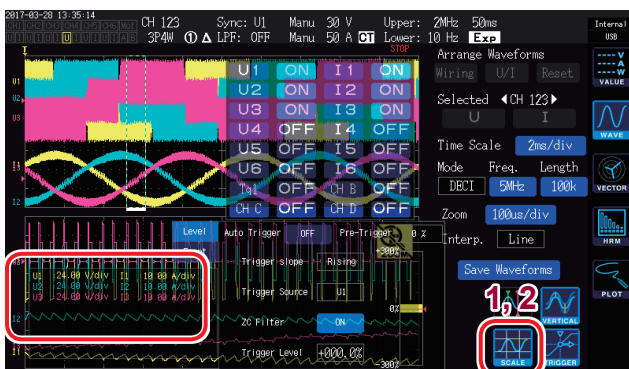

### 1 Touch **SCALE**.

The Vertical Axis Scale window will open.

### 2 Touch **SCALE** again.

The window will close.

## Trigger settings

For the purposes of this section, the term *trigger* refers to functionality for setting the condition at which to start waveform recording.

When the condition set as the trigger occurs, the trigger is said to have been activated, and waveform recording will begin.

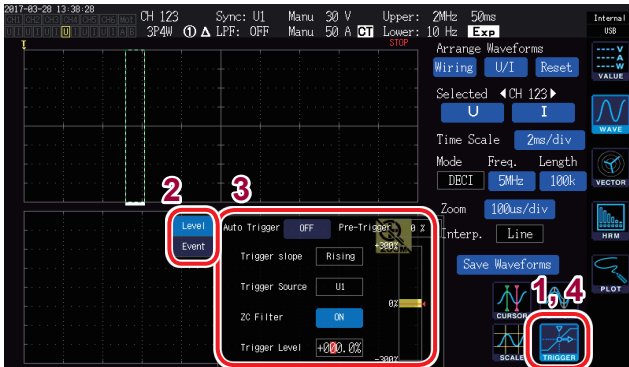

- 1 **Touch TRIGGER.**  
The Trigger Settings window will be displayed.
- 2 **Select the trigger detection method (Level/Event).**
- 3 **Touch each setting to select it.**
- 4 **Touch TRIGGER.**  
The window will close.

Setting	Options	Description
Trigger detection method	Level	The trigger will be activated by fluctuations in the level of the storage waveform.
	Event	The trigger will be activated by fluctuations in the value of the measurement parameter selected for D/A output.
Auto Trigger	ON, OFF	When set to ON, waveform recording will be forcibly started if the next trigger is not activated within 100 ms of the activation of the pre-trigger. This setting is useful in applications such as observation of DC input waveforms. When set to OFF, waveform recording will not start unless the set condition occurs.
Pre-Trigger	0% to 100% (Can be set in 10% increments.)	Sets how much of the waveform to allocate before the trigger is activated, relative to the recording length.  Setting method (Y rotary knob: Turns red.) Turn rotary knob: Select Press rotary knob: Enter → The knob's light will turn off.
Trigger Slope	Rising	The trigger will be activated at the rising edge of the waveform.
	Falling	The trigger will be activated at the falling edge of the waveform.
Trigger Source	Sets the waveform to use as the trigger source.	
	U1 to U6	Voltage waveforms
	I1 to I6	Current waveforms
	CH A to CH D, Tq1, Tq2, Spd1, Spd2, Ext1, Ext2	Motor waveforms (available only on motor analysis and D/A-equipped models) Available settings vary with the motor input operating mode.

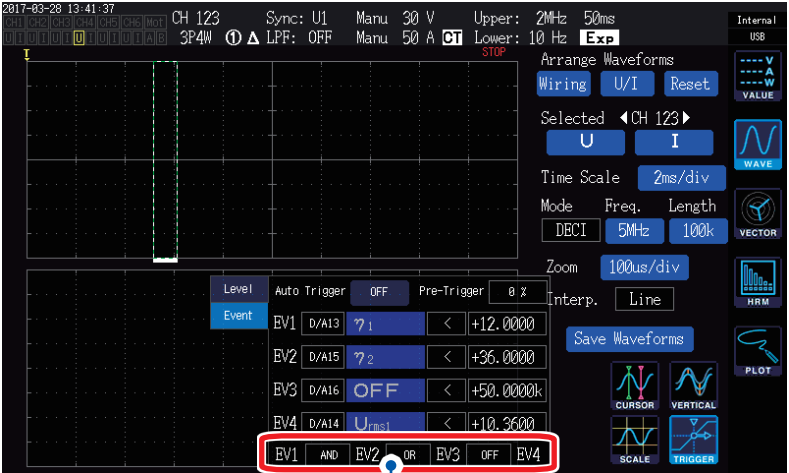
<p><b>ZC Filter</b> (Zero-cross filter)</p>	<p><b>ON, OFF</b></p>	<p>When the trigger source has been set to a voltage waveform or current waveform, activates the trigger using a waveform to which a noise filter has been applied to eliminate noise. Set to <b>ON</b> to obtain stable trigger timing when using a waveform containing noise. This setting is particularly effective when observing PWM waveforms. It does not affect the display waveform.</p>
<p><b>Trigger Level</b></p>	<p><b>-300% to +300%</b></p>	<p>Sets the level at which the trigger is activated as a percentage of the source range. A level monitor is shown on the right side of the window. This setting cannot be used when the trigger source is set to a motor waveform pulse (<b>Pulse</b>). Setting method (Y rotary knob: Turns red.) Turn Y rotary knob: Change value Press Y rotary knob: Change digit (10%, 1%, 0.1%) Press X rotary knob: Enter → The knob's light will turn off.</p>
<p><b>EV1 to EV4</b></p>	<p>These condition definitions consist of a D/A output measurement parameter (D/A13 to D/A20), an inequality sign (&lt; or &gt;), and a value (0.00000 to 999999T).</p>  <p>The conditions under which the trigger is activated are determined by OR and AND operations on EV1 through EV4. The AND operator has precedence over the OR operator.</p>	

4

## 4.3 Recording Waveforms

### Recording a waveform continuously

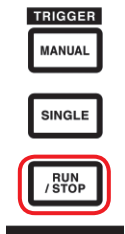

- 1 Press the **[RUN/STOP]** key.  
(**[RUN/STOP]**: Turns green.)

The instrument will enter the trigger standby state. Recording will start when the trigger is activated. The instrument will enter the trigger standby state repeatedly.

- 2 Press the **[RUN/STOP]** key.  
(**[RUN/STOP]**: Turns red.)

Recording will stop.

- When storage has been stopped by pressing the **[RUN/STOP]** key, FFT analysis and the zoom function may not operate.
- Use waveform analysis (zoom and FFT analysis) on waveforms captured using the **[SINGLE]** key

### Recording a waveform once

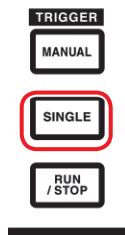

- Press the **[SINGLE]** key.  
(**[SINGLE]**: Turns green.)

The instrument will enter the trigger standby state. Recording will start when the trigger is activated.

Once the waveform has been recorded for the recording length, recording will stop.  
(**[SINGLE]**: Turns off. **[RUN/STOP]**: Turns red.)

Pressing **[RUN/STOP]** while the instrument is in the standby state will cause recording to stop.  
(**[SINGLE]**: Turns off. **[RUN/STOP]**: Turns red.)

### Activating the trigger manually

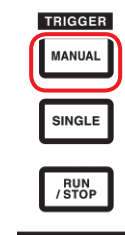

- Press the **[MANUAL]** key while the instrument is in the standby state.

The trigger will be activated when the key is pressed, and recording will start.

## 4.4 Analyzing Displayed Waveforms

### Viewing displayed waveform values (Cursor measurement)

You can use the two cursors to display cursor values for the selected waveform. Cursor values for each connection's voltage waveform, current waveform, and motor input waveform can be displayed, along with the difference between the two cursors' respective values.

Cursor value display window

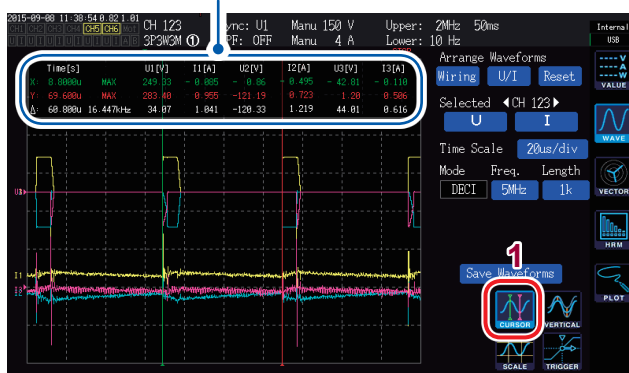

- 1 Touch **CURSOR**.  
The cursor display window will open.
- 2 Using the **[CH]** **◀▶** keys, select the channel for which you wish to perform cursor measurement.
- 3 Use the X rotary knob and the Y rotary knob to set the cursor position and to display the maximum and minimum values (in order) for the cursors' measured values

X rotary knob: Change the X cursor setting  
Rotate the knob to display values in the following order:

- Minimum value display
- Movement of cursor and maximum value display
- Minimum value display
- Movement of cursor and maximum value display
- ....

Y rotary knob: Change the Y cursor setting  
The Y rotary knob operates in the same manner as the X rotary knob.

The following items will be displayed in the cursor display window:

- Cursor X values (level and time axis), maximum and minimum value indication
- Cursor Y values (level and time axis), maximum and minimum value indication
- Difference ( $\Delta$ ) between cursor X and Y values (level difference and time axis difference)
- Reciprocal of the cursor X and cursor Y time-axis difference ( $1/\Delta$ )

- For each dot on the displayed waveform, there are two pieces of data (the maximum value and the minimum value) (p.99 p.100). Consequently, you can switch between the maximum value display and the minimum value display during cursor measurement.
- Cursor measurement can be selected on the following waveform-related screens:
  - **WAVE** screen (waveform display)
  - **WAVE+ZOOM** screen (waveform + zoom display)
  - **WAVE+VALUE** screen (waveform + measured value display)
  - **WAVE+FFT** screen (waveform+ FFT analysis)

## Enlarging waveforms (zoom function)

You can enlarge the displayed waveform along the time (horizontal) axis. The portion of the waveform indicated by the solid white border in the waveform display area (the zoom region) will be enlarged along the time axis and shown in the zoom display area.

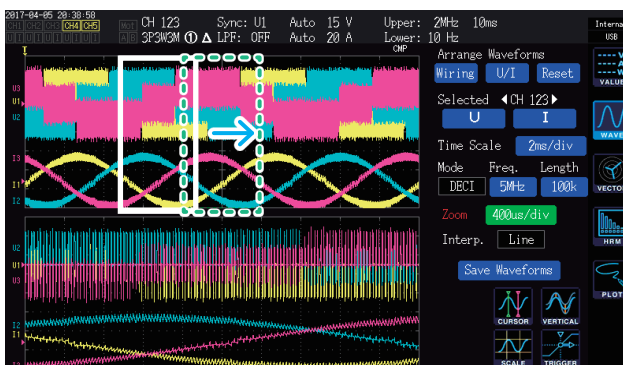
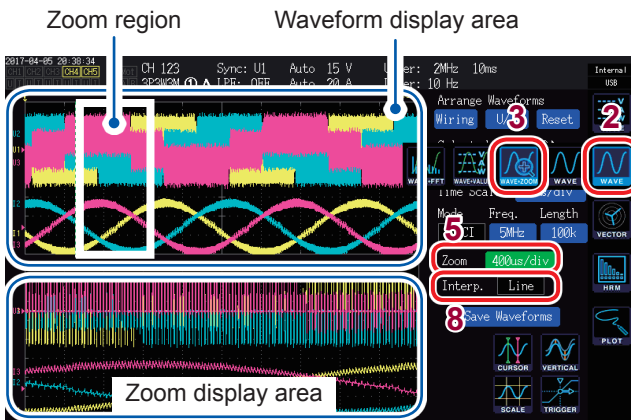

- The broken green lines indicate the zoom region after the position and zoom factor settings change.
- The waveform shown at the bottom of the screen is the waveform inside the zoom region shown by the solid white lines.
- When using the zoom function, acquire waveforms using the SINGLE trigger. (p. 104)

- 1 Press the **[MEAS]** key.
- 2 Touch **WAVE**.
- 3 Touch **WAVE+ZOOM**.
- 4 Acquire a waveform with the **[SINGLE]** key.  
See “4.1 Displaying Waveforms” (p. 95).
- 5 Touch the **Zoom** box.
- 6 Select the time scale (the desired zoom factor and the size of the zoom region) with the **X** rotary knob.  
Which time scales are available for selection depends on the number of storage points (**x2** to **x200k**).
- 7 Change the position of the zoom region with the **Y** rotary knob.  
The zoom region will move horizontally. (When you press the Y rotary knob, the color of the knob’s light will change from green to red, and the speed with which the zoom region moves will increase. When you press the button again, the color of the knob’s light will change back to green.)
- 8 Touch the **Interp.** setting and select the interpolation method.

- Line:** Interpolates between pairs of points with straight lines.
- Sine:** Interpolates between pairs of points smoothly using the sinc function. (This option can be selected only when the storage mode is set to Deci and the time scale is set to a certain value or greater.)

### What does it mean...

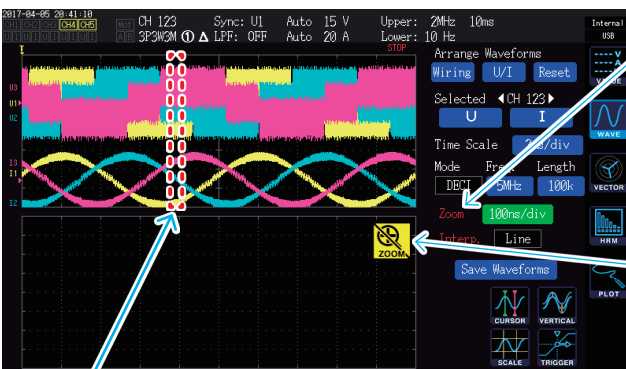

**When Zoom is shown in red**  
Zoom will be shown in red if the display and zoom settings do not match because the zoom setting was changed while an enlarged waveform was being displayed in the zoom display area

**When  is shown**  
When storage has been stopped with the **[RUN/STOP]** key, the icon may not be displayed. Acquire a waveform using the **[SINGLE]** key (p. 104).

**When a broken red line is shown**  
The zoom factor or position have not been set appropriately. Change the zoom settings.  
Examples: If the zoom region extends outside the screen.



## 4.5 Viewing FFT Analysis Results

The instrument can carry out an FFT analysis of the voltage and current for a selected channel and display the results as a graph or as numerical values up to 2 MHz. Motor analysis and D/A-equipped models can also perform FFT analysis of analog input signals. This capability is convenient when you wish to observe an inverter's carrier frequency or observe high-frequency noise affecting a commercial power supply line or DC power supply.

### Displaying waveforms and FFT analysis results

This section describes how to display the waveform that is subject to FFT analysis as well as the corresponding FFT analysis results. FFT analysis is performed for the waveform that is displayed in the window shown in the waveform display area (see figure below). Consequently, FFT analysis cannot be performed without displaying the waveform.

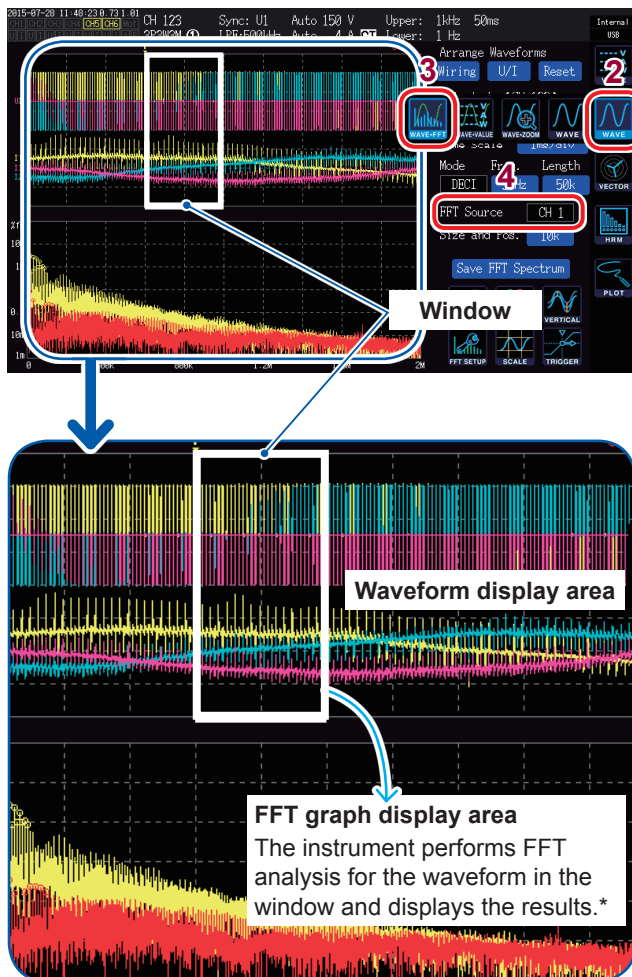

1 Press the **[MEAS]** key.

2 Touch **WAVE**.

3 Touch **WAVE+FFT**.

4 Touch **FFT Source**.

FFT analysis will be performed for the waveform from the channel selected here. Available settings: **CH1** to **CH6**, **CH AB** (motor analysis and D/A-equipped models only)

5 Acquire a waveform with the **[SINGLE]** key.

The FFT analysis results for the waveform in the window will be displayed in the FFT graph display area.

Graph axis	
Vertical	Logarithmic display of level (% f.s. or RMS value)
Horizontal	Linear display of frequency

Graph color	
Yellow	Voltage or CHA
Red	Current or CHB

- \* Immediately after the window position and point count settings are changed, it may take some time for the changed settings and the content of the window to match.
- \* When performing FFT analysis, acquire waveforms using the SINGLE trigger (p. 104).

## Changing the window size and position

You can move the window position horizontally and change the window size by changing the number of points for which FFT analysis is performed.

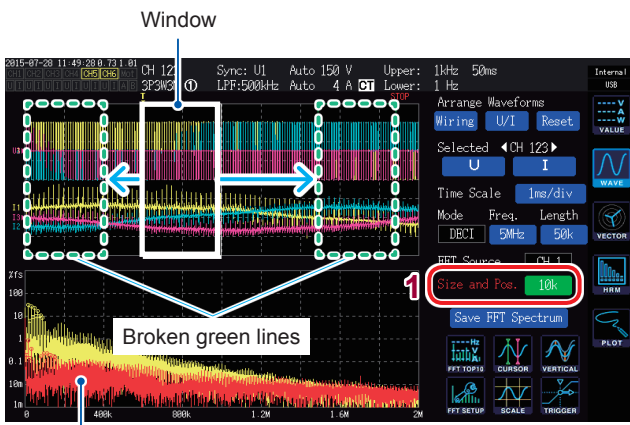

FFT graph display area (p. 107)

- The broken green lines indicate the position of the window after the position and point count settings have been changed.
- The FFT analysis results for the waveform in the window indicated by solid white lines are shown at the bottom of the screen.

### 1 Touch Size and Pos.

When you touch a value, the rotary knob's light will turn green.

### 2 Set the number of points for which to perform FFT analysis (the window size) with the X rotary knob.

Available settings: **1 k, 5 k, 10 k, 50 k**

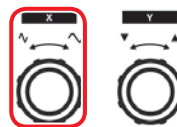

Turning the rotary knob: Select  
Pressing the rotary knob: Select → The knob's light will turn off.

### 3 Change the position of the window with the Y rotary knob.

The position of the broken green lines will move horizontally.

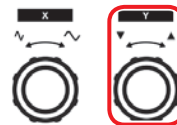

Turning the rotary knob: Select  
Pressing the rotary knob: Select → The knob's light will turn off.

## What does it mean...

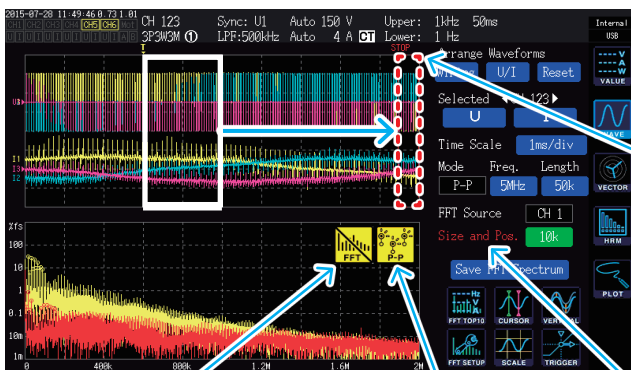

#### When is shown

When storage has been stopped with the **[RUN/STOP]** key, the icon may not be displayed. Acquire a waveform using the **[SINGLE]** key (p. 104).

#### When is shown

P-P has been selected as the storage mode (see p. 109).

#### When a broken red light is displayed

The window's position has not been set appropriately. FFT analysis cannot be performed under these conditions. Set the window position again.

- Examples
- If the number of points is greater than the recording length
  - If the window size and point count do not match

#### When **Size and Pos.** is shown in red

**Size and Pos.** will be shown in red if the FFT analysis results display and **Size and Pos.** settings do not match because the **Size and Pos.** settings were changed while the FFT analysis results were being displayed.

The maximum frequency for which the instrument can perform FFT analysis varies with the sampling speed (Freq.) setting as described below. The maximum analysis frequency is obtained by subtracting the frequency resolution from the frequency in the table.

Sampling	5 MS/s	2.5 MS/s	1 MS/s	500 kS/s	250 kS/s	100 kS/s	50 kS/s	25 kS/s	10 kS/s
Maximum frequency (Voltage and current)	2 MHz	1 MHz	400 kHz	200 kHz	100 kHz	40 kHz	20 kHz	10 kHz	4 kHz
Maximum frequency (Motor input)	20 kHz	20 kHz	20 kHz	20 kHz	20 kHz	20kHz	20 kHz	10 kHz	4 kHz

Since sampling of motor input analog waveforms operates at a maximum of 50 kS/s, the maximum frequency for which FFT analysis can be performed differs from the maximum frequency for voltage and current waveforms.

In addition, combining the sampling speed and point count settings causes the frequency resolution of FFT analysis to vary as follows:

#### Voltage and current waveforms

Sampling	5 MS/s	2.5 MS/s	1 MS/s	500 kS/s	250 kS/s	100 kS/s	50 kS/s	25 kS/s	10 kS/s
Number of points									
1000	5 kHz	2.5 kHz	1 kHz	500 Hz	250 Hz	100 Hz	50 Hz	25 Hz	10 Hz
5000	1 kHz	500 Hz	200 Hz	100 Hz	50 Hz	20 Hz	10 Hz	5 Hz	2 Hz
10000	500 Hz	250 Hz	100 Hz	50 Hz	25Hz	10 Hz	5 Hz	2.5 Hz	1 Hz
50000	100 Hz	50 Hz	20 Hz	10 Hz	5 Hz	2 Hz	1 Hz	0.5 Hz	0.2 Hz

#### Motor input waveforms

Sampling	5 MS/s to 50 kS/s	25 kS/s	10 kS/s
Number of points			
1000	50 Hz	25 Hz	10 Hz
5000	10 Hz	5 Hz	2 Hz
10000	5 Hz	2.5 Hz	1 Hz
50000	1 Hz	0.5 Hz	0.2 Hz

Since sampling of motor input analog waveforms operates at a maximum of 50 kS/s, the frequency resolution of FFT analysis differs from frequency resolution for voltage and current waveforms.

- When P-P is selected as the storage mode, FFT analysis is performed using the maximum value from the peak-peak compression results. In this case, the  mark will be displayed on the screen.
- When DECI is selected as the storage mode, the instrument's internal digital anti-aliasing filter will be automatically enabled based on the sampling settings. Consequently, the effects of aliasing can be limited even when a slow sampling setting is used. When the storage mode is P-P, the digital anti-aliasing filter will not be enabled.
- FFT calculations are performed only when the WAVE+FFT screen is displayed. Consequently, updates to the waveform display and other functionality on this screen may exhibit delays.

## Displaying FFT analysis results as values

This section describes how to select 10 FFT analysis result values in order, starting with data points with large voltage or current values, and display the frequency and level for each (known as the FFT peak value display). For motor analysis and D/A-equipped models, similar data can be displayed for FFT analysis results for analog input signals.

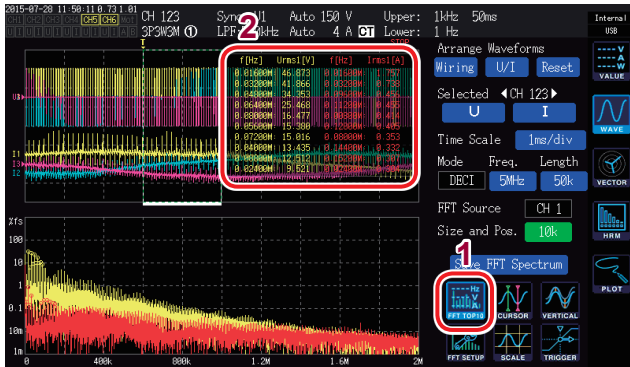

FFT TOP10 measured values can be sent to a computer using the LAN, GP-IB, or RS-232C interface.

### 1 Touch **FFT TOP10**.

The FFT TOP10 window will open.

Number of displayed digits: 6  
The number of digits changes to reflect the range of the target waveform.

Display items: Frequency and level

## Turning the display of FFT analysis results on and off

Display of the FFT analysis results can be turned on and off.

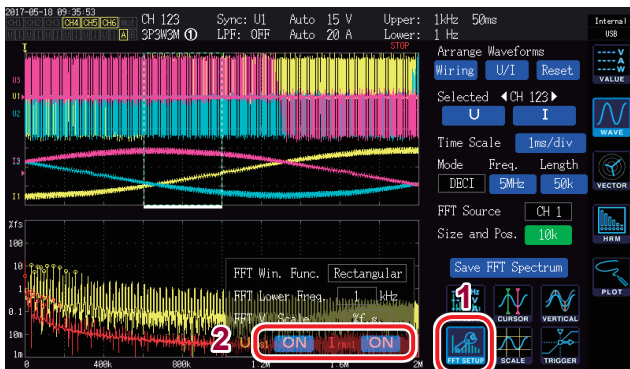

### 1 Touch **FFT SETUP**.

### 2 Touch **ON** or **OFF** for each display item to toggle it on or off.

## Setting the lower limit frequency for the FFT peak value display

This section describes how to set the lower limit frequency to use when displaying FFT peak values.



1 Touch **FFT SETUP**.

2 Touch **FFT Lower Freq.**

Enter the lower limit frequency with the numeric keypad.

Values shown as part of the FFT peak value display for voltage, current, and motor input waveforms are considered to be peak values when their level is less than that of adjacent data points. Ten such data points are acquired, starting with peak values with higher levels.

At this time, data points with frequencies that are lower than the FFT analysis lower limit frequency setting are not included in the peak value display.

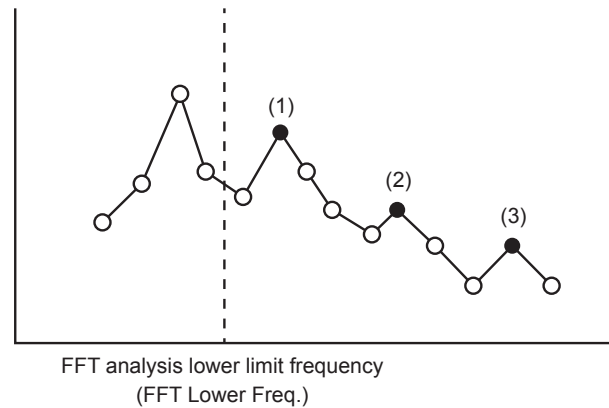
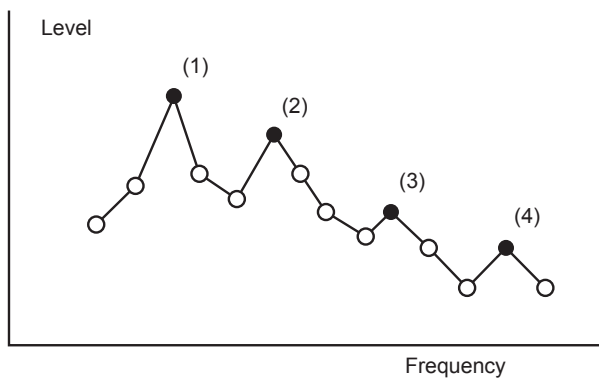

## Setting the window function

This function describes how to set the window function used in FFT analysis.

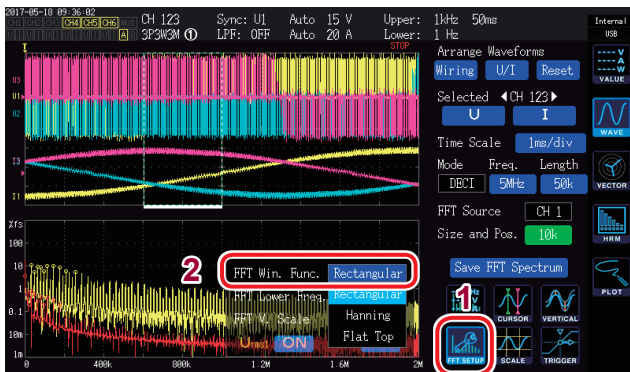

- 1 Touch **FFT SETUP**.
- 2 Touch **FFT Win. Func.** and select the desired window function.

<b>Rectangular</b>	This function is effective when the period of the measured waveform is an integral multiple of the FFT calculation interval.
<b>Hanning</b>	This function is effective in instances where (a) you wish to emphasize frequency resolution and (b) the rectangular function is not effective.
<b>Flat-top</b>	This function is effective in instances where (a) you wish to emphasize level resolution and (b) the rectangular function is not effective.

### What is a window function?

FFT calculations extract a portion of the measured waveform for the set number of points at the set sampling speed. The processing used to extract this waveform is known as window processing. For the purpose of FFT calculations, it is assumed that the waveform extracted using this finite interval repeats regularly. For the PW6001, the interval enclosed by the solid white lines corresponds to this window.

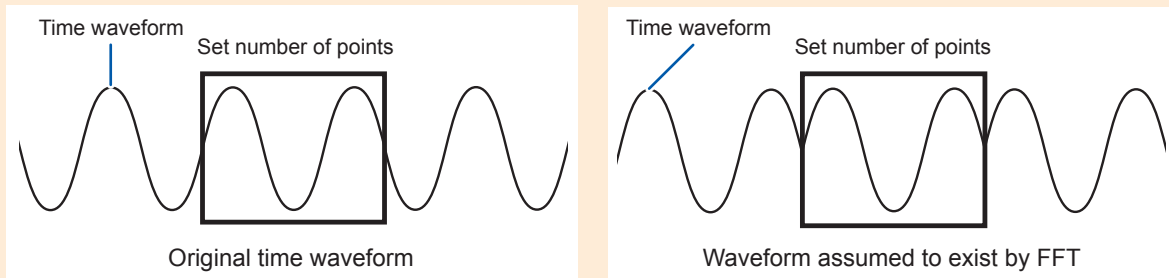

If the number of FFT calculation points does not match the period of the measured waveform, both ends of the waveform in the window will be discontinuous, causing an error known as a leakage error and leading to the detection of FFT analysis results that do not in fact exist. Window functions, which were conceived as a means of limiting such leakage errors, perform processing that helps ensure both ends of the extracted waveform are smooth.

## Changing the scale of the vertical axis on the FFT analysis results display

You can set the scale of the vertical axis on the FFT analysis results display as the percentage of full scale (% f.s.) or the RMS value.

### When %f.s. is selected

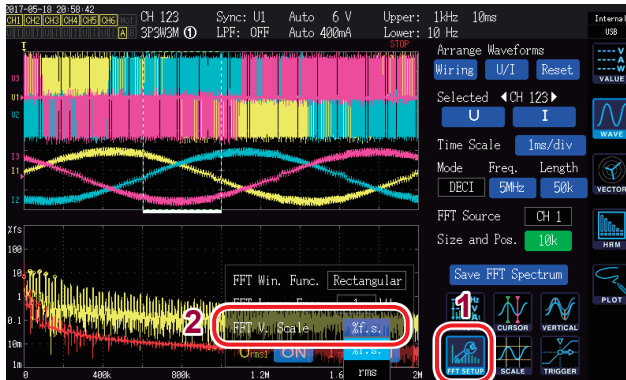

- 1 Touch **FFT SETUP**.
- 2 Touch **FFT V. Scale**, and select the desired scale for the vertical axis.

### When rms is selected

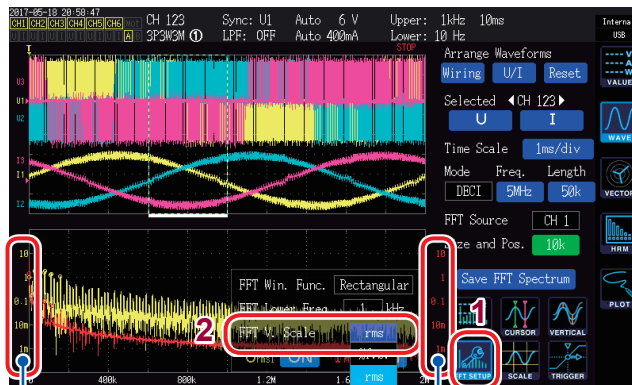

The current scale is shown in yellow.

The voltage scale is shown in red.





## 5.1 Time Control Function

The time control function enables auto-saving, integration functionality, and hold/peak hold functionality to be controlled based on the time.

See “Performing integration while using the time control function”(p. 70), “Automatically saving measurement data”(p. 147), “5.3 Hold and Peak Hold Functions”(p. 119).

### Before performing integration or saving data using the time control function

- Be sure to set the clock (current time) before auto-saving data or using the integration function. See “6 Changing System Settings”(p. 137).
- Auto-save operation and the integration function cannot be configured separately.
- The integration function must be operating. After stopping time control, press the **[DATA RESET]** key to reset integration values.
- The instrument will not operate unless you press the **[START/STOP]** key, even if the time settings have been configured.

### Interval time control

Interval time control repeats control over a fixed time interval.

- When timer time control and actual time control are **OFF**, auto-saving and integration will stop at 9999 hr. 59 min. 59 sec.
- If the interval setting is longer than the timer time or actual time control time setting, interval time control will not be performed.
- If the timer time or actual time control time end time differs from the interval time end time, the timer time or actual time control time end time will take precedence.
- Changing the interval will cause the maximum number of recording parameters to vary. (As the interval increases, the maximum number of recording parameters will increase.) See “Setting which measurement parameters to save”(p. 144).

### Timer time control

Timer time control stops auto-saving and integration automatically once the set timer time has elapsed. When used in combination with the interval time, it is possible to perform control by subdividing the timer time using intervals.

- If the actual time control time has been set so that it is longer than the timer time, integration will start at the actual time control start time and end at the timer time. (The actual time control stop time will be ignored.)
- If the **[START/STOP]** key is pressed before the timer time ends, integration will stop, and integration values will be retained. If the **[START/STOP]** key is pressed again in this state, integration will resume and be performed for the timer set time (cumulative integration).

### Actual time control

Actual time control enables control to be started and stopped by specifying times. In addition, when used in combination with interval time control, it is possible to perform control by subdividing the actual time control time using intervals.

- If the actual time control time is set so that it is longer than the timer time, integration will start at the actual time control start time and end at the timer time. (The actual time control stop time will be ignored.)
- If the set time is in the past, actual time control will be treated as if it were set to **OFF**.
- If integration is stopped during actual time control, actual time control will be set to **OFF**.

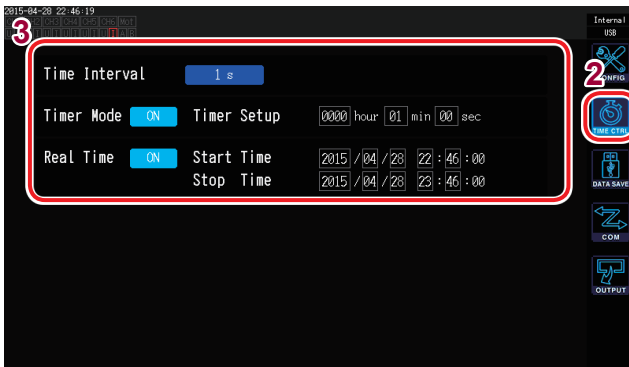

- 1 Press the **[SYSTEM]** key.
- 2 Touch **TIME CTRL**.
- 3 Touch each setting and select the desired value.

Parameter	Settings	Description
Time Interval	When the data update rate is 10 ms <b>OFF, 10 ms, 50 ms, 200 ms, 500 ms, 1 s, 5 s, 10 s, 15 s, 30 s, 1 min, 5 min, 10 min, 15 min, 30 min, 60 min</b>	<ul style="list-style-type: none"> <li>• The selections vary depending on the data update rate setting (<b>Meas. Interval</b>) “Setting the data update rate”(p.59).</li> <li>• When the averaging function’s <b>Averaging mode</b> setting is set to <b>ADD</b> (simple average), intervals that are shorter than the data update interval as determined by the number of averaging iterations setting cannot be selected “Averaging Function”(p.117).</li> </ul> Setting method (Y rotary knob: Turns green.) Turn rotary knob: Select Press rotary knob: Enter → The knob’s light will turn off.
	When the data update rate is 50 ms <b>OFF, 50 ms, 200 ms, 500 ms, 1 s, 5 s, 10 s, 15 s, 30 s, 1 min, 5 min, 10 min, 15 min, 30 min, 60 min</b>	
	When the data update rate is 200 ms <b>OFF, 200 ms, 500 ms, 1 s, 5 s, 10 s, 15 s, 30 s, 1 min, 5 min, 10 min, 15 min, 30 min, 60 min</b>	
Timer Mode	<b>ON</b>	Turns the timer setting <b>ON</b> . Timer time control will stop once the timer time ( <b>Timer Setup</b> ) has elapsed after starting.
	<b>OFF</b>	Turns the timer setting <b>OFF</b> . Timer time control will not be performed.
Timer Setup (Timer time)	<b>hour, min, sec</b>	Sets the timer setting when the <b>Timer Mode</b> is <b>ON</b> . Valid setting range: <b>0 hour 0 min 10 sec to 9999 hour 59 min 59 sec</b> Enter values using the numeric keypad window (p.29).
Real Time	<b>ON</b>	Starts time control at the <b>Start Time</b> and stops time control at the <b>Stop Time</b> .
	<b>OFF</b>	Disables actual time control.
Start Time/ Stop Time	<b>Year, month, day, hour, min</b>	Sets the <b>Start Time/Stop Time</b> when <b>Real Time</b> is set to <b>ON</b> . Use the Western year and 24-hour style hour. Set in increments of 1 min. Example: 10:16 pm on February 13, 2015 → <b>2015/2/13 22:16:00</b> Upper limit for time Start time: <b>2077/12/31 23:59:00</b> Stop time: <b>2077/12/31 23:59:00</b> Enter values using the numeric keypad window (p.29).

## 5.2 Averaging Function

The averaging function averages measured values and displays the result. This function can be used to obtain more stable display values when measured values fluctuate and cause large variations in the display.

During averaging, the averaging setting indicator at the top of the screen will light up.

See “Measurement Screen Display”(p.31).

The instrument provides two averaging modes.

### Simple average (ADD)

In this mode, the number of measured values indicated by the number of averaging iterations are averaged at each data update rate (**Meas. Interval**), and output data is updated. This mode may be combined with interval time control to record average values during the time. In this case, select the number of averaging iterations so that the interval and data update interval agree. The data update interval will vary as shown below based on the number of averaging iterations settings:

Data update rate	Number of averaging iterations				
	5	10	20	50	100
<b>10 ms</b>	50 ms	100 ms	200 ms	500 ms	1 s
<b>50 ms</b>	250 ms	500 ms	1 s	2.5 s	5 s
<b>200 ms</b>	1 s	2 s	4 s	10 s	20 s

### Exponential average (EXP)

In this mode, data is subject to exponential averaging using the time constant defined by the exponential averaging response speed. It does not affect the display update rate. The response speed varies based on the data update rate.

Data update rate	Response speed		
	FAST	MID	SLOW
<b>10 ms</b>	0.1 s	0.8 s	5 s
<b>50 ms</b>	0.5 s	4 s	25 s
<b>200 ms</b>	2.0 s	16 s	100 s

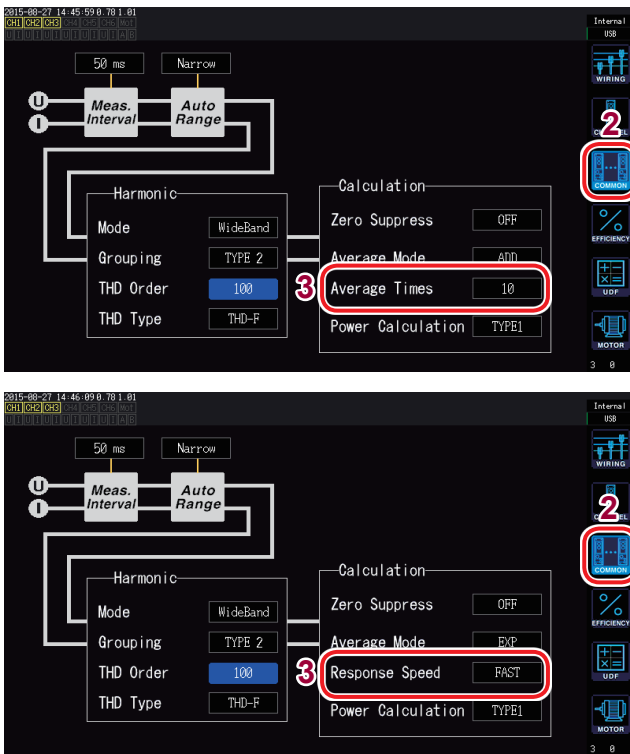

- 1 Press the **[INPUT]** key.
- 2 Touch **COMMON**.
- 3 Touch each setting and select the desired value.

Parameter	Setting	Description
Average Mode	ADD	Simple average (Set the number of averaging iterations.)
	EXP	Exponential average (Set the response speed.)
Average Times	5, 10, 20, 50, 100	
Response speed	FAST	See "Exponential average (EXP)" (p. 117).
	MID	
	SLOW	

### Averaging operation

- Averaging functions for all measured values except the voltage peak value, current peak value, integration values, and harmonic data when using a 10 ms data update interval.
- It applies not only to display values, but also to measured values saved in the instrument's memory, measured values acquired using communications, and measured values output as an analog signal.
- When a measured value-related setting such as the connection or range changes, averaging calculation is restarted. In this case, since no average value exists until the next data update, measured values during this period will be invalid.
- When averaging and auto-range operation are used together, it may take longer than normal for measured values to stabilize on the correct value.
- Integration measured values during averaging operation are calculated from measured values prior to averaging operation.
- Internal averaging calculations continue even when measured values are being held by the hold function.
- The peak hold function applies to measured values after averaging operation.

### Over-range operation

When an over-range event occurs during simple averaging, the average value will be considered over-range as well. When a range-over event occurs during exponential averaging, averaging calculations will continue using internal calculation values.

- Settings cannot be switched by on a connection or channel basis.
- The measured value invalid interval after the range is changed varies with settings.
- Waveforms shown on the screen and D/A output waveforms are not affected by averaging.
- For more information about averaging calculation methods for different types of measured values, see the section about averaging in the calculation specifications. See "10.5 Calculation Formula Specifications"(p.241).

## 5.3 Hold and Peak Hold Functions

### Hold function

By pressing the **[HOLD]** key, you can stop display updates for all measured values and hold the data at the time the key was pressed. By switching screens in that state, you can view other measurement data at the time data was held. In addition, the same operation as the **[HOLD]** key can be performed using the HOLD external control signal.

During hold operation, the **[HOLD]** key will turn red, and the **HOLD** mark on the screen's operating status indicator will light up.

See "1.4 Basic Operation (Screen Display and Layout)"(p.27).

### Canceling the hold state

Press the **[HOLD]** key again during hold operation to cancel the hold state.

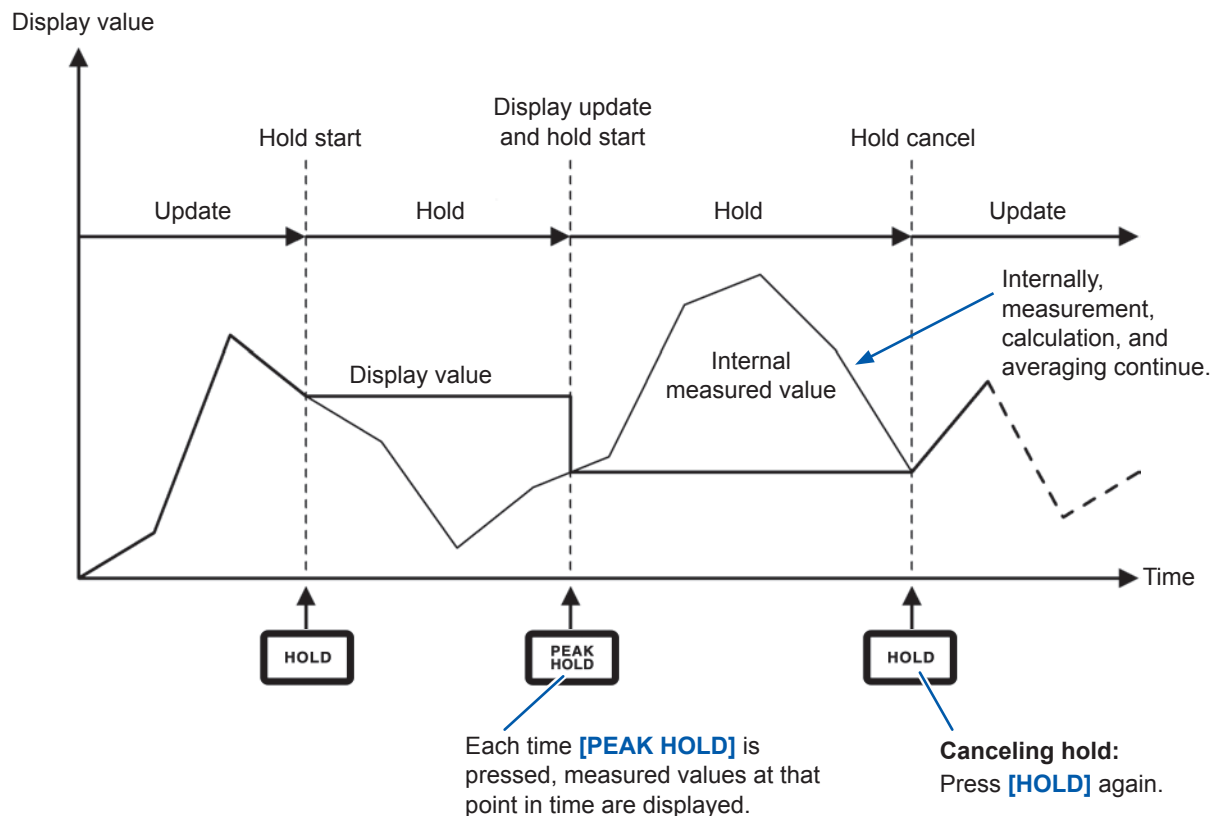

## Operation in the hold state

- Hold operation also applies to the following measured values:
  1. Measured values stored in the instrument's memory
  2. Measured values acquired using communications
  3. Measured values output as an analog signal
- Waveforms, the clock, and the peak-over display are updated.
- In the following circumstances, data is updated with the latest internal data:
  1. When the **[PEAK HOLD]** key is pressed
  2. When the time control function's interval time is reached
  3. When the HOLD external control signal is detected
- Auto-saving when an interval has been set saves the data immediately prior to the update.
- Averaging and integration calculations continue to be performed internally.
- Settings that affect measured values, for example range and LPF settings, cannot be changed.
- When the range is set to **AUTO**, auto-range operation is canceled, and the range is fixed to the range at the time the **[HOLD]** key was pressed.
- The hold function cannot be used in combination with the peak hold function.

- Waveforms shown on the screen and D/A output waveforms are not affected by the hold function.
- Data held during hold operation is not the data displayed when the **[HOLD]** key was pressed, but rather the data for each data update rate being held internally at the time the **[HOLD]** key was pressed.

## Peak hold function

Pressing the **[PEAK HOLD]** key places the instrument in the peak hold state. Only parameters whose values exceed the past peak value are updated. This function is used when you wish to thoroughly capture phenomena characterized by instantaneously large values, for example rush current.

During peak hold operation, the **[PEAK HOLD]** key will turn red, and the **PEAK HOLD** mark on the screen's operating status indicator will light up.

See "Common Screen Display"(p.30).

### Canceling the peak hold state

Press the **[PEAK HOLD]** key again during peak hold operation to cancel the peak hold state.

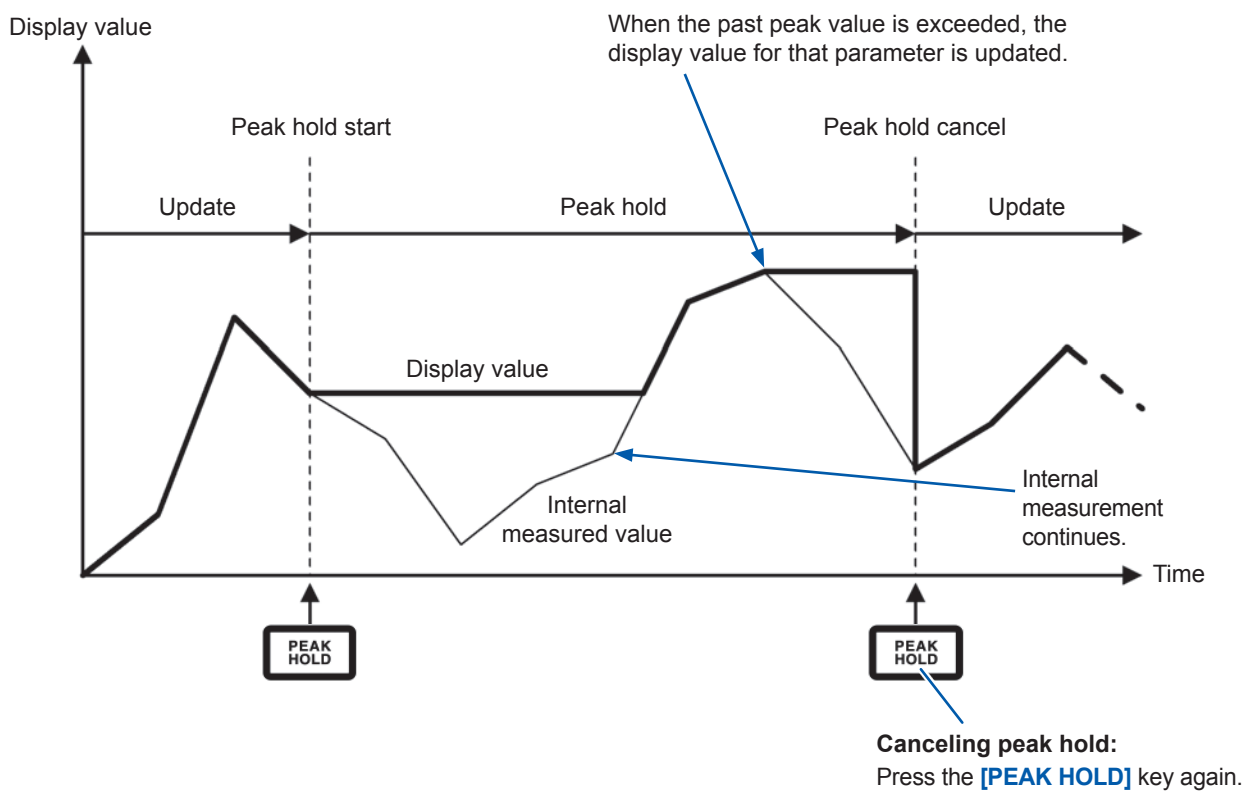

### Usage in combination with the time control function

When an interval has been set, the peak hold function can be used to measure the maximum value during the interval time. When the timer time or actual time control time have been set, the instrument will display the maximum value from the start time to the stop time.

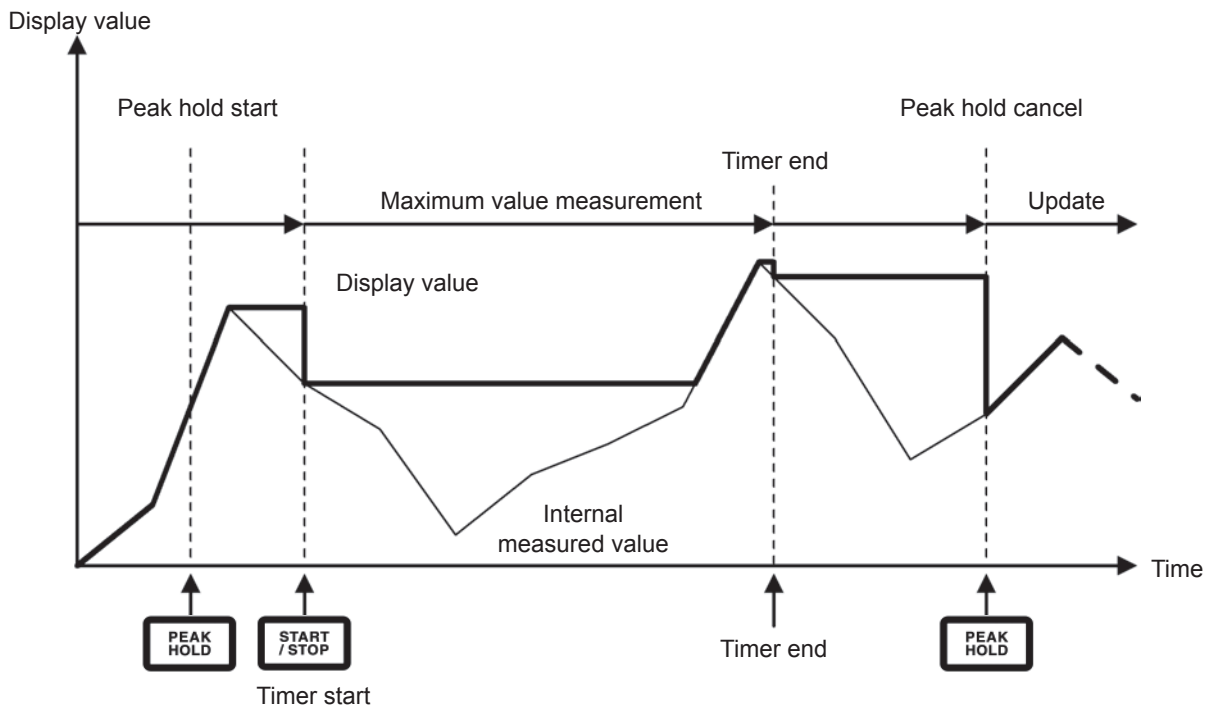
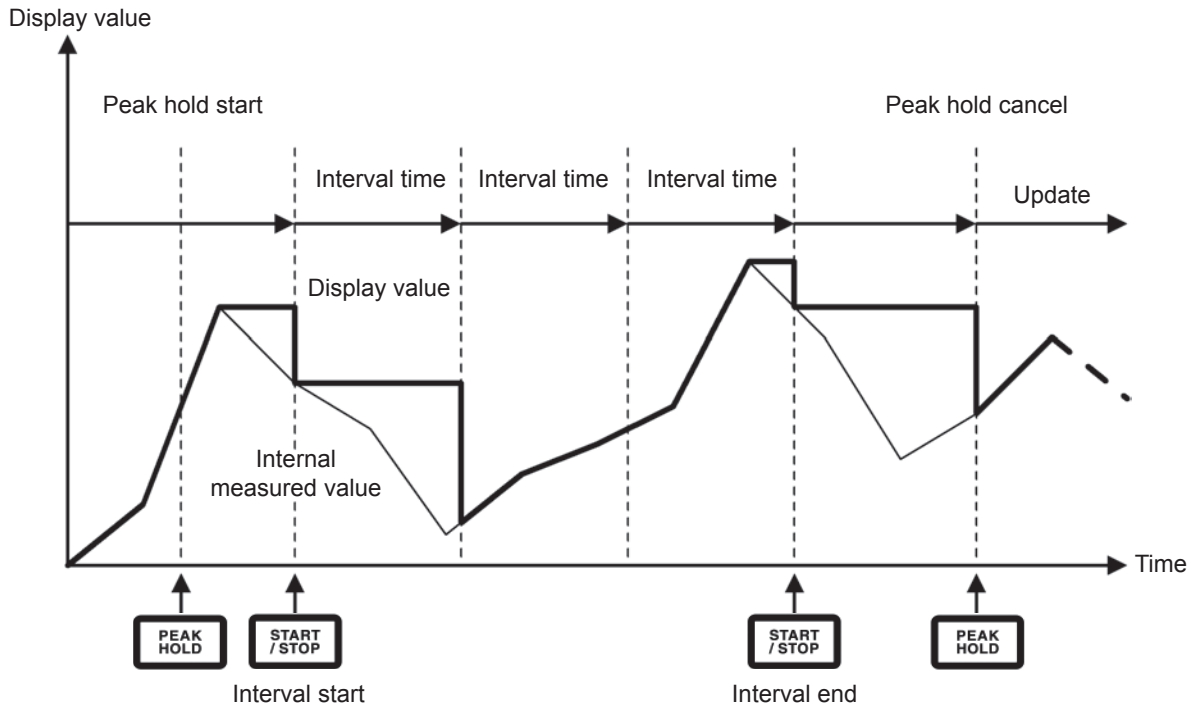



## Operation in the peak hold state

- Peak hold operation also applies to the following measured values:
  1. Measured values stored in the instrument's memory
  2. Measured values acquired using communications
  3. Measured values output as an analog signal
- Waveforms, the clock, and the peak-over display are updated.
- When the display goes over-range, it will show "-----." In this case, cancel peak hold operation and switch to a range in which the over-range event will not occur.
- The maximum value is determined using the absolute value of measured values. (However, this method does not apply to voltage or current peak values.) For example, if -60 W is input after inputting 50 W, the display would indicate -60 W since the absolute value of -60 W is greater than that of 50 W.
- In the following circumstances, the peak hold value is reset, and peak hold operation starts anew:
  1. When the **[HOLD]** key is pressed
  2. When the time control function's interval time is reached
  3. When the HOLD external control signal is detected
- Auto-saving when an interval has been set saves the data immediately prior to the update.
- During averaging calculation, peak hold operation applies to measured values after averaging.
- Settings that affect measured values, for example range and the LPF settings, cannot be changed.
- When the range is set to **AUTO**, auto-range operation is canceled, and the range is fixed to the range at the time the **[PEAK HOLD]** key was pressed.
- The peak hold function cannot be used in combination with the hold function.

- Waveforms shown on the screen and D/A output waveforms are not affected by the peak hold function.
- The time at which the maximum value occurred is not displayed.
- The peak hold function does not apply to integrated values.

## 5.4 Delta Conversion Function

The delta conversion function converts between a 3-phase measurement line delta connection and a Y connection (star connection) during measurement. The conversion is performed using voltage waveform data sampled at 5 MHz between different channels based on the formula.

### Δ-Y conversion

This function can be set to **ON** when the **Connection** is **3P3W3M** or **3V3A**. It enable the measurement using the phase voltage across the motor coil as a Y connection even when unable to access the midpoint of a motor wired internally as a Y connection that has been connected using a delta connection. The voltage waveform, voltage measured values, and harmonic voltage are all input as line voltages but calculated as phase voltages.

#### For a 3P3W3M connection

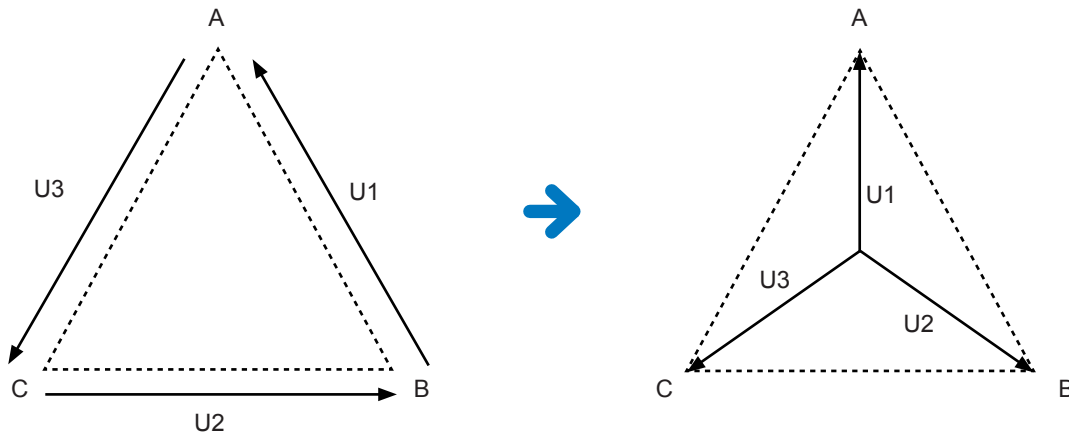

#### For a 3V3A connection

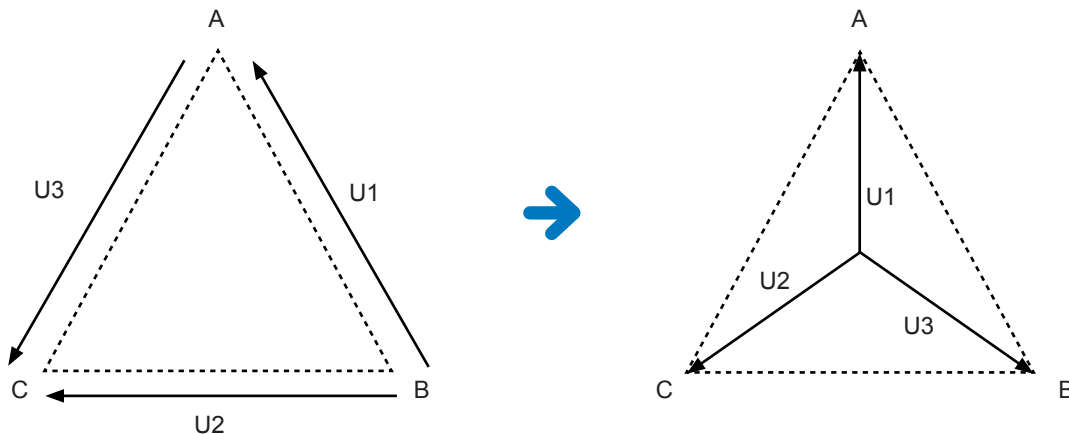

- In Δ-Y conversion, the voltage waveform is converted into vectors and analyzed using a virtual neutral point.
- The result may differ from the actual phase voltage.
- The vector diagram shown on the Connection screen is the same as the 3P4W vector diagram. For a 3V3A connection, the only difference is that the phase sequence is reversed.
- The two-wattmeter method is used to calculate active power for a 3V3A connection, but the three-wattmeter method is used after conversion.
- Peak-over is determined using pre-conversion values.
- When the voltage range is set to auto-range operation, voltage range changes are determined by multiplying the range by  $1/\sqrt{3}$  (multiplying by approximately 0.57735).

## Y- $\Delta$ conversion

This function can be set to **ON** when the **Connection** is **3P4W**. It enables the line voltage to be measured when phase voltage is input using a Y connection.

The voltage waveform, voltage measured values, and harmonic voltage are all input as phase voltages but calculated as line voltages.

### Illustration of Y- $\Delta$ conversion For a 3P4W connection

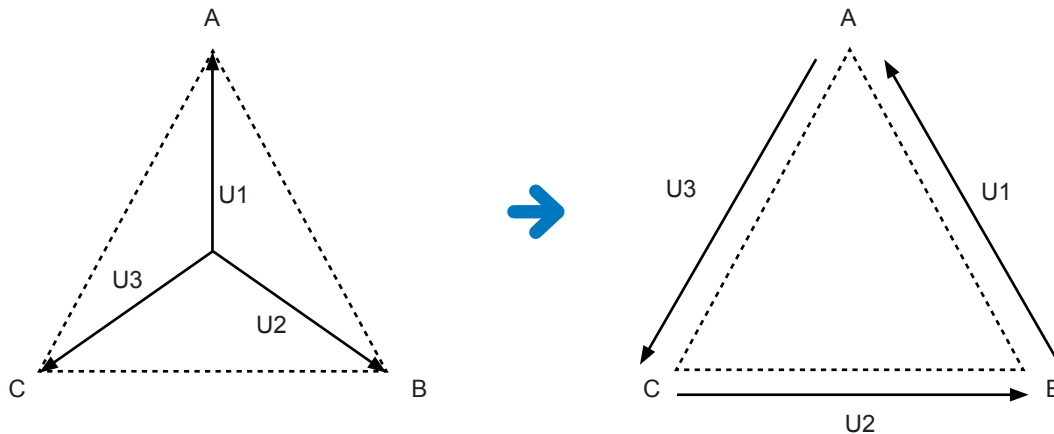

- The vector diagram shown on the Connection screen is the same as the 3P3W3M vector diagram.
- Peak-over and the voltage peak value display range are determined using pre-conversion values.
- When the voltage range is set to auto-range operation, voltage range changes are determined using post-conversion measured values.

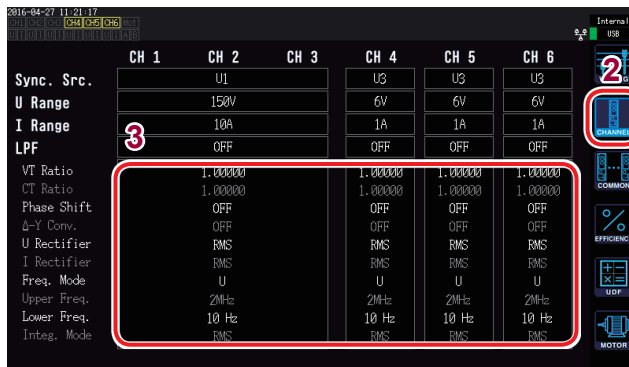

- 1 Press the **[INPUT]** key.
- 2 Touch **CHANNEL**.
- 3 Touch the channel detailed settings area for the channel you wish to configure.
- 4 Touch **Δ Conv.** and set it to **ON**.
- 5 Touch **×** to close the window.

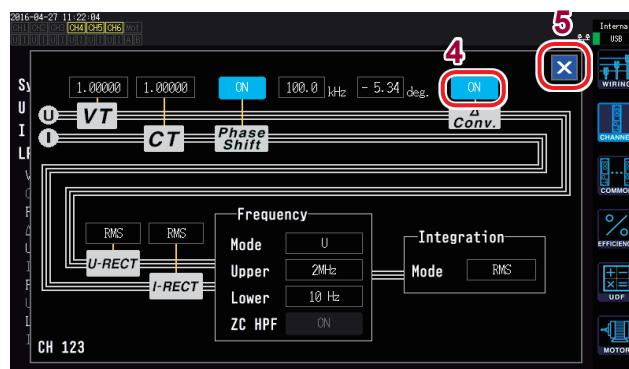

## 5.5 Selecting the Power Calculation Formula

This function enables you to select calculation formulas for reactive power, power factor, and power phase angle to mimic operation of legacy Hioki instruments. Since no standardized calculation formulas for apparent power and reactive power have been defined for distorted 3-phase AC signals, different instruments use different formulas. To increase compatibility with previous models, the instrument allows you to choose from three formula settings.

See “10.5 Calculation Formula Specifications”(p.241).

If you do not use the model in question or do not know which type to choose, select **TYPE1**.

<b>TYPE1</b>	Provides compatibility with the TYPE1 setting used by the Hioki model PW3390, 3390, and 3193.
<b>TYPE2</b>	Provides compatibility with the TYPE2 setting used by the Hioki model 3192 and 3193.
<b>TYPE3</b>	Uses the active power sign as the power factor sign.

- The different formulas do not yield different results for active power (even when the waveform is distorted) since that parameter is calculated directly from voltage and current waveform sampled values.
- The calculation formula that provides compatibility with the TYPE2 setting used by the Hioki PW3390 and 3390 is equivalent to selecting TYPE1 with a **3V3A** connection.

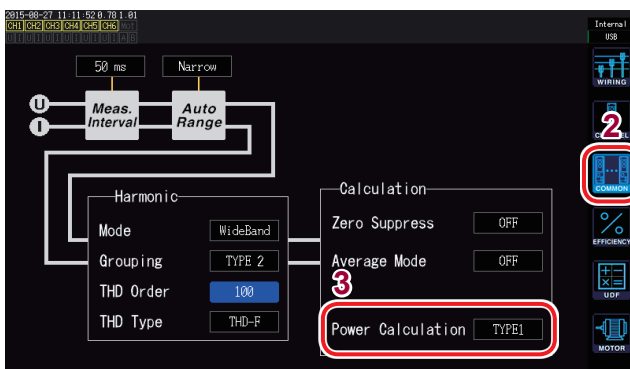

- 1 Press the **[INPUT]** key.
- 2 Touch **COMMON**.
- 3 Touch **Power Calculation** and select the desired type.

**TYPE1, TYPE2, TYPE3**

## 5.6 Current Sensor Phase Shift Function

Current sensors generally exhibit a tendency for phase error to increase gradually in the high-frequency region of their frequency band. By using sensor-specific phase characteristics information to correct this error, it is possible to reduce the error component in power measurements made in high-frequency regions.

### Illustration

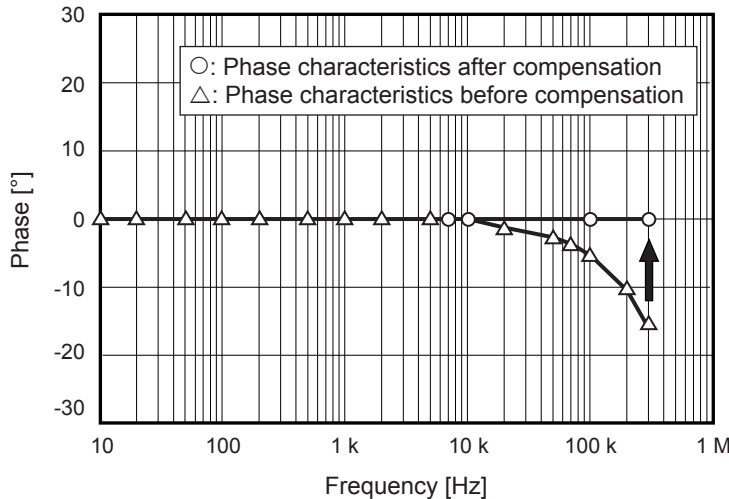

See the table below for information about current sensor phase characteristics. Example settings for the current sensor phase shift function are provided on the following page.

Table 1. Current sensor phase characteristics (representative values) (Ver. 02)

Model	Frequency [kHz]	Phase difference between input and output (representative value) [°]
CT6841	100.0	-1.82
CT6843	100.0	-1.68
CT6844	50.0	-1.29
CT6845	20.0	-0.62
CT6846	20.0	-1.89
CT6862	300.0	-10.96
CT6863	100.0	-4.60
CT6865	1.0	-1.21
CT6875	200.0	-10.45
CT6875-01	200.0	-12.87
CT6876	200.0	-12.96
CT6876-01	200.0	-14.34
CT6877	100.0	-2.63
CT6877-01	100.0	-3.34
CT6904	300.0	-9.82
9709	20.0	-1.11
PW9100	300.0	-2.80

These values are representative for the indicated sensors under the following conditions:

- Standard cable length (not using the extension cable)
- With the conductor positioned in the center of the sensor

Contact Hioki for more information about using the CT9557.

**Example for the CT6862: Setting a frequency of 300.0 kHz and a phase difference of -10.96°.**

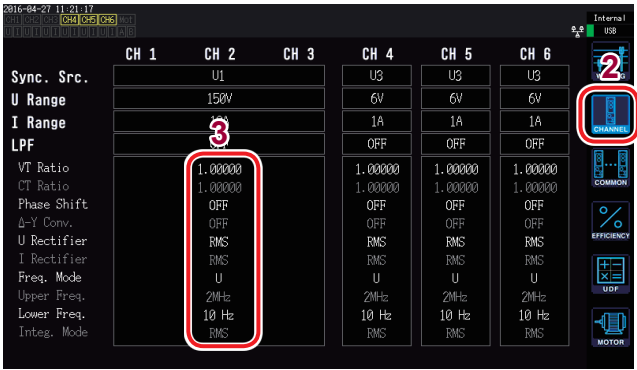

- 1 Press the **[INPUT]** key.
- 2 Touch **CHANNEL**.
- 3 Touch the channel detailed settings area for the channel you wish to configure.
- 4 Touch **Phase Shift** and set it to **ON**.
- 5 Touch the frequency and set it to **300.0 kHz**.

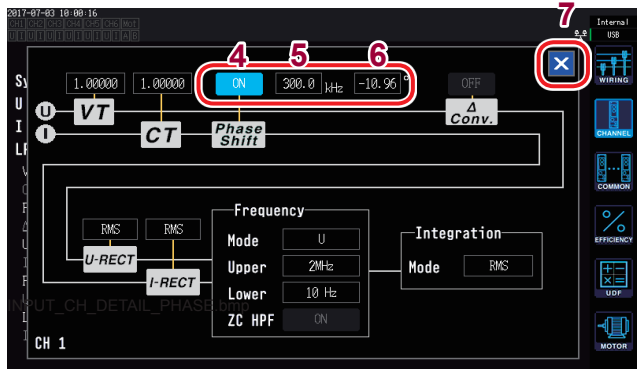

- 5 Touch the frequency and set it to **300.0 kHz**.  
Enter the value on the numeric keypad window "Numeric keypad windows"(p.29).
- 6 Touch phase difference and set it to **-10.96°**.  
Enter the value on the numeric keypad window.
- 7 Touch **x** to close the window.

- Enter values accurately as mistaken settings can cause the compensation process to increase measurement error.
- The single setting also applies to connections other than 1P2W. Enter the phase difference and frequency that correspond to the current sensor in use.
- Operation outside the frequency range within which the current sensor's phase accuracy is specified is not defined.

# 5.7 User-defined Calculations (UDF)

You can set calculation formulas that combine the instrument's measured values, numerical values, and functions. The set calculation values can be displayed on the measurement screen and used to perform calculations.



1 Press the **[INPUT]** key.

2 Touch **UDF**.

Available settings: **UDF1** to **UDF16**  
(16 formulas)

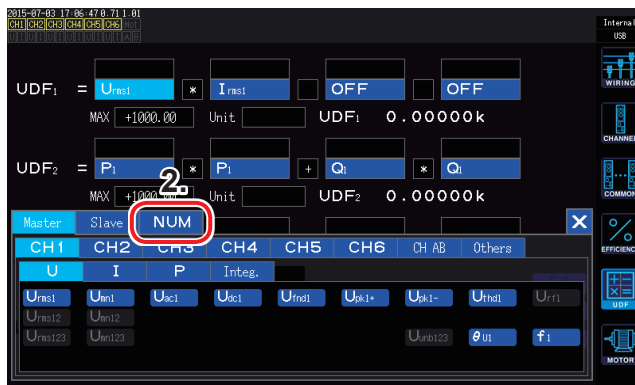

3 Touch a setting name.

1. The basic measurement parameter selection window will open.
2. Touch a setting to select it.
  - Previously set UDF formulas can also be selected.
  - Numerical values can also be entered (touch **NUM** and enter the value with the numeric keypad).

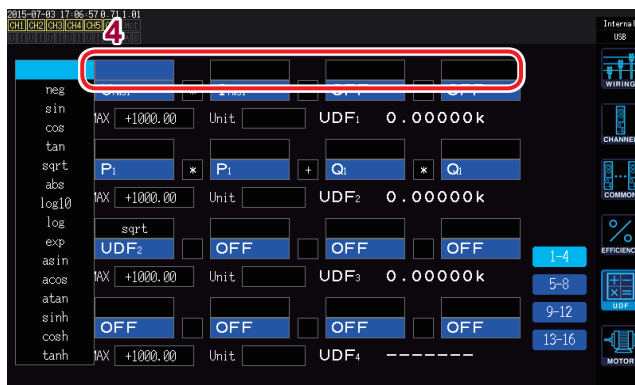

4 Select a function

<b>neg</b>	Negative
<b>sin, cos, tan</b>	Trigonometric functions *
<b>sqrt</b>	Square root
<b>abs</b>	Absolute value
<b>log10</b>	Common logarithm
<b>log</b>	Logarithm
<b>exp</b>	Exponent
<b>asin, acos, atan</b>	Inverse trigonometric functions *
<b>sinh, cosh, tanh</b>	Hyperbolic functions *

\* Angles are expressed in degrees (°), not radians.

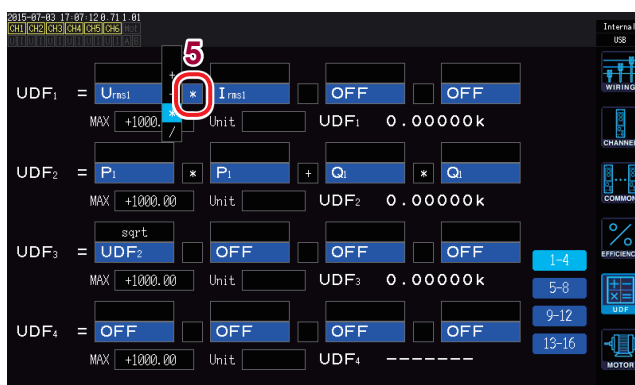

5 Select the basic arithmetic operator.

Available settings: **+**, **-**, **\***, **÷**

## 5

Using the Instrument's Functionality



## 6 Set the maximum value for the UDF.

The valid measurement range is 0% to  $\pm 100\%$  of the set maximum value.

### If you set +1.00000

UDF display digits: X.XXXXX

Valid measurement range: 0.00000 to  $\pm 1.00000$

### If you set +10000.0

UDF display digits: XX.XXXX k

Valid measurement range: 0.0000k to  $\pm 10.0000k$

## 7 Set the unit.

- You can enter the unit using the keyboard window.
- The unit entered here is also applied when displaying the UDF on the measurement screen.

Note that when a calculation formula includes measured values from the slave instrument while using user-defined calculations and two-instrument synchronization (numerical synchronization mode) together, synchronization may be interrupted. If synchronization is interrupted in error, the value may differ from the actual value. Even if the result of the calculation formula is displayed, operation will be as described below. Calculation formulas that include measured values from the slave instrument will be affected. Other calculation formulas that include the calculation formulas in question will also be affected.

- If numerical synchronization is interrupted after you select a measured value from the slave instrument for use in an efficiency calculation or a user-defined calculation, the results of calculation formulas that include measured values from the slave instrument will no longer be displayed on the screen (p.53)
- Under the above conditions, calculations will be performed as if the measured value from the slave instrument is zero, and the results will be reflected in other user-defined calculation formulas.



## 5.8 Simple Graph Function

### D/A monitor graph

You can display a graph of measured values selected for up to eight D/A output parameters as a time series.

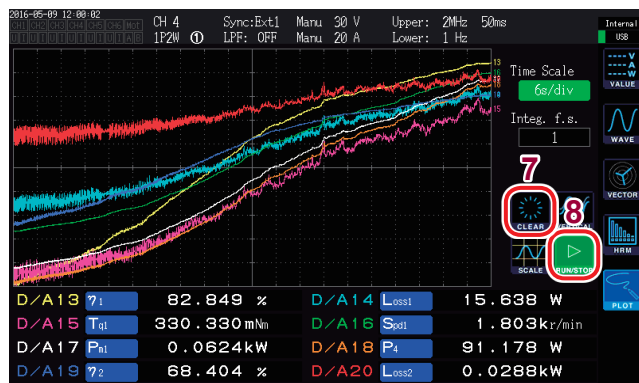
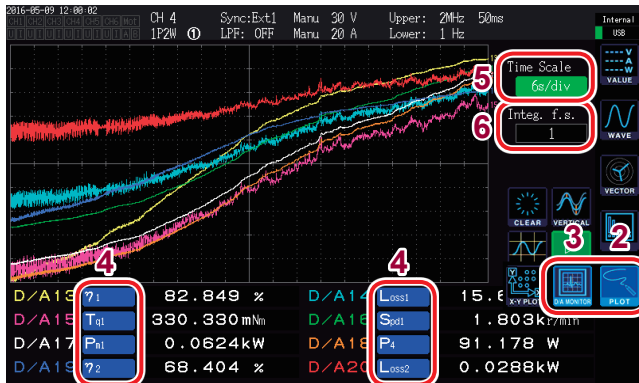

- 1 Press the **[MEAS]** key.
- 2 Touch **PLOT**.
- 3 Touch **D/A MONITOR**.
- 4 Select D/A output parameters.  
You can select and display any eight basic measurement parameters in the D/A output parameter display area.
- 5 Touch **Time Scale** and select the time axis with the X rotary knob.  
Available settings: 300ms/div, 1.5s/div, 3s/div, 6s/div, 12s/div, 30s/div, 1min/div, 3min/div, 6min/div, 10min/div, 30 min/div, 1h/div, 3h/div, 6h/div, 12h/div, 1day/div
- 6 Set the **Integ. f.s.** (integration full scale).  
Set if you wish to display integration values on the graph.(p.177)  
Available settings: 1/10, 1/2, 1, 5, 10, 50, 100, 500, 1000, 5000, 10000
- 7 Touch **CLEAR**.  
The displayed rendered data will be cleared.
- 8 Set whether to render waveforms or stop rendering waveforms.  
(Toggle rendering by touching the button.)

<b>RUN</b>	Renders the waveform.
<b>STOP</b>	Stops rendering the waveform.

- The D/A output parameters in the D/A monitor graph (D/A13 to D/A20) are linked to the D/A13 to D/A20 D/A output parameters (p.177) and D/A13 to D/A16 in the X-Y plot (p.133). Changing the set parameters in one of these locations will change them in the other locations as well.
- The **Integ. f.s.** (integration full scale) of the D/A monitor graph is linked to the integration full-scale for D/A output parameters(p.177) and the **Integ. f.s.** (integration full scale) of the X-Y plot (p.133). Changing the setting in one of these locations will change it in the other locations as well.
- Measured values in the graph rendered on the D/A monitor graph screen cannot be saved.
- To save the rendered screen, use the screenshot function (p.154).
- Performing any of the following operations will cause the rendered graph to be cleared and rendering of a new graph to begin:
  - Changing the waveform rendering setting from **STOP** to **RUN**
  - Setting D/A output parameters
  - Changing the **Time Scale**
  - Changing other settings that affect measured values (for example, ranges, connections, synchronization sources, or LPF)

## Detailed display settings

You can set whether to display rendered data for each D/A output parameter and set the maximum and minimum values for the vertical axis scale. The top of the graph render area will be set to the maximum value, and the bottom of the area will be set to the minimum value.

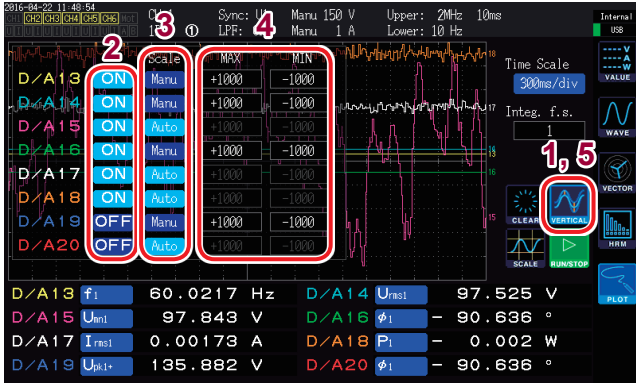

- 1 Touch **VERTICAL**.  
The detailed display settings window will open.

### To toggle the display

- 2 Touch **ON/OFF** for each D/A output parameter to toggle its display.

<b>ON</b>	Enables display of rendered data.
<b>OFF</b>	Disables display of rendered data.

### To set the vertical axis scale

- 3 Touch **Scale**.

<b>Manu</b>	Sets the scale manually.
<b>Auto</b>	Sets the scale automatically. Sets the maximum and minimum values automatically so that the graph fits on the screen.

### If Scale is set to Manu

- 4 Touch **MAX** or **MIN** and enter the desired value.

Enter the desired value using the numeric keypad window (p.29).

- 5 Touch **VERTICAL**.  
The window will close.

## Vertical axis scale display

Displays a list of vertical axis scale values for D/A output parameter rendering data for which the display setting has been set to ON.

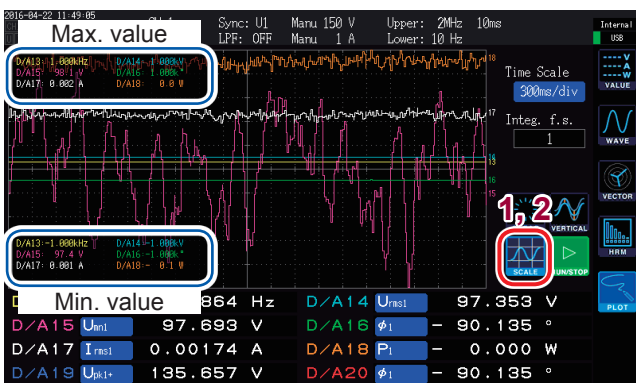

- 1 Touch **SCALE**.  
The vertical axis scale window will open.
- 2 Touch **SCALE** again.  
The window will close.

## X-Y plot function

You can have the instrument render a simple X-Y graph by selecting the X-axis (horizontal axis) and Y-axis (vertical axis) from the basic measurement parameters.

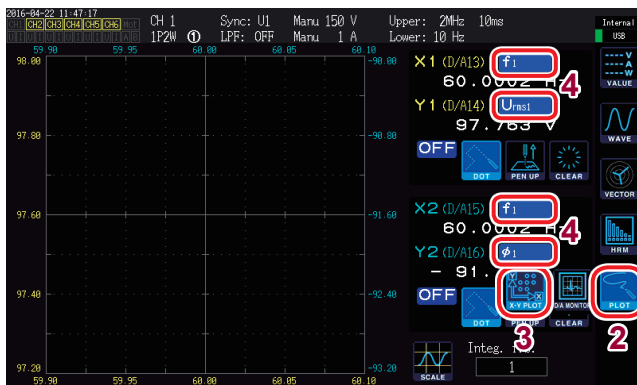

1 Press the **[MEAS]** key.

2 Touch **PLOT**.

3 Touch **X-Y PLOT**.

4 Select the display parameters.

Select the following four parameters: X1, Y1, X2, and Y2.

You can display graphs for a total of two pairs of parameters (X1-Y1 and X2-Y2).

- X1-Y1 graph
  - X1-axis scale: At bottom of rendering area (in yellow)
  - Y1-axis scale: At left of rendering area (in yellow)
- X2-Y2 graph
  - X2-axis scale: At top of rendering area (in light blue)
  - Y2-axis scale: At right of rendering area (in light blue)

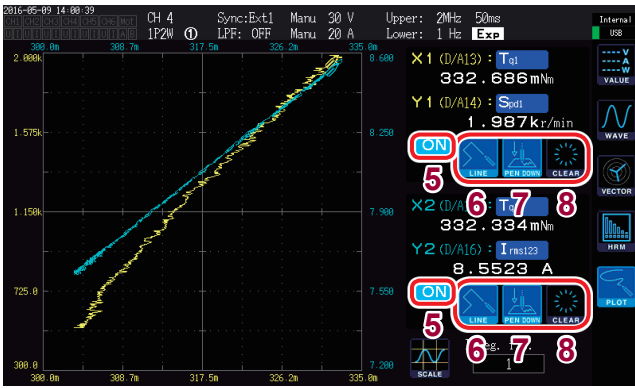

**5 Select whether to display the plot.**

(Touching the button will toggle the display on and off.)

<b>ON</b>	Enables the plot display.
<b>OFF</b>	Disables the plot display.

**6 Select the interpolation method to use for rendered points.**

(Touching the button will toggle the display on and off.)

<b>DOT</b>	Renders measured values using dots (points). (Without interpolation)
<b>LINE</b>	Interpolates between measured values to render them as a line.

**7 Touch **PEN UP** or **PEN DOWN** to enable or disable rendering operation.**

(Touching the button will toggle the display on and off.)

<b>PEN UP</b>	Disables rendering.
<b>PEN DOWN</b>	Enables rendering.

**8 Touch **CLEAR**.**

Clears the displayed graph.

- Measured values for each data refresh rate interval are rendered based on the display refresh rate. A pen mark (✎) is displayed at each rendering location.
- The D/A13 to D/A16 parameters set for the X-Y plot are linked to the D/A output parameters and the D/A13 to D/A16 output parameters being graphed by the D/A monitor (p. 131).
- Measured values in the graph rendered on the X-Y plot screen cannot be saved.
- To save the rendered screen, use the screenshot function (p. 154).
- Performing any of the following operations will cause the rendered graph to be cleared and rendering of a new graph to begin:
  - Changing the display parameters
  - Changing other settings that affect measured values (for example, ranges, connections, synchronization sources, or LPF)

## Vertical axis/horizontal axis scale settings, integration full-scale setting

This section describes how to set the scale for the vertical axis and horizontal axis in the graph rendering area for the X-Y plot function.

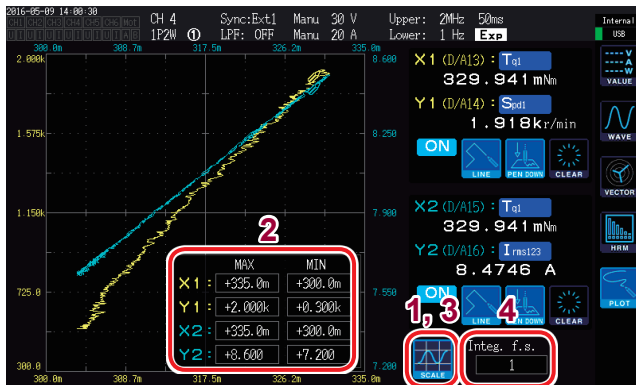

### 1 Touch **SCALE**.

The vertical axis/horizontal axis scale window will open.

### 2 Set the display maximum and minimum values.

Touch MAX/MIN and enter the desired values in the numeric keypad window.

### 3 Touch **SCALE** again.

The window will close.

### 4 Set **Integ. f.s. (integration full scale)**.

Set if you wish to display integration values in X-Y plot (p. 177).

**Available values: 1/10, 1/2, 1, 5, 10, 50, 100, 500, 1000, 5000, 10000**

The **Integ. f.s.** (integration full scale) of the X-Y plot is linked to the integration full scale for D/A output parameters (p. 177) and the **Integ. f.s.** (integration full scale) of the D/A monitor graph (p. 131). Changing the setting in one of these locations will change it in the other locations as well.



# 6

# Changing System Settings

## Checking and changing settings

This section describes how to check the instrument's software version and change settings such as the display language and beep tone.



**1** Press the **[SYSTEM]** key.

**2** Touch **CONFIG**.

You can check and configure the following settings:

- Display language
- Beep tone
- Startup screen
- Clock
- Correcting the touch panel (p. 138).
- Serial number: The serial number consists of 9 digits. The first two (from the left) indicate the year of manufacture, and the next two indicate the month of manufacture.
- Instrument software version

Parameter	Settings	Description
Language	Sets the language used for the instrument's display.	
	Japanese	Japanese
	English	English
Beep	Sets whether to sound a beep tone to signal key and touch panel operation.	
	ON	Enables the beep tone.
	OFF	Disables the beep tone.

Parameter	Settings	Description
Start Screen	Sets the screen that is displayed when the instrument starts up.	
	WIRING	Displays the Connection screen.
Clock	Sets the time and date of the instrument's internal clock.	
	Actual time control and file information are managed using this clock. Verify that the time and date have been set accurately before using the instrument.	
Clock	Touch the digit you wish to change and enter the desired value on the numeric keypad window (p. 29).	
	Valid setting range: 2015/01/01 00:00:00 to 2077/12/31 23:59:59	

## Correcting the touch panel

This section describes how to correct the touch panel if it stops registering the location of touch events accurately. The touch panel cannot be corrected remotely (via the web interface).

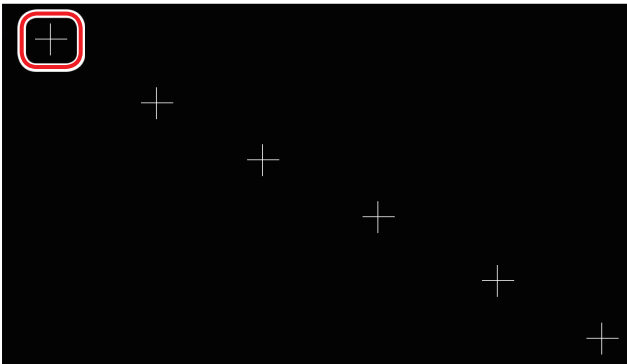

- 1 Touch the **[SYSTEM]** key.
- 2 Touch **CONFIG**.
- 3 Touch **Calib. Touch Pos..**
- 4 Touch the center of each of the six “+” marks displayed on the screen.

Once each “+” mark has turned red and disappeared, the compensation process is complete.

## 6.1 Initializing the Instrument

If the instrument is operating in a strange manner, check “Before having your instrument repaired”(p.257). If you are unsure of the cause, perform a system reset or boot key reset.

### System reset

This system describes how to initialize all settings other than the language setting and communications settings to their default values. Measurement data and screen data stored in the instrument’s internal memory will be erased.

See “6.2 Default Settings”(p.139).

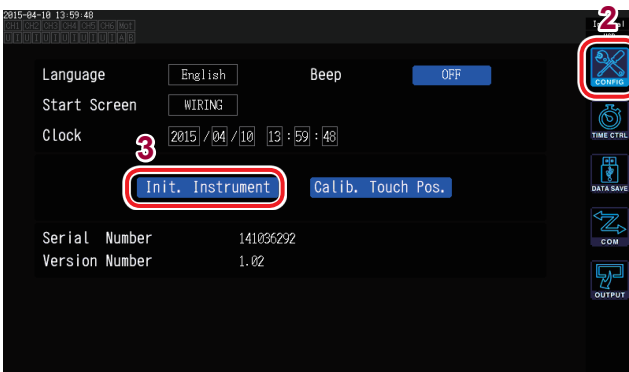

- 1 Press the **[SYSTEM]** key.
- 2 Touch **CONFIG**.
- 3 Touch **Init. Instrument**.  
A confirmation dialog box will be displayed.
- 4 Select **Yes** or **No**.

Yes	Performs the reset.
No	Cancel the reset.

### Boot key reset

This section describes how to initialize all settings other than the language setting and communications settings to their default values.

You can initiate a boot key reset by pressing the **[SYSTEM]** key as the instrument’s self-test completes after it is powered on.



## 6.2 Default Settings

The following tables list the instrument's default settings. Measurement screen and recorded data settings will also be reset.

Parameter	Default setting
Current input	Probe 1
Connection	Pattern 1 (1P2W)
Sync. Src. (synchronization source)	U1, U2, U3, U4, U5, U6
U range	600 V
U AUTO range	OFF
U rectifier	RMS
VT ratio	1.0 (OFF)
I range	Sensor rating
I AUTO range	OFF
I rectifier	RMS
CT ratio	1.0 (OFF)
LPF	OFF
Sensor phase shift	OFF
Integration mode	RMS
Freq. Mode	U
Upper Freq. (upper limit frequency)	2 MHz
Lower Freq. (lower limit frequency)	10 Hz
ZC HPF	ON
Delta conversion	OFF
Data update rate	50 ms
AUTO range breadth	Narrow
Harmonic mode	Wideband
Grouping	TYPE1
THD calculation order	100th
THD Type (THD calculation method)	THD-F
Zero Suppress (zero-suppression)	0.5% f.s.
Averaging mode	OFF
Power calculation	TYPE1
Efficiency calculation Pin, Pout	P1
Display language*	English
Beep tone	ON
Startup screen selection	Wiring (Connection screen)
GP-IB address*	1
Synchronization control	OFF





Parameter	Default setting
(Motor) operating mode	Single
(Motor) synchronization source	DC
Measurement parameters	Pattern 4 (Torque, Speed, OFF, OFF)
Torque input	Analog
(Motor) LPF	OFF
Volt. Rng. (voltage range)	5 V
RPM input	Pulse
Scaling	1.0
Unit of TQ (torque unit)	Nm (N•m)
Num. Pulses (pulse count)	2
Num. Poles (motor pole number)	4
Slip (slip input frequency)	f1
Center frequency (fc)	60000 Hz
Frequency range (fd)	30000 Hz
Phase ADJ	0.000
D/A waveform output	ON
Output range	1 V f.s.
Integration full scale	1
Output parameter	Urms1
Time Interval	1 s
Timer Mode	OFF
Timer Setup	1min
Real Time (actual time control)	OFF
CSV save format	CSV
Auto-saving	OFF
Adding Comment	OFF
Link Setup Info. (setting information synchronized saving)	OFF
DHCP*	OFF
IP address*	192.168.1.1
Subnet mask*	255.255.255.0
Default gateway*	0.0.0.0
RS-232C connection*	RS-232C
RS-232C communications speed	38400 bps

\* Parameter that is not initialized by a system reset. These parameters are initialized only by a boot key reset (p.138).



# Saving Data and Manipulating Files

✓: Data can be saved. –: Data cannot be saved.

Key	Description	Internal memory	USB flash drive
	<b>[SAVE]</b> key Saves measurement data manually.	–	✓
	<b>[START/STOP]</b> key Automatically saves measurement data.	✓	✓
Save Waveforms	(Displayed on touch panel) Saves waveform data.	–	✓
Save FFT Spectrum	(Displayed on touch panel) Saves FFT data.	–	✓
	<b>[COPY]</b> key Saves a screenshot.	–	✓
	<b>[FILE]</b> key		
	Saves settings data and settings files.	–	✓
	Loads settings data and settings files.	–	✓
	Saves data from the instrument's internal memory to a USB flash drive.	–	✓

## 7.1 Inserting and Removing USB Flash Drives

### CAUTION



- Inserting a USB flash drive upside down, backwards or in the wrong direction may damage the drive and/or instrument.
- Do not move the instrument while a USB flash drive is inserted. Doing so may cause damage.
- Some USB flash drive are susceptible to static electricity. Exercise care when using such products because static electricity could damage the USB flash drive or cause malfunction of the instrument.

### IMPORTANT

- USB flash drives have a limited service life. After long-term or frequent usage, data reading and writing capabilities will be degraded. In that case, purchase a new drive.
- No compensation is available for loss of data stored on the USB flash drive, regardless of the content or cause of damage or loss. Be sure to back up any important data stored on USB flash drives.
- While the instrument is accessing the USB flash drive, the USB memory access lamp (p.142) will turn yellow-green. Do not turn off the instrument while this lamp is on. Never remove the USB flash drive while the lamp is on. Doing so may damage the data stored on the drive.

If the instrument is turned on while a USB flash drive is inserted, it may not start up depending on the drive. If you encounter this issue, insert the drive after turning on the instrument. It is recommended to check the drive's compatibility before use.

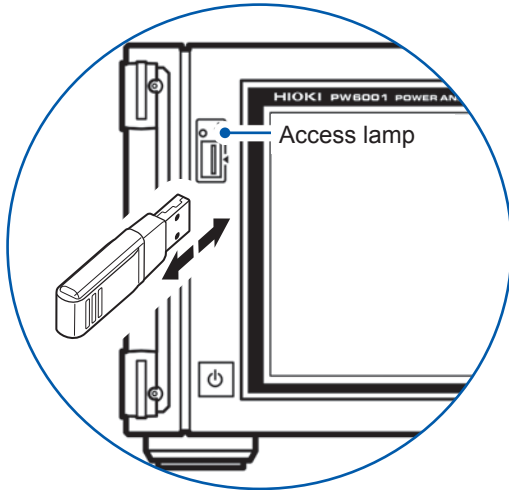

<b>Connector</b>	USB Type A connector
<b>Electrical specifications</b>	USB 2.0
<b>Supplied power</b>	Max. 500 mA
<b>Number of ports</b>	1
<b>Compatible USB flash drives</b>	USB Mass Storage Class
<b>File system</b>	FAT16, FAT32

### Inserting a USB flash drive





Insert the USB flash drive into the USB flash drive connector on the front of the instrument. When you do so, the instrument will automatically create a folder called “**PW6001**.” Subsequently, all files will be created inside that folder.

- Only use USB flash drives that are compatible with the Mass Storage Class specification.
- Not all commercially available USB flash drives are compatible with the instrument.
- If the instrument does not recognize a USB flash drive, try another drive.

### Removing a USB flash drive

Remove the drive after verifying that the access lamp is not yellow-green. It is not necessary to eject the drive on the instrument.

### Instrument display when using a USB flash drive

	Display	Status
 (Lit up [yellow-green])	The access lamp turns yellow-green.	The instrument is accessing the USB flash drive (either to save or load data).
	<ul style="list-style-type: none"> <li>• The media indicator on the top right of the screen turns to black from gray.</li> <li>• The background will turn red once more than 95% of the space available on the drive is being used.</li> </ul>	The instrument has recognized the USB flash drive.
	The media indicator on the top right of the screen indicates <b>SLOW</b> .	The instrument has recognized the USB flash drive as a drive with a slow write speed. The instrument will only be able to save about one-third of the maximum number of recordable parameters at each interval time.
	The media indicator on the top right of the screen indicates <b>UNKNOWN</b> .	The instrument is unable to recognize the USB flash drive because there is not enough available space.

## 7.2 File Operations Screen

This section describes the File Operations screen. The File Operations screen cannot be used during automatic saving.

Touch to move up one level.

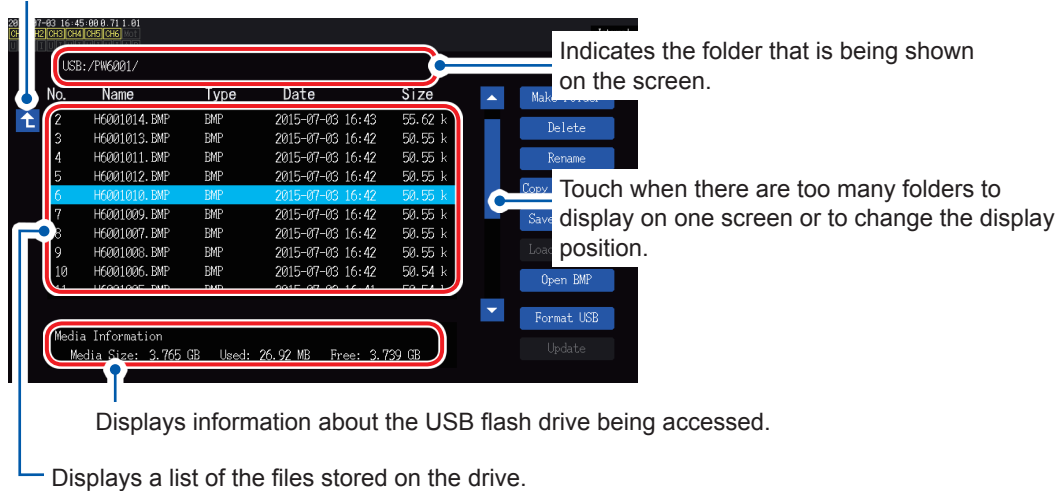

### Data types

Filename (Name)	File type (Type)	Contents
M6001nnn.CSV	CSV	Manually saved measurement data
MMDDnnkk.CSV	CSV	Automatically saved measurement data
F6001nnn.CSV	CSV	FFT data
W6001nnn.CSV	CSV	Waveform data (U, I)
E6001nnn.CSV	CSV	Waveform data (motor input)
B6001nnn.BIN	BIN	Waveform data (binary format)
H6001nnn.BMP	BMP	Screenshot data
MMDDnn00.SET	SET	Automatically saved settings data
xxxxxxxx.SET	SET	Settings data
xxxxxxxx	FOLDER	Folder
xxxxxxxx	???	File that cannot be manipulated by the instrument

- In filenames, “nnn” or “nn” indicates sequential numbering in the folder (000 to 999 or 00 to 99); “kk” indicates the file segment number (00 to 99) for files larger than 100 MB; and “MMDD” indicates the month and day.
- Settings data filenames may be set as desired (up to eight characters).
- The instrument cannot display two-byte characters (Japanese, etc.). Two-byte characters will be replaced by “□□.”

### Number of characters that can be used

Type of input	Maximum number of characters that can be entered
Folder name	8 alphanumeric characters (capitals only)
Comment	40 alphanumeric characters and symbols

### Moving inside folders

- Touching a line associated with a folder will display its contents.
- Touching  at the top left will move back up one level in the hierarchy.
- You cannot move to folders inside folders.

## 7.3 Saving Measurement Data

There are two ways to save data: manually and automatically. You can select from all measured values for fundamental measurement parameters and harmonic measurement parameters. Files are saved in CSV format, and the data delimiter can be set.

Data cannot be saved manually or automatically while the USB flash drive is being accessed (while the access lamp is yellow-green [ p. 142 ]). Saved CSV files have their read-only attribute set.

### Setting which measurement parameters to save

These settings apply to both manual and automatic saving of data. This section describes how to set which parameters are saved to the USB flash drive. The number of parameters that can be saved at each set interval time (p. 116) is subject to the following limits:

Interval	10 ms	50 ms	200 ms	500 ms	1 s	Other
Maximum number of recordable parameters	50	250	1000	2500	5000	No limit

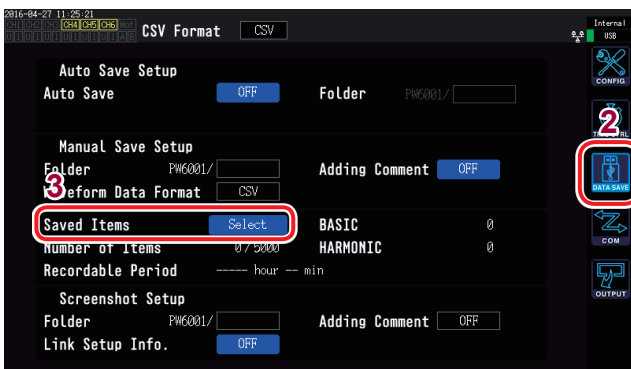

- 1 Press the [SYSTEM] key.
- 2 Touch **DATA SAVE**.
- 3 Touch **Saved Items**.  
The Measurement Parameter Selection window will be displayed.
- 4 Touch the parameters you wish to save to select their checkbox.

Touch to toggle all parameters on or off. (ON: Set to )

Touch to select the parameter type.

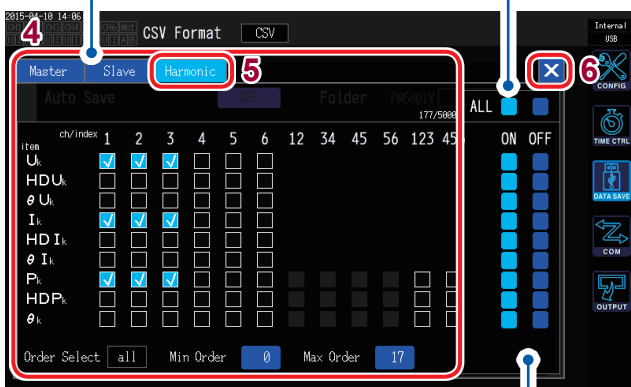

Touch to toggle all parameters in that row on or off.

Parameter types

<b>Master</b>	Basic measurement parameters
<b>Slave</b>	Basic measurement parameters measured by the slave instrument while operating in numerical synchronization mode
<b>Harmonic</b>	Harmonic measurement parameters

- 5 (When **Harmonic** is selected as the parameter type)  
Touch parameters to select them.  
For more information, see the table on the following page.
- 6 Touch **x** to close the window.

Parameter	Settings	Description
<b>Order Select</b> (Output order)	Sets which of the following orders to output.	
	<b>all</b>	Selects all orders.
	<b>even</b>	Selects even-numbered orders.
	<b>odd</b>	Selects odd-numbered orders.
<b>Min Order</b> (Minimum order)	Sets the minimum order to output. This parameter cannot be set to a value that is greater than the maximum order. (Valid setting range: 0 to 100)	
	Setting method (Y rotary knob: Turns green.) Turn rotary knob: Select Press rotary knob: Enter → The knob's light will turn off.	
<b>Max Order</b> (Maximum order)	Sets the maximum order to output. This parameter cannot be set to a value that is less than the minimum order. (Valid setting range: 0 to 100)	
	Setting method (Y rotary knob: Turns green.) Turn rotary knob: Select Press rotary knob: Enter → The knob's light will turn off.	

## Manually saving measurement data

Pressing the **[SAVE]** key saves measured values at that point in time.  
 (You must set which measurement parameters to save and where to save them in advance.)

<b>Folder (save destination)</b>	Limited to USB flash drive
<b>Filenames</b>	Automatically generated with “CSV” extension M6001nnn.CSV (where “nnn” indicates sequential numbering in the folder from 000 to 999) Example: M6001000.CSV (the first file to be saved)
<b>Remarks</b>	A new file is created when first saving data. Subsequently, the same file is appended.

- Saved data may differ from display values at the instant the **[SAVE]** key is pressed due to the time difference. To ensure saved data and display values match, manually save data while using the hold function.
- Up to 1000 files can be created inside the same folder.

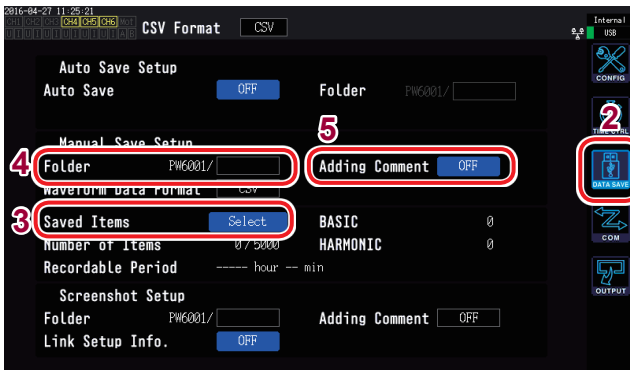

- 1 Press the **[SYSTEM]** key.
- 2 Touch **DATA SAVE**.
- 3 See “Setting which measurement parameters to save”(p. 144).
- 4 Touch **Folder** and set to the desired folder.  
 Enter the folder name with the keyboard window (p. 29).
- 5 Touch **Adding Comment** and select **ON** or **OFF**.

<b>ON</b>	Enables comment entry.
<b>OFF</b>	Disables comment entry.

- 6 Press **SAVE** when you wish to save data.  
 (When **Adding Comment** is set to **ON**, enter a comment with the keyboard window.)

Once you accept the comment, the data will be saved.

The entered comment string will be added to the end of the measurement data in the CSV file.

- During automatic save operation, manual save operation cannot be performed.
- When the sequential number used for files in the folder reaches 1000, an error will be displayed. Set a new **Folder**.
- The following limits apply to the number of characters that can be entered:  
 Folder name: Up to 8 alphanumeric characters and symbols  
 Comment: Up to 40 alphanumeric characters and symbols

### Timing at which new files are created

Once the following settings have been changed or operations performed, a new file will be created the next time data is saved:

<b>Settings</b>	<ul style="list-style-type: none"> <li>• Save destination folder</li> <li>• Connection mode</li> <li>• Measurement parameters to be saved</li> </ul>
<b>Operation</b>	Pressing of the <b>[DATA RESET]</b> key (This can be convenient when you wish to change the sequential numbering.)



## Automatically saving measurement data

This functionality automatically saves measured values at the set time. Parameters that have been set in advance will be saved.

<b>Folder (save destination)</b>	Internal memory or USB flash drive
<b>Filenames</b>	Automatically generated based on the time and date at start of saving with “CSV” extension for measurement data or “SET” for settings data MMDDnnkk.CSV, MMDDnn00.SET (MM: month; DD: day; nn: sequential numbering in the folder from 00 to 99; kk: file segment number from 00 to 99 when the file size exceeds 100 MB) Example: 11040000.CSV (first file saved on November 4) See “Folder and file structure when saving data automatically”(p. 148).

- During automatic save operation, neither manual save operation nor waveform save operation can be performed.
- If automatic save operation starts during manually save operation, waveform save operation, or screenshot operation, data for several automatic save operation may be lost.

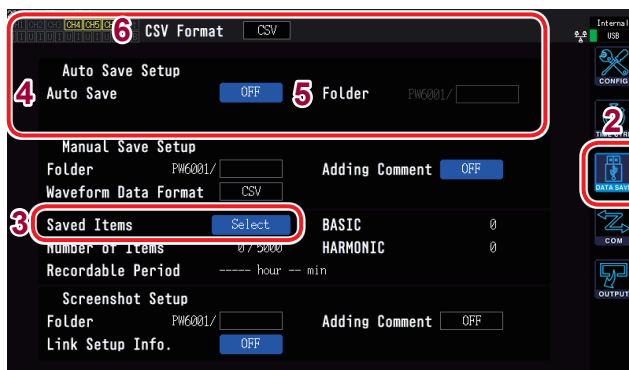

- The maximum number of recordable parameters “Setting which measurement parameters to save”(p. 144) varies with the interval time. (Longer interval times result in a higher maximum number of recordable parameters.)
- If automatic saving is set to **OFF**, you will not be able to set the save destination since data will be saved in the instrument’s internal memory.
- To view data that has been saved in the instrument’s internal memory, you must first copy the data to a USB memory stick. See “Copying files”(p. 158)
- Folder names of up to 8 alphanumeric characters and symbols can be entered.

### Remaining save time

When **Auto Save** is set to **ON**, the remaining save time for the USB flash drive being used will be displayed. An estimate of the remaining save time is calculated based on the amount of usable space on the USB flash drive, the number of parameters being recorded, and the interval time.

- 1 Press the **[SYSTEM]** key.
- 2 Touch **DATA SAVE**.
- 3 See “Setting which measurement parameters to save”(p. 144).
- 4 Touch **Auto Save** and set it to **ON**.

<b>ON</b>	Saves data to the USB flash drive.
<b>OFF</b>	Saves data to the internal memory.

- 5 (When Automatic save is set to **ON**)  
Touch **Folder** and set the desired folder.  
Enter the folder name with the keyboard window (p. 29).
- 6 Touch **CSV Format** and select the desired format.

<b>CSV</b>	Measurement data is comma-delimited (“,”), and a period (“.”) is used as the decimal point.
<b>SSV</b>	Measurement data is semicolon-delimited (“;”), and a comma is used as the decimal point.

- 7 **Set the save time.**  
See “5.1 Time Control Function”(p. 115), “Automatic save operation using time control”(p. 149).
- 8 **Press the [START/STOP] key.**  
Automatic saving will start. The set folder will be created automatically, and data will be saved there.  
To stop automatic save operation:  
**Press the [START/STOP] key again.**

### Timing at which new files are created

<p><b>When saving data in the internal memory</b></p>	<ul style="list-style-type: none"> <li>• Only one file is created in the internal memory. Each time integration starts, the file will be overwritten.</li> <li>• Once data has been saved for the number of intervals indicated below, the old data will be deleted, and new data will be added: When the interval is 10 ms: 18000 intervals When the interval is a value other than 10 ms: 3600 intervals</li> <li>• The internal memory will be cleared when the <b>[DATA RESET]</b> key is pressed.</li> </ul>
<p><b>When saving data to a USB flash drive</b></p>	<ul style="list-style-type: none"> <li>• A new file is created when integration starts.</li> <li>• Case 1: When a file exceeds about 100 MB, a new file will be created. (Up to 100 files can be saved for one measurement.)</li> <li>• Case 2: When integration stops and the <b>[DATA RESET]</b> key is pressed, a new file will be created the next time integration starts. (Up to 100 files can be saved per folder.)</li> </ul> <p>See “Folder and file structure when saving data automatically”(p. 148).</p>

### Folder and file structure when saving data automatically

The following explanation assumes that a folder named “AAA” was set as the **Folder** (save destination) for automatic saving on November 4.

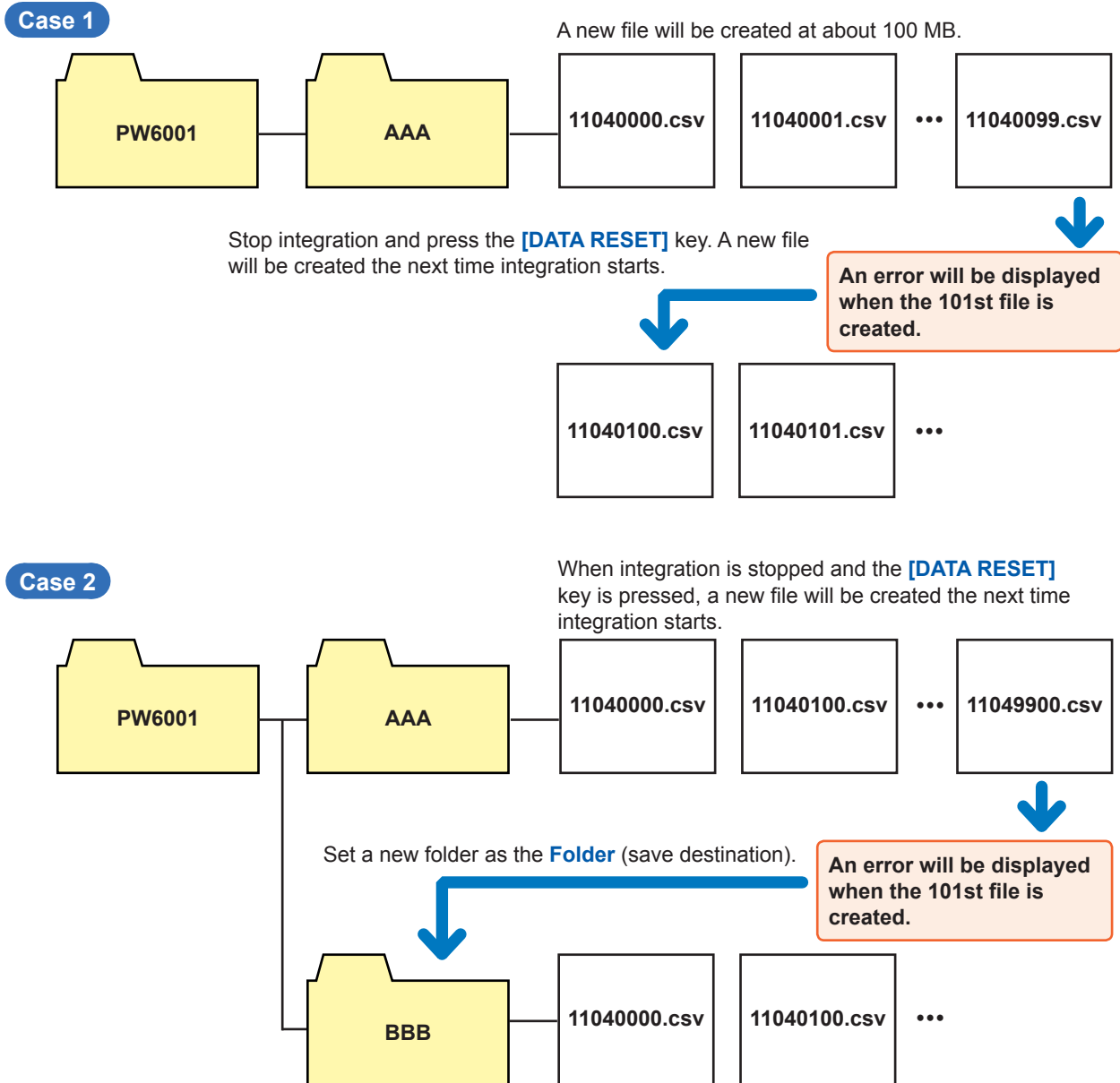

## Automatic save operation using time control

- Settings cannot be changed while time control is operating. In addition, when the range is set to auto, the range will be fixed to the range at the time the [START/STOP] key is pressed.
- If the USB flash drive becomes full during automatic save operation, an error will be displayed, and save operation will stop.  
See “Time Control Function”(p.115).

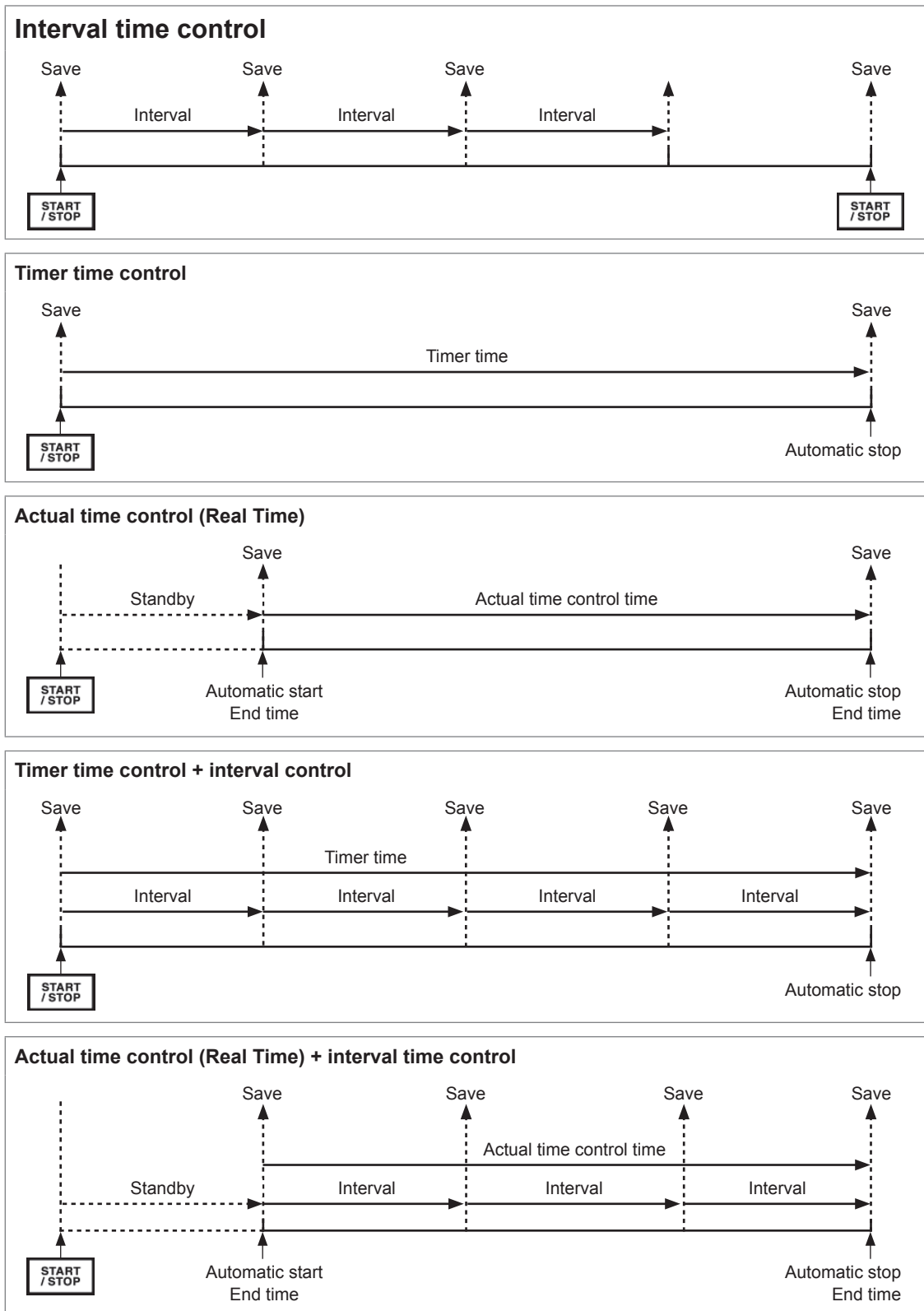

## 7.4 Saving Waveform Data

Waveform data displayed on the Wave screen is saved when **Save Waveforms** is touched. The same **Folder** and **Adding Comment** settings as for manual saving of measurement data are used.

<b>Folder (save destination)</b>	Limited to USB flash drive
<b>Filenames</b>	<p>Automatically generated with an extension of CSV or BIN (depending on the waveform save format setting).</p> <ul style="list-style-type: none"> <li>When CSV is selected W6001nnn.CSV, E6001nnn.CSV (where “nnn” indicates sequential numbering in the folder from 000 to 999) Examples: <ul style="list-style-type: none"> <li>W6001000.CSV (the first file to be saved)</li> <li>Data from the motor analysis analog input channel is saved to files named using the E6001nnn.CSV format, while data from other channels is saved to files named using the W6001nnn.CSV format.</li> </ul> </li> <li>When BIN is selected B6001nnn.BIN Examples: <ul style="list-style-type: none"> <li>B6001000.BIN</li> <li>Motor analysis waveforms will be saved in the same file.</li> </ul> </li> </ul>

### Save settings

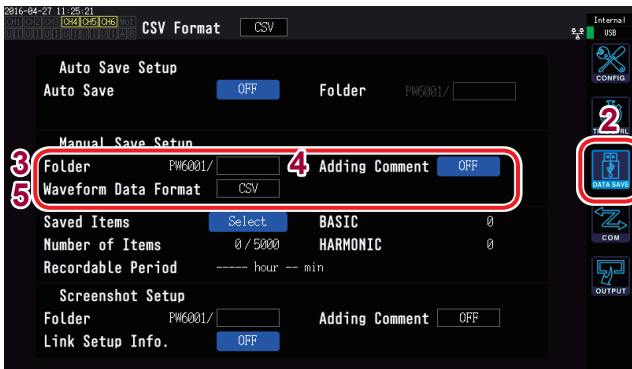

Folder names of up to 8 alphanumeric characters and symbols can be entered.

- 1 Press the **[SYSTEM]** key.
- 2 Touch **DATA SAVE**.
- 3 Touch **Folder** and set to the desired folder.  
Enter the folder name with the keyboard window “Keyboard windows”(p.29).
- 4 Touch **Adding Comment** and set to **ON** or **OFF**.

<b>ON</b>	Enables comment entry.
<b>OFF</b>	Disables comment entry.

- 5 Touch **Waveform save format** and select the desired format.

Note: This setting cannot be selected in the current version. We plan to provide this capability via a function upgrade.

<b>CSV</b>	CSV file format (with read-only attribute set)
<b>BIN</b>	Binary file format (BIN format)

## Operation while saving

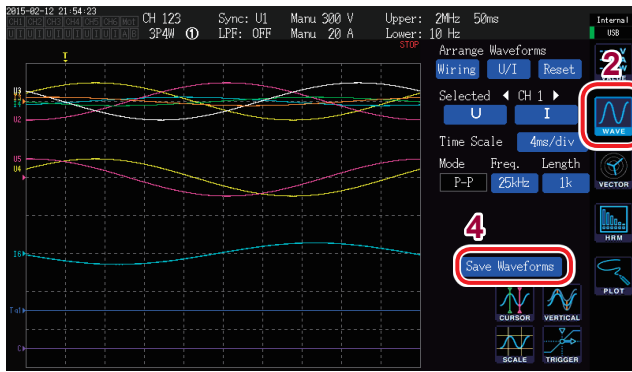

- 1 Press the **[MEAS]** key.
- 2 Touch **WAVE**.
- 3 Press the **[SINGLE]** key to acquire waveforms. (p.104)  
The **[RUN/STOP]** key will turn red.
- 4 Touch **Save Waveforms**.

If the instrument has not recognized the USB flash drive, the button will be grayed out so that you cannot touch it.

(If **Adding Comment** is set to **ON**)  
Enter a comment with the keyboard window "Keyboard windows"(p.29).

Once you accept the comment, the data will be saved.

The entered comment string will be added to the end of the measurement data in the CSV file.

The following will be added before measurement data in the CSV file:

- SAMPLING (sampling speed)
- POINT (recording length)
- MODE (storage mode)
- COMMENT (entered comment string)

- You may not be able to save the waveform if it was acquired by pressing the **[RUN/STOP]** key.
- For more information about saving BIN files, see p.165.
- Parameters for which the waveform display is **OFF** will not be saved.
- Waveform data cannot be saved while automatic save operation is in progress.
- During **P-P** mode operation, waveform data will be saved as a set of max. and min. data compressed using peak-peak compression.
- Waveform data in DECI mode is saved as a set of files consisting of data that has been processed by an anti-aliasing filter for FFT use (AAF data) and the data that is shown on the screen (DECI data).
- When using motor pulse input, two copies of the data shown on the screen (DECI data) (two copies of the same data) are saved.
- When the sequential number used for files in the folder reaches 1000, an error will be displayed. Set a new **Folder** (p.150).
- Up to 40 alphanumeric characters and symbols can be entered for comments.  
See "4.1 Displaying Waveforms"(p.95).
- A dialog box will be displayed while saving the data. To cancel save operation, touch **Cancel** on the dialog box.

## 7.5 Saving FFT Data

FFT data displayed on the **Wave+FFT** screen is saved whenever **Save FFT Spectrum** is touched. The save destination and comment entry settings are shared with manual saving of measurement data.

<b>Save destination</b>	Can only be set to a USB flash drive.
<b>Filename</b>	Automatically generated with an extension of CSV (other formats not supported) F6001nnn.CSV (where "nnn" indicates sequential numbering in the folder from 000 to 999) Example: F6001000.CSV (the first file to be saved)

### Save settings

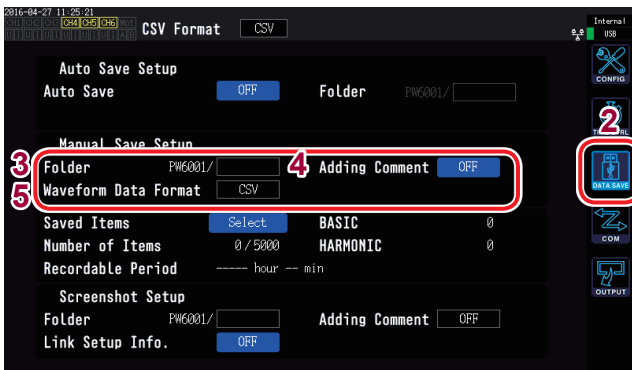

Folder names of up to 8 alphanumeric characters and symbols can be entered.

- 1 Press the **[SYSTEM]** key.
- 2 Touch **DATA SAVE**.
- 3 Touch **Folder** and set the folder.  
Enter the folder name with the keyboard window (p.29).
- 4 Touch **Adding Comment** and set to **ON** or **OFF**.

<b>ON</b>	Enables comment entry.
<b>OFF</b>	Disables comment entry.

- 5 Touch **Waveform save format** and select the desired format.

<b>CSV</b>	CSV file format (with read-only attribute set)
<b>BIN</b>	Binary file format (BIN format)

FFT data is saved in the CSV format, even when BIN has been set as the waveform save format.

## Operation while saving

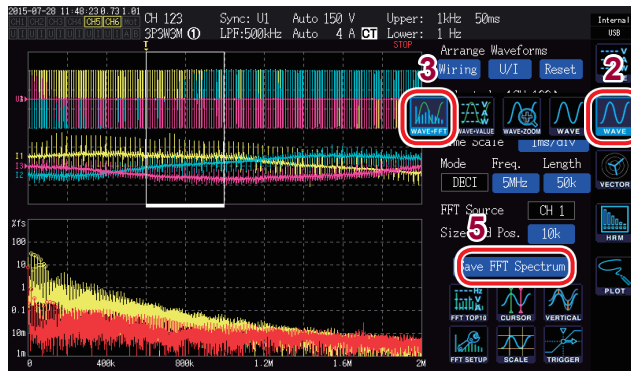

- 1 Press the **[MEAS]** key.
- 2 Touch **WAVE**.
- 3 Select **WAVE+FFT**.
- 4 Press the **[SINGLE]** key to acquire waveforms.  
The **[RUN/STOP]** key will turn red.
- 5 Touch **Save FFT Spectrum**.

If the instrument has not recognized the USB flash drive, the button will be grayed out so that you cannot touch it.

(If **Adding Comment** is set to **ON**)  
Enter a comment with the keyboard window (p.29).

Once you accept the comment, the data will be saved.

The following will be added before the FFT data in the CSV file:

- SAMPLING (sampling speed)
- SIZE (window size)
- MODE (storage mode)
- COMMENT (entered comment string)

- Parameters for which the FFT display is OFF will not be saved.
- FFT data cannot be saved while automatic save operation is in progress, or while the storage device is otherwise busy.
- Data cannot be saved when the waveform data or FTT analysis data is invalid.
- When the sequential number used for files in the folder reaches 1000, an error will be displayed. Set up a new Folder (p.152).
- Up to 40 alphanumeric characters and symbols can be entered for comments.
- A dialog box will be displayed while saving the data. To cancel save operation, touch **Cancel** on the dialog box.

## 7.6 Saving Screenshots

You can save a screenshot as a BMP file on a USB flash drive by pressing the **[COPY]** key.

<b>Folder (save destination)</b>	Limited to USB flash drive
<b>Filenames</b>	Automatically generated with "BMP" extension H6001nnn.BMP (where "nnn" indicates sequential numbering in the folder from 000 to 999) Example: H6001000.BMP (the first file to be saved)

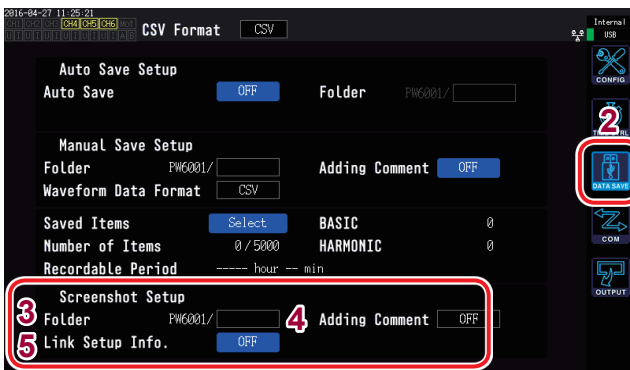

- 1 Press the **[SYSTEM]** key.
- 2 Touch **DATA SAVE**.
- 3 Touch **Folder** and set it to the desired folder.  
Enter the folder name with the keyboard window (p.29).

- 4 Touch **Adding Comment** and select the desired setting.

<b>OFF</b>	Disables comment entry.
<b>TEXT</b>	Allows you to enter comments with the keyboard window.
<b>BMP</b>	Allows you to enter comments as handwriting on the screen. (Comments will be added to the screenshot and saved.)

- Screenshots can be saved during automatic save operation. However, automatic save operation will have priority, and screenshots cannot be saved when the interval is less than 1 sec.
- When the sequential number used for files in the folder reaches 1000, an error will be displayed. Set a new **Folder**.
- The following limits apply to the number of characters that can be entered:

- Folder name: Up to 8 alphanumeric characters and symbols
- Comment: Up to 40 alphanumeric characters and symbols

- 5 Select **ON** or **OFF** for **Link Setup Info**.

<b>OFF</b>	Disables saving of settings information.
<b>ON</b>	Saves a screenshot of each channel's measurement condition settings.

- 6 Press the **[COPY]** key and enter a comment.

(If you selected **TEXT**)  
Enter a comment with the keyboard window.

Once you accept the comment, the data will be saved.

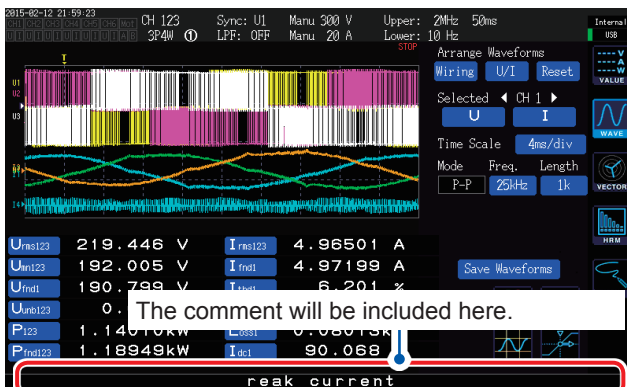



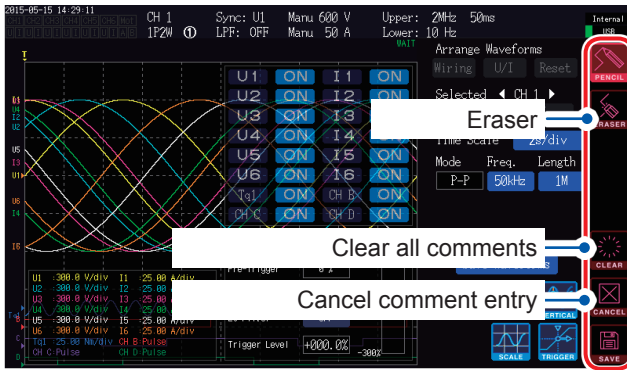

(If you selected **BMP**)

Touch **PENCIL** and enter a handwritten comment.

Touch **SAVE** to save the data along with your comment.

If you cancel comment entry, the screenshot will not be saved.

## 7.7 Saving Settings Data

Information about the instrument's settings can be saved to a USB flash drive as a settings file.

<b>Folder (save destination)</b>	Limited to USB flash drive
<b>Filenames</b>	Set as desired (up to 8 characters) with "SET" extension Example: SETTING1.SET

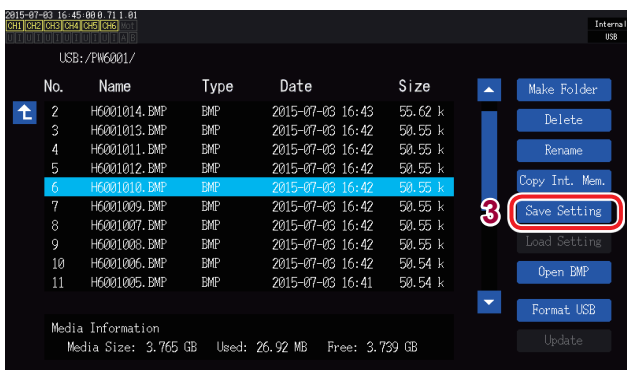

- 1 Press the **[FILE]** key.
- 2 Touch the folder in which you wish to save the file.
- 3 Touch **Save Setting** and enter a filename.  
Enter a filename with the keyboard window (p.29).

- Language and communications settings cannot be saved.
- Settings cannot be saved while automatic save operation is in progress.

## 7.8 Loading Screenshots

This section describes how to load previously saved screenshots and display them on the screen.

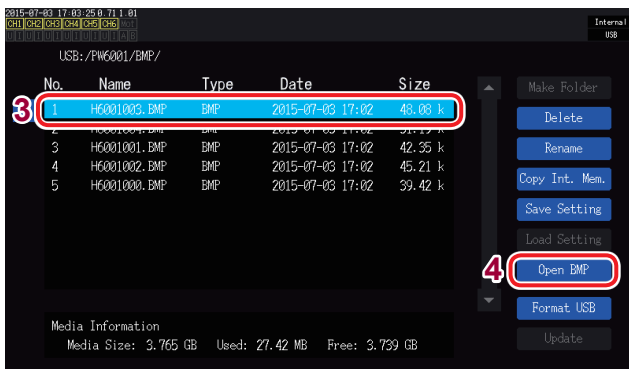

- 1 Press the **[FILE]** key.
- 2 Touch the folder in which the screenshot is saved.
- 3 Touch the BMP file.
- 4 Touch **Open BMP**.  
A confirmation dialog box will be displayed.
- 5 Select whether to load the file or cancel the operation.

<b>YES</b>	Loads the file.
<b>NO</b>	Cancels the operation.

## 7.9 Loading Settings Data

This section describes how to load a previously saved settings file and restore its settings.

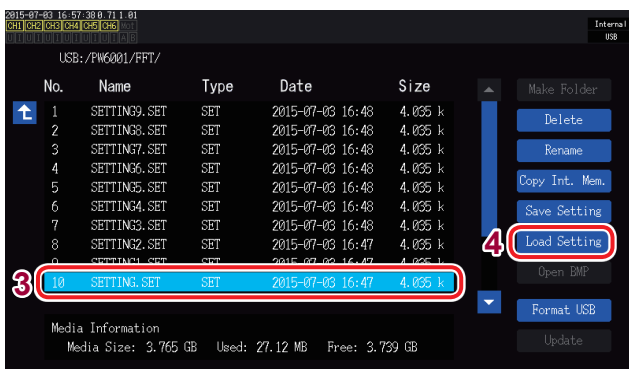

Settings can only be restored when the same options and other characteristics are the same. If the instrument is equipped with different options, you will not be able to restore the settings.

- 1 Press the **[FILE]** key.
- 2 Touch the folder in which the settings file was saved.
- 3 Touch the settings file.
- 4 Touch **Load Setting**.  
A confirmation dialog box will be displayed.
- 5 Select whether to load the file or cancel the operation.

<b>YES</b>	Loads the file.
<b>NO</b>	Cancels the operation.

## 7.10 File and Folder Operations

### Creating a folder

You can create folders as necessary. Before creating a folder, insert a USB flash drive.

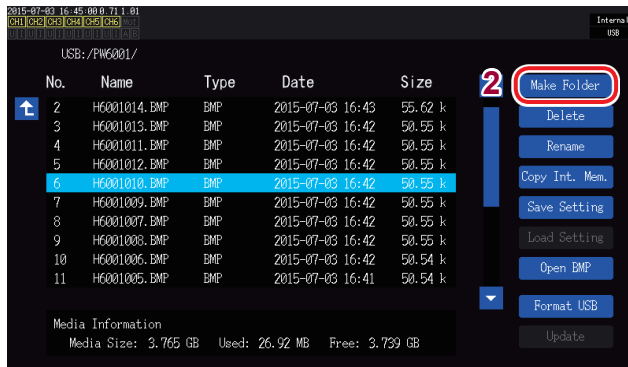

- 1 Press the **[FILE]** key.
- 2 Touch **Make Folder** and enter a folder name.

Enter a folder name with the keyboard window (p.29).

Folder names can have up to eight characters.

Folders can only be created inside the “PW6001” folder.

### Deleting files and folders

This section describes how to delete a file or folder that was previously saved on a USB flash drive.

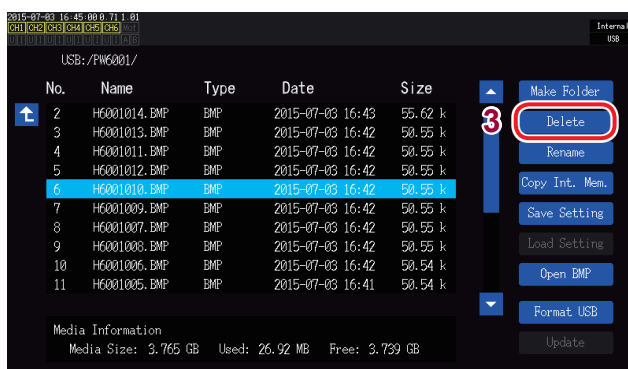

- 1 Press the **[FILE]** key.
- 2 Touch the file or folder you wish to delete.
- 3 Touch **Delete**.
- 4 Select whether to delete or cancel the operation.

<b>YES</b>	Deletes the file/folder.
<b>NO</b>	Cancels the operation.

## Changing the name of a file or folder

This section describes how to change the name of a file or folder that was previously saved on a USB flash drive.

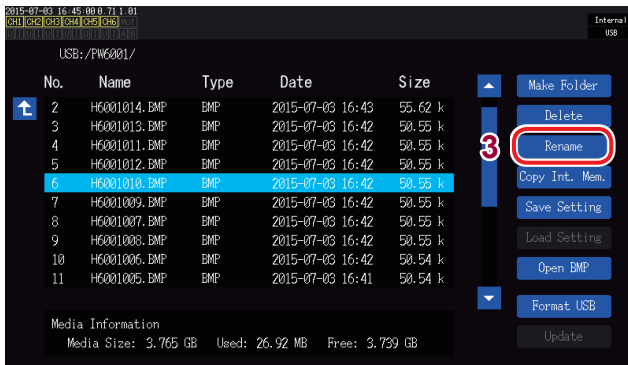

- 1 Press the **[FILE]** key.
- 2 Touch the file or folder whose name you wish to change.
- 3 Touch **Rename** and enter a filename.

Enter a filename with the keyboard window (p.29).

File names and folder names can have up to eight characters.

## Copying files

This section describes how to copy a file from the instrument's internal memory to a USB flash drive. Before copying files, insert a USB flash drive.

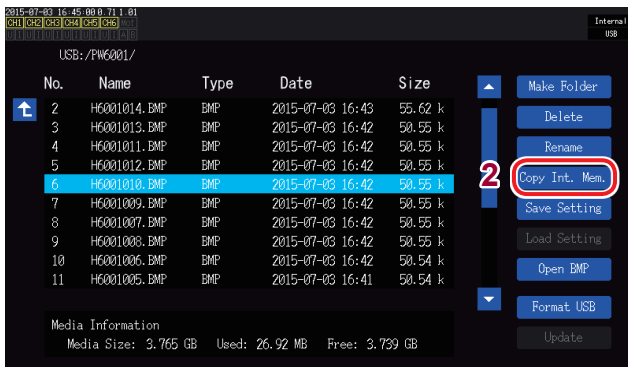

- 1 Press the **[FILE]** key.
- 2 Touch **Copy Int. Mem.** and change the filename.

Enter a filename with the keyboard window (p.29).

File names can have up to eight characters.

If a file with the same name exists, it cannot be overwritten. Change the filename and then copy it.

## Formatting a USB flash drive

This section describes how to format a USB flash drive for use with the instrument. Touch **Format USB** after inserting a USB flash drive into the instrument to start formatting the media. Once the format is complete, a folder named "**PW6001**" will be created automatically at the top layer of the file/folder hierarchy.

Formatting a USB flash drive will cause all data stored on the drive to be erased. This operation cannot be undone. Check the contents of the drive carefully before formatting it. It is recommended to back up important data stored on USB flash drives.

## 7.11 Measured Value Data Format

### Header structure

The following header information (which consists of parameter names saved in the first row in the file) is used when automatically or manually saving measurement data:

- The selected parameters from the table are output, from top to bottom and from left to right.
- Measurement data starts on the first row after the header and follows the header order.
- The first four parameters (Date, Time, Status, and Status1 to Status6) and the harmonic status (HARM Status) are output regardless of whether they have been selected.
- The status1 to status6 information is output for installed input units.

Output parameter	Instrument symbol	Header and order
Date		Date
Time		Time
Elapsed time		Etime
Elapsed time (ms)		Etime (ms)
Status		Status
Channel status		Status1/Status2/Status3/Status4/Status5/Status6
<b>Basic measurement parameters</b>		
* The string "[Slv]" is added to basic measurement parameter headers for the slave instrument when operating in numerical synchronization mode.		
Voltage RMS value	Urms	Urms1/Urms2/Urms3/Urms4/Urms5/Urms6/ Urms12/Urms34/Urms45/Urms56/Urms123/Urms456
Voltage mean value rectification RMS equivalent	Umn	Umn1/Umn2/Umn3/Umn4/Umn5/Umn6/ Umn12/Umn34/Umn45/Umn56/Umn123/Umn456
Voltage AC component	Uac	Uac1/Uac2/Uac3/Uac4/Uac5/Uac6
Voltage simple average	Udc	Udc1/Udc2/Udc3/Udc4/Udc5/Udc6
Voltage fundamental wave component	Ufnd	Ufnd1/Ufnd2/Ufnd3/Ufnd4/Ufnd5/Ufnd6/
Voltage waveform peak (+)	Upk+	PUpk1/PUpk2/PUpk3/PUpk4/PUpk5/PUpk6
Voltage waveform peak (-)	Upk-	MUpk1/MUpk2/MUpk3/MUpk4/MUpk5/MUpk6
Total voltage harmonic distortion	Uthd	Uthd1/Uthd2/Uthd3/Uthd4/Uthd5/Uthd6
Voltage ripple factor	Urf	Urf1/Urf2/Urf3/Urf4/Urf5/Urf6
Voltage unbalance rate	Uunb	Uunb123/Uunb456
Current RMS value	Irms	Irms1/Irms2/Irms3/Irms4/Irms5/Irms6/ Irms12/Irms34/Irms45/Irms56/Irms123/Irms456
Current mean value rectification RMS equivalent	Imn	Imn1/Imn2/Imn3/Imn4/Imn5/Imn6/ Imn12/Imn34/Imn45/Imn56/Imn123/Imn456
Current AC component	Iac	Iac1/Iac2/Iac3/Iac4/Iac5/Iac6
Current simple average	Idc	Idc1/Idc2/Idc3/Idc4/Idc5/Idc6
Current fundamental wave component	Ifnd	Ifnd1/Ifnd2/Ifnd3/Ifnd4/Ifnd5/Ifnd6/
Current waveform peak (+)	Ipk+	PIpk1/PIpk2/PIpk3/PIpk4/PIpk5/PIpk6
Current waveform peak (-)	Ipk-	MIPk1/MIPk2/MIPk3/MIPk4/MIPk5/MIPk6
Total current harmonic distortion	Ithd	Ithd1/Ithd2/Ithd3/Ithd4/Ithd5/Ithd6
Current ripple factor	Irf	Irf1/Irf2/Irf3/Irf4/Irf5/Irf6

Measured Value Data Format

Output parameter	Instrument symbol	Header and order
Current unbalance rate	lunb	lunb123/lunb456
Active power	P	P1/P2/P3/P4/P5/P6/P12/P34/P45/P56/P123/P456
Fundamental wave active power	Pfnd	Pfnd1/Pfnd2/Pfnd3/Pfnd4/Pfnd5/Pfnd6/ Pfnd12/Pfnd34/Pfnd45/Pfnd56/Pfnd123/Pfnd456
Apparent power	S	S1/S2/S3/S4/S5/S6/S12/S34/S45/S56/S123/S456
Fundamental wave apparent power	Sfnd	Sfnd1/Sfnd2/Sfnd3/Sfnd4/Sfnd5/Sfnd6/ Sfnd12/Sfnd34/Sfnd45/Sfnd56/Sfnd123/Sfnd456
Reactive power	Q	Q1/Q2/Q3/Q4/Q5/Q6/Q12/Q34/Q45/Q56/Q123/Q456
Fundamental wave reactive power	Qfnd	Qfnd1/Qfnd2/Qfnd3/Qfnd4/Qfnd5/Qfnd6/ Qfnd12/Qfnd34/Qfnd45/Qfnd56/Qfnd123/Qfnd456
Power factor	$\lambda$	PF1/PF2/PF3/PF4/PF5/PF6/PF12/PF34/PF45/PF56/PF123/PF456
Fundamental wave power factor	$\lambda$ fnd	PFfnd1/PFfnd2/PFfnd3/PFfnd4/PFfnd5/PFfnd6/ PFfnd12/PFfnd34/PFfnd45/PFfnd56/PFfnd123/PFfnd456
Voltage phase angle	$\theta$ U	Udeg1/Udeg2/Udeg3/Udeg4/Udeg5/Udeg6
Current phase angle	$\theta$ I	Ideg1/Ideg2/Ideg3/Ideg4/Ideg5/Ideg6
Power phase angle	$\phi$	DEG1/DEG2/DEG3/DEG4/DEG5/DEG6/ DEG12/DEG34/DEG45/DEG56/DEG123/DEG456
Frequency	f	FREQ1/FREQ2/FREQ3/FREQ4/FREQ5/FREQ6
Positive-direction current integration value	Ih+	PIH1/PIH2/PIH3/PIH4/PIH5/PIH6
Negative-direction current integration value	Ih-	MIH1/MIH2/MIH3/MIH4/MIH5/MIH6
Total positive- and negative-direction current integration value	Ih	IH1/IH2/IH3/IH4/IH5/IH6
Positive-direction power integration value	WP+	PWP1/PWP2/PWP3/PWP4/PWP5/PWP6 PWP12/PWP34/PWP45/PWP56/PWP123/PWP456
Negative-direction power integration value	WP-	MWP1/MWP2/MWP3/MWP4/MWP5/MWP6 MWP12/MWP34/MWP45/MWP56/MWP123/MWP456
Total positive- and negative-direction power integration value	WP	WP1/WP2/WP3/WP4/WP5/WP6 WP12/WP34/WP45/WP56/WP123/WP456
Efficiency	$\eta$	Eff1/Eff2/Eff3/Eff4
Loss	Loss	Loss1/Loss2/Loss3/Loss4
Torque	Tq	Tq1/Tq2
RPM	Spd	Spd1/Spd2
Motor power	Pm	Pm1/Pm2
Slip	Slip	Slip1/Slip2
Free input during independent input mode operation	CH	CHA/CHB/CHC/CHD
User-defined calculation	UDF	UDF1/UDF2/UDF3/UDF4/UDF5/UDF6/UDF7/UDF8/ UDF9/UDF10/UDF11/UDF12/UDF13/UDF14/UDF15/UDF16

\* Basic measurement parameters from the slave instrument will be output after basic measurement parameters from the master instrument.

Output parameter		Instrument symbol	Header and order
<b>Harmonic measurement parameters</b>			
Status			HRMStatus
0th order	Harmonic voltage RMS value	Uk	HU1L000/HU2L000/HU3L000/HU4L000/HU5L000/HU6L000
	Harmonic current RMS value	Ik	HI1L000/HI2L000/HI3L000/HI4L000/HI5L000/HI6L000
	Harmonic active power	Pk	HP1L000/HP2L000/HP3L000/HP4L000/HP5L000/HP6L000/ HP12L000/HP34L000/HP45L000/HP56L000/HP123L000/HP456L000
	Harmonic voltage content percentage	HDUk	HU1D000/HU2D000/HU3D000/HU4D000/HU5D000/HU6D000
	Harmonic current content percentage	HDIk	HI1D000/HI2D000/HI3D000/HI4D000/HI5D000/HI6D000
	Harmonic power content percentage	HDPk	HP1D000/HP2D000/HP3D000/HP4D000/HP5D000/HP6D000/ HP12D000/HP34D000/HP45D000/HP56D000/HP123D000/HP456D000
	Harmonic voltage phase angle	θUk	HU1P000/HU2P000/HU3P000/HU4P000/HU5P000/HU6P000
	Harmonic current phase angle	θIk	HI1P000/HI2P000/HI3P000/HI4P000/HI5P000/HI6P000
	Harmonic voltage/ current phase difference	θk	HP1P000/HP2P000/HP3P000/HP4P000/HP5P000/HP6P000/ HP12P000/HP34P000/HP45P000/HP56P000/HP123P000/HP456P000
nth order	(Omitted)	-	Last three digits indicate the order n.
100th order	Harmonic voltage RMS value	Uk	HU1L100/HU2L100/HU3L100/HU4L100/HU5L100/HU6L100
	Harmonic current RMS value	Ik	HI1L100/HI2L100/HI3L100/HI4L100/HI5L100/HI6L100
	Harmonic active power	Pk	HP1L100/HP2L100/HP3L100/HP4L100/HP5L100/HP6L100/ HP12L100/HP34L100/HP45L100/HP56L100/HP123L100/HP456L100
	Harmonic voltage content percentage	HDUk	HU1D100/HU2D100/HU3D100/HU4D100/HU5D100/HU6D100
	Harmonic current content percentage	HDIk	HI1D100/HI2D100/HI3D100/HI4D100/HI5D100/HI6D100
	Harmonic power content percentage	HDPk	HP1D100/HP2D100/HP3D100/HP4D100/HP5D100/HP6D100/ HP12D100/HP34D100/HP45D100/HP56D100/HP123D100/HP456D100
	Harmonic voltage phase angle	θUk	HU1P100/HU2P100/HU3P100/HU4P100/HU5P100/HU6P100
	Harmonic current phase angle	θIk	HI1P100/HI2P100/HI3P100/HI4P100/HI5P100/HI6P100
	Harmonic voltage/ current phase difference	θk	HP1P100/HP2P100/HP3P100/HP4P100/HP5P100/HP6P100/ HP12P100/HP34P100/HP45P100/HP56P100/HP123P100/HP456P100

## Status data

Status information is used to express measurement conditions at the time the measurement data was saved using a 32-bit hexadecimal value. Status is the logical sum of Status1 to Status6 as well as StatusM1/StatusM2/StatusMInd.

Example: If bit 11 of Status2 (ZU) is ON and bit 17 of StatusM1 (ZM) is on, bits 11 and 17 of Status will be ON.

### Channel status data (Status1, Status2, Status3, Status4, Status5, and Status6)

Status1 through Status6 indicate the status of individual channels.

Example: Status3 indicates the status of channel 3.

The 32 bits are assigned as follows:

bit31	bit30	bit29	bit28	bit27	bit26	bit25	bit24
-	-	-	-	-	-	-	-
bit23	bit22	bit21	bit20	bit19	bit18	bit17	bit16
-	-	-	-	-	-	-	-
bit15	bit14	bit13	bit12	bit11	bit10	bit9	bit8
-	UCU	ZP	ZI	ZU	DP	DI	DU
bit7	bit6	bit5	bit4	bit3	bit2	bit1	bit0
-	-	-	-	RI	RU	PI	PU

Bit	Abbreviation	Description
Bit 14	UCU	Calculation not possible (for example, because the measurement data was invalid immediately after a range change)
Bit 13	ZP	Power calculation (synchronization source) forced zero-cross
Bit 12	ZI	Current frequency forced zero-cross
Bit 11	ZU	Voltage frequency forced zero-cross
Bit 10	DP	No power calculation (synchronization source) data update
Bit 9	DI	No current frequency data update
Bit 8	DU	No voltage frequency data update
Bit 3	RI	Current range exceeded
Bit 2	RU	Voltage range exceeded
Bit 1	PI	Current peak exceeded
Bit 0	PU	Voltage peak exceeded

Example: When bit 12 (ZI, current frequency forced zero-cross) and bit 2 (RU, voltage range exceeded) are set to on, the status is represented as 1004 in hexadecimal notation.

For reference

In binary notation, it is written 00000000000000000000100000000100.



**Channel A and B motor status (StatusM1, StatusM2)**

bit31	bit30	bit29	bit28	bit27	bit26	bit25	bit24
–	–	–	–	–	–	–	–
bit23	bit22	bit21	bit20	bit19	bit18	bit17	bit16
–	–	UCUB	ZMB	RMB	UCUA	ZMA	RMA
bit15	bit14	bit13	bit12	bit11	bit10	bit9	bit8
–	–	–	–	–	–	–	–
bit7	bit6	bit5	bit4	bit3	bit2	bit1	bit0
–	–	–	–	–	–	–	–

Bit	Abbreviation	Description
Bit 21	UCUB	CH B calculation not possible (for example, because the measurement data was invalid immediately after a range change)
Bit 20	ZMB	CH B motor synchronization source forced zero-cross
Bit 19	RMB	Range exceeded while using CH B as analog input
Bit 18	UCUA	CH A calculation not possible (for example, because the measurement data was invalid immediately after a range change)
Bit 17	ZMA	CH A motor synchronization source forced zero-cross
Bit 16	RMA	Range exceeded while using CH A as analog input

**Status during motor analysis independent input mode operation (StatusMInd)**

bit31	bit30	bit29	bit28	bit27	bit26	bit25	bit24
–	UCU	ZD	ZC	ZB	ZA	RB	RA
bit23	bit22	bit21	bit20	bit19	bit18	bit17	bit16
–	–	–	–	–	–	–	–
bit15	bit14	bit13	bit12	bit11	bit10	bit9	bit8
–	–	–	–	–	–	–	–
bit7	bit6	bit5	bit4	bit3	bit2	bit1	bit0
–	–	–	–	–	–	–	–

Bit	Abbreviation	Description
Bit 30	UCU	Calculation not possible (for example, because the measurement data was invalid immediately after a range change)
Bit 29	ZD	CH D forced zero-cross
Bit 28	ZC	CH C forced zero-cross
Bit 27	ZB	CH B forced zero-cross
Bit 26	ZA	CH A forced zero-cross
Bit 25	RB	CH B range exceeded
Bit 24	RA	CH A range exceeded

### Harmonic status (HARMStatus)

Status information is used to express measurement conditions at the time the measurement data was saved using a 32-bit hexadecimal value. The status for harmonic measurement data is one HARMStatus block. The 32 bits are assigned as follows (the numbers 1 through 6 at the end of the abbreviation indicate the channel number):

bit31	bit30	bit29	bit28	bit27	bit26	bit25	bit24
–	–	–	–	–	–	–	–
bit23	bit22	bit21	bit20	bit19	bit18	bit17	bit16
–	–	UCU6	UCU5	UCU4	UCU3	UCU2	UCU1
bit15	bit14	bit13	bit12	bit11	bit10	bit9	bit8
–	–	ZH6	ZH5	ZH4	ZH3	ZH2	ZH1
bit7	bit6	bit5	bit4	bit3	bit2	bit1	bit0
–	–	RF6	RF5	RF4	RF3	RF2	RF1

Bits	Abbreviation	Description
16 to 21	UCU	Calculation not possible (for example, because the measurement data was invalid immediately after a range change)
8 to 13	ZH	Harmonic waveform forced zero-cross
0 to 5	RF	Frequency range exceeded

### Measured value data format

General measured values	±□□□□□□□E±□□ 7-digit mantissa including the decimal point and 2-digit exponent (The “+” at the beginning of the mantissa and any leading zeroes are omitted.)
Integration values	±□□□□□□□E±□□ 7-digit mantissa including the decimal point and 2-digit exponent (The “+” at the beginning of the mantissa and any leading zeroes are omitted.)
Times	Year/month/day: □□□□/□□/□□ Hours/minutes/seconds: □□:□□:□□ Elapsed time: □□□□□:□□:□□ Elapsed time (ms): □□□
Errors	Input exceeded: +99999.9E+99

## 7.12 Waveform Binary Data Format

### Data format

Settings information and waveform data are saved in the file.

Waveform data is saved after the settings information.

### Settings information (byte order: big-endian)

Offset	Size	Type	Variable name	Description																																																																
0	12 char		sizeStr[12]	String with the number of bytes in the file excluding this variable (the number of bytes following the model name) (total of 12 bytes: 11 characters plus a colon) Example: If the file size is 4568 bytes, subtracting 12 yields the value 4556 bytes, resulting in the string 00000004556.																																																																
12	12 char		model[12]	String containing the model name Example: PW6001-16\0\0																																																																
24	12 char		version[12]	String containing the version Example: 2.00\0\0\0\0\0\0\0\0																																																																
36	48 char		comment[48]	String containing a comment																																																																
84	4 long		saveCH	Channels targeted for saving <table border="1"> <thead> <tr> <th>bit31</th> <th>bit30</th> <th>bit29</th> <th>bit28</th> <th>bit27</th> <th>bit26</th> <th>bit25</th> <th>bit24</th> </tr> </thead> <tbody> <tr> <td>-</td> <td>-</td> <td>-</td> <td>-</td> <td>-</td> <td>-</td> <td>-</td> <td>-</td> </tr> <tr> <th>bit23</th> <th>bit22</th> <th>bit21</th> <th>bit20</th> <th>bit19</th> <th>bit18</th> <th>bit17</th> <th>bit16</th> </tr> <tr> <td>-</td> <td>-</td> <td>-</td> <td>-</td> <td>CHD</td> <td>CHC</td> <td>CHB</td> <td>CHA</td> </tr> <tr> <th>bit15</th> <th>bit14</th> <th>bit13</th> <th>bit12</th> <th>bit11</th> <th>bit10</th> <th>bit9</th> <th>bit8</th> </tr> <tr> <td>-</td> <td>-</td> <td>I6</td> <td>I5</td> <td>I4</td> <td>I3</td> <td>I2</td> <td>I1</td> </tr> <tr> <th>bit7</th> <th>bit6</th> <th>bit5</th> <th>bit4</th> <th>bit3</th> <th>bit2</th> <th>bit1</th> <th>bit0</th> </tr> <tr> <td>-</td> <td>-</td> <td>U6</td> <td>U5</td> <td>U4</td> <td>U3</td> <td>U2</td> <td>U1</td> </tr> </tbody> </table> Example: If all channels have been targeted for saving, the result would be the following binary number: 00000000 00001111 00111111 Expressed in decimal notation: 999231	bit31	bit30	bit29	bit28	bit27	bit26	bit25	bit24	-	-	-	-	-	-	-	-	bit23	bit22	bit21	bit20	bit19	bit18	bit17	bit16	-	-	-	-	CHD	CHC	CHB	CHA	bit15	bit14	bit13	bit12	bit11	bit10	bit9	bit8	-	-	I6	I5	I4	I3	I2	I1	bit7	bit6	bit5	bit4	bit3	bit2	bit1	bit0	-	-	U6	U5	U4	U3	U2	U1
bit31	bit30	bit29	bit28	bit27	bit26	bit25	bit24																																																													
-	-	-	-	-	-	-	-																																																													
bit23	bit22	bit21	bit20	bit19	bit18	bit17	bit16																																																													
-	-	-	-	CHD	CHC	CHB	CHA																																																													
bit15	bit14	bit13	bit12	bit11	bit10	bit9	bit8																																																													
-	-	I6	I5	I4	I3	I2	I1																																																													
bit7	bit6	bit5	bit4	bit3	bit2	bit1	bit0																																																													
-	-	U6	U5	U4	U3	U2	U1																																																													
88	4 long		logicCH	Channels serving as motor logic input Bit 0: CHA; bit 1: CHB; bit 2: CHC; bit 3: CHD CHC and CHD are always used as logic input, so bit 2 and bit 3 are always set to 1. Example: If all channels are being used as logic input, the result would be the following binary number: 00000000 00000000 00000000 00001111 Expressed in decimal notation: 15																																																																
92	4 long		abType	CHA and CHB measurement parameter type <table border="1"> <thead> <tr> <th>bit31</th> <th>bit30</th> <th>bit29</th> <th>bit28</th> <th>bit27</th> <th>bit26</th> <th>bit25</th> <th>bit24</th> </tr> </thead> <tbody> <tr> <td>-</td> <td>-</td> <td>-</td> <td>-</td> <td>-</td> <td>-</td> <td>-</td> <td>-</td> </tr> <tr> <th>bit23</th> <th>bit22</th> <th>bit21</th> <th>bit20</th> <th>bit19</th> <th>bit18</th> <th>bit17</th> <th>bit16</th> </tr> <tr> <td>-</td> <td>-</td> <td>-</td> <td>-</td> <td>-</td> <td>-</td> <td>-</td> <td>-</td> </tr> <tr> <th>bit15</th> <th>bit14</th> <th>bit13</th> <th>bit12</th> <th>bit11</th> <th>bit10</th> <th>bit9</th> <th>bit8</th> </tr> <tr> <td>-</td> <td>-</td> <td>-</td> <td>-</td> <td>-</td> <td>-</td> <td>-</td> <td>-</td> </tr> <tr> <th>bit7</th> <th>bit6</th> <th>bit5</th> <th>bit4</th> <th>bit3</th> <th>bit2</th> <th>bit1</th> <th>bit0</th> </tr> <tr> <td>-</td> <td>-</td> <td>-</td> <td>CHB</td> <td>Spd1 (Analog)</td> <td>Tq2</td> <td>CHA</td> <td>Tq1</td> </tr> </tbody> </table> Example: If the CHA measurement parameter is Tq1 and the CHB measurement parameter is Tq2, the result would be the following binary number: 00000000 00000000 00000101 Expressed in decimal notation: 5	bit31	bit30	bit29	bit28	bit27	bit26	bit25	bit24	-	-	-	-	-	-	-	-	bit23	bit22	bit21	bit20	bit19	bit18	bit17	bit16	-	-	-	-	-	-	-	-	bit15	bit14	bit13	bit12	bit11	bit10	bit9	bit8	-	-	-	-	-	-	-	-	bit7	bit6	bit5	bit4	bit3	bit2	bit1	bit0	-	-	-	CHB	Spd1 (Analog)	Tq2	CHA	Tq1
bit31	bit30	bit29	bit28	bit27	bit26	bit25	bit24																																																													
-	-	-	-	-	-	-	-																																																													
bit23	bit22	bit21	bit20	bit19	bit18	bit17	bit16																																																													
-	-	-	-	-	-	-	-																																																													
bit15	bit14	bit13	bit12	bit11	bit10	bit9	bit8																																																													
-	-	-	-	-	-	-	-																																																													
bit7	bit6	bit5	bit4	bit3	bit2	bit1	bit0																																																													
-	-	-	CHB	Spd1 (Analog)	Tq2	CHA	Tq1																																																													
96	48 char		wiring[6][8]	Connections for 6 channels This field contains an 8-byte string for each of the six channels, in order starting with CH1. Example: If CH1 through CH6 are all set to 1P2W, the result would be the following string: 1P2W\0\0\0\0\01P2W\0\0\0\0\01P2W\0\0\0\0\01P2W\0\0\0\0\01P2W\0\0\0\0\01P2W\0\0\0\0\0																																																																
144	24 float		uRange[6]	Voltage ranges for 6 channels, saved in order starting with CH1																																																																
168	24 float		iRange[6]	Current ranges for 6 channels, saved in order starting with CH1																																																																
192	8 float		analogRange[2]	Motor analog ranges for CHA and CHB																																																																
200	24 float		vt[6]	VT ratios for 6 channels, saved in order starting with CH1																																																																

Offset	Size	Type	Variable name	Description
224	24	float	ct[6]	CT ratios for 6 channels, saved in order starting with CH1
248	8	float	tqScale[2]	Torque scaling values for CHA and CHB
256	4	float	speedScale	Speed scaling value
260	4	long	deltaConv	$\Delta Y$ conversion A value of 1 indicates that the setting is on. Bit 0: CH1; bit 1: CH2; bit 2: CH3; bit 3: CH4; bit 4: CH5; bit 5: CH6 Example: When the setting is on for CH1 through CH6, the result would be the following binary number: 00000000 00000000 00000000 00111111 Expressed in decimal notation: 63
264	24	long	lpf[6]	LPF settings for 6 channels, saved in order starting with CH1
288	4	long	anaLpf	A value of 1 indicates that the motor analog LPF setting is on. Bit 0: CH1; bit 1: CHB; Example: If the setting is on for CHA and CHB, the result would be the following binary number: 00000000 00000000 00000000 00000011 Expressed in decimal notation: 3
292	32	char	logicLpf[4][8]	Motor logic LPF "OFF," "WEAK," or "STRONG" in order starting with CHA Saved as a string Example: If the setting is off for CHA through CHD, the result would be the following string: OFF\0\0\0\0\0OFF\0\0\0\0\0OFF\0\0\0\0\0OFF\0\0\0\0\0
324	4	long	spc	Sensor phase compensation A value of 1 indicates that the setting is on. Bit 0: CH1; bit 1: CH2; bit 2: CH3; bit 3: CH4; bit 4: CH5; bit 6: CH6 Example: If the setting is on for CH1 through CH6, the result would be the following binary number: 00000000 00000000 00000000 00111111 Expressed in decimal notation: 63
328	24	float	spcHz[6]	Sensor phase compensation frequencies for 6 channels, saved in order starting with CH1 Unit: kHz Decimal values may differ slightly from values shown on the instrument's screen.
352	24	float	spcDeg[6]	Sensor phase compensation angles for 6 channels, saved in order starting with CH1 Decimal values may differ slightly from values shown on the instrument's screen.
376	4	long	storageMode	Storage mode A value of 0 indicates peak-peak compression, while a value of 1 indicates thinning.
380	4	long	smplSpd	Sampling speed This sampling speed is used for voltage, current, and logic measurement.
384	4	long	smplSpdAnalog	Sampling speed This sampling speed is used for motor analog measurement.
388	4	long	strgLen	Number of data points This number of data points is used for voltage, current, and logic measurement.
392	4	long	strgLenAnalog	Number of data points This number of data points is used for motor analog measurement.
396	48	double	convRateU[6]	Voltage waveform conversion coefficients for 6 channels, saved in order starting with CH1 Multiplying the waveform data count value by this value yields the voltage measured value.
444	48	double	convRateI[6]	Current waveform conversion coefficients for 6 channels, saved in order starting with CH1 Multiplying the waveform data count value by this value yields the current measured value.
492	16	double	convRateAnalog[2]	Motor analog waveform conversion coefficients for CHA and CHB, saved in order starting with CHA Multiplying the waveform data count value by this value yields the motor analog measured value.
508	24	long	offsetU[6]	Voltage waveform data start positions for 6 channels, saved in order starting with CH1 as the number of bytes from the start of the file The U1 start position is the same as the size field (568) in the settings information. The value 0 is used for channels not selected for saving.

Offset	Size	Type	Variable name	Description
532	24	long	offsetI[6]	Current waveform data start positions for 6 channels, saved in order starting with CH1 as the number of bytes from the start of the file The value 0 is used for channels not selected for saving.
556	4	long	offsetLogic	Motor logic waveform data start position The same value is used for CHA through CHD and indicates the number of bytes from the start of the file. The value 0 is used for channels not selected for saving.
560	8	long	offsetAnalog[2]	Motor analog waveform data start positions for CHA and CHB, saved in order starting with CHA as the number of bytes from the start of the file The value 0 is used for channels not selected for saving.

## Waveform data

Offset	Size	Type	Variable name	Description
568	2 × number of data points	short	wU1Max[]	U1 waveform data count value Indicates the maximum value when the storage mode is peak-peak compression or the value yielded by the anti-aliasing filter when the storage mode is thinning. The number of elements in the array is the same as the number of data points. Parameters for which waveform display is set to OFF are not saved.
Value obtained by multiplying the above offset by the above size	Same as above	short	wU1Min[]	U1 waveform data count value Indicates the minimum value when the storage mode is peak-peak compression or the value shown on the screen when the storage mode is thinning. The number of elements in the array is the same as the number of data points. Parameters for which waveform display is set to OFF are not saved.
Same as above	Same as above	short	wU2Max[]	U2 maximum value or value from anti-aliasing filter
Same as above	Same as above	short	wU2Min[]	U2 minimum value or value shown on screen
Same as above	Same as above	short	wU3Max[]	U3 maximum value or value from anti-aliasing filter
Same as above	Same as above	short	wU3Min[]	U3 minimum value or value shown on screen
Same as above	Same as above	short	wU4Max[]	U4 maximum value or value from anti-aliasing filter
Same as above	Same as above	short	wU4Min[]	U4 minimum value or value shown on screen
Same as above	Same as above	short	wU5Max[]	U5 maximum value or value from anti-aliasing filter
Same as above	Same as above	short	wU5Min[]	U5 minimum value or value shown on screen
Same as above	Same as above	short	wU6Max[]	U6 maximum value or value from anti-aliasing filter
Same as above	Same as above	short	wU6Min[]	U6 minimum value or value shown on screen
Same as above	Same as above	short	wI1Max[]	I1 maximum value or value from anti-aliasing filter
Same as above	Same as above	short	wI1Min[]	I1 minimum value or value shown on screen
Same as above	Same as above	short	wI2Max[]	I2 maximum value or value from anti-aliasing filter
Same as above	Same as above	short	wI2Min[]	I2 minimum value or value shown on screen
Same as above	Same as above	short	wI3Max[]	I3 maximum value or value from anti-aliasing filter
Same as above	Same as above	short	wI3Min[]	I3 minimum value or value shown on screen
Same as above	Same as above	short	wI4Max[]	I4 maximum value or value from anti-aliasing filter
Same as above	Same as above	short	wI4Min[]	I4 minimum value or value shown on screen

Offset	Size	Type	Variable name	Description																																
Same as above	Same as above	short	wI5Max[]	I5 maximum value or value from anti-aliasing filter																																
Same as above	Same as above	short	wI5Min[]	I5 minimum value or value shown on screen																																
Same as above	Same as above	short	wI6Max[]	I6 maximum value or value from anti-aliasing filter																																
Same as above	Same as above	short	wI6Min[]	I6 minimum value or value shown on screen																																
Same as above	Same as above	short	wLMax[]	Motor logic maximum value or value from anti-aliasing filter Value: 0 or 1																																
				<table border="1"> <thead> <tr> <th>bit15</th> <th>bit14</th> <th>bit13</th> <th>bit12</th> <th>bit11</th> <th>bit10</th> <th>bit9</th> <th>bit8</th> </tr> </thead> <tbody> <tr> <td>*</td> <td>*</td> <td>*</td> <td>*</td> <td>CHA</td> <td>CHB</td> <td>CHC</td> <td>CHD</td> </tr> <tr> <th>bit7</th> <th>bit6</th> <th>bit5</th> <th>bit4</th> <th>bit3</th> <th>bit2</th> <th>bit1</th> <th>bit0</th> </tr> <tr> <td>*</td> <td>*</td> <td>*</td> <td>*</td> <td>*</td> <td>*</td> <td>*</td> <td>*</td> </tr> </tbody> </table>	bit15	bit14	bit13	bit12	bit11	bit10	bit9	bit8	*	*	*	*	CHA	CHB	CHC	CHD	bit7	bit6	bit5	bit4	bit3	bit2	bit1	bit0	*	*	*	*	*	*	*	*
				bit15	bit14	bit13	bit12	bit11	bit10	bit9	bit8																									
				*	*	*	*	CHA	CHB	CHC	CHD																									
bit7	bit6	bit5	bit4	bit3	bit2	bit1	bit0																													
*	*	*	*	*	*	*	*																													
Bits marked with an asterisk are undefined and should not be used.																																				
Same as above	Same as above	short	wLMin[]	Motor logic minimum value or value shown on screen See explanation for previous field.																																
Same as above	Same as above	short	wAMax[]	Motor analog A maximum value or value from anti-aliasing filter																																
Same as above	Same as above	short	wAMin[]	Motor analog A minimum value or value shown on screen																																
Same as above	Same as above	short	wBMax[]	Motor analog B maximum value or value from anti-aliasing filter																																
Same as above	Same as above	short	wBMin[]	Motor analog B minimum value or value shown on screen																																

## Data format

Text data portion + binary data portion

- The remaining binary data portion is saved after the text data portion.
- Text data portion: String as variable sizeStr.

## Binary data length

Waveform information is fixed at 568 bytes.

If the number of data points (strLen) is 1000, the size of wU1Max[] would be 1000 (number of data points) × 2 (size of short) = 2000 bytes.

The size of wU1Min[] would also be 2000 bytes.

If only U1 has been selected for waveform saving, the saveCH value would be 1. In this case, the file size would be 568 + 2000 + 2000 = 4568 bytes.

The text data sizeStr[12] at the beginning of the file would be the string "00000004556," the result of subtracting the size of this variable (12 bytes).

## Waveform data conversion method

Acquire the conversion coefficient (convRateU[6], etc.) and the waveform data (wU1Max[], etc.). The waveform data contains count values, which can be converted into numerical data by multiplying the count value by the conversion coefficient.

### Example 1: U1 maximum value data conversion method

Acquire wU1Max for each data point, and multiply by the U1 conversion coefficient (convRateU[0]).

Data for 1st point: wU1Max[0] × convRateU[0]

Data for 2nd point: wU1Max[1] × convRateU[0]

**Example 2: U1 minimum value data conversion method**

Data for 1st point:  $wU1Min[0] \times convRateU[0]$

Data for 2nd point:  $wU1Min[1] \times convRateU[0]$





## 8.1 Synchronization Interface (Two-instrument Synchronized Measurement)

### CAUTION



**Do not connect or disconnect connectors while the instrument is powered on. Doing so may damage the instrument.**

Synchronized measurement can be performed by connecting two instruments with the optional L6000 Optical Connection Cable. Since synchronization is performed using optical fiber—without electrical signals—it is possible to connect two instruments with different earth potentials without issue.

There are two operating modes for synchronized measurement, with the following features:

Numerical synchronization mode	The slave instrument's basic measurement parameters are transmitted to the master instrument at every synchronized data update rate interval, allowing the pair of instruments to function as a power meter with up to 12 channels. No distinction is made between the master and slave instruments. Up to 12 channels of basic measurement parameter data can be freely displayed on the screen, efficiency calculated, and files saved.
Waveform synchronization mode	Voltage and current sampling waveforms for up to three channels on the slave instrument are transmitted to the master instrument, where they are combined with three channels on the master instrument so that the pair of instruments functions as a six-channel power meter. Waveforms sampled in a synchronized manner with the slave instrument, which can be located up to 500 m away, can be displayed on the same screen with waveforms from the master instrument, and the phase difference between them can be simultaneously compared using vectors.

- Up to two instruments can be synchronized. It is not possible to synchronize three or more instruments.
- Only PW6001 instruments can be connected. Connecting another device may cause a malfunction.
- In addition to the optional L6000 Optical Connection Cable, instruments may be connected using 50/125  $\mu\text{m}$  multi-mode fiber with a standard Duplex-LC (2-core LC) connector (over a length of up to 500 m).
- There will be a sampling clock frequency deviation of up to 200 ppm between two synchronized instruments. When using waveform synchronization mode at 5 MS/s, sampling interpolation or thinning will occur at a frequency of up to 1,000/sec. in order to adjust for this deviation.
- Waveforms that have been interpolated or thinned may influence the results of FFT analysis and harmonic measurement results at 10 kHz or above.

## Connecting 2 instruments with the L6000 Optical Connection Cable

You will need: PW6001 (×2), L6000 Optical Connection Cable (×1)

Back

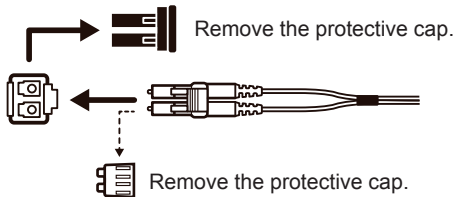
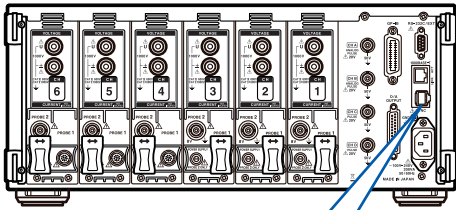

- 1 Verify that both instruments have been powered off.
- 2 Connect the optical connection cable to the synchronization connectors on the back of the master and slave instruments.
- 3 Turn on the master instrument and then the slave instrument (in that order). (Power the instruments off in the opposite order.)

- During synchronization control, control data for the two instruments is transmitted via the L6000 Optical Connection Cable. Never disconnect the cable as doing so will prevent the instruments from being synchronized.
- Powering off either the master or slave instrument will result in a synchronization error.
- Ensure that the master and slave instruments have the same software version. Using instruments with different software versions will result in a synchronization error.

## Configuring synchronized measurement

This section describes how to configure the master and slave instruments.

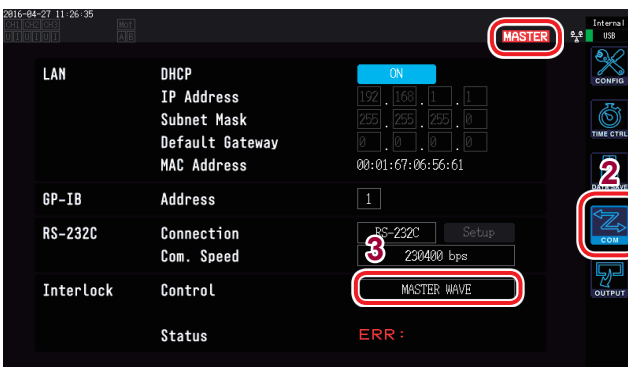

- 1 Press the **[SYSTEM]** key.
- 2 Touch **COM**.
- 3 Touch **Interlock - Control** and configure the settings.

You can check the synchronization status with the operating status indicator at the top right of the screen.

- Configure these settings while both instruments are connected with the L6000 Optical Connection Cable and powered on.
- When the data update rate is set to 10 ms, numerical synchronization mode cannot be selected.
- If the master and slave instruments are set to different data update rates, set the master data update rate to the slave instrument.

<b>MASTER</b>	Master instrument in numerical synchronization mode (blue background)
<b>SLAVE</b>	Slave instrument in numerical synchronization mode (white background)
<b>MASTER</b>	Master instrument in waveform synchronization mode (cyan background)
<b>SLAVE</b>	Slave instrument in waveform synchronization mode (cyan background)
<b>MASTER</b>	Synchronization error (red background) (The background of the slave instrument's indicator may also turn red.)

## Numerical synchronization mode

<b>Synchronization parameters</b>	Parameters are synchronized between the master and slave instruments at the data update timing. The slave instrument will also respond to the [START/STOP] and [DATA RESET] keys on the master instrument.
<b>Delay</b>	Synchronization timing between the master and slave instruments will be delayed by up to 20 $\mu$ s.
<b>Functions</b>	Slave basic measurement parameters can be selected for use with the following functions on the master instrument: <ul style="list-style-type: none"> <li>• CUSTOM screen display parameters</li> <li>• Parameters being saved to a USB flash drive or the internal memory</li> <li>• Parameters used in efficiency calculation formulas (active power only, including motor power)</li> <li>• User-defined calculation parameters</li> <li>• Analog output parameters</li> </ul>

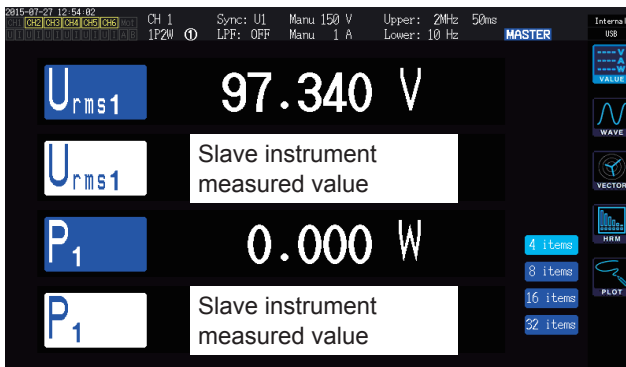
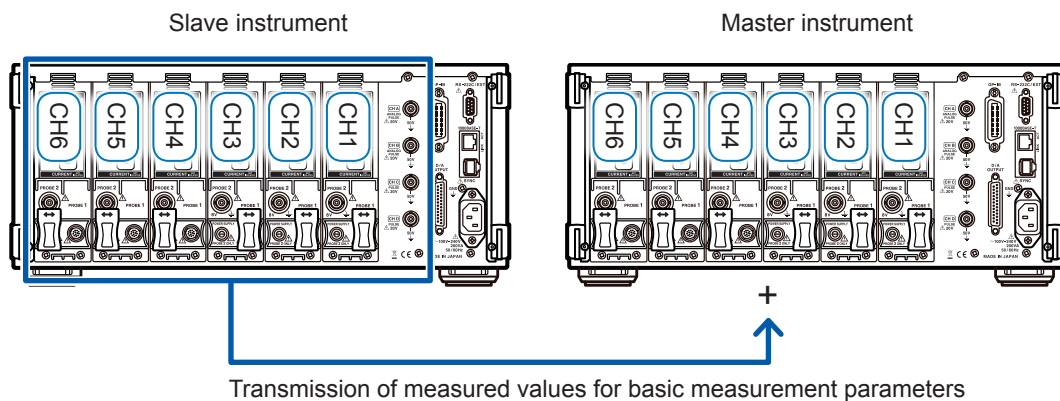

When a measured value from the slave instrument is selected on the CUSTOM screen as a display parameter, the color of the parameter name will be reversed.

- Slave instrument harmonic measured values and waveforms cannot be displayed on the master instrument.
- Slave instrument settings cannot be checked or changed from the master instrument.
- The master and slave instruments' hold and peak hold functions operate independently of one another.

**Waveform synchronization mode**

<b>Synchronization parameters</b>	Parameters are synchronized at the master and slave instruments' voltage and current waveform sampling timing.
<b>Delay</b>	The sampling timing will be delayed by up to 5 samples.
<b>Functions</b>	By transmitting the slave instrument's CH 1 to CH 3 voltage and current sampling waveforms to the master instrument's CH 4 to CH 6, the master instrument will operate as a six-channel power meter. Not only basic measurement parameters, but also harmonic and waveform can be measured in the same manner as input to CH 4 to CH 6 on the master instrument.

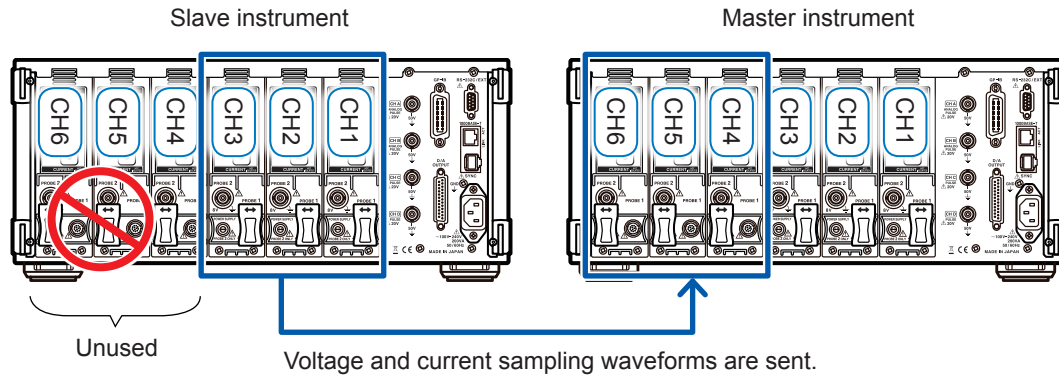

- If either the master instrument or slave instrument has less than three channels, waveform synchronization mode cannot be used.
- Voltage and current signals input to CH 4 to CH 6 on the master instrument, voltage signals input to CH 4 to CH 6 on the slave instrument, and motor input signals input to the slave instrument cannot be used in measurement.
- On the slave instrument, no settings can be changed except to cancel slave mode, including measurement.
- No slave instrument interfaces can be used, including D/A output.

## 8.2 Using D/A Output (Motor Analysis and D/A-equipped Models Only) (Analog and Waveform Output)

Motor analysis and D/A-equipped models can generate analog output for user-specified measured values as well as voltage and current waveforms as-is.

Analog output can be used to record fluctuations over extended periods of time based on the data update rate. Waveform output generates output of voltage and current waveforms sampled at 5 MS/s without modification at 1 MS/s, allowing them to be observed in combination with another device such as an oscilloscope.

### Connecting an application-specific device to the instrument

This section describes how to connect an application-specific device (for example, an oscilloscope, data logger, or recorder) to the instrument's D/A output terminal using its D-sub connector. To ensure safe operation, be sure to turn off the instrument and device before connecting them. Once they have been connected, turn them back on.

#### Output circuit

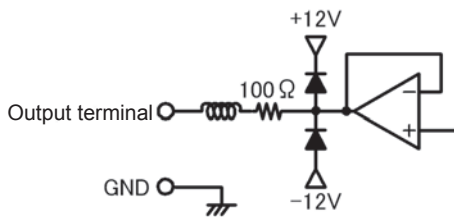

The output impedance of each output terminal is approximately 100 Ω. When connecting a recorder, DMM, or other device, use a model with high input impedance (1 MΩ or greater). See "Specifications"(p.207).

#### D/A output terminal pin layout

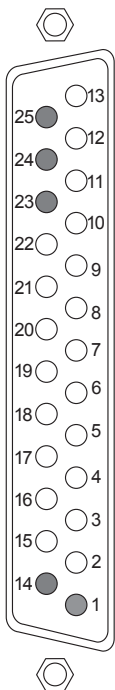

Pin no.	Output ( ): Waveform output
1	GND
2	D/A1 (U1)
3	D/A2 (I1)
4	D/A3 (U2)
5	D/A4 (I2)
6	D/A5 (U3)
7	D/A6 (I3)
8	D/A7 (U4)
9	D/A8 (I4)
10	D/A9 (U5)
11	D/A10 (I5)
12	D/A11 (U6)
13	D/A12 (I6)

Pin no.	Output
14	GND
15	D/A13
16	D/A14
17	D/A15
18	D/A16
19	D/A17
20	D/A18
21	D/A19
22	D/A20
23	GND
24	GND
25	GND

## D/A output terminal connection method

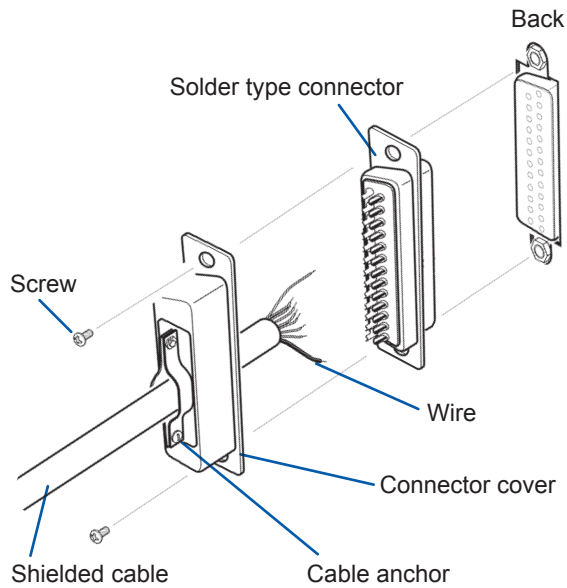

Use the connector included with the instrument to make connections to external control terminals and output terminals (DB-25P-NR, DB19678-2R Japan Aviation Electronics Industry, Ltd.) or equivalent parts.

- Solder wires in place securely.
- Be sure to secure the cable with the included screws (M2.6 × 6) along with the connector cover so that the connector will not come loose.
- Grip the connector cover when connecting or disconnecting the connector.
- Be sure to use shielded cables for output and external control.
- If the cable's shielding is not grounded, connect it to the connector cover or cable anchor shown in the above figure.

## Selecting output parameters

This section describes how to select output parameters for D/A output. Up to 20 parameters may be selected using the **D/A output** setting on the Settings screen.

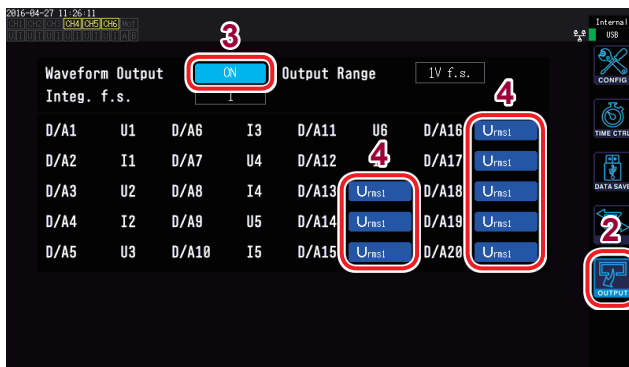

- 1 Press the **[SYSTEM]** key.
- 2 Touch **OUTPUT**.
- 3 Select whether to use waveform output.

<b>ON</b>	Enables waveform output.
<b>OFF</b>	Disables waveform output. (Analog output for all channels)

- 4 Touch the channel parameter you wish to set.

The basic measurement parameter selection dialog box will be displayed.

- 5 Touch the desired setting to select it.

To cancel the operation, touch **x** to close the dialog box.

Parameter	Settings	Description
<b>Integ. f.s.</b> (Integration full scale)	1/10, 1/2, 1, 5, 10, 50, 100, 500, 1000, 5000, 10000	Set when outputting integration values as analog output.
<b>Output range</b>	1V f.s. , 2V f.s.	Set to the output voltage value for full-scale input during waveform output. (p. 178)

- When waveform output is selected, waveform output is fixed to channels 1 through 12 (D/A1 to D/A12). Channels 13 through 20 (DA13 to D/A20) can only be selected when using analog output.
- Parameters set on the Measurement, Settings, or File Operations screen are output continuously.
- The D/A13 to D/A20 D/A output parameters are linked to the D/A13 to D/A20 D/A output parameters in the D/A monitor graph (p. 131) and D/A13 to D/A16 in the X-Y plot (p. 133). Changing the set parameters in one of these locations will change them in the other locations as well.
- Similarly, the integration full-scale setting is linked to the D/A monitor graph and the X-Y plot. Changing the setting in one of these locations will change it in the other locations as well.

## Analog output

- The instrument's measured values are level-converted and output as a DC voltage.
- Voltage input and current input (current sensor input) are isolated.
- You can output 20 parameters (when waveform output is selected, 8 parameters) by selecting one parameter from the basic measurement parameters for each output channel.
- By using the instrument in combination with a data logger or recorder, you can record fluctuations over extended periods of time.

### Specifications

<b>Output voltage (Output range)</b>	±5 V DC f.s. (effective output range: 1% f.s. to 110% f.s.) (For more information about the output rate for each parameter, see "Output rates" [p.180].)
<b>Output resistance</b>	100 Ω ±5 Ω
<b>Output update rate</b>	Varies with the data update rate for the selected parameters.

- The instrument will generate output of approximately 6 V during positive over-range events (but approximately 5.3 V at voltage peak and current peak). For negative over-range events, the instrument will generate output of approximately -6 V (but approximately -5.3 V at voltage peak and current peak).
- The instrument may generate maximum output of approximately ±12 V in the event of a malfunction.
- When using a VT ratio or CT ratio, the instrument will output the value obtained by multiplying the range by the VT ratio or CT ratio within the range of ±5 V DC.
- While in the hold state or peak hold state, and during averaging operation, the instrument will output the appropriate operational value.
- During hold operation while an interval time has been set, output will be updated at each interval time after the start of integration.
- When the measurement range has been set to AUTO, the analog output rate will vary with changes to the range. In instances such as abruptly fluctuating measured values, exercise care so as not to make any mistakes in range conversion. In addition, it is recommended to fix the range manually during such measurement.
- Data cannot be output using the harmonic analysis function for parameters other than basic measurement parameters.

### Integration full scale

When using analog output, set the integration full-scale value. For example, if the integration value is small relative to the full-scale value, it will take a long time for the integration value to reach the full-scale value, causing the D/A output voltage to vary gradually. Conversely, if the integration value is large relative to the full-scale value, it will take less time for the integration value to reach the full-scale value, causing the D/A output voltage to vary abruptly. By setting the integration full scale, you can change the active power integration D/A output full-scale value.



## Waveform output

- The instrument will generate instantaneous waveforms for the input voltage and current.
- Voltage inputs and current inputs (current sensor inputs) are isolated.
- The instrument can be used in combination with an oscilloscope or other device to observe input waveforms such as equipment rush current.

Specifications	<b>Output voltage (Output range)</b>	Select from $\pm 1$ V or $\pm 2$ V. Crest factor: 2.5 or greater
	<b>Output resistance</b>	100 $\Omega$ $\pm 5$ $\Omega$
	<b>Output update rate</b>	1 MHz (16-bit)

- The time required to output a signal that is input to a voltage or current input pin from the D/A output connector (i.e., the delay time) is approximately 100  $\mu$ s.
- Waveforms are clipped at approximately  $\pm 7$  V.
- The instrument will generate output of 0 V at all times for channels that have not been installed. Channels for which D/A output has been enabled are shown in red.
- The instrument may generate maximum output of approximately  $\pm 12$  V in the event of a malfunction.
- When using a VT ratio or CT ratio, the instrument will output the voltage obtained by multiplying the range by the VT ratio or CT ratio.
- Waveform output consists of continuous instantaneous value output, without regard to hold, peak hold, or averaging operation.
- When the measurement range has been set to AUTO, the analog output rate will vary with changes to the range. In instances such as abruptly fluctuating measured values, exercise care so as not to make any mistakes in range conversion. In addition, it is recommended to fix the range during such measurement.

## Output rates

Analog output is generated as a voltage of  $\pm 5$  V DC relative to full scale. At full scale, the voltage listed in the following table will be output.

✓: Output voltage has polarity.

Selected output parameter	Notation	Polarity	Rated output voltage
Voltage RMS value	Urms		0 V to +5 V DC relative to 0% to 100% f.s. of range
Voltage mean value rectification RMS equivalent	Umn		0 V to +5 V DC relative to 0% to 100% f.s. of range
Voltage AC component	Uac		0 V to +5 V DC relative to 0% to 100% f.s. of range
Voltage simple average	Udc	✓	$\pm 5$ V DC relative to $\pm 100\%$ f.s. of range
Voltage fundamental wave component	Ufnd		0 V to +5 V DC relative to 0% to 100% f.s. of range
Voltage waveform peak (+)	Upk+	✓	$\pm 5$ V DC relative to $\pm 300\%$ f.s. of range
Voltage waveform peak (-)	Upk-	✓	$\pm 5$ V DC relative to $\pm 300\%$ f.s. of range
Total voltage harmonic distortion	Uthd		0 V to +5 V DC relative to 0% to 500%
Voltage ripple factor	Urf		0 V to +5 V DC relative to 0% to 500%
Voltage unbalance rate	Uunb		0 V to +5 V DC relative to 0% to 100%
Current RMS value	Irms		0 V to +5 V DC relative to 0% to 100% f.s. of range
Current mean value rectification RMS equivalent	Imn		0 V to +5 V DC relative to 0% to 100% f.s. of range
Current AC component	Iac		0 V to +5 V DC relative to 0% to 100% f.s. of range
Current simple average	Idc	✓	$\pm 5$ V DC relative to $\pm 100\%$ f.s. of range
Current fundamental wave component	Ifnd		0 V to +5 V DC relative to 0% to 100% f.s. of range
Current waveform peak (+)	Ipk+	✓	$\pm 5$ V DC relative to $\pm 300\%$ f.s. of range
Current waveform peak (-)	Ipk-	✓	$\pm 5$ V DC relative to $\pm 300\%$ f.s. of range
Total current harmonic distortion	Ithd		0 V to +5 V DC relative to 0% to 500%
Current ripple factor	Irf		0 V to +5 V DC relative to 0% to 500%
Current unbalance rate	Iunb		0 V to +5 V DC relative to 0% to 100%
Active power	P	✓	P1/P2/P3/P4/P5/P6: Voltage range $\times$ current range P12/P34/P45/P56: (Voltage range $\times$ current range) $\times$ 2 P123/P456 (3V3A, 3P3W3M): (Voltage range $\times$ current range) $\times$ 2 P123/P456 (3P4W): (Voltage range $\times$ current range) $\times$ 3 Example: For 3P4W, P123, 300 V range, 10 A range: 300 V $\times$ 10 A $\times$ 3 = full scale of 9 kW DC $\pm 5$ V relative to $\pm 9$ kW f.s.
Fundamental wave active power	Pfnd	✓	Same as active power (P)
Apparent power	S		S1/S2/S3/S4/S5/S6: Voltage range $\times$ current range S12/S34/S45/S56: (Voltage range $\times$ current range) $\times$ 2 S123/S456 (3V3A, 3P3W3M): (Voltage range $\times$ current range) $\times$ 2 S123/S456 (3P4W): (Voltage range $\times$ current range) $\times$ 3 Example: For S34, 150 V range, 10 A range: 150 V $\times$ 10 A $\times$ 2 = full scale of 3 kW 0 V to +5 V DC relative to 0 to 3 kW f.s.

✓: Output voltage has polarity.

Selected output parameter	Notation	Polarity	Rated output voltage
Fundamental wave apparent power	Sfnd		Same as apparent power (S)
Reactive power	Q	✓	Same as active power (P)
Fundamental wave reactive power	Qfnd	✓	Same as active power (P)
Power factor	$\lambda$	✓	$\pm 5$ V DC relative to power factor of $\pm 1$
Fundamental wave power factor	$\lambda$ .fnd	✓	$\pm 5$ V DC relative to fundamental wave power factor of $\pm 1$
Voltage phase angle	$\theta_U$	✓	$\pm 5$ V DC relative to voltage phase angle of $\pm 180^\circ$
Current phase angle	$\theta_I$	✓	Same as voltage phase angle ( $\theta_U$ )
Power phase angle	$\phi$	✓	Same as voltage phase angle ( $\theta_U$ )
Frequency	f		+5 V DC relative to the upper limit frequency setting
Positive-direction current integration value	Ih+		Same as total positive- and negative- direction current integration value (Ih)
Negative-direction current integration value	Ih-	<sup>-4</sup>	Same as total positive- and negative- direction current integration value (Ih)
Total positive- and negative-direction current integration value	Ih	✓	Current range $\times$ integration full scale Example: If integrating for 1 hour with the 10 A range: 10 Ah is current integration f.s. <sup>2</sup> $\pm 5$ V DC relative to $\pm 10$ Ah
Positive-direction power integration value	WP+		Same as total positive- and negative- direction power integration value (WP)
Negative-direction power integration value	WP-	<sup>-4</sup>	Same as total positive- and negative- direction power integration value (WP)
Total positive- and negative-direction power integration value	WP	✓	WP1/WP2/WP3/WP4/WP5/WP6: Voltage range $\times$ current range $\times$ integration full scale WP12/WP34/WP45/WP56: (Voltage range $\times$ current range $\times$ integration full scale) $\times 2$ WP123/WP456 (3V3A, 3P3W3M): (Voltage range $\times$ current range $\times$ integration full scale) $\times 3$ Example: If integrating 1 hour with the 300 V range and the 10 A range for WP123: 9 kWh is the active power integration f.s. $\pm 5$ V DC relative to $\pm 9$ kWh
Efficiency	$\eta$		0 V to +5 V DC relative to 0% to 200%
Loss value	Loss	✓	Pin = Pin1 + Pin2 + Pin3 + Pin4 Pout = Pout1 + Pout2 + Pout3 + Pout4 The larger of Pin and Pout is used as the P range. $\pm 5$ V DC relative to $\pm 100\%$ of the P range Example: With the 3 kW P range, $\pm 5$ V DC relative to $\pm 100\%$ of 3 kW
Torque	Tq	✓	Analog DC input: Voltage range $\times$ scale value = Rated torque $\pm 5$ V DC relative to $\pm 100\%$ of the rated torque Frequency input: Scale value = Rated torque $\pm 5$ V DC relative to $\pm 100\%$ of the rated torque

Selected output parameter	Notation	Polarity	Rated output voltage
RPM	Spd	✓	Analog DC input: Voltage range × scale value = Rated RPM Pulse input: (60 × upper limit frequency) / pulse count setting = Rated RPM ±5 V DC relative to ±100% of the rated RPM
Motor power	Pm	✓	±5 V DC relative to ±100% of the Pm range <sup>*3</sup>
Slip	Slip	✓	±5 V DC relative to ±100%
Free input during independent input mode operation	CH*	✓ <sup>*1</sup>	Analog DC input: ±5 V DC relative to ±100% of the voltage range Pulse input: ±5 V DC relative to ±100% of the upper limit frequency
User-defined calculation	UDF	✓	±5 V DC relative to ±100% of the "MAX" value set for each user-defined calculation

\*1: Analog DC input has polarity, but pulse frequency input does not.

\*2: If the voltage for the integration value would exceed ±5 V, analog output will switch to 0 V before continuing to vary.

\*3: The Pm range is calculated using the motor power calculation formula by using the rated torque as the torque and the rated RPM as the RPM.

\*4: Value always has a negative sign.

## Examples of D/A output

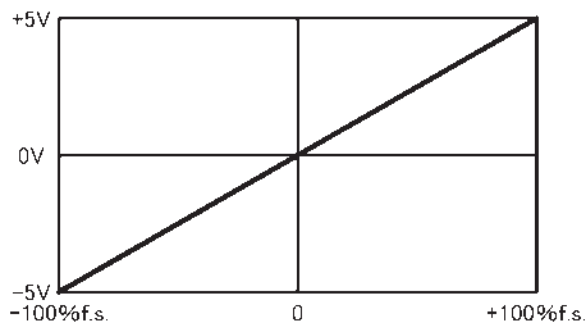

Voltage/current (dc), active power, reactive power

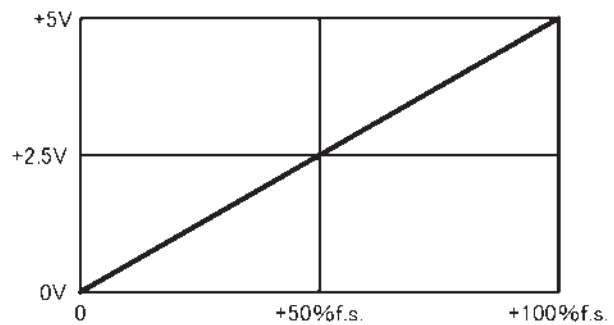

Voltage/current (rms, mn, ac, fnd, unb), apparent power

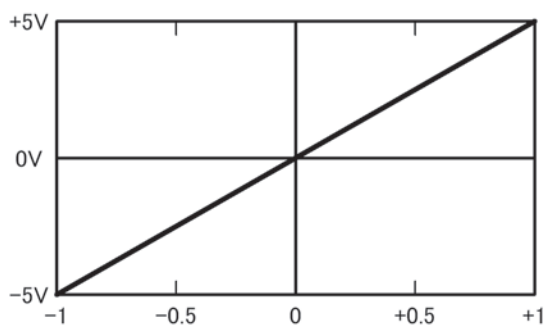

Power factor

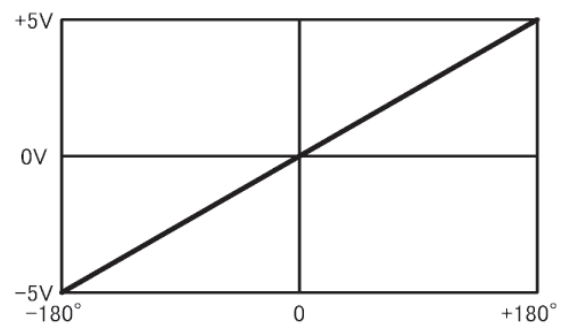

Voltage, current, power phase angle

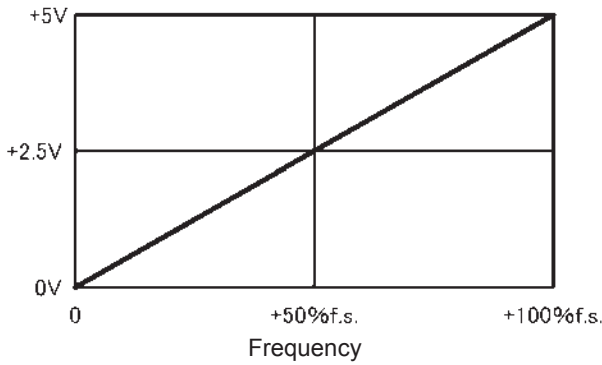

The upper limit frequency setting is used as 100% f.s.

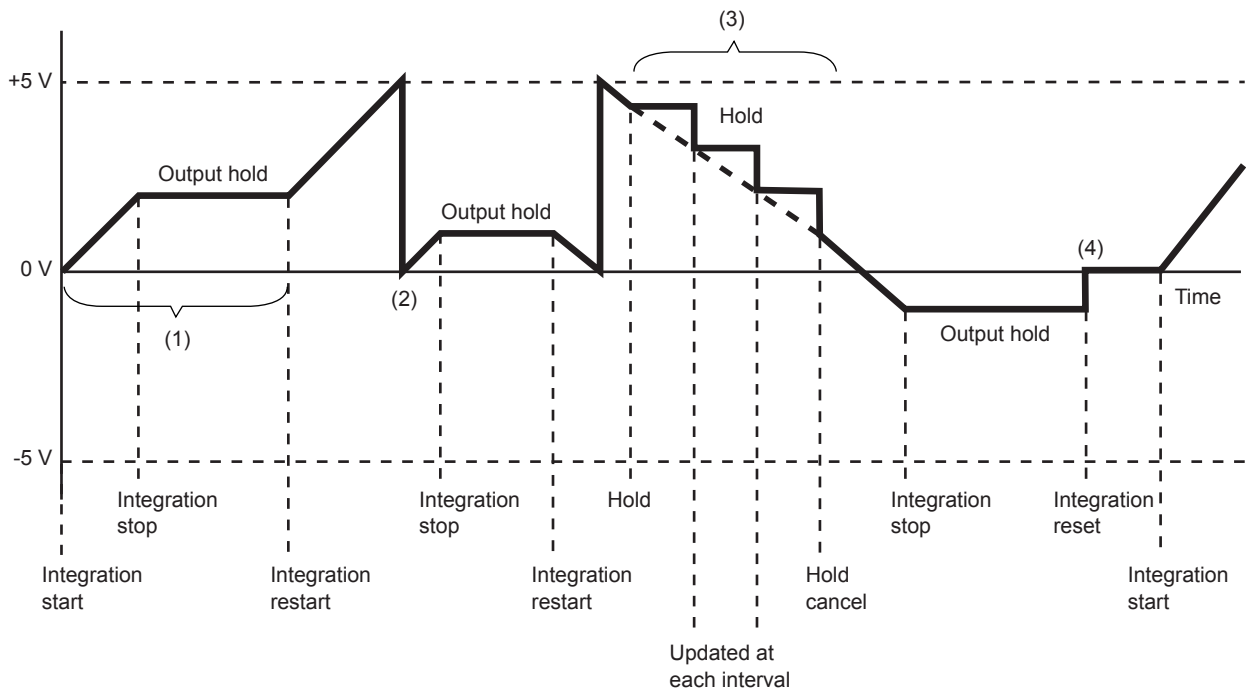

- (1) Analog output varies with the start of integration. Analog output is held when integration stops.
- (2) If the voltage for the integration value would exceed  $\pm 5$  V, analog output will switch to 0 V before continuing to vary.
- (3) Analog output is held when the display is held during integration. The output is updated every interval time. When the hold is canceled, analog output will vary based on the original integration value.
- (4) When the integration value is reset, analog output will switch to 0 V.

## 8.3 Using Motor Analysis (Motor Analysis and D/A-equipped Models Only)

Motor analysis and D/A-equipped models of the instrument can perform motor analysis when used with an external torque sensor and tachometer. The motor analysis function can be used to measure torque, RPM, motor power, and slip by inputting the signals from a torque sensor and a tachometer such as a rotary encoder (incremental type). In addition, the inputs can be used as two analog channels and two pulse input channels.

### WARNING

To avoid electric shock or damage to the equipment, always observe the following precautions when connecting signals to the CH A through CH D input terminals:



- Always turn off the instrument and any devices being connected before making connections.
- Ensure that each terminal's signal does not exceed the applicable rating.
- Loose connections during operation pose a hazard, for example by coming into contact with other energized parts. Ensure that connections are secure.

### CAUTION

To prevent damage to the connector, be sure to release the locking mechanism, grip the head of the connector (not the cable), and pull it out.



Instrument input terminal connector guides

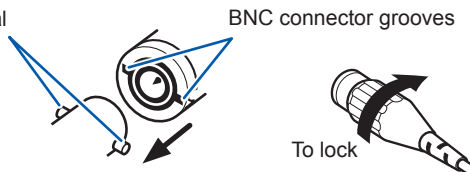

## Connecting a torque meter and tachometer

Rear

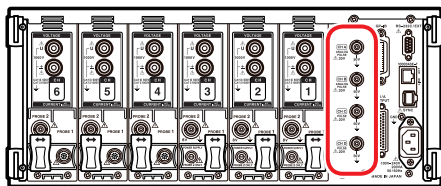

Motor analysis and D/A-equipped models of the instrument have four input terminals (isolated BNC connectors: CH A, CH B, CH C, and CH D) on the back panel.

Since each terminal is isolated from the instrument, and since the CH A through CH D terminals are isolated from each other, various sensors and other devices with different ground potentials can be connected to the instrument.

You will need: L9217 Connection Cord (necessary quantity), device to be connected (torque sensor, tachometer, etc.)

- 1 Verify that the instrument and the device being connected have been powered off.
- 2 Connect the connected device's output terminal to the instrument with a connection cord, as illustrated in the example on the following page.
- 3 Turn on the instrument.
- 4 Turn on the connected device.

## Operating modes and connection methods

The instrument provides three operating modes for motor input:

<b>Single motor</b> (Default setting)	CH A: Torque signal input CH B: RPM signal input CH C: Direction of rotation input CH D: Origin signal input	This mode is used to analyze a single motor. It can be used not only to measure motor power and efficiency, but also to perform analysis combining direction of rotation with regeneration/power operation or advanced analysis in the form of electrical angle measurement. Measurement can also be synchronized to one cycle of the mechanical angle.
<b>Dual motor</b>	CH A: Torque signal input 1 CH B: Torque signal input 2 CH C: RPM signal input 1 CH D: RPM signal input 2	This mode is used to simultaneously analyze two motors. It allows motor power and efficiency to be measured simultaneously for two circuits.
<b>Independent input</b>	CH A: Analog DC input 1 CH B: Analog DC input 2 CH C: Pulse input 1 CH D: Pulse input 2	This mode is used to measure and display readings for sensor signals consisting of voltage output and to connect pulse inputs, measure their frequencies, and display their waveforms. CH A and B can also be used for pulse inputs.

- When inputting an origin signal (Z-phase pulse) to CH D in single-motor mode, be sure to input the pulse output from the same encoder to CH B. If the timing of the rising edge of the pulse input to CH B and the timing of the rising edge of the pulse input to CH D are reversed, RPM measurement may become unstable.
- When performing pulse-based measurement during motor analysis, use a signal such that the pulse count is a whole-number multiple of the number of motor pole pairs (half the motor pole number). (p.60)
- In dual-motor mode, analog DC output type tachometers cannot be used. Always connect a pulse output type tachometer.
- In environments with a large amount of noise, ground connected sensors and the instrument to the same potential.

### Example single-motor mode connections

**Example 1: Example of motor power measurement (measurement parameters: set to Pattern 4)**

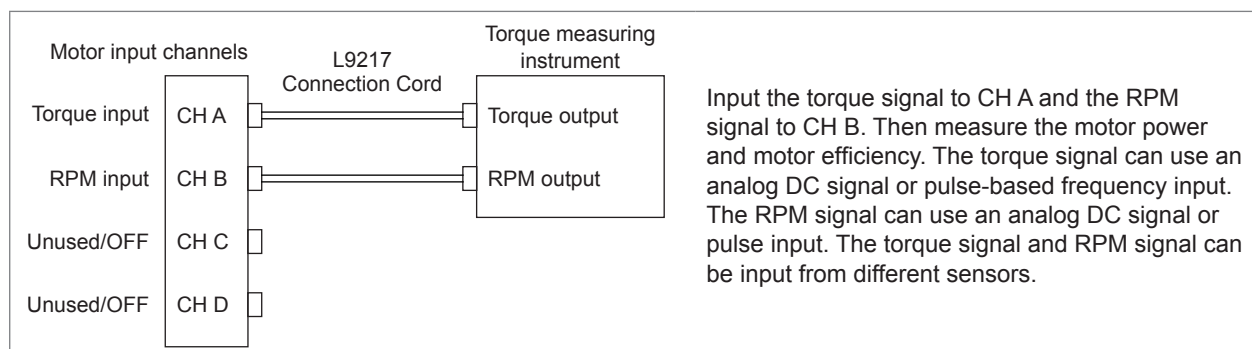

**Example 2: Motor power measurement with forward/reverse detection (measurement parameters: set to Pattern 2)**

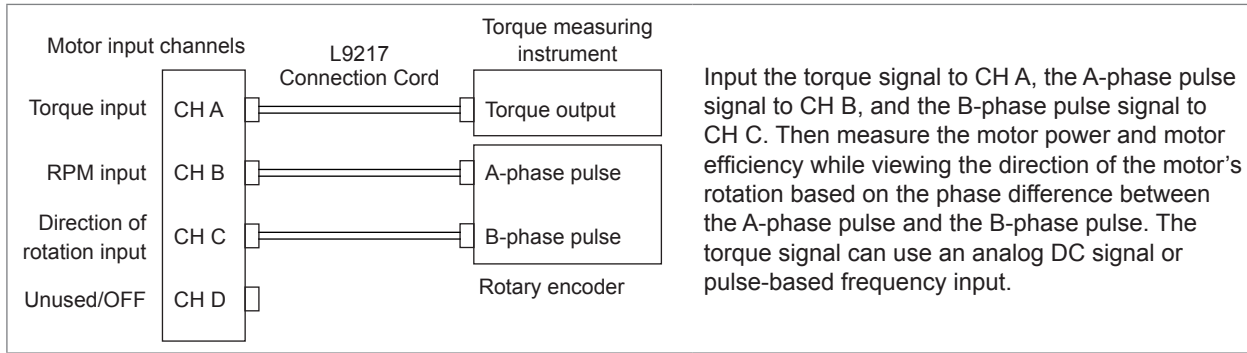

**Example 3: Example of motor power measurement and electrical angle measurement (measurement parameters: set to Pattern 1)**

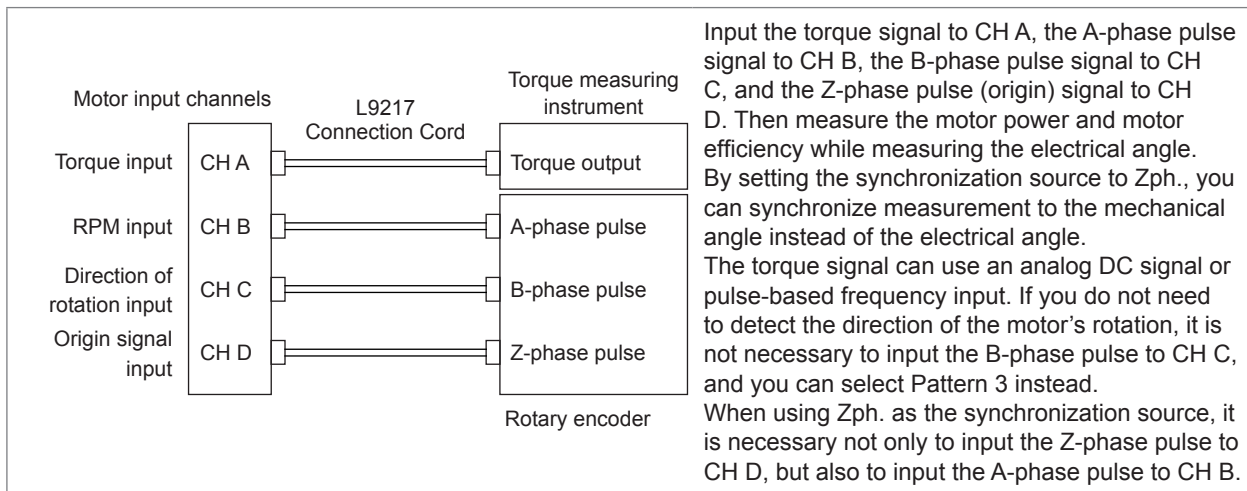

**Example of dual-motor mode connection**

**Example 4: Example of motor power measurement**

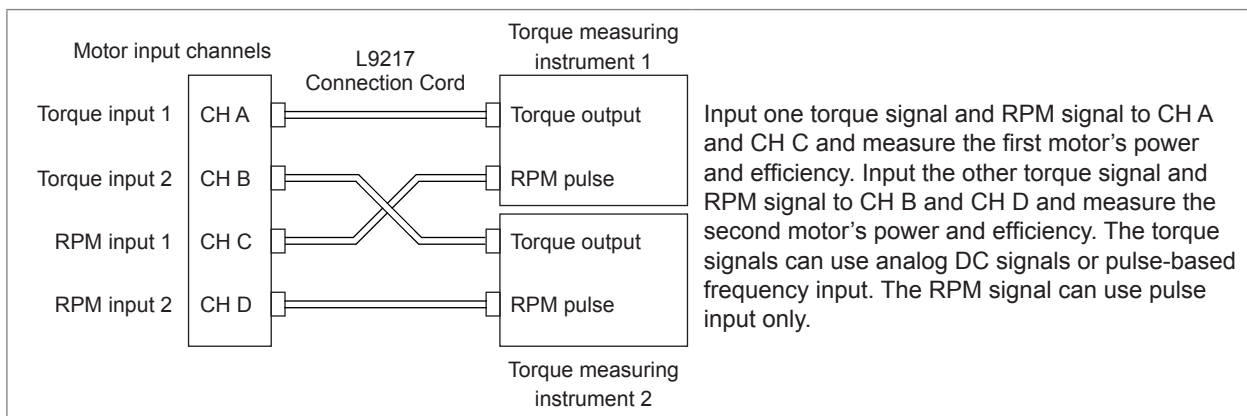

**Setting the connected motor inputs and displaying measured values**

For more information about displaying measured values and configuring the instrument, see “3.6 Viewing Motor Measured Values (Motor Analysis and D/A-equipped Models)”(p. 82).



## 8.4 Controlling Integration with External Signals

Integration can be started and stopped, and integration data can be reset, with 0 V/5 V logic signals or short/open contact signals using the instrument's external control interface. You can also supply a power at +5 V and up to 200 mA to the external control device.

Rear

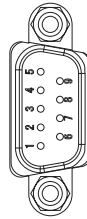
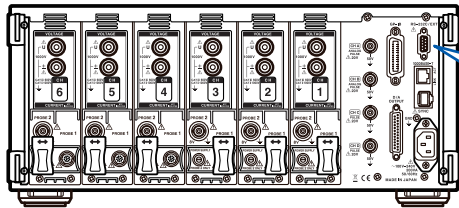

9-pin D-sub plug (male)  
Locking screws: #4-40

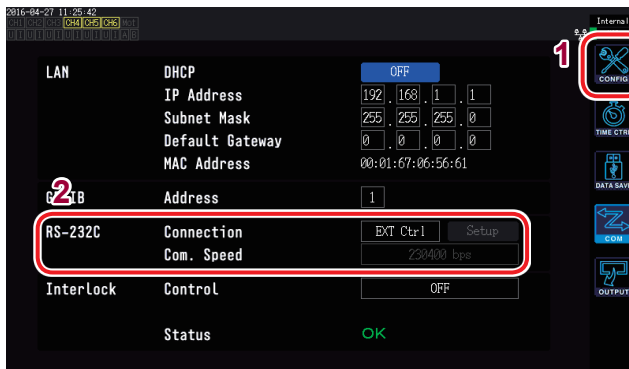

- 1 Press the **[SYSTEM]** key.
- 2 Touch **COM**.
- 3 Touch the RS-232C connection setting and select **EXT Ctrl**.

- Prepare a device to control the instrument with functions allocated to the pin numbers listed below.
- Provide a 9-pin D-sub female connector or cut off the male-side connector of the 9444 Connection Cable and provide a direct connection to the device based on the internal cable colors.
- Leave unused pins open.

Pin number	Cable color	Function
1	Brown	Start/stop integration When this pin changes from high (5 V or open) to low (0 V or shorted), integration will start. When it changes from low to high, integration will stop.
2	Red	Unused
3	Orange	Unused
4	Yellow	Hold When this pin changes from high (5 V or open) to low (0 V or shorted), the display will be held. When it changes from low to high, the hold will be canceled.
5	Green	GND
6	Blue	Reset integration values When this pin is low for at least 200 ms, integration values will be reset. This function is valid only while integration is stopped.
7	Purple	Unused
8	Gray	Unused
9	White	Power supply +5 V, up to 200 mA

### External control terminal internal circuit diagram

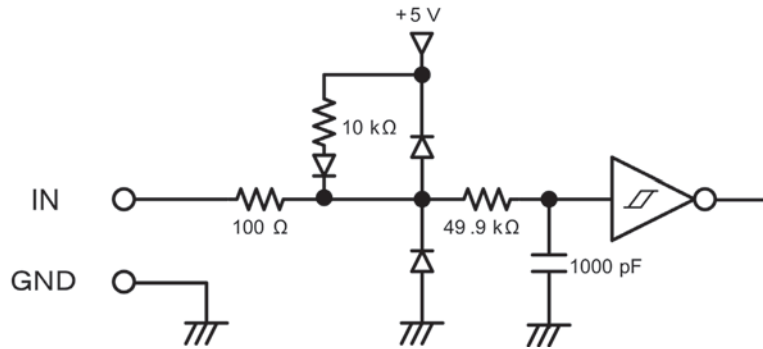

### Connecting the cable

You will need: 9444 Connection Cable and the external device you will use to control the instrument

Connect the 9444 Connection Cable to the instrument's 9-pin D-sub connector. Be sure to secure it in place with screws.

### Control signal timing

External control interface signals are detected during the intervals shown on the timing chart below. The display may be delayed depending on the frequency being measured and on how two-instrument synchronization is being used.

### Starting and stopping integration

This signal controls whether integration is started or stopped. This operation is the same as that performed by the **[START/STOP]** key on the instrument's panel.

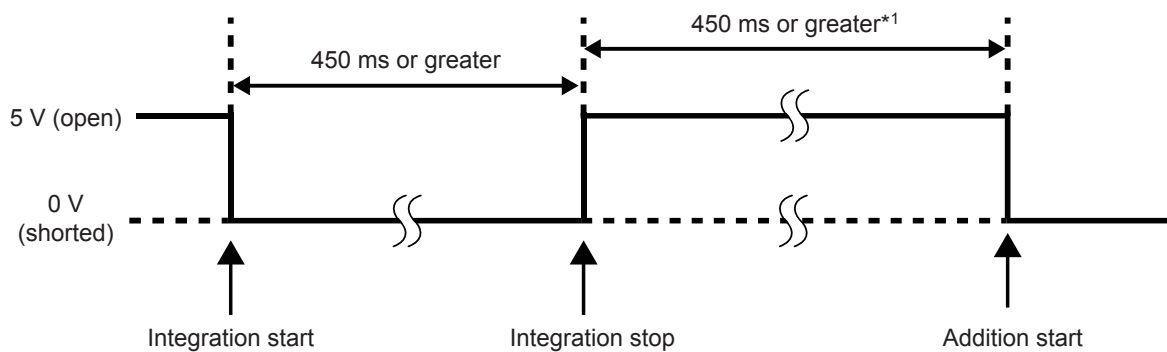

\*1: When automatic saving is enabled, 1 sec. or greater

## Resetting integration values

This signal controls whether integration values are reset. This operation is the same as that performed by the **[DATA RESET]** key on the instrument's panel.

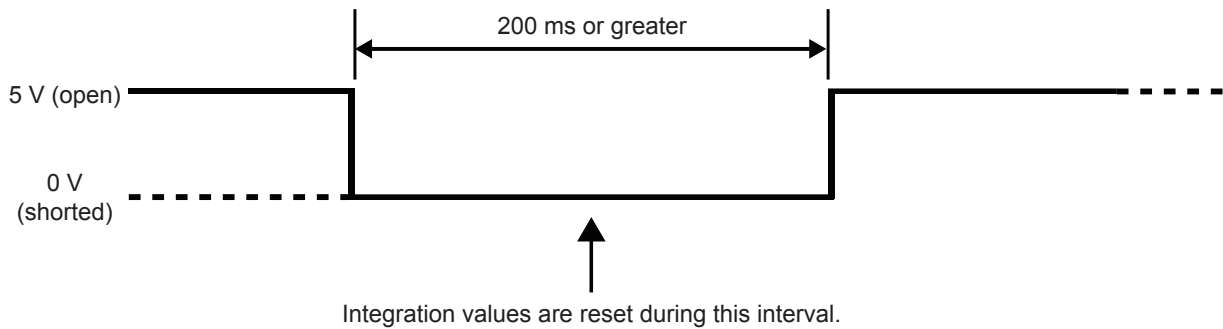

This signal is ignored while integration is being performed. Allow at least 450 ms (or when automatic saving is enabled, at least 1 sec.) to pass after integration stops before inputting this signal.

## Holding the display

This operation is the same as that performed by the **[HOLD]** key on the instrument's panel.

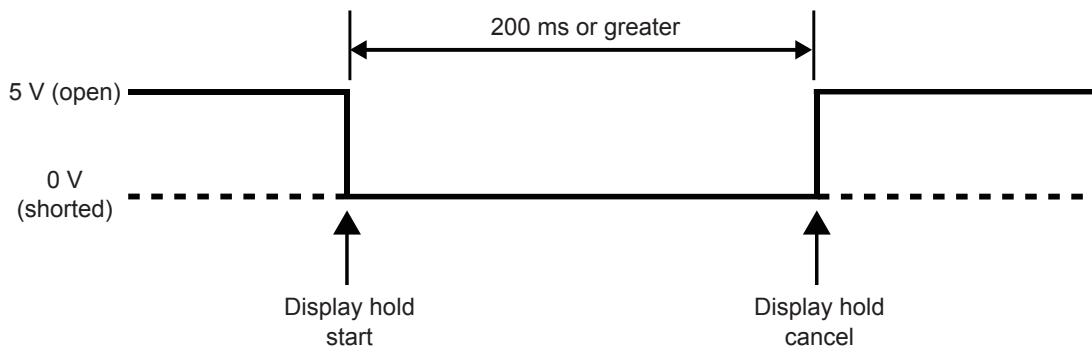

- To avoid instrument damage, do not input a signal at a voltage of 5.5 V or greater.
- Use chatter-free control signals.

## 8.5 Connecting an LR8410 Link-compatible Logger

The instrument can be connected via **Bluetooth®** to a Hioki LR8410 Link-compatible logger to allow measured values from the instrument for D/A output parameters to be observed using the LR8410 Link-compatible logger (maximum of 8 parameters from D/A13 to D/A20). You will need the connection cable and Bluetooth® serial conversion adapter listed below to connect the devices.

- Connection cable: Dedicated connection cable (available from Hioki on a special-order basis)
- Bluetooth® serial conversion adapter: The Parani\*-SD1000 is recommended (Bluetooth® class: Class 1)

\*: Trademark of another company

- To ensure safety, always turn off the instrument before connecting the logger. Turn the instrument on once you have connected the logger.
- Refer to the Parani-SD1000 precautions concerning use of Bluetooth®.
- Displayed values will reflect the resolution of the logger being used and may differ from values shown on the PW6001. To record values that are close to the PW6001's measured values, choose a range based on the input.

### Configuring the adapter and connecting the cable

- 1** Set the Bluetooth® serial conversion adapter's communications speed.  
Set the speed using the adapter's DIP switches.
- 2** Connect one end of the dedicated cable to the PW6001's D-sub 9-pin connector and the other end to the Bluetooth® serial conversion adapter.

### Configuring the instrument

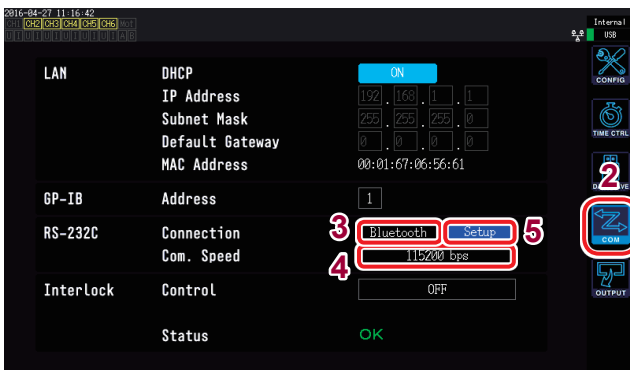

- For more information about how to configure a Hioki LR8410 Link-compatible logger such as the LR8410, see the logger's user manual.
- To order a dedicated connection cable, contact your authorized Hioki distributor or reseller.

- 1** Press the **[SYSTEM]** key.
- 2** Touch **COM**.
- 3** Touch **Connection** and select **Bluetooth**.
- 4** Select the **communications speed**.  
Select the same communications speed as set with the adapter's DIP switches.
- 5** Touch **Setup**.  
Initialize the adapter. (See table below.)  
Perform this step if connecting to the adapter for the first time.

Initial settings

<b>Device name</b>	PW6001#nnnnnnnn:HIOKI (where "n" indicates the 9-digit serial number)
<b>Operating mode</b>	Mode3 (Stand by for connections from all Bluetooth® devices)
<b>PIN code</b>	0000
<b>Response</b>	Not used
<b>Escape sequence characters</b>	Not allowed

# Connecting the Instrument to a Computer

The instrument ships standard with LAN, GP-IB, and RS-232C interfaces that can be used to connect the instrument to a computer and control it remotely, control the instrument using communications commands, or transfer measurement data to a computer.

## Operating precautions

Use only one of the three LAN, GP-IB, and RS-232C interfaces at any given time. Simultaneous use of multiple interfaces may cause the instrument to malfunction, for example by stopping communications.

## LAN connection functionality

- Use an Internet browser to control the instrument remotely.
- Control the instrument using communications commands (create a program and connect to the communications command port via TCP/IP to control the instrument).
- Control the instrument remotely using a dedicated application or transfer measurement data to a computer.

## GP-IB connection functionality

- Control the instrument using communications commands.
- Control the instrument remotely using a dedicated application or transfer measurement data to a computer.

## RS-232C connection functionality

- Control the instrument using communications commands.
- Control the instrument remotely using a dedicated application or transfer measurement data to a computer.
- Supply power to an RS-232C communications device that supports a 9-pin power supply (voltage of +5 V and maximum current of 200 mA).

A dedicated application (with instruction manual) and communications command instruction manual can be downloaded from our website.

## 9.1 Using the LAN Interface

The LAN interface can be used to control the instrument remotely via an Internet browser, to transfer measurement data to a computer with a dedicated application (PW Communicator), or to control the instrument with communications commands.

First, it is necessary to configure the LAN settings on the instrument, to build a network environment, and to connect the instrument to a computer with a LAN cable.

- For more information about how to use the dedicated application, see the instruction manual that comes with it.
- For more information about command communications, see the communications command instruction manual.
- Both resources can be downloaded from our website.

### Configuring LAN settings and building a network environment

#### Configuring LAN settings on the instrument

You must configure the LAN settings before connecting the instrument to a network. If you change the LAN settings while connected to a network, the instrument may have the same IP address as another device on the LAN, causing incorrect address information to be sent to the LAN.

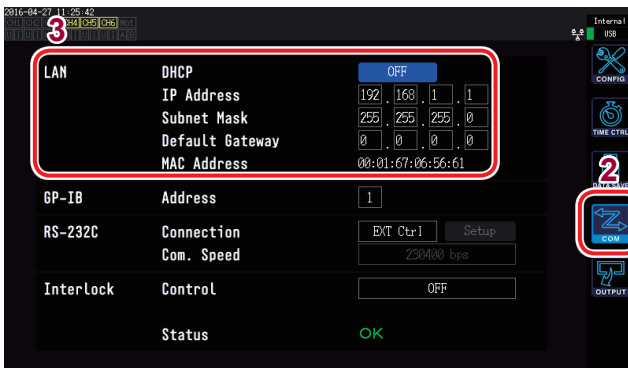

Restart the instrument after changing the network settings.

- 1 Press the **[SYSTEM]** key.
- 2 Touch **COM**.
- 3 Set **DHCP** to **ON** or **OFF**.  
(If DHCP is set to **OFF** only)
- 4 Touch the **IP Address** and enter the address with the numeric keypad.
- 5 Touch the **Subnet Mask** and enter the subnet mask with the numeric keypad.
- 6 Touch the **Default Gateway** and enter the default gateway with the numeric keypad.

## Description of settings

<b>DHCP</b> (Dynamic Host Configuration Protocol)	DHCP is a method by which devices can automatically acquire and configure themselves with an IP address and other information. When this DHCP function is enabled and there is a DHCP server operating on the same network, the instrument can automatically acquire and configure the IP address, subnet mask, and default gateway settings.
<b>IP address</b>	The IP address is used to identify individual devices that are connected to the network. Use a unique address that no other device on the network is using. The instrument uses IP version 4, and IP addresses are expressed as a series of four decimal numbers separated by periods, as in "192.168.0.1." If the DHCP setting is enabled, the IP address setting will be configured automatically using DHCP.
<b>Subnet mask</b>	The subnet mask is used to separate the IP address into the portion that indicates the network and the portion that indicates the device. The subnet mask typically consists of a series of four decimal numbers separated by periods, as in "255.255.255.0." If the DHCP setting is enabled, the subnet mask setting will be configured automatically using DHCP.
<b>Default gateway</b>	The default gateway specifies the IP address of the device that serves as the gateway when the computer with which you are communicating is on a different network than the instrument. When not using a gateway (for example, when using a one-to-one connection), set the instrument's gateway to "0.0.0.0." If the DHCP setting is enabled, the default gateway will be configured automatically using DHCP.

## Example network environment architectures

### Example 1: Connecting the instrument to an existing network

When connecting the instrument to an existing network, you must first have the network system administrator (department) allocate the following settings. Ensure that the instrument uses a unique address that is not being used by any other device on the network.

IP address	_____ . _____ . _____ . _____
Subnet mask	_____ . _____ . _____ . _____
Default gateway	_____ . _____ . _____ . _____

**When connecting a measuring instrument to an existing network** (provide one of the following)

- 1000Base-T compatible straight cable (commercially available cable, up to 100 m in length) (For 100Base or 10Base networking, you can also use a 100Base-TX or a 10Base-T cable.)
- 9642 LAN Cable with cross-conversion connector (optional)

### Example 2: Adding a LAN port to a computer that is connected to an existing network and connecting the instrument to the new port

Configure the IP address, subnet mask, and default gateway of the new LAN port after verifying the proper settings with your network system administrator.

### Example 3: Connecting one computer and multiple instruments using a hub

When creating a local network that is not connected externally, it is recommended to use private IP addresses such as those shown in the example.

When creating a network with a network address of 192.168.1.0/24

IP addresses	Computer: 192.168.1.1 Instruments: 192.168.1.2, 192.168.1.3, 192.168.1.4, etc. (progressing in order)
Subnet mask	255.255.255.0
Default gateway	0.0.0.0

**Example 4: Connecting one computer and one instrument with the 9642 LAN Cable**

When connecting one computer and one instrument with the conversion connector included with the 9642 LAN Cable, you may set the IP address as desired. However, it is recommended to use a private IP address.

IP addresses	Computer: 192.168.1.1 Instrument: 192.168.1.2 (Use a different value.)
Subnet mask	255.255.255.0
Default gateway	0.0.0.0

**When connecting one measuring instrument and one computer** (provide one of the following)

- 1000Base-T compatible cross cable (up to 100 m)
- 1000Base-T compatible straight cable and cross-conversion connector (up to 100 m)
- 9642 LAN Cable with cross-conversion connector (optional)

**Connecting the LAN cable**

This section describes how to connect the instrument and computer with a LAN cable.

**CAUTION**



When connecting the instrument to your LAN using a LAN cable of more than 30 m or with a cable laid outdoors, take appropriate countermeasures that include installing a surge protector for LANs. Such signal wiring is susceptible to induced lighting, which can cause damage to the instrument.

Rear

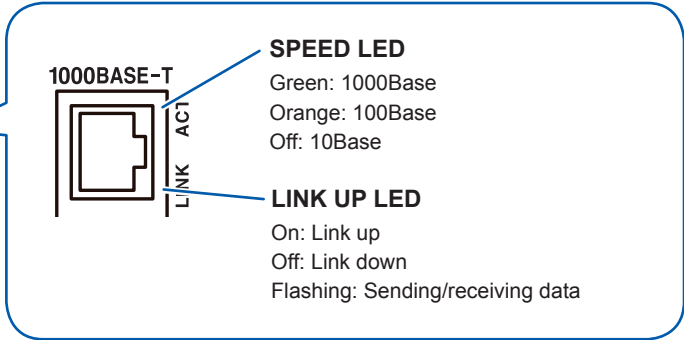
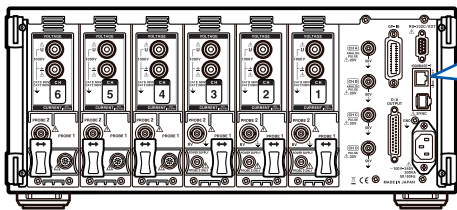

**Example connection: Connecting one instrument and one computer (connecting the instrument to a computer)**

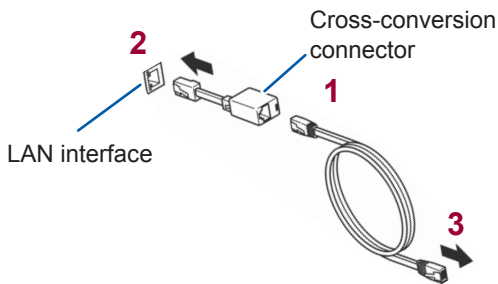

- 1** Connect the cross-conversion connector to the LAN cable.
- 2** Connect the cross-conversion connector to the instrument's LAN interface.
- 3** Connect the LAN cable to the computer's 100Base-TX connector.

When using a hub, the instrument can be connected without using a cross conversion connector.



## Controlling the instrument remotely with an Internet browser

The instrument includes a standard HTTP server function that enables it to be controlled remotely from an Internet browser running on a computer. The browser will display the instrument's screen and control panel, which is operated in the same manner as the actual instrument.

Attempting to control the instrument from multiple computers at the same time may result in unintended operation. Use a single computer to control the instrument.

### Connecting to the instrument

Launch Internet Explorer® and enter "http://" followed by the IP address with which the instrument has been configured into the browser's address bar. For example, you would enter the following if the instrument's IP address were 192.168.1.1:

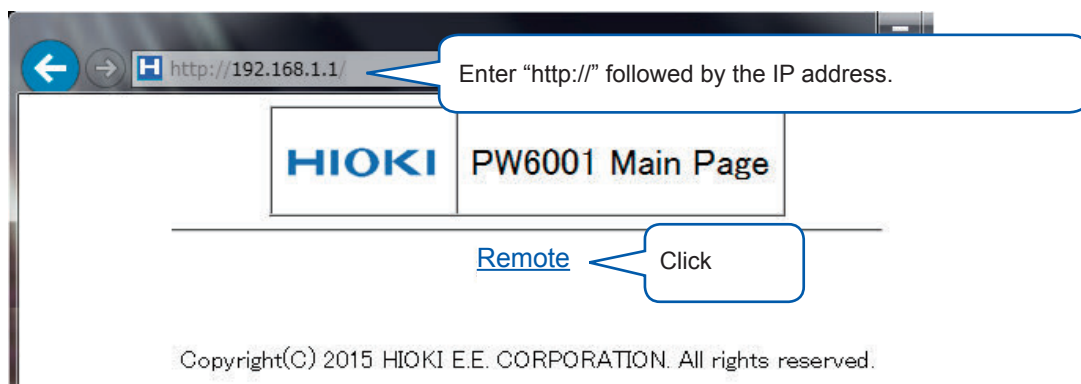

Display of the main page shown in the figure indicates that you have successfully connected to the instrument. Clicking the "**Remote**" link will open the remote operation page.

#### If the main page is not displayed

- Check the instrument's LAN settings and the computer's IP address. See "Configuring LAN settings and building a network environment"(p. 192).
- Verify that the LAN interface's LINK UP LED is on and that the LAN mark (  ) is shown on the instrument's screen. See "Connecting the LAN cable"(p. 194).

### How to control the instrument

The instrument's screen and control panel are shown as-is in the browser. Click a control key to perform the corresponding operation on the instrument. In addition, the display screen can be updated automatically by setting an update time under "Automatic update."

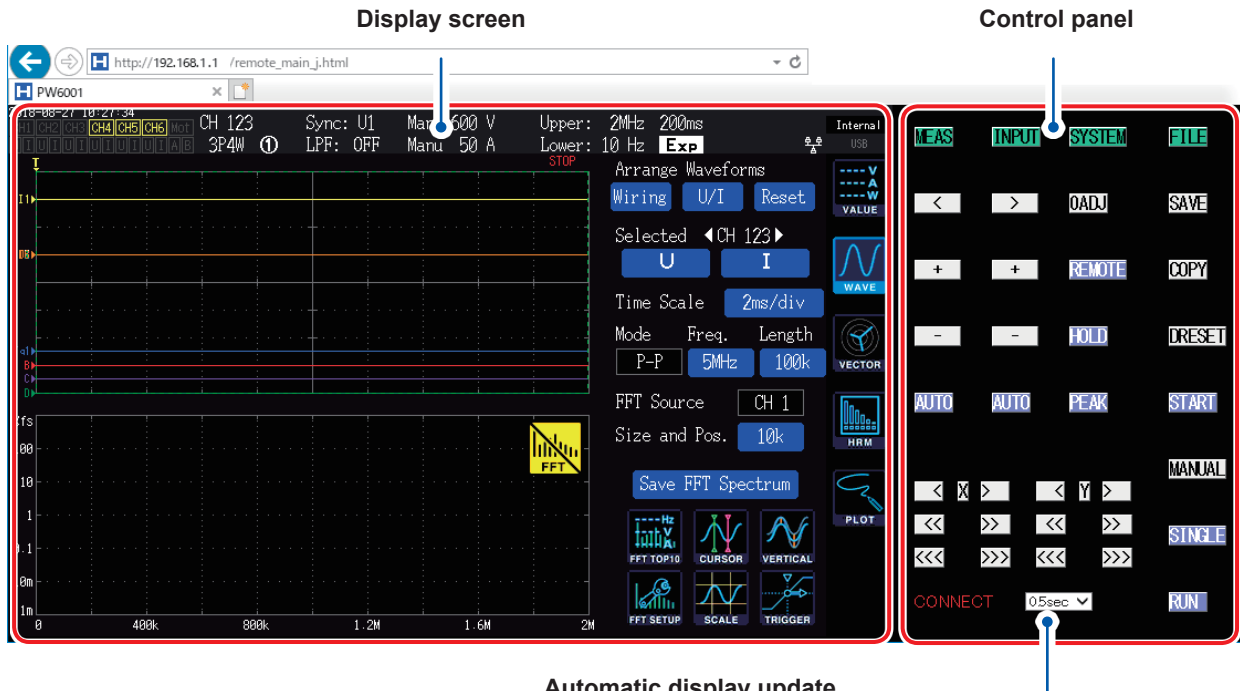

#### Automatic display update

The display screen will be updated at the set interval.  
Available settings: OFF, 0.5 sec., 1 sec., 2 sec., 5 sec., 10 sec.

This function may not operate properly if the browser is maximized or minimized. Set the browser zoom to 100% during use.

## 9.2 Performing Instrument File Operations from a Computer (Using FTP)

Using FTP client software on a computer, you can transfer files on the instrument's media to a computer and perform other file operations.

- The instrument has a built-in FTP (file transfer protocol, RFC959-compliant) server.
- The server can also be accessed from Internet Explorer® or shareware clients.

- The instrument's FTP server supports only one connection. It is not possible to access it simultaneously from multiple computers.
- The FTP connection may be disconnected if 1 minute or more passes without a command being sent after the connection is initiated. In this case, connect to the FTP server again.
- Disconnect the FTP connection before ejecting the CF card or USB flash drive.
- Do not perform file operations on the instrument while there is an active FTP connection.
- When accessing the FTP server from Internet Explorer®, file modified times and dates may not match those shown on the instrument.
- When accessing the FTP server from Internet Explorer®, the browser may acquire data from the previous session rather than the most recent data due to the presence of data from the previous session in the browser's Internet temporary files.

You must configure the instrument and connect it to a computer with a LAN cable in order to use the FTP feature.

See "9.1 Using the LAN Interface"(p. 192)

Some computer FTP clients and browsers delete all files and folders being moved if the move operation is canceled, regardless of whether the files and folders had been transferred or not. Exercise caution when using the move command. It is recommend to copy (download) the files and folders and then delete them.

### Things to check before using the FTP feature

Relationship of media types and directories	All media types are shown as directories in the FTP session. /USB ... USB flash drive
Constraints	Files cannot be accessed while measurement is in progress.

## Using FTP to connect to the instrument

This example explains how to connect to the instrument using Explorer in Windows 7. Launch your computer's browser and enter the following into the address bar:

Before the IP address, enter your username and password separated by a colon, then the "at" mark (@), and then the address.

[ftp://Username:Password@Instrument's IP address]

For the username "HIOKI" and the password (PW6001)

ftp://HIOKI:PW6001@192.168.0.2

If the instrument's address is 192.168.0.2:

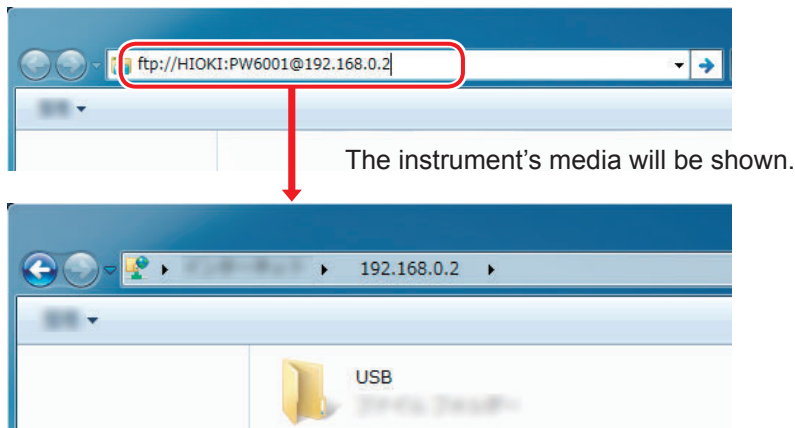

### If unable to connect

Check the instrument's communications settings.  
See "9.1 Using the LAN Interface"(p. 192)

## Performing file operations with FTP

### Downloading files

Select the file you wish to download from the list of folders and drag\* the file to the download destination (the desktop or a folder outside the Internet Explorer® window) with the mouse.

\*Click on the file and then move the mouse while holding down the mouse button. Release the button once you have moved the mouse cursor to the desired location.

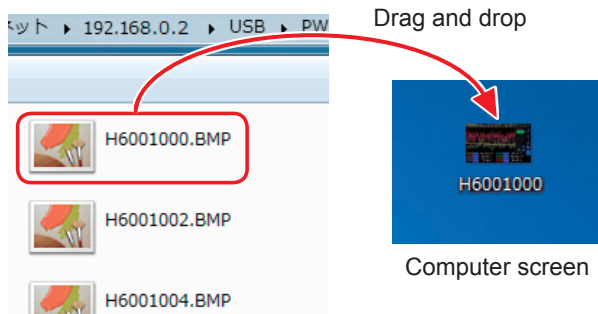

The seconds or hours, minutes, and seconds of the file's timestamp (time and date) may not reflect the actual time.

### Deleting files

Right-click the mouse on a file in the FTP folder list and select **[Delete]** from the context menu.

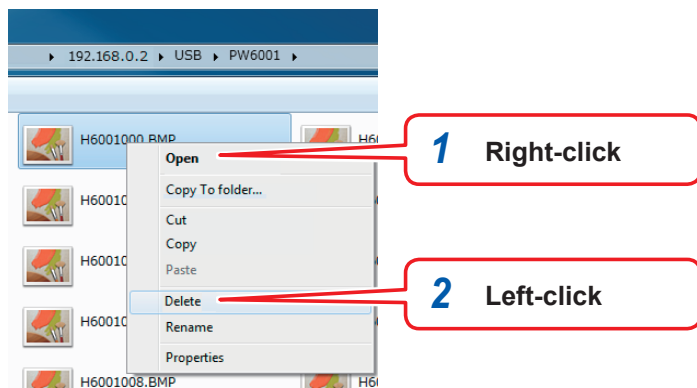

You cannot upload files from the computer to the instrument's media.

## 9.3 Using GP-IB

The instrument ships standard with a GP-IB interface. By connecting the instrument to a computer with a GP-IB cable, you can control the instrument's operation remotely and transfer measurement data to the computer.

### WARNING



- **Always turn both devices OFF when connecting and disconnecting an interface connector. Otherwise, an electric shock may occur.**
- **To avoid damage to the instrument, do not short-circuit the connector or input a voltage.**
- **Be sure to connect the cable to the target device's GP-IB connector. Connecting it to a different connector with different electrical specifications may result in electric shock or equipment damage.**

### CAUTION



- **Be sure to secure the cable's connectors in place with screws after connecting them. Failure to connect them securely may prevent the specifications from being satisfied, resulting in equipment damage.**

### About GP-IB

- IEEE-488-2 1987 common commands (required) may be used.
- The interface complies with the following reference standard: IEEE-488.1 1987<sup>\*1</sup>.
- The interface has been designed based on the following reference standard: IEEE-488.2 1987<sup>\*2</sup>.  
If the output queue fills up, a query error will result, and the output queue will be cleared. Consequently, the interface does not comply with the deadlocked state<sup>\*3</sup> defined in IEEE 488.2 in the clearing of the output queue and the outputting of query errors.

\*1 : ANSI/IEEE Standard 488.1-1987, IEEE Standard Digital Interface for Programmable Instrumentation

\*2 : ANSI/IEEE Standard 488.2-1987, IEEE Standard Codes, Formats, Protocols, and Common Commands

\*3 : Deadlocked state: State in which the input buffer and output queue are full, making continued processing impossible.

### Specifications

<b>SH1</b>	The interface supports all source handshake functions.
<b>AH1</b>	The interface supports all acceptor handshake functions.
<b>T6</b>	The interface supports basic talker functions. The interface supports serial poll functions. The interface does not support talk-only mode. The interface supports talker cancel functions using My Listen Address (MLA).
<b>L4</b>	The interface supports basic listener functions. The interface does not support listen-only mode. The interface supports listener cancel functions using My Talk Address (MTA).

<b>SR1</b>	The interface supports all service request functions.
<b>RL1</b>	The interface supports all remote-local functions.
<b>PP0</b>	The interface does not support parallel poll functions.
<b>DC1</b>	The interface supports all device clear functions.
<b>DT1</b>	The interface supports all device trigger functions.
<b>C0</b>	The interface does not support controller functions.

Character code: ASCII

## Connecting the GP-IB cable

Connect the GP-IB cable to the instrument's GP-IB connector.

Rear

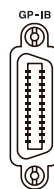
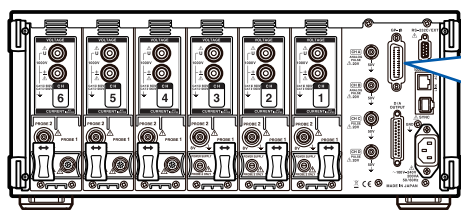

Recommended cable:  
9151-02 GP-IB Connection Cable (2 m)

## Setting the GP-IB address

Set the GP-IB address before using the GP-IB interface.

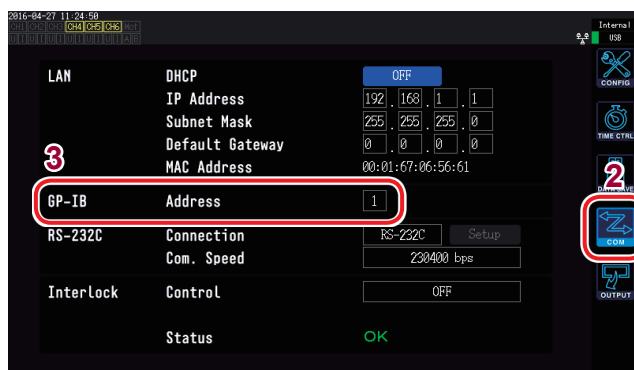

- 1 Press the **[SYSTEM]** key.
- 2 Touch **COM**.
- 3 Touch the **Address** setting and enter the address with the numeric keypad.  
Default value: 1  
Valid setting range: 0 to 30

## 9.4 Using RS-232C

By connecting the optional RS-232C cable to the instrument, you can control it with serial communications via the RS-232C interface from a computer or controller, and you can start and stop integration using a contact switch.

### WARNING



- **Always turn both devices OFF when connecting and disconnecting an interface connector. Otherwise, an electric shock may occur.**
- **To avoid damage to the instrument, do not short-circuit the connector or input a voltage.**
- **Be sure to connect the cable to the target device's RS-232C connector. Connecting it to a different connector with different electrical specifications may result in electric shock or equipment damage.**

### CAUTION



**Be sure to secure the cable's connectors in place with screws after connecting them. Failure to connect them securely may prevent the specifications from being satisfied, resulting in equipment damage.**

#### Operating precautions

Use only one of the three LAN, GP-IB, and RS-232C interfaces at any given time. Simultaneous use of multiple interfaces may cause the instrument to malfunction, for example by stopping communications.

## Specifications

<b>Communications method</b>	Full duplex, asynchronous											
<b>Communications speed</b>	9,600 bps / 19,200 bps / 38,400 bps / 57,600 bps / 115,200 bps / 230,400 bps											
<b>Data length</b>	8 bits											
<b>Parity</b>	None											
<b>Stop bits</b>	1											
<b>Message terminator</b>	When receiving: CR+LF When sending: CR+LF											
<b>Flow control</b>	None											
<b>Electrical specifications</b>	<table border="1"> <tr> <td rowspan="2">Input voltage level</td> <td>5 to 15 V</td> <td>ON</td> </tr> <tr> <td>-15 to -5 V</td> <td>OFF</td> </tr> <tr> <td rowspan="2">Output voltage level</td> <td>+5 V or greater</td> <td>ON</td> </tr> <tr> <td>-5 V or less</td> <td>OFF</td> </tr> </table>		Input voltage level	5 to 15 V	ON	-15 to -5 V	OFF	Output voltage level	+5 V or greater	ON	-5 V or less	OFF
Input voltage level	5 to 15 V	ON										
	-15 to -5 V	OFF										
Output voltage level	+5 V or greater	ON										
	-5 V or less	OFF										
<b>Connector</b>	Interface connector pin assignments (9-pin male D-sub with #4-40 locking screws) The input and output connector implements terminal (DTE) specifications. Recommended cable: 9637 RS-232C Cable (computer use) See "Connecting the RS-232C cable"(p.204). Note: When using a USB-serial converter to connect the instrument to a computer, you must use a gender changer (male/female conversion) and a straight-cross converter.											

Character code: ASCII



## Configuring the D-sub 9-pin connector

The instrument's D-sub 9-pin connector can be switched between RS-232C interface and external control interface modes.

### ⚠ CAUTION



- When connecting the instrument to a device that does not support power supply using the No. 9 pin, do not enable the **Bluetooth®** setting. Doing so may damage the connected device.
- Since the optional 9637 RS-232C Cable does not connect the No. 9 pins, it is not possible to supply power through that cable.
- Up to 200 mA of power may be supplied.

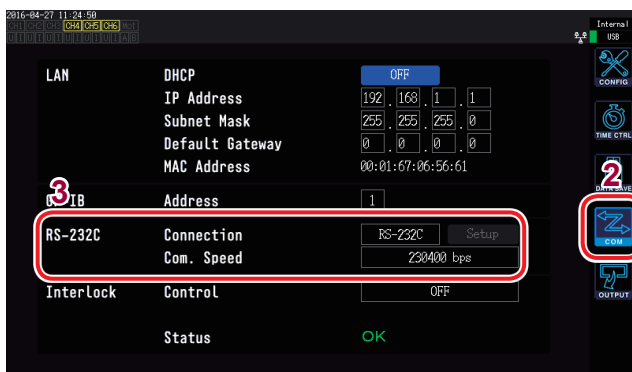

- 1 Press the **[SYSTEM]** key.
- 2 Touch **COM**.
- 3 Touch the **Connection** setting and set as desired.

Connection	Description	Supplemental information
<b>RS-232C</b>	Functions as the RS-232C interface.	Connect the instrument to an external device to control the instrument using communications commands.
<b>Bluetooth®</b>	Functions as the RS-232C interface. The connector's No. 9 pin will supply 5 V of power, which can be used to drive the Bluetooth®- RS-232C conversion adapter.	Connect the instrument to an external device using Bluetooth® to control the instrument using communications commands.
<b>EXT Ctrl</b>	Functions as the external control interface. The connector's No. 9 pin will supply 5 V of power.	Connect the instrument to an external device to control the instrument using logic signals or short/open contact signals. See "8.4 Controlling Integration with External Signals"(p. 187).

- 4 Select the **Com. Speed** (communications speed) from the following available settings:  
**9,600 bps / 19,200 bps / 38,400 bps / 57,600 bps / 115,200 bps / 230,400 bps**

## Connecting the RS-232C cable

Recommended cable: 9637 RS-232C Cable (1.8 m, 9-pin to 9-pin, cross cable)

Rear

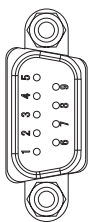
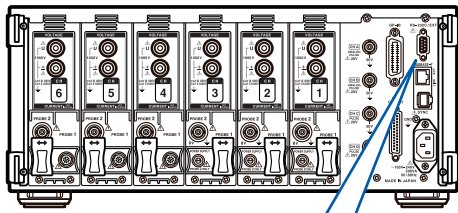

D-sub 9-pin male  
Locking screws: #4-40

### 1 Connect the RS-232C cable to the instrument's D-sub 9-pin connector.

Be sure to secure the connector with screws.

### 2 Set the controller's communications protocol to match the instrument's settings.

Be sure to configure the controller as follows:

- Asynchronous communications
- Communications speed: 9,600 bps / 19,200 bps / 38,400 bps / 57,600 bps / 115,200 bps / 230,400 bps (Use the same setting as the instrument.)
- Stop bits: 1
- Data length: 8 bits
- Parity check: None
- Flow control: None

- If connecting to a controller (DTE), provide a cross cable that satisfies the specifications of the instrument's connector and the controller's connector.
- Be sure to configure the controller's communications protocol settings to match the instrument's settings (p. 193).
- When using a USB-serial cable, you may need a gender changer or a straight-cross converter. Choose parts that satisfy the specifications of the instrument's connector and the USB-serial cable's connector.

The input and output connector implements terminal (DTE) specifications.  
The instrument uses pin numbers 2, 3, 5, 7, and 8. Other pins are unused.

Pin number	Interchange circuit name		CCIT circuit number	EIA abbreviation	JIS abbreviation	Common abbreviation
1	Data channel receive carrier detect	Carrier Detect	109	CF	CD	DCD
2	Receive data	Receive Data	104	BB	RD	RxD
3	Send data	Send Data	103	BA	SD	TxD
4	Data terminal ready	Data Terminal Ready	108/2	CD	ER	DTR
5	Signal ground	Signal Ground	102	AB	SG	GND
6	Data set ready	DATA Set Ready	107	CC	DR	DSR
7	Request to send	Request to Send	105	CA	RS	RTS
8	Clear to send	Clear to Send	106	CB	CS	CTS
9	Ring indicator	Ring Indicator	125	CE	CI	RI

## Connecting the instrument to a computer

Use a D-sub 9-pin female to D-sub 9-pin female cross cable.

Recommended cable: 9637 RS-232C Cable (1.8 m, 9-9 pin, cross cable)

### Cross wiring

D-sub 9-pin female  
PW6001 side

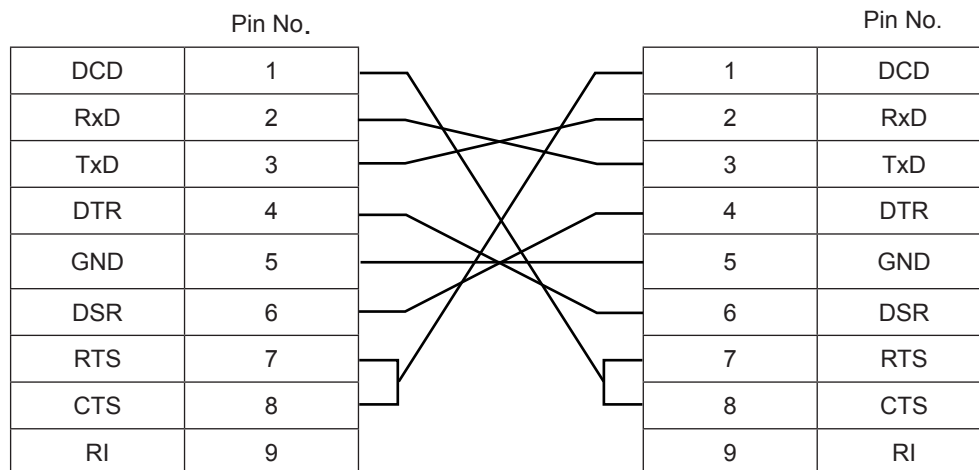

D-sub 9-pin female  
Computer (AT compatible) side



## 9.5 Canceling the Remote State (Reverting to the Local State)

During GP-IB communications, the instrument will enter the remote state (remote control state), and the **[REMOTE/LOCAL]** key will light up. In this state, keys other than the **[REMOTE/LOCAL]** key cannot be used.

When in the GP-IB local lockout state (triggered by the GP-IB LLO [Local Lock Out] command), the **[REMOTE/LOCAL]** key cannot be used, either. In this case, either execute the interface function GTL command (GP-IB command GTL: Go To Local) or cycle the instrument's power to revert to the local state.

Key status		Description
	Lit up	Remote state (remote control state) Keys other than the <b>[REMOTE/LOCAL]</b> key cannot be used.
	Off	Key operation is enabled.

### Canceling the remote state

Press the **[REMOTE/LOCAL]** key (which will be lit up).

Key operation will be enabled, and the **[REMOTE/LOCAL]** key light will turn off.



# 10 Specifications

## 10.1 General Specifications

### Environmental and safety specifications

<b>Operating environment</b>	Indoors, Pollution Degree 2, altitude up to 2000 m (6562 ft.)
<b>Storage temperature and humidity</b>	Temperature; –10°C to 50°C (14.0°F to 122.0°F) Humidity; 80% RH or less (non-condensing)
<b>Operating temperature and humidity</b>	Temperature; 0°C to 40°C (32.0°F to 104.0°F) Humidity; 80% RH or less (non-condensing)
<b>Dielectric strength</b>	50 Hz/60 Hz 5.4 kV AC rms for 1 min. (sensed current of 1 mA) Between voltage input terminals and instrument enclosure, and between current sensor input terminals and interfaces 1 kV AC rms for 1 min. (sensed current of 3 mA) Between motor input terminals (CH. A, CH. B, CH. C, and CH. D) and the instrument enclosure
<b>Standards</b>	Safety EN61010 EMC EN61326 Class A
<b>Rated supply voltage</b>	100 V to 240 V AC (Voltage fluctuations of ±10% from the rated supply voltage are taken into account.) Expected transient overvoltage: 2500 V
<b>Rated supply frequency</b>	50 Hz/60 Hz
<b>Maximum rated power</b>	200 VA
<b>Dimensions</b>	Approx. 430W × 177H × 450D mm (16.93" W × 6.97" H × 17.72" D) (excluding protruding parts)
<b>Mass</b>	Approx. 14.0 kg (498.3 oz.) (for PW6001-16)
<b>Backup battery life</b>	Approx. 10 years (reference value at 23°C) (lithium battery that stores time and setting conditions)
<b>Product warranty period</b>	3 years
<b>Guaranteed accuracy period</b>	6 months (1-year accuracy = 6-month accuracy × 1.5)
<b>Accuracy guarantee conditions</b>	Accuracy guarantee temperature and humidity: 23°C ±3°C (73.4°F ±5.1°F), 80% RH or less Warm-up time: 30 min. or more
<b>Accessories</b>	See "Verifying Package Contents" (p.7).
<b>Options</b>	See "Options" (p.8).

## 10.2 Basic Specifications

### Power measurement input specifications

**Measurement lines** 1-phase/2-wire (1P2W), 1-phase/3-wire (1P3W), 3-phase/3-wire (3P3W2M, 3V3A, 3P3W3M), 3-phase/4-wire (3P4W)

	CH1	CH2	CH3	CH4	CH5	CH6
Pattern 1	1P2W	1P2W	1P2W	1P2W	1P2W	1P2W
Pattern 2	1P3W / 3P3W2M		1P2W	1P2W	1P2W	1P2W
Pattern 3	1P3W / 3P3W2M		1P2W	1P3W / 3P3W2M		1P2W
Pattern 4	1P3W / 3P3W2M		1P3W / 3P3W2M		1P3W / 3P3W2M	
Pattern 5	3P3W3M / 3V3A / 3P4W			1P2W	1P2W	1P2W
Pattern 6	3P3W3M / 3V3A / 3P4W			1P3W / 3P3W2M		1P2W
Pattern 7	3P3W3M / 3V3A / 3P4W			3P3W3M / 3V3A / 3P4W		

For 2-channel combinations, select 1P3W or 3P3W2M.

For 3-channel combinations, select 3P3W3M, 3V3A, or 3P4W.

Number of channels	1	2	3	4	5	6
Pattern 1	✓	✓	✓	✓	✓	✓
Pattern 2	–	✓	✓	✓	✓	✓
Pattern 3	–	–	–	–	–	✓
Pattern 4	–	–	–	✓	–	✓
Pattern 5	–	–	✓	✓	✓	✓
Pattern 6	–	–	–	–	✓	✓
Pattern 7	–	–	–	–	–	✓

Connection patterns that can be selected based on the number of channels: [✓] Can be selected, [–] Cannot be selected

For 2- or 3-channel combinations, the same current sensor can only be selected for each combination.

<b>Number of input channels</b>	Max. 6 channels in units of 1 channel with simultaneous voltage/current input	
<b>Input terminal type</b>	Voltage and current terminals for each channel; two types (Probe 1 and Probe 2) of terminals for current Voltage Plug-in terminals (safety terminals) Probe 1 Dedicated connector (ME15W) Probe 2 BNC (metal) + power supply terminal Either Probe 1 or Probe 2 can be used for current.	
<b>Probe 2 power supply</b>	+12 V ±0.5 V, -12 V ±0.5 V, max. 600 mA, up to a max. of 700 mA for up to 3 channels	
<b>Input method</b>	Voltage measurement unit	Photoisolated input, resistance voltage divider
	Current measurement unit	Isolated input from current sensor (voltage output)
<b>Voltage range</b>	Select from following for each connection: 6 V / 15 V / 30 V / 60 V / 150 V / 300 V / 600 V / 1500 V	

<b>Current range</b>	<p>Probe 1: Sensor rating is detected automatically.</p> <p>400 mA / 800 mA / 2 A / 4 A / 8 A / 20 A (with 20 A sensor)  4 A / 8 A / 20 A / 40 A / 80 A / 200 A (with 200 A sensor)  1 A / 2 A / 5 A / 10 A / 20 A / 50 A (with 50 A sensor)  10 A / 20 A / 50 A / 100 A / 200 A / 500 A (with 500 A sensor)  20 A / 40 A / 100 A / 200 A / 400 A / 1 kA (with 1000 A sensor)  40 A / 80 A / 200 A / 400 A / 800 A / 2 kA (with 2000 A sensor)</p> <p>The current range can be selected for each connection (however, only when the same sensor is being used for all channels of the same connection).</p> <hr/> <p>Probe 2: Sensor input rate is set by the user.</p> <p>1 kA / 2 kA / 5 kA / 10 kA / 20 kA / 50 kA (with 0.1 mV/A sensor)  100 A / 200 A / 500 A / 1 kA / 2 kA / 5 kA (with 1 mV/A sensor)  10 A / 20 A / 50 A / 100 A / 200 A / 500 A (with 10 mV/A sensor; with 3274 or 3275)  1 A / 2 A / 5 A / 10 A / 20 A / 50 A (with 100 mV/A sensor; with 3273 or 3276)  100 mA / 200 mA / 500 mA / 1 A / 2 A / 5 A (with 1 V/A sensor; with CT6700 or CT6701)  (0.1 V / 0.2 V / 0.5 V / 1.0 V / 2.0 V / 5.0 V range)</p>	
<b>Crest factor</b>	<p>3 (relative to voltage/current range rating); however, 1.33 for 1500 V range, 1.5 for 5 V Probe 2 range  300 (relative to minimum valid voltage and current input); however, 133 for 1500 V range, 150 for 5 V Probe 2 range</p>	
<b>Input resistance (50 Hz / 60 Hz)</b>	<p>Voltage inputs 4 MΩ ±40 kΩ  Probe 1 inputs 1 MΩ ±50 kΩ  Probe 2 inputs 1 MΩ ±50 kΩ</p>	<p>Input capacitance: 5 pF typical (defined at 100 kHz)</p>
<b>Maximum input voltage</b>	<p>Voltage inputs 1000 V, ±2000 V peak (10 ms or less)  Input voltage frequency of 250 kHz to 1 MHz, (1250 - f) V  Input voltage frequency of 1 MHz to 5 MHz, 50 V  Unit for f above: kHz</p> <p>Probe 1 inputs 5 V, ±12 V<sub>peak</sub> (10 ms or less)  Probe 2 inputs 8 V, ±15 V<sub>peak</sub> (10 ms or less)</p>	
<b>Maximum rated voltage to earth</b>	<p>Voltage input terminal (50 Hz/60 Hz)  600 V measurement Cat III expected transient overvoltage: 6000 V  1000 V measurement Cat II expected transient voltage: 6000 V</p>	
<b>Measurement method</b>	Voltage/current simultaneous digital sampling with zero-cross synchronized calculation	
<b>Sampling</b>	5 MHz / 18 bits	
<b>Frequency band</b>	DC, 0.1 Hz to 2 MHz	
<b>Synchronization frequency range</b>	0.1 Hz to 2 MHz	
<b>Measurement lower limit frequency</b>	<p>Select from the following frequencies for each connection:  0.1 Hz / 1 Hz / 10 Hz / 100 Hz / 1 kHz / 10 kHz / 100 kHz</p>	
<b>Measurement upper limit frequency</b>	<p>Select from the following frequencies for each connection:  100 Hz / 500 Hz / 1 kHz / 5 kHz / 10 kHz / 50 kHz / 100 kHz / 500 kHz / 2 MHz</p>	
<b>Synchronization source</b>	<p>U1 to U6, I1 to I6, DC (fixed at data update rate),  Ext1 to Ext2 (in a mode other than independent input for a motor analysis and D/A-equipped model when RPM is set to pulse input and the remainder of [pulse count / {pole count / 2}] is 0), Zph. (when using a motor analysis-equipped model in Single mode with Origin input to CH D), CH C to CH D (when using a motor analysis-equipped model in independent input mode)</p> <p>Can be selected for each connection (U and I for the same channel are measured using the same synchronization source.)  The zero-cross point of the waveform after passing through the zero-cross filter is used as the standard for U or I selection.</p>	

<b>Zero-cross filter</b>	Used in zero-cross detection for voltage and current waveforms. Does not affect measured waveforms. Consists of digital LPF and HPF filters. Cutoff frequencies are determined automatically based on the upper and lower limit frequency settings and measurement frequency.
<b>Data update rate</b>	10 ms / 50 ms / 200 ms When using simple averaging, the data update rate varies based on the number of averaging iterations.
<b>LPF</b>	500 Hz / 1 kHz / 5 kHz / 10 kHz / 50 kHz / 100 kHz / 500 kHz / OFF Approx. 500 kHz analog LPF + digital IIR filter (Butterworth characteristics equivalent) Except when off, add $\pm 0.1\%$ rdg. to the accuracy. Defined for frequencies that are less than or equal to 1/10 of the set frequency. The post-LPF value is used for the peak value, and over-peak judgments are made using pre-digital LPF values.
<b>Polarity detection</b>	Current and voltage zero-cross timing comparison
<b>Measurement parameters</b>	Voltage (U), current (I), active power (P), apparent power (S), reactive power (Q), power factor ( $\lambda$ ), phase angle ( $\phi$ ), frequency (f), efficiency ( $\eta$ ), loss (Loss), voltage ripple factor (Urf), current ripple factor (Irf), current integration (Ih), power integration (WP), voltage peak (Upk), current peak (Ipk)
<b>Accuracy</b>	Sine wave input with a power factor of 1 or DC input, terminal-to-ground voltage of 0 V, after zero-adjustment Within the effective measurement range

	Voltage (U)	Current (I)
DC	$\pm 0.02\%$ rdg. $\pm 0.03\%$ f.s.	$\pm 0.02\%$ rdg. $\pm 0.03\%$ f.s.
0.1 Hz $\leq$ f < 30 Hz	$\pm 0.1\%$ rdg. $\pm 0.2\%$ f.s.	$\pm 0.1\%$ rdg. $\pm 0.2\%$ f.s.
30 Hz $\leq$ f < 45 Hz	$\pm 0.03\%$ rdg. $\pm 0.05\%$ f.s.	$\pm 0.03\%$ rdg. $\pm 0.05\%$ f.s.
45 Hz $\leq$ f $\leq$ 66 Hz	$\pm 0.02\%$ rdg. $\pm 0.02\%$ f.s.	$\pm 0.02\%$ rdg. $\pm 0.02\%$ f.s.
66 Hz < f $\leq$ 1 kHz	$\pm 0.03\%$ rdg. $\pm 0.04\%$ f.s.	$\pm 0.03\%$ rdg. $\pm 0.04\%$ f.s.
1 kHz < f $\leq$ 50 kHz	$\pm 0.1\%$ rdg. $\pm 0.05\%$ f.s.	$\pm 0.1\%$ rdg. $\pm 0.05\%$ f.s.
50 kHz < f $\leq$ 100 kHz	$\pm 0.01 \times f\%$ rdg. $\pm 0.2\%$ f.s.	$\pm 0.01 \times f\%$ rdg. $\pm 0.2\%$ f.s.
100 kHz < f $\leq$ 500 kHz	$\pm 0.008 \times f\%$ rdg. $\pm 0.5\%$ f.s.	$\pm 0.008 \times f\%$ rdg. $\pm 0.5\%$ f.s.
500 kHz < f $\leq$ 1 MHz	$\pm (0.021 \times f - 7)\%$ rdg. $\pm 1\%$ f.s.	$\pm (0.021 \times f - 7)\%$ rdg. $\pm 1\%$ f.s.
Frequency band	2 MHz (-3 dB, typical)	2 MHz (-3 dB, typical)

	Active power (P)	Phase difference
DC	$\pm 0.02\%$ rdg. $\pm 0.05\%$ f.s.	-
0.1 Hz $\leq$ f < 30 Hz	$\pm 0.1\%$ rdg. $\pm 0.2\%$ f.s.	$\pm 0.1^\circ$
30 Hz $\leq$ f < 45 Hz	$\pm 0.03\%$ rdg. $\pm 0.05\%$ f.s.	$\pm 0.05^\circ$
45 Hz $\leq$ f $\leq$ 66 Hz	$\pm 0.02\%$ rdg. $\pm 0.03\%$ f.s.	$\pm 0.05^\circ$
66 Hz < f $\leq$ 1 kHz	$\pm 0.04\%$ rdg. $\pm 0.05\%$ f.s.	$\pm 0.05^\circ$
1 kHz < f $\leq$ 10 kHz	$\pm 0.15\%$ rdg. $\pm 0.1\%$ f.s.	$\pm 0.4^\circ$
10 kHz < f $\leq$ 50 kHz	$\pm 0.15\%$ rdg. $\pm 0.1\%$ f.s.	$\pm (0.040 \times f)^\circ$
50 kHz < f $\leq$ 100 kHz	$\pm 0.012 \times f\%$ rdg. $\pm 0.2\%$ f.s.	$\pm (0.050 \times f)^\circ$
100 kHz < f $\leq$ 500 kHz	$\pm 0.009 \times f\%$ rdg. $\pm 0.5\%$ f.s.	$\pm (0.055 \times f)^\circ \pm 0.7^\circ$
500 kHz < f $\leq$ 1 MHz	$\pm (0.047 \times f - 19)\%$ rdg. $\pm 2\%$ f.s.	$\pm (0.055 \times f)^\circ \pm 0.7^\circ$



- Unit for f in the formulas in the above table: kHz
- Voltage and current DC values are defined for U<sub>dc</sub> and I<sub>dc</sub>, while frequencies other than DC are defined for U<sub>rms</sub> and I<sub>rms</sub>.
- When U or I is selected as the synchronization source, accuracy is defined for source input of at least 5% f.s.
- The phase difference is defined for a power factor of zero during f.s. input.
- The current sensor accuracy must be added to the above accuracy figures for current, active power, and phase difference.
- For the 6 V range, add ±0.05% f.s. for voltage and active power.
- Add ±20 μV to the DC accuracy for current and active power when using Probe 1 (however, 2 V f.s.).
- Add ±0.05% rdg. ±0.2% f.s. for current and active power when using Probe 2, and add ±0.2° to the phase at or above 10 kHz.
- The accuracy figures for voltage, current, active power, and phase difference for 0.1 Hz to 10 Hz are reference values.
- The accuracy figures for voltage, active power, and phase difference in excess of 220 V from 10 Hz to 16 Hz are reference values.
- The accuracy figures for voltage, active power, and phase difference in excess of 750 V for values of f such that 30 kHz < f ≤ 100 kHz are reference values.
- The accuracy figures for voltage, active power, and phase difference in excess of (22000/f [kHz]) V for values of f such that 100 kHz < f ≤ 1 MHz are reference values.
- Add ±0.02% rdg. for voltage and active power at or above 1000 V (however, figures are reference values).  
Even for input voltages that are less than 1000 V, the effect will persist until the input resistance temperature falls.
- For voltages in excess of 600 V, add the following to the phase difference accuracy:
  - 500 Hz < f ≤ 5 kHz: ±0.3°
  - 5 kHz < f ≤ 20 kHz: ±0.5°
  - 20 kHz < f ≤ 200 kHz: ±1°

Measurement parameter	Accuracy
Apparent power	Voltage accuracy + current accuracy ±10 dgt.
Reactive power	Apparent power accuracy + $\left(\sqrt{2.69 \times 10^{-4} \times f + 1.0022 - \lambda^2} - \sqrt{1 - \lambda^2}\right) \times 100\% \text{ f.s.}$
Power factor	$\phi$ of other than ±90°: $\pm \left[ 1 - \frac{\cos(\phi + \text{phase difference accuracy})}{\cos(\phi)} \right] \times 100\% \text{ rdg. } \pm 50 \text{ dgt.}$ $\phi$ of ±90°: ±cos (ϕ + phase difference accuracy) × 100% f.s. ±50 dgt.
Waveform peak	Voltage/current RMS accuracy ±1% f.s. (f.s.: apply 300% of range)

f: kHz; ϕ: Display value for voltage/current phase difference; λ: Display value for power factor

<b>Effects of temperature and humidity</b>	Add the following to the voltage, current, and active power accuracy within the range of 0°C to 20°C or 26°C to 40°C: ±0.01% rdg./°C (add 0.01% f.s./°C for DC measured values) For current and active power when using Probe 2, ±0.02% rdg./°C (add 0.05% f.s./°C for DC measured values) Under conditions of 60% RH or greater: Add ±0.0006 × humidity [%RH] × f [kHz]% rdg. to the voltage and active power accuracy. Add ±0.0006 × humidity [%RH] × f [kHz]° for the phase difference.	
<b>Effects of common-mode voltage</b>	50 Hz/60 Hz	100 dB or greater (when applied between the voltage input terminals and the enclosure)
	100 kHz	80 dB or greater (reference value)
	Defined for CMRR when the maximum input voltage is applied for all measurement ranges.	
<b>Effects of external magnetic fields</b>	±1% f.s. or less (in a magnetic field of 400 A/m, DC or 50 Hz/60 Hz)	

<b>Effects of power factor</b>	$\phi$ of other than $\pm 90^\circ$ : $\pm \left[ 1 - \frac{\cos(\phi + \text{phase difference accuracy})}{\cos(\phi)} \right] \times 100\% \text{ rdg.}$ $\phi$ of $\pm 90^\circ$ : $\pm \cos(\phi + \text{phase difference accuracy}) \times 100\% \text{ f.s.}$
<b>Effective measurement range</b>	Voltage, current, power: 1% to 110% of range
<b>Zero-suppression range</b>	Select from OFF / 0.1% f.s. / 0.5% f.s. When set to OFF, a value may be displayed even when receiving zero input.
<b>Zero-adjustment</b>	Zero-adjustment of input offsets that are less than or equal to $\pm 10\%$ f.s. for voltage and $\pm 10\%$ f.s. $\pm 4$ mV for current

## Frequency measurement specifications

<b>Number of measurement channels</b>	Max. 6 channels (f1 to f6), based on the number of input channels
<b>Measurement source</b>	Select from U/I for each connection.
<b>Measurement method</b>	Reciprocal method + zero-cross sampling value compensation Calculated from the zero-cross point of waveforms after application of the zero-cross filter.
<b>Measurement range</b>	0.1 Hz to 2 MHz (Display shows 0.00000 Hz or ----- Hz if measurement is not possible.) However, the range is limited by the measurement lower limit frequency setting.
<b>Data update rate</b>	Tracks the data update rate for the power measurement input specifications.
<b>Accuracy</b>	$\pm 0.01$ Hz (while measuring a frequency of 45 Hz to 66 Hz during voltage frequency measurement with a measurement interval of at least 50 ms and sine wave input with a magnitude of at least 50% of the voltage measurement range only) Other conditions: $\pm 0.05\%$ rdg. $\pm 1$ dgt. (with a sine wave that is at least 30% of the measurement source's measurement range)
<b>Display format</b>	0.10000 Hz to 9.99999 Hz, 9.9000 Hz to 99.9999 Hz, 99.000 Hz to 999.999 Hz, 0.99000 kHz to 9.99999 kHz, 9.9000 kHz to 99.9999 kHz, 99.000 kHz to 999.999 kHz, 0.99000 MHz to 2.00000 MHz

## Integration measurement specifications

<b>Measurement modes</b>	Select RMS or DC for each connection (DC mode can only be selected when using an AC/DC sensor with a 1P2W connection).
<b>Measurement parameters</b>	Current integration (Ih+, Ih-, Ih), active power integration (WP+, WP-, WP) Ih+ and Ih- are measured only in DC mode. Only Ih is measured in RMS mode.
<b>Measurement method</b>	Digital calculation based on current and active power values (during averaging, calculations are performed using pre-averaging values).  DC mode      Every sampling interval, current values and instantaneous power values are integrated separately for each polarity. RMS mode      The current RMS value and active power value are integrated for each measurement interval. Only active power is integrated separately for each polarity. (Active power values are integrated separately for each polarity at each synchronization source period.)
<b>Measurement interval</b>	As per data update rate setting
<b>Display resolution</b>	999999 (6 digits + decimal point), starting from the resolution at which 1% of each range is f.s.
<b>Measurement range</b>	0 to $\pm 9999.99$ TAh/TWh Integration will stop if any integration value exceeds the range.

<b>Integration time</b>	10 sec. to 9999 hr. 59 min. 59 sec. Integration will stop if the integration time exceeds the range.
<b>Integration time accuracy</b>	$\pm 0.02\%$ rdg. (0°C to 40°C)
<b>Integration accuracy</b>	$\pm(\text{current or active power accuracy}) \pm \text{integration time accuracy}$
<b>Backup function</b>	None If a power outage occurs while integration is being performed, integration will stop after power is restored, and integration data will be reset.
<b>Integration control</b>	<ul style="list-style-type: none"> <li>• Start, stop, and data reset by means of keys, communications commands, and external control</li> <li>• Start and stop by means of actual time</li> <li>• Timer-based stop after a certain amount of time elapses</li> <li>• Synchronized control and cumulative integration for all channels</li> </ul>

## Harmonic measurement specifications

<b>Number of measurement channels</b>	Max. 6 channels, based on the number of input channels
<b>Synchronization source</b>	Based on the synchronization source setting for each connection.
<b>Measurement modes</b>	Select from IEC standard mode or wideband mode (setting applies to all channels).
<b>Measurement parameters</b>	Harmonic voltage RMS value, harmonic voltage content percentage, harmonic voltage phase angle, harmonic current RMS value, harmonic current content percentage, harmonic current phase angle, harmonic active power, harmonic power content percentage, harmonic voltage/current phase difference, total harmonic voltage distortion, total harmonic current distortion, voltage unbalance rate, current unbalance rate (no intermediate harmonic parameters in IEC standard mode)
<b>FFT processing word length</b>	32 bits
<b>Antialiasing</b>	Digital filter (automatically configured based on synchronization frequency)
<b>Window function</b>	Rectangular
<b>Grouping</b>	OFF / Type 1 (harmonic sub-group) / Type 2 (harmonic group)
<b>THD calculation method</b>	THD_F / THD_R (Setting applies to all connections.) Select calculation order from 2nd order to 100th order (however, limited to the maximum analysis order for each mode).

**(1) IEC standard mode**

<b>Measurement method</b>	Zero-cross synchronization calculation method (same window for each synchronization source) Fixed sampling interpolation calculation method with average thinning in window IEC 61000-4-7:2002 compliant with gap overlap
<b>Synchronization frequency range</b>	45 Hz to 66 Hz (Does not operate when the synchronization source is DC.)
<b>Data update rate</b>	Fixed at 200 ms (when set to 10 ms or 50 ms, harmonic data alone is updated at 200 ms).
<b>Analysis orders</b>	0th to 50th
<b>Window wave number</b>	When less than 56 Hz, 10 waves; when 56 Hz or greater, 12 waves
<b>Number of FFT points</b>	4096 points

Accuracy	Frequency	Harmonic voltage and current	Harmonic power	Phase difference
	DC (0th order)		±0.1% rdg. ±0.1% f.s.	±0.1% rdg. ±0.2% f.s.
45 Hz ≤ f ≤ 66 Hz		±0.2% rdg. ±0.04% f.s.	±0.4% rdg. ±0.05% f.s.	±0.08°
66 Hz < f ≤ 440 Hz		±0.5% rdg. ±0.05% f.s.	±1.0% rdg. ±0.05% f.s.	±0.08°
440 Hz < f ≤ 1 kHz		±0.8% rdg. ±0.05% f.s.	±1.5% rdg. ±0.05% f.s.	±0.4°
1 kHz < f ≤ 2.5 kHz		±2.4% rdg. ±0.05% f.s.	±4% rdg. ±0.05% f.s.	±0.4°
2.5 kHz < f ≤ 3.3 kHz		±6% rdg. ±0.05% f.s.	±10% rdg. ±0.05% f.s.	±0.8°

Power is defined for a power factor of 1.  
 Accuracy specifications are defined for fundamental wave input that is greater than or equal to 50% of the range.  
 Add the current sensor accuracy to the above accuracy figures for current, active power, and phase difference.  
 Add ±0.02% rdg. for voltage and active power at or above 1000 V (however, figures are reference values).  
 Even for input voltages that are less than 1000 V, the effect will persist until the input resistance temperature falls.

**(2) Wideband mode**

<b>Measurement method</b>	Zero-cross synchronization calculation method (same window for each synchronization source) with gaps Fixed sampling interpolation calculation method
<b>Synchronization frequency range</b>	0.1 Hz to 300 kHz
<b>Data update rate</b>	Fixed at 50 ms. When set to 10 ms, harmonic data alone is updated at 50 ms. When set to 200 ms, values are obtained by averaging four sets of 50 ms data.

Maximum analysis order and window wave number (The instrument incorporates hysteresis at frequency range boundaries.)

Frequency	Window wave number	Maximum analysis order
0.1 Hz $\leq$ f < 80 Hz	1	100th
80 Hz $\leq$ f < 160 Hz	2	100th
160 Hz $\leq$ f < 320 Hz	4	60th
320 Hz $\leq$ f < 640 Hz	2	60th
640 Hz $\leq$ f < 6 kHz	4	50th
6 kHz $\leq$ f < 12 kHz	2	50th
12 kHz $\leq$ f < 25 kHz	4	50th
25 kHz $\leq$ f < 50 kHz	8	30th
50 kHz $\leq$ f < 101 kHz	16	15th
101 kHz $\leq$ f < 201 kHz	32	7th
201 kHz $\leq$ f $\leq$ 300 kHz	64	5th

**Phase zero-adjustment** The instrument provides phase zero-adjustment functionality using keys or communications commands (only available when the synchronization source is set to Ext).  
The phase zero-adjust value can be set automatically and manually.  
Setting range of the phase zero-adjust value:  $-180.000^\circ$  to  $+180.000^\circ$  (in increments of  $0.001^\circ$ )

**Accuracy** Add the following to the accuracy figures for voltage (U), current (I), active power (P), and phase difference. (Unit for f in the formulas in the following table: kHz)

Frequency	Harmonic voltage and current	Harmonic power	Phase difference
DC	$\pm 0.1\%$ f.s.	$\pm 0.2\%$ f.s.	–
0.1 Hz $\leq$ f < 30 Hz	$\pm 0.05\%$ f.s.	$\pm 0.05\%$ f.s.	$\pm 0.1^\circ$
30 Hz $\leq$ f < 45 Hz	$\pm 0.1\%$ f.s.	$\pm 0.2\%$ f.s.	$\pm 0.1^\circ$
45 Hz $\leq$ f $\leq$ 66 Hz	$\pm 0.05\%$ f.s.	$\pm 0.1\%$ f.s.	$\pm 0.1^\circ$
66 Hz < f $\leq$ 1 kHz	$\pm 0.05\%$ f.s.	$\pm 0.1\%$ f.s.	$\pm 0.1^\circ$
1 kHz < f $\leq$ 10 kHz	$\pm 0.05\%$ f.s.	$\pm 0.1\%$ f.s.	$\pm 0.6^\circ$
10 kHz < f $\leq$ 50 kHz	$\pm 0.2\%$ f.s.	$\pm 0.4\%$ f.s.	$\pm(0.020 \times f)^\circ \pm 0.5^\circ$
50 kHz < f $\leq$ 100 kHz	$\pm 0.4\%$ f.s.	$\pm 0.5\%$ f.s.	$\pm(0.020 \times f)^\circ \pm 1^\circ$
100 kHz < f $\leq$ 500 kHz	$\pm 1\%$ f.s.	$\pm 2\%$ f.s.	$\pm(0.030 \times f)^\circ \pm 1.5^\circ$
500 kHz < f $\leq$ 900 kHz	$\pm 4\%$ f.s.	$\pm 5\%$ f.s.	$\pm(0.030 \times f)^\circ \pm 2^\circ$

The figures for voltage, current, power, and phase difference for frequencies in excess of 300 kHz are reference values.

When the fundamental wave is outside the range of 16 Hz to 850 Hz, the figures for voltage, current, power, and phase difference for frequencies other than the fundamental wave are reference values.

When the fundamental wave is within the range of 16 Hz to 850 Hz, the figures for voltage, current, power, and phase difference in excess of 6 kHz are reference values.

Accuracy values for phase difference are defined for input for which the voltage and current for the same order are at least 10% f.s.

## Waveform recording specifications

<b>Number of measurement channels</b>	Voltage and current waveforms Motor waveforms	Max. 6 channels (based on the number of input channels) Max. 2 analog DC channels + max. 4 pulse channels
<b>Recording capacity</b>	<ul style="list-style-type: none"> <li>• 1 Mword × ((voltage + current) × max. 6 channels + motor waveforms)</li> <li>• Fixed to 1 Mword when the number of channels is low.</li> <li>• Motor waveforms: Motor analysis and D/A-equipped models only</li> <li>• No memory allocation function</li> </ul>	
<b>Waveform resolution</b>	16 bits (Voltage and current waveforms use the upper 16 bits of the 18-bit A/D.)	
<b>Sampling speed</b>	Voltage and current waveforms Motor waveforms Motor pulse	Always 5 MS/s Always 50 kS/s (analog DC) Always 5 MS/s
<b>Compression ratio</b>	1/1, 1/2, 1/5, 1/10, 1/20, 1/50, 1/100, 1/200, 1/500 (5 MS/s, 2.5 MS/s, 1 MS/s, 500 kS/s, 250 kS/s, 100 kS/s, 50 kS/s, 25 kS/s, 10 kS/s) However, motor waveforms are only compressed at 50 kS/s or less.	
<b>Recording length</b>	1 kWord / 5 kWord / 10 kWord / 50 kWord / 100 kWord / 500 kWord / 1 Mword	
<b>Storage mode</b>	Peak-to-peak compression or simple thinning	
<b>Trigger mode</b>	SINGLE or NORMAL (with forcible trigger setting) When FFT analysis is enabled in NORMAL mode, the instrument enters trigger standby after waiting for FFT calculations to complete.	
<b>Pre-trigger</b>	0% to 100% of the recording length, in 10% steps	
<b>Trigger detection method</b>	Level trigger / Event trigger (1) Level trigger Detects the trigger based on fluctuations in the level of the storage waveform. <b>Trigger source:</b> Voltage and current waveform, waveform after voltage and current zero-cross filter, manual, motor waveform, motor pulse (motor waveform and motor pulse: Motor analysis and D/A-equipped models only) <b>Trigger slope:</b> Rising edge, falling edge <b>Trigger level:</b> ±300% of the range for the waveform, in 0.1% steps  (2) Event trigger Detects the trigger based on fluctuations in the value of the measurement parameter selected for D/A output. Specifically, trigger detection conditions are set using OR and AND operations performed on the four events defined below. Note that the AND operator has precedence over the OR operator. Event: These condition definitions consist of a D/A output measurement parameter (D/A13 to D/A20), an inequality sign (< or >), and a value (0.00000 to 999999T). EVm : D/An □ X.XXXXX y (m: 1 to 4, n: 13 to 20, □: Inequality sign, X.XXXXX: 6-digit constant, y: SI prefix)	

## FFT analysis specifications

<b>Measurement channels</b>	Voltage and current waveforms: 1 channel (selected from input channels) Motor waveforms: Analog DC Analysis is performed only when the FFT screen is being displayed.
<b>Calculation type</b>	RMS spectrum
<b>Number of FFT points</b>	1,000 / 5,000 / 10,000 / 50,000
<b>FFT processing word length</b>	32 bits
<b>Analysis position</b>	User-specified position in recorded waveform data
<b>Anti-aliasing</b>	Automatic digital filter (during simple thinning mode) None (during peak-peak compression mode; FFT using max. value)
<b>Window functions</b>	Rectangular / Hanning / Flat-top
<b>Maximum analysis frequency</b>	Linked to waveform recording compression ratio 2 MHz, 1 MHz, 400 kHz, 200 kHz, 100 kHz, 40 kHz, 20 kHz, 10 kHz, 4 kHz With analog DC input: 20 kHz, 10 kHz, 4 kHz The maximum analysis frequency is obtained by subtracting the frequency resolution from the above frequency.
<b>FFT peak value display</b>	The level and frequency for the peak values for both voltage and current are shown. The display indicates 10 calculated values in order of descending peak value level from the top. FFT calculation results are recognized as peak values when both adjacent data points have lower levels than the data point in question.

## Motor analysis specifications (PW6001-11 to -16 only)

<b>Number of input channels</b>	4 channels CH A Analog DC input / Frequency input / Pulse input CH B Analog DC input / Frequency input / Pulse input CH C Pulse input CH D Pulse input
<b>Operating mode</b>	Single, dual, or independent input
<b>Input terminal profile</b>	Isolated BNC connectors
<b>Input resistance (DC)</b>	1 M $\Omega$ $\pm$ 50 k $\Omega$
<b>Input method</b>	Function-isolated input and single-end input
<b>Measurement parameters</b>	Voltage, torque, rpm, frequency, slip, motor power
<b>Synchronization source</b>	Same as the power measurement input specifications Single-mode operation 1 for all channels Dual-mode operation 2 sets (for CH A/CH C and for CH B/CH D).
<b>Input frequency source</b>	f1 to f6 (based on the instrument's number of channels) Select frequency to use for slip calculation. Single-mode operation 1 for all channels Dual-mode operation 2 sets (for CH A/CH C and for CH B/CH D).
<b>Number of motor poles</b>	2 to 254 Single/independent input mode operation 1 for all channels Dual-mode operation 2 sets (for CH A/CH C and for CH B/CH D).
<b>Maximum input voltage</b>	$\pm$ 20 V (analog DC and pulse operation)
<b>Additional conditions for guaranteed accuracy</b>	Input Terminal-to-ground voltage of 0 V, after zero-adjustment

**(1) Analog DC input (CH A/CH B)**

<b>Measurement range</b>	±1 V / ±5 V / ±10 V	
<b>Effective input range</b>	1% to 110% f.s.	
<b>Sampling</b>	50 kHz, 16 bits	
<b>Response speed</b>	0.2 ms (when LPF is OFF)	
<b>Measurement method</b>	Simultaneous digital sampling, zero-cross synchronization calculation method (averaging between zero-crosses)	
<b>Measurement accuracy</b>	±0.05% rdg. ±0.05% f.s.	
<b>Temperature coefficient</b>	±0.03% f.s./°C	
<b>Effects of common-mode voltage</b>	±0.01% f.s. or less with 50 V applied between the input terminals and the chassis (DC / 50 Hz / 60 Hz)	
<b>Effects of external magnetic fields</b>	±0.1% f.s. or less (in a magnetic field of 400 A/m, DC or 50 Hz/60 Hz)	
<b>LPF</b>	OFF (20 kHz) / ON (1 kHz)	
<b>Display range</b>	From the range's zero-suppression range setting to ±150%	
<b>Zero-adjustment</b>	Zero-compensation of input offsets that are less than or equal to voltage ±10% f.s.	
<b>Scaling</b>	0.01 to 9999.99 (Torque) / 0.01 to 99999.9 (rpm)	
<b>Units</b>	Torque                      N·m / mN·m / kN·m rpm                            r/min. Independent input V, up to 6 user-selected ASCII characters	

**(2) Frequency input (CH A/CH B)**

<b>Detection level</b>	Low: 0.5 V or less; High: 2.0 V or more
<b>Measurement frequency band</b>	0.1 Hz to 1 MHz (at 50% duty ratio)
<b>Minimum detection width</b>	0.5 μs or more
<b>Measurement range</b>	Set zero-point frequency $f_c$ and frequency $f_d$ at rated torque for $f_c \pm f_d$ [Hz]. Both $f_c$ and $f_d$ can be set from 1 kHz to 500 kHz in 1 Hz steps. However, values must be set so that $(f_c + f_d) \leq 500$ kHz and $(f_c - f_d) \geq 1$ kHz.
<b>Measurement accuracy</b>	±0.05% rdg. ±3 dgt.
<b>Display range</b>	1.000 kHz to 500.000 kHz
<b>Zero-adjustment</b>	Zero-compensation of input offsets within the range of $f_c \pm 1$ kHz
<b>Scaling</b>	0.01 to 9999.99
<b>Units</b>	N·m / mN·m / kN·m



**(3) Pulse input (CH A / CH B / CH C / CH D)**

<b>Detection level</b>	Low: 0.5 V or less; High: 2.0 V or more
<b>Measurement frequency band</b>	0.1 Hz to 1 MHz (at 50% duty ratio)
<b>Minimum detection width</b>	0.5 $\mu$ s or more
<b>Pulse filter</b>	OFF / Weak / Strong (When using the weak setting, positive and negative pulses of less than 0.5 $\mu$ s are ignored. When using the strong setting, positive and negative pulses of 5 $\mu$ s are ignored.)
<b>Measurement range</b>	800 kHz
<b>Measurement accuracy</b>	$\pm 0.05\%$ rdg. $\pm 3$ dgt.
<b>Display range</b>	0.1 Hz to 800.000 kHz
<b>Units</b>	Hz / r/min.
<b>Frequency division setting range</b>	1 to 60000
<b>Rotation direction detection</b>	Can be set in single mode (detected based on lead/lag of CH B and CH C).
<b>Mechanical angle origin detection</b>	Can be set in single mode (CH B frequency division cleared at CH D rising edge).

**D/A output specifications (PW6001-11 to -16 only)**

<b>Number of output channels</b>	20 channels				
<b>Output terminal profile</b>	D-sub 25-pin connector $\times$ 1				
<b>Output details</b>	<ul style="list-style-type: none"> <li>• Switchable between waveform output and analog output (select from basic measurement parameters).</li> <li>• Waveform output is fixed to CH1 to CH12.</li> <li>• Waveform output of 0 V is generated for channels that are not installed.</li> </ul>				
<b>D/A conversion resolution</b>	16 bits (polarity + 15 bits)				
<b>Output update rate</b>	<table> <tr> <td>Analog output</td> <td>10 ms / 50 ms / 200 ms (based on data update rate for the selected parameter)</td> </tr> <tr> <td>Waveform output</td> <td>1 MHz</td> </tr> </table>	Analog output	10 ms / 50 ms / 200 ms (based on data update rate for the selected parameter)	Waveform output	1 MHz
Analog output	10 ms / 50 ms / 200 ms (based on data update rate for the selected parameter)				
Waveform output	1 MHz				
<b>Output voltage</b>	<table> <tr> <td>Analog output</td> <td><math>\pm 5</math> V DC f.s. (max. approx. <math>\pm 12</math> V DC)</td> </tr> <tr> <td>Waveform output</td> <td>Switchable between <math>\pm 2</math> V f.s. and <math>\pm 1</math> V f.s., crest factor of 2.5 or greater Setting applies to all channels.</td> </tr> </table>	Analog output	$\pm 5$ V DC f.s. (max. approx. $\pm 12$ V DC)	Waveform output	Switchable between $\pm 2$ V f.s. and $\pm 1$ V f.s., crest factor of 2.5 or greater Setting applies to all channels.
Analog output	$\pm 5$ V DC f.s. (max. approx. $\pm 12$ V DC)				
Waveform output	Switchable between $\pm 2$ V f.s. and $\pm 1$ V f.s., crest factor of 2.5 or greater Setting applies to all channels.				
<b>Output resistance</b>	100 $\Omega$ $\pm 5$ $\Omega$				
<b>Output accuracy</b>	<table> <tr> <td>Analog output</td> <td>Output measurement parameter measurement accuracy <math>\pm 0.2\%</math> f.s. (DC level)</td> </tr> <tr> <td>Waveform output</td> <td>Measurement accuracy <math>\pm 0.5\%</math> f.s. (at <math>\pm 2</math> V f.s.) or <math>\pm 1.0\%</math> f.s. (at <math>\pm 1</math> V f.s.) (RMS value level, up to 50 kHz)</td> </tr> </table>	Analog output	Output measurement parameter measurement accuracy $\pm 0.2\%$ f.s. (DC level)	Waveform output	Measurement accuracy $\pm 0.5\%$ f.s. (at $\pm 2$ V f.s.) or $\pm 1.0\%$ f.s. (at $\pm 1$ V f.s.) (RMS value level, up to 50 kHz)
Analog output	Output measurement parameter measurement accuracy $\pm 0.2\%$ f.s. (DC level)				
Waveform output	Measurement accuracy $\pm 0.5\%$ f.s. (at $\pm 2$ V f.s.) or $\pm 1.0\%$ f.s. (at $\pm 1$ V f.s.) (RMS value level, up to 50 kHz)				
<b>Temperature coefficient</b>	$\pm 0.05\%$ f.s./ $^{\circ}$ C				

## Display specifications

<b>Display characters</b>	Japanese / English / Chinese (simplified)	
<b>Display</b>	9" WVGA TFT color LCD (800 × 480 dots) with an LED backlight and touch panel	
<b>Dot pitch</b>	0.246 (V) mm × 0.246 (H) mm	
<b>Display value resolution</b>	999999 count (including integration values)	
<b>Display update rate</b>	Measured values	Approx. 200 ms (independent of internal data update rate) When using simple averaging, the data update rate varies based on the number of averaging iterations.
	Waveforms	Based on display settings
<b>Screens</b>	Measurement screen, Input Settings screen, System Settings screen, File Operations screen	
<b>Warning displays</b>	When the input channel voltage or current has exceeded the peak value, when no synchronization source is detected. Warning icons for all channels are displayed on all Measurement screen pages. However, during waveform synchronization mode while synchronizing two instruments, inputs in excess of peak values for channels 4 to 6 on the master instrument are not displayed.	

## Control panel specifications

<b>Control devices</b>	Power button × 1, rubber key × 23, rotary knob × 2, touch panel							
<b>Touch panel</b>	Analog resistive touch panel							
<b>Rotary knobs</b>	30 clicks, 15 pulses, lighted							
<b>Rubber keys</b>	Mechanical switch type, 12 lighted, 11 not lighted							
	Lighted	<table border="1"> <tr> <td>Green/red</td> <td>START/STOP, RUN/STOP</td> </tr> <tr> <td>Green</td> <td>SINGLE, MEAS, INPUT, SYSTEM, FILE, AUTO×2</td> </tr> <tr> <td>Red</td> <td>HOLD, PEAK HOLD, REMOTE/LOCAL</td> </tr> </table>	Green/red	START/STOP, RUN/STOP	Green	SINGLE, MEAS, INPUT, SYSTEM, FILE, AUTO×2	Red	HOLD, PEAK HOLD, REMOTE/LOCAL
Green/red	START/STOP, RUN/STOP							
Green	SINGLE, MEAS, INPUT, SYSTEM, FILE, AUTO×2							
Red	HOLD, PEAK HOLD, REMOTE/LOCAL							
	Not lighted	PAGE (left/right), SAVE, COPY, U-UP, U-DOWN, I-UP, I-DOWN, 0 ADJ, DATA RESET, MANUAL						
<b>Key lock</b>	Turn on/off by pressing and holding the <b>[REMOTE/LOCAL]</b> key for 3 sec. While the key lock is engaged, the key lock icon is displayed on the screen.							
<b>System reset</b>	Reverts hardware settings to their initial values. However, language and communications settings are not changed.							
<b>Boot key reset</b>	The hardware settings are reverted to their factory defaults if the <b>[SYSTEM]</b> key is held down while the instrument is turned on. All functions, including language and communications settings, are initialized to their factory defaults.							
<b>File operations</b>	Display list of data on USB flash drive, format USB flash drive, create new folder, delete folder/file, copy files from internal memory							

## External interface specifications

### (1) USB flash drive interface

<b>Connector</b>	USB Type A connector × 1 with LED light function
<b>Connector location</b>	Front panel
<b>Electrical specifications</b>	USB 2.0 (high-speed)
<b>Power supplied</b>	Max. 500 mA
<b>Supported USB flash drives</b>	USB Mass Storage Class compatible
<b>File system</b>	FAT32
<b>Recorded data</b>	<ul style="list-style-type: none"> <li>• Save/load settings files</li> <li>• Save measured values/automatic recorded data (CSV format)</li> <li>• Copy measured values/recorded data (from internal memory)</li> <li>• Save waveform data, save screenshots (compressed BMP format)</li> </ul>

### (2) LAN interface

<b>Connector</b>	RJ-45 connector × 1
<b>Connector location</b>	Rear panel
<b>Electrical specifications</b>	IEEE 802.3 compliant
<b>Transmission method</b>	10Base-T / 100Base-TX / 1000Base-T (automatic detection)
<b>Protocol</b>	TCP/IP (with DHCP function)
<b>Functions</b>	HTTP server (remote operation), dedicated port (data transfers, command control), FTP server (file transfers)
<b>Maximum cable length</b>	100 m

### (3) GP-IB interface

<b>Connector</b>	Micro ribbon (Amphenol) 24-pin connector × 1
<b>Connector location</b>	Rear panel
<b>Communication method</b>	IEEE 488.1 1987 compliant developed with reference to IEEE 488.2 1987 Interface functions: SH1, AH1, T6, L4, SR1, RL1, PP0, DC1, DT1, C0
<b>Addresses</b>	00 to 30
<b>Remote control</b>	The <b>[REMOTE/LOCAL]</b> key lights up in the remote state, which can be cancelled with the <b>[REMOTE/LOCAL]</b> key.

**(4) RS-232C interface**

<b>Connector</b>	D-sub 9-pin connector × 1, 9-pin power supply compatible, also used for external control
<b>Connector location</b>	Rear panel
<b>Communication method</b>	RS-232C, EIA RS-232D, CCITT V.24, and JIS X5101 compliant Full duplex, start stop synchronization, data length of 8, no parity, 1 stop bit
<b>Flow control</b>	Hardware flow control ON/OFF
<b>Communications speed</b>	9,600 bps / 19,200 bps / 38,400 bps / 57,600 bps / 115,200 bps / 230,400 bps
<b>Power supplied</b>	OFF/ON (voltage of +5 V, max. 200 mA)
<b>Functions</b>	Command control, LR8410 Link support (requires connection using only pins 2, 3, 5, and 9 of the dedicated connector) Switchable with external control (simultaneous use not supported)

**(5) External control interface**

<b>Connector</b>	D-sub 9-pin connector × 1, 9-pin power supply compatible, also used for RS-232C
<b>Connector location</b>	Rear panel
<b>Pin assignments</b>	No. 1 pin Start/stop No. 4 pin Hold (event) No. 5 pin GND No. 6 pin Data reset No. 9 pin Power supply
<b>Supplied power</b>	OFF/ON (voltage of +5 V, max. 200 mA)
<b>Electrical specifications</b>	0 V/5 V (2.5 V to 5 V) logic signals or contact signal with terminal shorted or open
<b>Functions</b>	Same operation as the <b>[START/STOP]</b> key or the <b>[DATA RESET]</b> key on the control panel Switchable with RS-232C (simultaneous use not supported)

**Two-instrument synchronization interface**

<b>Connector</b>	SFP optical transceiver, Duplex-LC (2-wire LC)
<b>Connector location</b>	Rear panel
<b>Optical signal</b>	850 nm VCSEL, 1 Gbps
<b>Laser class</b>	Class 1
<b>Fiber used</b>	50/125 μm multi-mode fiber equivalent, up to 500 m
<b>Operating mode</b>	Value synchronization / Waveform synchronization
<b>Functions</b>	Data is sent from the connected slave instrument to the master instrument, which performs calculations and displays values.

## 10.3 Functional Specifications

### Auto-range function

<b>Function</b>	The voltage and current ranges for each connection are automatically changed in response to the input (excluding motor input ranges).	
<b>Operating mode</b>	OFF/ON (selectable for each connection)	
<b>Operation</b>	Pressing the <b>[AUTO]</b> key turns on auto-range operation for the corresponding connection, and the <b>[AUTO]</b> key lights up. Pressing the <b>[AUTO]</b> key while it is lit up or pressing the <b>▲/▼</b> range keys turns off auto-range operation for the corresponding range. Auto-range operation is turned off for all channels when integration starts.	
<b>Auto-range breadth</b>	Broad/narrow (applies to all channels)	
	Broad	The range is increased by one if the peak value is exceeded for the connection or if there is an RMS value that is greater than or equal to 110% f.s. The range is lowered by two if all RMS values for the connection are less than or equal to 10% f.s. (However, the range is not lowered if the peak value would be exceeded with the lower range.)
	Narrow	The range is increased by one if the peak value is exceeded for the connection or if there is an RMS value that is greater than or equal to 105% f.s. The range is lowered by one if all RMS values for the connection are less than or equal to 40% f.s. (However, the range is not lowered if the peak value would be exceeded with the lower range.)  Voltage range changes when $\Delta$ -Y conversion is enabled are determined by multiplying the range by $[\frac{1}{\sqrt{3}}]$ .
<b>Range changes</b>	Measured values for the corresponding connection or motor input at the time the range changes are invalidated. However, data for other connections is not affected. The waveform's period may be longer than the invalidation period if the synchronization frequency is low. In this case, it will take longer than the invalid data display period for measured values to stabilize. The same applies to range changes initiated by the user (not only auto-range changes).	

### Time control function

<b>Function</b>	Other functions are controlled based on the time. There are three types of control: timer control, actual time control, and interval control.	
<b>Operation</b>	Timer control	Stops once the set amount of time has elapsed.
	Actual time control	Starts at the specified time and stops at the specified time.
	Interval	Repeats control at a set interval from the time operation starts until it stops.
<b>Timer control</b>	OFF, 10 sec. to 9999 hr. 59 min. 59 sec. (in 1 sec. steps)	
<b>Actual time control</b>	OFF, start time/stop time (in 1 min. steps)	
<b>Interval</b>	OFF / 10 ms / 50 ms / 200 ms / 500 ms / 1 sec. / 5 sec. / 10 sec. / 15 sec. / 30 sec. / 1 min. / 5 min. / 10 min. / 15 min. / 30 min. / 60 min. However, the set value cannot be less than the data update rate. The maximum number of parameters that can be saved is determined based on this setting.	

## Hold functionality

### (1) Hold

<b>Function</b>	Stops updating the display with all measured values and holds the value currently being displayed. However, display updates continue for the waveform, clock, and peak-over displays. Internal calculations, for example integration and averaging, continue. The hold function cannot be used with the peak hold function.
<b>Operating mode</b>	OFF/ON
<b>Operation</b>	Pressing the <b>[HOLD]</b> key activates the function, and the <b>[HOLD]</b> key and the screen's hold icon light up. Pressing the <b>[HOLD]</b> key again turns off the function. While the hold function is on, data is updated when the <b>[PEAK HOLD]</b> key is pressed, during interval operation, and when an external control signal is detected. Data is updated using the internal data update rate (which is distinct from the display update rate).
<b>Output data</b>	Hold data is output for analog output and save data while the hold function is active (however, waveform output continues). For auto-saving during interval operation, the data from before the update is output.
<b>Backup</b>	None (The function turns off when the instrument is turned off.)
<b>Constraints</b>	While the hold function is on, settings that affect measured values cannot be changed.

### (2) Peak hold

<b>Function</b>	Updates the display for all measured values using the maximum value obtained by comparing the absolute values for each measured value (excluding Upk and lpk). However, the waveform display and instantaneous value display for integration values continue to be updated. During averaging operation, the maximum value is applied to the measured value after averaging. The peak hold function cannot be used with the hold function.
<b>Operating mode</b>	OFF/ON
<b>Operation</b>	Pressing the <b>[PEAK HOLD]</b> key activates the function, and the <b>[PEAK HOLD]</b> key and the screen's peak hold icon light up. Pressing the <b>[PEAK HOLD]</b> key again turns off the function. While the hold function is on, data is updated when the <b>[HOLD]</b> key is pressed, during interval operation, and when an external synchronization signal is detected. Data is updated using the internal data update rate (which is distinct from the display update rate).
<b>Output data</b>	Peak hold data is output for analog output and save data while the peak hold function is active. However, waveform output continues. For auto-saving during interval operation, the data from before data was cleared is output.
<b>Backup</b>	None (The function turns off when the instrument is turned off.)
<b>Constraints</b>	While the hold function is on, settings that affect measured values cannot be changed.

## Calculation functionality

### (1) Rectifier

<b>Function</b>	Selects the voltage and current values used to calculate apparent and reactive power and power factor.
<b>Operator mode</b>	RMS/mean (Can be selected for each connection's voltage and current.)

### (2) Scaling

<b>Function</b>	Sets the VT ratio and CT ratio and applies them to measured values. Can be selected for each connection.
<b>VT (PT) ratio</b>	OFF / 0.00001 to 9999.99 (Cannot be set such that VT*CT is greater than 1.0E+06.)
<b>CT ratio</b>	OFF / 0.00001 to 9999.99 (Cannot be set such that VT*CT is greater than 1.0E+06.)
<b>Display</b>	During scaling, the SC icon is displayed on the screen.

### (3) Averaging (AVG)

<b>Function</b>	<p>All instantaneous measured values, including harmonics, are averaged. (Excludes peak values, integration values, and harmonic data during 10 ms data update operation.) Voltage (U), current (I), and power (P) values are averaged, and calculated values are calculated from those values. For harmonics, instantaneous values are averaged for RMS values and content percentages. The phase angle is calculated from the results of averaging the real and imaginary parts after FFT application. The phase difference, distortion, and unbalance rate are calculated from data obtained by the above averaging. The ripple factor is calculated from data obtained by averaging the difference between the positive and negative peak values. Motor analysis measured values are calculated from data obtained by averaging the CH A, CH B, CH C, and CH D values.</p>						
<b>Operating mode</b>	OFF / Simple averaging / Exponential averaging						
<b>Operation</b>	Simple averaging	Averaging is performed for the number of simple averaging iterations for each data refresh cycle, and the output data is updated. The data update rate is lengthened by the number of averaging iterations.					
	Exponential averaging	Data is exponentially averaged using a time constant defined by the data update rate and the exponential averaging response speed.					
During averaging operation, averaged data is used for all analog output and save data.							
<b>Number of simple averaging iterations</b>	The output data update rate changes as follows depending on the number of averaging iterations and the data update rate:						
		Number of averaging iterations	5	10	20	50	100
	Data update rate	10 ms	50 ms	100 ms	200 ms	500 ms	1 sec.
		50 ms	250 ms	500 ms	1 sec.	2.5 sec.	5 sec.
	200 ms	1 sec.	2 sec.	4 sec.	10 sec.	20 sec.	
All connections use the same output data update rate.							
<b>Exponential averaging response speed</b>	Setting			FAST	MID	SLOW	
	Data update rate	10 ms	0.1 sec.	0.8 sec.	5 sec.		
		50 ms	0.5 sec.	4 sec.	25 sec.		
		200 ms	2.0 sec.	16 sec.	100 sec.		
<p>These values indicate the time required for the final stabilized value to converge on ±1% when the input changes from 0% f.s. to 90% f.s. Although harmonic data is not averaged when the data update rate is 10 ms, harmonic data contained in basic measurement parameters is averaged using the exponential averaging coefficient every 10 ms.</p>							

**(4) Efficiency and loss calculations**

<b>Function</b>	The efficiency $\eta$ [%] and loss Loss [W] are calculated based on each channel's and connection's active power values.
<b>Calculated items</b>	Active power value (P), fundamental wave active power (Pfund), and motor power (Pm) (Motor analysis and D/A-equipped models only) for each channel and connection
<b>Calculation precision</b>	Items are calculated using 32-bit floating-point calculations using measured values for the parameters substituted into each formula. When performing calculations between connections with different power ranges, the largest range in the same calculation is used.
<b>Calculation rate</b>	Calculations are updated using the data update rate. When performing calculations between connections with different synchronization sources, the most recent data at the time of the calculation is used.
<b>Number of calculations that can be performed</b>	Four each efficiency and loss
<b>Calculation formulas</b>	Calculated items are specified for Pin(n) and Pout(n) in the following format: Pin = Pin1 + Pin2 + Pin3 + Pin4, Pout = Pout1 + Pout2 + Pout3 + Pout4  $\eta = 100 \times \frac{ Pout }{ Pin }, \text{ Loss} =  Pin  -  Pout $

**(5) User-defined calculations**

<b>Function</b>	User-specified basic measurement parameters are calculated using the specified calculation formulas.
<b>Calculation items</b>	4 basic measurement parameters or constants with up to 6 digits combined with 4 fundamental arithmetic operators UDFn = ITEM1 □ ITEM2 □ ITEM3 □ ITEM4 ITEMn: Basic measurement parameter or constant with up to 6 digits □ : One of following: +, -, *, / A UDFn term can also be selected as ITEMn, with calculations performed in the order indicated by n. The following functions can be selected for each ITEMn term: neg (sign), sin, cos, tan, sqrt, abs, log10 (common logarithm), log (logarithm), exp, asin, acos, atan, sinh, cosh, and tanh. When a UDFn formula includes UDFm (where n ≤ m), the previous calculated value is used for UDFm.
<b>Number of calculations allowed</b>	16 (UDF1 to UDF16)
<b>Maximum value setting</b>	Set for each UDFn term within the range of 1.000 μ to 100.0 T. Functions as the UDFn range.
<b>Units</b>	Up to 6 ASCII characters for each UDFn term

**(6) Power calculation formula selection**

<b>Function</b>	Selects the reactive power, power factor, and power phase angle formulas.
<b>Formulas</b>	TYPE1 / TYPE2 / TYPE3 TYPE1 Compatible with TYPE1 as used by the PW3390, 3390 and 3193. TYPE2 Compatible with TYPE2 as used by the 3192 and 3193. TYPE3 Uses the active power sign as the power factor sign. For more information, see "10.5 Calculation Formula Specifications" (p.243 to p.244).



**(7) Delta conversion**

<b>Function</b>	$\Delta$ -Y	When using a 3P3W3M or 3V3A connection, converts the line voltage waveform to a phase voltage waveform using a virtual neutral point.
	Y- $\Delta$	When using a 3P4W connection, converts the phase voltage waveform to a line voltage waveform. Voltage RMS values and all voltage parameters, including harmonics, are calculated using the post-conversion voltage. However, peak-over is determined using pre-conversion values.
<b>Formulas</b>	$\Delta$ -Y 3P3W3M	$u1s = (U1s - U3s) / 3$ , $u2s = (U2s - U1s) / 3$ , $u3s = (U3s - U2s) / 3$ $u4s = (U4s - U6s) / 3$ , $u5s = (U5s - U4s) / 3$ , $u6s = (U6s - U5s) / 3$
	$\Delta$ -Y 3V3A	$u1s = (U1s - U3s) / 3$ , $u2s = (U3s + U2s) / 3$ , $u3s = (-U2s - U1s) / 3$ $u4s = (U4s - U6s) / 3$ , $u5s = (U6s + U5s) / 3$ , $u6s = (-U5s - U4s) / 3$
	Y- $\Delta$	$U1s = u1s - u2s$ , $U2s = u2s - u3s$ , $U3s = u3s - u1s$ $U4s = u4s - u5s$ , $U5s = u5s - u6s$ , $U6s = u6s - u4s$ u1s to u6s: Phase voltage sampling values for channels 1 through 6 U1s to U6s: Line voltage sampling values for channels 1 through 6

**(8) Current sensor phase shift calculation**

<b>Function</b>	Corrects the current sensor's harmonic phase characteristics using calculations.
<b>Operating mode</b>	OFF/ON (set for each connection)
<b>Compensation value settings</b>	Compensation points are set using the frequency and phase difference. Frequency      0.1 kHz to 999.9 kHz (in 0.1 kHz steps) Phase difference 0.00° to ±90.00° (in 0.01° steps) However, the time difference calculated from the frequency's phase difference is subject to a maximum value of 98 $\mu$ s in 0.5 ns steps.

**Display functionality****(1) Connection confirmation screen**

<b>Function</b>	Displays a connection diagram and, for connections other than 1-phase connections, voltage and current vectors based on the selected measurement lines and dual sensor settings. The ranges for a correct connection are displayed on the vector display so that the connection can be checked.
<b>Mode at startup</b>	User can select to display the connection confirmation screen at startup (startup screen setting).
<b>Simple settings</b>	Users can select a measurement target for each connection and switch to appropriate settings. Commercial power supply / Commercial power supply HD / DC / DC HD / PWM / High-frequency / Low power factor / Other

**(2) Vector display screen**

<b>Function</b>	Displays a connection-specific vector graph along with associated level values and phase angles. The user can select the display order and vector magnification.
<b>Display patterns</b>	1-vector Vectors are drawn for up to six channels; can be turned on and off for each channel. 2-vector Vectors are drawn for each selected connection.

### (3) Numerical display screen

<b>Function</b>	Displays power measured values and motor measured values for up to six instrument channels.	
<b>Display patterns</b>	Basic by connection	Displays measured values for the measurement lines and motors combined in the connection. There are four measurement line patterns: U, I, P, and Integ. The display is linked to the channel display LEDs.
	Selection display	Creates a numerical display for the measurement parameters that the user has selected from all basic measurement parameters in the location selected by the user. There are 4-, 8-, 16-, and 32-display patterns.

### (4) Harmonic display screen

<b>Function</b>	Displays harmonic measured values on the instrument's screen.	
<b>Display patterns</b>	Bar-graph display	Displays harmonic measurement parameters for user-specified channels as a bar graph.
	List display	Displays numerical values for user-specified parameters and user-specified channels.

### (5) Waveform display screen

<b>Function</b>	Displays the voltage and current waveforms and motor waveform.	
<b>Display patterns</b>	All-waveform display, zoom display, FFT display, waveform + numerical display, cursor measurements are supported.	

## Simple graph function

### (1) D/A monitor graph

<b>Function</b>	Displays recorded parameters (measured values) selected as D/A output parameters as a time series. Waveform data at the data refresh rate is subject to peak-peak compression based on the time axis setting and rendered. Data is not recorded or saved.	
<b>Operation</b>	Rendering is started and stopped with the <b>RUN/STOP</b> button. Display values are rendered during hold and peak hold operation. Rendered data is cleared when a setting related to measured values (for example, D/A output parameters or ranges) is changed and when the clear button is pressed.	
<b>Number of rendering parameter</b>	Up to 8	
<b>Rendering parameters</b>	Linked to D/A output parameter CH13 to CH20 settings	
<b>Time axis</b>	10 ms/dot to 48 min/dot (cannot select less than data refresh rate)	
<b>Vertical axis</b>	Auto-scaled (so that data within the screen display range based on the time axis fits on the screen) / manual (based on user-set maximum and minimum display values)	

### (2) X-Y plot

<b>Function</b>	Displays an X-Y graph based on the user's selection of the horizontal axis and vertical axis parameters from the basic measurement parameters. Dots are rendered based on the data refresh rate, and data is not recorded or saved.	
-----------------	--	--

## Automatic save function

<b>Function</b>	Saves the specified measured values in effect for each interval. Automatic save operation is controlled by the time control function. Data is recorded to the same file until a data reset is performed.	
<b>Save destination</b>	OFF / Internal memory / USB flash drive If the USB flash drive is selected, the user can also specify a save destination folder.	
<b>Saved parameters</b>	User-selected from all measured values, including harmonic measured values	
<b>Maximum number of saved parameters</b>	When the save destination is the USB flash drive, the maximum number of saved parameters varies with the interval setting.	
<b>Maximum amount of saved data</b>	Internal memory	64 MB (data for approx. 3600 measurements) 1 file only (overwritten)
	USB flash drive	Approx. 100 MB per file (automatically segmented) × 100 files Functionality is not provided for automatically erasing files when the media is full.
<b>Data format</b>	CSV file format (with read-only attribute) With functionality for selecting the delimiter	
	CSV	Measurement data is delimited with commas, and a period “.” is used to represent decimal points.
	SSV	Measurement data is delimited with semicolons, and a comma “,” is used to represent decimal points.
<b>Filename</b>	Automatically generated based on the time and date at which measurement started; extension: CSV.	

## Manual save function

### (1) Measurement data

<b>Function</b>	The <b>[SAVE]</b> key saves specified measured values at the time it is pressed. Comment text can be entered for each saved data point. A new file is created the first time data is saved. Subsequently, data is added to the same file. A new file is created when the save destination folder, connection pattern, or saved parameters are changed. In addition, a new file is created when the <b>[DATA RESET]</b> key is pressed.	
<b>Save destination</b>	USB flash drive The save destination folder can be specified.	
<b>Saved parameters</b>	User-selected from all measured values, including harmonic measured values (same as saved parameters for the automatic save function)	
<b>Comment entry</b>	OFF/ON Up to 40 alphanumeric characters and symbols	
<b>Data format</b>	CSV file format (with read-only attribute)	
<b>Filename</b>	Automatically generated; extension: CSV	
<b>Constraints</b>	The manual save function for measurement data cannot be used while automatic saving is in progress.	

**(2) Waveform data**

<b>Function</b>	The <b>[Save Waveforms]</b> key saves waveform data at the time it is pressed. (There is no physical <b>[Save Waveforms]</b> key. Instead, it is implemented as a button on the touch panel.) Comment text can be entered for each saved data point.
<b>Save destination</b>	USB flash drive The save destination folder can be specified.
<b>Comment entry</b>	OFF/ON Up to 40 alphanumeric characters and symbols
<b>Data format</b>	CSV file format (with read-only attribute) Binary file format (.BIN format)
<b>Filename</b>	Automatically generated; extension: CSV or BIN
<b>Constraints</b>	Operation is not available during automatic save operation, during storage device operation, or when the waveform data is invalid.

**(3) Screenshots**

<b>Function</b>	The <b>[COPY]</b> key saves a screenshot to the save destination. Saved screenshots can be reviewed on the File screen.
<b>Save destination</b>	USB flash drive The save destination folder can be specified.
<b>Comment entry</b>	OFF / Text / Handwritten When set to [Text], up to 40 alphanumeric characters and symbols When set to [Handwritten], hand-drawn images are pasted to the screen.
<b>Data format</b>	Compressed BMP
<b>Filename</b>	Automatically generated; extension: BMP
<b>Constraints</b>	The function can be used while automatic saving is in progress, but automatic save operation takes priority. Cannot be used when the interval is set to less than 1 sec.

**(4) Settings data**

<b>Function</b>	Saves settings information to the save destination as a settings file via functionality provided on the File screen. In addition, previously saved settings files can be loaded and their settings restored on the File screen. However, language and communications settings are not saved.
<b>Save destination</b>	USB flash drive, the save destination folder can be specified.
<b>Filename</b>	Filename as set by the user when saving the file; extension: SET

**(5) FFT data**

<b>Function</b>	Saves the FFT data for set and displayed channels when the <b>Save FFT Spectrum</b> key is pressed. (The <b>Save FFT Spectrum</b> key is a button on the touch panel, rather than a hardware key.) Comments can be entered for each set of saved data.
<b>Save destination</b>	USB flash drive The user can specify the destination folder.
<b>Comment entry</b>	OFF/ON Up to 40 alphanumeric characters
<b>Data format</b>	CSV file format (with read-only attribute set)
<b>Filename</b>	Automatically generated with extension of CSV; F6001nnn.CSV (where “nnn” indicates sequential numbering from 0 to 999)
<b>Constraints</b>	Operation is not available during automatic save operation, during storage device operation, or when the waveform data is invalid.

**Two-instrument synchronization function**

<b>Function</b>	Sends data from the connected slave instrument to the master instrument, which performs calculations and displays the results. In numerical synchronization mode, the master instrument operates as a power meter with up to 12 channels. In waveform synchronization mode, the master instrument operates while synchronizing up to three channels from the slave instrument at the waveform level.	
<b>Operating mode</b>	OFF / Numerical synchronization / Waveform synchronization Numerical synchronization cannot be selected when the data update rate is 10 ms. Waveform synchronization cannot be selected when the master instrument has less than three channels or during dual sensor operation.	
<b>Synchronized items</b>	Numerical synchronization mode	Data update timing, start/stop/data reset
	Waveform synchronization mode	Voltage/current sampling timing
<b>Synchronization delay</b>	Numerical synchronization mode	Up to 20 $\mu$ s
	Waveform synchronization mode	Up to 5 samples
<b>Transfer items</b>	Numerical synchronization mode	Basic measurement parameters for up to six channels (including motor data, not including user-defined calculations)
	Waveform synchronization mode	Voltage/current sampling waveforms for up to three channels (not including motor data)
	However, the maximum number of channels is limited to a total of six, including the master instrument's channels.	

## Other functions

<b>Clock function</b>	Auto-calendar, automatic leap year detection, 24-hour clock
<b>Actual time accuracy</b>	When the instrument is on, $\pm 100$ ppm; when the instrument is off, within $\pm 3$ sec./day (25°C)
<b>Sensor identification</b>	Current sensors connected to Probe1 are automatically detected. Sensor range and sensor connection/disconnection events are detected, and a warning dialog is displayed.
<b>Zero-adjustment function</b>	After the AC/DC current sensor's DEMAG signal is sent, zero-compensation of the voltage and current input offsets is performed. Either voltage/current channels or motor channels are selected on the channel display, and zero-adjustment is performed for all ranges for the selected channels. If the compensation range is exceeded, the instrument displays the error channel and range and continues the compensation process. Compensation values for the erroneous channel or range (other than current range) revert to the previous compensation values. Compensation values are preserved across power on/off events and system resets. Compensation values revert to their factory defaults if a boot key reset is performed.
<b>Touch panel compensation</b>	Position calibration is performed for the touch panel. Compensation values are preserved across power on/off events and system resets. Compensation values revert to their factory defaults if a boot key reset is performed.

## 10.4 Measurement Parameter Detailed Specifications

### Basic measurement parameters

#### (1) Power measurement parameters

Measurement parameter	Notation	Pattern 1 1P2W×6	Pattern 2 1P3W / 3P3W2M + 1P2W×4	Pattern 3 1P3W / 3P3W2M×2 + 1P2W×2	Pattern 4 1P3W / 3P3W2M×3	Pattern 5 3P3W3M / 3V3A / 3P4W + 1P2W×3	Pattern 6 3P3W3M / 3V3A / 3P4W + 1P3W / 3P3W2M + 1P2W	Pattern 7 3P3W3M / 3V3A / 3P4W×2	
Voltage	RMS value	Urms	CH	CH 12	CH 12, 45	CH 12, 34, 56	CH 123	CH 123, 45	CH 123, 456
	Mean value rectification RMS equivalent	Umn	CH	CH 12	CH 12, 45	CH 12, 34, 56	CH 123	CH 123, 45	CH 123, 456
	AC component	Uac	CH	CH	CH	CH	CH	CH	CH
	Simple average	Udc	CH	CH	CH	CH	CH	CH	CH
	Fundamental wave component	Ufnd	CH	CH	CH	CH	CH	CH	CH
	Waveform peak +	Upk+	CH	CH	CH	CH	CH	CH	CH
	Waveform peak -	Upk-	CH	CH	CH	CH	CH	CH	CH
	Total harmonic distortion	Uthd	CH	CH	CH	CH	CH	CH	CH
	Ripple factor	Urf	CH	CH	CH	CH	CH	CH	CH
Unbalance rate	Uunb					123	123	123, 456	
Current	RMS value	Irms	CH	CH 12	CH 12, 45	CH 12, 34, 56	CH 123	CH 123, 45	CH 123, 456
	Mean value rectification RMS equivalent	Imn	CH	CH 12	CH 12, 45	CH 12, 34, 56	CH 123	CH 123, 45	CH 123, 456
	AC component	Iac	CH	CH	CH	CH	CH	CH	CH
	Simple average	Idc	CH	CH	CH	CH	CH	CH	CH
	Fundamental wave component	Ifnd	CH	CH	CH	CH	CH	CH	CH
	Waveform peak +	Ipk+	CH	CH	CH	CH	CH	CH	CH
	Waveform peak -	Ipk-	CH	CH	CH	CH	CH	CH	CH
	Total harmonic distortion	Ithd	CH	CH	CH	CH	CH	CH	CH
	Ripple factor	Irf	CH	CH	CH	CH	CH	CH	CH
Unbalance rate	Iunb					123	123	123, 456	
Active power	P	CH	CH 12	CH 12, 45	CH 12, 34, 56	CH 123	CH 123, 45	CH 123, 456	
Fundamental wave active power	Pfnd	CH	CH 12	CH 12, 45	CH 12, 34, 56	CH 123	CH 123, 45	CH 123, 456	
Apparent power	S	CH	CH 12	CH 12, 45	CH 12, 34, 56	CH 123	CH 123, 45	CH 123, 456	
Fundamental wave apparent power	Sfnd	CH	CH 12	CH 12, 45	CH 12, 34, 56	CH 123	CH 123, 45	CH 123, 456	
Reactive power	Q	CH	CH 12	CH 12, 45	CH 12, 34, 56	CH 123	CH 123, 45	CH 123, 456	
Fundamental wave reactive power	Qfnd	CH	CH 12	CH 12, 45	CH 12,34,56	CH 123	CH 123, 45	CH 123, 456	
Power factor	$\lambda$	CH	CH 12	CH 12, 45	CH 12, 34, 56	CH 123	CH 123, 45	CH 123, 456	
Fundamental wave power factor	$\lambda_{fnd}$	CH	CH 12	CH 12, 45	CH 12, 34, 56	CH 123	CH 123, 45	CH 123, 456	
Phase angle	Voltage phase angle	$\theta_U$	CH	CH	CH	CH	CH	CH	CH
	Current phase angle	$\theta_I$	CH	CH	CH	CH	CH	CH	CH
	Power phase angle	$\phi$	CH	CH 12	CH 12, 45	CH 12, 34, 56	CH 123	CH 123, 45	CH 123, 456

CH: Channels with which instrument is equipped (1, 2, 3, 4, 5, or 6)

Measurement Parameter Detailed Specifications

Measurement parameter		Notation	Unit	Display range		Polarity (+/-)
Voltage	RMS value	Urms	V	Of U range:	Zero to 150% <sup>*2</sup>	
	Mean value rectification RMS equivalent	Umn	V	↓	Zero to 150% <sup>*2</sup>	
	AC component	Uac	V	↓	Zero to 150% <sup>*2</sup>	
	Simple average	Udc	V	↓	Zero to 150% <sup>*2</sup>	✓
	Fundamental wave component	Ufnd	V	↓	Zero to 150% <sup>*2</sup>	
	Waveform peak +	Upk+	V	↓	Zero to 300% <sup>*3</sup>	✓
	Waveform peak -	Upk-	V	↓	Zero to 300% <sup>*3</sup>	✓
	Total harmonic distortion <sup>*1</sup>	Uthd	%		0.000 to 500.000	
	Ripple factor <sup>*1</sup>	Urf	%		0.000 to 500.000	
Unbalance rate	Uunb	%		0.000 to 100.000		
Current	RMS value	Irms	A	Of I range:	Zero to 150%	
	Mean value rectification RMS equivalent	Imn	A	↓	Zero to 150%	
	AC component	Iac	A	↓	Zero to 150%	
	Simple average	Idc	A	↓	Zero to 150%	✓
	Fundamental wave component	Ifnd	A	↓	Zero to 150%	
	Waveform peak +	Ipk+	A	↓	Zero to 300% <sup>*4</sup>	✓
	Waveform peak -	Ipk-	A	↓	Zero to 300% <sup>*4</sup>	✓
	Total harmonic distortion <sup>*1</sup>	Ithd	%		0.000 to 500.000	
	Ripple factor <sup>*1</sup>	Irf	%		0.000 to 500.000	
Unbalance rate	Iunb	%		0.000 to 100.000		
Active power		P	W	Of P range:	Zero to 150%	✓
Fundamental wave active power		Pfnd	W	↓	Zero to 150%	✓
Apparent power		S	VA	↓	Zero to 150%	
Fundamental wave apparent power		Sfnd	VA	↓	Zero to 150%	
Reactive power		Q	Var	↓	Zero to 150%	✓
Fundamental wave reactive power		Qfnd	Var	↓	Zero to 150%	✓
Power factor		λ			0.00000 to 1.00000	✓
Fundamental wave power factor		λfnd			0.00000 to 1.00000	✓
Phase angle	Voltage phase angle	θU	°		0.000 to 180.000	✓
	Current phase angle	θI	°		0.000 to 180.000	✓
	Power phase angle	φ	°		0.000 to 180.000	✓

Zero: Zero-suppression setting value

✓ Indicates a parameter with a positive or negative polarity sign.

\*1: When using the 1500 V range, 100%.

This range does not change, including when using the delta conversion function.

\*2: When using the 1500 V range, 133%.

\*3: When using the Probe2 5 V range, 150%.

\*4: Zero display of S value and Q value, conforms to U value and I value.

When the Upk+/Upk- voltage waveform peak or the Ipk+/Ipk- current waveform peak exceeds the display range, a peak-over event is considered to have occurred.



**(2) Integration measurement parameters**

Measurement parameter	Notation	Pattern 1 1P2W×6	Pattern 2 1P3W / 3P3W2M + 1P2W×4	Pattern 3 1P3W / 3P3W2M×2 + 1P2W×2	Pattern 4 1P3W / 3P3W2M×3	Pattern 5 3P3W3M / 3V3A / 3P4W + 1P2W×3	Pattern 6 3P3W3M / 3V3A / 3P4W + 1P3W / 3P3W2M + 1P2W	Pattern 7 3P3W3M / 3V3A / 3P4W×2	
Integration	Positive-direction current magnitude <sup>*1</sup>	lh+	CH	3, 4, 5, 6	3, 6		4, 5, 6	6	
	Negative-direction current magnitude <sup>*1</sup>	lh-	CH	3, 4, 5, 6	3, 6		4, 5, 6	6	
	Sum of positive- and negative- direction current magnitude	lh	CH	CH	CH	CH	CH	CH	CH
	Positive-direction power magnitude	WP+	CH	3, 4, 5, 6, 12	3, 6, 12, 45	12, 34, 56	4, 5, 6, 123	6, 123, 45	123, 456
	Negative-direction power magnitude	WP-	CH	3, 4, 5, 6, 12	3, 6, 12, 45	12, 34, 56	4, 5, 6, 123	6, 123, 45	123, 456
	Sum of positive- and negative-direction power magnitude	WP	CH	3, 4, 5, 6, 12	3, 6, 12, 45	12, 34, 56	4, 5, 6, 123	6, 123, 45	123, 456

CH: Channels with which instrument is equipped (1, 2, 3, 4, 5, or 6)

\*1: Only channels for which the integration mode is set to DC mode.

Measurement parameter	Notation	Unit	Display range		Polarity (+/-)	
Integration	Positive-direction current magnitude	lh+	Ah	Of I range:	0 to 1% to <sup>-2</sup>	
	Negative-direction current magnitude	lh-	Ah	↓	0 to 1% to <sup>-2</sup>	<sup>-3</sup>
	Sum of positive- and negative- direction current magnitude	lh	Ah	↓	0 to 1% to <sup>-2</sup>	✓
	Positive-direction power magnitude	WP+	Wh	Of P range:	0 to 1% to <sup>-2</sup>	
	Negative-direction power magnitude	WP-	Wh	↓	0 to 1% to <sup>-2</sup>	<sup>-3</sup>
	Sum of positive- and negative- direction power magnitude	WP	Wh	↓	0 to 1% to <sup>-2</sup>	✓

✓: Indicates a parameter with a positive or negative polarity sign.

\*2: Positive, negative, and positive/negative values use the same range and are displayed using the number of digits needed to display the maximum value.

\*3: Indicates a parameter whose sign is always negative.

**(3) Frequency and calculation measurement parameters**

Measurement parameter	Notation	Unit	Channel	Display range	Polarity (+/-)
Frequency	f	Hz	CH	0.00000 Hz to 2.00000 MHz	
Efficiency	$\eta$	%	1, 2, 3, 4	0.000 to 200.000	
Loss	Loss	W	1, 2, 3, 4	150% of P range	✓
User-defined calculation	UDF	Free <sup>*</sup>	1, 2, 3, 4, 5, 6, 7, 8, 9, 10, 11, 12, 13, 14, 15, 16	As per settings	✓

✓: Indicates a parameter with a positive or negative polarity sign.

\*: Can be set by user.

**(4) Motor analysis measurement parameters (Motor analysis and D/A-equipped models only)**

Mode	Single		Dual		Independent input	
Terminal	Input parameter	Notation	Input parameter	Notation	Input parameter	Notation
CH A	Torque <sup>*1</sup>	Tq1	Torque <sup>*1</sup>	Tq1	Voltage/pulse	CH A
CH B	RPM <sup>*2</sup>	Spd1	Torque <sup>*1</sup>	Tq2	Voltage/pulse	CH B
CH C	OFF / Rotation direction <sup>*3</sup>	--	RPM <sup>*3</sup>	Spd1	Pulse	CH C
CH D	OFF / Z-phase <sup>*3</sup>	--	RPM <sup>*3</sup>	Spd2	Pulse	CH D
--	Motor power	Pm1	Motor power	Pm1, Pm2	--	--
--	Slip	Slip1	Slip	Slip1, Slip2	--	--

\*1: Switchable between analog DC input and frequency input.

\*2: Switchable between analog DC input and pulse input.

\*3: Pulse input only.

	Measurement parameter	Setting	Unit	Display range		Polarity (+/-)
CH A	Torque	Analog DC	mNm, Nm,	Of A range:	Zero to 150%	✓
		Frequency	kNm	Rated torque setting	0 to 150%	✓
	Voltage	Analog DC	V, user-specified	Of A range:	Zero to 150%	✓
	Pulse frequency	Pulse	Hz			
CH B	Torque	Analog DC	mNm, Nm,	Of A range:	Zero to 150%	✓
		Frequency	kNm	Rated torque setting	0 to 150%	✓
	RPM	Analog DC	r/min	Of B range:	Zero to 150%	✓
		Pulse			✓ <sup>*1</sup>	
	Voltage	Analog DC	V, user-specified	Of A range:	Zero to 150%	✓
Pulse frequency	Pulse	Hz				
CH C	RPM	Pulse	r/min			
	Pulse frequency	Pulse	Hz			
CH D	RPM	Pulse	r/min			
	Pulse frequency	Pulse	Hz			
Pm	Motor power		W	Of Pm range:	Zero to 150%	✓
Slip	Slip		%		0.000 to 100.000	✓

✓: Indicates a parameter with a positive or negative polarity sign.

\*1: When using rotation direction in single mode only.

Peak-over detection is not performed for measured values for motor analysis measurement parameters.

## Harmonic measurement parameters

Measurement parameter	Notation	Pattern 1 1P2W×6	Pattern 2 1P3W / 3P3W2M + 1P2W×4	Pattern 3 1P3W / 3P3W2M×2 + 1P2W×2	Pattern 4 1P3W / 3P3W2M×3	Pattern 5 3P3W3M / 3V3A / 3P4W + 1P2W×3	Pattern 6 3P3W3M / 3V3A / 3P4W + 1P3W / 3P3W2M + 1P2W	Pattern 7 3P3W3M / 3V3A / 3P4W×2
Harmonic voltage RMS value	U <sub>k</sub>	CH	CH	CH	CH	CH	CH	CH
Harmonic voltage phase angle	θU <sub>k</sub>	CH	CH	CH	CH	CH	CH	CH
Harmonic current RMS value	I <sub>k</sub>	CH	CH	CH	CH	CH	CH	CH
Harmonic current phase angle	θI <sub>k</sub>	CH	CH	CH	CH	CH	CH	CH
Harmonic active power	P <sub>k</sub>	CH	CH 12	CH 12, 45	CH 12, 34, 56	CH 123	CH 123, 45	CH 123, 456
Harmonic voltage/current phase angle	θ <sub>k</sub>	CH	CH 12	CH 12, 45	CH 12, 34, 56	CH 123	CH 123, 45	CH 123, 456
Harmonic voltage content percentage	HDU <sub>k</sub>	CH	CH	CH	CH	CH	CH	CH
Harmonic current content percentage	HDI <sub>k</sub>	CH	CH	CH	CH	CH	CH	CH
Harmonic power content percentage	HDP <sub>k</sub>	CH	CH 12	CH 12, 45	CH 12, 34, 56	CH 123	CH 123, 45	CH 123, 456

Measurement parameter	Notation	Unit	Display range		Polarity (+/-)
Harmonic voltage RMS value	U <sub>k</sub>	V	Of U range:	0 to 150%	*
Harmonic voltage phase angle	θU <sub>k</sub>	°		0.000 to 180.000	✓
Harmonic current RMS value	I <sub>k</sub>	A	Of I range:	0 to 150%	*
Harmonic current phase angle	θI <sub>k</sub>	°		0.000 to 180.000	✓
Harmonic active power	P <sub>k</sub>	W	Of P range:	0 to 150%	✓
Harmonic voltage/current phase angle	θ <sub>k</sub>	°		0.000 to 180.000	✓
Harmonic voltage content percentage	HDU <sub>k</sub>	%		0.000 to 100.000	*
Harmonic current content percentage	HDI <sub>k</sub>	%		0.000 to 100.000	*
Harmonic power content percentage	HDP <sub>k</sub>	%		0.000 to 100.000	✓

✓: Indicates a parameter with a positive or negative polarity sign.

\*: This parameter includes a polarity sign for the 0th order component only.

## Power range breakdown

### (1) With 20 A sensor

Voltage/connection/current		400.000 mA	800.000 mA	2.00000 A	4.00000 A	8.00000 A	20.0000 A
6.00000 V	1P2W	2.40000	4.80000	12.0000	24.0000	48.0000	120.000
	1P3W, 3V3A 3P3W (2M, 3M)	4.80000	9.60000	24.0000	48.0000	96.0000	240.000
	3P4W	7.20000	14.4000	36.0000	72.0000	144.000	360.000
15.0000 V	1P2W	6.00000	12.0000	30.0000	60.0000	120.000	300.000
	1P3W, 3V3A 3P3W (2M, 3M)	12.0000	24.0000	60.0000	120.000	240.000	600.000
	3P4W	18.0000	36.0000	90.0000	180.000	360.000	900.000
30.0000 V	1P2W	12.0000	24.0000	60.0000	120.000	240.000	600.000
	1P3W, 3V3A 3P3W (2M, 3M)	24.0000	48.0000	120.000	240.000	480.000	1.20000 k
	3P4W	36.0000	72.0000	180.000	360.000	720.000	1.80000 k
60.0000 V	1P2W	24.0000	48.0000	120.000	240.000	480.000	1.20000 k
	1P3W, 3V3A 3P3W (2M, 3M)	48.0000	96.0000	240.000	480.000	960.000	2.40000 k
	3P4W	72.0000	144.000	360.000	720.000	1.44000 k	3.60000 k
150.000 V	1P2W	60.0000	120.000	300.000	600.000	1.20000 k	3.00000 k
	1P3W, 3V3A 3P3W (2M, 3M)	120.000	240.000	600.000	1.20000 k	2.40000 k	6.00000 k
	3P4W	180.000	360.000	900.000	1.80000 k	3.60000 k	9.00000 k
300.000 V	1P2W	120.000	240.000	600.000	1.20000 k	2.40000 k	6.00000 k
	1P3W, 3V3A 3P3W (2M, 3M)	240.000	480.000	1.20000 k	2.40000 k	4.80000 k	12.0000 k
	3P4W	360.000	720.000	1.80000 k	3.60000 k	7.20000 k	18.0000 k
600.000 V	1P2W	240.000	480.000	1.20000 k	2.40000 k	4.80000 k	12.0000 k
	1P3W, 3V3A 3P3W (2M, 3M)	480.000	960.000	2.40000 k	4.80000 k	9.60000 k	24.0000 k
	3P4W	720.000	1.44000 k	3.60000 k	7.20000 k	14.4000 k	36.0000 k
1.50000 kV	1P2W	600.000	1.20000 k	3.00000 k	6.00000 k	12.0000 k	30.0000 k
	1P3W, 3V3A 3P3W (2M, 3M)	1.20000 k	2.40000 k	6.00000 k	12.0000 k	24.0000 k	60.0000 k
	3P4W	1.80000 k	3.60000 k	9.00000 k	18.0000 k	36.0000 k	90.0000 k

Units are as follows: for active power (P), W; for apparent power (S), VA; and for reactive power (Q), var.  
 Multiply the figures given in this table by 1/10 if using a 2 A sensor, by 10 if using a 200 A sensor, or by 100 if using a 2 kA sensor.

**(2) With 50 A sensor**

Voltage/connection/current		1.00000 A	2.00000 A	5.00000 A	10.0000 A	20.0000 A	50.0000 A
6.00000 V	1P2W	6.00000	12.0000	30.0000	60.0000	120.000	300.000
	1P3W, 3V3A 3P3W (2M, 3M)	12.0000	24.0000	60.0000	120.000	240.000	600.000
	3P4W	18.0000	36.0000	90.0000	180.000	360.000	900.000
15.0000 V	1P2W	15.0000	30.0000	75.0000	150.000	300.000	750.000
	1P3W, 3V3A 3P3W (2M, 3M)	30.0000	60.0000	150.000	300.000	600.000	1.50000 k
	3P4W	45.0000	90.0000	225.000	450.000	900.000	2.25000 k
30.0000 V	1P2W	30.0000	60.0000	150.000	300.000	600.000	1.50000 k
	1P3W, 3V3A 3P3W (2M, 3M)	60.0000	120.000	300.000	600.000	1.20000 k	3.00000 k
	3P4W	90.0000	180.000	450.000	900.000	1.80000 k	4.50000 k
60.0000 V	1P2W	60.0000	120.000	300.000	600.000	1.20000 k	3.00000 k
	1P3W, 3V3A 3P3W (2M, 3M)	120.000	240.000	600.000	1.20000 k	2.40000 k	6.00000 k
	3P4W	180.000	360.000	900.000	1.80000 k	3.60000 k	9.00000 k
150.000 V	1P2W	150.000	300.000	750.000	1.50000 k	3.00000 k	7.50000 k
	1P3W, 3V3A 3P3W (2M, 3M)	300.000	600.000	1.50000 k	3.00000 k	6.00000 k	15.0000 k
	3P4W	450.000	900.000	2.25000 k	4.50000 k	9.00000 k	22.5000 k
300.000 V	1P2W	300.000	600.000	1.50000 k	3.00000 k	6.00000 k	15.0000 k
	1P3W, 3V3A 3P3W (2M, 3M)	600.000	1.20000 k	3.00000 k	6.00000 k	12.0000 k	30.0000 k
	3P4W	900.000	1.80000 k	4.50000 k	9.00000 k	18.0000 k	45.0000 k
600.000 V	1P2W	600.000	1.20000 k	3.00000 k	6.00000 k	12.0000 k	30.0000 k
	1P3W, 3V3A 3P3W (2M, 3M)	1.20000 k	2.40000 k	6.00000 k	12.0000 k	24.0000 k	60.0000 k
	3P4W	1.80000 k	3.60000 k	9.00000 k	18.0000 k	36.0000 k	90.0000 k
1.50000 kV	1P2W	1.50000 k	3.00000 k	7.50000 k	15.0000 k	30.0000 k	75.0000 k
	1P3W, 3V3A 3P3W (2M, 3M)	3.00000 k	6.00000 k	15.0000 k	30.0000 k	60.0000 k	150.000 k
	3P4W	4.50000 k	9.00000 k	22.5000 k	45.0000 k	90.0000 k	225.000 k

Units are as follows: for active power (P), W; for apparent power (S), VA; and for reactive power (Q), var.

Multiply the figures given in this table by 1/10 if using a 5 A sensor, by 10 if using a 500 A sensor, or by 100 if using a 5 kA sensor.

**(3) With 1 kA sensor**

Voltage/connection/current		20.0000 A	40.0000 A	100.000 A	200.000 A	400.000 A	1.00000 kA
6.00000 V	1P2W	120.000	240.000	600.000	1.20000 k	2.40000 k	6.00000 k
	1P3W, 3V3A 3P3W (2M, 3M)	240.000	480.000	1.20000k	2.40000 k	4.80000 k	12.0000 k
	3P4W	360.000	720.000	1.80000 k	3.60000 k	7.20000 k	18.0000 k
15.0000 V	1P2W	300.000	600.000	1.50000 k	3.00000 k	6.00000 k	15.0000 k
	1P3W, 3V3A 3P3W (2M, 3M)	600.000	1.20000 k	3.00000 k	6.00000 k	12.0000 k	30.0000 k
	3P4W	900.000	1.80000 k	4.50000 k	9.00000 k	18.0000 k	45.0000 k
30.0000 V	1P2W	600.000	1.20000 k	3.00000 k	6.00000 k	12.0000 k	30.0000 k
	1P3W, 3V3A 3P3W (2M, 3M)	1.20000 k	2.40000 k	6.00000 k	12.0000 k	24.0000 k	60.0000 k
	3P4W	1.80000 k	3.60000 k	9.00000 k	18.0000 k	36.0000 k	90.0000 k
60.0000 V	1P2W	1.20000 k	2.40000 k	6.00000 k	12.0000 k	24.0000 k	60.0000 k
	1P3W, 3V3A 3P3W (2M, 3M)	2.40000 k	4.80000 k	12.0000 k	24.0000 k	48.0000 k	120.000 k
	3P4W	3.60000 k	7.20000k	18.0000 k	36.0000 k	72.0000 k	180.000 k
150.000 V	1P2W	3.00000 k	6.00000 k	15.0000 k	30.0000 k	60.0000 k	150.000 k
	1P3W, 3V3A 3P3W (2M, 3M)	6.00000 k	12.0000 k	30.0000 k	60.0000 k	120.000 k	300.000 k
	3P4W	9.00000 k	18.0000 k	45.0000 k	90.0000 k	180.000 k	450.000 k
300.000 V	1P2W	6.00000 k	12.0000 k	30.0000 k	60.0000 k	120.000 k	300.000 k
	1P3W, 3V3A 3P3W (2M, 3M)	12.0000 k	24.0000 k	60.0000 k	120.000 k	240.000 k	600.000 k
	3P4W	18.0000 k	36.0000 k	90.0000 k	180.000 k	360.000 k	900.000 k
600.000 V	1P2W	12.0000 k	24.0000 k	60.0000 k	120.000 k	240.000 k	600.000 k
	1P3W, 3V3A 3P3W (2M, 3M)	24.0000 k	48.0000 k	120.000 k	240.000 k	480.000 k	1.20000 M
	3P4W	36.0000 k	72.0000 k	180.000 k	360.000 k	720.000 k	1.80000 M
1.50000 kV	1P2W	30.0000 k	60.0000 k	150.000 k	300.000 k	600.000 k	1.50000 M
	1P3W, 3V3A 3P3W (2M, 3M)	60.0000 k	120.000 k	300.000 k	600.000 k	1.20000 M	3.00000 M
	3P4W	90.0000 k	180.000 k	450.000 k	900.000 k	1.80000 M	4.50000 M

Units are as follows: for active power (P), W; for apparent power (S), VA; and for reactive power (Q), var.

## 10.5 Calculation Formula Specifications

### Calculation formulas for basic measurement parameters

Connection setting / Parameter	1P2W	1P3W	3P3W2M	3V3A	3P3W3M	3P4W
Voltage RMS value	$U_{rms(i)} = \sqrt{\frac{1}{M} \sum_{s=0}^{M-1} (U_{(i)s})^2}$	$= \frac{1}{2} (U_{rms(i)} + U_{rms(i+1)})$		$U_{rms_{123}} = \frac{1}{3} (U_{rms_1} + U_{rms_2} + U_{rms_3})$ $U_{rms_{456}} = \frac{1}{3} (U_{rms_4} + U_{rms_5} + U_{rms_6})$		
Voltage average value rectification RMS equivalent	$U_{mn(i)} = \frac{\pi}{2\sqrt{2}} \frac{1}{M} \sum_{s=0}^{M-1}  U_{(i)s} $	$= \frac{1}{2} (U_{mn(i)} + U_{mn(i+1)})$		$U_{mn_{123}} = \frac{1}{3} (U_{mn_1} + U_{mn_2} + U_{mn_3})$ $U_{mn_{456}} = \frac{1}{3} (U_{mn_4} + U_{mn_5} + U_{mn_6})$		
Voltage AC component	$U_{ac(i)} = \sqrt{(U_{rms(i)})^2 - (U_{dc(i)})^2}$					
Voltage simple average	$U_{dc(i)} = \frac{1}{M} \sum_{s=0}^{M-1} U_{(i)s}$					
Voltage fundamental wave component	Harmonic voltage $U_{1(i)}$ harmonic calculation formula					
Voltage peak	$Upk_{+(i)} = U_{(i)s}$ Maximum value for M data points $Upk_{-(i)} = U_{(i)s}$ Minimum value for M data points					
Total voltage harmonic distortion	$U_{thd(i)}$ harmonic calculation formula					
Voltage ripple factor	$\frac{(Upk_{+(i)} - Upk_{-(i)})}{(2 \times  U_{dc(i)} )} \times 100$					
Voltage phase angle	$\theta U_{1(i)}$ harmonic calculation formula					
Voltage unbalance rate				$U_{unb_{123}} \quad U_{unb_{456}} = \sqrt{\frac{1 - \sqrt{3 - 6\beta}}{1 + \sqrt{3 - 6\beta}}} \times 100$ $\beta = \frac{U_{12}^4 + U_{23}^4 + U_{31}^4}{(U_{12}^2 + U_{23}^2 + U_{31}^2)^2}$ <ul style="list-style-type: none"> <li>• <math>U_{12}</math>, <math>U_{23}</math>, and <math>U_{31}</math> use fundamental wave voltage RMS values (line voltage) from harmonic calculation results.</li> <li>• With 3P4W connections, detected as a phase voltage but converted to a line voltage for calculation purposes.</li> <li>• <math>U_{45}</math>, <math>U_{56}</math>, and <math>U_{64}</math> are used to calculate the <math>\beta</math> value for <math>U_{unb_{456}}</math> instead of <math>U_{12}</math>, <math>U_{23}</math>, and <math>U_{31}</math>, respectively.</li> </ul>		
(i): Measurement channel; M: Number of samples during synchronized timing period; s: Sample point number						

Connection setting Parameter	1P2W	1P3W	3P3W2M	3V3A	3P3W3M	3P4W
Current RMS value	$I_{rms(i)} = \sqrt{\frac{1}{M} \sum_{s=0}^{M-1} (I_{(i)s})^2}$	$= \frac{1}{2} (I_{rms(i)} + I_{rms(i+1)})$		$I_{rms_{123}} = \frac{1}{3} (I_{rms_1} + I_{rms_2} + I_{rms_3})$ $I_{rms_{456}} = \frac{1}{3} (I_{rms_4} + I_{rms_5} + I_{rms_6})$		
Current average value rectification RMS equivalent	$I_{mn(i)} = \frac{\pi}{2\sqrt{2}} \frac{1}{M} \sum_{s=0}^{M-1}  I_{(i)s} $	$= \frac{1}{2} (I_{mn(i)} + I_{mn(i+1)})$		$I_{mn_{123}} = \frac{1}{3} (I_{mn_1} + I_{mn_2} + I_{mn_3})$ $I_{mn_{456}} = \frac{1}{3} (I_{mn_4} + I_{mn_5} + I_{mn_6})$		
Current AC component	$I_{ac(i)} = \sqrt{(I_{rms(i)})^2 - (I_{dc(i)})^2}$					
Current simple average	$I_{dc(i)} = \frac{1}{M} \sum_{s=0}^{M-1} I_{(i)s}$					
Current fundamental wave component	Harmonic current $I_{1(i)}$ harmonic calculation formula					
Current peak	$I_{pk+(i)} = I_{(i)s}$ Maximum value for M data points $I_{pk-(i)} = I_{(i)s}$ Minimum value for M data points					
Total current harmonic distortion	$I_{thd(i)}$ harmonic calculation formula					
Current ripple factor	$\frac{(I_{pk+(i)} - I_{pk-(i)})}{(2 \times  I_{dc(i)} )} \times 100$					
Current phase angle	$\theta_{I_{1(i)}}$ harmonic calculation formula					
Current unbalance rate				$I_{unb_{123}}, I_{unb_{456}} = \sqrt{\frac{1 - \sqrt{3 - 6\beta}}{1 + \sqrt{3 - 6\beta}}} \times 100$ $\beta = \frac{U_{12}^4 + U_{23}^4 + U_{31}^4}{(U_{12}^2 + U_{23}^2 + U_{31}^2)^2}$ <ul style="list-style-type: none"> <li>• <math>I_{12}</math>, <math>I_{23}</math>, and <math>I_{31}</math> use fundamental wave current RMS values (line current) from harmonic calculation results.</li> <li>• With 3P3W3M and 3P4W connections, converted to a line current for calculation purposes.</li> <li>• <math>I_{45}</math>, <math>I_{56}</math>, and <math>I_{64}</math> are used to calculate the <math>\beta</math> value for <math>I_{unb_{456}}</math> instead of <math>I_{12}</math>, <math>I_{23}</math>, and <math>I_{31}</math>, respectively.</li> </ul>		
(i): Measurement channel; M: Number of samples during synchronized timing period; s: Sample point number						



Line setting Parameter	1P2W	1P3W	3P3W2M	3V3A	3P3W3M	3P4W
Active power	$P(i)=\frac{1}{M}\sum_{S=0}^{M-1}(U_{(i)s}\times I_{(i)s})$	$P_{(i)(i+1)}=P_{(i)}+P_{(i+1)}$		$P_{123}=P_1+P_2$ $P_{456}=P_4+P_5$	$P_{123}=P_1+P_2+P_3$ $P_{456}=P_4+P_5+P_6$	
	<ul style="list-style-type: none"> <li>With 3P3W3M and 3P4W connections, the voltage waveform U(i)s uses phase voltage.</li> <li>3P3W3M: <math>U_{1s}=\frac{(U_{1s}-U_{3s})}{3}</math>, <math>U_{2s}=\frac{(U_{2s}-U_{1s})}{3}</math>, <math>U_{3s}=\frac{(U_{3s}-U_{2s})}{3}</math></li> <li>With 3V3A connections, the voltage U(i) uses line voltage. (The 3P3W2M and 3V3A connections use the same calculations.)</li> <li>The polarity sign for active power P indicates the direction of flow: +P during consumption and -P during regeneration.</li> </ul>					
Apparent power	$S_{(i)}=U_{(i)}\times I_{(i)}$	$S_{(i)(i+1)}=S_{(i)}+S_{(i+1)}$	$S_{(i)(i+1)}=\frac{\sqrt{3}}{2}(S_{(i)}+S_{(i+1)})$	$S_{123}=\frac{\sqrt{3}}{3}(S_1+S_2+S_3)$ $S_{456}=\frac{\sqrt{3}}{3}(S_4+S_5+S_6)$	$S_{123}=S_1+S_2+S_3$ $S_{456}=S_4+S_5+S_6$	
	<ul style="list-style-type: none"> <li>U(i) and I(i) are selected from rms/mn.</li> <li>With 3P3W3M and 3P4W connections, the voltage U(i) uses phase voltage.</li> <li>With 3V3A connections, the voltage U(i) uses line voltage.</li> </ul>					
Reactive power	When calculation formula Type 1 or Type 3 is selected					
	$Q_{(i)}=\frac{Q_{(i)}}{\sqrt{S_{(i)}^2-P_{(i)}^2}}$	$Q_{(i)(i+1)}=Q_{(i)}+Q_{(i+1)}$		$Q_{123}=Q_1+Q_2$ $Q_{456}=Q_4+Q_5$	$Q_{123}=Q_1+Q_2+Q_3$ $Q_{456}=Q_4+Q_5+Q_6$	
	When calculation formula Type 2 is selected					
	$Q_{(i)}=\frac{Q_{(i)}}{\sqrt{S_{(i)}^2-P_{(i)}^2}}$	$Q_{(i)(i+1)}=\sqrt{S_{(i)(i+1)}^2-P_{(i)(i+1)}^2}$		$Q_{123}=\sqrt{S_{123}^2-P_{123}^2}$ , $Q_{456}=\sqrt{S_{456}^2-P_{456}^2}$		
<ul style="list-style-type: none"> <li>The polarity sign <i>si</i> for the reactive power Q when calculation formula Type 1 or Type 3 is selected indicates the lead/lag polarity, with no sign indicating lag and a negative sign indicating lead.</li> <li>The polarity sign <i>si(i)</i> is acquired based on the lead/lag relationship between the voltage waveform U(i)s and the current waveform I(i)s for each measurement channel (i).</li> <li>For 3P3W3M and 3P4W connections, the voltage waveform U(i)s uses phase voltage.</li> <li>3P3W3M: <math>U_{1s}=\frac{(U_{1s}-U_{3s})}{3}</math>, <math>U_{2s}=\frac{(U_{2s}-U_{1s})}{3}</math>, <math>U_{3s}=\frac{(U_{3s}-U_{2s})}{3}</math></li> <li>When calculation formula Type 2 is selected, polarity signs are not used.</li> </ul>						
Power factor	When calculation formula Type 1 is selected					
	$\lambda_{(i)}=Si_{(i)}\left \frac{P_{(i)}}{S_{(i)}}\right $	$\lambda_{(i)(i+1)}=Si_{(i)(i+1)}\left \frac{P_{(i)(i+1)}}{S_{(i)(i+1)}}\right $		$\lambda_{123}=Si_{123}\left \frac{P_{123}}{S_{123}}\right $ , $\lambda_{456}=Si_{456}\left \frac{P_{456}}{S_{456}}\right $		
	When calculation formula Type 2 is selected					
	$\lambda_{(i)}=\left \frac{P_{(i)}}{S_{(i)}}\right $	$\lambda_{(i)(i+1)}=\left \frac{P_{(i)(i+1)}}{S_{(i)(i+1)}}\right $		$\lambda_{123}=\left \frac{P_{123}}{S_{123}}\right $ , $\lambda_{456}=\left \frac{P_{456}}{S_{456}}\right $		
When calculation formula Type 3 is selected						
$\lambda_{(i)}=\frac{P_{(i)}}{S_{(i)}}$	$\lambda_{(i)(i+1)}=\frac{P_{(i)(i+1)}}{S_{(i)(i+1)}}$		$\lambda_{123}=\frac{P_{123}}{S_{123}}$ , $\lambda_{456}=\frac{P_{456}}{S_{456}}$			
<ul style="list-style-type: none"> <li>The polarity sign <i>si</i> for power factor <math>\lambda</math> when calculation formula Type 1 is selected indicates the lead/lag polarity, with no sign indicating lag and a negative sign indicating lead.</li> <li>The polarity sign <i>si(i)</i> is acquired based on the lead/lag relationship between the voltage waveform U(i)s and the current waveform I<sub>0s</sub> for each measurement channel (i). The signs <i>si<sub>12</sub></i>, <i>si<sub>34</sub></i>, and <i>si<sub>123</sub></i> are acquired from the Q<sub>12</sub>, Q<sub>34</sub>, and Q<sub>123</sub> signs, respectively.</li> <li>Active power signs are used as-is as polarity signs when calculation formula Type 3 is selected.</li> </ul>						

Calculation Formula Specifications

Line setting Parameter	1P2W	1P3W	3P3W2M	3V3A	3P3W3M	3P4W
Power phase angle	When calculation formula Type 1 is selected					
	$\phi_{(i)}=si_{(i)}\cos^{-1} \lambda_{(i)} $	$\phi_{(i)(i+1)}=si_{(i)(i+1)}\cos^{-1} \lambda_{(i)(i+1)} $	$\phi_{123}=si_{123}\cos^{-1} \lambda_{123} $ $\phi_{456}=si_{456}\cos^{-1} \lambda_{456} $			
	When calculation formula Type 2 is selected					
	$\phi_{(i)}=\cos^{-1} \lambda_{(i)} $	$\phi_{(i)(i+1)}=\cos^{-1} \lambda_{(i)(i+1)} $	$\phi_{123}=\cos^{-1} \lambda_{123} $ $\phi_{456}=\cos^{-1} \lambda_{456} $			
	When calculation formula Type 3 is selected					
	$\phi_{(i)}=\cos^{-1}\lambda_{(i)}$	$\phi_{(i)(i+1)}=\cos^{-1}\lambda_{(i)(i+1)}$	$\phi_{123}=\cos^{-1}\lambda_{123}$ $\phi_{456}=\cos^{-1}\lambda_{456}$			
<ul style="list-style-type: none"> <li>The polarity sign <math>si</math> when calculation formula Type 1 is selected indicates the lead/lag polarity, with no signal indicating lag and a negative sign indicating lead.</li> <li>The polarity sign <math>si_{(i)}</math> is acquired based on the lead/lag relationship between the voltage waveform <math>U_{(i)s}</math> and the current waveform <math>I(i)</math>s for each measurement channel (<math>i</math>). The signs <math>si_{12}</math>, <math>si_{34}</math>, and <math>si_{123}</math> are acquired from the <math>Q_{12}</math>, <math>Q_{34}</math>, and <math>Q_{123}</math> signs, respectively.</li> <li>The expression "<math>\cos^{-1} \lambda_{(i)} </math>" in the Type 1 and Type 2 calculation formulas is used when <math>P \geq 0</math>. When <math>P &lt; 0</math>, the expression "<math> 180 - \cos^{-1} \lambda  </math>" is used.</li> </ul>						
<p>(<math>i</math>): Measurement channel; <math>M</math>: Number of samples during synchronized timing period; <math>s</math>: Sample point number            For 3V3A and 3P3W3M connections, 3P4W formulas are used for <math>\Delta</math>-Y conversion.            The 3P4W formulas are also used as-is for Y-<math>\Delta</math> conversion with 3P4W connections.</p>						

Line setting Parameter	1P2W	1P3W	3P3W2M	3V3A	3P3W3M	3P4W
Fundamental wave active power	$P_{1(i)}$ harmonic active power	$P_{1(i)(i+1)}$ harmonic active power	$P_{1(i)(i+1)(i+2)}$ harmonic active power			
Fundamental wave apparent power	$S_{fnd_{1(i)}} = \sqrt{(P_{1(i)})^2 + (Q_{1(i)})^2}$	$S_{fnd_{1(i)(i+1)}} = \sqrt{(P_{1(i)(i+1)})^2 + (Q_{1(i)(i+1)})^2}$	$S_{fnd_{1(i)(i+1)(i+2)}} = \sqrt{(P_{1(i)(i+1)(i+2)})^2 + (Q_{1(i)(i+1)(i+2)})^2}$			
Fundamental wave reactive power	$Q_{1(i)}$ harmonic reactive power	$Q_{1(i)(i+1)}$ harmonic reactive power	$Q_{1(i)(i+1)(i+2)}$ harmonic reactive power			
Fundamental wave power factor*	$\lambda_{fnd_{1(i)}} = si_{(i)} \cos\theta_{1(i)} $	$\lambda_{fnd_{1(i)(i+1)}} = si_{(i)(i+1)} \cos\theta_{1(i)(i+1)} $	$\lambda_{fnd_{1(i)(i+1)(i+2)}} = si_{(i)(i+1)(i+2)} \cos\theta_{1(i)(i+1)(i+2)} $			
<p>The polarity sign <math>si</math> is acquired based on the sign of the fundamental wave reactive power when using calculation formula Type 1 or based on the sign of the fundamental wave active power when using calculation formula Type 3. No polarity sign is used when calculation formula Type 2 is selected.            *: Fundamental wave power factor is also known as displacement power factor (DPF).</p>						

## Motor analysis option formulas

Measurement parameter	Setting	Formula
Voltage	Analog DC	$\frac{1}{M} \sum_{s=0}^{M-1} A_s$ <p><math>M</math>: Number of samples during synchronized timing period;  <math>s</math>: Sample point number</p>
Pulse frequency	Pulse	Pulse frequency
Torque	Analog DC	$\frac{1}{M} \sum_{s=0}^{M-1} A_s \times \text{scaling setting}$ <p><math>M</math>: Number of samples during synchronized timing period;  <math>s</math>: Sample point number</p>
	Frequency	$\frac{(\text{Measurement frequency} - fc \text{ setting}) \times \text{rated torque value}}{fd \text{ setting}}$
RPM	Analog DC	$\frac{1}{M} \sum_{s=0}^{M-1} A_s \times \text{scaling setting}$ <p><math>M</math>: Number of samples during synchronized timing period;  <math>s</math>: Sample point number</p>
	Pulse	$s_i \frac{60 \times \text{pulse frequency}}{\text{Pulse count setting}}$ <p>The polarity sign <math>s_i</math> is acquired based on the A-phase pulse rising/falling edge and the B-phase pulse logic level (high/low) when direction of rotation detection is enabled in single mode.</p>
Motor power		$\text{Torque} \times \frac{2 \times \pi \times \text{RPM}}{60} \times \text{unit coefficient}$ <p>The unit coefficient is 1 if the torque unit is N·m, 1/1000 if mN·m, and 1000 if kN·m.</p>
Slip		$100 \times \frac{2 \times 60 \times \text{input frequency} -  \text{RPM}  \times \text{pole number setting}}{2 \times 60 \times \text{input frequency}}$ <p>The input frequency is selected from f1 to f6.</p>

### Harmonic measurement parameter calculation formulas

Connection setting	1P2W	1P3W	3P3W2M	3V3A	3P3W3M	3P4W
Parameter						
Harmonic voltage	$U_{k(i)} = \sqrt{(U_{kr(i)})^2 + (U_{ki(i)})^2}$					
Harmonic voltage phase angle	$\theta U_{k(i)} = \left( \frac{U_{kr(i)}}{-U_{ki(i)}} \right)$					
Harmonic current	$I_{k(i)} = \sqrt{(I_{kr(i)})^2 + (I_{ki(i)})^2}$					
Harmonic current phase angle	$\theta I_{k(i)} = \left( \frac{I_{kr(i)}}{-I_{ki(i)}} \right)$					
Harmonic active power	$P_{k(i)} = U_{kr(i)} \times I_{kr(i)} + U_{ki(i)} \times I_{ki(i)}$		$P_{k(i)} = \frac{1}{3}(U_{kr(i)} - U_{kr(i+2)}) \times I_{kr(i)} + \frac{1}{3}(U_{ki(i)} - U_{ki(i+2)}) \times I_{ki(i)}$ $P_{k(i+1)} = \frac{1}{3}(U_{kr(i+1)} - U_{kr(i)}) \times I_{kr(i+1)} + \frac{1}{3}(U_{ki(i+1)} - U_{ki(i)}) \times I_{ki(i+1)}$ $P_{k(i+2)} = \frac{1}{3}(U_{kr(i+2)} - U_{kr(i+1)}) \times I_{kr(i+2)} + \frac{1}{3}(U_{ki(i+2)} - U_{ki(i+1)}) \times I_{ki(i+2)}$			Same as 1P2W
	--	$P_{k(i)(i+1)} = P_{k(i)} + P_{k(i+1)}$	$P_{k(i)(i+1)(i+2)} = P_{k(i)} + P_{k(i+1)} + P_{k(i+2)}$			
Harmonic reactive power (Used in internal calculations only)	$Q_{k(i)} = U_{kr(i)} \times I_{ki(i)} - U_{ki(i)} \times I_{kr(i)}$		$Q_{k(i)} = \frac{1}{3}(U_{kr(i)} - U_{kr(i+2)}) \times I_{ki(i)} - \frac{1}{3}(U_{ki(i)} - U_{ki(i+2)}) \times I_{kr(i)}$ $Q_{k(i+1)} = \frac{1}{3}(U_{kr(i+1)} - U_{kr(i)}) \times I_{ki(i+1)} - \frac{1}{3}(U_{ki(i+1)} - U_{ki(i)}) \times I_{kr(i+1)}$ $Q_{k(i+2)} = \frac{1}{3}(U_{kr(i+2)} - U_{kr(i+1)}) \times I_{ki(i+2)} - \frac{1}{3}(U_{ki(i+2)} - U_{ki(i+1)}) \times I_{kr(i+2)}$			Same as 1P2W
	--	$Q_{k(i)(i+1)} = Q_{k(i)} + Q_{k(i+1)}$	$Q_{k(i)(i+1)(i+2)} = Q_{k(i)} + Q_{k(i+1)} + Q_{k(i+2)}$			
Harmonic voltage/current phase difference	$\theta_{k(i)} = \theta I_{k(i)} - \theta U_{k(i)}$					
	--	$\theta_{k(i)(i+1)} = \tan^{-1} \left( \frac{Q_{k(i)(i+1)}}{P_{k(i)(i+1)}} \right)$	$\theta_{k(i)(i+1)(i+2)} = \tan^{-1} \left( \frac{Q_{k(i)(i+1)(i+2)}}{P_{k(i)(i+1)(i+2)}} \right)$			
<ul style="list-style-type: none"> <li>• (i): Measurement channel; k: Analysis order; r: Post-FFT real part; i: Post-FFT imaginary part</li> <li>• The fundamental wave of the harmonic synchronization source that serves as the phase reference is corrected to 0° for the harmonic voltage phase angle and harmonic current phase angle. (However, this compensation is not performed when the harmonic synchronization source is "Ext.") When the synchronization source is DC, the data update timing is used as 0°. When the synchronization source is "Ext," "Zph.," "CH C," or "CH D," the rising edge of the pulse being synchronized is used as 0° (with harmonic AAF group delay compensation).</li> <li>• The harmonic voltage/current phase difference for each phase when using a 3P3W3M or 3P4W connection is calculated based on the phase voltage, regardless of whether delta conversion is on or off.</li> </ul>						

Connection setting	1P2W	1P3W	3P3W2M	3V3A	3P3W3M	3P4W
Parameter						
Harmonic voltage content percentage	$Uhd_{k(i)} = \frac{U_k}{U_1} \times 100$					
Harmonic current content percentage	$Ihd_{k(i)} = \frac{I_k}{I_1} \times 100$					
Harmonic power content percentage	$Phd_{k(i)} = \frac{P_k}{P_1} \times 100$					
Total harmonic voltage distortion	$Uthd_{(i)} = \frac{\sqrt{\sum_{k=2}^K (U_k)^2}}{U_1} \times 100$ (with THD-F setting) or $\frac{\sqrt{\sum_{k=2}^K (U_k)^2}}{\sqrt{\sum_{k=1}^K (U_k)^2}} \times 100$ (with THD-R setting)					
Total harmonic current distortion	$Ithd_{(i)} = \frac{\sqrt{\sum_{k=2}^K (I_k)^2}}{I_1} \times 100$ (with THD-F setting) or $\frac{\sqrt{\sum_{k=2}^K (I_k)^2}}{\sqrt{\sum_{k=1}^K (I_k)^2}} \times 100$ (with THD-R setting)					
(i): Measurement channel; k: Harmonic order; K: Maximum analysis order (varies with synchronization frequency)						

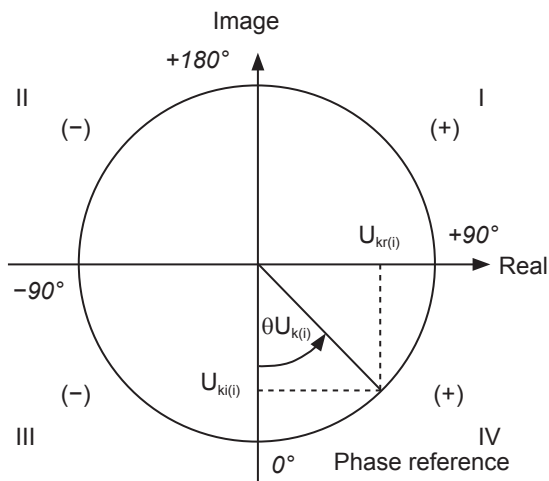

Example: For harmonic voltage

I	$\tan^{-1} \left( \frac{U_{kr(i)}}{-U_{ki(i)}} \right) + 180^\circ$
III, IV	$\tan^{-1} \left( \frac{U_{kr(i)}}{-U_{ki(i)}} \right)$
II	$\tan^{-1} \left( \frac{U_{kr(i)}}{-U_{ki(i)}} \right) - 180^\circ$
$U_{ki(i)} = 0, U_{kr(i)} < 0$	$-90^\circ$
$U_{ki(i)} = 0, U_{kr(i)} > 0$	$+90^\circ$
$U_{ki(i)} < 0, U_{kr(i)} = 0$	$0^\circ$
$U_{ki(i)} = 0, U_{kr(i)} = 0$	$0^\circ$
$U_{ki(i)} > 0, U_{kr(i)} = 0$	$+180^\circ$

## Connection specifications

### 1-phase/2-wire (1P2W)

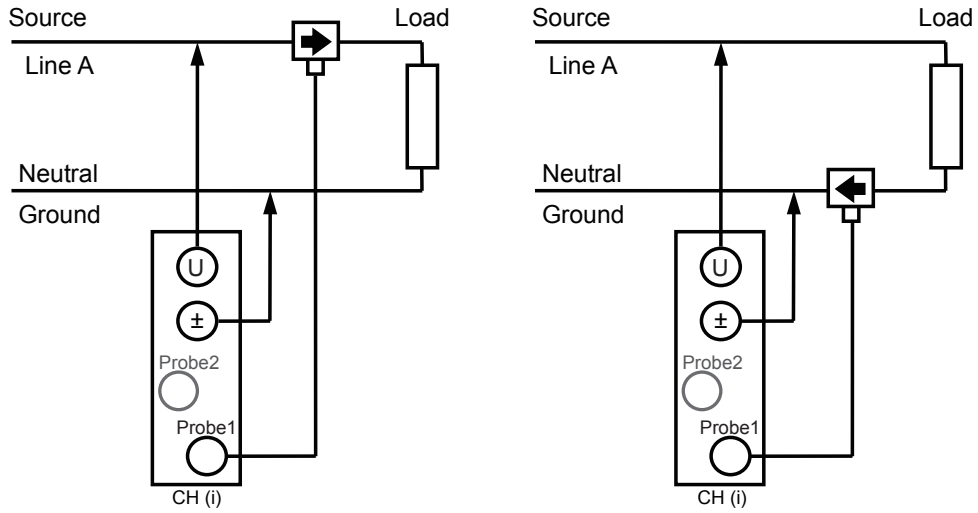

### 1-phase/3-wire (1P3W)

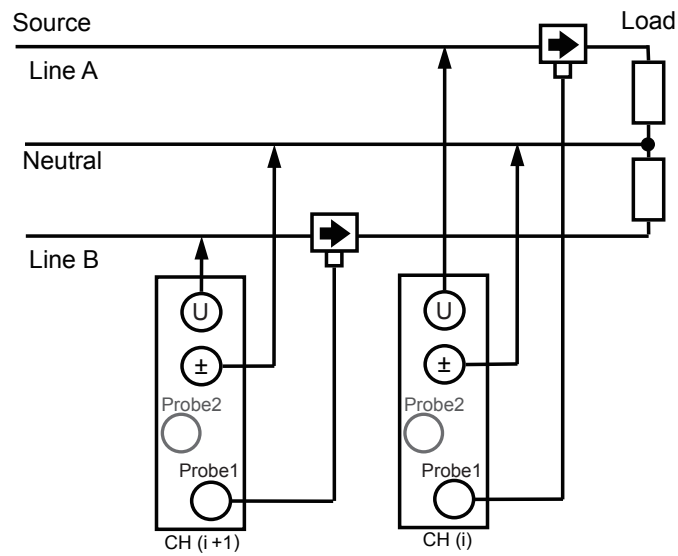

**3-phase/3-wire (3P3W2M)**

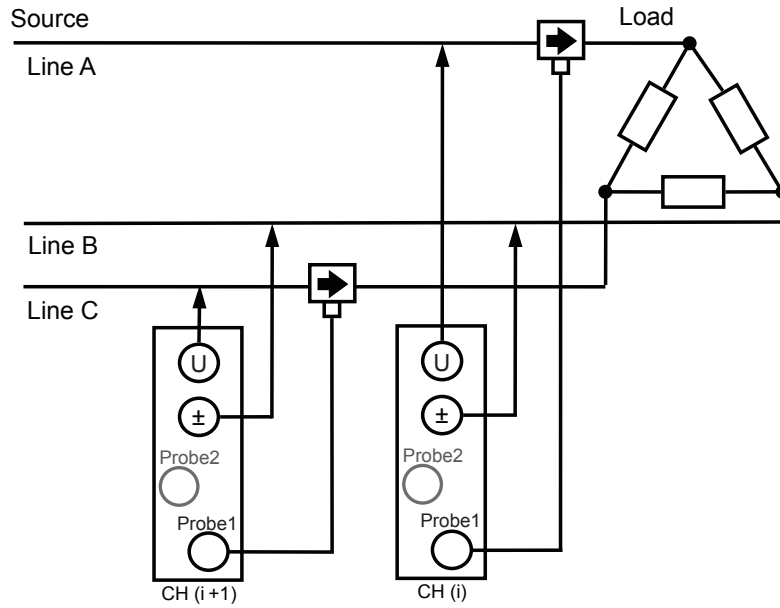

**3-phase/3-wire (3V3A)**

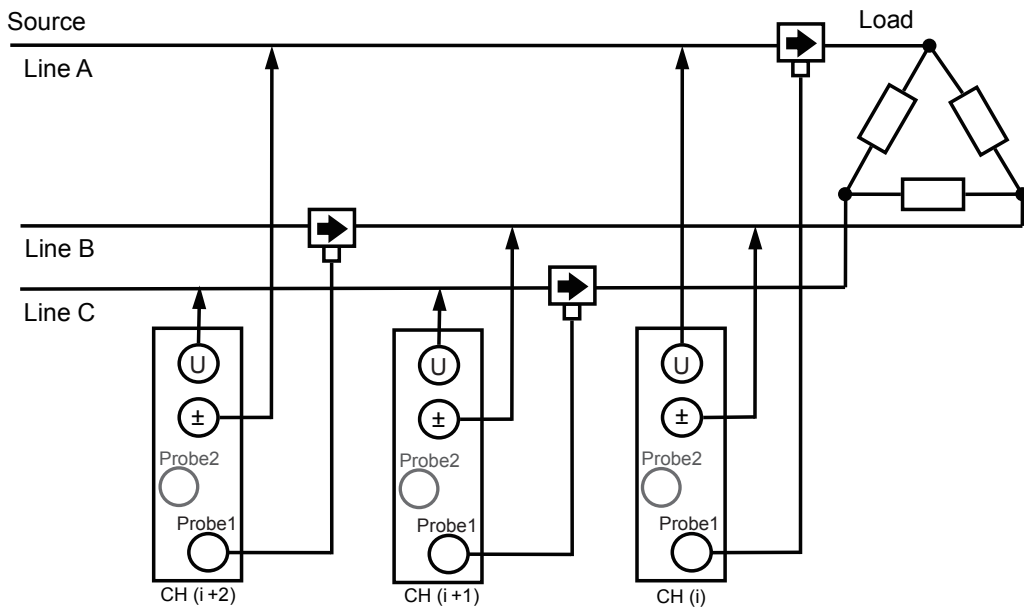

### 3-phase/3-wire (3P3W3M)

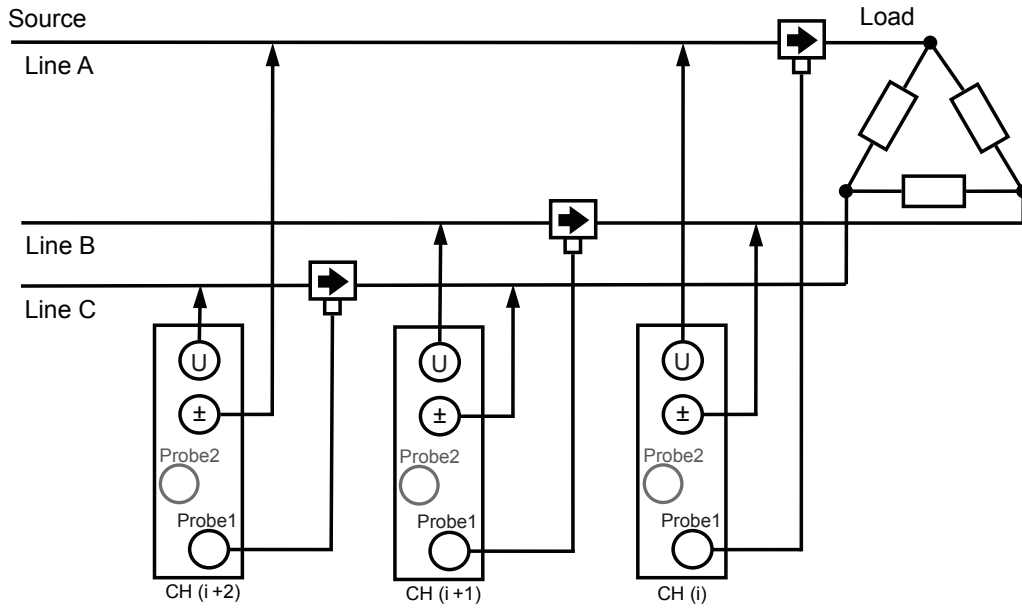

### 3-phase/4-wire (3P4W)

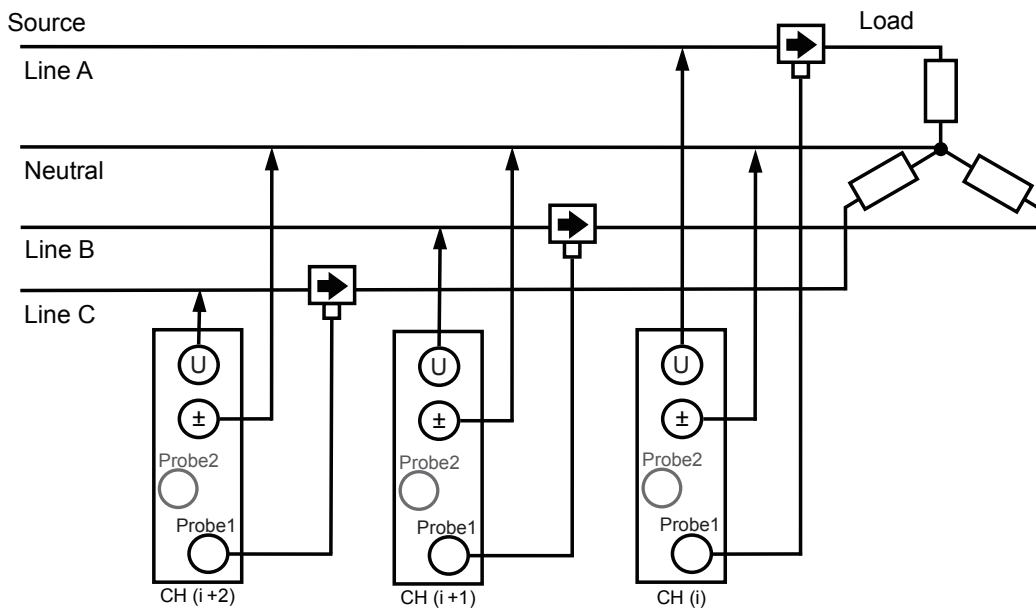



**Block diagram**

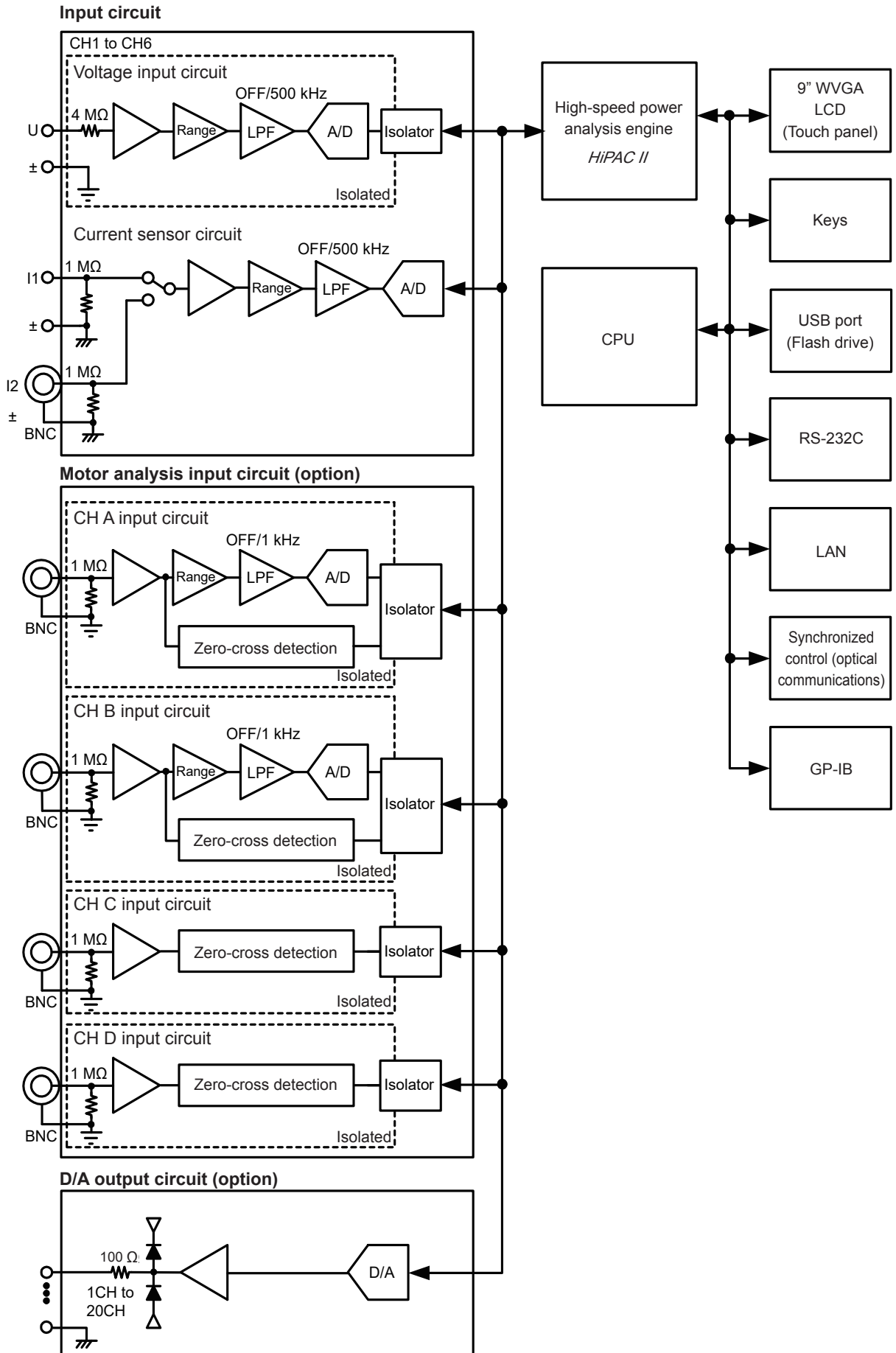

**Calculating combined accuracy (when the PW6001 instrument and sensor combined accuracy is not defined)**

Measurement accuracy for active power is determined by adding the accuracy of the current sensor being used to the instrument's accuracy.

rdg. accuracy = Active power rdg. accuracy + sensor rdg. accuracy

f.s. accuracy = Active power f.s. accuracy + (senor rating/current range) × sensor f.s. accuracy

Example	Sensor	CT6862 (50 A rating), accuracy of ±0.05% rdg. ±0.01% f.s.
	Instrument settings	Connection: 1P2W Voltage range: 600 V Current range: 10 A Power range: 6.00000 kW, accuracy of ±0.02% rdg. ±0.03% f.s.
	Measurement target	400 V, 5 A, 2.00000 kW, 50 Hz

rdg. accuracy = 0.02% + 0.05% = ±0.07% rdg.

f.s. accuracy = 0.03% + (50 A/10 A) × 0.01% = ±0.08% f.s.

The active power accuracy is ±0.07 rdg. ±0.08% f.s. (6 kW power range is f.s.).

## 11.1 Repairs, Inspections, and Cleaning

Before having the instrument repaired, review the information provided in “Before having your instrument repaired” (p.257) and “Error Displays” (p.259).

### Calibration

**IMPORTANT**

Regular calibration is required in order to ensure the instrument will yield measurement results at the specified degree of accuracy.

The calibration interval varies with factors such as the conditions and environment of use. It is recommended to determine an appropriate calibration interval based on the conditions and environment in which you use the instrument and have Hioki calibrate it regularly based on that interval.

### Cleaning

- If the instrument becomes dirty, moisten a soft cloth with water or a neutral detergent and gently wipe it clean.
- Wipe the instrument's display gently with a soft, dry cloth.
- To prevent the instrument's air vents from becoming obstructed, clean them regularly. If the vents become blocked, their ability to cool the inside of the instrument will be reduced, causing the instrument to malfunction.

**IMPORTANT**

Never use cleaners that contain benzene, alcohol, acetone, ether, ketones, thinners, or gasoline. Doing so may cause distortion or discoloration of the instrument's enclosure.

## Repairs and inspections

If you feel that the instrument may be malfunctioning, contact your authorized Hioki distributor or reseller after reviewing the information provided in “12 Troubleshooting”(p.257). In the event of any of the conditions listed at the bottom of this page, halt use immediately, unplug the instrument, and contact your authorized Hioki distributor or reseller.

### **WARNING**



**Touching any of the high-voltage points inside the instrument is very dangerous. Customers are not allowed to modify, disassemble, or repair the instrument. Doing so may cause fire, electric shock, or injury.**

### **CAUTION**



- If the protective functions of the instrument are damaged, either remove it from service or mark it clearly so that others do not use it inadvertently.
- The instrument contains a built-in backup lithium battery, which offers a service life of about ten years. If the date and time deviate substantially when the instrument is switched on, it is the time to replace that battery. Contact your authorized Hioki distributor or reseller.

#### **IMPORTANT (Halt use in the event of the following conditions.)**

- If the instrument is clearly damaged
- If the instrument is not capable of measurement
- If the instrument has been stored for an extended period of time in an undesirable environment, for example under conditions of high temperature and humidity
- If the instrument has been subjected to stress due to shipment under harsh conditions
- If the instrument is wet or soiled with a large amount of oil or dust  
(If the instrument gets wet or oil and dust get inside it, internal insulation may deteriorate, posing a significant risk of electric shock or fire.)
- If the instrument is unable to save measurement conditions

## 11.2 Disposing of the Instrument

- To dispose of the instrument, remove the lithium battery and follow all applicable rules and regulations in the region of use.
- Dispose of all optional accessories in accordance with applicable instructions.

### WARNING



- To avoid electric shock, turn off the power switch and disconnect the power cord and measurement cable before removing the lithium battery.
- Battery may explode if mistreated. Do not short-circuit, recharge, disassemble or dispose of in fire.
- Keep batteries away from children to prevent accidental swallowing.

### Removing the lithium battery

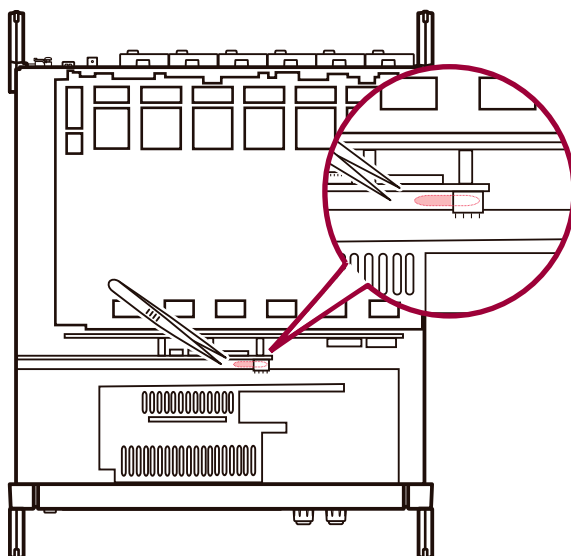
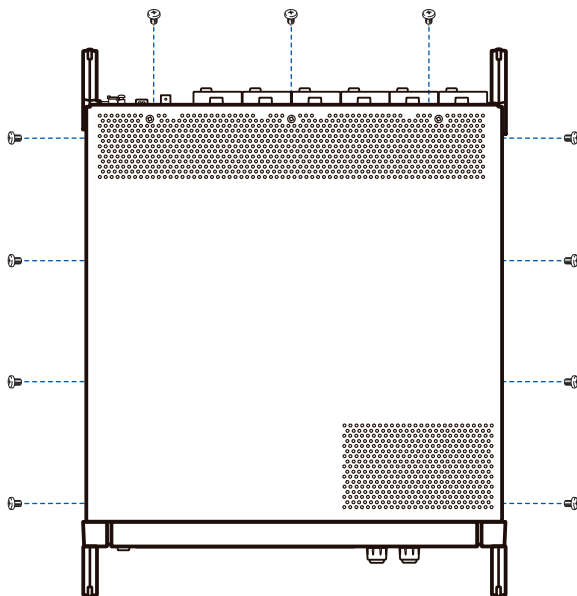

#### Necessary tools

- Phillips head screwdriver (No. 2) ×1
- Pair of tweezers ×1

- 1** Turn off the instrument's power switch.
- 2** Unplug current sensors, voltage cords, the power cord, and any other cords or cables.
- 3** Using the Phillips head screwdriver, remove the 11 screws that hold the top cover in place.
- 4** Lift up on the back of the top cover to remove it.
- 5** Remove the FPC from the circuit board.
- 6** Insert the tip of the tweezers between the battery holder on the internal circuit board and the battery and lift up on the battery to remove it.

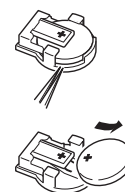

#### CALIFORNIA, USA ONLY

This product contains a CR Coin Lithium Battery which contains Perchlorate Material - special handling may apply. See [www.dtsc.ca.gov/hazardouswaste/perchlorate](http://www.dtsc.ca.gov/hazardouswaste/perchlorate)

## 11.3 Replacement Parts and Their Service Lives

### Replacement parts and their service lives

Some of the parts used in the product will exhibit degraded characteristics with use over an extended period of time. Regular replacement of these parts is recommended to ensure your ability to use the product indefinitely. When replacing a part, please contact your authorized Hioki distributor or reseller. The service life of parts varies with the operating environment and frequency of use. The recommended replacement interval does not constitute a guarantee.

Part	Service life	Remarks and conditions
<b>Electrolytic capacitors</b>	About 10 years	The circuit board on which the parts in question are mounted must be replaced.
<b>LCD backlight (Service life: Based on deterioration to half initial level of brightness)</b>	About 8 years	When used for 24 hours per day
<b>Fan motor</b>	About 10 years	When used for 24 hours per day
<b>Backup battery</b>	About 10 years	If the time and date are off significantly when the instrument is turned on, the battery should be replaced.
<b>Opto-isolation elements</b>	About 5 to 10 years	When used for 24 hours per day
<b>Optical connection cables and connectors</b>	About 10 years	When used for 24 hours per day

### Replacing the fuse

The instrument's power supply includes a fuse. If you are unable to turn on the instrument, this fuse may have blown. Please contact your authorized Hioki distributor or reseller as the fuse cannot be replaced or repaired by the user.

# 12 Troubleshooting

## 12.1 Frequently Asked Questions

- If you believe the instrument may be malfunctioning or broken, see “Before having your instrument repaired” below as well as “Error Displays” (p.259). If unable to resolve the issue, please contact your authorized Hioki distributor or reseller.
- If the instrument fails to display a measured value even when the probe is shorted, the fuse may have blown. The fuse cannot be replaced or repaired by the customer. Please contact your authorized Hioki distributor or reseller.

### Before having your instrument repaired

Check the following items before having your instrument repaired:

Issue	Check items or cause	Solution and where to find additional information
<b>Nothing is shown on the screen when the power switch is turned on.</b>	Is the power cord connected to the instrument? Is the power cord connected properly?	Verify that the power cord is connected properly. See “2.3 Connecting the Power Cord” (p.37).
<b>The keys do not do anything.</b>	Is the instrument in the key-lock state?	Press and hold the <b>[REMOTE/LOCAL]</b> key for at least 3 seconds to cancel the key-lock state.
<b>The screen does not react when the touch panel is touched.</b>	<ul style="list-style-type: none"> <li>• Is the instrument in the key-lock state?</li> <li>• Is there dust or other foreign material between the instrument and the touch panel?</li> </ul>	<ul style="list-style-type: none"> <li>• Press and hold the <b>[REMOTE/LOCAL]</b> key for at least 3 seconds to cancel the key-lock state</li> <li>• Remove the dust or other foreign material. See “Cleaning” (p.253).</li> </ul>
<b>The touch panel responds to a different position than the one that was touched.</b>	The touch panel may be misaligned.	Align the touch panel. See “Correcting the touch panel” (p.138).
<b>The instrument’s settings cannot be changed.</b>	Is the instrument performing integration or stopped while performing integration?	Perform an integration value reset (data reset). See “3.3 Viewing Integration Values” (p.65).
<b>The voltage or current measured value is not displayed.</b>	Are the voltage cords and current sensors connected properly?	Check the connections and wiring. See “2 Preparing for Measurement”(p.35).
	Do the input channel and display channel match? (For example, this issue would arise if the input channel were set to CH1 while a page other than the <b>CH1</b> page was being displayed.)	Change the input channel page using the <b>[◀]</b> and <b>[▶]</b> keys. See “3.2 Viewing Power Measured Values and Changing Measurement Conditions” (p.54).
<b>The active power is not displayed.</b>	Have the voltage and current range settings and the zero-suppression settings been configured properly?	Set the voltage and current ranges properly. If the input is low relative to the range, set zero-suppression to 0.1% or “off.” See “Setting the ranges” (p.55), “Changing System Settings” (p.137).

Issue	Check items or cause	Solution and where to find additional information
<b>Frequency cannot be measured, or measured values are unstable.</b>	Is the input frequency within the range of 0.1 Hz to 2 MHz?	Check the frequency by viewing the input waveform. See “4 Viewing Waveforms”(p.95).
	Is the input frequency lower than the setting?	Set the measurement lower limit frequency setting. See “Configuring frequency measurement” (p.62).
	Is the synchronization source input correct? Is the synchronization source input range too large?	Check the synchronization source setting. See “Setting the synchronization source” (p.60), “Setting the ranges” (p.55).
	Is the measurement target a waveform with a large amount of distortion, for example a PWM waveform?	Set the zero-cross filter to “strong.” See “ZC Filter” (p.103).
<b>Three-phase voltage measurement results are low.</b>	Are you measuring the common-mode voltage with the $\Delta$ -Y conversion function?	Turn off the $\Delta$ -Y conversion function. See “ $\Delta$ -Y conversion” (p.124).
<b>Power measured values are anomalous.</b>	Is the instrument connected properly?	Check the instrument’s connections. See “Verifying Proper Connections (Connection Check)” (p.49).
	Have the rectifier and LPF settings been configured properly?	Set the rectifier properly. If the LPF is enabled, set it to “off.” See “Setting the rectifier” (p.64), “Setting the low-pass filter (LPF)” (p.61).
<b>The current reading never falls to zero even when receiving zero-input.</b>	Are you using a low current range with a Universal Clamp On CT? The current sensor’s high-frequency noise may be affecting the current reading.	Perform zero-adjustment after setting the LPF to 100 kHz. See “Setting the low-pass filter (LPF)” (p.61), “Connecting the Instrument to the Measurement Lines (Zero-adjustment)” (p.45).
<b>The apparent power, reactive power, and power factor readings on the secondary-side of an inverter differ from measurements obtained using other instruments. Voltage values are higher than expected.</b>	Is the rectifier setting the same as on the other instruments?	Use the same rectifier setting as with the other instruments. See “Setting the rectifier” (p.64).
	The calculation methods may differ.	Use the same calculation methods as with the other instruments.” See “Selecting the Power Calculation Formula” (p.126).
<b>I am unable to measure motor RPM.</b>	Is the pulse output set to voltage output? The instrument cannot detect open collector pulse output.	Set the device to voltage output to match the CH B pulse input setting.
	Does the pulse output contain noise?	Check the cable routing. Ground the encoder that is generating the pulse output. Set the pulse noise filter (PNF) setting. See “Setting the pulse noise filter (PNF)” (p.86).
<b>The data I saved includes one or more large values that exceed the range.</b>	Did a range-over event occur?	Set an appropriate range. See “4.1 Displaying Waveforms” (p.95), “7.11 Measured Value Data Format” (p.159).



## If the cause of your problem remains unclear

Try performing a system reset.  
All settings will be returned to their factory defaults.  
See "Changing System Settings" (p. 137).

## 12.2 Error Displays

- If you believe the instrument may be malfunctioning or broken, see "Before having your instrument repaired" (p.257) as well as "Error Displays." below. If unable to resolve the issue, please contact your authorized Hioki distributor or reseller
- If an error is shown on the display, the instrument needs to be repaired. Please contact your authorized Hioki distributor or reseller.
- Turning on the instrument while the measurement lines are live may damage the instrument or cause an error to be displayed. Always turn the instrument on first and then activate power to the measurement lines once you have verified that no error is being displayed by the instrument.

### Startup errors and operating errors

Error display	Cause	Solution and where to find additional information
FPGA initialization error	The FPGA is unable to boot.	The instrument needs to be repaired. Please contact your authorized Hioki distributor or reseller.
DRAM error	A DRAM error has occurred.	
Unit ID error	An input channel detection error has occurred.	
SRAM error	An SRAM error has occurred.	
Flash sum error	The program flash checksum value is incorrect.	
Adjustment value sum error	The adjustment value checksum value is incorrect.	
Backup error	Backed-up system variables are erroneous and contradict each other.	If this error is displayed in a noise-free environment, the instrument needs to be repaired. Please contact your authorized Hioki distributor or reseller. See "11.3 Replacement Parts and Their Service Lives" (p.256).
Unit error	Noise in excess of the allowable value was applied, or optical isolator element performance may have degraded.	
Fan error	Noise in excess of the allowable value was applied, or fan performance may have degraded.	

### Control errors

Error display	Cause	Solution and where to find additional information
Integration is running. Reset integration.	The operator attempted to change a setting while the instrument was performing integration, was in the integration standby state, or was stopped.	Stop integration and reset the integration value before changing settings. See "3.3 Viewing Integration Values" (p.65).

Error display	Cause	Solution and where to find additional information
Now holding measured values.	The operator attempted to change a setting while the instrument was in the hold state.	Cancel the hold or peak hold state before changing settings.
Now holding measured peak values.	The operator attempted to change a setting while the instrument was in the peak hold state.	See "5.3 Hold and Peak Hold Functions" (p. 119).
Input value out of range. Please check input range and re-enter value.	The operator attempted to set the VT or CT ratio to a value that would cause the limit value for (VT × CT) to be exceeded.	Set the ratio so that the limit value for (VT × CT) (1.0E+06) is not exceeded.
Cannot select the wiring. Different sensors are used in it.	The connection cannot be changed to the selected mode because the sensor combination is incorrect.	Check the current sensor connections. See "2.7 Setting the Connection Mode and Current Sensors" (p. 43).
The number of saved items has exceeded the limit.	When setting the save measurement parameters, the operator attempted to set a number of parameters that would exceed the upper limit on the number of parameters, which is determined by the interval setting.	Use a longer interval time setting. See "5.1 Time Control Function" (p. 115).
The number of saved items has exceeded the limit.	When setting the interval, the operator attempted to set an interval time that would cause the upper limit on the number of recording parameters that can be set to be less than the current number of recording parameters.	Reduce the number of recording parameters. See "7.3 Saving Measurement Data" (p. 144).
Cannot execute screenshot while auto saving.	The operator attempted to save a screenshot while automatic save operation was in progress with an interval setting of less than 1 sec.	Set the interval to 1 sec. or greater, or stop automatic save operation.
Cannot save measured data manually while auto saving.	The operator attempted to save manually while automatic save operation was in progress.	Stop automatic save operation.
Cannot save waveform data while auto saving.	The operator attempted to save waveform while automatic save operation was in progress.	Stop automatic save operation.
Cannot save data while waveform storage is in progress.	The operator attempted to save waveform while storage operation was in progress.	Stop storage operation.
Operating in slave mode.	The operator attempted to change a setting while the instrument was operating as the slave in a two-instrument synchronized setup.	Set two-instrument synchronized control to "off".
Failed in zero adjustment.	After zero-adjustment completed, there was one or more channels or ranges that could not be adjusted.	Check the input level or input frequency.
Cannot perform zero adjustment.	The operator attempted to perform a zero-adjustment while the instrument was performing integration, was in the integration standby state, or was stopped.	Stop integration and reset the integration value before performing zero-adjustment. See "3.3 Viewing Integration Values" (p. 65).
Interlock control has been interrupted.	There was no response from the other instrument during synchronized operation.	Check the other instrument setting or two-instrument synchronization connector's connections.
Input value out of range.	The user attempted to enter a value outside the valid setting range for a setting requiring entry of a number in the numeric keypad window.	Enter a value within the valid setting range.

## USB flash drive and file operation errors

Error display	Cause	Solution and where to find additional information
Failed to load program file for version upgrade.	There was no upgrade file when performing an upgrade, or the upgrade's checksum value was incorrect.	The upgrade file may be corrupt. Re-copy the upgrade file and try the upgrade again.
Inadequate USB flash drive capacity.	File operations cannot be performed due to inadequate USB flash drive capacity.	Delete unneeded files or replace the USB flash drive with a new unit.
Cannot generate a file name automatically.	No additional filenames can be generated automatically.	Specify a different save destination folder or create a new folder and save files to that folder. Alternatively, delete unneeded files or replace the USB flash drive with a new unit. See "7.10 File and Folder Operations" (p. 157).
Please enter file or folder name.	The operator failed to enter a string when entering a filename or folder name.	Enter the filename or folder name.
The name is already taken. Please choose a different name.	A folder with the same name as the file was found when creating a settings file or copying a file from the instrument's internal memory.	Change the name of the file or folder. See "Changing the name of a file or folder" (p. 158).
USB Flash Drive is not found.	No USB flash drive was recognized when saving data.	Check whether a USB flash drive has been inserted. See "7.1 Inserting and Removing USB Flash Drives" (p. 141).
Failed to load setup data. Sensor Config. is different.	The operator loaded a settings file that is not supported.	Settings files cannot be loaded when the combination of options and other devices or save item settings differ from those of the instrument. See "7.9 Loading Settings Data" (p. 156).
Failed to load setup data. Option Config. is different.	The operator loaded a settings file that is not supported.	
Unit Config. is incompatible with the setup data.	The operator loaded a settings file that is not supported.	
Cannot load setup data now.	The operator attempted to load a settings file during integration, hold, or synchronized operation.	Reset integration, cancel hold operation, or turn synchronized control off.
Failed to write data.	The instrument failed to write data to the media during save operation.	Repeat the operation.
Failed to load data.	The instrument failed to load data from the media.	
Unable to create file.	The instrument was unable to create the file.	Repeat the operation.
Unable to create folder.	The instrument was unable to create the folder.	
Firmware version of setup data is incompatible with this inst.	The instrument's firmware version at the time the file was loaded differed from the version at the time the settings file was saved.	Reconfigure the settings.
Checksum error	The settings file is corrupt.	
This USB flash drive is not supported.	The operator attempted to use an unsupported USB flash drive.	Reformat as a FAT32 drive if the file system is not FAT. See "7.1 Inserting and Removing USB Flash Drives" (p. 141).

Error display	Cause	Solution and where to find additional information
Cannot delete the folder. It is not empty.	The operator attempted to delete a folder that contains one or more files or folders.	Delete the files and folders in the folder.
No data in internal memory.	The operator attempted to copy data to the USB flash drive when there was no data in the instrument's internal memory.	Repeat the operation after saving data in the instrument's internal memory.
Cannot access USB flash drive.	USB flash drive operations cannot be performed.	Format the flash drive.
Undefined error	An unexpected error occurred.	If the error condition continues, please contact your authorized Hioki distributor or reseller.

# Appendix

## Appx. 1 Rack-mounting the Instrument

The instrument can be installed using rack-mounting hardware.

### Rack-mounting hardware

#### JIS standard (right-side hardware)

Material: A5052

Thickness: t3

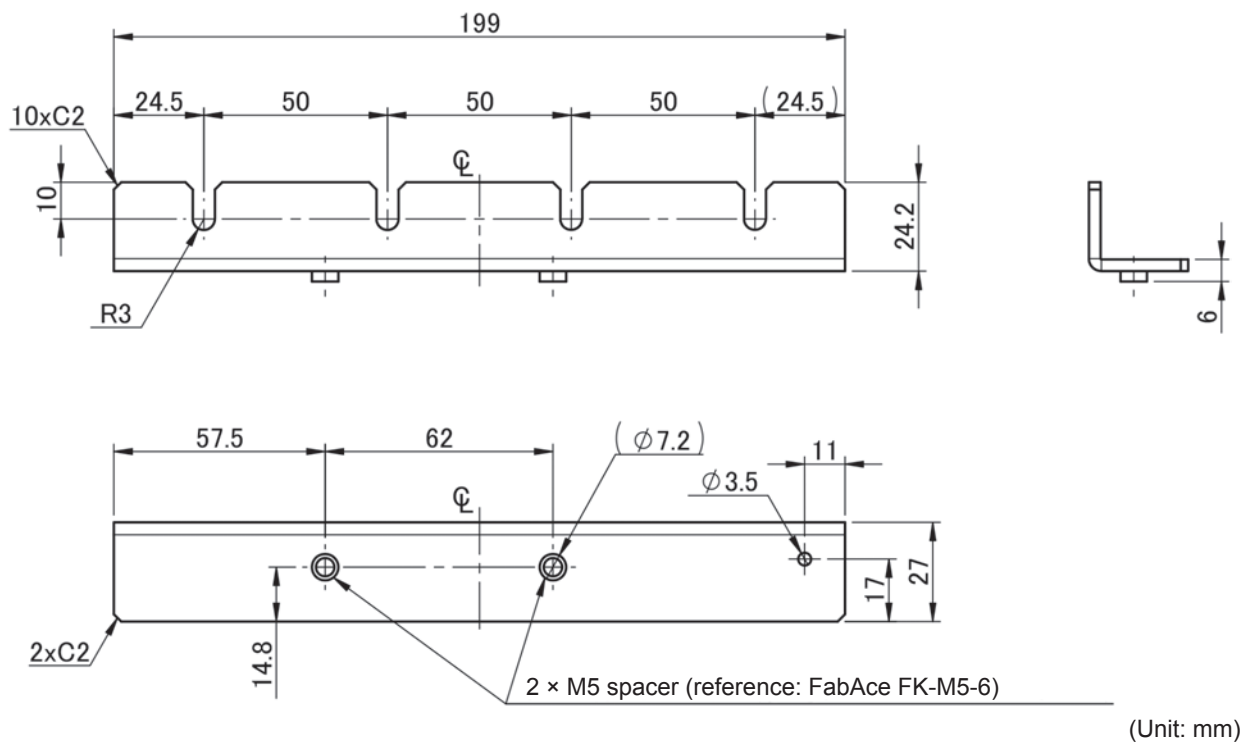

**JIS standard (left-side hardware)**

Material: A5052

Thickness: t3

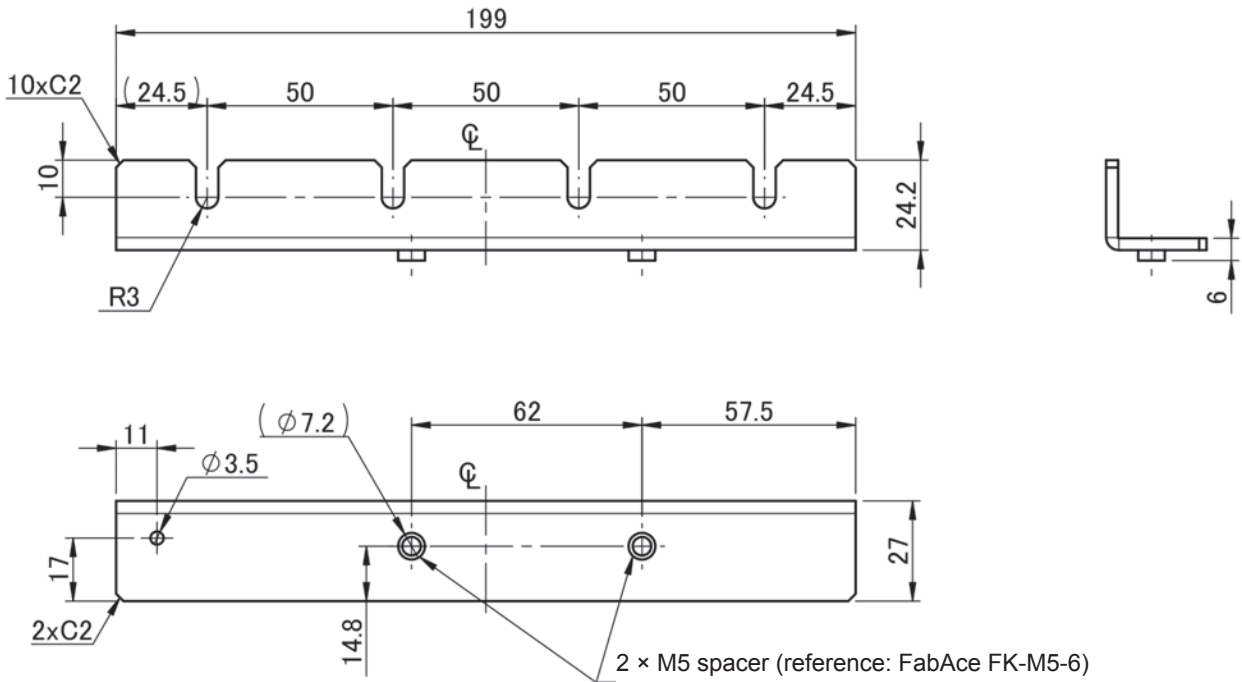

(Unit: mm)

**JIS standard (cosmetic panel)**

Material: A5052

Thickness: t1.6

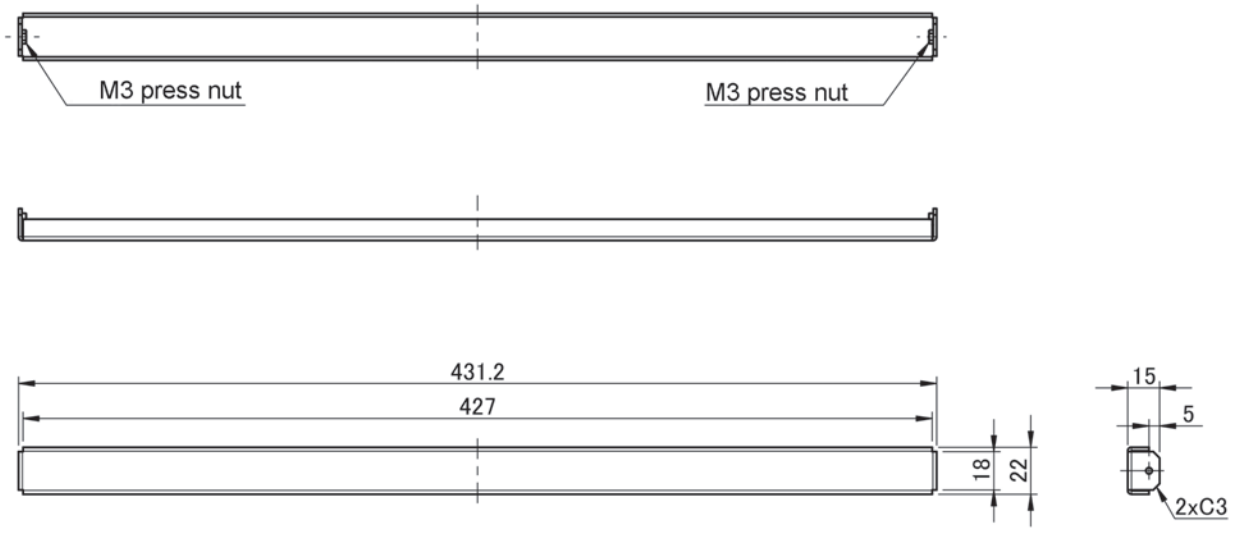

(Unit: mm)

**EIA standard**

Material: A5052

Thickness: t3

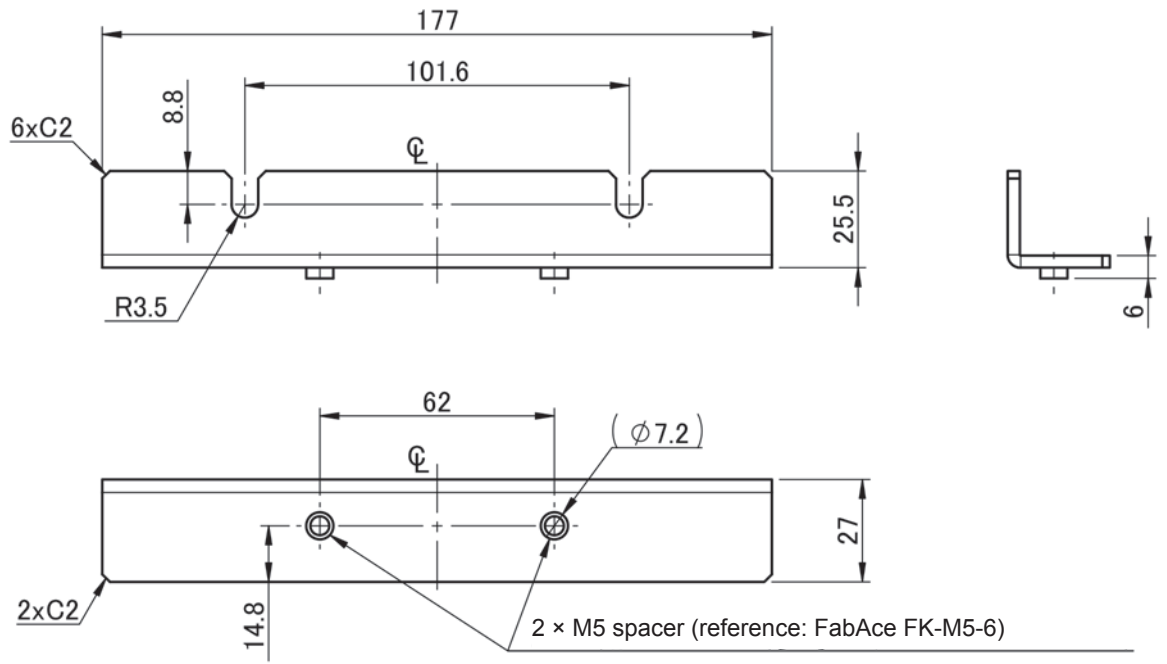

(Unit: mm)

## Installation instructions

### ⚠ WARNING



Use M4 × 14 mm screws to attach the hardware to the PW6001. Using screws longer than 14 mm may damage the instrument's internal components or cause electric shock.



- Reinforce the inside of the rack with commercially available support braces or other parts as appropriate to compensate for the weight of the instrument.
- Leave at least 20 mm of space on every surface other than the underside to keep the instrument's temperature from rising. Leave at least 15 mm of space underneath the instrument (the height of its feet).
- When mounting the instrument in a rack, install so that air can be drawn in through the instrument's air vents (on the top, sides, and bottom).
- If you require M4 × 14 mm screws, please contact your authorized Hioki distributor or reseller.

### JIS

- 1 Verify that the instrument is turned off and disconnect all cables and the power cord.
- 2 Remove the two M4 cap bolts that hold each handle in place.

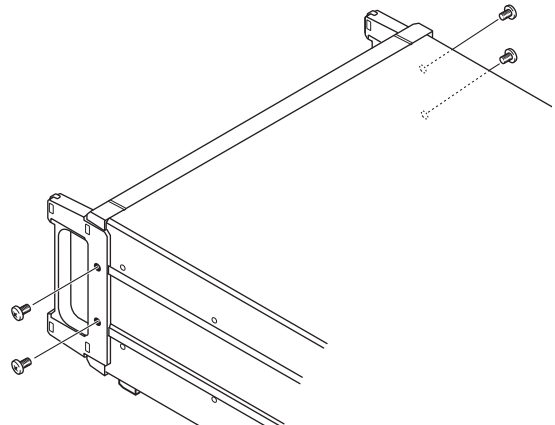

- 3 Attach the rack-mounting hardware (left-/right-side hardware) to the instrument with two M4 × 14 mm screws.

Do not use screws longer than 14 mm.

- 4 Attach the rack-mounting hardware (cosmetic panel) with M3 × 8 mm screws.

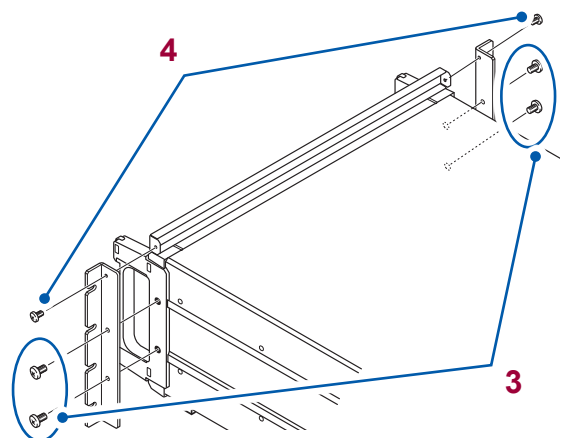



## EIA

- 1 Verify that the instrument is turned off and disconnect all cables and the power cord.
- 2 Remove the two M4 cap bolts that hold each handle in place.

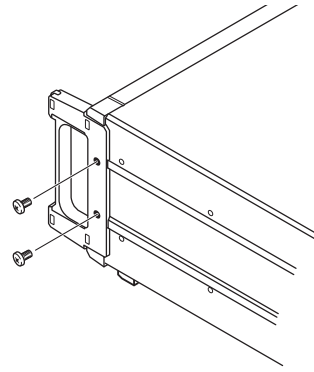

- 3 Attach the rack-mounting hardware (for both sides) to the instrument with two M4 × 14 mm screws.

Do not use screws longer than 14 mm.

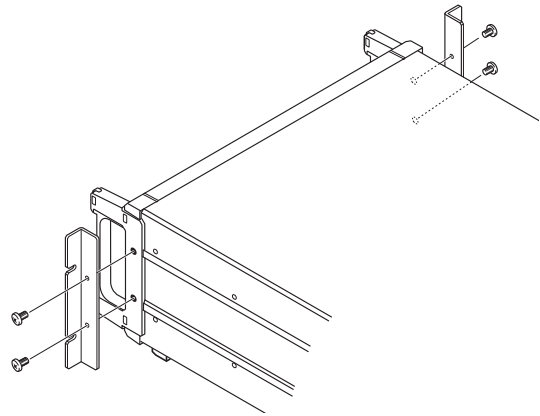

# Appx. 2 Outline Drawings

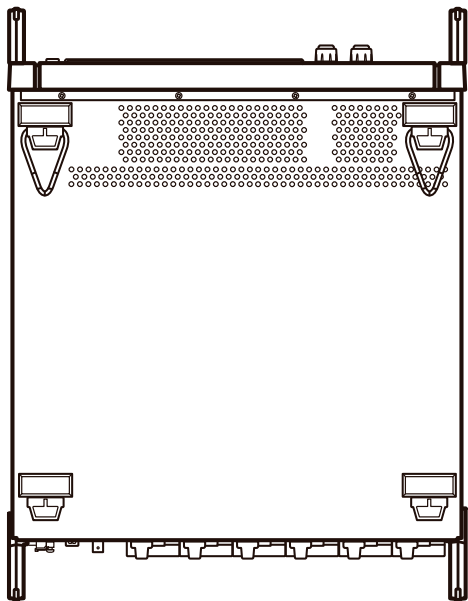
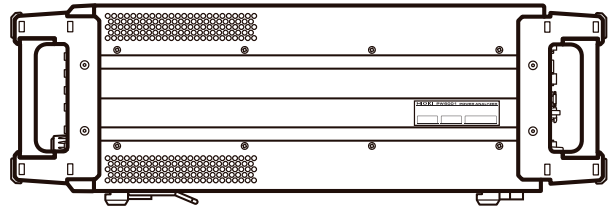
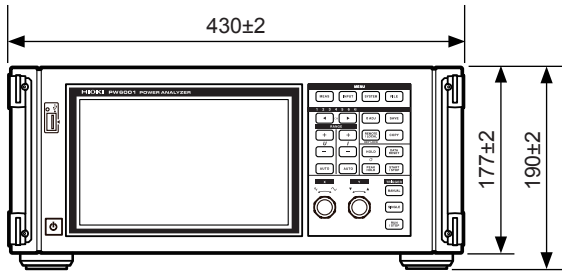
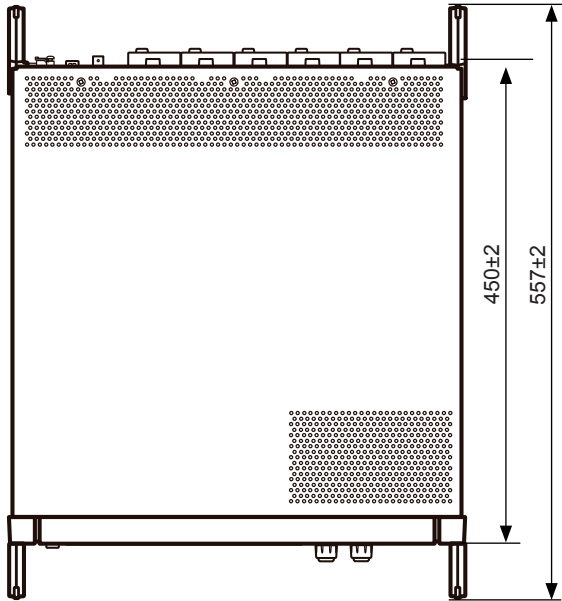

(Unit: mm)

# Index

## Symbol

$\Delta$ -Y conversion ..... 124

## Number

1P2W ..... 43  
1P3W ..... 43  
3P3W2M ..... 43  
3P3W3M ..... 43  
3P4W ..... 43  
3V3A ..... 43

## A

Access Lamp ..... 141  
Accuracy ..... 210  
Actual Time Control ..... 69, 115  
Actual Time Control Time ..... 70  
Aliasing ..... 100  
Analog Output ..... 59, 178  
Antialiasing ..... 109, 213  
A-phase Pulse ..... 93  
Arrange Waveforms ..... 96  
Attribute ..... 144  
Automatically Saves Measurement Data ..... 141, 147  
Auto range ..... 56  
AUTO Range ..... 22, 57  
Auto Trigger ..... 102  
Averaging ..... 31, 117

## B

Backup ..... 224  
Bar Graph ..... 32  
Beep Tone ..... 137  
Before Having Your Instrument Repaired ..... 257  
BIN (Binary format) ..... 150  
Bluetooth ..... 203  
Boot Key Reset ..... 138  
B-phase Pulse ..... 93

## C

Calculating combined accuracy ..... 252  
Calculation Order ..... 75  
Carrier Frequency ..... 107  
Center Frequency ..... 89  
Channel Detailed Display Area ..... 68  
Channel Indicator LED ..... 22  
Clock Setting ..... 137  
Combined Accuracy ..... 252  
Comment Entry ..... 154  
commercial power line ..... 47  
Common-mode Voltage ..... 211  
Connection Diagram ..... 43

Connection Mode ..... 31  
Connection Pattern ..... 31  
Content ..... 72  
Conversion Cable ..... 39  
Crest Factor ..... 209  
CSV ..... 147  
CSV Format ..... 144  
CT ..... 31, 64  
Cumulative Integration ..... 69  
current direction mark ..... 46  
Current Sensor Phase Shift Function ..... 127  
CURSOR ..... 105  
Cursor measurement ..... 105  
CUSTOM ..... 51

## D

D/A MONITOR ..... 131  
D/A Output ..... 25, 175  
Data Update Rate ..... 31, 59  
DC Mode ..... 68  
DECI ..... 99  
Default Gateway ..... 192  
Default Settings ..... 139  
Degaussing ..... 45  
Delta Conversion ..... 31, 124  
dgt ..... 12  
DHCP ..... 193  
Dimensions ..... Appx.6  
Direction ..... 86  
Direction of Rotation ..... 86, 93  
Displacement power factor (DPF) ..... 244  
Display Icons ..... 27  
Displaying Waveforms ..... 95  
Display Language ..... 137  
Display Range ..... 53  
Displays Vectors ..... 32  
DMAG ..... 45  
DOT ..... 134  
D-sub 9-pin Connector ..... 25, 203  
Dual ..... 84  
Dual Motor ..... 84

## E

Effective Measurement Range ..... 53  
Efficiency Calculation ..... 33, 78  
Electrical Angle ..... 91  
EV (Event) ..... 103  
Event (Trigger detection method) ..... 102  
Exponential Averaging ..... 31, 117  
Extension ..... 146, 150, 152, 154  
External Control Terminal ..... 188  
External Input ..... 25  
External Signal ..... 66, 187  
Ext (Sync.Src.) ..... 60, 91

**F**

FFT analysis .....	107
FFT Lower Freq.....	111
FFT Source.....	107
FFT TOP10.....	110
FFT Win. Func (window function used in FFT analysis) .....	112
File.....	143
Fnd Value .....	71
Folder .....	143
Freq. (Sampling speed).....	99
Frequency Measurement.....	62
f.s.....	12
FTP.....	197
fundamental frequency.....	47
Fundamental Wave Component.....	71
Fundamental Wave Vector .....	73

**G**

GP-IB Connector .....	25, 200
Grouping Method.....	76

**H**

Handwritten .....	155
Harmonic .....	32, 71
Harmonic Group .....	76
Harmonic Measurement Mode .....	74
Harmonic Sub-group .....	76
HD .....	47
High Pass Filter .....	63
Hold Function .....	23, 119
HTTP Server.....	221

**I**

IEC.....	74
IEC Standard Mode.....	74
Independent Input.....	84
Indiv. ....	85
Inlet.....	37
Input Channels .....	25
Input Impedance.....	175
Integ. f.s.....	131, 135
Integ. Indicator.....	69
Integration.....	65
Integration Full Scale.....	178
Integration Mode.....	68
Intermediate Harmonic .....	76
Internal Memory.....	30
Inter-order Harmonic .....	76
Interp. ....	106
Interval.....	115
Interval Time.....	69, 115
IP Address .....	192

I-RECT.....	64
Item.....	72

**K**

Keyboard Window .....	29
-----------------------	----

**L**

LAN.....	25, 192
Length (Recording length).....	99
Level (Trigger detection method).....	102
LINE.....	134
Line (Interpolation method).....	106
List Display .....	32
Loss.....	77
Low-pass Filter .....	86
LOW PF.....	47
LPF.....	31, 61, 86

**M**

MAC Address.....	26
MANUAL.....	104
Manual Integration.....	69
Manual Range .....	56
Manual Saving.....	141, 146
Manual Trigger.....	24
Master Instrument.....	77, 171
Maximum Display Order .....	72
Maximum Rated Input-to-Ground Voltage .....	17
MAX Order.....	72
MEAN .....	64
Measurement Lower Limit Frequency .....	62
Measurement Upper Limit Frequency .....	62
Mechanical Angle .....	90
Media Indicator.....	30
Mode (Storage mode).....	99
Motor Input .....	25, 82
Motor Power .....	83

**N**

Narrow .....	57
Number of Averaging Iterations .....	118
Numerical Synchronization Mode.....	171
Numeric Keypad Window .....	29

**O**

Operating State Indicator.....	30
Optical Connection Cable.....	10, 172
Origin.....	86
Origin Signal.....	86
Outline Drawing.....	Appx.6
Output Impedance .....	175

Output range.....	179
Output Rates .....	180

## P

Parameter Selection Window .....	52
Peak Hold Function .....	23, 119
Peak-over .....	57
Peak-peak Compression .....	99
PEN DOWN.....	134
PEN UP .....	134
Phase ADJ.....	92
Phase Shift .....	128
Phase Zero-adjustment .....	92, 215
PNF .....	86
Polarity.....	68
Polarity Detection .....	210
Power Calculation Formula .....	126
Power Inlet.....	25
Power Supply Terminal.....	25
P-P.....	99
Pre-Trigger .....	102
Probe1 terminal .....	17, 39
Probe2 terminal .....	17, 40
Pulse Noise Filter .....	86
PWM.....	47

## R

Rack-mounting .....	Appx. 1
rdg. ....	12
Recording Length (Length).....	99
Recording Waveforms .....	104
Rectifier .....	64
Remote State.....	23, 205
Response Speed .....	118
RMS.....	64
Rotary Encoder.....	90
Rotary Knobs.....	24
RPM.....	83

## S

Sampling Speed (Frequency).....	99
Save FFT Spectrum .....	152
Saves Measurement Data Manually.....	141
Save Waveforms .....	150
Scale.....	72
Scale Value.....	88
Scaling.....	31, 64
Screenshot .....	141, 154, 156
Selecting Display .....	51
Self-test .....	42
Serial Number.....	137
Setting Indicator.....	30
Settings Data.....	155
Setup (Bluetooth setting).....	190

Simple Averaging.....	31, 117
Sine (Interpolation method) .....	106
Single.....	84
SINGLE .....	104
Single Motor .....	84
Size and Pos. ....	108
Slave Instrument.....	77, 171
Sliding Cover .....	25
Slip.....	83, 87
SSV .....	147
Startup Screen Selection.....	137
Status data .....	162
Storage Mode (Mode).....	99
Subnet Mask.....	192
Synchronization Source.....	31
Synchronization Unlock.....	61
System Reset .....	138
System Settings.....	137

## T

Time Axis Setting .....	99
Timer Integration .....	70
Timer Time.....	69, 115
Time Scale.....	99
Time Scale (D/A monitor function).....	131
Time Scale (Displaying waveforms) .....	99
Time Setting .....	137
Torque.....	83
Touch .....	21
Touch Panel.....	138
Trigger .....	95
Trigger Level.....	103
Trigger Slope .....	102
Trigger Source.....	102
Two-instrument Synchronization .....	25, 171

## U

UDF (User-defined Calculations).....	129
U-RECT .....	64
USB Flash Drive .....	30, 141

## V

Vector Display.....	32, 73
VERTICAL .....	101
Virtual Neutral Point.....	124
Voltage Cord.....	42
Voltage Input Terminal .....	25
VT .....	31, 64

## W

Warm-up.....	42, 45
Waveform Synchronization Mode.....	171

Wide .....	57
WideBand .....	74
Wideband Mode .....	74
Window Function .....	112, 213
Window Wave Number .....	76, 214

## X

---

X-Y PLOT .....	133
----------------	-----

## Y

---

Y- $\Delta$ Conversion .....	125
------------------------------	-----

## Z

---

ZC Filter .....	103
ZC HPF .....	63
Zero Adjustment .....	22, 45
Zero-adjustment of Motor Input .....	83
Zero-cross .....	60
Zero-cross Filter .....	103
Zero Position .....	97
Zero-suppression .....	53, 58
Zoom .....	106
Z-phase .....	91
Zph. (Synchronization source) .....	60

# Warranty Certificate

# HIOKI

Model	Serial number	Warranty period Three (3) years from date of purchase ( ___ / ___ )
-------	---------------	--

Customer name: \_\_\_\_\_

Customer address: \_\_\_\_\_

## Important

- Please retain this warranty certificate. Duplicates cannot be reissued.
- Complete the certificate with the model number, serial number, and date of purchase, along with your name and address. The personal information you provide on this form will only be used to provide repair service and information about Hioki products and services.

This document certifies that the product has been inspected and verified to conform to Hioki's standards.

Please contact the place of purchase in the event of a malfunction and provide this document, in which case Hioki will repair or replace the product subject to the warranty terms described below.

## Warranty terms

1. The product is guaranteed to operate properly during the warranty period (three [3] years from the date of purchase).  
If the date of purchase is unknown, the warranty period is defined as three (3) years from the date (month and year) of manufacture (as indicated by the first four digits of the serial number in YYMM format).
2. If the product came with an AC adapter, the adapter is warranted for one (1) year from the date of purchase.
3. The accuracy of measured values and other data generated by the product is guaranteed as described in the product specifications.
4. In the event that the product or AC adapter malfunctions during its respective warranty period due to a defect of workmanship or materials, Hioki will repair or replace the product or AC adapter free of charge.
5. The following malfunctions and issues are not covered by the warranty and as such are not subject to free repair or replacement:
  - 1. Malfunctions or damage of consumables, parts with a defined service life, etc.
  - 2. Malfunctions or damage of connectors, cables, etc.
  - 3. Malfunctions or damage caused by shipment, dropping, relocation, etc., after purchase of the product
  - 4. Malfunctions or damage caused by inappropriate handling that violates information found in the instruction manual or on precautionary labeling on the product itself
  - 5. Malfunctions or damage caused by a failure to perform maintenance or inspections as required by law or recommended in the instruction manual
  - 6. Malfunctions or damage caused by fire, storms or flooding, earthquakes, lightning, power anomalies (involving voltage, frequency, etc.), war or unrest, contamination with radiation, or other acts of God
  - 7. Damage that is limited to the product's appearance (cosmetic blemishes, deformation of enclosure shape, fading of color, etc.)
  - 8. Other malfunctions or damage for which Hioki is not responsible
6. The warranty will be considered invalidated in the following circumstances, in which case Hioki will be unable to perform service such as repair or calibration:
  - 1. If the product has been repaired or modified by a company, entity, or individual other than Hioki
  - 2. If the product has been embedded in another piece of equipment for use in a special application (aerospace, nuclear power, medical use, vehicle control, etc.) without Hioki's having received prior notice
7. If you experience a loss caused by use of the product and Hioki determines that it is responsible for the underlying issue, Hioki will provide compensation in an amount not to exceed the purchase price, with the following exceptions:
  - 1. Secondary damage arising from damage to a measured device or component that was caused by use of the product
  - 2. Damage arising from measurement results provided by the product
  - 3. Damage to a device other than the product that was sustained when connecting the device to the product (including via network connections)
8. Hioki reserves the right to decline to perform repair, calibration, or other service for products for which a certain amount of time has passed since their manufacture, products whose parts have been discontinued, and products that cannot be repaired due to unforeseen circumstances.

**HIOKI E.E. CORPORATION**

<http://www.hioki.com>

18-07 EN-3







# HIOKI

<http://www.hioki.com>



**All regional  
contact  
information**

**HEADQUARTERS**

81 Koizumi  
Ueda, Nagano 386-1192 Japan

**HIOKI EUROPE GmbH**

Rudolf-Diesel-Strasse 5  
65760 Eschborn, Germany  
[hioki@hioki.eu](mailto:hioki@hioki.eu)

1906 EN

Edited and published by HIOKI E.E. CORPORATION

Printed in Japan

- CE declarations of conformity can be downloaded from our website.
- Contents subject to change without notice.
- This document contains copyrighted content.
- It is prohibited to copy, reproduce, or modify the content of this document without permission.
- Company names, product names, etc. mentioned in this document are trademarks or registered trademarks of their respective companies.