

300 Times Better Noise Resistance

- Max. $2 \times 10^{19} \Omega$ Display
- Min. 0.1 fA Resolution
- Max. 6.4 ms Measurement Speed
- Max. 2000 V Output

SUPER MEGOHM METER SM7120



Flexible, Multipurpose Design

Electrometer
Picoammeter
IR Meter

Max.
1000 V Output
SM7110

New



4CH
Microcurrent
Measurement
SM7420

Highly stable measurements with strong noise resistance

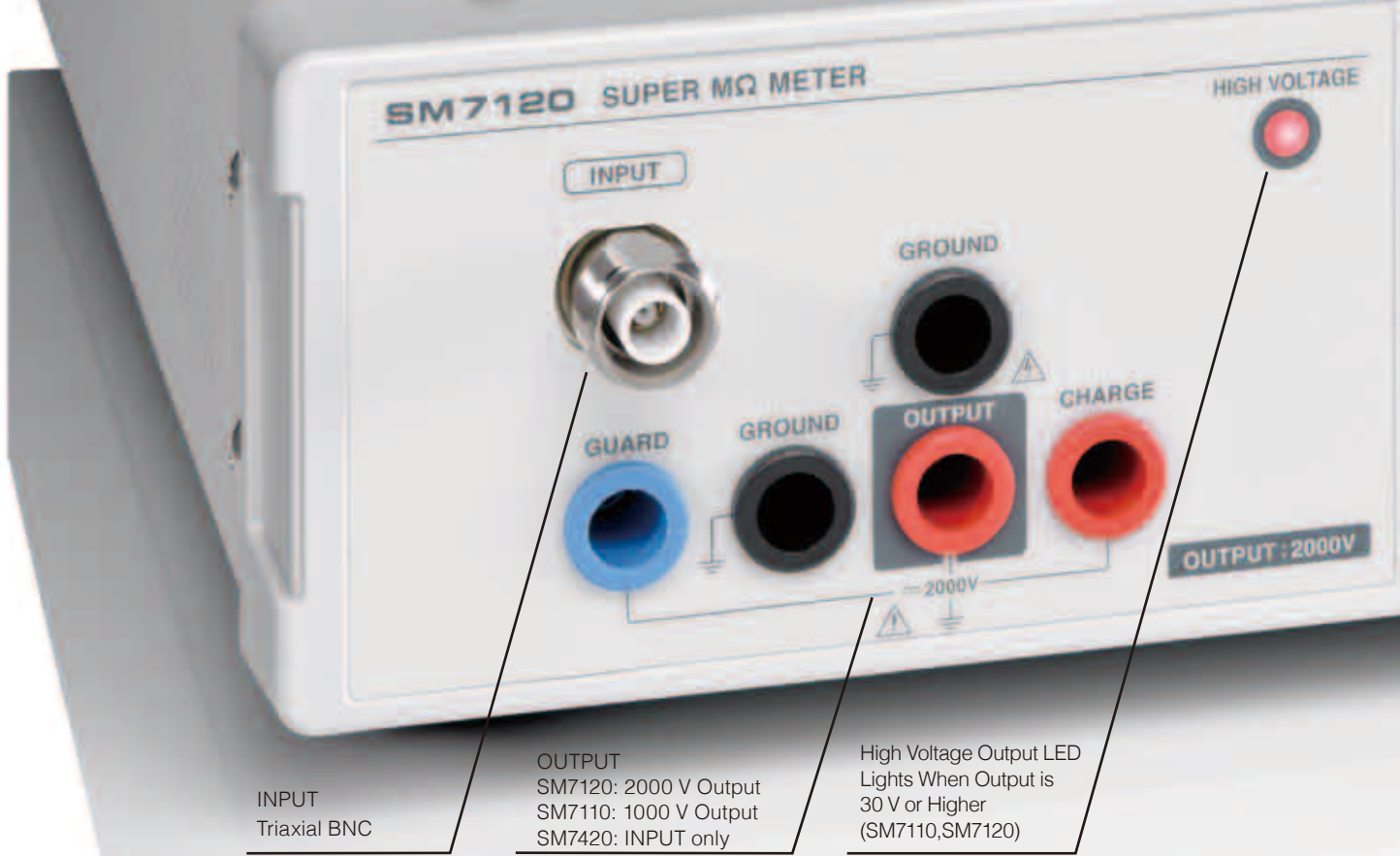

The stability you need for high resistance measurements

1/60 Variability, 300x Noise Resistance

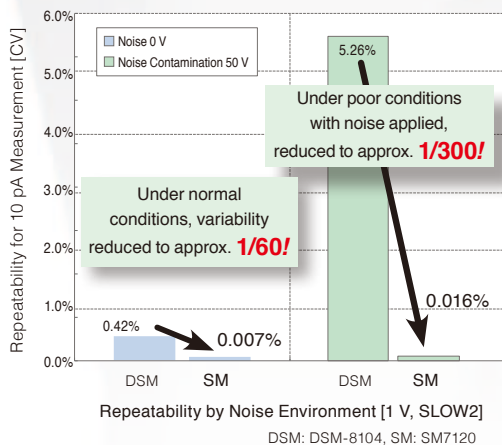

Advanced 2 kV floating circuitry

Stability (repeatability) against power supply noise and external noise has improved dramatically due to a combination of new Super Megohm floating circuitry and triaxial connectors. Variability in normal usage environments is reduced to 1/60 compared to previous models, and to 1/300* in conditions where 50 V noise is applied.

* Compared to legacy model, the DSM-8104



16 mm large-diameter triaxial connector

The large-diameter triaxial connector newly adopted for current input terminals has a triple coaxial structure with the internal shield connected to the GUARD (COM) line and the external shield connected to the GROUND. This achieves both stability against noise and safety during high-voltage inspections.



Supports components with high voltage resistance

2000 V / $2 \times 10^{19} \Omega$ Measurement * SM7120

Perfect for EVs and other high-voltage applications



Improved high voltage resistance and isolation performance in components are essential to meet the demands for high efficiency in recent years for applications such as automotive parts and wearable devices. The SM7120 can output 2000 V without an external power supply, ensuring that it will remain relevant even as inspection requirements expand going forward.

Model	Measurement channel	Maximum output voltage
SM7110	1ch	1000 V
SM7120	1ch	2000 V
SM7420	4ch	-----

* $2 \times 10^{19} \Omega = 20,000 \text{ P(peta)} \Omega$

Supports mass production of 1600 units/minute

Min. 6.4 ms High-Speed Inspection

6.4 ms = 4.1 ms measurement + 2.3 ms contact check

Achieve high-speed measurement with an inspection time (from TRIG input to INDEX output) of 6.4 ms when contact checks that are essential for mass production inspections are included, and 7.0 ms when comparator measurement is included.

MLCC high-speed inspection with pre-charge function *

Large-capacity outputs of 2000 V/1.8 mA (SM7120 only) and 1000 V/10 mA are available, to reduce sample charging time.

[Charging terminals are equipped as standard.] The max. 50 mA/250 V pre-charge function achieves high throughput for MLCC mass production inspections. *SM7110,SM7120



Optimal Utilities for Evaluation of New Materials



Evaluate Semiconductors and New Materials

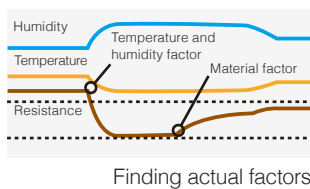

[Simultaneous measurement of temperature and humidity]

Temperature and humidity must be managed together, because changes in either can affect insulation resistance. Models SM7120, SM7110 and SM7420 are equipped to perform highly accurate temperature and humidity measurements (temperature $\pm 0.5^{\circ}\text{C}$ ($\pm 0.9^{\circ}\text{F}$), humidity $\pm 5\%$ R.H.), for the measurement and management of new materials.

(When using the optional Z2011 HUMIDITY SENSOR: Temperature -40°C to 80°C (-40°F to 176°F), Humidity 20% to 80%)

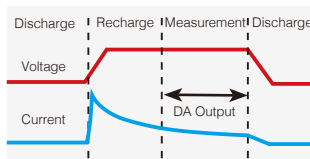

[Sequence control] [D/A output]

In sequence mode, set the time (max. 999.9 s) for "Discharge" - "Recharge" - "Measurement" - "Discharge", to perform repeated measurements without using a computer. During measurement, current fluctuations can also be saved to recorders from D/A output.

For even more precise evaluations, use external control such as USB to perform voltage resistance testing on semiconductors or to check the voltage dependence of new material.

Auto Average to Cancel Irregular Input

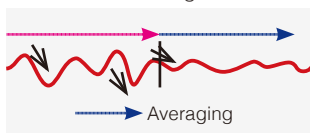
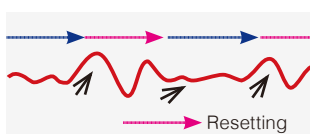

[Auto averaging]

With the SM series, auto averaging monitors fluctuations in current and automatically determines the optimum average, so there is no need to make changes to settings while observing measurement results. Unexpected measurement fluctuations, such as transient responses in recharge current and unstable contacts with large variations, are automatically removed to achieve stable measurement results.

(An average of a specified number with fixed measurement conditions is also possible.)

[5-stage measurement speed]

Speed switches between FAST, FAST2, MID, SLOW, and SLOW2 based on environment, and can be set according to environment such as FAST2 at $\frac{1}{2}$ PLC for the internal integration time.

Save a Huge Range of Electrode Variations and Settings



[Electrode presets]

A variety of electrode and shield box presets are provided according to material.

The electrode constant is set automatically by simply entering the name of the electrode to be used, allowing resistivity to be measured easily and accurately.

[Panel save/load]

Electrode names and various settings, such as the 60-second settings for sequence control, can be saved as panel data. This means that material switching can be performed easily simply by loading panel data.

Make Mass Production More Practical than Ever

High-Performance Contact Checks for Picoammeter Mode (Using External Power Source)

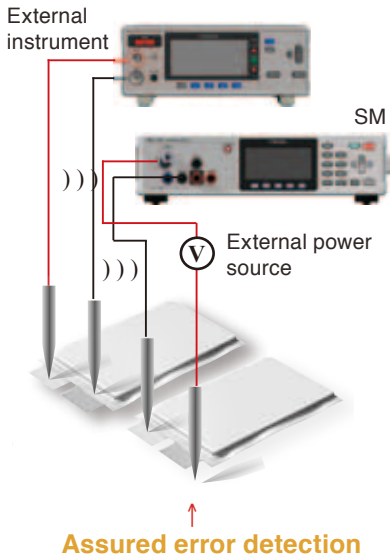

[Low capacity contact checks]

The SM7110/SM7120 is equipped with contact checks that can identify low-capacity capacitors of only a few pF as well as measured objects with a small capacitance. (Reference value: 0.1 pF to 99.99 pF)

[2-band selection]

As with battery production lines, select the frequency for contact checks to prevent the minute check signals on site with multiple various measuring instruments from getting crossed.

These two contact checks can also be used in picoammeter mode with an external power supply. These are high-performance contact checks that prevent unnecessary retries and excess detection due to the effects of an external power supply, and that also prevent takt reduction and worsening yield ratio.

[CH independent contact checks]

The SM7420 using an external power source enables check frequencies and delay settings to be changed for each measurement channel, achieving detailed settings that match the line design.

Faster Line Construction

EXT I/O TEST				I/O TYPE:HPM			
EOM	ERR	INDEX	C_CHK_GO	V_CHK_GO	OPEN_GO	VON	HI
IN	LO	PASS	FAIL	TRIG	START	C_CHK	STOP
V_CHK	OPEN	ILOCK	KLOCK	V_CHK	OPEN	ILOCK	KLOCK
EXIT		ON	OFF				

EXT I/O Test

[External interfaces]

There are three types of external interface: GP-IB, RS-232C, and USB, as well as the built-in EXT I/O for easy linkage with programmable controllers.

[Communication monitor] [EXT I/O test]

Because the communication monitor and EXT I/O test function can be used to assess all interfaces, work can be performed while observing operation conditions in real time as necessary during line construction.

Flexible Setup Changes

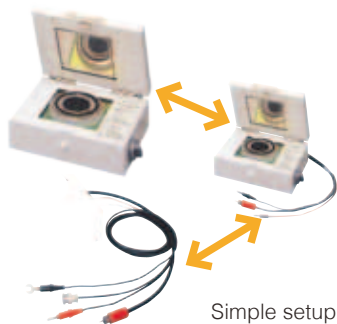

[Cable length correction]

Replace measuring cables without adjustment by simply registering the cable length. (Cable length that can be registered: 0.5 m to 3.0 m (1.64 ft to 9.84 ft)) Capacitance contact check functions that are generally included with electrometers and picoammeters will require the impedance matching to be reset whenever the cable length changes. With the SM series, replacement is possible without any adjustments.

[Jig capacity open correction]

With the SM series, open correction is provided for jig switching, for a flexible response to changes in line structure without the need for adjustments.

High-Speed Low-Current Measurement and Large-Capacity Output: Perfect for MLCC Mass Production Lines

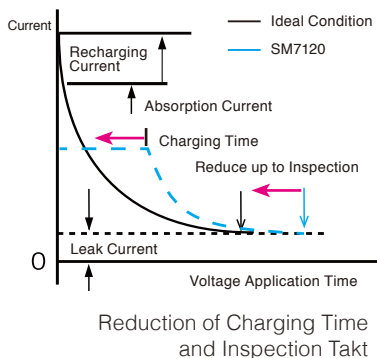

[Input impedance 1 kΩ]

Because the SM7110, SM7120, SM7420 offers low input impedance of 1 kΩ for all current range and speed settings, there is no delay due to "settling time". This is optimal for mass production lines, because there is no reduction in speed due to switching range.

[Max. 50 mA /250 V, 1.8 mA /2000 V large capacity output, low noise]

For the insulation resistance measurement of a capacitive sample such as MLCC, charging time when voltage is applied is also important, in addition to the inspection speed. Reduced charging time allows a shorter inspection takt. The SM series has a built-in large-capacity, low-noise power supply, for reliable and even higher performance of MLCC.

Electrodes for a Variety of Materials and Uses

SURFACE/VOLUME RESISTANCE MEASUREMENT ELECTRODE SM9001

Measure sheets, film, plate products, materials, and antistatic flooring materials as they are - no need to cut samples

- Compliance Standards

JIS C2170, IEC61340-2-3

"Methods of test for determining the resistance and resistivity of solid planar materials used to avoid electrostatic charge accumulation"



Not CE
Marked

- Main body
SURFACE/VOLUME RESISTANCE MEASUREMENT
ELECTRODE SM9001

(With integrated low resistance [500 kΩ]/high resistance [1 TΩ] test surfaces)

Measure without cutting samples

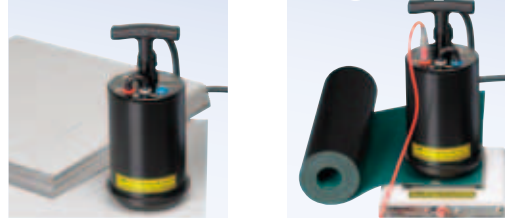

- Electrode Shapes Compliant with Standards

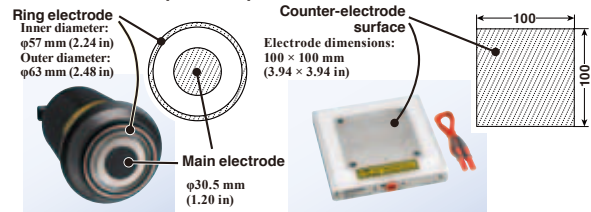

Main body electrode
(Bottom view of the SM9001)

Counter-electrode with
integrated stand
(SM9001 accessory)

The electrode on the main body uses conductive rubber in a size conforming to standards. Just place the electrode on the sample or measurement point to make stable measurements under a load of 2.5 kg (88.2 oz). Furthermore, measurement voltage up to 1000 V enables highly accurate measurements.

- Test Before Use With the SM9002
Verification Fixture for Surface
Resistance Measurement (Optional)

The SM9002 Verification Fixture for Surface Resistance Measurement (optional) allows you to check the operation of the electrode to increase the reliability of measurement results.

Verification Fixture for Surface
Resistance Measurement
SM9002



When using the SM9002

- Options
VERIFICATION FIXTURE FOR SURFACE
RESISTANCE MEASUREMENT SM9002

(With integrated low resistance [500 kΩ]/high resistance [1 TΩ] test surfaces)

* When connecting electrodes and shield boxes to SM7110/SM7120, note that CONVERSION ADAPTER Z5010 or a change of connectors is required.

- Resistivity Measurement

Resistivity (specific resistance) is measured to determine the quality of an insulating material. Resistivity can be classified as volume resistivity or surface resistivity, respectively indicated by the resistance between two sides relative to that of a 1 cm³ cube, or by the resistance relative to that of a 1 cm² surface. HIOKI's super megohm meter SM series provides a wide variety of electrodes to ensure easy measurement regardless of sample material or condition.

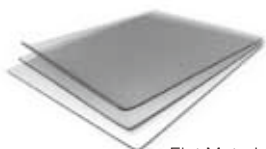

Flat Material



Roll Sample

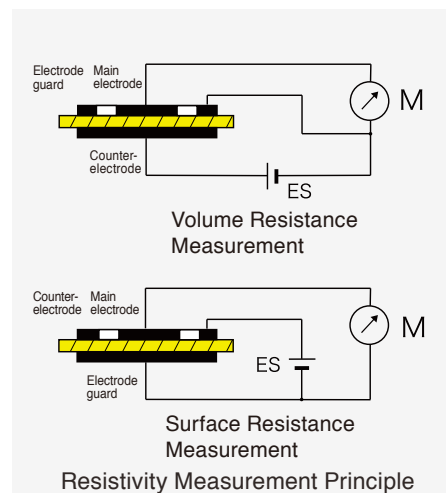

Application Map

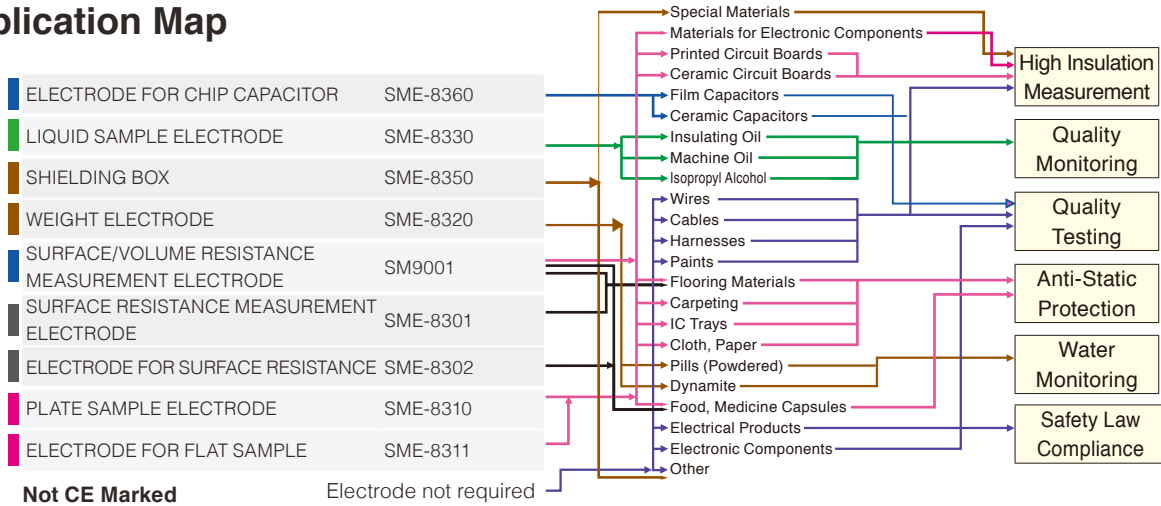

When connecting electrodes and shield boxes to SM7110/SM7120, note that CONVERSION ADAPTER Z5010 or a change of connectors is required.

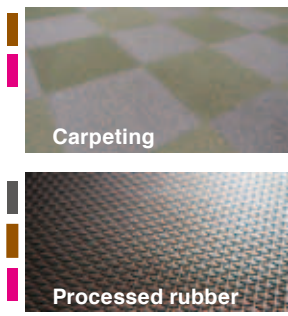
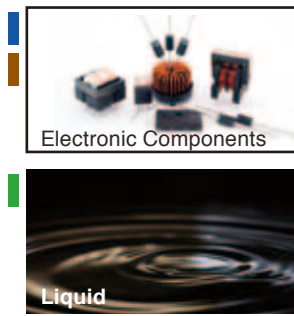

SHIELDING BOX SME-8350

This is used as a sample accommodation box during measurement of a high-insulation resistance samples, or inductive or capacitive samples to perform electromagnetic shielding. When used in combination with mass electrode SME-8320, the electrode can be used as a counter electrode or a guard electrode.

When measuring electronic components such as capacitors and transducers, external noise and leakage currents are prevented to ensure stable measurement.

Accessories: Rubber sheet

Dimensions: 250 mm (9.84 in) W × 100 mm (3.94 in) H × 200 mm (7.87 in) D, **Lead length:** 80 cm (2.62 ft)

* Connection option for SM7110 and SM7120 Interlock connection cable DSM8104F

ELECTRODE FOR CHIP CAPACITOR SME-8360

This electrode is for measuring the insulation resistance of chip capacitors, **with an adjustable jig from 0 mm to 11 mm (0 in to 0.43 in)**. An interlock connection cable is connected to the main unit, so that measurement voltage becomes "OFF" while the lid is open to ensure safety.

Dimensions: 200 mm (7.87 in) W × 52 mm (2.05 in) H × 150 mm (5.91 in) D, **Lead length:** 85 cm (2.79 ft)

MASS ELECTRODE SME-8320

This is an electrode for plate samples for use together with SHIELDING BOX SME-8350. **This electrode enables extremely easy measurement of surface and volume resistivity even on carpets and other coarse surfaces.** The main electrode dia. is 50 mm (1.97 in), and the ring electrode inner dia. and outer dia. are 70 mm (2.76 in) and 80 mm (3.15 in), respectively. A jig that holds the electrodes in a concentric arrangement and two banana clips are also included.

Combined with SHIELDING BOX (SME-8350)

LIQUID SAMPLE ELECTRODE SME-8330

An **electrically guarded** electrode for liquid samples. * Inspection data sheet included Measure resistance up to 10¹⁹ Ω·cm (at 1000 V).

Total volume: 25 mL
Capacitance between main and counter electrode: Approx. 45 pF
Electrode constant: Approx. 500 cm (16.41 ft)
Distance between electrodes: 1 mm (0.04 in)

Dimensions: φ 36 × 140 mm (1.42 × 5.51 in)
JIS C 2101 compliant

Accessories: Connection cable 60 cm (1.97 ft) length Red: OGA00029, Black: OGA00030

ELECTRODE FOR FLAT SAMPLE SME-8311

An electrode for measuring the resistivity of plate samples. Samples of 40 to 100 mm (1.57 to 3.94 in) square by up to 8 mm (0.31 in) in thickness are measurable. **The main electrode dia. is 19.6 mm (0.77 in) and inner & outer dia. of the ring electrode are 24.1 mm (0.95 in) & 28.8 mm (1.13 in), respectively.** The fundamental specifications are the same as SME-8310.

Dimensions: 215 mm (8.46 in) W × 78 mm (3.07 in) H × 165 mm (6.50 in) D, **Lead length:** 75 cm (2.46 ft)

* Connection option for SM7110 and SM7120 Interlock connection cable DSM8104F

SURFACE RESISTANCE MEASUREMENT ELECTRODE SME-8301

Simply press the tips of the electrode onto the sample to measure surface resistance. Use this to measure the surface resistance of samples used for static electricity measures. Measure resistance up to 10¹¹ Ω.

Dimensions: φ60 × 50 mm (2.36 × 1.97 in), **Lead length:** 1 m (3.28 ft)

ELECTRODE FOR FLAT SAMPLE SME-8310

An electrode for measuring the resistivity of plate samples. Samples of 100 mm (3.94 in) square by up to 8 mm (0.31 in) in thickness are measurable. **The main electrode dia. is 50 mm (1.97 in) and inner & outer dia. of ring electrode are 70 mm (2.76 in) & 80 mm (3.15 in), respectively.** An interlock connection cable is connected to the main unit, so that measurement voltage becomes "OFF" while the lid is open to **ensure safety**. A selector switch allows selection of volume resistivity or surface resistivity.

Dimensions: 215 mm (8.46 in) W × 78 mm (3.07 in) H × 165 mm (6.50 in) D, **Lead length:** 75 cm (2.46 ft)

* Connection option for SM7110 and SM7120 Interlock connection cable DSM8104F

SURFACE RESISTANCE MEASUREMENT ELECTRODE SME-8302

An electrode for surface resistance of **curved samples and small samples**, such as resin and rubber processed goods. Surface resistance can be measured by pressing the rubber tips at the tip onto the sample. Measure electrodes up to 10¹¹ Ω at 10 mm intervals or greater.

(Distance between electrodes: 4 mm (0.16 in))

Dimensions: φ 40 × 115 mm (0.16 × 4.53 in), **Lead length:** 1 m (3.28 ft)

General Specifications

Basic Specifications

Operating environment	Indoors, pollution degree 2, altitude up to 2000 m (6562 ft)
Operating temperature and humidity range	0°C to 40°C (32°F to 104°F), 80% RH or less, no condensation
Storage temperature and humidity range	-10°C to 50°C (14°F to 122°F), 80% RH or less, no condensation
Power supply/Maximum rated power consumption	100 V to 240 V AC (50 Hz/60 Hz): 45 VA
Dielectric withstand voltage	4000 V AC, sensed current: 10 mA Between all mains supply terminals and protective ground, interfaces, and measurement jacks
Compliance standard	EMC:EN61326 Safety:EN61010
Dimensions/mass	SM7110/SM7120 : 330 mm (12.99 in) W × 80 mm (3.15 in) H × 450 mm (17.72 in) D, 5.9 kg (208.1 oz) SM7420 : 330 mm (12.99 in) W × 80 mm (3.15 in) H × 450 mm (17.72 in) D, 6.5 kg (229.3 oz)
Accessories	Power cord ×1, Instruction manual ×1, CD-R (Communications command instruction manual, USB driver) EXT I/O male connector ×1 SM7110/SM7120: Short plug ×1

Measurement Specifications

Parameter	SM7110 / SM7120	SM7420
Measurement channel	1ch	4ch
Measurement parameter	DC current, DC voltage, temperature, humidity	DC current, temperature, humidity
Applied voltage	SM7110:0.1 V to 1000.0 V SM7120:0.1 V to 2000.0 V	-----
Measurement method	Current measurement method through application of constant voltage to measured object	Ammeter
Warning display	Voltage output value: Red LED comes on when approx. 30 V or higher	-----
Current input terminals	Triaxial BNC connector	Triaxial BNC connector
Voltage output terminal	Banana terminal	-----
COM terminal	-----	Banana terminal
Charge voltage output terminal	Banana terminal	-----
GUARD terminal	Banana terminal	-----
Interlock Input Terminal	BNC terminal	-----
Max. rated voltage to ground	2000 V DC	
Ammeter input resistance	1 kΩ ±10%	
Display refresh rate	200 ms ±5 ms (display refreshment can be turned ON/OFF during measurement.)	
Display unit	Monochrome graphic LCD	
Accuracy guarantee conditions	Guaranteed accuracy period	1 year
	Guaranteed accuracy period after adjustment made by Hioki	1 year
	Accuracy guarantee temperature and humidity range:	23°C ±5°C (73°F ±9°F), 80% RH or less
	Warm-up time:	30 min. or more
	Power supply frequency range	50/60 Hz ±2 Hz
Temperature coefficient	Add ±(measurement accuracy × 1/10)/°C for the following ranges: 0°C to 18°C (32°F to 64°F) and 28°C to 40°C (82°F to 104°F).	

Functional Specifications

Parameter	SM7110 / SM7120	SM7420
Measured value display mode	Display 1: Select one of the following: Resistance/current/surface resistivity/volume resistivity	○
	Display 2: Measurement voltage (voltage monitor)	×
	Display method: EXT (index display) or UNIT (units display), Number of significant figures: 3 to 6	○
Voltage output function	Sink/source (supports recharging and discharging) Selection when output is OFF: Discharge/high impedance (Hi-Z)	×
Voltage for resistance calculation	Select from the following: V.MONI (voltage measurement value)/MES.V (voltage setting value)/EXT.V (voltage setting value for calculation)	EXT.V only
Delay Function	Time from trigger input until start of measurement	Shared for all channels
Averaging Function	Measurement value averaging (OFF / ON / AUTO) ON 2 to 255 AUTO Automatically changes the number of averaging iterations based on the amount of change in the measurement value	Shared for all channels
Self-Calibration	Set time: 1 s to 600 s *Automated when the power is turned on	○
Cable length correction function	Correction range 0.5 m to 3.0 m (1.64 ft to 9.84 ft)	Each CH
Jig Capacity Open Correction Function	Display range: 0.00 pF to 99.99 pF Capacity measurement accuracy ±(20% rdg. ±0.1 pF)	Each CH
Contact Check Function	Capacitance measurement method using high-frequency signals Display range: 0.000 pF to 99.999 pF Measurement frequency: 300 kHz / 245 kHz	Each CH
Comparator Function	Determine with dgt. value (Hi, IN, Lo) * When using the comparator function, the range is fixed.	○
Sequence Program	Executes the Discharge - Recharge - Measurement - Discharge pattern in order Measurement: 1 ms to 999.9 s, Other than measurement: 0 ms to 999.9 s	×
Other functions	Judgment sound setting function, interlock function, reset, self-test	○

Accuracy Specifications

Accuracy guaranteed for 1 year; Post-adjustment accuracy guaranteed for 1 year
 * The 2000 V range is for the SM7120 only. Note that the voltage resistance for the electrodes will be 1000 V.

Current measurement accuracy

Range	Max. display	Resolution	Current measurement accuracy ($\pm\%$ rdg. \pm dgt.)			
			FAST / FAST2	MED	SLOW	SLOW2
20 pA	19.9999 pA	0.1 fA	–	–	2.0+450	2.0+30
200 pA	199.999 pA	1 fA	–	1.0+600	1.0+45	1.0+30
2 nA	1.99999 nA	10 fA	0.5+600	0.5+40	0.5+30	0.5+20
20 nA	19.9999 nA	100 fA	0.5+30	0.5+20	0.5+15	0.5+10
200 nA	199.999 nA	1 pA	0.5+30	0.5+20	0.5+15	0.5+10
2 μ A	1.99999 μ A	10 pA	0.5+30	0.5+20	0.5+15	0.5+10
20 μ A	19.9999 μ A	100 pA	0.5+30	0.5+20	0.5+15	0.5+10
200 μ A	199.999 μ A	1 nA	0.5+30	0.5+20	0.5+15	0.5+10
2 mA	1.99999 mA	10 nA	0.5+30	–	–	–

Measurement Time: INDEX time (When contact checks are ON)

Measurement speed (internal integration time)		Power supply frequency	
		50 Hz	60 Hz
FAST	2 ms	6.4 ms	6.4 ms
FAST2	0.5 PLC	16.0 ms	15.0 ms
MED	1 PLC	26.0 ms	23.0 ms
SLOW	4 PLC	112.0 ms	96.0 ms
SLOW2	13 PLC	322.0 ms	322.0 ms

PLC: Power Line Cycle

Temperature/Humidity Measurement Accuracy

When used together with the Z2011 HUMIDITY SENSOR

Temperature accuracy range	-40.00°C~80.00°C \pm 0.5°C
Humidity accuracy range	20.0% RH to 80.0% RH \pm 5 RH

Resistance accuracy

Current measurement accuracy + voltage measurement accuracy
 Accuracy is not guaranteed if the voltage setting value is selected to calculate resistance.

Resistance display range 50 Ω to 2 \times 10¹⁹ Ω

Example measurement time

Contact check (2.3 ms)	Comparator (0.2 ms)	Measurement speed (Power supply frequency)					
		FAST (50 Hz)			FAST2 (60 Hz)		
		INDEX	EOM	EOM (SM7420)	INDEX	EOM	EOM (SM7420)
OFF	OFF	4.1 ms	4.5 ms	5.4 ms	12.7 ms	13.1 ms	14.0 ms
OFF	ON	4.1 ms	4.7 ms	5.6 ms	12.7 ms	13.3 ms	14.2 ms
ON	OFF	6.4 ms	6.8 ms	7.7 ms	15.0 ms	15.4 ms	16.3 ms
ON	ON	6.4 ms	7.0 ms	7.9 ms	15.0 ms	15.6 ms	16.5 ms

INDEX time : Contact check time + Delay time + Measurement time

EOM time : INDEX + Comparator measurement time + 0.4 ms * Add 1.0 ms if calculating the resistance from the voltage measurement

EOM (SM7420) : INDEX + Comparator measurement time + 1.3 ms

SM7110 / SM7120 Voltage specifications * SM7420 cannot generate or measure voltage.

Voltage measurement accuracy

Range	Max. display	Resolution	Voltage measurement accuracy ($\pm\%$ rdg. \pm dgt.)
10 V	10.000 V	0.001 V	0.03+2
100 V	100.00 V	0.01 V	0.03+2
1000 V	1000.0 V	0.1 V	0.03+2
2000 V*	2000.0 V	0.1 V	0.2+2

Voltage Generation Accuracy Setting when output is OFF: Discharge or Hi-Z

Range	Setting voltage range	Setting resolution	Voltage generation accuracy ($\pm\%$ setting, $\pm\%$ f.s.)	Time from the START signal until voltage output
10 V	0.1 V to 10.0 V	0.1 V	0.1+0.05	0.1 ms max.
100 V	10.1 V to 100.0 V	0.1 V	0.1+0.05	0.1 ms max.
1000 V	101 V to 1000 V	1 V	0.1 +0.05	0.1 ms max.
2000 V*	1001 V to 2000 V	1 V	0.2 +0.10	0.1 ms max.

Voltage Generation Current Limiter

Recharge setting	Setting voltage range	As per settings	Total current	Current value		
				Measurement	Recharge	
ON	0.1 V to 250.0 V	50 mA	50 mA	5 mA	45 mA	
		10 mA	10 mA	5 mA	5 mA	
		5 mA	5 mA	5 mA	0 mA	
		10 mA	10 mA	5 mA	5 mA	
		5 mA	5 mA	5 mA	0 mA	
OFF	251 V to 1000 V	5 mA	5 mA	5 mA	0 mA	
		1.8 mA	1.8 mA	1.8 mA	0 mA	
		1001 V to 2000 V*	50 mA	50 mA	50 mA	0 mA
			10 mA	10 mA	10 mA	0 mA
			5 mA	5 mA	5 mA	0 mA
10 mA	10 mA		10 mA	0 mA		
OFF	251 V to 1000 V	5 mA	5 mA	5 mA	0 mA	
		1.8 mA	1.8 mA	1.8 mA	0 mA	
		1001 V to 2000 V*	50 mA	50 mA	50 mA	0 mA
			10 mA	10 mA	10 mA	0 mA
			5 mA	5 mA	5 mA	0 mA
10 mA	10 mA		10 mA	0 mA		

External Interface

SM7110/SM7120

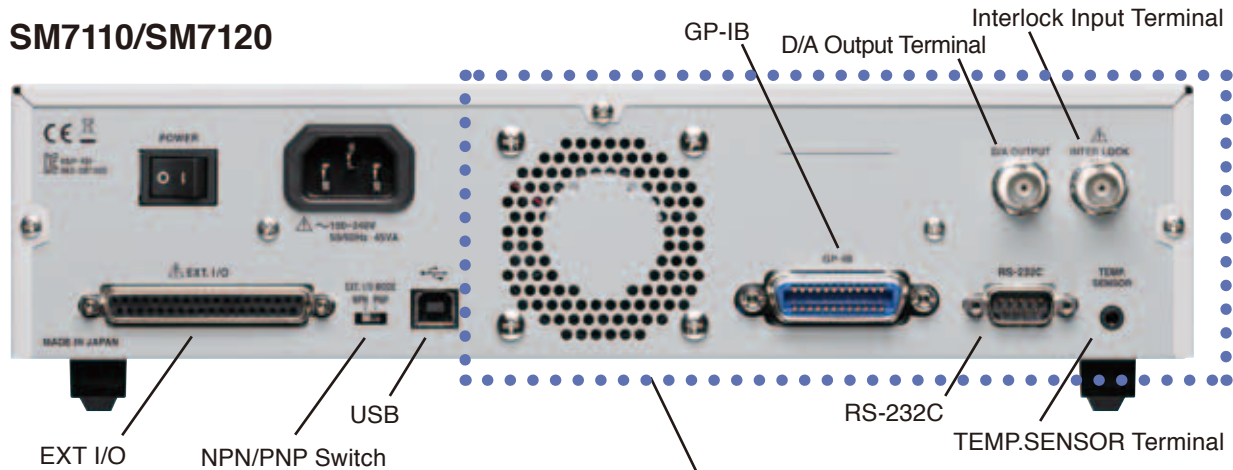

EXT I/O Interface (with test function)

You can use the rear panel's switch to select either the NPN type (which supports sink output) or the PNP type (which supports source output) for the input signal polarity to match the programmable controller's common polarity.

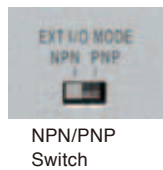

Connector

Connector used : 37-pin D-sub female connector with #4-40 inch screws (on the main unit)

Compatible connectors : DC-37P-ULR (solder type), DCSP-JB37PR (crimped type)
Japan Aviation Electronics Industry, Ltd.

Input Signals	Input type	Photocoupler isolation: Non-voltage contact inputs (Current sync output supported) (negative logic)
	Input ON voltage	1 V or less
	Input OFF voltage	OPEN (Shield current: 100 μA or less)
Output Signals	Output type	Photocoupler isolation: Open drain npn output (non-polar)
	Max. load voltage	30 V
	Max. output current	50 mA/ch
	Residual voltage	0.5 V (10 mA), 1.0 V (50 mA)
Built-in insulation power	Output voltage	Sink output support: +5.0 V ±10% Source output support: -5.0 V ±10%
	Max. output current	100 mA
	External power input	Limit
	Isolated	Floating from protective ground potential and measurement circuitry
	Insulation rating	Terminal-to-ground voltage: 50 V DC, 33 V rms AC, 46.7 V peak AC or less

Dynamic Chart (Voltage output, External trigger measurement)

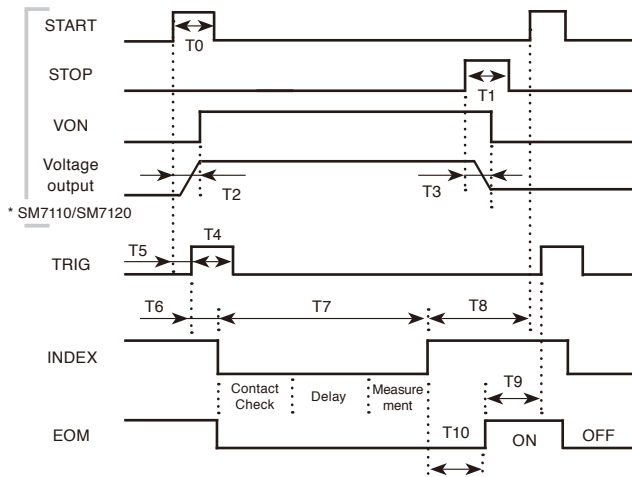

T0: 0.1 ms or greater, T1: 0.1 ms or greater, T4: 0.1 ms or greater
T2 (T3): Voltage output (stop) time: Less than 0.1 ms, T5: Trigger accepted: 0 s or greater
T6: INDEX, EOM delay time, T7: INDEX time, T8: START setup time: 4 ms or greater
T9: TRIG setup time: Display ON (40 ms or greater) Display OFF (1 ms or greater)
T10: Less than (Comparator measurement time + 0.1 ms)

SM7420

COM terminal for connecting external power source on rear (Measurement GROUND)

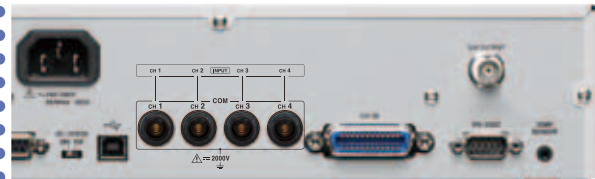

Communication Monitor

Monitor the USB, RS-232C, and GP-IB transmission contents on the panel.

GP-IB Interface

Communication method	IEEE-488.2 compliant Interface function SH1, AH1, T6, L4, SR1, RL1, PP0, DC1, DT1, C0
Addresses	0~30

RS-232C Interface

Connector	9-pin D-sub male connector with #4-40 inch screws
Communication method	Full duplex, start stop synchronization, stop bit of 1 (fixed), data length of 8 (fixed), no parity, no flow control
Communication speed (bps)	4800 / 9600 / 19200 / 38400 / 115200

USB Device

Connector	Series B receptacle
Electrical specifications	USB2.0 (Full-speed)
Class	CDC class (COM mode) HID class (USB keyboard mode)

D/A Output

Output terminal	BNC terminal
Output voltage	0 V to 2 V DC: 2.0 V at current range F.S. (Select the output ch. for the SM7420)
Output impedance	1 kΩ

Interlock Input (SM7110/SM7120)

Input terminals	BNC terminal (Parallel with the EXT I/O terminal)
Interlock operation	When this setting is enabled, interlock is disengaged when Lo is input or when there is a short circuit between terminals.
Operation when the function is enabled	Output and measurement of the measurement voltage are stopped. Measurement is not possible by key or communication.

TEMP.SENSOR Terminal

Input sensor	Z2011 HUMIDITY SENSOR
--------------	-----------------------

COM Terminal (SM7420)

Input terminals	Banana terminal
-----------------	-----------------

Model: SUPER MEGOHM METER SM7110 SUPER MEGOHM METER SM7120 SUPER MEGOHM METER SM7420

Model No. (Order Code)	Measurement channel	Maximum output voltage	Remarks
SM7110	1ch	1000 V	
SM7120	1ch	2000 V	
SM7420	4ch	-----	Dedicated microcurrent measurement

Measurement probe not included with main unit. Please purchase an optional probe that matches your measurement application.

Options

Probes



PIN TYPE LEAD (RED) L2230
Cable length: 1 m (3.28 ft)



PIN TYPE LEAD (BLACK) L2231
Cable length: 1 m (3.28 ft)



CLIP TYPE LEAD (RED) L2232
Cable length: 1 m (3.28 ft)



CLIP TYPE LEAD (RED) L2233
Cable length: 1 m (3.28 ft)



OPEN LEAD (RED) L2234
Cable length: 3 m (9.84 ft)



OPEN LEAD (RED) L2235
Cable length: 3 m (9.84 ft)



HUMIDITY SENSOR Z2011
HUMIDITY SENSOR
Cord length: 1.5 m (4.92 ft)

STANDARD RESISTOR SR-2



A resistor box for calibration of the super megohm meters.
It uses a structure that ensures a guard.
Max. voltage: 1000 V DC
Resistance: 10 to 10,000 MΩ (24 points)
CONVERSION ADAPTER Z5010 required.
Dimensions: 270 mm (10.63 in) W × 90 mm (3.54 in) H × 195 mm (7.68 in) D
* Inspection data sheet included

Communication Interfaces

RS-232C CABLE 9637

9pin-9pin, cross
Cord length: 1.8 m (5.91 ft)

RS-232C CABLE 9638

9pin-25pin, cross
Cord length: 1.8 m (5.91 ft)

GP-IB CONNECTION CABLE 9151-02

Cord length: 2 m (6.56 ft)

Contact your local Hioki distributor for information about the pricing and specifications for the CONVERSION ADAPTER Z5010.

Supports 0201 Size Packages* Electrode for SMD Samples SM9060

Fine chip electrode with floating structures that can ignore jig surface resistance * EIA SIZE: 008004



Operability

Simple chuck for size 0201

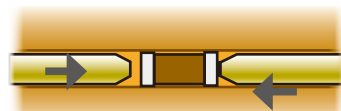

The fine chip is easily secured via the groove, and a dedicated wire probe firmly holds the sample.

Measurement Performance

Accurate measurement due to floating structures

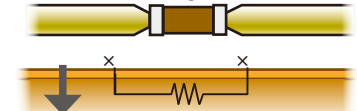

During an inspection, the stage lowers so that the surface resistance of the jig can be ignored, allowing the sample to be measured accurately.

When connecting electrodes to a SUPER MEGOHM METER, note a change of connectors is required.

MLCC Dedicated Leakage Current Test System

SUPER MEGOHM METER SM7420 (4CH) / SM7810 (8CH)

POWER SUPPLY UNIT SM7860

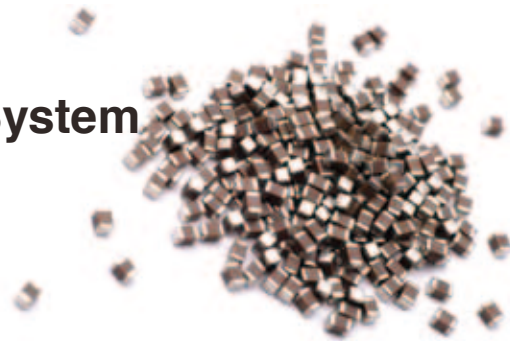

Provides Maximum Throughput for MLCC Tests

Characteristics of the MLCC Leakage Current Test System

This high-speed test system combines the 4ch microcurrent SUPER MEGOHM METER SM7420 with an external power source, or the 8ch SUPER MEGOHM METER SM7810, developed for leakage current tests, with a 32ch output POWER SUPPLY UNIT SM7860.

Perfect for equipping on automated machines, use this to construct the fastest MLCC leakage current inspection line.



8CH Leakage Current Test System

- The SUPER MEGOHM METER SM7810 achieves the fastest MLCC leakage current inspection line in the industry with **8ch simultaneous measurement up to a speed of 6.8 ms**, as well as **reduces automated machine takt time** to contribute to cost reduction for an MLCC super-mass production line.
- Select a POWER SUPPLY UNIT SM7860 based on maximum applied voltage and functionality to support all kinds of inspection lines including recharging and discharging.

■ SM7810 Specifications



No. of channels	8ch
Measurement method	Applies voltage to measured object and measures current
Applied voltage	Supplied from external power source (voltage input terminal on rear)
Ammeter input resistance	1 kΩ
External interfaces (Criteria setting, Operation)	GP-IB, RS-232C, EXT I/O (Excluding GP-IB address settings, all criteria settings / operations executed via external interface.)
Measured value display mode	Resistance / Current
Measurement speed	FAST, MED, SLOW, SLOW2
Measurement range	Current: 1 pA to 1 mA, Resistance: $1 \times 10^2 \Omega$ to $1 \times 10^{15} \Omega$
Range switching	HOLD / AUTO
Trigger delay	0 ms to 9999 ms (Resolution: 1 ms)
Averaging function	Averaging method: Moving average, OFF / ON (1 to 255) / AUTO
Measurement voltage setting	0.1 V to 1000.0 V (Resolution: 0.1 V)
Measurement comparison / Determination function	Compares measurement to reference value Determination: HI, IN, LO Setting scope of reference value: -9.9999E30 to 9.9999E30
Function	Contact check function / Jig capacity open correction function / Jig resistance open correction function

■ SM7860 Specifications



I/O terminal	Voltage output terminal (rear): Round special connector (8ch support)
External interfaces (Criteria setting, Operation)	GP-IB, RS-232C, EXT I/O (Excluding GP-IB address settings, all criteria settings / operations executed via external interface.)
Supported models	SUPER MEGOHM METER SM7810
Function	Voltage output
Operation method	Sink/source, supports recharging and discharging
Generation control	Output when OUTPUT signal of EXT I/O is ON
Output ON/OFF	Settable for individual channels
Voltage error alarm	Generates alarm when monitored voltage is outside set range, Valid setting range: ± 2 to $\pm 19\%$ (Resolution: 1%)
Current limit	Limit method: Limit independent on each channel Current limit direction: Current limit possible in both directions
Voltage monitor	Measures and displays output voltage for each system
Limitations	Voltage application object: Multi-layer ceramic capacitors Number of recharging channels: Within 8ch/system Operation criteria: Limitation on recharging interval

For detailed specifications, refer to the unit catalog, "SUPER MEGOHM METER SM7810 / POWER SOURCE UNIT SM7860."

Note: Company names and Product names appearing in this catalog are trademarks or registered trademarks of various companies.

HIOKI

HIOKI E. E. CORPORATION

HEADQUARTERS

81 Koizumi, Ueda, Nagano, 386-1192, Japan
TEL +81-268-28-0562 FAX +81-268-28-0568
<http://www.hioki.com> / E-mail: os-com@hioki.co.jp

HIOKI USA CORPORATION

TEL +1-609-409-9109 FAX +1-609-409-9108
<http://www.hiokiusa.com> / E-mail: hioki@hiokiusa.com

HIOKI (Shanghai) SALES & TRADING CO., LTD.
TEL +86-21-63910090 FAX +86-21-63910360
<http://www.hioki.cn> / E-mail: info@hioki.com.cn

HIOKI SINGAPORE PTE. LTD.
TEL +65-6634-7677 FAX +65-6634-7477
E-mail: info-sg@hioki.com.sg

HIOKI KOREA CO., LTD.
TEL +82-2-2183-8847 FAX +82-2-2183-3360
E-mail: info-kr@hioki.co.jp

DISTRIBUTED BY