

Communication Command Instruction Manual

PW3335(-01,-02,-03,-04) Power Meter

- ✓ This manual explains the communication commands for the above Power Meter models only.
- ✓ Be sure to review the Instruction Manual for your Power Meter before using the instrument.
- ✓ Please refer to the instruction manual for your Power Meter for details regarding command settings.
- ✓ All reasonable care has been taken in the production of this manual, but if you find any points which are unclear or in error, please contact your supplier or the International Sales and Marketing Department at HIOKI headquarters.
- ✓ In the interest of product development, the contents of this manual are subject to revision without prior notice.
- ✓ The content of this manual is protected by copyright.
No reproduction, duplication or modification of the content is permitted without the authorization of HIOKI E.E. Corporation.

Contents

1	Introduction	1
	Message Format	2
	Output Queue and Input Buffer	5
	Status Byte Register	6
	Event Registers	8
	Initialization Items	12
	Command Execution Time	13
	Errors During Communications	13
2	Message List	14
	Standard Commands	14
	Device-specific Commands (Event Registers)	14
	Device-specific Commands (Measurement Settings)	15
	Device-specific Commands (Voltage Range)	15
	Device-specific Commands (Current Range)	16
	Device-specific Commands (Frequency Range [Zero-crossing Filter])	17
	Device-specific Commands (Synchronization Source)	17
	Device-specific Commands (VT/CT Ratio)	18
	Device-specific Commands (D/A Output)	19
	Device-specific Commands (Instrument Display Settings)	20
	Device-specific Commands (Measurement Value Output)	21
	Device-specific Commands (Measurement Value Output Settings [Harmonic Wave])	28
	Device-specific Commands (Communications)	31
	Device-specific Commands (Dummy commands for maintaining compatibility with other models (333x, PW3336, PW3337, etc.))	31
3	Message Reference	32
	Message Reference Interpretation	32
	Standard Commands	33
	(1) System Data Command	33
	(2) Internal Operation Command	33
	(3) Synchronization Commands	34
	(4) Status and Event Control Commands	35
	Device-specific Commands	37
	(1) Event Status Register	37
	(2) Measurement Settings	38
	(3) Voltage Range	42
	(4) Current Range	46
	(5) Frequency Range (Zero-crossing Filter)	51
	(6) Synchronization Source	52
	(7) VT Ratio/CT Ratio	55
	(8) D/A output	56
	(9) Instrument Display Settings	62
	(10) Measurement Value Output	68
	(11) Communications Settings	106
	(12) Status-dependent Commands (Common Commands)	111
	(13) Status-dependent Commands (Device-specific Commands)	112
4	Operation Problems (Communications)	117
5	Device Documentation Requirements 	119

1 Introduction

This manual is for Power Meter models PW3335(-01, -02, -03,-04).

Messages are provided in the interface to control the Power Meter.

There are two types of messages: program messages that are sent from the controller (such as a computer) to the Power Meter and response messages that are sent from the Power Meter to the controller.

There are also execution confirmation messages for synchronization with the controller in the RS-232C interface.

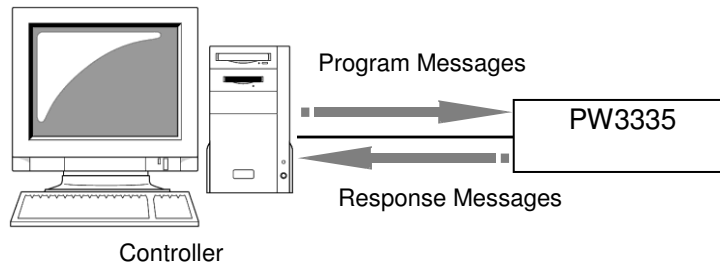

Message types are further categorized as follows.

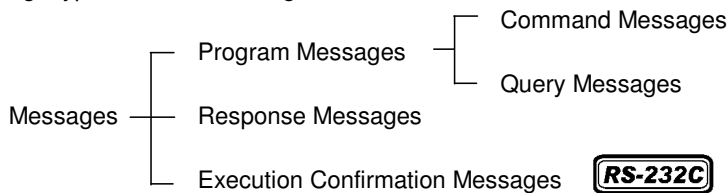

When issuing commands that contain data, make sure that the data is provided in the specified format.

When connecting via LAN, connect to TCP/IP port 3300.

LAN

NOTE

During communication the Power Meter will enter the Remote state and the **REMOTE Indicator** on the unit will turn ON.

When this occurs, all operation keys except for **SHIFT(EXIT/LOCAL)** will be disabled.

However, if the Power Meter is in the Local Lock Out state via GP-IB (GP-IB command [LLO:Local Lock Out -> P_11](#)), the **SHIFT(EXIT/LOCAL) Key** will also be disabled. If this occurs, execute the GTL (Go To Local) interface function or turn the Power Meter OFF and ON again to return to the Local state.

If the Power Meter enters the Remote state when on the settings screen, it will automatically change to the measurement display.

Message Format

■ Program Messages

Program messages can be either Command Messages or Query Messages.

(1) Command Messages

Instructions to control the instrument, such as to change settings or reset
Example: Instruction to set the voltage range.

:VOLTAGE:RANGE 300

↑
↑
↑
 Header portion Space Data portion

(2) Query Messages

Requests for responses relating to results of operation or measurement, or the state of instrument settings
Example: Request for the current measurement range

:VOLTAGE:RANGE?

↑
↑
 Header portion Question mark

See: "Headers (p. 2)", "Separators (p. 3)", "Data Formats (p.4)"

■ Response Messages

When a query message is received, its syntax is checked and a response message is generated.-
The **:HEADer** command determines whether headers are prefixed to response messages.

Header ON **:VOLTAGE:RANGE 300**
Header OFF **300**
(The current voltage range is 300 V.)

At power-on, Header ON is selected.

If an error occurs when a query message is received, no response message is generated for that query.

■ Command Syntax

Command names are chosen to mnemonically represent their function, and can be abbreviated. The full command name is called the "long form", and the abbreviated name is called the "short form". The command references in this manual indicate the short form in upper-case letters, extended to the long form in lower case letters, although the commands are not case-sensitive in actual usage.

DISPLAY?	OK (long form)
DISP?	OK (short form)
DISPL?	Error
DIS?	Error

Response messages generated by the instrument are in long form and in upper case letters.

■ Headers

Headers must always be prefixed to program messages.

(1) Command Program Headers

There are three types of commands: Simple, Compound, and Standard.

- **Headers for Simple Commands**

This header type is a sequence of letters and digits.

:ESE0

- **Headers for Compound Commands**

These headers consist of multiple simple command type headers separated by colons ":".

:VOLTage:RANGE

- **Headers for Standard Commands**

This header type begins with an asterisk "*", indicating that it is a standard command defined by IEEE 488.2.

***RST**

(2) **Query Program Header**

These commands are used to query the instrument about the results of operations, measured values, and the current states of instrument settings.

As shown in the following examples, a query is formed by appending a question mark ? after a program header.

:HOLD?

:VOLTage:RANGe?

Characters within square brackets [] may be omitted.

:MEASure[:NORMAL]:VALue?



Either form is valid

:MEASure:VALue?

■ Message Terminators

The instrument recognizes the following message terminators (delimiters):



- LF
- CR+LF
- EOI
- LF with an EOI

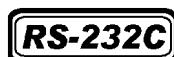

- CR
- CR+LF

Depending on the instrument's interface settings, the following can be selected as the terminator for response messages.

For information on settings, see "Terminator Setting" (p. 110).



- LF with an EOI
- CR+ LF with an EOI (default)

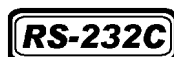

- LF
- CR+LF (default)

■ Separators

(1) **Message Unit Separator**

Multiple messages can be written in one line by separating them with semicolons ";".

:VOLTage:RANGe 300;AVERaging 10

- When messages are combined in this way and if one command contains an error, all subsequent messages up to the next terminator will be ignored.

(2) **Header Separator**

In a message consisting of both a header and data, the header is separated from the data by a space " " (ASCII code 20H).

: VOLTage: RANGe 300

(3) **Data Separator**

In a message containing multiple data items, commas are required to separate the data items from one another.

:MEASure? U, I

■ Data Formats

The instrument uses character data, decimal numeric data and character string data depending on the command.

(1) Character Data

Character data always begins with an alphabetic character, and subsequent characters may be either alphabetic or numeric. Character data is not case-sensitive, although response messages from the instrument are only upper case. When the command data portion contains `<1/0/ON/OFF>`, the operation will be the same as when 0 is OFF and 1 is ON.

:HEADER OFF

(2) Decimal Numeric Data

Three formats are used for numeric data: NR1, NR2 and NR3. Numeric values may be signed or unsigned. Unsigned numeric values are handled as positive values. Values exceeding the precision handled by the instrument are rounded to the nearest valid digit or truncated.

- NR1 Integer data (e.g.: +12, -23, 34)
- NR2 Fixed-point data (e.g.: +1.23, -23.45, 3.456)
- NR3 Floating-point exponential representation data (e.g.: +1.0E-2, -2.3E+4)

The term “NRf format” includes all three of the above numeric decimal formats.

The instrument accepts NRf format data. The format of response data is specified for each command, and the data is sent in that format.

:AVERAGING 10



The instrument does not completely support IEEE 488.2. Use referenced data whenever possible. Also be careful not to overflow the input buffer or output queue with a single command.

Compound Command Header Omission

When several commands having a common header are combined to form a compound command (for example, `:VOLTage:AUTO` and `:VOLTage:RANGe`), if they are written together in sequence, the common portion (here, `:VOLTage:`) can be omitted after its initial occurrence.

This common portion is called the “current path” (analogous to the path concept in computer file storage), and until it is cleared, the interpretation of subsequent commands presumes that they share the same common portion.

This usage of the current path is shown in the following example:

Full expression

:VOLTage:AUTO OFF;:VOLTage:RANGe 300

Compacted expression

:VOLTage:AUTO OFF;RANGe 300



The current path allows you to abbreviate the next command.

The current path is cleared when the power is turned on, when reset by key input, by a colon “:” at the start of a command, and when a message terminator is detected.

Standard command messages can be executed regardless of the current path. They have no effect upon the current path.

A colon “:” is not required at the start of the header of a Simple or Compound command. However, to avoid confusion with abbreviated forms and operating mistakes, we recommend always placing a colon at the start of a header.

Output Queue and Input Buffer

■ Output Queue

Response messages are stored in the output queue until read by the controller. The output queue is also cleared in the following circumstances:

- Power on
- Device clear
- Query error



The output queue capacity of the instrument is 4,096 bytes. If response messages overflow the buffer, a query error is generated and the output queue is cleared.

■ Input Buffer

The input buffer capacity of the instrument is 1,024 bytes.

If 1,024 bytes are allowed to accumulate in this buffer so that it becomes full, the GP-IB interface bus enters the waiting state until space is cleared in the buffer.

The RS-232C and LAN interfaces will not accept data beyond 1,024 bytes.

Note: Ensure that the length of a single line never exceeds 1,024 bytes.

Status Byte Register

The instrument uses the status model defined by the IEEE 488.2 standard for items related to serial polling via the service request function.

Events are what trigger service requests.

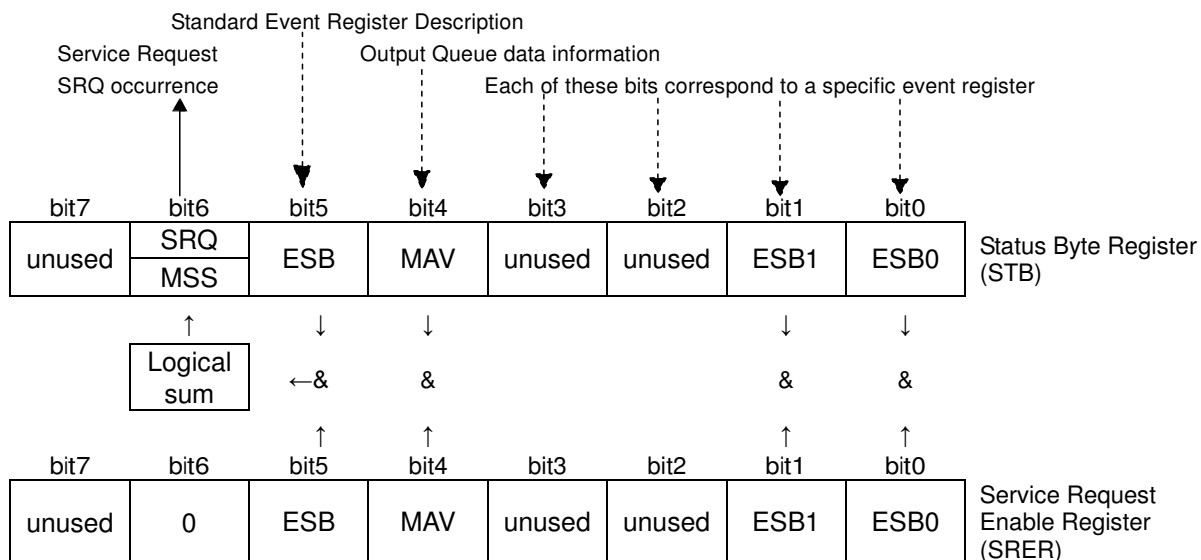

Overview of Service Request Occurrence

The Status Byte Register contains information about the event registers and the output queue. Required items are selected from this information by masking with the Service Request Enable Register.

When any bit selected by the mask is set, bit 6 (MSS; the Master Summary Status) of the Status Byte Register is also set, which generates an SRQ (Service Request) message and dispatches a service request.

SRQs (Service Requests) can be used only with the GP-IB interface.

However, SRER setting (***SRE?**) and STB read (***STB?**) queries can be used even with the RS-232C and LAN interfaces.

■ Status Byte Register (STB)

During serial polling, the contents of the 8-bit Status Byte Register are sent from the instrument to the controller. When any Status Byte Register bit enabled by the Service Request Enable Register has switched from 0 to 1, the MSS bit becomes 1. Consequently, the SRQ bit is set to 1, and a service request is dispatched.

The SRQ bit is always synchronous with service requests, and is read and simultaneously cleared during serial polling. Although the MSS bit is only read by an ***STB?** query, it is not cleared until a clear event is initiated by the ***CLS** command.

Bit 7		unused
Bit 6	SRQ	Set to 1 when a service request is dispatched.
	MSS	This is the logical sum of the other bits of the Status Byte Register.
Bit 5	ESB	Standard Event Status (logical sum) bit This is the logical sum of the Standard Event Status Register.
Bit 4	MAV	Message available Indicates that a message is present in the output queue.
Bit 3		unused
Bit 2		unused
Bit 1	ESB1	Event Summary (logical sum) bit 1 This is the logical sum of Event Status Register 1.
Bit 0	ESB0	Event Summary (logical sum) bit 0 This is the logical sum of Event Status Register 0.

■ Service Request Enable Register (SRER)

Setting a bit of this register to 1 enables the corresponding bit of the Status Byte Register to be used.

Event Registers

■ Standard Event Status Register (SESR)

The Standard Event Status Register is an 8-bit register.

If any bit in the Standard Event Status Register is set to 1 (after masking by the Standard Event Status Enable Register), bit 5 (ESB) of the Status Byte Register is set to 1.

See: "Standard Event Status Enable Register (SESER)" (p. 9)

The Standard Event Status Register is cleared in the following situations:

- When a ***CLS** command is executed
- When an event register query (***ESR?**) is executed
- When the instrument is powered on

Bit 7	PON	Power-On Flag Set to 1 when the power is turned on, or upon recovery from an outage.
Bit 6	URQ	User Request unused
Bit 5	CME	Command error (The command to the message terminator is ignored.) This bit is set to 1 when a received command contains a syntactic or semantic error: <ul style="list-style-type: none"> • Program header error • Incorrect number of data parameters • Invalid parameter format • Received a command not supported by the instrument
Bit 4	EXE	Execution Error This bit is set to 1 when a received command cannot be executed for some reason. <ul style="list-style-type: none"> • The specified data value is outside of the set range • The specified data cannot be set (data format discrepancy) • Execution is prevented by some other operation being performed
Bit 3	DDE	Device-dependent Error This bit is set to 1 when a command cannot be executed due to some reason other than a command error, a query error or an execution error. <ul style="list-style-type: none"> • An internal error occurred and execution cannot be performed (error displayed) • A command was received that cannot be executed during a restricted operation (integration, hold, etc.) • When "o.r", "S.Err" or "-----" occurs and the error data is read by a *MEASure? query.
Bit 2	QYE	Query Error (the output queue is cleared) This bit is set to 1 when a query error is detected by the output queue control. <ul style="list-style-type: none"> • When an attempt is made to read the output queue when the output queue is empty (GP-IB only) • When the data overflows the output queue • When the next command is received while there is data in the output queue • When there is a query after a *IDN? on the same line.
Bit 1	RQC (unused)	Request Control
Bit 0	OPC	Operation Complete This bit is set to 1 in response to an *OPC command. <ul style="list-style-type: none"> • It indicates the completion of operations of all messages up to the *OPC command

■ Standard Event Status Enable Register (SESER)

Setting any bit of the Standard Event Status Enable Register to 1 enables access to the corresponding bit of the Standard Event Status Register.

Standard Event Status Register (SESR) and Standard Event Status Enable Register (SESER)

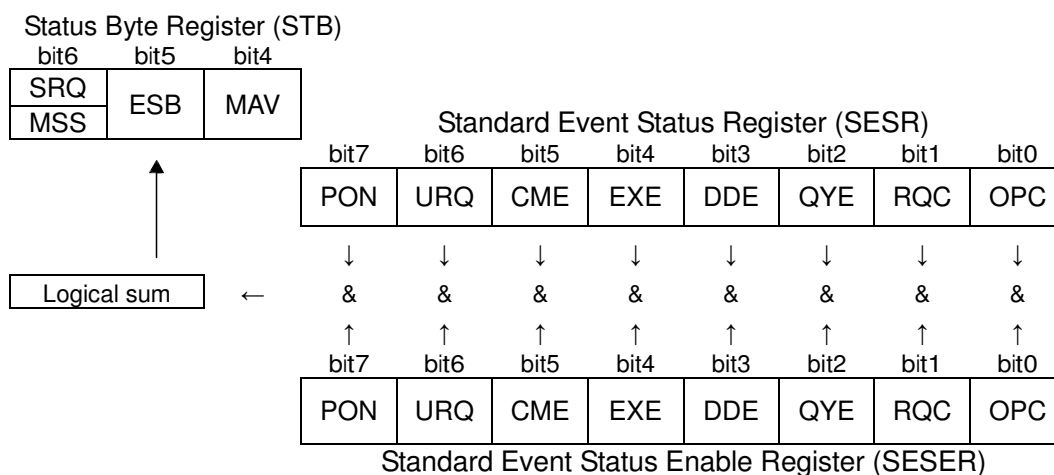

■ Device-specific Event Status Registers (ESR0, and ESR1)

This instrument provides four Event Status Registers for controlling events. Each event register is an 8-bit register.

When any bit in one of these Event Status Registers enabled by its corresponding Event Status Enable Register is set to 1, the following happens:

- For Event Status Register 0, bit 0 (ESB0) of the Status Byte Register (STB) is set to 1.
- For Event Status Register 1, bit 1 (ESB1) of the Status Byte Register (STB) is set to 1.

Event Status Registers 0 through 1 are cleared in the following situations:

- When a ***CLS** command is executed
- When an Event Status Register query (**:ESR0?**, or **:ESR1?**) is executed
- When the instrument is powered on

Event Status Register 0 (ESR0)		
Bit 7	DataSet	Data updated.
Bit 6	Change Setting Err	Data became invalid due to a hardware-related setting change. (For example, immediately after the range was changed.)
Bit 5	SyncErr	A synchronization error occurred on ch1, ch2, or ch3.
Bit 4	IntegrateEnd	Integration has completed.
Bit 3	AVeraGe update	Averaged data updated.
Bit 2	Current Protection	Instrument protection mode activated.
Bit 1	---	Unused.
Bit 0	Ext.Sync Error	Failed external synchronization for the data update.

Event Status Register 1 (ESR1)

Bit 7	Frequency Out of Range	The frequency(voltage or current) is invalid.
Bit 6	Over DataIntegrate	A peak overflow of voltage or current occurred in the active power integration value.
Bit 5	CurrentOver DataIntegrate	A peak overflow of current occurred in the current integration value.
Bit 4	Over-I	A peak overflow occurred in the current input.
Bit 3	Over-U	A peak overflow occurred in the voltage input.
Bit 2	High-P	The active power is over range.
Bit 1	High-I	The current is over range.
Bit 0	High-U	The voltage is over range.

Event Status Register 0 to 1 (ESR0 to ESR1) and
Event Status Enable Register 0 to 1 (ESER0 to ESER1)

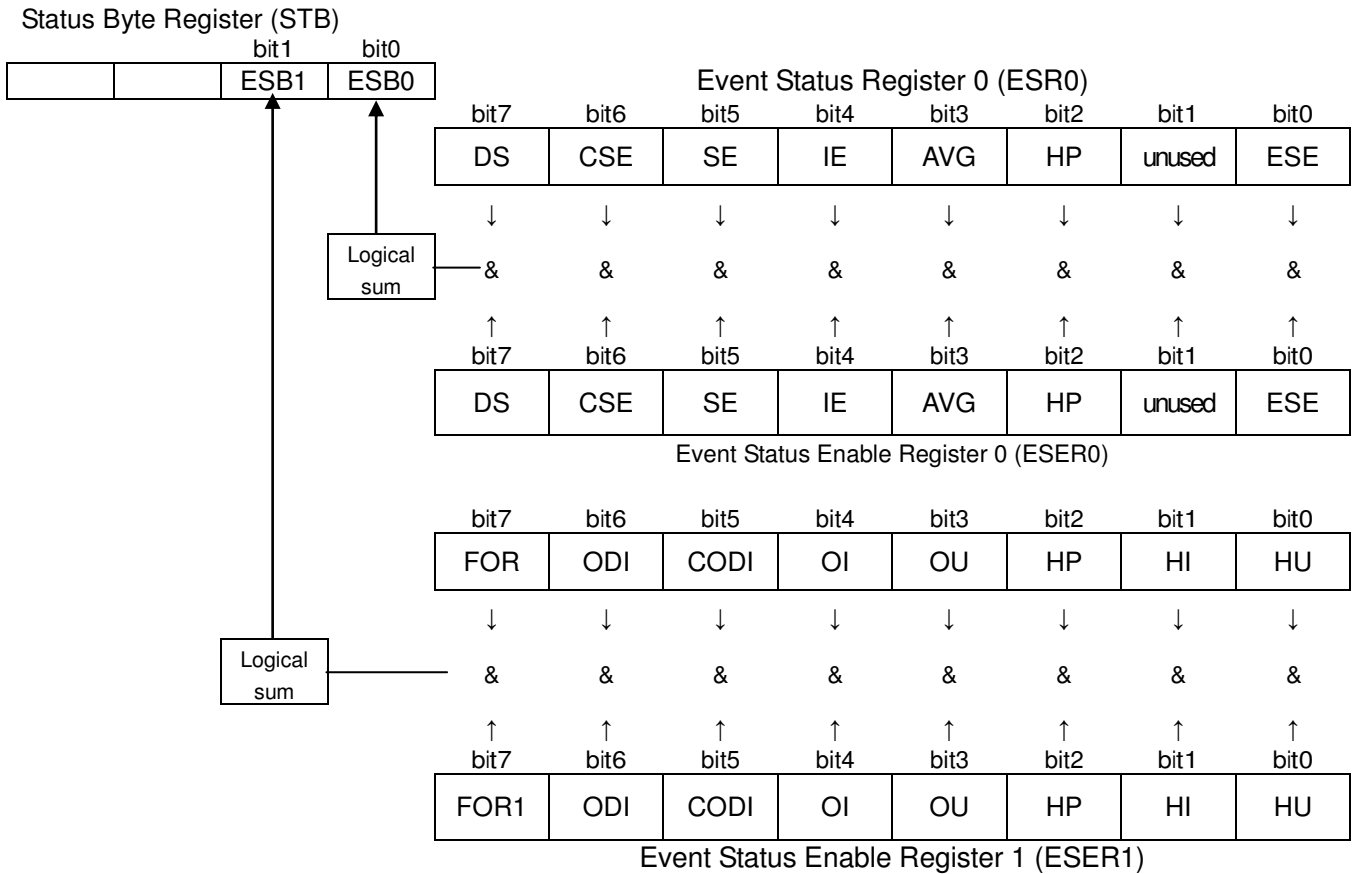

■ Register Reading and Writing

Register	Read	Write
Status Byte Register	*STB?	-
Service Request Enable Register	*SRE?	*SRE
Standard Event Status Register	*ESR?	-
Standard Event Status Enable Register	*ESE?	*ESE
Event Status Register 0	:ESR0?	-
Event Status Enable Register 0	:ESE0?	:ESE0
Event Status Register 1	:ESR1?	-
Event Status Enable Register 1	:ESE1?	:ESE1

■ GP-IB Commands

The following commands can be used through interface functions.

Command	Description	
GTL	Go To Local	Changes the instrument from the Remote state to the Local state.
LLO	Local Lock Out	Locks all keys on the instrument, including the Local Key.
DCL	Device CLear	Clears the input buffer and output queue.
SDC	Selected Device Clear	Clears the input buffer and output queue.
GET	Group Execute Trigger	Updates the displayed value while it is being held.

Initialization Items

Item	Initialization Method	At Power-on	System Reset	*RST Command	Device Clear (GP-IB only)	*CLS Command	Factory Default
GP-IB address		-	-	-	-	-	1
RS-232C setting (baud rate)		-	-	-	-	-	38400
LAN setting		-	-	-	-	-	*4
Device-specific functions (range, etc.)		-	●	●	-	-	*4
Output Queue		●	●	-	●	-	●
Input Buffer		●	●	-	●	-	●
Status Byte Register		●	●	-	-*1	●*2	●
Event registers		●*3	●	-	-	●	●
Enable register		●	●	-	-	-	0
Current path		●	●	-	●	-	●
Headers on/off		●	●	●	-	-	ON
Output items		●	●	●			*5,
Response message terminator		●	●	-	-	-	CR+LF
Response message separator		●	●	●	-	-	;

*1. Only the MAV bit (bit 4) is cleared.

*2. All bits except the MAV bit are cleared.

*3. Except the PON bit (bit 7).

*4. Refer to the user's manual for the instrument.

*5. See below.

Output Item Initialization

Measurement Item	
Voltage (U)	<input type="radio"/>
Current (I)	<input type="radio"/>
Active power (P)	<input type="radio"/>
Apparent power (S)	<input type="radio"/>
Reactive power (Q)	<input type="radio"/>
Power factor (PF)	<input type="radio"/>
Phase angle (DEG)	<input type="radio"/>
Voltage frequency (FREQU)	<input type="radio"/>
Current frequency (FREQI)	<input type="radio"/>
Harmonic wave voltage effective value (HU)	<input type="radio"/> (first-order only)
Harmonic wave current effective value (HU)	<input type="radio"/> (first-order only)
Harmonic wave power effective value (HU)	<input type="radio"/> (first-order only)

Output for all items other than those listed above is OFF by default.

Command Execution Time

Command execution time indicates the time for analyzing and processing long form commands. However, the command execution time for commands with data is the time described according to the data format specified in the <data portion>, and for query commands it is the time when the header is ON.

- The instrument performs measurements, calculations, and updates the display repeatedly in 200 ms cycles. Measurements and calculations are given priority over command processing, and require a maximum of 150 ms. Therefore, a maximum delay of 150 ms may be encountered from the time a command is received until analysis begins.

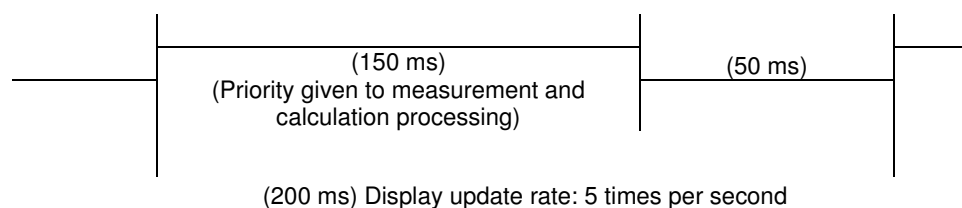

- Updating the display may be delayed if the analysis processing is not completed in time, even if the internal processing time is met.
- All commands are sequential.
- When communicating with a controller, the time required to transfer the data must be added. The amount of time required for the data transfer depends on the controller (communications). The RS-232C transfer time for a starting bit, data length of 8, no parity bit, and a stop bit (10 bits total) with a baud rate setting of N bps is calculated as follows:

$$\text{Transfer Time } T [1 \text{ character/second}] = \text{Baud Rate } N [\text{bps}] / 10 [\text{bits}]$$
 The measurement value is 11 characters so the time required to transfer one piece of data would be $11/T$.
 (Example) 9600 bps: $11 / (9600 / 10) = 11 \text{ ms}$ (approximately)
- Wait a few moments after making any changes via setting commands to allow the measurements to stabilize.

Command	Execution time (excluding communication time and delays to the start of analysis)
*WAI	200ms or less
The other commands	10 ms or less

Errors During Communications

An error occurs when messages are executed in the following cases:

- Command Error**
When message syntax (spelling) is invalid
When the data format in a command or query is invalid
- Query Error**
When the response message exceeds 4,000 bytes
When there is a query after an ***IDN?** query
- Execution Error**
When invalid character or numeric data is present
- Device-dependent Error**
When an error occurs during self-testing
When a restricted operation (such as changing the range) is attempted during an integration operation (when the INTEGRATOR indicator is lit or flashing)
When a restricted operation (such as changing the range) is attempted during the Hold state
When the ***TRG** command is executed in any state other than the Hold state

Note:

A command error will always occur if a message is spelled incorrectly or if any data is present after a query. When an error occurs with a query, no response message will be generated for that query.

2 Message List

The information in angled brackets < > represents the data format.

When the GP-IB interface is used, you can send an SRQ interrupt to the controller by setting the Event Status Register and *SRE.

Standard Commands

Message	Data Formats (Response data for queries)	Description	Reference Page
*CLS	_____	Clears the event registers and the Status Byte Register.	35
*ESE		Sets/Queries the Standard Event	
*ESE?	0 to 255	Status Enable Register.	35
*ESR?	0 to 255	Queries the Standard Event Status Register.	35
*IDN?	<Manufacturer name>, <Model name>, <Model type>, <Software version> <Serial number>	Queries the Device ID.	33
*OPC	_____	Sets bit 0 of the Standard Event Status Register to 1 after an operation completes.	34
*OPC?	1	Queries execution completion.	34
*OPT?	_____	Queries the device options.	33
*RST	_____	Initializes the device.	33
*SRE		Sets/Queries the Service Request Enable	
*SRE?	0 to 127	Register.	36
*STB?	0 to 127	Queries the Status Byte Register.	36
*TRG	_____	Updates the display once.	36
*TST?	0 to 4	Initiates a self-test and queries the result.	34
*WAI	_____	Waits until the next display update completes.	34

Device-specific Commands (Event Registers)

Message	Data Formats (Response data for queries)	Description	Reference Page
:ESE0		Sets/Queries Event Status Enable Register 0.	
:ESE0?	0 to 255		37
:ESR0?	(0 to 255)	Queries Event Status Register 0.	37
:ESE1		Sets/Queries Event Status Enable Register 1.	
:ESE1?	0 to 255		37
:ESR1?	(0 to 255)	Queries Event Status Register 1.	37

Device-specific Commands (Measurement Settings)

Message	Data Formats (Response data for queries)	Description	Reference Page
:AVERaging :AVERaging?	1/2/5/10/25/50/100	Sets/Queries the number of times to perform averaging.	38
:INTEGrate?		Queries the integration set time and the integration state.	39
:INTEGrate:STATe :INTEGrate:STATe?	START/STOP/RESET	Sets/Queries the integration state.	39
:INTEGrate:TIME :INTEGrate:TIME?	<Hour(NR1)>, <Minutes(NR1)>	Sets/Queries the integration time.	40
:INTEGrate:AUTO :INTEGrate:AUTO?	OFF/ON	Sets/Queries the AUTO レンジ積算の状态	40
:HARMonic:ORDer:UPPer :HARMonic:ORDer:UPPer?	<Order (2 to 50)>	Sets/Queries the upper limit order for harmonic wave analysis.	40
:HOLD :HOLD?	OFF/ON/MAX/MIN/RESET	Sets/Queries the holds or releases the display value.	41
:ZEROadjust		Performs a zero adjustment.	41
:ZEROadjust	<Zero adjustment execution state>	Queries the zero adjustment execution state.	41
:DEMAg :DEMAg?	<Zero adjustment execution state>	Performs a zero adjustment. Queries the zero adjustment execution state.	41
:SYNC:CONTRol :SYNC:CONTRol?	<Synchronization control setting>	Sets/Queries the synchronization control function.	42

Device-specific Commands (Voltage Range)

Message	Data Formats (Response data for queries)	Description	Reference Page
:VOLTage?	(<AUTO>,<Voltage Range>)	Queries the voltage range setting item (ch1 only).	42
:VOLTage:AUTO :VOLTage:AUTO?	ON/OFF	Sets (all channels) or queries (ch1 only) the voltage automatic range.	42
:VOLTage:RANGe :VOLTage:RANGe?	<Voltage Range (NR1)>	Sets (all channels) or queries (ch1 only) the voltage range.	43
:VOLTage:SElect:ALL?	ON/OFF	Sets whether to select all voltage ranges.	45
:VOLTage:SElect:U6V :VOLTage:SElect:U6V?	ON/OFF	Sets/Queries whether to select the 6 V voltage range.	45
:VOLTage:SElect:U15V :VOLTage:SElect:U15V?	ON/OFF	Sets/Queries whether to select the 15 V voltage range.	45
:VOLTage:SElect:U30V :VOLTage:SElect:U30V?	ON/OFF	Sets/Queries whether to select the 30 V voltage range.	45
:VOLTage:SElect:U60V :VOLTage:SElect:U60V?	ON/OFF	Sets/Queries whether to select the 60 V voltage range.	45
:VOLTage:SElect:U150V :VOLTage:SElect:U150V?	ON/OFF	Sets/Queries whether to select the 150 V voltage range.	45
:VOLTage:SElect:U300V :VOLTage:SElect:U300V?	ON/OFF	Sets/Queries whether to select the 300 V voltage range.	45
:VOLTage:SElect:U600V :VOLTage:SElect:U600V?	ON/OFF	Sets/Queries whether to select the 600 V voltage range.	45
:VOLTage:SElect:U1000V :VOLTage:SElect:U1000V?	ON/OFF	Sets/Queries whether to select the 1,000 V voltage range.	45
:VOLTage:SElect :VOLTage:SElect?	<Voltage range selection (NR1)>	Sets/Queries whether to select the voltage range (3332-compatible).	45

Device-specific Commands (Current Range)

Message	Data Formats (Response data for queries)	Description	Reference Page
:CURRent?	(<AUTO>, <Current Range>, ...)	Queries the current range setting item (ch1 only).	46
:CURRent:AUTO :CURRent:AUTO?	ON/OFF	Sets (all channels) or queries (ch1 only) the current automatic range.	46
:CURRent:RANGe :CURRent:RANGe?	<Current Range (NR1)>	Sets (all channels) or queries (ch1 only) the current range.	47
:CURRent:SElect:ALL	ON/OFF	Sets whether to select all current ranges.	47
:CURRent:SElect:I1mA :CURRent:SElect:I1mA?	ON/OFF	Sets/Queries whether to select the 1 mA current range (*1).	48
:CURRent:SElect:I2mA :CURRent:SElect:I2mA?	ON/OFF	Sets/Queries whether to select the 2 mA current range (*1).	48
:CURRent:SElect:I5mA :CURRent:SElect:I5mA?	ON/OFF	Sets/Queries whether to select the 5 mA current range (*1).	48
:CURRent:SElect:I10mA :CURRent:SElect:I10mA?	ON/OFF	Sets/Queries whether to select the 10 mA current range (*1).	48
:CURRent:SElect:I20mA :CURRent:SElect:I20mA?	ON/OFF	Sets/Queries whether to select the 20 mA current range (*1).	48
:CURRent:SElect:I50mA :CURRent:SElect:I50mA?	ON/OFF	Sets/Queries whether to select the 50 mA current range (*1).	48
:CURRent:SElect:I100mA	ON/OFF	Sets/Queries whether to select the 100 mA current range (*1).	48
:CURRent:SElect:I200mA :CURRent:SElect:I200mA?	ON/OFF	Sets/Queries whether to select the 200 mA current range (*1).	48
:CURRent:SElect:I500mA :CURRent:SElect:I500mA?	ON/OFF	Sets/Queries whether to select the 500 mA current range (*1).	48
:CURRent:SElect:I1A :CURRent:SElect:I1A?	ON/OFF	Sets/Queries whether to select the 1 A current range (*1).	48
:CURRent:SElect:I2A :CURRent:SElect:I2A?	ON/OFF	Sets/Queries whether to select the 2 A current range (*1).	48
:CURRent:SElect:I5A :CURRent:SElect:I5A?	ON/OFF	Sets/Queries whether to select the 5 A current range (*1).	48
:CURRent:SElect:I10A :CURRent:SElect:I10A?	ON/OFF	Sets/Queries whether to select the 10 A current range (*1).	48
:CURRent:SElect:I20A?	ON/OFF	Sets/Queries whether to select the 20 A current range (*1).	48
:CURRent:SElect :CURRent:SElect?	ON/OFF	Sets/queries whether to select the current range (3332-compatible).	49
:CURRent:EXTRange :CURRent:EXTRange?	<Clamp Current Range>	Sets (all channels) or queries (ch1 only) the current range (current sensor).	50
:CURRent:SElect:C1A :CURRent:SElect:C1A?	ON/OFF	Sets or queries whether to select the 1 A current sensor range.	48
:CURRent:SElect:C2A :CURRent:SElect:C2A?	ON/OFF	Sets or queries whether to select the 2 A current sensor range.	48
:CURRent:SElect:C5A?	ON/OFF	Sets or queries whether to select the 5 A current sensor range.	48
:CURRent:TYPE :CURRent:TYPE?	<Current Sensor Type>	Sets (all channels) or queries (ch1 only) the current sensor type.	49

*1: There is no abbreviated format available for the current range portion of the command (the "m" cannot be omitted).

Device-specific Commands (Frequency Range [Zero-crossing Filter])

The frequency range and zero-crossing filter settings are linked.

Message	Data Formats (Response data for queries)	Description	Reference Page
:FREQuency?	<Frequency Range (NR3)>	Queries the frequency range (zero-crossing filter).	51
:FREQuency:RANGe :FREQuency:RANGe?	<Frequency Range (NR3)>	Sets or queries the frequency range (zero-crossing filter).	51

Device-specific Commands (Synchronization Source)

Message	Data Formats (Response data for queries)	Description	Reference Page
:SOURce :SOURce?	<Synchronization Source>	Sets (all channels) or queries (ch1 only) the synchronization source.	52
:SOURce:TIMEOut :SOURce:TIMEOut?	0.1/1/10	Sets (all channels) or queries (ch1 only) the synchronization timeout.	52
:SOURce:FLTer:LEVel:ALL	1~15	Sets all synchronization source detection levels.	52
:SOURce:FLTer:LEVel:U6V :SOURce:FLTer:LEVel:U6V?	1~15	Sets/Queries the voltage synchronization source detection level.	53
:SOURce:FLTer:LEVel:U15V :SOURce:FLTer:LEVel:U15V?	1~15	Sets/Queries the voltage synchronization source detection level.	53
:SOURce:FLTer:LEVel:U30V :SOURce:FLTer:LEVel:U30V?	1~15	Sets/Queries the voltage synchronization source detection level.	53
:SOURce:FLTer:LEVel:U60V :SOURce:FLTer:LEVel:U60V?	1~15	Sets/Queries the voltage synchronization source detection level.	53
:SOURce:FLTer:LEVel:U150V :SOURce:FLTer:LEVel:U150V?	1~15	Sets/Queries the voltage synchronization source detection level.	53
:SOURce:FLTer:LEVel:U300V :SOURce:FLTer:LEVel:U300V?	1~15	Sets/Queries the voltage synchronization source detection level.	53
:SOURce:FLTer:LEVel:U600V :SOURce:FLTer:LEVel:U600V?	1~15	Sets/Queries the voltage synchronization source detection level.	53
:SOURce:FLTer:LEVel:U1000V :SOURce:FLTer:LEVel:U1000V?	1~15	Sets/Queries the voltage synchronization source detection level.	53
:SOURce:FLTer:LEVel:I1mA :SOURce:FLTer:LEVel:I1mA?	1~15	Sets/Queries the current synchronization source detection level (*1).	53
:SOURce:FLTer:LEVel:I2mA :SOURce:FLTer:LEVel:I2mA?	1~15	Sets/Queries the current synchronization source detection level (*1).	53
:SOURce:FLTer:LEVel:I5mA :SOURce:FLTer:LEVel:I5mA?	1~15	Sets/Queries the current synchronization source detection level (*1).	53
:SOURce:FLTer:LEVel:I10mA :SOURce:FLTer:LEVel:I10mA?	1~15	Sets/Queries the current synchronization source detection level (*1).	53
:SOURce:FLTer:LEVel:I20mA :SOURce:FLTer:LEVel:I20mA?	1~15	Sets/Queries the current synchronization source detection level (*1).	53
:SOURce:FLTer:LEVel:I50mA :SOURce:FLTer:LEVel:I50mA?	1~15	Sets/Queries the current synchronization source detection level (*1).	53
:SOURce:FLTer:LEVel:I100mA :SOURce:FLTer:LEVel:I100mA?	1~15	Sets/Queries the current synchronization source detection level (*1).	53
:SOURce:FLTer:LEVel:I200mA :SOURce:FLTer:LEVel:I200mA?	1~15	Sets/Queries the current synchronization source detection level (*1).	53
:SOURce:FLTer:LEVel:I500mA :SOURce:FLTer:LEVel:I500mA?	1~15	Sets/Queries the current synchronization source detection level (*1).	53
:SOURce:FLTer:LEVel:I1A :SOURce:FLTer:LEVel:I1A?	1~15	Sets/Queries the current synchronization source detection level.	53
:SOURce:FLTer:LEVel:I2A	1~15	Sets/Queries the current synchronization source	53

:SOURce:FILTER:LEVel:12A?		detection level.	
:SOURce:FILTER:LEVel:15A	1~15	Sets or queries the current synchronization source detection level.	53
:SOURce:FILTER:LEVel:15A?			
:SOURce:FILTER:LEVel:110A	1~15	Sets or queries the current synchronization source detection level.	53
:SOURce:FILTER:LEVel:110A?			
:SOURce:FILTER:LEVel:120A	1~15	Sets or queries the current synchronization source detection level.	53
:SOURce:FILTER:LEVel:120A?			
:SOURce:FILTER:LEVel:C1A	1~15	Sets or queries the current (external sensor) synchronization source detection level.	54
:SOURce:FILTER:LEVel:C1A?			
:SOURce:FILTER:LEVel:C2A	1~15	Sets or queries the current (external sensor) synchronization source detection level.	54
:SOURce:FILTER:LEVel:C2A?			
:SOURce:FILTER:LEVel:C5A	1~15	Sets or queries the current (external sensor) synchronization source detection level.	54
:SOURce:FILTER:LEVel:C5A?			

*1: There is no abbreviated format available for the current range portion of the command (the “m” in “1 mA” and similar text cannot be omitted).

Device-specific Commands (VT/CT Ratio)

Message	Data Formats (Response data for queries)	Description	Reference Page
:SCALE?	(<VT Ratio>, <CT Ratio>)	Queries the VT and CT ratios.	55
:SCALE:VT	<VT Ratio (NRf)>	Sets or queries the VT ratio.	55
:SCALE:VT?			
:SCALE:CT	<CT Ratio (NRf)>	Sets or queries the CT ratio.	55
:SCALE:CT?			

Device-specific Commands (D/A Output)

Message	Data Formats (Response data for queries)	Description	Reference Page
:AOUT?		Queries (D/A1 output items only) D/A output items.	56
:AOUT:ITEM:DA1	<Output Item>	Sets/Queries the D/A1 terminal output item.	56
:AOUT:ITEM:DA1?			
:AOUT:ITEM:DA2	<Output Item>	Sets/Queries the D/A2 terminal output item.	56
:AOUT:ITEM:DA2?			
:AOUT:ITEM:DA3	<Output Item>	Sets/Queries the D/A3 terminal output item.	56
:AOUT:ITEM:DA3?			
:AOUT:ITEM:DA4	<Output Item>	Sets/Queries the D/A4 terminal output item.	56
:AOUT:ITEM:DA4?			
:AOUT:ITEM:DA5	<Output Item>	Sets/Queries the D/A5 terminal output item.	56
:AOUT:ITEM:DA5?			
:AOUT:ITEM:DA6	<Output Item>	Sets/Queries the D/A6 terminal output item.	56
:AOUT:ITEM:DA6?			
:AOUT:ITEM:DA7	<Output Item>	Sets/Queries the D/A7 terminal output item.	56
:AOUT:ITEM:DA7?			
:AOUT:IRANge:DA1	<Integrated value current range (NR2)>	Sets/Queries the current range selected output item when outputting the D/A1 terminal integrated value.	57
:AOUT:IRANge:DA1?			
:AOUT:IRANge:DA2	<Integrated value current range (NR2)>	Sets/Queries the current range selected output item when outputting the D/A2 terminal integrated value.	57
:AOUT:IRANge:DA2?			
:AOUT:IRANge:DA3	<Integrated value current range (NR2)>	Sets/Queries the current range selected output item when outputting the D/A3 terminal integrated value.	57
:AOUT:IRANge:DA3?			
:AOUT:IRANge:DA4	<Integrated value current range (NR2)>	Sets/Queries the current range selected output item when outputting the D/A4 terminal integrated value.	57
:AOUT:IRANge:DA4?			
:AOUT:IRANge:DA5	<Integrated value current range (NR2)>	Sets/Queries the current range selected output item when outputting the D/A5 terminal integrated value.	57
:AOUT:IRANge:DA5?			
:AOUT:IRANge:DA6	<Integrated value current range (NR2)>	Sets/Queries the current range selected output item when outputting the D/A6 terminal integrated value.	57
:AOUT:IRANge:DA6?			
:AOUT:IRANge:DA7	<Integrated value current range (NR2)>	Sets/Queries the current range selected output item when outputting the D/A7 terminal integrated value.	57
:AOUT:IRANge:DA7?			

Device-specific Commands (Instrument Display Settings)

Message ([]: Can be omitted)	Data Formats (Response data for queries)	Description	Reference Page
:DISPlay[:NORMal] :DISPlay[:NORMal]?	<Display a>, <Display b>, <Display c>, <Display d>	Sets/Queries instrument display items (a) through (d).	62
:DISPlay:NORMal:A :DISPlay:NORMal:A?	<Display a>	Sets/Queries instrument display item (a).	62
:DISPlay:NORMal:B :DISPlay:NORMal:B?	<Display b>	Sets/Queries instrument display item (b).	62
:DISPlay:NORMal:C :DISPlay:NORMal:C?	<Display c>	Sets/Queries instrument display item (c).	62
:DISPlay:NORMal:D :DISPlay:NORMal:D?	<Display d>	Sets/Queries instrument display item (d).	62
:DISPlay:MODE :DISPlay:MODE?	<Display Specification>	Sets/Queries the instrument display mode (normal/harmonic wave).	66
:DISPlay:HARMonic:ORDER :DISPlay:HARMonic:ORDER?	<Harmonic Wave Order 0 to 50>	Sets/Queries the display order for harmonic wave order common display.	66
:DISPlay:HARMonic:B:ITEM :DISPlay:HARMonic:B:ITEM?	<Harmonic Wave Display Item>	Sets/Queries the display item (b) for harmonic wave order common display.	66
:DISPlay:HARMonic:C:ITEM :DISPlay:HARMonic:C:ITEM?	<Harmonic Wave Display Item>	Sets/Queries the display item (c) for harmonic wave order common display.	66
:DISPlay:HARMonic:D:ITEM :DISPlay:HARMonic:D:ITEM?	<Harmonic Wave Display Item>	Sets/Queries the display item (d) for harmonic wave order common display.	66
:DISPlay:HORDERsel:A:ORDER :DISPlay:HORDERsel:A:ORDER?	<Harmonic Wave Order 0 to 50>	Display order (a) for harmonic wave order individual display.	67
:DISPlay:HORDERsel:A:ITEM :DISPlay:HORDERsel:A:ITEM?	<Harmonic Wave Display Item>	Display item (a) for harmonic wave order individual display.	67
:DISPlay:HORDERsel:B:ORDER :DISPlay:HORDERsel:B:ORDER?	<Harmonic Wave Order 0 to 50>	Display order (b) for harmonic wave order individual display.	67
:DISPlay:HORDERsel:B:ITEM :DISPlay:HORDERsel:B:ITEM?	<Harmonic Wave Display Item>	Display item (b) for harmonic wave order individual display.	67
:DISPlay:HORDERsel:C:ORDER :DISPlay:HORDERsel:C:ORDER?	<Harmonic Wave Order 0 to 50>	Display order (c) for harmonic wave order individual display.	67
:DISPlay:HORDERsel:C:ITEM :DISPlay:HORDERsel:C:ITEM?	<Harmonic Wave Display Item>	Display item (c) for harmonic wave order individual display.	67
:DISPlay:HORDERsel:D:ORDER :DISPlay:HORDERsel:D:ORDER?	<Harmonic Wave Order 0 to 50>	Display order (d) for harmonic wave order individual display.	67
:DISPlay:HORDERsel:D:ITEM :DISPlay:HORDERsel:D:ITEM?	<Harmonic Wave Display Item>	Display item (d) for harmonic wave order individual display.	67

Device-specific Commands (Measurement Value Output)

Note: :MEASure[:NORMAL]:ITEM:U:CH1(?) → Setting Command:MEASure[:NORMAL]:ITEM:U:CH1
Query :MEASure[:NORMAL]:ITEM:U:CH1?

Message ([:]: Can be omitted)	Data Formats (Response data for queries)	Description	Reference Page
:MEASure[:Power]? :MEASure[:Normal]:VALue?	<Measurement Item 1> ... Maximum 180	Queries measurement data.	68
:MEASure:ITEM:ALLClear		Turns OFF all output items (including harmonic wave).	75
:MEASure[:Normal]:ITEM?		Queries output items.	75
:DATAout:ITEM(?)	(<Output Item 1>, <Output Item 2>)	“:MEASure?” query output specification (3332-compatible)	76
:MEASure[:Normal]:ITEM:STATUS:INST(?) :MEASure[:Normal]:ITEM:STATUS:MAXmin(?)	<Output Item 0/1>	“:MEASure?” query Set/Query the measurement status output.	77
:MEASure[:Normal]:ITEM:U:ALL :MEASure[:Normal]:ITEM:U:CH1(?)	<Output Item (Rectification Method)>	“:MEASure?” query Sets/Queries the voltage (instantaneous value) data output.	78
:MEASure[:Normal]:ITEM:U_MAX:ALL :MEASure[:Normal]:ITEM:U_MAX:CH1(?)	<Output Item (Rectification Method)>	“:MEASure?” query Sets/Queries the voltage (maximum value) data output.	78
:MEASure[:Normal]:ITEM:U_MIN:ALL :MEASure[:Normal]:ITEM:U_MIN:CH1(?)	<Output Item (Rectification Method)>	“:MEASure?” query Sets/Queries the voltage (minimum value) data output.	78
:MEASure[:Normal]:ITEM:I:ALL :MEASure[:Normal]:ITEM:I:CH1(?)	<Output Item (Rectification Method)>	“:MEASure?” query Sets/Queries the current (instantaneous value) data output.	78
:MEASure[:Normal]:ITEM:I_MAX:ALL :MEASure[:Normal]:ITEM:I_MAX:CH1(?)	<Output Item (Rectification Method)>	“:MEASure?” query Sets/Queries the current (maximum value) data output.	78
:MEASure[:Normal]:ITEM:I_MIN:ALL :MEASure[:Normal]:ITEM:I_MIN:CH1(?)	<Output Item (Rectification Method)>	“:MEASure?” query Sets/Queries the current (minimum value) data output.	78
:MEASure[:Normal]:ITEM:P:ALL :MEASure[:Normal]:ITEM:P:CH1(?)	<Output Item (Rectification Method)>	“:MEASure?” query Sets/Queries the active power (instantaneous value) data output.	79
:MEASure[:Normal]:ITEM:P_MAX:ALL :MEASure[:Normal]:ITEM:P_MAX:CH1(?)	<Output Item (Rectification Method)>	“:MEASure?” query Sets/Queries the active power (maximum value) data output.	79
:MEASure[:Normal]:ITEM:P_MIN:ALL :MEASure[:Normal]:ITEM:P_MIN:CH1(?)	<Output Item (Rectification Method)>	“:MEASure?” query Sets/Queries the active power (minimum value) data output.	79

Message ([] : Can be omitted)	Data Formats (Response data for queries)	Description	Reference Page
:MEASure[:NORMAL]:ITEM:S:ALL :MEASure[:NORMAL]:ITEM:S:CH1(?)	<Output Item (Rectification Method)>	“:MEASure?” query Sets/Queries the apparent power (instantaneous value) data output.	79
:MEASure[:NORMAL]:ITEM:S_MAX:ALL :MEASure[:NORMAL]:ITEM:S_MAX:CH1(?)	<Output Item (Rectification Method)>	“:MEASure?” query Sets/Queries the apparent power (maximum value) data output.	79
:MEASure[:NORMAL]:ITEM:S_MIN:ALL :MEASure[:NORMAL]:ITEM:S_MIN:CH1(?)	<Output Item (Rectification Method)>	“:MEASure?” query Sets/Queries the apparent power (minimum value) data output.	79
:MEASure[:NORMAL]:ITEM:Q:ALL :MEASure[:NORMAL]:ITEM:Q:CH1(?)	<Output Item (Rectification Method)>	“:MEASure?” query Sets/Queries the reactive power (instantaneous value) data output.	80
:MEASure[:NORMAL]:ITEM:Q_MAX:ALL :MEASure[:NORMAL]:ITEM:Q_MAX:CH1(?)	<Output Item (Rectification Method)>	“:MEASure?” query Sets/Queries the reactive power (maximum value) data output.	80
:MEASure[:NORMAL]:ITEM:Q_MIN:ALL :MEASure[:NORMAL]:ITEM:Q_MIN:CH1(?)	<Output Item (Rectification Method)>	“:MEASure?” query Sets/Queries the reactive power (minimum value) output data.	80
:MEASure[:NORMAL]:ITEM:PF:ALL :MEASure[:NORMAL]:ITEM:PF:CH1(?)	<Output Item (Rectification Method)>	“:MEASure?” query Sets/Queries the power factor (instantaneous value) data output.	80
:MEASure[:NORMAL]:ITEM:PF_MAX:ALL :MEASure[:NORMAL]:ITEM:PF_MAX:CH1(?)	<Output Item (Rectification Method)>	“:MEASure?” query Sets/Queries the power factor (maximum value) data output.	80
:MEASure[:NORMAL]:ITEM:PF_MIN:ALL :MEASure[:NORMAL]:ITEM:PF_MIN:CH1(?)	<Output Item (Rectification Method)>	“:MEASure?” query Sets/Queries the power factor (minimum value) data output.	80
:MEASure[:NORMAL]:ITEM:DEG:ALL :MEASure[:NORMAL]:ITEM:DEG:CH1(?)	<Output Item (Rectification Method)>	“:MEASure?” query Sets/Queries the phase angle (instantaneous value) data output.	81
:MEASure[:NORMAL]:ITEM:DEG_MAX:ALL :MEASure[:NORMAL]:ITEM:DEG_MAX:CH1(?)	<Output Item (Rectification Method)>	“:MEASure?” query Sets/Queries the phase angle (maximum value) data output.	81
:MEASure[:NORMAL]:ITEM:DEG_MIN:ALL :MEASure[:NORMAL]:ITEM:DEG_MIN:CH1(?)	<Output Item (Rectification Method)>	“:MEASure?” query Sets/Queries the phase angle (minimum value) data output.	81
:MEASure[:NORMAL]:ITEM:FREQU:ALL :MEASure[:NORMAL]:ITEM:FREQU:CH1(?)	<Output Setting 0/1>	“:MEASure?” query Sets/Queries the voltage frequency (instantaneous value) data output.	81
:MEASure[:NORMAL]:ITEM:FREQU_MAX:ALL :MEASure[:NORMAL]:ITEM:FREQU_MAX:CH1(?)	<Output Setting 0/1>	“:MEASure?” query Sets/Queries the voltage frequency (maximum value) data output.	81

Message ([] : Can be omitted)	Data Formats (Response data for queries)	Description	Reference Page
:MEASure[:NORMAL]:ITEM:FREQU_MIN:ALL :MEASure[:NORMAL]:ITEM:FREQU_MIN:CH1(?)	<Output Setting 0/1>	“:MEASure?” query Sets/Queries the voltage frequency (minimum value) data output.	81
:MEASure[:NORMAL]:ITEM:FREQI:ALL :MEASure[:NORMAL]:ITEM:FREQI:CH1(?)	<Output Setting 0/1>	“:MEASure?” query Sets/Queries the current frequency (instantaneous value) data output.	82
:MEASure[:NORMAL]:ITEM:FREQI_MAX:ALL :MEASure[:NORMAL]:ITEM:FREQI_MAX:CH1(?)	<Output Setting 0/1>	“:MEASure?” query Sets/Queries the current frequency (maximum value) data output.	82
:MEASure[:NORMAL]:ITEM:FREQI_MIN:ALL :MEASure[:NORMAL]:ITEM:FREQI_MIN:CH1(?)	<Output Setting 0/1>	“:MEASure?” query Sets/Queries the current frequency (minimum value) data output.	82
:MEASure[:NORMAL]:ITEM:TIME(?) (Data by current range during auto-range integration)			
:MEASure[:NORMAL]:ITEM:TIME:I200mA(?) :MEASure[:NORMAL]:ITEM:TIME:I500mA(?) :MEASure[:NORMAL]:ITEM:TIME:I1A(?) :MEASure[:NORMAL]:ITEM:TIME:I2A(?) :MEASure[:NORMAL]:ITEM:TIME:I5A(?) :MEASure[:NORMAL]:ITEM:TIME:I10A(?) :MEASure[:NORMAL]:ITEM:TIME:I20A(?) :MEASure[:NORMAL]:ITEM:TIME:BACKup(?)	<Output Setting 0/1>	“:MEASure?” query Sets/Queries the integration time data output.	82
:MEASure[:NORMAL]:ITEM:IH:ALL :MEASure[:NORMAL]:ITEM:IH:CH1(?) (Data by current range during auto-range integration)			
:MEASure[:NORMAL]:ITEM:IH:CH1:I200mA(?) :MEASure[:NORMAL]:ITEM:IH:CH1:I500mA(?) :MEASure[:NORMAL]:ITEM:IH:CH1:I1A(?) :MEASure[:NORMAL]:ITEM:IH:CH1:I2A(?) :MEASure[:NORMAL]:ITEM:IH:CH1:I5A(?) :MEASure[:NORMAL]:ITEM:IH:CH1:I10A(?) :MEASure[:NORMAL]:ITEM:IH:CH1:I20A(?) :MEASure[:NORMAL]:ITEM:IH:CH1:BACKup(?)	<Output Item (Rectification Method)>	“:MEASure?” query Sets/Queries the integration current (total sum) data output.	83
:MEASure[:NORMAL]:ITEM:PIH:ALL :MEASure[:NORMAL]:ITEM:PIH:CH1(?) (Data by current range during auto-range integration)			
:MEASure[:NORMAL]:ITEM:PIH:CH1:I200mA(?) :MEASure[:NORMAL]:ITEM:PIH:CH1:I500mA(?) :MEASure[:NORMAL]:ITEM:PIH:CH1:I1A(?) :MEASure[:NORMAL]:ITEM:PIH:CH1:I2A(?) :MEASure[:NORMAL]:ITEM:PIH:CH1:I5A(?) :MEASure[:NORMAL]:ITEM:PIH:CH1:I10A(?) :MEASure[:NORMAL]:ITEM:PIH:CH1:I20A(?) :MEASure[:NORMAL]:ITEM:PIH:CH1:BACKup(?)	<Output Item (Rectification Method)>	“:MEASure?” query Sets/Queries the positive integration current data output.	84

Message ([] : Can be omitted)	Data Formats (Response data for queries)	Description	Reference Page
:MEASure[:NORMAL]:ITEM:MIH:ALL :MEASure[:NORMAL]:ITEM:MIH:CH1(?)			
(Data by current range during auto-range integration)			
:MEASure[:NORMAL]:ITEM:MIH:CH1:I200mA(?) :MEASure[:NORMAL]:ITEM:MIH:CH1:I500mA(?) :MEASure[:NORMAL]:ITEM:MIH:CH1:I1A(?) :MEASure[:NORMAL]:ITEM:MIH:CH1:I2A(?) :MEASure[:NORMAL]:ITEM:MIH:CH1:I5A(?) :MEASure[:NORMAL]:ITEM:MIH:CH1:I10A(?) :MEASure[:NORMAL]:ITEM:MIH:CH1:I20A(?) :MEASure[:NORMAL]:ITEM:MIH:CH1:BACKup(?)	<Output Item (Rectification Method)>	“:MEASure?” query Sets/Queries the negative integration current data output.	85
:MEASure[:NORMAL]:ITEM:WP:ALL :MEASure[:NORMAL]:ITEM:WP:CH1(?)			
(Data by current range during auto-range integration)			
:MEASure[:NORMAL]:ITEM:WP:CH1:I200mA(?) :MEASure[:NORMAL]:ITEM:WP:CH1:I500mA(?) :MEASure[:NORMAL]:ITEM:WP:CH1:I1A(?) :MEASure[:NORMAL]:ITEM:WP:CH1:I2A(?) :MEASure[:NORMAL]:ITEM:WP:CH1:I5A(?) :MEASure[:NORMAL]:ITEM:WP:CH1:I10A(?) :MEASure[:NORMAL]:ITEM:WP:CH1:I20A(?) :MEASure[:NORMAL]:ITEM:WP:CH1:BACKup(?)	<Output Item (Rectification Method)>	“:MEASure?” query Sets/Queries the integration active power (total sum) data output.	86
:MEASure[:NORMAL]:ITEM:PWP:ALL :MEASure[:NORMAL]:ITEM:PWP:CH1(?)			
(Data by current range during auto-range integration)			
:MEASure[:NORMAL]:ITEM:PWP:CH1:I200mA(?) :MEASure[:NORMAL]:ITEM:PWP:CH1:I500mA(?) :MEASure[:NORMAL]:ITEM:PWP:CH1:I1A(?) :MEASure[:NORMAL]:ITEM:PWP:CH1:I2A(?) :MEASure[:NORMAL]:ITEM:PWP:CH1:I5A(?) :MEASure[:NORMAL]:ITEM:PWP:CH1:I10A(?) :MEASure[:NORMAL]:ITEM:PWP:CH1:I20A(?) :MEASure[:NORMAL]:ITEM:PWP:CH1:BACKup(?)	<Output Item (Rectification Method)>	“:MEASure?” query Sets/Queries the integration active power (positive) data output.	87
:MEASure[:NORMAL]:ITEM:MWP:ALL :MEASure[:NORMAL]:ITEM:MWP:CH1(?)			
(Data by current range during auto-range integration)			
:MEASure[:NORMAL]:ITEM:MWP:CH1:I200mA(?) :MEASure[:NORMAL]:ITEM:MWP:CH1:I500mA(?) :MEASure[:NORMAL]:ITEM:MWP:CH1:I1A(?) :MEASure[:NORMAL]:ITEM:MWP:CH1:I2A(?) :MEASure[:NORMAL]:ITEM:MWP:CH1:I5A(?) :MEASure[:NORMAL]:ITEM:MWP:CH1:I10A(?) :MEASure[:NORMAL]:ITEM:MWP:CH1:I20A(?) :MEASure[:NORMAL]:ITEM:MWP:CH1:BACKup(?)	<Output Item (Rectification Method)>	“:MEASure?” query Sets/Queries the integration active power (negative) data output.	88
:MEASure[:NORMAL]:ITEM:UPK:ALL :MEASure[:NORMAL]:ITEM:UPK:CH1(?)	<Output Setting 0/1>	“:MEASure?” query Sets/Queries the voltage waveform peak value (instantaneous value) data output.	89

Message ([]: Can be omitted)	Data Formats (Response data for queries)	Description	Reference Page
:MEASure[:NORMAL]:ITEM:UPK_MAX:ALL :MEASure[:NORMAL]:ITEM:UPK_MAX:CH1(?)	<Output Setting 0/1>	“:MEASure?” query Sets/Queries the voltage waveform peak value (maximum value) data output.	89
:MEASure[:NORMAL]:ITEM:UPK_MIN:ALL :MEASure[:NORMAL]:ITEM:UPK_MIN:CH1(?)	<Output Setting 0/1>	“:MEASure?” query Sets/Queries the voltage waveform peak value (minimum value) data output.	89
:MEASure[:NORMAL]:ITEM:IPK:ALL :MEASure[:NORMAL]:ITEM:IPK:CH1(?)	<Output Setting 0/1>	“:MEASure?” query Sets/Queries the current waveform peak (instantaneous value) data output.	89
:MEASure[:NORMAL]:ITEM:IPK_MAX:ALL :MEASure[:NORMAL]:ITEM:IPK_MAX:CH1(?)	<Output Setting 0/1>	“:MEASure?” query Sets/Queries the current waveform peak value (maximum value) data output.	89
:MEASure[:NORMAL]:ITEM:IPK_MIN:ALL :MEASure[:NORMAL]:ITEM:IPK_MIN:CH1(?)	<Output Setting 0/1>	“:MEASure?” query Sets/Queries the current waveform peak value (minimum value) data output.	89
:MEASure[:NORMAL]:ITEM:MCR:ALL :MEASure[:NORMAL]:ITEM:MCR:CH1(?)	<Output Setting>	“:MEASure?” query Sets/Queries the Maximum Current Ratio (instantaneous value) data output.	90
:MEASure[:NORMAL]:ITEM:MCR_MAX:ALL :MEASure[:NORMAL]:ITEM:MCR_MAX:CH1(?)	<Output Setting>	“:MEASure?” query Sets/Queries the Maximum Current Ratio (maximum value) data output.	90
:MEASure[:NORMAL]:ITEM:MCR_MIN:ALL :MEASure[:NORMAL]:ITEM:MCR_MIN:CH1(?)	<Output Setting>	“:MEASure?” query Sets/Queries the Maximum Current Ratio (minimum value) data output.	90
:MEASure[:NORMAL]:ITEM:UCFactor:ALL :MEASure[:NORMAL]:ITEM:UCFactor:CH1(?)	<Output Setting 0/1>	“:MEASure?” query Sets/Queries the voltage crest factor (instantaneous value) data output.	90
:MEASure[:NORMAL]:ITEM:UCF_MAX:ALL :MEASure[:NORMAL]:ITEM:UCF_MAX:CH1(?)	<Output Setting 0/1>	“:MEASure?” query Sets/Queries the voltage crest factor (maximum value) data output.	90
:MEASure[:NORMAL]:ITEM:UCF_MIN:ALL :MEASure[:NORMAL]:ITEM:UCF_MIN:CH1(?)	<Output Setting 0/1>	“:MEASure?” query Sets/Queries the voltage crest factor (minimum value) data output.	90
:MEASure[:NORMAL]:ITEM:ICFactor:ALL :MEASure[:NORMAL]:ITEM:ICFactor:CH1(?)	<Output Setting 0/1>	“:MEASure?” query Sets/Queries the current crest factor (instantaneous value) data output.	91

Message ([] : Can be omitted)	Data Formats (Response data for queries)	Description	Reference Page
:MEASure[:NORMAL]:ITEM:ICF_MAX:ALL :MEASure[:NORMAL]:ITEM:ICF_MAX:CH1(?)	<Output Setting 0/1>	“:MEASure?” query Sets/Queries the current crest factor (maximum value) data output.	91
:MEASure[:NORMAL]:ITEM:ICF_MIN:ALL :MEASure[:NORMAL]:ITEM:ICF_MIN:CH1(?)	<Output Setting 0/1>	“:MEASure?” query Sets/Queries the current crest factor (minimum value) data output.	91
:MEASure[:NORMAL]:ITEM:ITAVerage:ALL :MEASure[:NORMAL]:ITEM:ITAVerage:CH1(?) (Data by current range during auto-range integration) :MEASure[:NORMAL]:ITEM:ITAVerage:CH1:200mA(?) :MEASure[:NORMAL]:ITEM:ITAVerage:CH1:500mA(?) :MEASure[:NORMAL]:ITEM:ITAVerage:CH1:1A(?) :MEASure[:NORMAL]:ITEM:ITAVerage:CH1:2A(?) :MEASure[:NORMAL]:ITEM:ITAVerage:CH1:5A(?) :MEASure[:NORMAL]:ITEM:ITAVerage:CH1:10A(?) :MEASure[:NORMAL]:ITEM:ITAVerage:CH1:20A(?) :MEASure[:NORMAL]:ITEM:ITAVerage:CH1:BACKup(?)	<Output Item (Rectification Method)>	“:MEASure?” query Sets/Queries the time average current data output.	92
:MEASure[:NORMAL]:ITEM:PTAVerage:ALL :MEASure[:NORMAL]:ITEM:PTAVerage:CH1(?) (Data by current range during auto-range integration) :MEASure[:NORMAL]:ITEM:PTAVerage:CH1:200mA(?) :MEASure[:NORMAL]:ITEM:PTAVerage:CH1:500mA(?) :MEASure[:NORMAL]:ITEM:PTAVerage:CH1:1A(?) :MEASure[:NORMAL]:ITEM:PTAVerage:CH1:2A(?) :MEASure[:NORMAL]:ITEM:PTAVerage:CH1:5A(?) :MEASure[:NORMAL]:ITEM:PTAVerage:CH1:10A(?) :MEASure[:NORMAL]:ITEM:PTAVerage:CH1:20A(?) :MEASure[:NORMAL]:ITEM:PTAVerage:CH1:BACKup(?)	<Output Item (Rectification Method)>	“:MEASure?” query Sets/Queries the time average active power data output.	93
:MEASure[:NORMAL]:ITEM:URF:ALL :MEASure[:NORMAL]:ITEM:URF:CH1(?)	<Output Setting 0/1>	“:MEASure?” query Sets/Queries the voltage ripple factor (instantaneous value) data output.	93
:MEASure[:NORMAL]:ITEM:URF_MAX:ALL :MEASure[:NORMAL]:ITEM:URF_MAX:CH1(?)	<Output Setting 0/1>	“:MEASure?” query Sets/Queries the voltage ripple factor (maximum value) data output.	93
:MEASure[:NORMAL]:ITEM:URF_MIN:ALL :MEASure[:NORMAL]:ITEM:URF_MIN:CH1(?)	<Output Setting 0/1>	“:MEASure?” query Sets/Queries the voltage ripple factor (minimum value) data output.	93
:MEASure[:NORMAL]:ITEM:IRF:ALL :MEASure[:NORMAL]:ITEM:IRF:CH1(?)	<Output Setting 0/1>	“:MEASure?” query Sets/Queries the current ripple factor (instantaneous value) data output.	94
:MEASure[:NORMAL]:ITEM:IRF_MAX:ALL :MEASure[:NORMAL]:ITEM:IRF_MAX:CH1(?)	<Output Setting 0/1>	“:MEASure?” query Sets/Queries the current ripple factor (maximum value) data output.	94
:MEASure[:NORMAL]:ITEM:IRF_MIN:ALL :MEASure[:NORMAL]:ITEM:IRF_MIN:CH1(?)	<Output Setting 0/1>	“:MEASure?” query Sets/Queries the current ripple factor (minimum value) data output.	94

Message ([]: Can be omitted)	Data Formats (Response data for queries)	Description	Reference Page
:MEASure[:NORMal]:ITEM:UTHD:ALL :MEASure[:NORMal]:ITEM:UTHD:CH1(?)	<Output Setting 0/1>	“:MEASure?” query Sets/Queries the total harmonic wave voltage distortion factor (instantaneous value) data output.	94
:MEASure[:NORMal]:ITEM:UTHD_MAX:ALL :MEASure[:NORMal]:ITEM:UTHD_MAX:CH1(?)	<Output Setting 0/1>	“:MEASure?” query Sets/Queries the total harmonic wave voltage distortion factor (maximum value) data output.	94
:MEASure[:NORMal]:ITEM:UTHD_MIN:ALL :MEASure[:NORMal]:ITEM:UTHD_MIN:CH1(?)	<Output Setting 0/1>	“:MEASure?” query Sets/Queries the total harmonic wave voltage distortion factor data output.	94
:MEASure[:NORMal]:ITEM:ITHD:ALL :MEASure[:NORMal]:ITEM:ITHD:CH1(?)	<Output Setting 0/1>	“:MEASure?” query Sets/Queries the total harmonic wave current distortion factor (instantaneous value) data output.	95
:MEASure[:NORMal]:ITEM:ITHD_MAX:ALL :MEASure[:NORMal]:ITEM:ITHD_MAX:CH1(?)	<Output Setting 0/1>	“:MEASure?” query Sets/Queries the total harmonic wave current distortion factor (maximum value) data output.	95
:MEASure[:NORMal]:ITEM:ITHD_MIN:ALL :MEASure[:NORMal]:ITEM:ITHD_MIN:CH1(?)	<Output Setting 0/1>	“:MEASure?” query Sets/Queries the total harmonic wave current distortion factor (minimum value) data output.	95

Device-specific Commands (Measurement Value Output Settings [Harmonic Wave])

Note: :MEASure:HARMonic:ITEM:U:CH1(?) → Setting Command :MEASure:HARMonic:ITEM:U:CH1
Query :MEASure:HARMonic:ITEM:U:CH1?

Message ([]: Can be omitted)	Data Formats (Response data for queries)	Description	Reference Page
:MEASure:HARMonic[:VALue]?		Harmonic wave measurement data output.	96
:MEASure:HARMonic:ITEM:ALLClear		“:MEASure:HARMonic?” Turns OFF all query output.	98
:MEASure:HARMonic:ITEM:LIST(?)	(<Output Item 1>, <Output Item 2>, <Output Item 3>, <Output Item 4>, <Output Item 5>, <Output Item 6>)	“:MEASure:HARMonic?” query. Sets/Queries output items.	99
:MEASure:HARMonic:ITEM:ORDer(?)	(<Lower Limit Order>, <Upper Limit Order>, <ODD/EVEN/ALL>)	Sets/Queries the output order of “:MEASure:HARMonic?” queries.	100
:MEASure:HARMonic:ITEM:STATus:INST(?) :MEASure:HARMonic:ITEM:STATus:MAXmin(?)	<Output Setting 0/1>	“:MEASure:HARMonic?” query Sets/Querys the measurement status output	100
:MEASure:HARMonic:ITEM:U:ALL :MEASure:HARMonic:ITEM:U:CH1(?)	<Output Setting 0/1>	“:MEASure:HARMonic?” Sets/Queries the output of the harmonic wave voltage effective value output for the above query.	101
:MEASure:HARMonic:ITEM:U_MAX:ALL :MEASure:HARMonic:ITEM:U_MAX:CH1(?)	<Output Setting 0/1>	“:MEASure:HARMonic?” Sets/Queries the output of the harmonic wave voltage effective value (maximum value) output for the above query.	101
:MEASure:HARMonic:ITEM:U_MIN:ALL :MEASure:HARMonic:ITEM:U_MIN:CH1(?)	<Output Setting 0/1>	“:MEASure:HARMonic?” Sets/Queries the output of the harmonic wave voltage effective value (minimum value) output for the above query.	101
:MEASure:HARMonic:ITEM:I:ALL :MEASure:HARMonic:ITEM:I:CH1(?)	<Output Setting 0/1>	“:MEASure:HARMonic?” Sets/Queries the output of the harmonic wave current effective value output for the above query.	101
:MEASure:HARMonic:ITEM:I_MAX:ALL :MEASure:HARMonic:ITEM:I_MAX:CH1(?)	<Output Setting 0/1>	“:MEASure:HARMonic?” Sets/Queries the output of the harmonic wave current effective value (maximum value) output for the above query.	101

Message ([]: Can be omitted)	Data Formats (Response data for queries)	Description	Reference Page
:MEASure:HARMonic:ITEM:I_MIN:ALL :MEASure:HARMonic:ITEM:I_MIN:CH1(?)	<Output Setting 0/1>	“:MEASure:HARMonic?” Sets/Queries the output of the harmonic wave current effective value (minimum value) output for the above query.	101
:MEASure:HARMonic:ITEM:P:ALL :MEASure:HARMonic:ITEM:P:CH1(?)	<Output Setting 0/1>	“:MEASure:HARMonic?” Sets/Queries the harmonic wave active power output for the above query.	102
:MEASure:HARMonic:ITEM:P_MAX:ALL :MEASure:HARMonic:ITEM:P_MAX:CH1(?)	<Output Setting 0/1>	“:MEASure:HARMonic?” Sets/Queries the harmonic wave active power (maximum value) output for the above query.	102
:MEASure:HARMonic:ITEM:P_MIN:ALL :MEASure:HARMonic:ITEM:P_MIN:CH1(?)	<Output Setting 0/1>	“:MEASure:HARMonic?” Sets/Queries the harmonic wave active power (minimum value) output for the above query.	102
:MEASure:HARMonic:ITEM:UCON:ALL :MEASure:HARMonic:ITEM:UCON:CH1(?)	<Output Setting 0/1>	“:MEASure:HARMonic?” Sets/Queries the harmonic wave voltage content for the above query.	102
:MEASure:HARMonic:ITEM:UCON_MAX:ALL :MEASure:HARMonic:ITEM:UCON_MAX:CH1(?)	<Output Setting 0/1>	“:MEASure:HARMonic?” Sets/Queries the harmonic wave voltage content (maximum value) for the above query.	102
:MEASure:HARMonic:ITEM:UCON_MIN:ALL :MEASure:HARMonic:ITEM:UCON_MIN:CH1(?)	<Output Setting 0/1>	“:MEASure:HARMonic?” Sets/Queries the harmonic wave voltage content (minimum value) for the above query.	102
:MEASure:HARMonic:ITEM:ICON:ALL :MEASure:HARMonic:ITEM:ICON:CH1(?)	<Output Setting 0/1>	“:MEASure:HARMonic?” Sets/Queries the harmonic wave current content for the above query.	103
:MEASure:HARMonic:ITEM:ICON_MAX:ALL :MEASure:HARMonic:ITEM:ICON_MAX:CH1(?)	<Output Setting 0/1>	“:MEASure:HARMonic?” Sets/Queries the harmonic wave current content (maximum value) for the above query.	103
:MEASure:HARMonic:ITEM:ICON_MIN:ALL :MEASure:HARMonic:ITEM:ICON_MIN:CH1(?)	<Output Setting 0/1>	“:MEASure:HARMonic?” Sets/Queries the harmonic wave current content (minimum value) for the above query.	103
:MEASure:HARMonic:ITEM:PCON:ALL :MEASure:HARMonic:ITEM:PCON:CH1(?)	<Output Setting 0/1>	“:MEASure:HARMonic?” Sets/Queries the harmonic wave active power content for the above query.	103
:MEASure:HARMonic:ITEM:PCON_MAX:ALL :MEASure:HARMonic:ITEM:PCON_MAX:CH1(?)	<Output Setting 0/1>	“:MEASure:HARMonic?” Sets/Queries the harmonic wave active power content (maximum value) for the above query.	103

Message ([]: Can be omitted)	Data Formats (Response data for queries)	Description	Reference Page
:MEASure:HARMonic:ITEM:PCON_MIN:ALL :MEASure:HARMonic:ITEM:PCON_MIN:CH1(?)	<Output Setting 0/1>	“:MEASure:HARMonic?” Sets/Queries the harmonic wave active power content (minimum value) for the above query.	103
:MEASure:HARMonic:ITEM:UPHase:ALL :MEASure:HARMonic:ITEM:UPHase:CH1(?)	<Output Setting 0/1>	“:MEASure:HARMonic?” Sets/Queries the harmonic wave voltage phase angle for the above query.	104
:MEASure:HARMonic:ITEM:UPHase_MAX:ALL :MEASure:HARMonic:ITEM:UPHase_MAX:CH1(?)	<Output Setting 0/1>	“:MEASure:HARMonic?” Sets/Queries the harmonic wave voltage phase angle (maximum value) for the above query.	104
:MEASure:HARMonic:ITEM:UPHase_MIN:ALL :MEASure:HARMonic:ITEM:UPHase_MIN:CH1(?)	<Output Setting 0/1>	“:MEASure:HARMonic?” Sets/Queries the harmonic wave voltage phase angle (minimum value) for the above query.	104
:MEASure:HARMonic:ITEM:IPHase:ALL :MEASure:HARMonic:ITEM:IPHase:CH1(?)	<Output Setting 0/1>	“:MEASure:HARMonic?” Sets/Queries the harmonic wave current phase angle for the above query.	104
:MEASure:HARMonic:ITEM:IPHase_MAX:ALL :MEASure:HARMonic:ITEM:IPHase_MAX:CH1(?)	<Output Setting 0/1>	“:MEASure:HARMonic?” Sets/Queries the harmonic wave current phase angle (maximum value) for the above query.	104
:MEASure:HARMonic:ITEM:IPHase_MIN:ALL :MEASure:HARMonic:ITEM:IPHase_MIN:CH1(?)	<Output Setting 0/1>	“:MEASure:HARMonic?” Sets/Queries the harmonic wave current phase angle (minimum value) for the above query.	104
:MEASure:HARMonic:ITEM:PPHase:ALL :MEASure:HARMonic:ITEM:PPHase:CH1(?)	<Output Setting 0/1>	“:MEASure:HARMonic?” Sets/Queries the harmonic wave voltage current phase difference for the above query.	105
:MEASure:HARMonic:ITEM:PPHase_MAX:ALL :MEASure:HARMonic:ITEM:PPHase_MAX:CH1(?)	<Output Setting 0/1>	“:MEASure:HARMonic?” Sets/Queries the harmonic wave voltage current phase difference (maximum value) for the above query.	105
:MEASure:HARMonic:ITEM:PPHase_MIN:ALL :MEASure:HARMonic:ITEM:PPHase_MIN:CH1(?)	<Output Setting 0/1>	“:MEASure:HARMonic?” Sets/Queries the harmonic wave voltage current phase difference (minimum value) for the above query.	105

Device-specific Commands (Communications)

Message ([]: Can be omitted)	Data Formats (Response data for queries)	Description	Reference Page
:RS232c?		Queries the RS232-C setting items.	106
:RS232c:BAUD :RS232c:BAUD?	<RS Baud Rate>	Sets/Queries the RS232-C baud rate.	106
:RS232c:ANSWer :RS232c:ANSWer?	ON/OFF	Sets/Queries the execution confirmation message.	107
:RS232c:ERRor?		Sets/Queries RS232-C communications errors.	107
:IP:ADDRess :IP:ADDRess?	(<Address 1 (NR1)>, <Address 2 (NR1)>, <Address 3 (NR1)>, <Address 4 (NR1)>)	Sets/Queries the LAN IP address.	108
:IP:DEFaultgateway :IP:DEFaultgateway?	(<Address 1 (NR1)>, <Address 2 (NR1)>, <Address 3 (NR1)>, <Address 4 (NR1)>)	Sets/Queries the LAN default gateway.	108
:IP:SUBNetmask :IP:SUBNetmask?	(<Address 1 (NR1)>, <Address 2 (NR1)>, <Address 3 (NR1)>, <Address 4 (NR1)>)	Sets/Queries the LAN subnet mask.	108
:GPIB?		Queries the GP-IB setting items.	109
:GPIB:ADDRess :GPIB:ADDRess?	<Address (NR1)>	Sets/Queries the GP-IB address.	109
:HEADer :HEADer?	ON/OFF	Sets/Queries the header.	109
:LOCAL	0/1 (NR1)	Changes to the Local (manual operation) state.	109
:TRANsmit:SEParator :TRANsmit:SEParator?	0/1 (NR1)	Sets/Queries the message unit separator.	110
:TRANsmit:TERMinator :TRANsmit:TERMinator?	0/1 (NR1)	Sets/Queries the message unit terminator.	110

Device-specific Commands (Dummy commands for maintaining compatibility with other models (333x, PW3336, PW3337, etc.))

Message	Data Formats (Response data for queries)	Description	Reference Page
:WIRing :Wiring?	TYPE1 to TYPE7	Sets/Queries the wire connection setting.	
:MODE :MODE?	1/2 (for 3331 interchangeability)	Queries will always return "TYPE1"	
:RECTifier :RECTifier?	ACDC,ACDC_UMEAN,DC,AC,FN D,1,2,3	Sets/Queries the rectifier. Queries will always return "ALL."	
:RESPonse :RESPonse?	FAST/SLOW/AUTO (For 3331 compatibility)	Sets/Queries the display update speed. Queries will always return "AUTO."	

3 Message Reference

Message Reference Interpretation

< >: Indicates the contents (character or numeric parameters) of the data portion of a message. Character parameters are returned as all capital letters.

Numeric Parameters :

- NRf Number format may be any of NR1, NR2 and NR3
- NR1 Integer data (e.g.: +12, -23, 34)
- NR2 Fixed-point data (e.g.: +1.23, -23.45, 3.456)
- NR3 Floating-point exponential representation data (e.g.: +1.0E-2, -2.3E+4)

Shows the command description.

Shows the message syntax. Explains the command data or response message.

Describes the message.

Shows an example of an actual command application. This description is normally when HEADER ON is set.

Read/Write the Standard Event Status Enable Register (SESER)																									
Syntax	Command *ESE <0 ~ 255 (NR1)>																								
	Query *ESE?																								
	Response <0 ~ 255 (NR1)>																								
Description	Command The SESER mask is set to the numerical value 0 to 255. The initial value (at power-on) is 0.																								
	Query The contents of the SESER, as set by the *ESE command, are returned as an NR1 value (0 to 255).																								
	<table style="margin-left: auto; margin-right: auto; border-collapse: collapse;"> <tr> <td style="padding: 0 10px;">128</td> <td style="padding: 0 10px;">64</td> <td style="padding: 0 10px;">32</td> <td style="padding: 0 10px;">16</td> <td style="padding: 0 10px;">8</td> <td style="padding: 0 10px;">4</td> <td style="padding: 0 10px;">2</td> <td style="padding: 0 10px;">1</td> </tr> <tr> <td style="padding: 0 10px;">bit 7</td> <td style="padding: 0 10px;">bit 6</td> <td style="padding: 0 10px;">bit 5</td> <td style="padding: 0 10px;">bit 4</td> <td style="padding: 0 10px;">bit 3</td> <td style="padding: 0 10px;">bit 2</td> <td style="padding: 0 10px;">bit 1</td> <td style="padding: 0 10px;">bit 0</td> </tr> <tr> <td style="padding: 0 10px;">PON</td> <td style="padding: 0 10px;">URQ</td> <td style="padding: 0 10px;">CME</td> <td style="padding: 0 10px;">EXE</td> <td style="padding: 0 10px;">DDE</td> <td style="padding: 0 10px;">QYE</td> <td style="padding: 0 10px;">RQC</td> <td style="padding: 0 10px;">OPC</td> </tr> </table>	128	64	32	16	8	4	2	1	bit 7	bit 6	bit 5	bit 4	bit 3	bit 2	bit 1	bit 0	PON	URQ	CME	EXE	DDE	QYE	RQC	OPC
128	64	32	16	8	4	2	1																		
bit 7	bit 6	bit 5	bit 4	bit 3	bit 2	bit 1	bit 0																		
PON	URQ	CME	EXE	DDE	QYE	RQC	OPC																		
Example	*ESE 36 (Sets bits 5 and 2 of SESER)																								

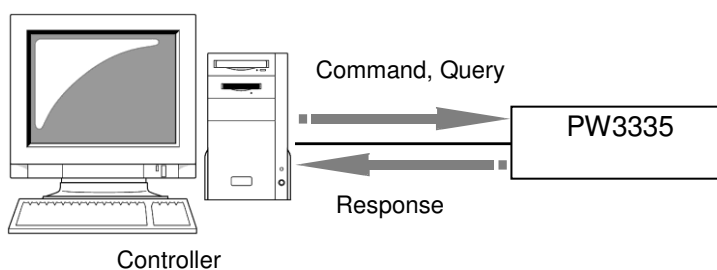

Standard Commands

(1) System Data Command

Query Device ID (Identification Code)

Syntax Query ***IDN?**
 Response <Manufacturer name>, <Model name>, <Model type>, <Software version>, <Serial number>

<Manufacturer name> "HIOKI" Fixed
 <Model name> "PW3335" No. of channels: 1

<Model type>	RS-232c	GP-IB	D/A output	Current Sensor Input
00	●	-	-	-
01	-	●	-	-
02	●	-	●	-
03	●	-	-	●
04	●	●	●	●

Example Query ***IDN?**
 Response **HIOKI,PW3335,04,V1.00,ser123456789**

The Device ID is HIOKI PW3335-04 (RS-232c,GP-IB, with D/A output,current sensor input), software version 1.00, 123456789.

- Note**
- The response message has no header.
 - "*"IDN?" must be the last query message in a program message.
 - Therefore, if any other query is detected after this query on the same line, a query error will occur and no response message will be output.

Query Device Options

Syntax Query ***OPT?**
 Response <IF type>, <D/A output capability>, < External current input sensor presence>

<IF type> RS/GPIB/RS_GPIB/NONE
 <D/A output capability> DA_OUT/NONE
 < External current input sensor presence> CURR_SENSOR/NONE

Description Queries the options available on the instrument.

Example Query ***OPT?**
 Response **GPIB,DA_OUT,CURR_SENSOR**

Instrument is equipped with a GP-IB interface, D/A output, and an external current sensor.

- Note**
- The response message has no header.

(2) Internal Operation Command

Initialize Device

Syntax Command ***RST**
Description Command Resets the instrument to its initial state.

- Note**
- Refer to the user's manual for the instrument (in the System Reset section) for information about the initial settings.
 - The communications state is not initialized.
 - This command can be executed even when a system error has occurred.

Execute Self-test and Query Result

Syntax	Query	*TST?
	Response	<0 ~ 4 (NR1)> 0:No error 1:ROM error 2:RAM error 3:FPGA error 4:Backup data error
Description	Perform the instrument self-test and return the result as a numerical value 0 to 4. Returns zero when no error occurs.	
Example	Query	*TST?
	Response	2 A RAM error was detected. The instrument may not be able to perform measurements correctly. Stop use immediately and send the instrument in for repairs.
Note	<ul style="list-style-type: none"> • The response message has no header. • A device-dependent error will occur if this command is executed during integration (when the INTEGRATOR indicator is lit) or when in the Hold state (when the HOLD indicator is lit). • This command can be executed even when a system error has occurred. 	

(3) Synchronization Commands

Set OPC Bit of SESR when Finished with All Pending Operations

Syntax	Command	*OPC
Description	Sets OPC bit 0 of the Standard Event Status Register (SESR) when all commands prior to *OPC have finished processing.	
Example	:MEAS?;*OPC Sets the OPC bit of the SESR after the :MEAS? query finishes processing.	

Respond with ASCII "1" when Finished with All Pending Operations

Syntax	Query	*OPC?
	Response	1
Description	Responds with ASCII "1" when all commands prior to *OPC have finished processing.	
Example	:MEAS?;*OPC? "1" is stored in the output queue after the data for the :MEAS? query is generated.	
Note	<ul style="list-style-type: none"> • The response message has no header. 	

Wait until display update finishes before executing the next command.

Syntax	Command	*WAI
Description	No commands after *WAI are run until the next display update completes. (200ms max)	
Example	:MEAS?;*WAI;;MEAS? Data is loaded after each display update.	
Note	<ul style="list-style-type: none"> • The displayed data will not be updated even if this command is executed, while the display is held, the maximum/minimum values are being held, and the averaged values are displayed. • The display data will not be updated even during a range switch ("----" display) even if this command is executed. 	

(4) Status and Event Control Commands

Clear Event Register, Status Byte Register (Except Output Queue)

Syntax Command ***CLS**

Description Clears the event status registers. The Status Byte Register bits corresponding to the event status registers are also cleared. (**SESR, ESR0, ESR1, RS232c:ERRor**)

- Note**
- The output queue, enable registers, and bit 4 of the status byte register (MAV) are not affected.
 - This command can be executed even when a system error has occurred.

Read/Write the Standard Event Status Enable Register (SESER)

Syntax Command ***ESE <0~255(NR1)>**
 Query ***ESE?**
 Response **<0~255(NR1)>**

Description Command The SESER mask is set to the numerical value 0 to 255. The initial value (at power-on) is 0. Although NRf numerical values are accepted, values to the right of the decimal are truncated. URQ (bit 6) and RQC (bit 1) is not used by the instrument. Therefore, these events will not be triggered even if a value of 1 is specified.

Query The contents of the SESER, as set by the ***ESE** command, are returned as an NR1 value (0 to 255).

128	64	32	16	8	4	2	1
bit 7	bit 6	bit 5	bit 4	bit 3	bit 2	bit 1	bit 0
PON	URQ	CME	EXE	DDE	QYE	RQC	OPC

Example Command ***ESE 36**
 (Sets bits 5 and 2 of SESER)
 Query ***ESE?**
 Response (When HEADER ON) ***ESE 36**
 (When HEADER OFF) **36**

Read and Clear Standard Event Status Register (SESR)

Syntax Query ***ESR?**
 Response **<0~255 (NR1)>**

Description Returns the contents of the SESR as an NR1 value from 0 to 255, then clears register contents.

The response message has no header.

128	64	32	16	8	4	2	1
bit 7	bit 6	bit 5	bit 4	bit 3	bit 2	bit 1	bit 0
PON	URQ	CME	EXE	DDE	QYE	RQC	OPC

Example ***ESR?**
32

Bit 5 of the SESR has been set to 1. →A CME (Command Error) has occurred.

- Note**
- This command can be executed even when a system error has occurred.

Write and Read Service Request Enable Register (SRER)

Syntax Command ***SRE <0~255 (NR1)>**
 Query ***SRE?**
 Response **<0~255 (NR1)>**

Description Command The SRER mask is set to the numerical value 0 to 255. Although NRf numerical values are accepted, values to the right of the decimal are truncated. Bit 6 and unused bits (bit 7) are ignored. The data is initialized to zero at power-on.

Query The contents of the SRER, as set by the ***SRE** command, are returned as an NR1 value (0 to 255). Bit 6 and unused bits (bit 7,3,2) always return as zero.

128	64	32	16	8	4	2	1
bit 7	bit 6	bit 5	bit 4	bit 3	bit 2	bit 1	bit 0
unused	0	ESB	MAV	unused	unused	ESB1	ESB0

Example Command ***SRE 33**
 Set SRER bits 0 and 5 to 1.

Query ***SRE?**
 Response (When HEADER ON) ***SRE 33**
 (When HEADER OFF) **33**
 SRER bits 0 and 5 have been set to 1.

Read Status Byte Register

Syntax Query ***STB?**
 Response **<0~255 (NR1)>**

Description The contents of the STB are returned as an NR1 value (0 to 255). The response message has no header.

128	64	32	16	8	4	2	1
bit 7	bit 6	bit 5	bit 4	bit 3	bit 2	bit 1	bit 0
unused	MSS	ESB	MAV	unused	unused	ESB1	ESB0

Example Query ***STB?**
 Response (When HEADER ON) **16**
 (When HEADER OFF) **16**

STB bit 4 has been set to 1.

- Note**
- The value of bit 6 is the value of the MSS bit.
 - The MSS bit will not be cleared even if the service requests have been cleared through serial polling.
 - This command can be executed even when a system error has occurred.

Request a Sample

Syntax Command ***TRG**

Description Updates the measurement display once when the instrument is in the Hold state.

Example **:HOLD ON;*TRG;;MEAS?**

- Note**
- A device-dependent error occurs if this command is executed in any other state than the Hold state.
 - While the averaged value is displayed, the displayed averaged value is updated by executing this command.

Device-specific Commands

(1) Event Status Register

Set and Query Device-specific Event Status Enable Register ESER0

Syntax Command :ESE0 <0~255 (NR1)>
 Query :ESE0?
 Response <0~255 (NR1)>

Description Command Sets the mask pattern in Event Status Enable Register 0 (ESER0) for the Event Status Register. Although NRf numerical values are accepted, values to the right of the decimal are truncated.

128	64	32	16	8	4	2	1
bit 7	bit 6	bit 5	bit 4	bit 3	bit 2	bit 1	bit 0
DS	CSE	SE	IE	AVG	HP	ODI	ESE

Example Command :ESE0 4
 Set ESER0 bit 2 to 1.
 Query :ESE0?
 Response (When HEADER ON) :ESE0 4
 (When HEADER OFF) 4

Note The data is initialized to zero at power-on.

Set and Query Device-specific Event Status Enable Register ESER1

Syntax Command :ESE1 <0~255 (NR1)>
 Query :ESE1?
 Response <0~255 (NR1)>

Description Command Sets the mask pattern in Event Status Enable Register 1 (ESER1) for the Event Status Register. Although NRf numerical values are accepted, values to the right of the decimal are truncated to the nearest integer.

128	64	32	16	8	4	2	1
bit 7	bit 6	bit 5	bit 4	bit 3	bit 2	bit 1	bit 0
FOR	ODI	CODI	IO	OU	HP	HI	HU

Example Command :ESE1 24
 Set ESER1 bits 3 and 4 to 1.
 Query :ESE1?
 Response (When HEADER ON) :ESE1 24
 (When HEADER OFF) 24

Note The data is initialized to zero at power-on.

Set and Query Device-specific Event Status Enable Registers ESER0 to ESER3

Syntax Query :ESR0?
 :ESR1?
 Response <0~255 (NR1)>

Description Command Returns the contents of the Event Status Register in NR1 format.

Note

- When ESR0? is executed, the content of ESR0 is cleared.
- When ESR1? is executed, the content of ESR1 is cleared.

(2) Measurement Settings

Setting and Querying the Number of Times to Perform Averaging

Syntax	Command	:AVERaging <Number of times to perform averaging (NR1)>
	Query	:AVERaging?
	Response	<Number of times to perform averaging (NR1)> 1/2/5/10/25/50/100

Description Sets or queries the number of times to perform averaging. Although NRf numerical values are accepted, values to the right of the decimal are truncated.

Example	Command	:AVER 10
	Query	Set the number of times to perform averaging to 10. :AVER?
	Response	(When HEADER ON) :AVERAGING 10 (When HEADER OFF) 10

Note

- When the number of times to perform averaging is changed, averaging restarts.
- You cannot change this setting while the display is held or when the maximum/minimum values are being held.

Querying the Integration Set Time and Status

Syntax	Query	:INTEGrate?
	Response	<0000 to 9999 (NR1)>,<00 to 59 (NR1)>;<Integration status>
Description		Returns the integration set time (hours, minutes) and the status of integration calculations as a numerical value and string, respectively. See “:INTEGrate:TIME?”, “:INTEGrate:STATE?” for details on the return values.
Example	Query	:INTEG?
	Response	(When HEADER ON) :INTEGRATE:TIME 0100,00,STATE START (When HEADER OFF) 0100,00;START
Note		• You can use the :TRANsmit:SEParator command to change the message unit separator from a semicolon “;” to a comma “,”.

Set and Query the Integration Status

Syntax	Command	:INTEGrate:STATE <Integration status>
	Query	:INTEGrate:STATE?
	Response	<Integration status> START/STOP/RESET
Description	Query	Indicates the integration operation.
	Response	Returns the integration status as a string.
Example	Command	:INTEG:STAT START
		Starts the integration operation.
	Query	:INTEG:STAT?
	Response	(When HEADER ON) :INTEGRATE:STATE START (When HEADER OFF) START
Note		<ul style="list-style-type: none"> • Depending on the integration state, a device-dependent error may occur (see the table below). • A device-dependent error will occur if the integration value reaches $\pm 9999999M$ or if the integration time reaches 10,000 hours.

		Instrument Status				
		RUN Indicator EXT Indicator OFF (Reset state)	Key input (command) EXT Indicator OFF		Integration from an External Terminal EXT Indicator ON	
			RUN Indicator ON (Integration in progress)	RUN Indicator Flashing (Stopped)	RUN indicator ON (Integration in progress)	RUN indicator Flashing (Stopped)
Command	START	○	×	○	×	×
	STOP	×	○	×	×	×
	RESET	○	×	○	×	○

○: The command is executed.

×: A device-dependent error occurs.

Set and Query the Integration Time

Syntax	Command	:INTEGrate:TIME <0000 to 9999 (NR1)>,<00to 59 (NR1)>
	Query	:INTEGrate:TIME?
	Response	<0000 to 9999(NR1)>,<00 to 59(NR1)>
Description	<p>Sets or queries the hours and minutes for the integration time.</p> <p>The setting range is 1 minute to 9,999 hours and 59 minutes. The unit is 1 minute.</p> <p>If the integration time is set to 0 hours and 0 minutes, integration is performed for 10,000 hours (approximately 417 days).</p> <p>Although NRf numerical values are accepted, values to the right of the decimal are truncated.</p>	
Example	Command	:INTEG:TIME 100,20
	Query	:INTEG:TIME?
	Response	(When HEADER ON) :INTEGRATE:TIME 0100,20 (When HEADER OFF) 0100,20
Note	<ul style="list-style-type: none"> You cannot change this setting during integration, while the display is held, or when the maximum/minimum values are being held. 	

Set and Query Auto-range Integration

Syntax	Command	:INTEGrate:AUTO <OFF/ON>
	Query	:INTEGrate:AUTO?
	Response	<OFF/ON>
Description	<p>Sets auto-range integration.</p>	
Example	Command	:INTEG:AUTO ON
	Query	:INTEG:AUTO?
	Response	(When HEADER ON) :INTEGRATE:AUTO ON (When HEADER OFF) ON
Note	<ul style="list-style-type: none"> You cannot change this setting during integration, while the display is held, or when the maximum/minimum values are being held. 	

Set and Query the Harmonic Wave Analysis Order Upper Limit

Syntax	Command	:HARMOinic:ORDer:UPPer <2 to 50 (NR1)>
	Query	:HARMOinic:ORDer:UPPer?
	Response	<2 to 50 (NR1)>
Description	<p>Sets or queries the upper limit for the harmonic wave analysis order.</p> <p>Although NRf numerical values are accepted, values to the right of the decimal are truncated.</p>	
Example	Command	:HARM:ORD:UPP 50
	Query	:HARM:ORD:UPP?
	Response	(When HEADER ON) :HARMONIC:ORDER:UPPER 50 (When HEADER OFF) 50
Note	<ul style="list-style-type: none"> You cannot change this setting during integration, while the display is held, or when the maximum/minimum values are being held. 	

Set and Query the Display Hold Status

Syntax	Command	:HOLD <ON/OFF/MAX/MIN/RESET>
	Query	:HOLD?
	Response	<ON/OFF/MAX/MIN/RESET> ON Keeps the current display value (display hold state). OFF Releases the currently held display value. MAX Displays the maximum value (maximum value hold). MIN Displays the minimum value (minimum value hold). RESET Resets the maximum, minimum, and averaged values.
Description	Command	Specifies the type of hold to perform on the display value or resets the maximum and minimum values. Although NRf numerical values are accepted, values to the right of the decimal are truncated.
	Query	Returns the current display value hold setting.
Example	Command	:HOLD ON Holds the current display value.
	Query	:HOLD?
	Response	(When HEADER ON) :HOLD ON (When HEADER OFF) ON
	Note	• Auto-range operation may cease to function if the hold state is triggered and canceled at a short period of around 200 ms.

Execute and Query Zero Adjustment (Degaussing)

Syntax	Command	:ZEROadjust :DEMAg
	Query	:ZEROadjust? :DEMAg?
	Response	<OK/BUSY/ERROR> OK Operation completed successfully. BUSY Currently performing a zero adjustment. ERROR Zero adjustment failed.
Description	Command	Performs a zero adjustment.
Example	Query	Returns the zero adjustment execution results or current status.
	Command	:ZERO
	Query	:ZERO?
	Response	(When HEADER ON) :ZEROADJUST OK (When HEADER OFF) OK
Note	<ul style="list-style-type: none"> • Some time is required to perform a zero adjustment (approximately 30 seconds). During this time, some commands may result in an execution error. Use this command in such a way that the next command is sent only after the zero adjustment (degaussing) is complete. For example, ":ZERO;*WAI". • If a zero adjustment has not been performed since the instrument was powered on, :ZEROadjust? will return "OK". • Although this instrument does not provide degauss operation, DEMAG(?) will trigger the same operation as :ZEROadjust. • You cannot change this setting during integration, while the display is held, or when the maximum/minimum values are being held. 	

Set and Query the Multiple Instrument Synchronization Control Function

Syntax	Command	:SYNC:CONTRol <OFF/IN/OUT>
	Query	:SYNC:CONTRol?
	Response	<OFF/IN/OUT> OFF Turns OFF the synchronization control function. IN Sets the instrument as the slave device. OUT Sets the instrument as the master device.
Description	Command	Sets or queries the I/O settings for multiple device synchronization control.
Example	Command	:SYNC:CONTR OUT
	Query	:SYNC:CONTR?
	Response	(When HEADER ON) :SYNC:CONTRol OUT (When HEADER OFF) OUT
Note	<ul style="list-style-type: none"> Reset the integration value for both the master and slaves before starting synchronized measurement of integration. 	

(3) Voltage Range

Query the Voltage Range and Auto Range

Syntax	Query	:VOLTage?
	Response	<Voltage range (NR1)>;<Auto range ON/OFF>;< Select (NR1)>
Description	Queries the voltage range setting.	
Example	Query	:VOLT?
	Response	(When HEADER ON) :VOLTAGE:RANGE 15;AUTO ON;SELECT 63 (When HEADER OFF) 15; ON; 63
Note	<ul style="list-style-type: none"> You can use the :TRANsmit:SEParator command to change the message unit separator from a semicolon ";" to a comma ",". Instead of :VOLTage?, you can also use :VOLTage1?. (Both of these commands perform the same operation.) 	

Set and Query the Voltage Auto Range

Syntax	Command	:VOLTage:AUTO <ON/OFF>
	Query	:VOLTage:AUTO?
	Response	<ON/OFF> ON Measures the voltage in an automatic range. OFF Turns off the voltage automatic range operation.
Description	Command	Turns ON or OFF the voltage auto range.
Example	Query	Returns the voltage auto range setting.
	Command	:VOLT:AUTO ON
	Query	:VOLT:AUTO?
	Response	(When HEADER ON) :VOLTAGE:AUTO ON (When HEADER OFF) ON
Note	<ul style="list-style-type: none"> If you set the voltage range via a command such as :VOLTage:RANGE, the auto range operation will be turned OFF for the specified channel. You cannot change this setting during integration, while the display is held. Instead of :VOLTage:AUTO(?), you can also use :VOLTage1:AUTO(?). (Both of these commands perform the same operation.) 	

Set and Query the Voltage Range Setting

Syntax	Command	:VOLTage:RANGe <Voltage Range (NR1)>
	Query	:VOLTage:RANGe?
	Response	<Voltage range (NR1)> <Voltage range (NR1)> = 6/15/30/60/150/300/600/1000
Description	Command	Sets the voltage range setting. (The unit is in volts [V].) The numerical value is accepted in NRf format.
	Query	Returns the voltage range setting in NR1 format.
Example	Command	:VOLT:RANG 15
	Query	:VOLT:RANG?
	Response	(When HEADER ON) :VOLTAGE:RANGE 15 (When HEADER OFF) 15
Note	<ul style="list-style-type: none"> • Do not append a unit to the voltage range. • After you change the range, wait a few moments until the internal circuitry stabilizes before you read any measurement values. • If a negative value is specified, the absolute value will be used. • If the number of times to perform averaging is set to any value other than 1 and the range is changed, averaging is restarted. • If any value other than <Voltage range (NR1)> is specified, the set value will be set to the range that can be measured. However, if the specified value exceeds the full scale of the range, the next highest range will be set instead. • If a range is specified, the auto range operation is turned OFF. Additionally, range select will be turned on. • You cannot change this setting during integration, while the display is held. • Instead of : VOLTage: RANGe (?), you can also use : VOLTage1: RANGe (?). (Both of these commands perform the same operation.) 	

Set Whether to Select All Voltage Ranges

Syntax	Query	:VOLTage:SELEct:ALL <ON/OFF>
Description	Sets whether to select all voltage ranges.	
Example	Query	:VOLT:SEL:ALL ON?
	Response	(When HEADER ON) :VOLTAGE:RANGE 15;AUTO ON;SELECT 63 (When HEADER OFF) 15; ON; 63
Note	<ul style="list-style-type: none"> • The 1,000 V range is always on, regardless of the value of this setting. • Specifying a voltage range with the :VOLTage:RANGe command will cause range select for the specified range to be turned on. You can use the :TRANsmitt:SEParator command to change the message unit separator from a semicolon ";" to a comma ",". • You cannot change this setting during integration, while the display is held, or when the maximum/minimum values are being held. 	

Set and Query Voltage Range Select

Syntax	Command	<pre> :VOLTage:SElect:U6V <ON/OFF> :VOLTage:SElect:U15V <ON/OFF> :VOLTage:SElect:U30V <ON/OFF> :VOLTage:SElect:U60V <ON/OFF> :VOLTage:SElect:U150V <ON/OFF> :VOLTage:SElect:U300V <ON/OFF> :VOLTage:SElect:U600V <ON/OFF> </pre>
	Query	<pre> :VOLTage:SElect:U6V? :VOLTage:SElect:U15V? :VOLTage:SElect:U30V? :VOLTage:SElect:U60V? :VOLTage:SElect:U150V? :VOLTage:SElect:U300V? :VOLTage:SElect:U600V? :VOLTage:SElect:U1000V? </pre>
	Response	<pre> <ON/OFF> ON Performs measurement using the voltage range in question during range key operation, auto-range operation, and auto-range integration. OFF Disables use of the voltage range in question during range key operation, auto-range operation, and auto-range integration. </pre>
Description	Command	Toggles use of the voltage range in question during auto-range operation and auto-range integration.
	Query	Returns whether the voltage range in question is used during auto-range operation and auto-range integration.
Example	Command	:VOLT:SEL:U30V ON
	Query	:VOLT:SEL:U30V?
	Response	(When HEADER ON) :VOLTAGE:SELECT:U30V ON (When HEADER OFF) ON
Note		<ul style="list-style-type: none"> • Specifying a voltage range with the “:VOLTage:RANGe” command will cause range select for the specified range to be turned on. • You cannot change this setting during integration, while the display is held, or when the maximum/minimum values are being held. • Since use of the 1,000 V range is always enabled, queries will always return ON.

電圧レンジセレクトの設定と問い合わせ

Syntax Command **:VOLTage:SElect <data(NR1)>**

Query **:VOLTage:SElect?**

Response **<data>**
 128 64 32 16 8 4 2 1
<data(NR1)>

bit7	bit6	bit5	bit4	bit3	bit2	bit1	bit0
-	1000V	600V	300V	150V	60V	30V	15V

Description

Sets and queries voltage range use settings range key operation, auto-range operation, and auto-range integration as a value from 0 to 127. Although NRf numerical values are accepted, values to the right of the decimal are truncated.

Example Command **:VOLT:SEL 124**

Configures the setting so that the 15 V and 30 V ranges are skipped.

Query **:VOLT:SEL?**

Response (When HEADER ON) **:VOLTAGE:SELECT 124**
 (When HEADER OFF) **124**

- Note**
- This command is provided to ensure compatibility with control programs for existing models (3332). To take maximum advantage of the PW3335's functionality, it is recommended to use commands such as :VOLTage:SElect:6V.
 - This query cannot be used to query the 6 V range use setting.
 - If this command is used to set whether to select voltage ranges, the 6 V range use setting will be set to OFF.
 - This command cannot be used to set the 1,000 V range (which is always ON).
 - Specifying a voltage range with the ":VOLTage:RANGe" command will cause range select for the specified range to be turned on.
 - You cannot change this setting during integration, while the display is held, or when the maximum/minimum values are being held.

(4) Current Range

Batch Query of Current Range Settings

Syntax	Query	:CURRent?
	Response	<Current range (NR2)>;<Auto range ON/OFF>,<Current sensor type>,<Current sensor range>,<Select (NR1)>, <Select (NR1)>
Description		Queries the current range setting.
Example	Query	:CURR?
	Response	(When HEADER ON) :CURRENT:RANGE 0.2;AUTO OFF; TYPE TYPE2;EXTRANGE C50;SELECT 255,32 (When HEADER OFF) 0.2; OFF; TYPE2; C50
Note		<ul style="list-style-type: none"> • You can use the :TRANsmit:SEParator command to change the message unit separator from a semicolon ";" to a comma ",". • See the sections on :CURRent:RANGe,AUTO,TYPE,EXTRange,SElect for details on the responses for this query. • Instead of :CURRent?, you can also use :CURRent1?. (Both of these commands perform the same operation.)

Query the Current Auto Range Setting

Syntax	Command	:CURRent:AUTO <ON/OFF>
	Query	:CURRent:AUTO?
	Response	<ON/OFF>
		ON Measures the current in an automatic range. OFF Turns off the current automatic range operation.
Description	Command	Turns ON or OFF the current auto range.
	Query	Returns the current auto range setting.
Example	Command	:CURR:AUTO ON
	Query	:CURR:AUTO?
	Response	(When HEADER ON) :CURRENT:AUTO ON (When HEADER OFF) ON
Note		<ul style="list-style-type: none"> • If you set the current range via a command such as :CURRent:RANGe, the auto range operation will be turned OFF for the specified channel. • You cannot change this setting during integration, while the display is held. • Instead of :CURRent:AUTO(?), you can also use :CURRent1:AUTO(?). (Both of these commands perform the same operation.)

Set and Query the Current Range Setting

Syntax	Command	:CURRent:RANGe <Current range (NR2)>
	Query	:CURRent:RANGe?
	Response	<Current range (NR2)> <Current range (NR2)> = 0.001/0.002/0.005/0.01/0.02/0.05/0.1/0.2/0.5/1/2/5/10/20
Description	Command	Sets the current range setting. (The unit used for current is amperes [A].) NRf numerical values are accepted
	Query	Returns the current range setting in NR1 format.
Example	Command	:CURR:RANG 0.2
	Query	:CURR:RANG?
	Response	(When HEADER ON) :CURRENT:RANGE 0.2
		(When HEADER OFF) 0.2

- Note**
- Do not append a unit to the current range.
 - After you change the range, wait a few moments until the internal circuitry stabilizes before you read any measurement values.
 - If a range is specified, the auto range operation is turned OFF. Range select will be turned ON.
 - If the number of times to perform averaging is set to any value other than 1 and the range is changed, averaging is restarted.
 - If any value other than <Current range (NR2)> is specified, the set value will be set to the range that can be measured. However, if the specified value exceeds the full scale of the range, the next highest range will be set instead.
 - If a negative value is specified, the absolute value will be used.
 - You cannot change this setting during integration, while the display is held.
 - If you are using a current sensor, use the **:CURRent:EXTRange(?)** command.
 - **:CURRent:RANGe(?)** performs the same operation.

Set Whether to Select All Auto-range Current Ranges

Syntax	Command	:CURRent:SElect:ALL ON/OFF
Description	Command	Sets whether to enable use of all current ranges and external current sensors during auto-range operation and auto-range integration.
Example	Command	:CURR:SEL:ALL ON
Note		<ul style="list-style-type: none"> • Use of the 100 mA and 20 A ranges as well as the external current sensor C5A range is always enabled, regardless of the value of this setting. • Specifying a current range with the “:CURRent:RANGe” command will cause range select for the specified range to be turned on. • You cannot change this setting during integration, while the display is held, or when the maximum/minimum values are being held.

Set and Query Auto-range Current Range Select

Syntax	Command	<pre> :CURRent:SElect:I1mA ON/OFF :CURRent:SElect:I2mA ON/OFF :CURRent:SElect:I5mA ON/OFF :CURRent:SElect:I10mA ON/OFF :CURRent:SElect:I20mA ON/OFF :CURRent:SElect:I50mA ON/OFF :CURRent:SElect:I200mA ON/OFF :CURRent:SElect:I500mA ON/OFF :CURRent:SElect:I1A ON/OFF :CURRent:SElect:I2A ON/OFF :CURRent:SElect:I5A ON/OFF :CURRent:SElect:I10A ON/OFF :CURRent:SElect:C1A ON/OFF :CURRent:SElect:C2A ON/OFF </pre>
	Query	<pre> :CURRent:SElect:I1mA? :CURRent:SElect:I2mA? :CURRent:SElect:I5mA? :CURRent:SElect:I10mA? :CURRent:SElect:I20mA? :CURRent:SElect:I50mA? :CURRent:SElect:I100mA? :CURRent:SElect:I200mA? :CURRent:SElect:I500mA? :CURRent:SElect:I1A? :CURRent:SElect:I2A? :CURRent:SElect:I5A? :CURRent:SElect:I10A? :CURRent:SElect:I20A? :CURRent:SElect:C1A? :CURRent:SElect:C2A? :CURRent:SElect:C5A? </pre>
	Response	<pre> <ON/OFF> ON Performs measurement using the current range in question during range key operation, auto-range operation, and auto-range integration. OFF Disables use of the current range in question during range key operation, auto-range operation, and auto-range integration. </pre>
Description	Command	Toggles use of the current range in question during range key operation, auto-range operation, and auto-range integration.
	Query	Returns whether the current range in question is used during range key operation, auto-range operation, and auto-range integration.
Example	Command	:CURR:SEL:I5A ON
	Query	:CURR:SEL:I5A?
	Response	(When HEADER ON) :CURRENT:SELECT:I5A ON (When HEADER OFF) ON
Note	<ul style="list-style-type: none"> • Specifying a current range with the :CURRent:RANGe or :CURRent:EXTRange command will cause range select for the specified range to be turned on. • You cannot change this setting during integration, while the display is held, or when the maximum/minimum values are being held. • Since use of the 100 mA and 20 A ranges as well as the external current sensor 5 A range is always enabled, queries will always return "ON." • There is no abbreviated format available for the current range portion of the command 	

(the “m” in “1 mA” an similar text cannot be omitted).

Set and Query Current Range Select

Syntax	Command	:CURRent:SElect <data1(NR1)>, <data2(NR1)>																
	Query	:CURRent:SElect?																
	Response	<data1>,<data2> 128 64 32 16 8 4 2 1 <data1(NR1)>																
		<table border="1"> <thead> <tr> <th>bit7</th> <th>bit6</th> <th>bit5</th> <th>bit4</th> <th>bit3</th> <th>bit2</th> <th>bit1</th> <th>bit0</th> </tr> </thead> <tbody> <tr> <td>200mA</td> <td>100mA</td> <td>50mA</td> <td>20mA</td> <td>10mA</td> <td>5mA</td> <td>2mA</td> <td>1mA</td> </tr> </tbody> </table>	bit7	bit6	bit5	bit4	bit3	bit2	bit1	bit0	200mA	100mA	50mA	20mA	10mA	5mA	2mA	1mA
bit7	bit6	bit5	bit4	bit3	bit2	bit1	bit0											
200mA	100mA	50mA	20mA	10mA	5mA	2mA	1mA											
		<data2(NR1)>																
		<table border="1"> <thead> <tr> <th>Bit7</th> <th>bit6</th> <th>bit5</th> <th>bit4</th> <th>bit3</th> <th>bit2</th> <th>bit1</th> <th>bit0</th> </tr> </thead> <tbody> <tr> <td>-</td> <td>-</td> <td>20A</td> <td>10A</td> <td>5A</td> <td>2A</td> <td>1A</td> <td>500mA</td> </tr> </tbody> </table>	Bit7	bit6	bit5	bit4	bit3	bit2	bit1	bit0	-	-	20A	10A	5A	2A	1A	500mA
Bit7	bit6	bit5	bit4	bit3	bit2	bit1	bit0											
-	-	20A	10A	5A	2A	1A	500mA											
Description		<p>Sets and queries current range use settings during range key operation, auto-range operation, and auto-range integration as a value from 0 to 255 (data 1) or from 0 to 63.</p> <p>Although NRf numerical values are accepted, values to the right of the decimal are truncated.</p>																
Example	Command	:CURR:SEL 252,63																
	Query	:CURR:SEL?																
	Response	(When HEADER ON) :CURRENT:SELECT 253, 63 (When HEADER OFF) 253, 63																
Note		<ul style="list-style-type: none"> • This command is provided to ensure compatibility with control programs for existing models (3332). • To take maximum advantage of the PW3335's functionality, it is recommended to use commands such as :CURRent:SElect:110A. • This command/query cannot be used to set or query external current sensor range use settings. • This command cannot be used to set the 100 mA or 20 A ranges (which are always on). • Specifying a current range with the :CURRent:RANGe command will cause range select for the specified range to be turned on. • You cannot change this setting during integration, while the display is held, or when the maximum/minimum values are being held. 																

Set and Query External Current Sensor Input

Syntax	Command	:CURRent:TYPE <External Current Sensor Type>
	Query	:CURRent:TYPE?
	Response	<External current sensor type> <External current sensor type> = OFF/TYP1/TYP2
Description	Command	Sets the external current sensor type.
	Query	Returns the current sensor range setting as a string.
Example	Command	:CURR:TYPE TYP1
	Query	:CURR:TYPE?
	Response	(When HEADER ON) :CURRENT:TYPE TYP1 (When HEADER OFF) TYP1
Note		<ul style="list-style-type: none"> • After you change this setting, wait a few moments until the internal circuitry stabilizes before you read any measurement values. • If the number of times to perform averaging is set to any value other than 1 and the range is changed, averaging is restarted. • You cannot change this setting during integration, while the display is held, or when the maximum/minimum values are being held. • If the instrument does not have external current sensor input, a hardware error will result.

Set and Query the Current Range (When Using an External Current Sensor)

Syntax	Command	:CURRent:EXTRange <External Current Sensor Range>
	Query	:CURRent:EXTRange?
	Response	<External current sensor range> <External current sensor range> = C1/C2/C5
Description	Command	Sets the external current range. Unlike other commands such as :CURRent:RANGe , an error will occur if any value other than the above <External current sensor range> is specified.
	Query	Returns the external current sensor range setting as a string.
Example	Command	:CURR:EXTR C5
	Query	:CURR:EXTR?
	Response	(When HEADER ON) :CURRENT:EXTRANGE C5 (When HEADER OFF) C5
	Note	<ul style="list-style-type: none"> • After you change the range, wait a few moments until the internal circuitry stabilizes before you read any measurement values. • If a range is specified, the auto range operation is turned OFF. • If the number of times to perform averaging is set to any value other than 1 and the range is changed, averaging is restarted. • An error will occur if any value other than the above <External current sensor range> is specified. • You cannot change this setting during integration, while the display is held, or when the maximum/minimum values are being held.

(5) Frequency Range (Zero-crossing Filter)

Query the Frequency Range

Syntax	Query	:FREQUENCY?
	Response	<Frequency range (NR3)>
Description		Queries the frequency range setting.
Example	Query	:FREQUENCY?
	Response	(When HEADER ON) :FREQUENCY:RANGE +500.0E+0 (When HEADER OFF) +500.0E+0
Note	<ul style="list-style-type: none"> • The frequency range and zero-crossing filter settings are linked. • Instead of :FREQUENCY?, you can also use :FREQUENCY1?. (Both of these commands perform the same operation.) 	

Set and Query the Frequency Range

Syntax	Command	:FREQUENCY:RANGE <Frequency range (NR3)>
	Query	:FREQUENCY:RANGE?
	Response	<Frequency range (NR3)> <Frequency range (NR3)> = +100.0E+0,+500.0E+0,+5.0E+3,+100.0E+3
Description	Command	Sets the frequency range. (The unit used for frequency is hertz [Hz].) NRf numerical values are accepted.
Example	Query	Returns the frequency range setting in NR3 format.
	Command	:FREQ:RANG 500E+0
	Response	(When HEADER ON) :FREQUENCY:RANGE +500.0E+0 (When HEADER OFF) +500.0E+0
Note	<ul style="list-style-type: none"> • Do not append a unit to the frequency range. • After you change the range, wait a few moments until the internal circuitry stabilizes before you read any measurement values. • The same setting is applied to all channels which are a part of a wiring type. • If the number of times to perform averaging is set to any value other than 1 and the range is changed, averaging is restarted. • If any value other than <Frequency range (NR3)> is specified, the set value will be set to the range that can be measured. However, if the specified value exceeds the full scale of the range, the next highest range will be set instead. • An execution error will occur if any value that exceeds the maximum range (100 kHz) or any negative value is specified. • You cannot change this setting during integration, while the display is held, or when the maximum/minimum values are being held. • Instead of :FREQUENCY:RANGe(?), you can also use :FREQUENCY1:RANGe(?). (Both of these commands perform the same operation.) 	

(6) Synchronization Source

Set and Query the Synchronization Source

Syntax	Command	:SOURce <Synchronization source>
	Query	:SOURce?
	Response	<Synchronization source> <Synchronization source> = U / I / DC
Description		Sets or queries the synchronization source setting.
Example	Command	:SOUR U
	Query	:SOUR?
	Response	(When HEADER ON) :SOURCE U (When HEADER OFF) U
Note	<ul style="list-style-type: none"> • After you change this setting, wait a few moments until the internal circuitry stabilizes before you read any measurement values. • The same setting is applied to all channels which are a part of a wiring type. • If the number of times to perform averaging is set to any value other than 1 and this setting is changed, averaging is restarted. • You cannot change this setting during integration, while the display is held, or when the maximum/minimum values are being held. • Instead of :SOURce?, you can also use :SOURce1?. (Both of these commands perform the same operation.) 	

Set and Query the Synchronization Timeout

Syntax	Command	:SOURce:TIMEOut <Timeout value (NR2)>
	Query	:SOURce:TIMEOut?
	Response	<Timeout value (NR2)> <Timeout value> = 0.1/1/10
Description		Sets or queries the synchronization timeout. (The unit used is seconds [sec].)
Example	Command	:SOUR:TIMEO 1
	Query	:SOUR:TIMEO?
	Response	(When HEADER ON) :SOURCE:TIMEOUT 1.0 (When HEADER OFF) 1.0
Note	<ul style="list-style-type: none"> • Do not append a unit to this setting. • After you change this setting, wait a few moments until the internal circuitry stabilizes before you read any measurement values. • If the number of times to perform averaging is set to any value other than 1 and this setting is changed, averaging is restarted. • You cannot change this setting during integration, while the display is held, or when the maximum/minimum values are being held. • Instead of :SOURce:TIMEOut(?), you can also use :SOURce1:TIMEOut(?). (Both of these commands perform the same operation.) 	

Set All Zero-cross Threshold Levels

Syntax	Command	:SOURce:FILTer:LEVel:ALL <1~15(NR1)>
Description	Command	Sets the zero-cross threshold level for all voltage and current ranges.
Example	Command	:SOUR:FILT:LEV:ALL 1
Note	<ul style="list-style-type: none"> • Changing this setting when the number of times to perform averaging is set to a value other than 1 will cause averaging processing to be restarted. • Although NRf numerical values are accepted, values to the right of the decimal are truncated. • You cannot change this setting during integration, while the display is held, or when the maximum/minimum values are being held. 	

Set and Query Zero-cross Threshold Values (Voltage Ranges)

Syntax	Command	<pre> :SOURce:FILTer:LEVel:U6V <1~15 (NR1)> :SOURce:FILTer:LEVel:U15V <1~15 (NR1)> :SOURce:FILTer:LEVel:U30V <1~15 (NR1)> :SOURce:FILTer:LEVel:U60V <1~15 (NR1)> :SOURce:FILTer:LEVel:U150V <1~15 (NR1)> :SOURce:FILTer:LEVel:U300V <1~15 (NR1)> :SOURce:FILTer:LEVel:U600V <1~15 (NR1)> :SOURce:FILTer:LEVel:U1000V <1~15 (NR1)> </pre>
	Query	<pre> :SOURce:FILTer:LEVel:U6V? :SOURce:FILTer:LEVel:U15V? :SOURce:FILTer:LEVel:U30V? :SOURce:FILTer:LEVel:U60V? :SOURce:FILTer:LEVel:U150V? :SOURce:FILTer:LEVel:U300V? :SOURce:FILTer:LEVel:U600V? :SOURce:FILTer:LEVel:U1000V? </pre>
	Response	<1~15(NR1)>
Description	Command	<p>Sets zero-cross threshold values.</p> <p>Although NRf numerical values are accepted, values to the right of the decimal are truncated.</p>
	Query	Queries zero-cross threshold values.
Example	Command	<pre>:SOUR:FILT:LEV:U6V 1</pre>
	Query	<pre>:SOUR:FILT:LEV:U6V?</pre>
	Response	(When HEADER ON) <pre>:SOURCE:FILTER:LEVEL:U6V 1</pre> (When HEADER OFF) <pre>1</pre>
Note		<ul style="list-style-type: none"> • Changing this setting when the number of times to perform averaging is set to a value other than 1 will cause averaging processing to be restarted. • You cannot change this setting during integration, while the display is held, or when the maximum/minimum values are being held.

Set and Query Zero-cross Threshold Values (Current Ranges)

Syntax	Command	<pre> :SOURce:FILTer:LEVel:I1mA <1~15 (NR1)> :SOURce:FILTer:LEVel:I2mA <1~15 (NR1)> :SOURce:FILTer:LEVel:I5mA <1~15 (NR1)> :SOURce:FILTer:LEVel:I10mA <1~15 (NR1)> :SOURce:FILTer:LEVel:I20mA <1~15 (NR1)> :SOURce:FILTer:LEVel:I50mA <1~15 (NR1)> :SOURce:FILTer:LEVel:I100mA <1~15 (NR1)> :SOURce:FILTer:LEVel:I200mA <1~15 (NR1)> :SOURce:FILTer:LEVel:I500mA <1~15 (NR1)> :SOURce:FILTer:LEVel:I1A <1~15 (NR1)> :SOURce:FILTer:LEVel:I2A <1~15 (NR1)> :SOURce:FILTer:LEVel:I5A <1~15 (NR1)> :SOURce:FILTer:LEVel:I10A <1~15 (NR1)> :SOURce:FILTer:LEVel:I20A <1~15 (NR1)> </pre>
	Query	<pre> :SOURce:FILTer:LEVel:I1mA? :SOURce:FILTer:LEVel:I2mA? :SOURce:FILTer:LEVel:I5mA? :SOURce:FILTer:LEVel:I10mA? :SOURce:FILTer:LEVel:I20mA? </pre>

		:SOURce:FILTer:LEVel:I50mA?
		:SOURce:FILTer:LEVel:I100mA?
		:SOURce:FILTer:LEVel:I200mA?
		:SOURce:FILTer:LEVel:I500mA?
		:SOURce:FILTer:LEVel:I1A?
		:SOURce:FILTer:LEVel:I2A?
		:SOURce:FILTer:LEVel:I5A?
		:SOURce:FILTer:LEVel:I10A?
		:SOURce:FILTer:LEVel:I20A?
	Response	<1~15(NR1)>
Description	Command	Sets zero-cross threshold values. Although NRf numerical values are accepted, values to the right of the decimal are truncated.
	Query	Queries zero-cross threshold values.
Example	Command	:SOUR:FILT:LEV:I1A 1
	Query	:SOUR:FILT:LEV:I1A?
	Response	(When HEADER ON) :SOURCE:FILTER:LEVEL:I1A 1 (When HEADER OFF) 1
Note		<ul style="list-style-type: none"> • Changing this setting when the number of times to perform averaging is set to a value other than 1 will cause averaging processing to be restarted. • You cannot change this setting during integration, while the display is held, or when the maximum/minimum values are being held.

ゼロクロスしきい値の設定と問い合わせ(外部電流センサ)

Syntax	Command	:SOURce:FILTer:LEVel:C1A <1~15 (NR1)>
		:SOURce:FILTer:LEVel:C2A <1~15 (NR1)>
		:SOURce:FILTer:LEVel:C5A <1~15 (NR1)>
	Query	:SOURce:FILTer:LEVel:C1A?
		:SOURce:FILTer:LEVel:C2A?
		:SOURce:FILTer:LEVel:C5A?
	Response	<1~15(NR1)>
Description	Command	Sets zero-cross threshold values. Although NRf numerical values are accepted, values to the right of the decimal are truncated.
	Query	Queries zero-cross threshold values.
Example	Command	:SOUR:FILT:LEV:C1A 1
	Query	:SOUR:FILT:LEV:C1A?
	Response	(When HEADER ON) :SOURCE:FILTER:LEVEL:C1A 1 (When HEADER OFF) 1
Note		<ul style="list-style-type: none"> • Changing this setting when the number of times to perform averaging is set to a value other than 1 will cause averaging processing to be restarted. • You cannot change this setting during integration, while the display is held, or when the maximum/minimum values are being held.

(7) VT Ratio/CT Ratio

Query the VT Ratio and CT Ratio

Syntax	Query	:SCALE?
	Response	<VT ratio (NR2)>,<CT ratio(NR2)>
Description		Queries the VT (PT) ratio and CT ratio setting values.
Example	Query	:SCAL?
	Response	(When HEADER ON) :SCALE:VT 2.0;CT 3.000 (When HEADER OFF) 2.0;3.000

Set and Query the VT Ratio Setting

Syntax	Command	:SCALE:VT <VT ratio (NR2)>
	Query	:SCALE:VT?
	Response	<VT ratio (NR2)> <VT ratio (NR2)> = 0.001 to 1000
Description	Command	Sets the VT (PT) ratio. NRf numerical values are accepted.
Example	Query	Returns the VT ratio setting in NR2 format.
	Command	:SCAL:VT 1.2
	Query	:SCAL:VT?
	Response	(When HEADER ON) :SCALE:VT 1.200 (When HEADER OFF) 1.200
Note		<ul style="list-style-type: none"> • If the number of times to perform averaging is set to any value other than 1 and the ratio is changed, averaging is restarted. • Changing the setting will cause the maximum and minimum values to be reset. • You cannot change this setting during integration, while the display is held, or when the maximum/minimum values are being held. • Instead of :SCALE:VT(?), you can also use :SCALE:PT(?). (Both of these commands perform the same operation.)

Set and Query the CT Ratio Setting

Syntax	Command	:SCALE:CT <CT ratio (NR2)>
	Query	:SCALE:CT?
	Response	<CT ratio (NR2)> <CT ratio (NR2)> = 0.001 to 1000
Description	Command	Sets the CT ratio. NRf numerical values are accepted.
Example	Query	Returns the CT ratio setting in NR2 format.
	Command	:SCAL:CT 2.1
	Query	:SCAL:CT?
	Response	(When HEADER ON) :SCALE:CT 2.100 (When HEADER OFF) 2.100
Note		<ul style="list-style-type: none"> • If the number of times to perform averaging is set to any value other than 1 and the range is changed, averaging is restarted. • Changing the setting will cause the maximum and minimum values to be reset. • You cannot change this setting during integration, while the display is held, or when the maximum/minimum values are being held.

(8) D/A output

Set and Query D/A Output (D/A1) Settings

Syntax	Command	Output Terminal D/A1	:AOUT <Output item>
	Query	Output Terminal D/A1	:AOUT?
	Response	<Output item> See List of Measurement Item Specifications for details about the <Output item> field.	
Description	Command	D/A1 Output Item	
	Query	Returns the D/A1 output item. (Same as :AOUT:ITEM:DA1 .)	
Example	Command	:AOUT S	
	Query	:AOUT?	
	Response	(When HEADER ON)	:AOUT:ITEM:DA1 S
		(When HEADER OFF)	S
Note	You can use the AOUT:ITEM(?) command to query and set DA1 through DA7. • A device error will occur on units that do not have a D/A output.		

Set and Query the D/A Output Terminal (D/A1 to D/A7) Output Items

Syntax	Command	Output Terminal D/A1	:AOUT:ITEM:DA1 <D/A output item>	
		Output Terminal D/A2	:AOUT:ITEM:DA2 <D/A output item>	
		Output Terminal D/A3	:AOUT:ITEM:DA3 <D/A output item>	
		Output Terminal D/A4	:AOUT:ITEM:DA4 <D/A output item>	
		Output Terminal D/A5	:AOUT:ITEM:DA5 <D/A output item>	
		Output Terminal D/A6	:AOUT:ITEM:DA6 <D/A output item>	
		Output Terminal D/A7	:AOUT:ITEM:DA7 <D/A output item>	
	Query	Output Terminal D/A1	:AOUT:ITEM:DA1?	
		Output Terminal D/A2	:AOUT:ITEM:DA2?	
		Output Terminal D/A3	:AOUT:ITEM:DA3?	
		Output Terminal D/A4	:AOUT:ITEM:DA4?	
		Output Terminal D/A5	:AOUT:ITEM:DA5?	
		Output Terminal D/A6	:AOUT:ITEM:DA6?	
		Output Terminal D/A7	:AOUT:ITEM:DA7?	
	Response	<D/A output item> See the D/A output item specification list for details.		
	Description	Sets or queries the output (rectification method) of the D/A output terminals (DA1 to DA7).		
	Example	Command	:AOUT:ITEM:DA1 WP	
Query		:AOUT:ITEM:DA1?		
Response		(When HEADER ON)	:AOUT:ITEM:DA1 WP	
		(When HEADER OFF)	WP	
Note	• A device error will occur on units that do not have a D/A output.			

Set and Query Current Range Select during D/A Output Terminal (D/A 1 to 7) Integrated Value Output

Syntax	Command	Output Terminal D/A1	:AOUT:IRANge:DA1 <integrated value current range (NR2)>
		Output Terminal D/A2	:AOUT:IRANge:DA2 <integrated value current range (NR2)>
		Output Terminal D/A3	:AOUT:IRANge:DA3 <integrated value current range (NR2)>
		Output Terminal D/A4	:AOUT:IRANge:DA4 <integrated value current range (NR2)>
		Output Terminal D/A5	:AOUT:IRANge:DA5 <integrated value current range (NR2)>
		Output Terminal D/A6	:AOUT:IRANge:DA6 <integrated value current range (NR2)>
		Output Terminal D/A7	:AOUT:IRANge:DA7 <integrated value current range (NR2)>
	Query	Output Terminal D/A1	:AOUT:IRANge:DA1?
		Output Terminal D/A2	:AOUT:IRANge:DA2?
		Output Terminal D/A3	:AOUT:IRANge:DA3?
		Output Terminal D/A4	:AOUT:IRANge:DA4?
		Output Terminal D/A5	:AOUT:IRANge:DA5?
		Output Terminal D/A6	:AOUT:IRANge:DA6?
		Output Terminal D/A7	:AOUT:IRANge:DA7?
	Response		< integrated value current range (NR2)> 0 0.2 / 0.5 / 1 / 2 / 5 / 10 / 20 BACKUP

Description

Integrated values exist for each current range when auto-range integration is performed. This command sets or queries the current range for which to output data when outputting integrated values. (Unit: ampere [A])
NRf numerical values are accepted.
When the value 0 is selected, integrated values for all ranges are added, and the resulting total value is output.

Example

Command	Returns the current range setting as an NR2-format value or string.
Query	:AOUT:IRANge:DA1?
Response	(When HEADER ON) :AOUT:IRANge:DA1 0.2 (When HEADER OFF) 0.2

Note • A device error will occur on units that do not have a D/A output.

- When auto-range integration is off, changing the setting results in an execution error. For DA output, the total value will be output regardless of the setting.
- Specifying a value other than <integrated value current range (NR2)> will cause the setting to be changed to “range that can measure the specified value.” However, the next range up will be selected if the range’s full-scale value is exceeded.
- If a negative value is specified, the absolute value will be used.

D/A output item specification list

(For :AOUT:ITEM:DA1~7)

Description			Parameter List (Values in parentheses can also be used.)										
Output items	Speed	Full-scale or output range (5Vfs.)	Rectification Method										
			ACDC	ACDC UMEAN	DC	AC	FND						
Voltage (U)	標準	2Vf.s.	U (V,V1,U1)	UMN	UDC	UAC	UFND						
		5Vf.s.	U_5V	UMN_5V	UDC_5V	UAC_5V	UFND_5V						
	高速	2Vf.s.	U_F	/									
		5Vf.s.	U_F5V										
	波形	1Vf.s.	U_WV										
Current (I)	標準	2Vf.s.	I (AA1,I1)						(IMN)	IDC	IAC	IFND	
		5Vf.s.	I_5V						(IMN_5)	IDC_5V	IAC_5V	IFND_5V	
	高速	2Vf.s.	I_F	/									
		5Vf.s.	I_F5V										
	波形	1Vf.s.	I_WV										
Active power (P)	標準	2Vf.s.	P (W,W1,P1)						PMN	PDC	PAC	PFND	
		5Vf.s.	P_5V						PMN_5V	PDC_5V	PAC_5V	PFND_5V	
	高速	2Vf.s.	P_F	/									
		5Vf.s.	P_F5V										
	波形	1Vf.s.	P_WV										
Apparent power (S)	標準	2Vf.s.	S (VA,VA1,S1)						SMN	/		SAC	SFND
		5Vf.s.	S_5V						SMN_5V			SAC_5V	SFND_5V
Inactive power (Q)	標準	2Vf.s.	Q (VAR,VAR1,Q1)	QMN	/		QAC	QFND					
		5Vf.s.	Q_5V	QMN_5V			QAC_5V	QFND_5V					
Power factor (λ)	標準	2Vf.s.	PF (PF1)	PFMN			/		PFAC			PFND	
		5Vf.s.	PF_5V	PFMN_5V					PFAC_5V	PFND_5V			
Phase angle (φ)	標準	2Vf.s.	/						/		DEGAC	DEGFND	
		5Vf.s.			DEGAC_5V	DEGFND_5V							
Voltage frequency (f)	標準	0.5Hz			FREQU_05								
		5Hz			FREQU_5								
		50Hz			FREQU_50 or FREQU								
		500Hz	FREQU_500										
		5kHz	FREQU_5K										
		50kHz	FREQU_50K										
		500kHz	FREQU_500K										
Current frequency (f)	標準	0.5Hz	FREQU_05										
		5Hz	FREQU_5										
		50Hz	FREQU_50 or FREQU										
		500Hz	FREQU_500										
		5kHz	FREQU_5K										
		50kHz	FREQU_50K										
		500kHz	FREQU_500K										
Positive	標準	5mAh	/		/		PIHDC_0005	/					

Description			Parameter List (Values in parentheses can also be used.)				
Output items	Speed	Full-scale or output range (5Vfs.)	Rectification Method				
			ACDC	ACDC UMEAN	DC	AC	FND
current integration (See Note 1.)		50mAh			PIHDC_005		
		500mAh			PIHDC_05		
		5Ah			PIHDC_5		
		50Ah			PIHDC_50 or PIHDC		
		500Ah			PIHDC_500		
		5kAh			PIHDC_5K		
		50kAh			PIHDC_50K		
		500kAh			PIHDC_500K		
		5MAh			PIHDC_5M		
		50MAh			PIHDC_50M		
		500MAh			PIHDC_500M		
		5000MAh			PIHDC_5000M		
		Negative current integration (See Note 1.)	標準	5mAh			MIHDC_005
50mAh					MIHDC_05		
500mAh					MIHDC_05		
5Ah					MIHDC_5		
50Ah					MIHDC_50 or MIHDC		
500Ah					MIHDC_500		
5kAh					MIHDC_5K		
50kAh					MIHDC_50K		
500kAh					MIHDC_500K		
5MAh					MIHDC_5M		
50MAh					MIHDC_50M		
500MAh					MIHDC_500M		
5000MAh					MIHDC_5000M		
Current integration (total sum) (See Note 1.) (See Note 2.)	標準	5mAh	IH_0005	IHMN_0005	IHDC_0005		
		50mAh	IH_005	IHMN_005	IHDC_005		
		500mAh	IH_05	IHMN_05	IHDC_05		
		5Ah	IH_5	IHMN_5	IHDC_5		
		50Ah	IH_50 or IH (AH,AH1, IH1)	IHMN_50 or IHMN	IHDC_50 or IHDC		
		500Ah	IH_500	IHMN_500	IHDC_500		
		5kAh	IH_5K	IHMN_5K	IHDC_5K		
		50kAh	IH_50K	IHMN_50K	IHDC_50K		
		500kAh	IH_500K	IHMN_500K	IHDC_500K		
		5MAh	IH_5M	IHMN_5M	IHDC_5M		
		50MAh	IH_50M	IHMN_50M	IHDC_50M		
		500MAh	IH_500M	IHMN_500M	IHDC_500M		
		5000MAh	IH_5000M	IHMN_5000M	IHDC_5000M		
Positive Active power integration (See Note 1.)	標準	5mWh	PWP_0005	PWPMN_0005	PWPDC_0005		
		50mWh	PWP_005	PWPMN_005	PWPDC_005		
		500mWh	PWP_05	PWPMN_05	PWPDC_05		
		5Wh	PWP_5	PWPMN_5	PWPDC_5		
		50Wh	PWP_50	PWPMN_50	PWPDC_50		

Description			Parameter List (Values in parentheses can also be used.)				
Output items	Speed	Full-scale or output range (5Vfs.)	Rectification Method				
			ACDC	ACDC UMEAN	DC	AC	FND
		500Wh	PWP_500 Or PWP (PWH, PWH1, PWP1)	PWPMN_500 Or PWPMN	PWPDC_500 Or PWPDC		
		5kWh	PWP_5K	PWPMN_5K	PWPDC_5K		
		50kWh	PWP_50K	PWPMN_50K	PWPDC_50K		
		500kWh	PWP_500K	PWPMN_500K	PWPDC_500K		
		5MWh	PWP_5M	PWPMN_5M	PWPDC_5M		
		50MWh	PWP_50M	PWPMN_50M	PWPDC_50M		
		500MWh	PWP_500M	PWPMN_500M	PWPDC_500M		
		5000MW	PWP_5000M	PWPMN_5000M	PWPDC_5000M		
Negative active power integration (See Note 1.)	標準	5mWh	MWP_0005	MWPMN_0005	MWPDC_0005		
		50mWh	MWP_005	MWPMN_005	MWPDC_005		
		500mWh	MWP_05	MWPMN_05	MWPDC_05		
		5Wh	MWP_5	MWPMN_5	MWPDC_5		
		50Wh	MWP_50	MWPMN_50	MWPDC_50		
		500Wh	MWP_500 Or MWP (MWH, MWH1, MWP1)	MWPMN_500 Or MWPMN	MWPDC_500 Or MWPDC		
		5kWh	MWP_5K	MWPMN_5K	MWPDC_5K		
		50kWh	MWP_50K	MWPMN_50K	MWPDC_50K		
		500kWh	MWP_500K	MWPMN_500K	MWPDC_500K		
		5MWh	MWP_5M	MWPMN_5M	MWPDC_5M		
		50MWh	MWP_50M	MWPMN_50M	MWPDC_50M		
		500MWh	MWP_500M	MWPMN_500M	MWPDC_500M		
		5000MW	MWP_5000M	MWPMN_5000M	MWPDC_5000M		
Active power (total sum of integration) (See Note 1.)	標準	5mWh	WP_0005	WPMN_0005	WPDC_0005		
		50mWh	WP_005	WPMN_005	WPDC_005		
		500mWh	WP_05	WPMN_05	WPDC_05		
		5Wh	WP_5	WPMN_5	WPDC_5		
		50Wh	WP_50	WPMN_50	WPDC_50		
		500Wh	WP_500 Or WP (WH, WH1, WP1)	WPMN_500 Or WPMN	WPDC_500 Or PWPDC		
		5kWh	WP_5K	WPMN_5K	WPDC_5K		
		50kWh	WP_50K	WPMN_50K	WPDC_50K		
		500kWh	WP_500K	WPMN_500K	WPDC_500K		
		5MWh	WP_5M	WPMN_5M	WPDC_5M		
		50MWh	WP_50M	WPMN_50M	WPDC_50M		
		500MWh	WP_500M	WPMN_500M	WPDC_500M		
		5000MW	WP_5000M	WPMN_5000M	WPDC_5000M		

Description			Parameter List (Values in parentheses can also be used.)				
Output items	Speed	Full-scale or output range (5Vf.s.)	Rectification Method				
			ACDC	ACDC UMEAN	DC	AC	FND
Maximum Current Ratio (MCR)	標準	2Vf.s.	MCR				
		5Vf.s.	MCR_5V				
Voltage crest factor (Ucf)	標準	2Vf.s.	UCF				
		5Vf.s.	UCF_5V				
Current crest factor (Icf)	標準	2Vf.s.	ICF				
		5Vf.s.	ICF_5V				
Time average current (T.AV I) (See Note 1.) (See Note 2.)	標準	2Vf.s.	ITAV	ITAVMN	ITAVDC		
		5Vf.s.	ITAV_5V	ITAVMN_5V	ITAVDC_5V		
Time average power (T.AV P) (See Note 1.)	標準	2Vf.s.	PTAV	PTAVMN	PTAVDC		
		5Vf.s.	PTAV_5V	PTAVMN_5V	PTAVDC_5V		
Voltage ripple factor (Urf)	標準	2Vf.s.	URF				
		5Vf.s.	URF_5V				
Current ripple factor (Irf)	標準	2Vf.s.	IRF				
		5Vf.s.	IRF_5V				
Voltage total distortion factor (Uthd)	標準	2Vf.s.	UTHD				
		5Vf.s.	UTHD_5V				
Current total distortion factor (Ithd)	標準	2Vf.s.	ITHD				
		5Vf.s.	ITHD_5V				

Note 1: Outputs the measured value for the current range specified with :AOUT:IRANge:DAX.

Note 2: During auto-range integration mode operation, ACDC and ACDC UMEAN result in invalid data, triggering 0 V output.

(9) Instrument Display Settings

Set and Query Instrument Display Items (Normal Measurement Items)

Syntax	Command	Display Area: a to d	:DISPlay[:NORMal] <Display a>,<Display b>,<Display c>,<Display d>
		Display Area: a	:DISPlay:NORMal:A <Display a>
		Display Area: b	:DISPlay:NORMal:B <Display b>
		Display Area: c	:DISPlay:NORMal:C <Display c>
		Display Area: d	:DISPlay:NORMal:D <Display d>
	Query	Display Area: a to d	:DISPlay[:NORMal]?
		Display Area: a	:DISPlay:NORMal:A?
		Display Area: b	:DISPlay:NORMal:B?
		Display Area: c	:DISPlay:NORMal:C?
		Display Area: d	:DISPlay:NORMal:D?
	Response		<Display a>,<Display b>,<Display c>,<Display d> See List of Measurement Item Specifications for details about the <Display items a to d> fields.
Description	Command		Sets or queries the items to display in the instrument display areas "a" to "d".
Example	Command		:DISP U,I,P,TIME The instrument display area settings are as follows: Display Area "a": Voltage (acdc) Display Area "b": Current (acdc) Display Area "c": Active power (acdc) Display Area "d": Integration time
	Query		:DISP?
	Response		(When HEADER ON) :DISPLAY U,I,P,TIME (When HEADER OFF) U,I,P,TIME

Note • The value displayed (instantaneous value, maximum value, or minimum value) depends on the HOLD state.

The HOLD states and the subsequent output values are as follows:

HOLD State	Displayed Content
OFF	Instantaneous value
ON	HOLD value
Maximum value hold	Maximum value
Minimum value hold	Minimum value

- If this command is issued while in harmonic wave display mode, use the :DISPlay:MODE command to change to normal display mode.
- The above-mentioned "instantaneous value" corresponds to the averaged value while the value is being averaged.

Normal Measurement Display Items List

(For :DISPlay[:NORMal])

Description		Parameter List	:DISPlay :NORMal Compatibility
Output items	Rectificati on Method		
Voltage (U)	ACDC	U (U1/V can also be used.)	a,b,c,d
	ACDC UMEAN	UMN (UMN1 can also be used.)	a,b,c,d
	DC	UDC (UDC1 can also be used.)	a,b,c,d
	AC	UAC (UAC1 can also be used.)	a,b,c,d
	FND	UFND (UFND1 can also be used.)	a,b,c,d
Current (I)	ACDC	I (I1/A can also be used.)	a,b,c,d
	DC	IDC (IDC1 can also be used.)	a,b,c,d
	AC	IAC (IAC1 can also be used.)	a,b,c,d
	FND	IFND (IFND1 can also be used.)	a,b,c,d
Active power (P)	ACDC	P (P1/W can also be used.)	a,b,c,d
	ACDC UMEAN	PMN (PMN1 can also be used.)	a,b,c,d
	DC	PDC (PDC1 can also be used.)	a,b,c,d
	AC	PAC (PAC1 can also be used.)	a,b,c,d
	FND	PFND (PFND1 can also be used.)	a,b,c,d
Apparent power (S)	ACDC	S (S1/VA can also be used.)	a,b,c,d
	ACDC UMEAN	SMN (SMN1 can also be used.)	a,b,c,d
	AC	SAC (SAC1 can also be used.)	a,b,c,d
	FND	SFND (SFND1 can also be used.)	a,b,c,d
Inactive power (Q)	ACDC	Q (Q1/VAR can also be used.)	a,b,c,d
	ACDC UMEAN	QMN (QMN1 can also be used.)	a,b,c,d
	AC	QAC (QAC1 can also be used.)	a,b,c,d
	FND	QFND (QFND1 can also be used.)	a,b,c,d
Power factor (λ)	ACDC	PF (PF1 can also be used.)	a,b,c,d
	ACDC UMEAN	PFMN (PFMN1 can also be used.)	a,b,c,d
	AC	PFAC (PFAC1 can also be used.)	a,b,c,d
	FND	PFND (PFND1 can also be used.)	a,b,c,d
Phase angle (φ)	AC	DEGAC (DEGAC1 can also be used.)	a,b,c,d
	FND	DEGFND (DEGFND1 can also be used.)	a,b,c,d
Voltage frequency (f)	-	FREQU (FREQU1 can also be used.)	a,b
Current frequency (f)	-	FREQI (FREQI1 can also be used.)	a,b
Positive current integration	DC	PIHDC (PIHDC1 can also be used.) PIHDC_TOTAL	a,b
		During Auto-range integration operation: Data by current range PIHDC_IRANGE	a,b: See Note 1.
Negative current integration	DC	MIHDC (MIHDC1 can also be used.) MIHDC_TOTAL	a,b
		During Auto-range integration operation: Data by current range MIHDC_IRANGE	a,b: See Note 1.
Current integration (total sum)	ACDC	IH (IH1/AH can also be used.) IH_TOTAL	a,b,c,d
	ACDC UMEAN	IHMN (IHMN1 can also be used.) IHMN_TOTAL	a,b,c,d
	DC	IHDC (IHDC1 can also be used.) IHDC_TOTAL	a,b,c,d
		During Auto-range integration operation: Data by current range IHMN_IRANGE	a,b,c,d: See Note 1.

Description		Parameter List	:DISPlay :NORMal Compatibility
Output items	Rectificati on Method		
Positive Active power integration	ACDC	PWP (PWP1/PWH/PINTEG can also be used.) PWP_TOTAL	a,b
		During Auto-range integration operation: Data by current range PWP_IRANGE	a,b: See Note 1.
	ACDC UMEAN	PWPMN (PWPMN1 can also be used.) PWPMN_TOTAL	a,b
		During Auto-range integration operation: Data by current range PWPMN_IRANGE	a,b: See Note 1.
	DC	PWPDC (PWPDC1 can also be used.) PWPDC_TOTAL	a,b
		During Auto-range integration operation: Data by current range PWPDC_IRANGE	a,b: See Note 1.
Negative active power integration	ACDC	MWP (MWP1/MWH/MINTEG can also be used.) MWP_TOTAL	a,b
		During Auto-range integration operation: Data by current range MWP_IRANGE	a,b: See Note 1.
	ACDC UMEAN	MWPMN (MWPMN1 can also be used.) MWPMN_TOTAL	a,b
		During Auto-range integration operation: Data by current range MWPMN_IRANGE	a,b: See Note 1.
	DC	MWPDC (MWPDC1 can also be used.) MWPDC_TOTAL	a,b
		During Auto-range integration operation: Data by current range MWPDC_IRANGE	a,b: See Note 1.
Active power (total sum of integration)	ACDC	WP (WP1/WH/INTEG can also be used.) WP_TOTAL	a,b,c,d
		During Auto-range integration operation: Data by current range WP_IRANGE	a,b,c,d: See Note 1.
	ACDC UMEAN	WPMN (WPMN1 can also be used.) WPMN_TOTAL	a,b,c,d
		During Auto-range integration operation: Data by current range WPMN_IRANGE	a,b,c,d: See Note 1.
	DC	WPDC (WPDC1 can also be used.) WPDC_TOTAL	a,b,c,d
		During Auto-range integration operation: Data by current range WPDC_IRANGE	a,b,c,d: See Note 1.
Integration time	-	TIME TIME_TOTAL	a,b,c,d
		During Auto-range integration operation: Data by current range TIME_IRANGE	a,b,c,d: See Note 1.
Voltage waveform peak value (Upk)	-	UPK (UPK1 can also be used.)	a,b
Current waveform peak value (Ipk)	-	IPK (IPK1 can also be used.)	a,b
Max Current Ratio(MCR)	-	MCR	c,d
Voltage crest factor (Ucf)	-	UCF (UCF1 can also be used.)	c,d
Current crest factor (Icf)	-	ICF (ICF1 can also be used.)	c,d

Description		Parameter List	:DISPlay :NORMal Compatibility
Output items	Rectificati on Method		
Time average current (T.AV I)	ACDC	ITAV (ITAV1 can also be used.) ITAV_TOTAL	a,b,c,d
	ACDC UMEAN	ITAVMN (ITAVMN1 can also be used.) ITAVMN_TOTAL	a,b,c,d
	DC	ITAVDC (ITAVDC1 can also be used.) ITAVDC_TOTAL	a,b,c,d
During Auto-range integration operation: Data by current range ITAVDC_IRANGE		a,b,c,d: See Note 1.	
Time average power (T.AV P)	ACDC	PTAV (PTAV1 can also be used.) PTAV_TOTAL	a,b,c,d
		During Auto-range integration operation: Data by current range ITAV_IRANGE	a,b,c,d: See Note 1.
	ACDC UMEAN	PTAVMN (PTAVMN1 can also be used.) PTAVMN_TOTAL	a,b,c,d
		During Auto-range integration operation: Data by current range PTAVMN_IRANGE	a,b,c,d: See Note 1.
	DC	PTAVDC (PTAVDC1 can also be used.) PTAVDC_TOTAL	a,b,c,d
		During Auto-range integration operation: Data by current range PTAVDC_IRANGE	a,b,c,d: See Note 1.
Voltage ripple factor (Urf)	-	URF (URF1 can also be used.)	c,d
Current ripple factor (Irf)	-	IRF (IRF1 can also be used.)	c,d
Voltage total distortion factor (Uthd)	-	UTHD (UTHD1 can also be used.)	c,d
Current total distortion factor (Ithd)	-	ITHD (ITHD1 can also be used.)	c,d

*Note 1: Valid data is displayed only when using auto-range integration.

Toggle and Query the Normal Measurement and Harmonic Wave Measurement Display Modes

Syntax	Command	:DISPlay:MODE <NORM/HRMS/HCON /HOSRMS/HOSCON>
	Query	:DISPlay:MODE?
	Response	<NORM/HRMS/HCON/HOSRMS/HOSCON> NORM: Normal measurement values HRMS: Harmonic wave level display, all orders (a: order, b/c/d: harmonic wave measurement) HCON: Harmonic wave content display, all orders (a: order, b/c/d: harmonic wave measurement) HOSRMS: Harmonic wave level display, individual orders (a/b/c/d: harmonic wave measurement) HOSCON: Harmonic wave content display, individual orders (a/b/c/d: harmonic wave measurement)
Description		Toggles or queries the content of the display area (normal measurement or harmonic wave measurement).
Example	Command	:DISP:MODE NORM
	Query	:DISP:MODE?
	Response	(When HEADER ON) :DISPLAY:MODE NORM (When HEADER OFF) NORM

Set and Query the Displayed Order for Harmonic Wave Common Order Display Mode

Syntax	Command	:DISPlay:HARMOic:ORDer <0 to 50 (NR1)>
	Query	:DISPlay:HARMOic:ORDer?
	Response	<0 to 50 (NR1)>
Description		Sets or queries the order for harmonic wave common order display mode. Although NRf numerical values are accepted, values to the right of the decimal are dropped.
Example	Command	:DISP:HARM:ORD 21
	Query	:DISP:HARM:ORD?
	Response	(When HEADER ON) :DISPLAY:HARMONIC:ORDER 21 (When HEADER OFF) 21
Note		• If the display is in any other mode other than harmonic wave (all orders) display mode, the display will not be immediately affected by this command. The setting will be applied when the display mode is changed via a command such as :DISPlay:MODE .

Set and Query the Display Items for Harmonic Wave Common Order Display Mode

Syntax	Command	Display Area: b :DISPlay:HARMOic:B:ITEM <Harmonic wave display item>
		Display Area: c :DISPlay:HARMOic:C:ITEM <Harmonic wave display item>
		Display Area: d :DISPlay:HARMOic:D:ITEM <Harmonic wave display item>
	Query	Display Area: b :DISPlay:HARMOic:B:ITEM?
		Display Area: c :DISPlay:HARMOic:C:ITEM?
		Display Area: d :DISPlay:HARMOic:D:ITEM?
	Response	<Harmonic wave display item> Harmonic wave voltage HU (HU1 can also be used.) Harmonic wave current HI (HI1 can also be used.) the harmonic wave active power output HP (HP1 can also be used.)
Description		Sets or queries the display items for harmonic wave common order display mode.
Example	Command	:DISP:HARM:B:ITEM HU
	Query	:DISP:HARM:B:ITEM?
	Response	(When HEADER ON) :DISPLAY:HARMONIC:B:ITEM HU (When HEADER OFF) HU
Note		• If the display is in any other mode other than harmonic wave (all orders) display mode, the display will not be immediately affected by this command. Change the display mode via a command such as :DISPlay:MODE .

Set and Query the Displayed Order for Harmonic Wave Individual Order Display Mode

Syntax	Command	Display Area: a	:DISPlay:HORDerSel:A:ORDER	<0 to 50 (NR1)>
		Display Area: b	:DISPlay:HORDerSel:B:ORDER	<0 to 50 (NR1)>
		Display Area: c	:DISPlay:HORDerSel:C:ORDER	<0 to 50 (NR1)>
		Display Area: d	:DISPlay:HORDerSel:D:ORDER	<0 to 50 (NR1)>
	Query	Display Area: a	:DISPlay:HORDerSel:A:ORDER?	
		Display Area: b	:DISPlay:HORDerSel:B:ORDER?	
		Display Area: c	:DISPlay:HORDerSel:C:ORDER?	
		Display Area: d	:DISPlay:HORDerSel:D:ORDER?	
	Response			<0 to 50 (NR1)>
Description				Sets or queries the displayed order for harmonic wave individual order display mode.
Example	Command		:DISP:HORDS:A:ORD 39	
	Query		:DISP:HORDS:A:ORD?	
	Response	(When HEADER ON)	:DISPLAY:HORDERSEL:A:ORDER 39	
		(When HEADER OFF)	39	
Note				<ul style="list-style-type: none"> If the display is in any other mode other than harmonic wave (individual order) display mode, the display will not be immediately affected by this command. Change the display mode via a command such as :DISPlay:MODE.

Set and Query the Display Items for Harmonic Wave Individual Order Display Mode

Syntax	Command	Display Area: a	:DISPlay:HORDerSel:A:ITEM	<Harmonic wave display item>
		Display Area: b	:DISPlay:HORDerSel:B:ITEM	<Harmonic wave display item>
		Display Area: c	:DISPlay:HORDerSel:C:ITEM	<Harmonic wave display item>
		Display Area: d	:DISPlay:HORDerSel:D:ITEM	<Harmonic wave display item>
	Query	Display Area: a	:DISPlay:HORDerSel:A:ITEM?	
		Display Area: b	:DISPlay:HORDerSel:B:ITEM?	
		Display Area: c	:DISPlay:HORDerSel:C:ITEM?	
		Display Area: d	:DISPlay:HORDerSel:D:ITEM?	
	Response			<Harmonic wave display item>
Description				See the :DISPlay:HARMonic:B:ITEM section for details. Sets or queries the display items for harmonic wave individual order display mode.
Example	Command		:DISP:HORDS:A:ITEM HI1	
	Query		:DISP:HORDS:A:ITEM?	
	Response	(When HEADER ON)	:DISPLAY:HORDERSEL:A:ITEM HI1	
		(When HEADER OFF)	HI1	
Note				<ul style="list-style-type: none"> If the display is in any other mode other than harmonic wave (individual order) display mode, the display will not be immediately affected by this command. Change the display mode via a command such as :DISPlay:MODE.

(10) Measurement Value Output

Query Measurement Data (Normal Measurement Items)

Syntax Query

:MEASure[:POWER]? (<Output item 1>...)**:MEASure[:NORMAl]:VALue? (<Output item 1>...)****Up to a maximum of 180 items**

Response

<Output item 1><Measurement value 1>,<Output item 2><Measurement value 2>....

See the **List of Output Item Specifications** for details about the <Measurement item> field.

Output Format

Header Portion	Data Formats
Measurement Values U,I,P,S,Q,PF,DEG, FREQU,FREQI, UPK,IPK, MCR,UCF,ICF, ITAV,PTAV, URF,IRF, UTHD,ITHD	NR3 numerical value data (always 10 characters) ±ddddddE±e (dddddd: 6-character numerical value data, including decimal point, e: coefficient 0, 3, or 6)
Integration Values IH,PIH,MIH, WP,PWP,MWP	NR3 numerical value data (always 11 characters) ±ddddddE±e (dddddd: 7-character numerical value data, including decimal point, e: coefficient 0, 3, or 6)
Time Values TIME	NR1 numerical value data (always 11 characters) hhhh,mm,ss (hours, minutes, seconds)

Error Data

	Headers	Measurement Values U,I,P,S,Q,PF,DEG, FREQU,FREQI, UPK,IPK, MCR,UCF,ICF, ITAV,PTAV,URF,IRF, UTHD,ITHD	Integration Values IH,PIH,MIH, WP,PWP,MWP
Error			
Over range (Instrument display: "o.r")		±999.99E+9	None
Scaling error (Instrument display: "S.Err")		±888.88E+9	±8888.88E+9
No data		±777.77E+9	±7777.77E+9

Description Query

Returns the measurement value as a numerical value.

The output items can be specified directly as parameters to **:MEASure?**, or specified in advance via a **:MEASure:ITEM** command.If only **:MEASure[:POWER]?** is specified without an output item, the outputs specified in advance via a **:MEASure:ITEM?** command are output.If specified directly, the items are output in the order they were specified. You can specify the output items listed in the [List of Directly Specified :MEASure Query Items](#) below.If you specified the output items in advance via **:MEASure:ITEM?** commands, the items will be output in the order that they appear in the [List of Directly Specified :MEASure Query Items](#).

Example Query

:MEAS? U,I,P

Response

Outputs the voltage, current, and active power values.

(When HEADER ON) **U +150.00E+0;I +020.00E+0;P +03.000E+3**

(When HEADER OFF) **+150.00E+0;+020.00E+0;+03.00E+3**

- Note**
- When all output items are set to OFF (immediately after executing **:MEASure:ITEM:ALLClear**), the measurement values for the items shown in display areas (a) through (d) will be output.
 - You can use the **:TRANsmit:SEParator** command to change the message unit separator from a semicolon ";" to a comma ",".
 - If the display is blank (such as when the range has been changed), the response message will be "no data" ($\pm 777.77E+9$) until the measurement data is displayed.
- We recommend only using this function with a fixed range.
- If **:MEASure[:POWER]?** is called with no specified output items immediately after powering on the instrument, U, I, P, S, Q, PF, DEG, FREQU, and FREQL will be output for channels 1 through 3 and SUM.
 - The output items specified via **:MEASure:ITEM** commands will not be reset even if a system reset is performed. These items are reset only when the instrument is powered on.
 - Up to 180 items will be output for each **:MEASure?** Query. If output was specified with a **:MEASure:ITEM** command, up to 180 items will be output in the order indicated in the List of Directly Specified **:MEASure?** Query Items. Since more than 180 items cannot be output, exercise care to ensure that the number of output items is 180 or less.

List of Directly Specified **:MEASure?** Query Items

Measurement Item	Rectification Method	Type	Parameter List	Substitute parameter (can be used with the same definition)
Status		Instantaneous value	STATUS (Details P.77)	
		Total	STATUS_MAXMIN	
Voltage	AC+DC	Instantaneous value	U	U1,V
		Maximum value	U_MAX	U1_MAX
		Minimum value	U_MIN	U1_MIN
	AC+DC UMEAN	Instantaneous value	UMN	UMN1
		Maximum value	UMN_MAX	UMN1_MAX
		Minimum value	UMN_MIN	UMN1_MIN
	AC	Instantaneous value	UAC	UAC1
		Maximum value	UAC_MAX	UAC1_MAX
		Minimum value	UAC_MIN	UAC1_MIN
	DC	Instantaneous value	UDC	UDC1
		Maximum value	UDC_MAX	UDC1_MAX
		Minimum value	UDC_MIN	UDC1_MIN
	FND	Instantaneous value	UFND	UFND1
		Maximum value	UFND_MAX	UFND1_MAX
		Minimum value	UFND_MIN	UFND1_MIN
Current	AC+DC	Instantaneous value	I	I1,A
		Maximum value	I_MAX	I1_MAX
		Minimum value	I_MIN	I1_MIN
	MEAN	Instantaneous value	IMN	IMN1
		Maximum value	IMN_MAX	IMN1_MAX
		Minimum value	IMN_MIN	IMN1_MIN
	AC	Instantaneous value	IAC	IAC1
		Maximum value	IAC_MAX	IAC1_MAX
		Minimum value	IAC_MIN	IAC1_MIN
	DC	Instantaneous value	IDC	IDC1
		Maximum value	IDC_MAX	IDC1_MAX
		Minimum value	IDC_MIN	IDC1_MIN
	FND	Instantaneous value	IFND	IFND1
		Maximum value	IFND_MAX	IFND1_MAX
		Minimum value	IFND_MIN	IFND1_MIN
Active power	AC+DC	Instantaneous value	P	P1, W
		Maximum value	P_MAX	P1_MAX
		Minimum value	P_MIN	P1_MIN

Measurement Item	Rectification Method	Type	Parameter List	Substitute parameter (can be used with the same definition)
	MEAN	Instantaneous value	PMN	PMN1
		Maximum value	PMN_MAX	PMN1_MAX
		Minimum value	PMN_MIN	PMN1_MIN
	AC	Instantaneous value	PAC	PAC1
		Maximum value	PAC_MAX	PAC1_MAX
		Minimum value	PAC_MIN	PAC1_MIN
	DC	Instantaneous value	PDC	PDC1
		Maximum value	PDC_MAX	PDC1_MAX
		Minimum value	PDC_MIN	PDC1_MIN
	FND	Instantaneous value	PFND	PFND1
		Maximum value	PFND_MAX	PFND1_MAX
		Minimum value	PFND_MIN	PFND1_MIN
Apparent power	AC+DC	Instantaneous value	S	S1, VA
		Maximum value	S_MAX	S1_MAX
		Minimum value	S_MIN	S1_MIN
	AC+DC UMEAN	Instantaneous value	SMN	SMN1
		Maximum value	SMN_MAX	SMN1_MAX
		Minimum value	SMN_MIN	SMN1_MIN
	AC	Instantaneous value	SAC	SAC1
		Maximum value	SAC_MAX	SAC1_MAX
		Minimum value	SAC_MIN	SAC1_MIN
	FND	Instantaneous value	SFND	SFND1
		Maximum value	SFND_MAX	SFND1_MAX
		Minimum value	SFND_MIN	SFND1_MIN
Reactive power	AC+DC	Instantaneous value	Q	Q1, VAR
		Maximum value	Q_MAX	Q1_MAX
		Minimum value	Q_MIN	Q1_MIN
	AC+DC UMEAN	Instantaneous value	QMN	QMN1
		Maximum value	QMN_MAX	QMN1_MAX
		Minimum value	QMN_MIN	QMN1_MIN
	AC	Instantaneous value	QAC	QAC1
		Maximum value	QAC_MAX	QAC1_MAX
		Minimum value	QAC_MIN	QAC1_MIN
	FND	Instantaneous value	QFND	QFND1
		Maximum value	QFND_MAX	QFND1_MAX
		Minimum value	QFND_MIN	QFND1_MIN
Power factor	AC+DC	Instantaneous value	PF	PF1
		Maximum value	PF_MAX	PF1_MAX
		Minimum value	PF_MIN	PF1_MIN
	AC+DC UMEAN	Instantaneous value	PFMN	PFMN1
		Maximum value	PFMN_MAX	PFMN1_MAX
		Minimum value	PFMN_MIN	PFMN1_MIN
	AC	Instantaneous value	PFAC	PFAC1
		Maximum value	PFAC_MAX	PFAC1_MAX
		Minimum value	PFAC_MIN	PFAC1_MIN
	FND	Instantaneous value	PFFND	PFFND1
		Maximum value	PFFND_MAX	PFFND1_MAX
		Minimum value	PFFND_MIN	PFFND1_MIN
Phase angle	AC	Instantaneous value	DEGAC	DEGAC1
		Maximum value	DEGAC_MAX	DEGAC1_MAX
		Minimum value	DEGAC_MIN	DEGAC1_MIN
	FND	Instantaneous value	DEGFND	DEGFND1
		Maximum value	DEGFND_MAX	DEGFND1_MAX
		Minimum value	DEGFND_MIN	DEGFND1_MIN
Voltage	-	Instantaneous value	FREQU	FREQU1

Measurement Item	Rectification Method	Type	Parameter List	Substitute parameter (can be used with the same definition)
frequency		Maximum value	FREQU_MAX	FREQU1_MAX
		Minimum value	FREQU_MIN	FREQU1_MIN
Current frequency	-	Instantaneous value	FREQI	FREQI1
		Maximum value	FREQI_MAX	FREQI1_MAX
		Minimum value	FREQI_MIN	FREQI1_MIN
Voltage waveform peak value	-	Instantaneous value	UPK	UPK1
		Maximum value	UPK_MAX	UPK1_MAX
		Minimum value	UPK_MIN	UPK1_MIN
Current waveform peak value	-	Instantaneous value	IPK	IPK1, IP
		Maximum value	IPK_MAX	IPK1_MAX
		Minimum value	IPK_MIN	IPK1_MIN
Maximum Current Ratio	-	Instantaneous value	MCR	
		Maximum value	MCR_MAX	
		Minimum value	MCR_MIN	
Voltage crest factor	-	Instantaneous value	UCF	UCF1
		Maximum value	UCF_MAX	UCF1_MAX
		Minimum value	UCF_MIN	UCF1_MIN
Current crest factor	-	Instantaneous value	ICF	ICF1
		Maximum value	ICF_MAX	ICF1_MAX
		Minimum value	ICF_MIN	ICF1_MIN
Time average current	AC+DC	Instantaneous value	ITAV (See Note 3.)	ITAV1
	AC+DC UMEAN	Instantaneous value	ITAVMN (See Note 3.)	ITAVMN1
	DC	Instantaneous value	ITAVDC	ITAVDC1
			During Auto-range integration operation: Data by current range (See Note 2.) ITAVDC_200mA, ITAVDC_500mA, ITAVDC_1A, ITAVDC_2A, ITAVDC_5A, ITAVDC_10A, ITAVDC_20A, ITAVDC_BACKUP	
Time average active power	AC+DC	Instantaneous value	PTAV	PTAV1
			During Auto-range integration operation: Data by current range (See Note 2.) PTAV_200mA, PTAV_500mA, PTAV_1A, PTAV_2A, PTAV_5A, PTAV_10A, PTAV_20A, PTAV_BACKUP	
	AC+DC UMEAN	Instantaneous value	PTAVMN	PTAVMN1
			During Auto-range integration operation: Data by current range (See Note 2.) PTAVMN_200mA, PTAVMN_500mA, PTAVMN_1A, PTAVMN_2A, PTAVMN_5A, PTAVMN_10A, PTAVMN_20A, PTAVMN_BACKUP	
	DC	Instantaneous value	PTAVDC	PTAVDC1
			During Auto-range integration operation: Data by current range (See Note 2.) PTAVDC_200mA, PTAVDC_500mA, PTAVDC_1A, PTAVDC_2A, PTAVDC_5A, PTAVDC_10A, PTAVDC_20A, PTAVDC_BACKUP	
Voltage	-	Instantaneous value	URF	URF1

Measurement Item	Rectification Method	Type	Parameter List	Substitute parameter (can be used with the same definition)
ripple factor		Maximum value	URF_MAX	URF1_MAX
		Minimum value	URF_MIN	URF1_MIN
Current ripple factor	-	Instantaneous value	IRF	IRF1
		Maximum value	IRF_MAX	IRF1_MAX
		Minimum value	IRF_MIN	IRF1_MIN
Total harmonic wave voltage distortion factor	-	Instantaneous value	UTHD	UTHD1
		Maximum value	UTHD_MAX	UTHD1_MAX
		Minimum value	UTHD_MIN	UTHD1_MIN
Total harmonic wave current distortion factor	-	Instantaneous value	ITHD	ITHD1
		Maximum value	ITHD_MAX	ITHD1_MAX
		Minimum value	ITHD_MIN	ITHD1_MIN
Positive power integration	AC+DC	Instantaneous value	PWP	PWP1, PWH
			During Auto-range integration operation: Data by current range (See Note 2.) PWP_200mA, PWP_500mA, PWP_1A, PWP_2A, PWP_5A, PWP_10A, PWP_20A, PWP_BACKUP	
Negative power integration	AC+DC	Instantaneous value	MWP	MWP1, MWH
			During Auto-range integration operation: Data by current range (See Note 2.) MWP_200mA, MWP_500mA, MWP_1A, MWP_2A, MWP_5A, MWP_10A, MWP_20A, MWP_BACKUP	
Active power integration (total sum)	AC+DC	Instantaneous value	WP	WP1, WH
			During Auto-range integration operation: Data by current range (See Note 2.) WP_200mA, WP_500mA, WP_1A, WP_2A, WP_5A, WP_10A, WP_20A, WP_BACKUP	
Positive power integration	AC+DC UMEAN	Instantaneous value	PWPMN	PWPMN
			During Auto-range integration operation: Data by current range (See Note 2.) PWPMN_200mA, PWPMN_500mA, PWPMN_1A, PWPMN_2A, PWPMN_5A, PWPMN_10A, PWPMN_20A, PWPMN_BACKUP	
Negative power integration	AC+DC UMEAN	Instantaneous value	MWPMN	MWPMN1
			During Auto-range integration operation: Data by current range (See Note 2.) MWPMN_200mA, MWPMN_500mA, MWPMN_1A, MWPMN_2A, MWPMN_5A, MWPMN_10A, MWPMN_20A, MWPMN_BACKUP	
Active power	AC+DC	Instantaneous value	WPMN	WPMN1

Measurement Item	Rectification Method	Type	Parameter List	Substitute parameter (can be used with the same definition)
integration (total sum)	UMEAN		During Auto-range integration operation: Data by current range (See Note 2.) WPMN_200mA, WPMN_500mA, WPMN_1A, WPMN_2A, WPMN_5A, WPMN_10A, WPMN_20A, WPMN_BACKUP	
Positive power integration	DC	Instantaneous value	PWPDC	PWPDC1
			During Auto-range integration operation: Data by current range (See Note 2.) PWPDC_200mA, PWPDC_500mA, PWPDC_1A, PWPDC_2A, PWPDC_5A, PWPDC_10A, PWPDC_20A, PWPDC_BACKUP	
Negative power integration	DC	Instantaneous value	MWPDC	MWPDC1
			During Auto-range integration operation: Data by current range (See Note 2.) MWPDC_200mA, MWPDC_500mA, MWPDC_1A, MWPDC_2A, MWPDC_5A, MWPDC_10A, MWPDC_20A, MWPDC_BACKUP	
Active power integration (total sum)	DC	Instantaneous value	WPDC	WPDC1
			During Auto-range integration operation: Data by current range (See Note 2.) WPDC_200mA, WPDC_500mA, WPDC_1A, WPDC_2A, WPDC_5A, WPDC_10A, WPDC_20A, WPDC_BACKUP	
Current integration (total sum)	AC+DC	Instantaneous value	IH (See Note 3.)	IH1, AH
	AC+DC UMEAN	Instantaneous value	IHMN (See Note 3.)	IHMN1
Positive current integration	DC	Instantaneous value	PIHDC	PIHDC1
			During Auto-range integration operation: Data by current range (See Note 2.) PIHDC_200mA, PIHDC_500mA, PIHDC_1A, PIHDC_2A, PIHDC_5A, PIHDC_10A, PIHDC_20A, PIHDC_BACKUP	
Negative current integration	DC	Instantaneous value	MIHDC	MIHDC1
			During Auto-range integration operation: Data by current range (See Note 2.) MIHDC_200mA, MIHDC_500mA, MIHDC_1A, MIHDC_2A, MIHDC_5A, MIHDC_10A, MIHDC_20A, MIHDC_BACKUP	
Current integration	DC	Instantaneous value	IHDC	IHDC1

Measurement Item	Rectification Method	Type	Parameter List	Substitute parameter (can be used with the same definition)
(total sum)			During Auto-range integration operation: Data by current range (See Note 2.) IHDC_200mA, IHDC_500mA, IHDC_1A, IHDC_2A, IHDC_5A, IHDC_10A, IHDC_20A, IHDC_BACKUP	
Integration time	-	Instantaneous value	TIME	
			During Auto-range integration operation: Data by current range (See Note 2.) TIME_200mA, TIME_500mA, TIME_1A, TIME_2A, TIME_5A, TIME_10A, TIME_20A, TIME_BACKUP	

List of Directly Specified :MEASure? Query Items

Note: **U**→**V**, **I**→**A**, **P**→**W**, **S**→**VA**, **Q**→**VAR**, **IH**→**AH**, **PWP**→**PWH**, **MWP**→**MWH**, **WH**→**WP**, and **WH**→**INTEG** are all valid substitutions.

For example, **:MEAS? U** and **:MEAS? V** produce the same response. However, **U** is always returned as the header.

Note 2: Valid only when Auto-range integration is on.

Note 3: Valid only when Auto-range integration is off.

Perform and Query a Reset of :MEASure? and :MEASure:HARMonics? Output Items

Syntax	Command	:MEASure:ITEM:ALLClear
Description		Clears all outputs set for :MEASure? and :MEASure:HARMonic? via :MEASure:ITEM commands.
Example	Command	:MEAS:ITEM:ALLC
Note		<ul style="list-style-type: none"> • This command turns all output settings OFF. • The output settings immediately after the instrument is powered on are as follows: Normal Measurement Items U, I, P, S, Q, PF, DEGAC, FREQU, and FREQL. Harmonic Wave First order effective values HU, HI, and HP.

Query:MEASure? Output Items

Syntax	Query	:MEASure[:NORMal]:ITEM?
Description		Clears all outputs set for :MEASure? and :MEASure:HARMonic? Returns the output settings for when :MEASure? is executed without any direct specifications.
Example	Query	:MEAS:ITEM?
	Response	(When HEADER ON) :MEASURE:NORMAL:ITEM U,I,P (When HEADER OFF) U,I,P
Note		• If all output items are turned OFF, this command returns the measurement items displayed on the instrument (in display areas (a) through (d)).

Set and Query:MEASure? Output Items

Syntax Command **:DATAout:ITEM** <data1 (NR1)>,<data2 (NR1)>

Query **:DATAout:ITEM?**

Response <data1>,<data2>

128 64 32 16 8 4 2 1
<data1 (NR1)>

bit7	bit6	bit5	bit4	bit3	bit2	bit1	bit0
FREQU	DEG	PF	Q	S	P	I	U

<data2 (NR1)>

bit7	bit6	bit5	bit4	bit3	bit2	bit1	bit0
		IPK	IH	TIME	MWP	PWP	WP

Description

Sets or queries the measurement items for the :MEASure? query as a numerical value between 0 and 255. Although NRf numerical values are accepted, values to the right of the decimal are dropped.

Example

Command **:DATA:ITEM 7,0**

(This enables the output of the voltage, current, and active power.)

Query **:DATA:ITEM?**

Response (When HEADER ON) **:DATAOUT:ITEM 7,0**

(When HEADER OFF) **7,0**

Note

- This command is provided for compatibility with control programs for the existing model 3332. This command can be used only to set or query AC/DC rectification measurement values. In order to fully utilize the capabilities of the PW3335, we recommend using the [MEASure:ITEM](#) commands.

Set and Query :MEASure? Output Items (Measurement status data: instantaneous value, maximum value, minimum value)

Syntax Instantaneous value :MEASure[:NORMal]:ITEM:STATus:INST(?) <Output item>
Maximum/Minimum value :MEASure[:NORMal]:ITEM:STATus:MAXmin(?) <Output item>

Response <Output item (NR1)>

128	64	32	16	8	4	2	1
bit7	bit6	bit5	bit4	bit3	bit2	bit1	bit0
							STATUS

Description

Sets the measurement data status (instantaneous value, maximum value, minimum value) output items as numerical values between 0 and 1.

Although NRf numerical values are accepted, values to the right of the decimal are dropped.

If no items are specified directly via a :MEASure? query, output is based on the specification of this command.

INST indicates the status for the instantaneous value at the time when the data is acquired.

MAXmin indicates the total from the time the maximum and minimum values were last reset.

The Status data indicates the status of the warning indicators on the instrument when the measurement data was saved. The Status data is represented by a 32-bit hexadecimal value. The content of each of these 32 bits is as follows:

bit31	bit30	bit29	bit28	bit27	bit26	bit25	bit24
-	-	-	HM	-	-	-	RP
bit23	bit22	bit21	bit20	bit19	bit18	bit17	bit16
-	-	-	CP	-	-	-	SY
bit15	bit14	bit13	bit12	bit11	bit10	bit9	bit8
-	-	-	RI	-	-	-	RU
bit7	bit6	bit5	bit4	bit3	bit2	bit1	bit0
-	-	-	PI	-	-	-	PU

HM: Harmonic wave measurement synchronization error

RP: Active power range exceeded

CP: Instrument protection mode activated

SY: Synchronization error

RI: Current range exceeded

RU: Voltage range exceeded

PIx: Current peak exceeded

PUx: Voltage peak exceeded

Example Command :MEAS:ITEM:STAT:INST 1
Specifies to turn ON measurement status output.

Query :MEAS:ITEM:STAT:INST?

Response (When HEADER ON) :MEASURE:NORMAL:ITEM:STAT:INST 1
(When HEADER OFF) 1

Set and Query :MEASure? Output Items (Instantaneous, Maximum, and Minimum Values for Voltage Data)

Syntax Instantaneous value: **:MEASure[:NORMal]:ITEM:U:ALL <Output item>**
 Maximum value: **:MEASure[:NORMal]:ITEM:U:CH1(?) <Output item>**
 Minimum value: **:MEASure[:NORMal]:ITEM:U_MAX:ALL <Output item>**
 Minimum value: **:MEASure[:NORMal]:ITEM:U_MAX:CH1(?) <Output item>**
 Minimum value: **:MEASure[:NORMal]:ITEM:U_MIN:ALL <Output item>**
 Minimum value: **:MEASure[:NORMal]:ITEM:U_MIN:CH1(?) <Output item>**
 Response: **<Output item (NR1)>**

128	64	32	16	8	4	2	1
bit7	bit6	bit5	bit4	bit3	bit2	bit1	bit0
			FND	DC	AC	MN	ACDC

Description

Sets the voltage data (instantaneous value, maximum value, minimum value) output items as numerical values between 0 and 31.

For example, specify 1 to output the AC+DC rectification or 2 to output the AC+DC Umn rectification measurement value.

You can also output all rectification methods together at once. For example, you can specify 3 to output both the AC+DC rectification and AC+DC Umn rectification measurement values at the same time.

Although NRf numerical values are accepted, values to the right of the decimal are dropped.

If no items are specified directly via a :MEASure? query, the measurement values are output based on the specification of this command.

Example Command: **:MEAS:ITEM:U:CH1 1**
 Specifies to output the instantaneous value of the AC/DC rectified voltage.
 Query: **:MEAS:ITEM:U:CH1?**
 Response (When HEADER ON): **:MEASURE:NORMAL:ITEM:U:CH1 1**
 Response (When HEADER OFF): **1**

Set and Query :MEASure? Output Items (Instantaneous, Maximum, and Minimum Values for Current Data)

Syntax Instantaneous value: **:MEASure[:NORMal]:ITEM:I:ALL <Output item>**
 Maximum value: **:MEASure[:NORMal]:ITEM:I:CH1(?) <Output item>**
 Maximum value: **:MEASure[:NORMal]:ITEM:I_MAX:ALL <Output item>**
 Maximum value: **:MEASure[:NORMal]:ITEM:I_MAX:CH1(?) <Output item>**
 Minimum value: **:MEASure[:NORMal]:ITEM:I_MIN:ALL <Output item>**
 Minimum value: **:MEASure[:NORMal]:ITEM:I_MIN:CH1(?) <Output item>**
 Response: **<Output item (NR1)>**

128	64	32	16	8	4	2	1
bit7	bit6	bit5	bit4	bit3	bit2	bit1	bit0
			FND	DC	AC	MN	ACDC

Description

Sets the current data (instantaneous value, maximum value, minimum value) output items as numerical values between 0 and 31.

For example, specify 1 to output the AC+DC rectification or 2 to output the AC+DC Umn rectification measurement value.

You can also output all rectification methods together at once. For example, you can specify 3 to output both the AC+DC rectification and AC+DC Umn rectification measurement values at the same time.

Although NRf numerical values are accepted, values to the right of the decimal are dropped.

If no items are specified directly via a :MEASure? query, the measurement values are output based on the specification of this command.

Example Command: **:MEAS:ITEM:I:CH1 1**
 Specifies to output the instantaneous value of the AC/DC rectified current.
 Query: **:MEAS:ITEM:I:CH1?**
 Response (When HEADER ON): **:MEASURE:NORMAL:ITEM:I:CH1 1**
 Response (When HEADER OFF): **1**

Set and Query :MEASure? Output Items (Instantaneous, Maximum, and Minimum Values for Active Power Data)

Syntax Instantaneous value: **:MEASure[:NORMal]:ITEM:P:ALL** <Output item>
Maximum value: **:MEASure[:NORMal]:ITEM:P:CH1(?)** <Output item>
Minimum value: **:MEASure[:NORMal]:ITEM:P_MAX:ALL** <Output item>
:MEASure[:NORMal]:ITEM:P_MAX:CH1(?) <Output item>
:MEASure[:NORMal]:ITEM:P_MIN:ALL <Output item>
:MEASure[:NORMal]:ITEM:P_MIN:CH1(?) <Output item>

Response <Output item (NR1)>

128	64	32	16	8	4	2	1
bit7	bit6	bit5	bit4	bit3	bit2	bit1	bit0
			FND	DC	AC	MN	ACDC

Description

Sets the active power data (instantaneous value, maximum value, minimum value) output items as numerical values between 0 and 31.

For example, specify 1 to output the AC+DC rectification or 2 to output the AC+DC Umn rectification measurement value.

You can also output all rectification methods together at once. For example, you can specify 3 to output both the AC+DC rectification and AC+DC Umn rectification measurement values at the same time.

Although NRf numerical values are accepted, values to the right of the decimal are dropped.

If no items are specified directly via a :MEASure? query, the measurement values are output based on the specification of this command.

Example

Command

:MEAS:ITEM:P:CH1 1

Specifies to output the instantaneous value of the AC/DC rectified active power.

Query

:MEAS:ITEM:P:CH1?

Response

(When HEADER ON) **:MEASURE:NORMAL:ITEM:P:CH1 1**
(When HEADER OFF) **1**

Set and Query :MEASure? Output Items (Instantaneous, Maximum, and Minimum Values for Apparent Power Data)

Syntax Instantaneous value: **:MEASure[:NORMal]:ITEM:S:ALL** <Output item>
Maximum value: **:MEASure[:NORMal]:ITEM:S:CH1(?)** <Output item>
Minimum value: **:MEASure[:NORMal]:ITEM:S_MAX:ALL** <Output item>
:MEASure[:NORMal]:ITEM:S_MAX:CH1(?) <Output item>
:MEASure[:NORMal]:ITEM:S_MIN:ALL <Output item>
:MEASure[:NORMal]:ITEM:S_MIN:CH1(?) <Output item>

Response <Output item (NR1)>

128	64	32	16	8	4	2	1
bit7	bit6	bit5	bit4	bit3	bit2	bit1	bit0
			FND		AC	MN	ACDC

Description

Sets the apparent power data (instantaneous value, maximum value, minimum value) output items as numerical values between 0 and 23.

For example, specify 1 to output the AC+DC rectification or 2 to output the AC+DC Umn rectification measurement value.

You can also output all rectification methods together at once. For example, you can specify 3 to output both the AC+DC rectification and AC+DC Umn rectification measurement values at the same time.

Although NRf numerical values are accepted, values to the right of the decimal are dropped.

If no items are specified directly via a :MEASure? query, the measurement values are output based on the specification of this command.

Example

Command

:MEAS:ITEM:S:CH1 1

Specifies to output the instantaneous value of the AC/DC rectified apparent power.

Query

:MEAS:ITEM:S:CH1?

Response

(When HEADER ON) **:MEASURE:NORMAL:ITEM:S:CH1 1**
(When HEADER OFF) **1**

Set and Query :MEASure? Output Items (Instantaneous, Maximum, and Minimum Values for Inactive Power Data)

Syntax Instantaneous value :MEASure[:NORMal]:ITEM:Q:ALL <Output item>
 :MEASure[:NORMal]:ITEM:Q:CH1(?) <Output item>
 Maximum value :MEASure[:NORMal]:ITEM:Q_MAX:ALL <Output item>
 :MEASure[:NORMal]:ITEM:Q_MAX:CH1(?) <Output item>
 Minimum value :MEASure[:NORMal]:ITEM:Q_MIN:ALL <Output item>
 :MEASure[:NORMal]:ITEM:Q_MIN:CH1(?) <Output item>

Response <Output item (NR1)>

128	64	32	16	8	4	2	1
bit7	bit6	bit5	bit4	bit3	bit2	bit1	bit0
			FND		AC	MN	ACDC

Description

Sets the inactive power data (instantaneous value, maximum value, minimum value) output items as numerical values between 0 and 23.

For example, specify 1 to output the AC+DC rectification or 2 to output the AC+DC Umn rectification measurement value.

You can also output all rectification methods together at once. For example, you can specify 3 to output both the AC+DC rectification and AC+DC Umn rectification measurement values at the same time.

Although NRf numerical values are accepted, values to the right of the decimal are dropped.

If no items are specified directly via a :MEASure? query, the measurement values are output based on the specification of this command.

Example Command

:MEAS:ITEM:Q:CH1 1

Specifies to output the instantaneous value of the AC/DC rectified inactive power.

Query

:MEAS:ITEM:Q:CH1?

Response

(When HEADER ON) :MEASURE:NORMAL:ITEM:Q:CH1 1

(When HEADER OFF) 1

Set and Query :MEASure? Output Items (Instantaneous, Maximum, and Minimum Values for Power Factor Data)

Syntax Instantaneous value :MEASure[:NORMal]:ITEM:PF:ALL <Output item>
 :MEASure[:NORMal]:ITEM:PF:CH1(?) <Output item>
 Maximum value :MEASure[:NORMal]:ITEM:PF_MAX:ALL <Output item>
 :MEASure[:NORMal]:ITEM:PF_MAX:CH1(?) <Output item>
 Minimum value :MEASure[:NORMal]:ITEM:PF_MIN:ALL <Output item>
 :MEASure[:NORMal]:ITEM:PF_MIN:CH1(?) <Output item>

Response <Output item (NR1)>

128	64	32	16	8	4	2	1
bit7	bit6	bit5	bit4	bit3	bit2	bit1	bit0
			FND		AC	MN	ACDC

Description

Sets the power factor data (instantaneous value, maximum value, minimum value) output items as numerical values between 0 and 23.

For example, specify 1 to output the AC+DC rectification or 2 to output the AC+DC Umn rectification measurement value.

You can also output all rectification methods together at once. For example, you can specify 3 to output both the AC+DC rectification and AC+DC Umn rectification measurement values at the same time.

Although NRf numerical values are accepted, values to the right of the decimal are dropped.

If no items are specified directly via a :MEASure? query, the measurement values are output based on the specification of this command.

Example Command

:MEAS:ITEM:PF:CH1 1

Specifies to output the instantaneous value of the AC/DC rectified power factor.

Query

:MEAS:ITEM:PF:CH1?

Response

(When HEADER ON) :MEASURE:NORMAL:ITEM:PF:CH1 1

(When HEADER OFF) 1

Set and Query :MEASure? Output Items (Instantaneous, Maximum, and Minimum Values for Phase Angle Data)

Syntax	Instantaneous value	:MEASure[:NORMal]:ITEM:DEG:ALL <Output item> :MEASure[:NORMal]:ITEM:DEG:CH1(?) <Output item>
	Maximum value	:MEASure[:NORMal]:ITEM:DEG_MAX:ALL <Output item> :MEASure[:NORMal]:ITEM:DEG_MAX:CH1(?) <Output item>
	Minimum value	:MEASure[:NORMal]:ITEM:DEG_MIN:ALL <Output item> :MEASure[:NORMal]:ITEM:DEG_MIN:CH1(?) <Output item>
	Response	<Output item (NR1)>

	128	64	32	16	8	4	2	1
	bit7	bit6	bit5	bit4	bit3	bit2	bit1	bit0
				FND		AC	MN	ACDC

Description

Sets the phase angle data (instantaneous value, maximum value, minimum value) output items as numerical values between 0 and 20.

For example, specify 4 to output the AC rectification or 16 to output the FND rectification measurement value.

You can also output all rectification methods together at once. For example, you can specify 20 to output both the AC rectification and FND rectification measurement values at the same time.

Although NRf numerical values are accepted, values to the right of the decimal are dropped.

If no items are specified directly via a :MEASure? query, the measurement values are output based on the specification of this command.

Example

Command	:MEAS:ITEM:DEG:CH1 4
Query	:MEAS:ITEM:DEG:CH1?
Response	(When HEADER ON) :MEASURE:NORMAL:ITEM:DEG:CH1 4 (When HEADER OFF) 4

Set and Query :MEASure? Output Items (Instantaneous, Maximum, and Minimum Values for Voltage Frequency Data)

Syntax	Instantaneous value	:MEASure[:NORMal]:ITEM:FREQU:ALL <Output item> :MEASure[:NORMal]:ITEM:FREQU:CH1(?) <Output item>
	Maximum value	:MEASure[:NORMal]:ITEM:FREQU_MAX:ALL <Output item> :MEASure[:NORMal]:ITEM:FREQU_MAX:CH1(?) <Output item>
	Minimum value	:MEASure[:NORMal]:ITEM:FREQU_MIN:ALL <Output item> :MEASure[:NORMal]:ITEM:FREQU_MIN:CH1(?) <Output item>
	Response	<Output item (NR1)>

	128	64	32	16	8	4	2	1
	bit7	bit6	bit5	bit4	bit3	bit2	bit1	bit0
								FREQU

Description

Sets the voltage frequency data (instantaneous value, maximum value, minimum value) output items as numerical values between 0 and 1.

Although NRf numerical values are accepted, values to the right of the decimal are dropped.

If no items are specified directly via a :MEASure? query, the measurement values are output based on the specification of this command.

Example

Command	:MEAS:ITEM:FREQU:CH1 1
Query	:MEAS:ITEM:FREQU:CH1?
Response	(When HEADER ON) :MEASURE:NORMAL:ITEM:FREQU:CH1 1 (When HEADER OFF) 1

Set and Query :MEASure? Output Items (Instantaneous, Maximum, and Minimum Values for Current Frequency Data)

Syntax	Instantaneous value	:MEASure[:NORMal]:ITEM:FREQI:ALL <Output item> :MEASure[:NORMal]:ITEM:FREQI:CH1(?) <Output item>
	Maximum value	:MEASure[:NORMal]:ITEM:FREQI_MAX:ALL <Output item> :MEASure[:NORMal]:ITEM:FREQI_MAX:CH1(?) <Output item>
	Minimum value	:MEASure[:NORMal]:ITEM:FREQI_MIN:ALL <Output item> :MEASure[:NORMal]:ITEM:FREQI_MIN:CH1(?) <Output item>
	Response	<Output item (NR1)> 128 64 32 16 8 4 2 1 bit7 bit6 bit5 bit4 bit3 bit2 bit1 bit0 FREQI
Description		Sets the current frequency data (instantaneous value, maximum value, minimum value) output items as numerical values between 0 and 1. Although NRf numerical values are accepted, values to the right of the decimal are dropped. If no items are specified directly via a :MEASure? query, the measurement values are output based on the specification of this command.
Example	Command	:MEAS:ITEM:FREQI:CH1 1
	Query	:MEAS:ITEM:FREQI:CH1?
	Response	(When HEADER ON) :MEASURE:NORMAL:ITEM:FREQI:CH1 1 (When HEADER OFF) 1

Set and Query:MEASure? Output Items (Integration Time)

Syntax	:MEASure[:NORMal]:ITEM:TIME(?) <Output item>	
	Data by current range during auto-range integration :MEASure[:NORMal]:ITEM:TIME:I200mA(?) < Output item > :MEASure[:NORMal]:ITEM:TIME:I500mA(?) < Output item > :MEASure[:NORMal]:ITEM:TIME:I1A(?) < Output item > :MEASure[:NORMal]:ITEM:TIME:I2A(?) < Output item > :MEASure[:NORMal]:ITEM:TIME:I5A(?) < Output item > :MEASure[:NORMal]:ITEM:TIME:I10A(?) < Output item > :MEASure[:NORMal]:ITEM:TIME:I20A(?) < Output item > :MEASure[:NORMal]:ITEM:TIME:BACKUp(?) < Output item >	
	Response <Output item (NR1)> 128 64 32 16 8 4 2 1 bit7 bit6 bit5 bit4 bit3 bit2 bit1 bit0 TIME	
Description	Sets the integration time data output to a numerical value between 0 and 1. Although NRf numerical values are accepted, values to the right of the decimal are dropped. If no items are specified directly via a :MEASure? query, the measurement values are output based on the specification of this command.	
Example	Command	:MEAS:ITEM:TIME 1
	Query	:MEAS:ITEM:TIME?
	Response	(When HEADER ON) :MEASURE:NORMAL:ITEM:TIME 1 (When HEADER OFF) 1

Set and Query:MEASure? Output Items (Current Integration [Total Sum])

Syntax :MEASure[:NORMal]:ITEM:IH:ALL <Output item>
 :MEASure[:NORMal]:ITEM:IH:CH1(?) <Output item>

Data by current range during auto-range integration

:MEASure[:NORMal]:ITEM:IH:CH1:I200mA(?) <Output item>
 :MEASure[:NORMal]:ITEM:IH:CH1:I500mA(?) <Output item>
 :MEASure[:NORMal]:ITEM:IH:CH1:I1 A(?) <Output item>
 :MEASure[:NORMal]:ITEM:IH:CH1:I2A(?) <Output item>
 :MEASure[:NORMal]:ITEM:IH:CH1:I5A(?) <Output item>
 :MEASure[:NORMal]:ITEM:IH:CH1:I10A(?) <Output item>
 :MEASure[:NORMal]:ITEM:IH:CH1:I20A(?) <Output item>
 :MEASure[:NORMal]:ITEM:IH:CH1:BACKup(?) <Output item>

Response <Output item (NR1)>

128	64	32	16	8	4	2	1
bit7	bit6	bit5	bit4	bit3	bit2	bit1	bit0
				DC		MN	ACDC

Description

Sets the current integration (total sum) data output items to a numerical value between 0 and 11.

For example, specify 1 to output the AC+DC rectification or 2 to output the AC+DC Umn rectification measurement value.

You can also output all rectification methods together at once. For example, you can specify 3 to output both the AC+DC rectification and AC+DC Umn rectification measurement values at the same time.

Although NRf numerical values are accepted, values to the right of the decimal are dropped.

If no items are specified directly via a :MEASure? query, the measurement values are output based on the specification of this command.

Example Command :MEAS:ITEM:IH:CH1 1

Specifies to output the instantaneous value of the AC/DC rectified current integration (total sum).

Query :MEAS:ITEM:IH:CH1?

Response (When HEADER ON) :MEASURE:NORMAL:ITEM:IH:CH1 1
 (When HEADER OFF) 1

Note • If auto-range integration is ON, the output of the MN and ACDC will be invalid data.

Set and Query:MEASure? Output Items (Positive Current Integration)

Syntax `:MEASure[:NORMal]:ITEM:PIH:ALL <Output item>`
`:MEASure[:NORMal]:ITEM:PIH:CH1(?) <Output item>`

Data by current range during auto-range integration

`:MEASure[:NORMal]:ITEM:PIH:CH1:I200mA(?) <Output item>`
`:MEASure[:NORMal]:ITEM:PIH:CH1:I500mA(?) <Output item>`
`:MEASure[:NORMal]:ITEM:PIH:CH1:I1A(?) <Output item>`
`:MEASure[:NORMal]:ITEM:PIH:CH1:I2A(?) <Output item>`
`:MEASure[:NORMal]:ITEM:PIH:CH1:I5A(?) <Output item>`
`:MEASure[:NORMal]:ITEM:PIH:CH1:I10A(?) <Output item>`
`:MEASure[:NORMal]:ITEM:PIH:CH1:I20A(?) <Output item>`
`:MEASure[:NORMal]:ITEM:PIH:CH1:BACKup(?) <Output item>`

Response `<Output item (NR1)>`

128	64	32	16	8	4	2	1
bit7	bit6	bit5	bit4	bit3	bit2	bit1	bit0
				DC			

Description

Sets the positive current integration data output items to a numerical value between 0 and 8.

For example, specify 8 to output the DC rectification measurement value.

Although NRf numerical values are accepted, values to the right of the decimal are dropped.

If no items are specified directly via a `:MEASure?` query, the measurement values are output based on the specification of this command.

Example Command

`:MEAS:ITEM:PIH:CH1 8`

Specifies to output the instantaneous value of the DC rectified positive current integration.

Query `:MEAS:ITEM:PIH:CH1?`

Response (When HEADER ON) `:MEASURE:NORMAL:ITEM:PIH:CH1 8`
(When HEADER OFF) `8`

Set and Query:MEASure? Output Items (Negative Current Integration)

Syntax `:MEASure[:NORMal]:ITEM:MIH:ALL <Output item>`
`:MEASure[:NORMal]:ITEM:MIH:CH1(?) <Output item>`

Data by current range during auto-range integration

`:MEASure[:NORMal]:ITEM:MIH:CH1:I200mA(?) <Output item>`

`:MEASure[:NORMal]:ITEM:MIH:CH1:I500mA(?)`

`<Output item>`

`:MEASure[:NORMal]:ITEM:MIH:CH1:I1A(?) <Output item>`

`:MEASure[:NORMal]:ITEM:MIH:CH1:I2A(?) <Output item>`

`:MEASure[:NORMal]:ITEM:MIH:CH1:I5A(?) <Output item>`

`:MEASure[:NORMal]:ITEM:MIH:CH1:I10A(?) <Output item>`

`:MEASure[:NORMal]:ITEM:MIH:CH1:I20A(?) <Output item>`

`:MEASure[:NORMal]:ITEM:MIH:CH1:BACKup(?) <Output item>`

Response `<Output item (NR1)>`

128	64	32	16	8	4	2	1
bit7	bit6	bit5	bit4	bit3	bit2	bit1	bit0
				DC			

Description

Sets the negative current integration data output items to a numerical value between 0 and 8.

For example, specify 8 to output the DC rectification measurement value.

Although NRf numerical values are accepted, values to the right of the decimal are dropped.

If no items are specified directly via a `:MEASure?` query, the measurement values are output based on the specification of this command.

Example Command

`:MEAS:ITEM:MIH:CH1 8`

Specifies to output the instantaneous value of the DC rectified negative current integration.

Query `:MEAS:ITEM:MIH:CH1?`

Response (When HEADER ON) `:MEASURE:NORMAL:ITEM:MIH:CH1 8`

(When HEADER OFF) `8`

Set and Query:MEASure? Output Items (Active Power Integration [Total Sum])

Syntax :MEASure[:NORMal]:ITEM:WP:ALL <Output item>
:MEASure[:NORMal]:ITEM:WP:CH1(?) <Output item>

Data by current range during auto-range integration

:MEASure[:NORMal]:ITEM:WP:CH1:I200mA(?) <Output item>
:MEASure[:NORMal]:ITEM:WP:CH1:I500mA(?) <Output item>
:MEASure[:NORMal]:ITEM:WP:CH1:I1A(?) <Output item>
:MEASure[:NORMal]:ITEM:WP:CH1:I2A(?) <Output item>
:MEASure[:NORMal]:ITEM:WP:CH1:I5A(?) <Output item>
:MEASure[:NORMal]:ITEM:WP:CH1:I10A(?) <Output item>
:MEASure[:NORMal]:ITEM:WP:CH1:I20A(?) <Output item>
:MEASure[:NORMal]:ITEM:WP:CH1:BACKup(?) <Output item>

Response <Output item (NR1)>

128	64	32	16	8	4	2	1
bit7	bit6	bit5	bit4	bit3	bit2	bit1	bit0
				DC		MN	ACDC

Description

Sets the active power integration (total sum) data output items to a numerical value between 0 and 11.

For example, specify 1 to output the AC+DC rectification or 2 to output the AC+DC Umn rectification measurement value.

You can also output all rectification methods together at once. For example, you can specify 3 to output both the AC+DC rectification and AC+DC Umn rectification measurement values at the same time.

Although NRf numerical values are accepted, values to the right of the decimal are dropped.

If no items are specified directly via a :MEASure? query, the measurement values are output based on the specification of this command.

Example Command

:MEAS:ITEM:WP:CH1 1

Specifies to output the instantaneous value of the AC/DC rectified active power integration (total sum).

Query :MEAS:ITEM:WP:CH1?

Response (When HEADER ON) :MEASURE:NORMAL:ITEM:WP:CH1 1
(When HEADER OFF) 1

Set and Query:MEASure? Output Items (Positive Active Power Integration)

Syntax :MEASure[:NORMal]:ITEM:PWP:ALL <Output item>
:MEASure[:NORMal]:ITEM:PWP:CH1(?) <Output item>

Data by current range during auto-range integration

:MEASure[:NORMal]:ITEM:PWP:CH1:I200mA(?) <Output item>
:MEASure[:NORMal]:ITEM:PWP:CH1:I500mA(?) <Output item>
:MEASure[:NORMal]:ITEM:PWP:CH1:I1A(?) <Output item>
:MEASure[:NORMal]:ITEM:PWP:CH1:I2A(?) <Output item>
:MEASure[:NORMal]:ITEM:PWP:CH1:I5A(?) <Output item>
:MEASure[:NORMal]:ITEM:PWP:CH1:I10A(?) <Output item>
:MEASure[:NORMal]:ITEM:PWP:CH1:I20A(?) <Output item>
:MEASure[:NORMal]:ITEM:PWP:CH1:BACKup(?) <Output item>

Response <Output item (NR1)>

128	64	32	16	8	4	2	1
bit7	bit6	bit5	bit4	bit3	bit2	bit1	bit0
				DC		MN	ACDC

Description

Sets the positive active power integration data output items to a numerical value between 0 and 11.

For example, specify 1 to output the AC+DC rectification or 2 to output the AC+DC Umn rectification measurement value.

You can also output all rectification methods together at once. For example, you can specify 3 to output both the AC+DC rectification and AC+DC Umn rectification measurement values at the same time.

Although NRf numerical values are accepted, values to the right of the decimal are dropped.

If no items are specified directly via a :MEASure? query, the measurement values are output based on the specification of this command.

Example Command

:MEAS:ITEM:PWP:CH1 1

Specifies to output the instantaneous value of the AC/DC rectified positive active power integration.

Query :MEAS:ITEM:PWP:CH1?

Response (When HEADER ON) :MEASURE:NORMAL:ITEM:PWP:CH1 1
(When HEADER OFF) 1

Set and Query:MEASure? Output Items (Negative Active Power Integration)

Syntax :MEASure[:NORMal]:ITEM:MWP:ALL <Output item>
:MEASure[:NORMal]:ITEM:MWP:CH1(?) <Output item>

Data by current range during auto-range integration

:MEASure[:NORMal]:ITEM:MWP:CH1:I200mA(?) <Output item>
:MEASure[:NORMal]:ITEM:MWP:CH1:I500mA(?) <Output item>
:MEASure[:NORMal]:ITEM:MWP:CH1:I1A(?) <Output item>
:MEASure[:NORMal]:ITEM:MWP:CH1:I2A(?) <Output item>
:MEASure[:NORMal]:ITEM:MWP:CH1:I5A(?) <Output item>
:MEASure[:NORMal]:ITEM:MWP:CH1:I10A(?) <Output item>
:MEASure[:NORMal]:ITEM:MWP:CH1:I20A(?) <Output item>
:MEASure[:NORMal]:ITEM:MWP:CH1:BACKup(?) <Output item>

Response <Output item (NR1)>

128	64	32	16	8	4	2	1
bit7	bit6	bit5	bit4	bit3	bit2	bit1	bit0
				DC		MN	ACDC

Description

Sets the negative active power integration data output items to a numerical value between 0 and 11.

For example, specify 1 to output the AC+DC rectification or 2 to output the AC+DC Umn rectification measurement value.

You can also output all rectification methods together at once. For example, you can specify 3 to output both the AC+DC rectification and AC+DC Umn rectification measurement values at the same time.

Although NRf numerical values are accepted, values to the right of the decimal are dropped.

If no items are specified directly via a :MEASure? query, the measurement values are output based on the specification of this command.

Example Command

:MEAS:ITEM:MWP:CH1 1

Specifies to output the instantaneous value of the AC/DC rectified negative active power integration.

Query :MEAS:ITEM:MWP:CH1?

Response (When HEADER ON) :MEASURE:NORMAL:ITEM:MWP:CH1 1
(When HEADER OFF) 1

Set and Query :MEASure? Output Items (Instantaneous, Maximum, and Minimum Values for the Voltage Waveform Peak)

Syntax	Instantaneous value	:MEASure[:NORMal]:ITEM:UPK:ALL <Output item>						
	Maximum value	:MEASure[:NORMal]:ITEM:UPK:CH1(?) <Output item>						
	Minimum value	:MEASure[:NORMal]:ITEM:UPK_MAX:ALL <Output item>						
		:MEASure[:NORMal]:ITEM:UPK_MAX:CH1(?) <Output item>						
	Minimum value	:MEASure[:NORMal]:ITEM:UPK_MIN:ALL <Output item>						
		:MEASure[:NORMal]:ITEM:UPK_MIN:CH1(?) <Output item>						
Response	<Output item (NR1)>							
	128	64	32	16	8	4	2	1
	bit7	bit6	bit5	bit4	bit3	bit2	bit1	bit0
								UPK
Description	Sets the voltage waveform peak value data (instantaneous value, maximum value, minimum value) output items as numerical values between 0 and 1. Although NRf numerical values are accepted, values to the right of the decimal are dropped. If no items are specified directly via a :MEASure? query, the measurement values are output based on the specification of this command.							
Example	Command	:MEAS:ITEM:UPK:CH1 1						
		Specifies to output the instantaneous value of the AC/DC rectified voltage waveform peak value.						
	Query	:MEAS:ITEM:UPK:CH1?						
	Response	(When HEADER ON)	:MEASURE:NORMAL:ITEM:UPK:CH1 1					
		(When HEADER OFF)	1					

Set and Query :MEASure? Output Items (Instantaneous, Maximum, and Minimum Values for the Current Waveform Peak)

Syntax	Instantaneous value	:MEASure[:NORMal]:ITEM:IPK:ALL <Output item>						
	Maximum value	:MEASure[:NORMal]:ITEM:IPK:CH1(?) <Output item>						
	Minimum value	:MEASure[:NORMal]:ITEM:IPK_MAX:ALL <Output item>						
		:MEASure[:NORMal]:ITEM:IPK_MAX:CH1(?) <Output item>						
	Minimum value	:MEASure[:NORMal]:ITEM:IPK_MIN:ALL <Output item>						
		:MEASure[:NORMal]:ITEM:IPK_MIN:CH1(?) <Output item>						
Response	<Output item (NR1)>							
	128	64	32	16	8	4	2	1
	bit7	bit6	bit5	bit4	bit3	bit2	bit1	bit0
								IPK
Description	Sets the current waveform peak value data (instantaneous value, maximum value, minimum value) output items as numerical values between 0 and 1. Although NRf numerical values are accepted, values to the right of the decimal are dropped. If no items are specified directly via a :MEASure? query, the measurement values are output based on the specification of this command.							
Example	Command	:MEAS:ITEM:IPK:CH1 1						
		Specifies to output the instantaneous value of the AC/DC rectified current waveform peak value.						
	Query	:MEAS:ITEM:IPK:CH1?						
	Response	(When HEADER ON)	:MEASURE:NORMAL:ITEM:IPK:CH1 1					
		(When HEADER OFF)	1					

Set and Query :MEASure? Output Items (Instantaneous, Maximum, and Minimum Values for Maximum Current Ratio Data)

Syntax	Instantaneous value	:MEASure[:NORMal]:ITEM:MCR:ALL <Output item>																								
		:MEASure[:NORMal]:ITEM:MCR:CH1(?) <Output item>																								
	Maximum value	:MEASure[:NORMal]:ITEM:MCR_MAX:ALL <Output item>																								
		:MEASure[:NORMal]:ITEM:MCR_MAX:CH1(?) <Output item>																								
	Minimum Value	:MEASure[:NORMal]:ITEM:MCR_MIN:ALL <Output item>																								
		:MEASure[:NORMal]:ITEM:MCR_MIN:CH1(?) <Output item>																								
	Response	<Output item (NR1)>																								
		<table border="1" style="margin-left: 40px;"> <thead> <tr> <th>128</th> <th>64</th> <th>32</th> <th>16</th> <th>8</th> <th>4</th> <th>2</th> <th>1</th> </tr> </thead> <tbody> <tr> <td>bit7</td> <td>bit6</td> <td>bit5</td> <td>bit4</td> <td>bit3</td> <td>bit2</td> <td>bit1</td> <td>bit0</td> </tr> <tr> <td></td> <td></td> <td></td> <td></td> <td></td> <td></td> <td></td> <td>MCR</td> </tr> </tbody> </table>	128	64	32	16	8	4	2	1	bit7	bit6	bit5	bit4	bit3	bit2	bit1	bit0								MCR
128	64	32	16	8	4	2	1																			
bit7	bit6	bit5	bit4	bit3	bit2	bit1	bit0																			
							MCR																			
Description		<p>Sets the Maximum Current Ratio data (instantaneous value, maximum value, minimum value) output items as numerical values between 0 and 1. Although NRf numerical values are accepted, values to the right of the decimal are dropped.</p> <p>If no items are specified directly via a :MEASure? query, the measurement values are output based on the specification of this command.</p>																								
Example	Command	:MEAS:ITEM:MCR:CH1 1																								
	Query	:MEAS:ITEM:MCR:CH1?																								
	Response	(When HEADER ON) :MEASURE:NORMAL:ITEM:MCR:CH1 1 (When HEADER OFF) 1																								

Set and Query :MEASure? Output Items (Instantaneous, Maximum, and Minimum Values for Voltage Crest Factor Data)

Syntax	Instantaneous value	:MEASure[:NORMal]:ITEM:UCFactor:ALL <Output item>																								
		:MEASure[:NORMal]:ITEM:UCFactor:CH1(?) <Output item>																								
	Maximum value	:MEASure[:NORMal]:ITEM:UCF_MAX:ALL <Output item>																								
		:MEASure[:NORMal]:ITEM:UCF_MAX:CH1(?) <Output item>																								
	Minimum value	:MEASure[:NORMal]:ITEM:UCF_MIN:ALL <Output item>																								
		:MEASure[:NORMal]:ITEM:UCF_MIN:CH1(?) <Output item>																								
	Response	<Output item (NR1)>																								
		<table border="1" style="margin-left: 40px;"> <thead> <tr> <th>128</th> <th>64</th> <th>32</th> <th>16</th> <th>8</th> <th>4</th> <th>2</th> <th>1</th> </tr> </thead> <tbody> <tr> <td>bit7</td> <td>bit6</td> <td>bit5</td> <td>bit4</td> <td>bit3</td> <td>bit2</td> <td>bit1</td> <td>bit0</td> </tr> <tr> <td></td> <td></td> <td></td> <td></td> <td></td> <td></td> <td></td> <td>UCF</td> </tr> </tbody> </table>	128	64	32	16	8	4	2	1	bit7	bit6	bit5	bit4	bit3	bit2	bit1	bit0								UCF
128	64	32	16	8	4	2	1																			
bit7	bit6	bit5	bit4	bit3	bit2	bit1	bit0																			
							UCF																			
Description		<p>Sets the voltage crest factor data (instantaneous value, maximum value, minimum value) output items as numerical values between 0 and 1. Although NRf numerical values are accepted, values to the right of the decimal are dropped.</p> <p>If no items are specified directly via a :MEASure? query, the measurement values are output based on the specification of this command.</p>																								
Example	Command	:MEAS:ITEM:UCF:CH1 1																								
	Query	:MEAS:ITEM:UCF:CH1?																								
	Response	(When HEADER ON) :MEASURE:NORMAL:ITEM:UCFACTOR:CH1 1 (When HEADER OFF) 1																								

Set and Query :MEASure? Output Items (Instantaneous, Maximum, and Minimum Values for Current Crest Factor Data)

Syntax Instantaneous value: **:MEASure[:NORMal]:ITEM:ICFactor:ALL** <Output item>
 Maximum value: **:MEASure[:NORMal]:ITEM:ICFactor:CH1(?)** <Output item>
 Minimum value: **:MEASure[:NORMal]:ITEM:ICF_MAX:ALL** <Output item>
 Minimum value: **:MEASure[:NORMal]:ITEM:ICF_MAX:CH1(?)** <Output item>
 Minimum value: **:MEASure[:NORMal]:ITEM:ICF_MIN:ALL** <Output item>
 Minimum value: **:MEASure[:NORMal]:ITEM:ICF_MIN:CH1(?)** <Output item>

Response <Output item (NR1)>

128	64	32	16	8	4	2	1
bit7	bit6	bit5	bit4	bit3	bit2	bit1	bit0
							ICF

Description

Sets the current crest factor data (instantaneous value, maximum value, minimum value) output items as numerical values between 0 and 1.

Although NRf numerical values are accepted, values to the right of the decimal are dropped.

If no items are specified directly via a :MEASure? query, the measurement values are output based on the specification of this command.

Example

Command

:MEAS:ITEM:ICF:CH1 1

Specifies to output the instantaneous value of the current crest factor.

Query

:MEAS:ITEM:ICF:CH1?

Response

(When HEADER ON) **:MEASURE:NORMAL:ITEM:ICFACTOR:CH1 1**

(When HEADER OFF) **1**

Set and Query:MEASure? Output Items (Time Average Current)

Syntax :MEASure[:NORMal]:ITEM:ITAVerage:ALL <Output item>
:MEASure[:NORMal]:ITEM:ITAVerage:CH1(?) <Output item>

Data by current range during auto-range integration

:MEASure[:NORMal]:ITEM:ITAVerage:CH1:I200mA(?) <Output item>
:MEASure[:NORMal]:ITEM:ITAVerage:CH1:I500mA(?) <Output item>
:MEASure[:NORMal]:ITEM:ITAVerage:CH1:I1A(?) <Output item>
:MEASure[:NORMal]:ITEM:ITAVerage:CH1:I2A(?) <Output item>
:MEASure[:NORMal]:ITEM:ITAVerage:CH1:I5A(?) <Output item>
:MEASure[:NORMal]:ITEM:ITAVerage:CH1:I10A(?) <Output item>
:MEASure[:NORMal]:ITEM:ITAVerage:CH1:I20A(?) <Output item>
:MEASure[:NORMal]:ITEM:ITAVerage:CH1:BACKup(?) <Output item>

Response <Output item (NR1)>

128	64	32	16	8	4	2	1
bit7	bit6	bit5	bit4	bit3	bit2	bit1	bit0
				DC		MN	ACDC

Description

Sets the time average current data output items to a numerical value between 0 and 11.

For example, specify 1 to output the AC+DC rectification or 2 to output the AC+DC Umn rectification measurement value.

You can also output all rectification methods together at once. For example, you can specify 3 to output both the AC+DC rectification and AC+DC Umn rectification measurement values at the same time.

Although NRf numerical values are accepted, values to the right of the decimal are dropped.

If no items are specified directly via a :MEASure? query, the measurement values are output based on the specification of this command.

Example

Command :MEAS:ITEM:ITAV:CH1 1
Specifies to output the AC/DC rectified time average current data.

Query :MEAS:ITEM:ITAV:CH1?

Response (When HEADER ON) :MEASURE:NORMAL:ITEM:ITAVERAGE:CH1 1
(When HEADER OFF) 1

Note • If auto-range integration is ON, the output of the MN and ACDC will be invalid data.

Set and Query:MEASure? Output Items (Time Average Active Power)

Syntax :MEASure[:NORMal]:ITEM:PTAVerage:ALL <Output item>
:MEASure[:NORMal]:ITEM:PTAVerage:CH1(?) <Output item>

Data by current range during auto-range integration

:MEASure[:NORMal]:ITEM:PTAVerage:CH1:I200mA(?) <Output item>
:MEASure[:NORMal]:ITEM:PTAVerage:CH1:I500mA(?) <Output item>
:MEASure[:NORMal]:ITEM:PTAVerage:CH1:I1A(?) <Output item>
:MEASure[:NORMal]:ITEM:PTAVerage:CH1:I2A(?) <Output item>
:MEASure[:NORMal]:ITEM:PTAVerage:CH1:I5A(?) <Output item>
:MEASure[:NORMal]:ITEM:PTAVerage:CH1:I10A(?) <Output item>
:MEASure[:NORMal]:ITEM:PTAVerage:CH1:I20A(?) <Output item>
:MEASure[:NORMal]:ITEM:PTAVerage:CH1:BACKup(?) <Output item>

Response <Output item (NR1)>

128	64	32	16	8	4	2	1
bit7	bit6	bit5	bit4	bit3	bit2	bit1	bit0
				DC		MN	ACDC

Description

Sets the time average active power data output items to a numerical value between 0 and 11.

For example, specify 1 to output the AC+DC rectification or 2 to output the AC+DC Umn rectification measurement value.

You can also output all rectification methods together at once. For example, you can specify 3 to output both the AC+DC rectification and AC+DC Umn rectification measurement values at the same time.

Although NRf numerical values are accepted, values to the right of the decimal are dropped.

If no items are specified directly via a :MEASure? query, the measurement values are output based on the specification of this command.

Example Command

:MEAS:ITEM:PTAV:CH1 1

Specifies to output the AC/DC rectified time average active power data.

Query

:MEAS:ITEM:PTAV:CH1?

Response

(When HEADER ON) :MEASURE:NORMAL:ITEM:PTAVERAGE:CH1 1
(When HEADER OFF) 1

Set and Query :MEASure? Output Items (Instantaneous, Maximum, and Minimum Values for the Voltage Ripple Factor)

Syntax Instantaneous value :MEASure[:NORMal]:ITEM:URF:ALL <Output item>
:MEASure[:NORMal]:ITEM:URF:CH1(?) <Output item>
Maximum value :MEASure[:NORMal]:ITEM:URF_MAX:ALL <Output item>
:MEASure[:NORMal]:ITEM:URF_MAX:CH1(?) <Output item>
Minimum value :MEASure[:NORMal]:ITEM:URF_MIN:ALL <Output item>
:MEASure[:NORMal]:ITEM:URF_MIN:CH1(?) <Output item>

Response <Output item (NR1)>

128	64	32	16	8	4	2	1
bit7	bit6	bit5	bit4	bit3	bit2	bit1	bit0
							URF

Description

Sets the voltage ripple factor data (instantaneous value, maximum value, minimum value) output items as numerical values between 0 and 1.

Although NRf numerical values are accepted, values to the right of the decimal are dropped.

If no items are specified directly via a :MEASure? query, the measurement values are output based on the specification of this command.

Example Command

:MEAS:ITEM:URF:CH1 1

Specifies to output the instantaneous value of the voltage ripple factor.

Query

:MEAS:ITEM:URF:CH1?

Response

(When HEADER ON) :MEASURE:NORMAL:ITEM:URF:CH1 1
(When HEADER OFF) 1

Set and Query :MEASure? Output Items (Instantaneous, Maximum, and Minimum Values for the Current Ripple Factor)

Syntax	Instantaneous value	:MEASure[:NORMal]:ITEM:IRF:ALL <Output item>
	Maximum value	:MEASure[:NORMal]:ITEM:IRF:CH1(?) <Output item>
	Minimum value	:MEASure[:NORMal]:ITEM:IRF_MAX:ALL <Output item>
		:MEASure[:NORMal]:ITEM:IRF_MAX:CH1(?) <Output item>
	Minimum value	:MEASure[:NORMal]:ITEM:IRF_MIN:ALL <Output item>
		:MEASure[:NORMal]:ITEM:IRF_MIN:CH1(?) <Output item>
Response		<Output item (NR1)>

128	64	32	16	8	4	2	1
bit7	bit6	bit5	bit4	bit3	bit2	bit1	bit0
							IRF

Description

Sets the current ripple factor data (instantaneous value, maximum value, minimum value) output items as numerical values between 0 and 1. Although NRf numerical values are accepted, values to the right of the decimal are dropped.

If no items are specified directly via a :MEASure? query, the measurement values are output based on the specification of this command.

Example

Command	:MEAS:ITEM:IRF:CH1 1
Query	:MEAS:ITEM:IRF:CH1?
Response	(When HEADER ON) :MEASURE:NORMAL:ITEM:IRF:CH1 1 (When HEADER OFF) 1

Set and Query :MEASure? Output Items (Instantaneous, Maximum, and Minimum Values for Total Harmonic Wave Voltage Distortion Factor Data)

Syntax	Instantaneous value	:MEASure[:NORMal]:ITEM:UTHD:ALL <Output item>
	Maximum value	:MEASure[:NORMal]:ITEM:UTHD:CH1(?) <Output item>
	Minimum value	:MEASure[:NORMal]:ITEM:UTHD_MAX:ALL <Output item>
		:MEASure[:NORMal]:ITEM:UTHD_MAX:CH1(?) <Output item>
	Minimum value	:MEASure[:NORMal]:ITEM:UTHD_MIN:ALL <Output item>
		:MEASure[:NORMal]:ITEM:UTHD_MIN:CH1(?) <Output item>
Response		<Output item (NR1)>

128	64	32	16	8	4	2	1
bit7	bit6	bit5	bit4	bit3	bit2	bit1	bit0
							UTHD

Description

Sets the total harmonic wave voltage distortion factor data (instantaneous value, maximum value, minimum value) output items as numerical values between 0 and 1.

Although NRf numerical values are accepted, values to the right of the decimal are dropped.

If no items are specified directly via a :MEASure? query, the measurement values are output based on the specification of this command.

Example

Command	:MEAS:ITEM:UTHD:CH1 1
Query	:MEAS:ITEM:UTHD:CH1?
Response	(When HEADER ON) :MEASURE:NORMAL:ITEM:UTHD:CH1 1 (When HEADER OFF) 1

Set and Query :MEASure? Output Items (Instantaneous, Maximum, and Minimum Values for Total Harmonic Wave Current Distortion Factor Data)

Syntax	Instantaneous value	:MEASure[:NORMal]:ITEM:ITHD:ALL <Output item> :MEASure[:NORMal]:ITEM:ITHD:CH1(?) <Output item>
	Maximum value	:MEASure[:NORMal]:ITEM:ITHD_MAX:ALL <Output item> :MEASure[:NORMal]:ITEM:ITHD_MAX:CH1(?) <Output item>
	Minimum value	:MEASure[:NORMal]:ITEM:ITHD_MIN:ALL <Output item> :MEASure[:NORMal]:ITEM:ITHD_MIN:CH1(?) <Output item>
	Response	<Output item (NR1)>

128	64	32	16	8	4	2	1
bit7	bit6	bit5	bit4	bit3	bit2	bit1	bit0
							ITHD

Description

Sets the total harmonic wave current distortion factor data (instantaneous value, maximum value, minimum value) output items as numerical values between 0 and 1. Although NRf numerical values are accepted, values to the right of the decimal are dropped.

If no items are specified directly via a :MEASure? query, the measurement values are output based on the specification of this command.

Example	Command	:MEAS:ITEM:ITHD:CH1 1 Specifies to output the instantaneous value of the total harmonic wave current distortion factor.
	Query	:MEAS:ITEM:ITHD:CH1?
	Response	(When HEADER ON) :MEASURE:NORMAL:ITEM:ITHD:CH1 1 (When HEADER OFF) 1

Query Harmonic Wave Measurement Data (Normal Measurement Items)

Syntax Query **:MEASure:HARMonic[:VALue]?**
 Response <Output item 1><Measurement value 1>,<Output item 2><Measurement value 2>.... (Maximum of 180 items)
 See the [List of Harmonic Wave Measurement Item Specifications](#) for details about the <Output item> field.

Description Query Outputs the items specified via :MEASure:HARMonic:ITEM commands. Unlike the :MEASure? query, only the items specified via :MEASure:HARMonic:ITEM commands are output. The measurement data is output in the order that the items are listed in the [List of Harmonic Wave Output Item Specifications](#).

Example Query **:MEAS:HARM?**
 Response (When HEADER ON) **Status 00000000,**
HU1L001 +09.803E+0;HI1L001 +12.933E+0;
HP1L001 -085.72E+0
 (When HEADER OFF) **00000000;+09.803E+0;+12.933E+0;-085.72E+0**

- Note**
- You can use the :TRANsmit:SEParator command to change the message unit separator from a semicolon ";" to a comma ",".
 - If the display is blank (such as when the range has been changed), the response message will be "no data" ($\pm 777.77E+9$) until the measurement data is displayed. We recommend only using this function with a fixed range.
 - If :MEASure:HARMonic? is called immediately after the instrument is powered on, the first-order effective values of HU, HI, and HP are output.
 - The output items specified via :MEASure:HARMonic:ITEM commands will not be reset even if a system reset is performed. These items are reset only when the instrument is powered on.
 - Up to 180 items will be output for each :MEASure:HARMonic[:VALue]? query. If output was specified with a :MEASure:HARMonic? command, up to 180 items will be output in the order indicated in the Output Items and Their Sequence. Since more than 180 items cannot be output, exercise care to adjust with :MEASure:HARMonic:ITEM so that the number of output items is 180 or less.
 - If the harmonic upper limit order (:HARMonic:ORDer:UPPer) is set to a value of less than 50, data for orders above the limit will be 0. (The instrument will display "----.")

:MEASure:HARMonic? Output Items and their Sequence

Harmonic Wave Measurement Items		
Status	Instantaneous value	Status
	Total	Status_MaxMin
Effective Value (Level)	Voltage 0-order	HU1L000
	Voltage 0-order (maximum value)	HU1MAXL000
	Voltage 0-order (minimum value)	HU1MINL000
	Current 0-order	HI1L000
	Current 0-order (maximum value)	HI1MAXL000
	Current 0-order (minimum value)	HI1LMIN000
	Power 0-order	HP1L000
	Power 0-order (maximum value)	HP1MAXL000
	Power 0-order (minimum value)	HP1MINL000
Content Ratio	Voltage 0-order	HU1D000
	Voltage 0-order (maximum value)	HU1MAXD000
	Voltage 0-order (minimum value)	HU1MIND000
	Current 0-order	HI1D000
	Current 0-order (maximum value)	HI1MAXD000
	Current 0-order (minimum value)	HI1MIND000
	Power 0-order	HP1D000
	Power 0-order (maximum value)	HP1MAXD000
	Power 0-order (minimum value)	HP1MIND000
Voltage Phase Difference	Voltage 0-order	HU1P000
	Voltage 0-order (maximum value)	HU1MAXP000
	Voltage 0-order (minimum value)	HU1MINP000
Current Phase Difference	Current 0-order	HI1P000
	Current 0-order (maximum value)	HI1MAXP000
	Current 0-order (minimum value)	HI1MINP000
Voltage Current Phase Difference	Power 0-order	HP1P000
	Power 0-order (maximum value)	HP1MAXP000
	Power 0-order (minimum value)	HP1MINP000
...	n-order	Last three digits: n
...
Effective Value (Level)	Voltage 50-order	HU1L050
	Voltage 50-order (maximum value)	HU1MAXL050
	Voltage 50-order (minimum value)	HU1MINL050
	Current 50-order	HI1L050
	Current 50-order (maximum value)	HI1MAXL050
	Current 50-order (minimum value)	HI1LMIN050
	Power 50-order	HP1L050
	Power 50-order (maximum value)	HP1MAXL050
	Power 50-order (minimum value)	HP1MINL050
Content Ratio	Voltage 50-order	HU1D050
	Voltage 50-order (maximum value)	HU1MAXD050
	Voltage 50-order (minimum value)	HU1MIND050
	Current 50-order	HI1D050
	Current 50-order (maximum value)	HI1MAXD050
	Current 50-order (minimum value)	HI1MIND050
	Power 50-order	HP1D050
	Power 50-order (maximum value)	HP1MAXD050
	Power 50-order (minimum value)	HP1MIND050

Voltage Phase Difference	Voltage 50-order	HU1P050
	Voltage 50-order (maximum value)	HU1MAXP050
	Voltage 50-order (minimum value)	HU1MINP050
Current Phase Difference	Current 50-order	HI1P050
	Current 50-order (maximum value)	HI1MAXP050
	Current 50-order (minimum value)	HI1MINP050
Voltage Current Phase Difference	Power 50-order	HP1P050
	Power 50-order (maximum value)	HP1MAXP050
	Power 50-order (minimum value)	HP1MINP050

Perform and Query a Reset of :MEASure:HARMonic? Output Items

Syntax	Command	:MEASure:HARMonic:ITEM:ALLClear
Description		Clears all outputs set for :MEASure:HARMonic? via :MEASure:HARMonic:ITEM commands.
Example	Command	:MEAS:HARM:ITEM:ALLC
Note		<ul style="list-style-type: none"> • This command turns all output settings OFF. • The output settings immediately after the instrument is powered on are as follows: harmonic wave First order effective values HU, HI, and HP.

Set and Query:MEASure:HARmonic? Output Items

Syntax	Command	:MEASure:HARmonic:ITEM :LIST							
		<data1 (NR1)>,<data2 (NR1)>,<data3 (NR1)>,<data4 (NR1)>,<data5 (NR1)>,<data6 (NR1)>							
	Query	:MEASure:HARmonic:ITEM:LIST?							
	Response	<data1>,<data2>,<data3>,<data4>,<data5>,<data6>							
		128	64	32	16	8	4	2	1
		<data1 (NR1)> Effective Value HU,HI							
		bit7	bit6	bit5	bit4	bit3	bit2	bit1	bit0
					HI				HU
		<data2 (NR1)> Effective Value HP							
		bit7	bit6	bit5	bit4	bit3	bit2	bit1	bit0
									HP
		<data3 (NR1)> Content Ratio HUCON,HICON							
		bit7	bit6	bit5	bit4	bit3	bit2	bit1	bit0
					HICON				HUCON
		<data4 (NR1)> Content Ratio P							
		bit7	bit6	bit5	bit4	bit3	bit2	bit1	bit0
									HPCON
		<data5 (NR1)> Phase Angle HUPHase,HIPHase							
		bit7	bit6	bit5	bit4	bit3	bit2	bit1	bit0
					HIPHA				HUPHA
		<data6 (NR1)> Phase Difference HPPHase							
		bit7	bit6	bit5	bit4	bit3	bit2	bit1	bit0
									HPPHA

Description Sets or queries the measurement items for the **:MEASure:HARmonic?** query as a numerical value between 0 and 17.

Although NRf numerical values are accepted, values to the right of the decimal are dropped.

Example Command **:MEAS:HARM:ITEM:LIST 17,1,0,0,0,0**
(This enables the output of the harmonic wave voltage, current, and active power effective values.)

Query **:MEAS:HARM:ITEM:LIST?**

Response (When HEADER ON) **:MEASURE:HARMONIC:ITEM:LIST 17,1,0,0,0,0**
(When HEADER OFF) **17,1,0,0,0,0**

- Note**
- This command is used along with the **:MEASure:HARmonic:ITEM:ORDER** command to specify the harmonic wave output order.
 - If you need to output the maximum and minimum values in addition to the instantaneous value for an output item, use the provided commands such as **:MEASure:HARmonic:ITEM:HU_MAX** to specify that.
 - Harmonic wave phase angle data cannot be displayed on the instrument. This data can only be obtained through communications commands.

Set and Query:MEASure:HARMonic? Output Items (Order)

Syntax Command **:MEASure:HARMonic:ITEM:ORDer**
 <Lower Limit Order (NR1)>,<Upper Limit Order (NR1)>,<ODD/EVEN/ALL>

Query **:MEASure:HARMonic:ITEM:ORDer?**

Response <Lower Limit Order (NR1)>, <Upper Limit Order (NR1)>,<ODD/EVEN/ALL>
 Lower limit order (NR1): 0 to 50
 Upper limit order (NR1): 0 to 50
 (the lower limit must be less than or equal to the upper limit)

ODD: Odd orders only
 EVEN: Even orders only
 ALL: All orders

Description

Sets or queries the measurement items(Order) for the :MEASure:HARMonic? query. The numerical value is accepted in NRf format, but any data after the decimal point is truncated.

Example

Command **:MEAS:HARM:ITEM:ORD 1,15,ODD**
 Sets the output to an odd order between 1 and 15.

Query **:MEAS:HARM:ITEM:ORD?**

Response (When HEADER ON) **:MEASURE:HARMONIC:ORDER 1,15,ODD**
 (When HEADER OFF) **1,15,ODD**

Note • This command is used along with the :MEASure:HARMonic:ITEM:LIST or :MEASure:HARMonic:ITEM:xxx commands to specify the harmonic wave output items.

Set and Query :MEASure:HARMonic? Output Items (Measurement status data: instantaneous value, maximum value, minimum value)

Syntax Instantaneous value **:MEASure:HARMonic:ITEM:STATus:INST(?)** <Output item>

Maximum/Minimum value **:MEASure:HARMonic:ITEM:STATus:MAXmin(?)** <Output item>

Response <Output item (NR1)>

128	64	32	16	8	4	2	1
bit7	bit6	bit5	bit4	bit3	bit2	bit1	bit0
							STATUS

Description

Sets the measurement data status (instantaneous value, maximum value, minimum value) output items as numerical values between 0 and 1.

Although NRf numerical values are accepted, values to the right of the decimal are dropped.

INST indicates the status for the instantaneous value at the time when the data is acquired.

MAXmin indicates the total from the time the maximum and minimum values were last reset.

For information about Status data, refer to :MEASure:ITEM:STATUS (page 77) for details.

Example

Command **:MEAS:HARM:ITEM:STAT:INST 1**
 Specifies to turn ON measurement status output.

Query **:MEAS:HARM:ITEM:STAT:INST?**

Response (When HEADER ON) **:MEASURE:HARMONIC:ITEM:STAT:INST 1**
 (When HEADER OFF) **1**

Set and Query :MEASure:HARMonic? Output Items (Instantaneous, Maximum, and Minimum Values for the Harmonic Wave Voltage Effective Value)

Syntax	Instantaneous value	:MEASure:HARMonic:ITEM:U:ALL <Output item>
	value	:MEASure:HARMonic:ITEM:U:CH1(?) <Output item>
	Maximum value	:MEASure:HARMonic:ITEM:U_MAX:ALL <Output item>
	value	:MEASure:HARMonic:ITEM:U_MAX:CH1(?) <Output item>
	Minimum value	:MEASure:HARMonic:ITEM:U_MIN:ALL <Output item>
	value	:MEASure:HARMonic:ITEM:U_MIN:CH1(?) <Output item>
	Response	<Output item (NR1)>

128	64	32	16	8	4	2	1
bit7	bit6	bit5	bit4	bit3	bit2	bit1	bit0
							HU

Description

Sets the harmonic wave voltage effective value data output items returned by :MEASure:HARMonic? (instantaneous value, maximum value, minimum value) as numerical values between 0 and 1.

The order output is the order specified via MEASure:HARMonic:ITEM:ORDER.

Although NRf numerical values are accepted, values to the right of the decimal are dropped.

Example

Command	:MEAS:HARM:ITEM:U:CH1 1
	Specifies to output the instantaneous value of the harmonic wave voltage effective value.
Query	:MEAS:HARM:ITEM:U:CH1?
Response	(When HEADER ON) :MEASURE:HARMONIC:ITEM:U:CH1 1
	(When HEADER OFF) 1

Note

- This command is used along with the :MEASure:HARMonic:ITEM:ORDER command to specify the harmonic wave output order.
- If the specification is the same as that for the :MEASure:HARMonic:ITEM:LIST command, the command issued afterwards takes precedence.

Set and Query :MEASure:HARMonic? Output Items (Instantaneous, Maximum, and Minimum Values for the Harmonic Wave Current Effective Value)

Syntax	Instantaneous value	:MEASure:HARMonic:ITEM:I:ALL <Output item>
	value	:MEASure:HARMonic:ITEM:I:CH1(?) <Output item>
	Maximum value	:MEASure:HARMonic:ITEM:I_MAX:ALL <Output item>
	value	:MEASure:HARMonic:ITEM:I_MAX:CH1(?) <Output item>
	Minimum value	:MEASure:HARMonic:ITEM:I_MIN:ALL <Output item>
	value	:MEASure:HARMonic:ITEM:I_MIN:CH1(?) <Output item>
	Response	<Output item (NR1)>

128	64	32	16	8	4	2	1
bit7	bit6	bit5	bit4	bit3	bit2	bit1	bit0
							HI

Description

Sets the harmonic wave current effective value data output items returned by :MEASure:HARMonic? (instantaneous value, maximum value, minimum value) as numerical values between 0 and 1.

The order output is the order specified via MEASure:HARMonic:ITEM:ORDER.

Although NRf numerical values are accepted, values to the right of the decimal are dropped.

Example

Command	:MEAS:HARM:ITEM:I:CH1 1
	Specifies to output the instantaneous value of the harmonic wave current effective value.
Query	:MEAS:HARM:ITEM:I:CH1?
Response	(When HEADER ON) :MEASURE:HARMONIC:ITEM:I:CH1 1
	(When HEADER OFF) 1

Note

- This command is used along with the :MEASure:HARMonic:ITEM:ORDER command to specify the harmonic wave output order.
- If the specification is the same as that for the :MEASure:HARMonic:ITEM:LIST command, the command issued afterwards takes precedence.

Set and Query :MEASure:HARMonic? Output Items (Instantaneous, Maximum, and Minimum Values for the Harmonic Wave Active Power Effective Value)

Syntax Instantaneous value: **:MEASure:HARMonic:ITEM:P:ALL** <Output item>
Maximum value: **:MEASure:HARMonic:ITEM:P:CH1(?)** <Output item>
Minimum value: **:MEASure:HARMonic:ITEM:P_MAX:ALL** <Output item>
:MEASure:HARMonic:ITEM:P_MAX:CH1(?) <Output item>
Response: **:MEASure:HARMonic:ITEM:P_MIN:ALL** <Output item>
:MEASure:HARMonic:ITEM:P_MIN:CH1(?) <Output item>

<Output item (NR1)>

128	64	32	16	8	4	2	1
bit7	bit6	bit5	bit4	bit3	bit2	bit1	bit0
							HP

Description

Sets the harmonic wave active power effective value data output items returned by :MEASure:HARMonic? (instantaneous value, maximum value, minimum value) as numerical values between 0 and 1.

The order output is the order specified via MEASure:HARMonic:ITEM:ORDER.

Although NRf numerical values are accepted, values to the right of the decimal are dropped.

Example Command: **:MEAS:HARM:ITEM:P:CH1 1**

Specifies to output the instantaneous value of the harmonic wave active power effective value.

Query: **:MEAS:HARM:ITEM:P:CH1?**

Response (When HEADER ON): **:MEASURE:HARMONIC:ITEM:P:CH1 1**

(When HEADER OFF) **1**

- Note**
- This command is used along with the :MEASure:HARMonic:ITEM:ORDER command to specify the harmonic wave output order.
 - If the specification is the same as that for the :MEASure:HARMonic:ITEM:LIST command, the command issued afterwards takes precedence.

Set and Query :MEASure:HARMonic? Output Items (Instantaneous, Maximum, and Minimum Values for the Harmonic Wave Voltage Content Ratio)

Syntax Instantaneous value: **:MEASure:HARMonic:ITEM:UCON:ALL** <Output item>
Maximum value: **:MEASure:HARMonic:ITEM:UCON:CH1(?)** <Output item>
Minimum value: **:MEASure:HARMonic:ITEM:UCON_MAX:ALL** <Output item>
:MEASure:HARMonic:ITEM:UCON_MAX:CH1(?) <Output item>
Response: **:MEASure:HARMonic:ITEM:UCON_MIN:ALL** <Output item>
:MEASure:HARMonic:ITEM:UCON_MIN:CH1(?) <Output item>

<Output item (NR1)>

128	64	32	16	8	4	2	1
bit7	bit6	bit5	bit4	bit3	bit2	bit1	bit0
							HUCON

Description

Sets the harmonic wave voltage content ratio data output items returned by :MEASure:HARMonic? (instantaneous value, maximum value, minimum value) as numerical values between 0 and 1.

The order output is the order specified via MEASure:HARMonic:ITEM:ORDER.

Although NRf numerical values are accepted, values to the right of the decimal are dropped.

Example Command: **:MEAS:HARM:ITEM:UCON:CH1 1**

Specifies to output the instantaneous value of the harmonic wave voltage content ratio.

Query: **:MEAS:HARM:ITEM:UCON:CH1?**

Response (When HEADER ON): **:MEASURE:HARMONIC:ITEM:UCON:CH1 1**

ON)

(When HEADER OFF) **1**

OFF)

- Note**
- This command is used along with the :MEASure:HARMonic:ITEM:ORDER command to specify the harmonic wave output order.
 - If the specification is the same as that for the :MEASure:HARMonic:ITEM:LIST command, the command issued afterwards takes precedence.

Set and Query :MEASure:HARMonic? Output Items (Instantaneous, Maximum, and Minimum Values for the Harmonic Wave Current Content Ratio)

Syntax	Instantaneous value	:MEASure:HARMonic:ITEM:ICON:ALL <Output item> :MEASure:HARMonic:ITEM:ICON:CH1(?) <Output item>
	Maximum value	:MEASure:HARMonic:ITEM:ICON_MAX:ALL <Output item> :MEASure:HARMonic:ITEM:ICON_MAX:CH1(?) <Output item>
	Minimum value	:MEASure:HARMonic:ITEM:ICON_MIN:ALL <Output item> :MEASure:HARMonic:ITEM:ICON_MIN:CH1(?) <Output item>
	Response	<Output item (NR1)>

128	64	32	16	8	4	2	1
bit7	bit6	bit5	bit4	bit3	bit2	bit1	bit0
							HICON

Description Sets the harmonic wave current content ratio data output items returned by :MEASure:HARMonic? (instantaneous value, maximum value, minimum value) as numerical values between 0 and 1.
The order output is the order specified via MEASure:HARMonic:ITEM:ORDER.
Although NRf numerical values are accepted, values to the right of the decimal are dropped.

Example Command :MEAS:HARM:ITEM:ICON:CH1 1
Specifies to output the instantaneous value of the harmonic wave current content ratio .

Query :MEAS:HARM:ITEM:ICON:CH1?

Response (When HEADER ON) :MEASURE:HARMONIC:ITEM:ICON:CH1 1
(When HEADER OFF) 1

Note

- This command is used along with the :MEASure:HARMonic:ITEM:ORDER command to specify the harmonic wave output order.
- If the specification is the same as that for the :MEASure:HARMonic:ITEM:LIST command, the command issued afterwards takes precedence.

Set and Query :MEASure:HARMonic? Output Items (Instantaneous, Maximum, and Minimum Values for the Harmonic Wave Active Power Content Ratio)

Syntax	Instantaneous value	:MEASure:HARMonic:ITEM:PCON:ALL <Output item> :MEASure:HARMonic:ITEM:PCON:CH1(?) <Output item>
	Maximum value	:MEASure:HARMonic:ITEM:PCON_MAX:ALL <Output item> :MEASure:HARMonic:ITEM:PCON_MAX:CH1(?) <Output item>
	Minimum value	:MEASure:HARMonic:ITEM:PCON_MIN:ALL <Output item> :MEASure:HARMonic:ITEM:PCON_MIN:CH1(?) <Output item>
	Response	<Output item (NR1)>

128	64	32	16	8	4	2	1
bit7	bit6	bit5	bit4	bit3	bit2	bit1	bit0
							HPCON

Description Sets the harmonic wave active power content ratio data output items returned by :MEASure:HARMonic? (instantaneous value, maximum value, minimum value) as numerical values between 0 and 1.
The order output is the order specified via MEASure:HARMonic:ITEM:ORDER.
Although NRf numerical values are accepted, values to the right of the decimal are dropped.

Example Command :MEAS:HARM:ITEM:PCON:CH1 1
Specifies to output the instantaneous value of the harmonic wave active power content ratio.

Query :MEAS:HARM:ITEM:PCON:CH1?

Response (When HEADER ON) :MEASURE:HARMONIC:ITEM:PCON:CH1 1
(When HEADER OFF) 1

Note

- This command is used along with the :MEASure:HARMonic:ITEM:ORDER command to specify the harmonic wave output order.
- If the specification is the same as that for the :MEASure:HARMonic:ITEM:LIST command, the command issued afterwards takes precedence.

Set and Query :MEASure:HARMonic? Output Items (Instantaneous, Maximum, and Minimum Values for the Harmonic Wave Voltage Phase Angle)

Syntax	Instantaneous value	:MEASure:HARMonic:ITEM:UPHase:ALL <Output item>
	Maximum value	:MEASure:HARMonic:ITEM:UPHase:CH1(?) <Output item>
	Minimum value	:MEASure:HARMonic:ITEM:UPHase_MAX:ALL <Output item>
		:MEASure:HARMonic:ITEM:UPHase_MAX:CH1(?) <Output item>
	Response	:MEASure:HARMonic:ITEM:UPHase_MIN:ALL <Output item>
		:MEASure:HARMonic:ITEM:UPHase_MIN:CH1(?) <Output item>

<Output item (NR1)>							
128	64	32	16	8	4	2	1
bit7	bit6	bit5	bit4	bit3	bit2	bit1	bit0
							HUPHase

Description Sets the harmonic wave voltage phase angle data output items returned by :MEASure:HARMonic? (instantaneous value, maximum value, minimum value) as numerical values between 0 and 1. The order output is the order specified via MEASure:HARMonic:ITEM:ORDER. Although NRf numerical values are accepted, values to the right of the decimal are dropped.

Example Command :MEAS:HARM:ITEM:UPHA:CH1 1
Specifies to output the instantaneous value of the harmonic wave voltage phase angle.

Query :MEAS:HARM:ITEM:UPHA:CH1?
Response (When HEADER ON) :MEASURE:HARMONIC:ITEM:UPHA:CH1 1
(When HEADER OFF) 1

Note

- This command is used along with the :MEASure:HARMonic:ITEM:ORDER command to specify the harmonic wave output order.
- If the specification is the same as that for the :MEASure:HARMonic:ITEM:LIST command, the command issued afterwards takes precedence.
- Harmonic wave phase angle data cannot be displayed on the instrument. This data can only be obtained through communications commands.

Set and Query :MEASure:HARMonic? Output Items (Instantaneous, Maximum, and Minimum Values for the Harmonic Wave Current Phase Angle)

Syntax	Instantaneous value	:MEASure:HARMonic:ITEM:IPHase:ALL <Output item>
	Maximum value	:MEASure:HARMonic:ITEM:IPHase:CH1(?) <Output item>
	Minimum value	:MEASure:HARMonic:ITEM:IPHase_MAX:ALL <Output item>
		:MEASure:HARMonic:ITEM:IPHase_MAX:CH1(?) <Output item>
	Response	:MEASure:HARMonic:ITEM:IPHase_MIN:ALL <Output item>
		:MEASure:HARMonic:ITEM:IPHase_MIN:CH1(?) <Output item>

<Output item (NR1)>							
128	64	32	16	8	4	2	1
bit7	bit6	bit5	bit4	bit3	bit2	bit1	bit0
							HIPHase

Description Sets the harmonic wave current phase angle data output items returned by :MEASure:HARMonic? (instantaneous value, maximum value, minimum value) as numerical values between 0 and 1. The order output is the order specified via MEASure:HARMonic:ITEM:ORDER. Although NRf numerical values are accepted, values to the right of the decimal are dropped.

Example Command :MEAS:HARM:ITEM:IPHA:CH1 1
Specifies to output the instantaneous value of the harmonic wave current phase angle.

Query :MEAS:HARM:ITEM:IPHA:CH1?
Response (When HEADER ON) :MEASURE:HARMONIC:ITEM:IPHASE:CH1 1
(When HEADER OFF) 1

Note

- This command is used along with the :MEASure:HARMonic:ITEM:ORDER command to specify the harmonic wave output order.
- If the specification is the same as that for the :MEASure:HARMonic:ITEM:LIST command, the command issued afterwards takes precedence.
- Harmonic wave phase angle data cannot be displayed on the instrument. This data can only be obtained through communications commands.

Set and Query :MEASure:HARMonic? Output Items (Instantaneous, Maximum, and Minimum Values for the Harmonic Voltage Current Phase difference)

Syntax	Instantaneous value	:MEASure:HARMonic:ITEM:PPHase:ALL <Output item>
	Maximum value	:MEASure:HARMonic:ITEM:PPHase:CH1(?) <Output item>
	Minimum value	:MEASure:HARMonic:ITEM:PPHase_MAX:ALL <Output item>
		:MEASure:HARMonic:ITEM:PPHase_MAX:CH1(?) <Output item>
		:MEASure:HARMonic:ITEM:PPHase_MIN:ALL <Output item>
		:MEASure:HARMonic:ITEM:PPHase_MIN:CH1(?) <Output item>

Response <Output item (NR1)>

128	64	32	16	8	4	2	1
bit7	bit6	bit5	bit4	bit3	bit2	bit1	bit0
							HPCON

Description

Sets the harmonic wave active power phase angle data output items returned by :MEASure:HARMonic? (instantaneous value, maximum value, minimum value) as numerical values between 0 and 1.

The order output is the order specified via MEASure:HARMonic:ITEM:ORDer.

Although NRf numerical values are accepted, values to the right of the decimal are dropped.

Example Command :MEAS:HARM:ITEM:PPHA:CH1 1

Specifies to output the instantaneous value of the harmonic wave active power phase angle.

Query :MEAS:HARM:ITEM:PPHA:CH1?

Response (When HEADER ON) :MEASURE:HARMONIC:ITEM:PPHASE:CH1 1
(When HEADER OFF) 1

Note

- This command is used along with the :MEASure:HARMonic:ITEM:ORDer command to specify the harmonic wave output order.
- If the specification is the same as that for the :MEASure:HARMonic:ITEM:LIST command, the command issued afterwards takes precedence.
- Harmonic voltage current phase difference data cannot be displayed on the instrument. This data can only be obtained through communications commands.

(11) Communications Settings

Set and Query RS-232C Settings

Syntax	Query	:RS232c?
	Response	BAUD <9600BPS/38400BPS>;ANSWER <ON/OFF> BAUD <9600BPS/38400BPS>: RS232C baud rate ANSWER<ON/OFF>: Turns execution confirmation message output ON or OFF. Returns the RS232-C baud rate and execution confirmation message settings as string values.
Description		
Example	Query	:RS232C?
	Response	(When HEADER ON) :RS232C:BAUD 9600BPS;ANSWER OFF (When HEADER OFF) 9600BPS; OFF
Note		<ul style="list-style-type: none"> • This command can be executed even when a system error has occurred. • You can use the :TRANsmit:SEParator command to change the message unit separator from a semicolon ";" to a comma ",". • This query can be used with the RS, LAN, and GP-IB interfaces.

Set and Query the RS-232C Baud Rate Setting

Syntax	Command	:RS232c:BAUD <9600BPS/38400BPS>
	Query	:RS232c:BAUD?
	Response	<9600BPS/38400BPS>
Description		Sets or queries the instrument's RS-232C baud rate setting.
Example	Command	:RS232:BAUD 9600BPS
	Query	:RS232:BAUD?
	Response	(When HEADER ON) :RS232C:BAUD 9600BPS (When HEADER OFF) 9600BPS
Note		<p>This query can be used with the RS, LAN, and GP-IB interfaces.</p> <p>This setting command can only be used with the LAN and GP-IB interfaces.</p>

Set and Query the RS-232C Execution Confirmation Message Setting

Syntax Command :RS232c:ANSWer <ON/OFF>
 Query :RS232c:ANSWer?
 Response <ON/OFF>

Description

Sets or queries the RS-232C execution confirmation message output setting (ON or OFF).
 When set to ON, a response is also received when sending a command. In addition, an execution confirmation message is included after the response to a query.
 The execution confirmation message is a 3-digit numerical value ("nnn"). "000" is returned when an operation is executed successfully. If an error occurs, the number of the nnnth command where the error occurred will be returned instead of "000".

Example (when HEADER OFF):

Command	Response	Comments
:RS232C:ANSWER ON	000	Operation completed successfully.
:ABCD	001	"ABCD" is an error.
:VOLT:RANGE?;CUR R:RANGE?	15;0.1;000	Operation completed successfully.
:VOLT:RANGE?;CUR R:RANGE? ; ABC	15;0.1;003	An error occurred with the third command, "ABC".

Example Command :RS232:ANSW ON
 Query :RS232:ANSW?
 Response (When HEADER ON) :RS232C:ANSWER ON;000
 (When HEADER OFF) ON;000

- Note**
- This command and query can be executed even when a system error has occurred.
 - When set to ON, operation may become unstable if the controller (the device that sends commands) does not receive an execution confirmation message response.
 - Please have received execution confirmation message also when sending blank line.
 - This command is used to synchronize operation with the controller over RS-232C, but can also be used with the GP-IB and LAN interfaces.
 - However, be sure to always receive sent execution confirmation messages. This query and setting command can be used with the RS, LAN, and GP-IB interfaces.

Query RS-232C Communications Errors

Syntax Query :RS232c:ERRor?
 Response <Communications error information (NR1)>

128	64	32	16	8	4	2	1
bit7	bit6	bit5	bit4	bit3	bit2	bit1	bit0
					Over run	Framing	

Description

Returns RS-232C communications error information in NR1 format and clears that information.
 The communications error information can also be reset to 0 via the *CLS command.
 The response message has no header.
 bit 2: Overrun error (missed data)
 bit 1: Framing error (erroneous data read)

Example Query :RS232:ERR?
 Response 4

- Note**
- This command can be executed even when a system error has occurred.
 - This query can be used with the RS, LAN, and GP-IB interfaces.

Set and Query the LAN IP Address Execution Confirmation Message Setting

Syntax	Command	:IP:ADDRess <Address 1 (NR1)>,<Address 2 (NR1)>,<Address 3 (NR1)>,<Address 4 (NR1)>
	Query	:IP:ADDRess?
	Response	<Address 1 (NR1)>,<Address 2 (NR1)>,<Address 3 (NR1)>,<Address 4 (NR1)> <Address 1 to Address 4 (NR1)> = 0 to 255
Description Example		Sets or queries the IP address of the instrument.
	Command	:IP:ADDR 192,168,1,1
	Query	:IP:ADDR?
	Response	(When HEADER ON) :IP:ADDRESS 192,168,1,1 (When HEADER OFF) 192,168,1,1
Note	<ul style="list-style-type: none"> • The LAN communications settings will be changed after the command is sent. All established connections before the settings were changed will be disconnected. • This query can be used with the RS-232C, LAN, and GP-IB interfaces. • This setting command can be used with the RS-232C and GP-IB interfaces. 	

Set and Query the LAN Default Gateway Address Execution Confirmation Message Setting

Syntax	Command	:IP:DEFaultgateway <Address 1 (NR1)>,<Address 2 (NR1)>,<Address 3 (NR1)>,<Address 4 (NR1)>
	Query	:IP:DEFaultgateway?
	Response	<Address 1 (NR1)>,<Address 2 (NR1)>,<Address 3 (NR1)>,<Address 4 (NR1)> <Address 1 to Address 4 (NR1)> = 0 to 255
Description Example		Sets or queries the default gateway address for the instrument.
	Command	:IP:DEF 192,168,1,250
	Query	:IP:DEF?
	Response	(When HEADER ON) :IP:DEFAULTGATEWAY 192,168,1,250 (When HEADER OFF) 192,168,1,250
Note	<ul style="list-style-type: none"> • The LAN communications settings will be changed after the command is sent. All established connections before the settings were changed will be disconnected. • This query can be used with the RS-232C, LAN, and GP-IB interfaces. • This setting command can be used with the RS-232C and GP-IB interfaces. 	

Set and Query the LAN Subnet Mask Execution Confirmation Message Setting

Syntax	Command	:IP:SUBNetmask <Address 1 (NR1)>,<Address 2 (NR1)>,<Address 3 (NR1)>,<Address 4 (NR1)>
	Query	:IP:SUBNetmask?
	Response	<Address 1 (NR1)>,<Address 2 (NR1)>,<Address 3 (NR1)>,<Address 4 (NR1)> <Address 1 to Address 4 (NR1)> = 0 to 255
Description Example		Sets or queries the subnet mask for the instrument.
	Command	:IP:SUBN 255,255,255,0
	Query	:IP:SUBN?
	Response	(When HEADER ON) :IP:SUBNETMASK 255,255,255,0 (When HEADER OFF) 255,255,255,0
Note	<ul style="list-style-type: none"> • The LAN communications settings will be changed after the command is sent. All established connections before the settings were changed will be disconnected. • This query can be used with the RS-232C, LAN, and GP-IB interfaces. • This setting command can be used with the RS-232C and GP-IB interfaces. 	

Query GP-IB Settings

Syntax	Query	:GPIB?
	Response	<GP-IB address (NR1)> <GP-IB address (NR1)> = 0 to 30
Description		Returns the GP-IB address setting as a string.
Example	Query	:GPIB?
	Response	(When HEADER ON) :GPIB:ADDRESS 5 (When HEADER OFF) 5
Note	<ul style="list-style-type: none"> • This query can be used with the RS-232C, LAN, and GP-IB interfaces. • If GP-IB is not implemented by the unit, a device error will occur. 	

Set and Query the GP-IB Address

Syntax	Command	:GPIB:ADDRess <GPiB address (NR1)>
	Query	:GPIB:ADDRess?
	Response	<GP-IB address (NR1)> <GP-IB address (NR1)> = 0 to 30
Description		Sets or queries the GP-IB address of the instrument.
Example	Command	:GPIB:ADDR 5
	Query	:GPIB:ADDR?
	Response	(When HEADER ON) :GPIB:ADDRESS 5 (When HEADER OFF) 5
Note	<ul style="list-style-type: none"> • This query can be used with the RS-232C, LAN, and GP-IB interfaces. • This setting command can only be used with the RS-232C and LAN interfaces. • If GP-IB is not implemented by the unit, a device error will occur. 	

Set and Query Response Message Headers ON/OFF Status

Syntax	Command	:HEADer <ON/OFF>
	Query	:HEADer?
	Response	<ON/OFF> ON: A header is added to the response message. OFF: No header is added to the response message.
Description		Sets or queries the ON/OFF status of query response message headers.
Example	Command	:HEAD ON
	Query	:HEAD?
	Response	(When HEADER ON) :HEADER ON (When HEADER OFF) OFF
Note	<ul style="list-style-type: none"> • This command and query can be executed even when a system error has occurred. • This command can not be executed during a zero adjust. 	

Change to the Local State

Syntax	Command	:LOCAL
Description		Changes the instrument from the Remote state to the Local state. If the instrument is already in the Local state when this command is received, it will remain in that state.
Example	Command	:LOCAL
Note	<ul style="list-style-type: none"> • This command and query can be executed even when a system error has occurred. 	

Set and Query the Message Unit Separator

Syntax Command :TRANsmit:SEParator <0/1>
 Query :TRANsmit:SEParator?
 Response <0/1>

Description

0: Semicolon ";" (default setting)
 1: Comma ","

Sets or queries the message unit separator used in response messages. Although NRf numerical values are accepted, values to the right of the decimal are truncated.

However, if headers are turned ON the actual output will be separated by semicolons, even if the separator has been set to comma.

Example

Command	:TRAN:SEP 0;;HEAD OFF;;MEAS? U1,I1	(Specify the separator to be a semicolon.)
Response	10.038E+0;+12.719E+0	(Separator is a semicolon.)
Command	:TRAN:SEP 1;;HEAD OFF;;MEAS? U1,I1	(Specify the separator to be a comma.)
Response	10.038E+0,+12.719E+0	(Separator is a comma.)
Command	:TRAN:SEP 0;;HEAD ON;;MEAS? U1,I1	(Specify the separator to be a semicolon.)
Response	U1 10.038E+0;I1 +12.719E+0	(Separator is a semicolon.)
Command	:TRAN:SEP 1;;HEAD ON;;MEAS? U1,I1	(Specify the separator to be a comma.)
Response	U1 10.038E+0,I1 +12.719E+0	(Separator is a semicolon.) (Because headers are turned ON.)

Query :TRAN:SEP?
 Response (When HEADER ON) :TRANSMIT:SEPARATOR 1
 (When HEADER OFF) 1

- Note**
- Always turn headers OFF (:HEAD OFF) when changing the message unit separator.
 - This command and query can be executed even when a system error has occurred.

Set and Query the Message Unit Terminator

Syntax Command :TRANsmit:TERMinator <0/1>
 Query :TRANsmit:TERMinator?
 Response <0/1>

Setting		RS-232c	GP-IB
		LAN	
I/F	0	LF	LF with an EOI
	1	CR+LF	LF with a CR+EOI

Description

Sets or queries the message unit terminator used in response messages. Although NRf numerical values are accepted, values to the right of the decimal are truncated.

Example

Command :TRAN:TERM 1
 Query :TRAN:TERM?
 Response (When HEADER ON) :TRANSMIT:TERMINATOR 1
 (When HEADER OFF) 1

- Note**
- This command and query can be executed even when a system error has occurred.

(12) Status-dependent Commands (Common Commands)

○: Can be executed ×: Cannot be executed

Command	Status	Integration Reset		Integration START		Integration STOP		System Error
		Continu ous	HOLD	Continu ous	HOLD	Continu ous	HOLD	
*CLS		○	○	○	○	○	○	○
*ESE		○	○	○	○	○	○	○
*ESE?		○	○	○	○	○	○	○
*ESR?		○	○	○	○	○	○	○
*IDN?		○	○	○	○	○	○	○
*OPC		○	○	○	○	○	○	○
*OPC?		○	○	○	○	○	○	○
*OPT?		○	○	○	○	○	○	○
*RST		○	○	○	○	○	○	○
*SRE		○	○	○	○	○	○	○
*SRE?		○	○	○	○	○	○	○
*STB?		○	○	○	○	○	○	○
*TRG		×	○	×	○	×	○	×
*TST?		○	×	×	×	×	×	○
*WAI		○	○	○	○	○	○	×

Status Descriptions

- Integration Reset : Integration calculations are stopped and the integration time and integration value are reset.
(The INTEGRATOR RUN indicator is OFF.)
- Integration START : Integration calculations are being performed (the INTEGRATOR RUN indicator is ON).
- Integration STOP : Integration calculations are stopped (the INTEGRATOR RUN indicator is flashing).
- Continuous : The display is updated each time sampling is performed (continuous display).
- HOLD : The display is currently held and/or maximum/minimum values are being held.
(The HOLD, MAX, or MIN indicator is ON.)
However, *TRG is only valid when the HOLD indicator is ON.
- System Error : Err. 1 to Err. 4 is currently displayed.

(13) Status-dependent Commands (Device-specific Commands)

○: Can be executed ×: Cannot be executed

△: While the display is held, cannot be executed.

When the maximum/minimum values are being held, can be executed.

Command	Status	Integration Reset		Integration START		Integration STOP		System Error
		Continu ous	HOLD	Continu ous	HOLD	Continu ous	HOLD	
AOUT?		○	○	○	○	○	○	○
AOUT								
:ITEM								
:DA[n]		○	○	○	○	○	○	×
:DA[n]?		○	○	○	○	○	○	○
:IRANge								
:DA[n]		○	○	○	○	○	○	×
:DA[n]?		○	○	○	○	○	○	○
AVERaging		○	×	×	×	×	×	×
AVERaging?		○	○	○	○	○	○	○
CURRent?		○	○	○	○	○	○	○
CURRent								
:AUTO		○	△	×	×	○	△	×
:AUTO?		○	○	○	○	○	○	○
:RANGe		○	△	×	×	○	△	×
:RANGe?		○	○	○	○	○	○	○
:EXTRange		○	△	×	×	○	△	×
:EXTRange?		○	○	○	○	○	○	○
:TYPe		○	×	×	×	×	×	×
:TYPe?		○	○	○	○	○	○	○
:SElect		○	×	×	×	×	×	×
:SElect?		○	○	○	○	○	○	○
:ALL		○	×	×	×	×	×	×
:[xxx]A		○	×	×	×	×	×	×
:[xxx]A?		○	○	○	○	○	○	○
:C[xxx]A		○	×	×	×	×	×	×
:C[xxx]A?		○	○	○	○	○	○	○
DATAout:ITEM		○	○	○	○	○	○	○
DATAout:ITEM?		○	○	○	○	○	○	○
DEMAg		○	×	×	×	○	×	×
DEMAg?		○	○	○	○	○	○	○
DISPlay?		○	○	○	○	○	○	○
DISPlay								
:HARMonic								
:[B,C,D]:ITEM		○	○	○	○	○	○	×
:[B,C,D]:ITEM?		○	○	○	○	○	○	○
:ORDer		○	○	○	○	○	○	×
:ORDer?		○	○	○	○	○	○	○

Command	Status	Integration Reset		Integration START		Integration STOP		System Error
		Continu ous	HOLD	Continu ous	HOLD	Continu ous	HOLD	
:HORDerSel								
: <u>[A,B,C,D]</u>								
: <u>ITEM</u>		○	○	○	○	○	○	×
: <u>ITEM?</u>		○	○	○	○	○	○	○
: <u>ORDer</u>		○	○	○	○	○	○	×
: <u>ORDer?</u>		○	○	○	○	○	○	○
: <u>MODE</u>		○	○	○	○	○	○	×
: <u>MODE?</u>		○	○	○	○	○	○	○
: <u>NORMal</u>		○	○	○	○	○	○	×
: <u>[A,B,C,D]</u>		○	○	○	○	○	○	×
: <u>[A,B,C,D]?</u>		○	○	○	○	○	○	○
ESE0		○	○	○	○	○	○	×
ESE0?		○	○	○	○	○	○	○
ESR0?		○	○	○	○	○	○	○
ESE1		○	○	○	○	○	○	×
ESE1?		○	○	○	○	○	○	○
ESR1?		○	○	○	○	○	○	○
FREQuency?		○	○	○	○	○	○	○
FREQuency								
: <u>RANGe</u>		○	×	×	×	×	×	×
: <u>RANGe?</u>		○	○	○	○	○	○	○
GPIB?		○	○	○	○	○	○	○
GPIB								
: <u>ADDRess</u>		○	○	○	○	○	○	×
: <u>ADDRess?</u>		○	○	○	○	○	○	○
HARMonic:ORDer:UPPER		○	×	×	×	×	×	×
HARMonic:ORDer:UPPER?		○	○	○	○	○	○	○
HEADer		○	○	○	○	○	○	○
HEADer?		○	○	○	○	○	○	○
HOLD		○	○	○	○	○	○	×
HOLD?		○	○	○	○	○	○	○
INTEGrate?		○	○	○	○	○	○	○
INTEGrate								
: <u>STATe</u> (*)								
START		○	○	×	×	○	○	×
STOP		×	×	○	○	×	×	×
RESET		○	○	×	×	○	○	×
: <u>STATe?</u>		○	○	○	○	○	○	○
: <u>TIME</u>		○	×	×	×	×	×	×
: <u>TIME?</u>		○	○	○	○	○	○	○
: <u>AUTO</u>		○	×	×	×	×	×	×
: <u>AUTO?</u>		○	○	○	○	○	○	○

Command \ Status	Integration Reset		Integration START		Integration STOP		System Error
	Continu ous	HOLD	Continu ous	HOLD	Continu ous	HOLD	
(*See also: Detailed Command Specifications)							
IP							
:ADDRESS	○	○	○	○	○	○	×
:ADDRESS?	○	○	○	○	○	○	○
:DEFAULTgateway	○	○	○	○	○	○	×
:DEFAULTgateway?	○	○	○	○	○	○	○
:SUBNetmask	○	○	○	○	○	○	×
:SUBNetmask?	○	○	○	○	○	○	○
LOCAL	○	○	○	○	○	○	○
MEASure?	○	○	○	○	○	○	×
MEASure							
:ITEM:ALLClear	○	○	○	○	○	○	○
:NORMal							
:VALUE?	○	○	○	○	○	○	×
All :ITEM commands and queries	○	○	○	○	○	○	○
:HARMonic?	○	○	○	○	○	○	×
:HARMonic							
:ITEM							
:LIST	○	○	○	○	○	○	○
:LIST?	○	○	○	○	○	○	○
:ORDER	○	○	○	○	○	○	○
:ORDER?	○	○	○	○	○	○	○
All :[U,I,P] commands and queries	○	○	○	○	○	○	○
:[UCON,ICON,PCON]	○	○	○	○	○	○	○
:[UPHase,IPHase,PPHase]	○	○	○	○	○	○	○
:RS232c?	○	○	○	○	○	○	○
:RS232c	○	○	○	○	○	○	○
ANSWer	○	○	○	○	○	○	○
ANSWer?	○	○	○	○	○	○	○
BAUD	○	○	○	○	○	○	×
BAUD?	○	○	○	○	○	○	○
ERRor?	○	○	○	○	○	○	○
SCALE[n]?	○	○	○	○	○	○	○
SCALE[n]							
:CT	○	×	×	×	×	×	×
:CT?	○	○	○	○	○	○	○
:VT	○	×	×	×	×	×	×
:VT?	○	○	○	○	○	○	○
SOURce[n]?	○	○	○	○	○	○	○
SOURce[n]	○	×	×	×	×	×	×
:TIMEOut?	○	○	○	○	○	○	○



Command	Status	Integration Reset		Integration START		Integration STOP		System Error
		Continu ous	HOLD	Continu ous	HOLD	Continu ous	HOLD	
:TIMEOut		○	×	×	×	×	×	×
:FILTer								
:LEVel								
:ALL		○	×	×	×	×	×	×
:U[xxx]V		○	×	×	×	×	×	×
:U[xxx]V?		○	○	○	○	○	○	○
:I[xxx]A		○	×	×	×	×	×	×
:I[xxx]A?		○	○	○	○	○	○	○
:C[xxx]A		○	×	×	×	×	×	×
:C[xxx]A?		○	○	○	○	○	○	○
SYNC:CONTRol		○	×	×	×	×	×	×
SYNC:CONTRol?		○	○	○	○	○	○	○
TRANsmit								
:SEParator		○	○	○	○	○	○	○
:SEParator?		○	○	○	○	○	○	○
:TERMinator		○	○	○	○	○	○	○
:TERMinator?		○	○	○	○	○	○	○
VOLTage[n]?		○	○	○	○	○	○	○
VOLTage[n]								
:AUTO		○	Δ	×	×	×	×	×
:AUTO?		○	○	○	○	○	○	○
:RANGe		○	Δ	×	×	×	×	×
:RANGe?		○	○	○	○	○	○	○
:SElect		○	Δ	×	×	×	×	×
:SElect?		○	○	○	○	○	○	○
:ALL		○	×	×	×	×	×	×
:U[xxx]V		○	×	×	×	×	×	×
:U[xxx]V?		○	○	○	○	○	○	○
ZEROadjust		○	×	×	×	○	×	×
ZEROadjust?		○	○	○	○	○	○	○
MODE		○	○	○	○	○	○	○
MODE?		○	○	○	○	○	○	○
RECTifier		○	○	○	○	○	○	○
RECTifier?		○	○	○	○	○	○	○
RESPonse		○	○	○	○	○	○	○
RESPonse?		○	○	○	○	○	○	○
WIRing		○	○	○	○	○	○	○
WIRing?		○	○	○	○	○	○	○











Status Descriptions

Integration Reset	:	Integration calculations are stopped and the integration time and integration value are reset. (The INTEGRATOR RUN indicator is OFF.)
Integration START	:	Integration calculations are being performed (the INTEGRATOR RUN indicator is ON).
Integration STOP	:	Integration calculations are stopped (the INTEGRATOR RUN indicator is flashing).
Continuous	:	The display is updated each time sampling is performed (continuous display).
HOLD	:	The display is currently held and/or maximum/minimum values are being held. (The HOLD, MAX, or MIN indicator is ON.)
System Error	:	Err. 1 to Err. 4 is currently displayed.

4 Operation Problems (Communications)

When communications are not operating properly, check the following causes and try the listed solutions.

- * Problems and solutions with no specific interface icon (  ) can be applied for all interfaces.

Problem	Cause / Solution
The RS-232C/LAN/GP-IB interface does not work at all.	<ul style="list-style-type: none"> • Are all cables properly connected? (See Chapter 4 in the Instruction Manual for the instrument.) • Are all connected devices powered ON? • Are all the cables used the correct types? (See Chapter 4 in the Instruction Manual for the instrument.) • Do the set communications conditions (RS baud rate, etc.) on the instrument match up with the controller?  • Are the address settings on the instrument the same as the controller's destination address?  • Does the instrument have the same IP address setting as another device?  • Are the communications settings (IP address, subnet mask, default gateway) all correct?  • Are these IP address settings the same as those on another device?  • Is the TCP/IP port number correct?  (Connect to TCP/IP port 3300.)
Communications are not working properly.	<ul style="list-style-type: none"> • Are the instrument and controller RS-232C settings (baud rate, data length, parity, stop bit) the same?  • The data length (8 bits), parity (none), and stop bit (1) are fixed values. • Is the controller's message terminator (delimiter) setting the same as the instrument setting?
After communications, the keys on the instrument no longer work.	<ul style="list-style-type: none"> • Press the SHIFT/EXIT/LOCAL keys on the instrument panel to take the instrument out of the Remote state. Or, send the <code>:LOCAL</code> command. • Are you sending the LLO (Local Lock Out) command (see page 11) to the instrument? 
The program stops running when I try to read data with an INPUT statement. 	<ul style="list-style-type: none"> • You must send a query before the INPUT statement. • Did an error occur in the query sent before the INPUT statement?
The GP-IB bus stops when I try to read data with an INPUT@(ENTER) statement. 	<ul style="list-style-type: none"> • You must send a query before the INPUT@(ENTER) statement. • Did an error occur in the query sent before the INPUT statement?

I sent a command but nothing happens.	<ul style="list-style-type: none"> • Use the *ESR? query to check the Standard Event Status Register for items that have caused an error. (See page 35.) • Use the RS232c:ERRor? query to check for any RS-232C communications errors. (See page 107.) RS-232C • Set RS232c:ANSWer to ON to enable execution confirmation. (See page 107.)
I sent multiple queries but received no responses back.	<ul style="list-style-type: none"> • Did an error occur? • Be sure to check for and read the response after each query is sent. To read all query responses at once, use the message separator and put all the queries on a single line. (See page 3.) Are you using the *IDN? query? <ul style="list-style-type: none"> • Query commands after an *IDN? query are not executed.
The query response message is not the same as what is displayed on the instrument panel.	<ul style="list-style-type: none"> • Response messages are generated when the query is received by the instrument. Therefore, in some cases the message may not match what is displayed on the panel when the response is read by the controller.
Sometimes service requests are not executed. GP-IB	<ul style="list-style-type: none"> • Are the Service Request Enable and Event Status Enable registers set correctly? (See page 35.) • Clear all the event registers with the *CLS command at the end of your SRQ processing subroutine. If the event bits are not cleared, the service requests will not be executed in the same event. (See page 35.)
I cannot obtain the averaged data.	<ul style="list-style-type: none"> • If any measurement-related settings such as the wiring, voltage range, current range, number of times to perform averaging, VT ratio, CT ratio, etc. are changed, averaging is restarted. To obtain the average values, wait until the first averaging process finishes or monitor the AVG flag in ESR0? as shown below. <ol style="list-style-type: none"> 1. After changing these settings, wait until the first set of data is displayed and clear the event flags. (Example: Changing the current range to 1A) :CURR:RANG 1;*WAI;*CLS 2. Monitor the AVG flag to see when it changes to 1. Read Event Status Register 0 with an :ESR0? query. Repeat until the AVG flag (bit 3) changes to 1. 3. Read the data once the AVG flag changes to 1. :MEAS?

5 Device Documentation Requirements



Information Related to Standard Execution Methods Based on IEEE488.2

(1) IEEE488.1 Interface Functions

See Chapter 4. 1. 3 “GP-IB Interface Settings and Connection” in the Instruction Manual for the instrument.

(2) Operation When the Address Is Set to a Value Outside the Range of 0 to 30

Settings outside the range of 0 to 30 are not allowed.

(3) Recognizing When a User Changes the Initial Address Setting

The new address is recognized at the moment when the user changes the address.

(4) Device Settings When the Instrument is Powered On

All status information is cleared. Other data is backed up.

However, header and response message terminator settings are reset.

(5) Message Exchange Option Notation

- Input Buffer Capacity and Operation

See: Input Buffer (page 5)

- Queries that Return Multiple Response Message Units

:VOLTage? (page 42)

:CURRent? (page 49)

:FREQuency? (page 51)

:SCALE? (page 55)

:INTEGrate? (page 39)

:MEASure? (page 68)

:MEASure:ITEM? (page 75)

:MEASure:HARMonic? (page 96)

:RS232c? (page 106)

- Queries that Generate a Response When Checking Syntax

All queries generate a response when checking syntax.

- Queries that Generate a Response When Read

There are no queries that generate a response when read by the controller.

- Coupled Commands

There are no such coupled commands.

(6) List of Functional Requirements for Device-specific Commands and Compound Command Program Header Specifications

- Program messages
- Program message terminators
- Program message units
- Program message unit separators
- Command message units
- Query message units
- Command program headers
- Query program headers
- Program data
- Character program data
- Binary numerical value program data
- Compound command program headers

(7) Block Data Buffer Capacity Limits

Block data is not used.

-
-
- (8) [List of Program Data Elements Used in <Expressions> and the Maximum Number of Nested Levels Allowed in Sub-expressions \(Including Syntax Restrictions Imposed by the Device on <Expressions>\)](#)
Sub-expressions are not used. The program data elements used in expressions are character program data and binary numerical value program data.
(Excluding [*IDN?](#))
- (9) [Query Response Syntax](#)
See: [Message Reference](#)(page 32)
- (10)[Message Transmission Interference Between Devices that Do Not Conform to the Defined Response Message Rules](#)
Messages cannot be sent between devices.
- (11)[Block Data Response Capacity](#)
There are no block data responses.
- (12)[List of Common Commands and Queries Used](#)
See: [Message List](#)(page 14)
- (13)[Device Status After a Revised Query Completes Successfully](#)
The [*CAL?](#) command is not used.
- (14)[**DDT" Command](#)
The [*DDT?](#) command is not used.
- (15)[Macro Commands](#)
Macros are not used.
- (16)[Identification-related Queries and "**IDN?" Query Responses](#)
See: [Standard Commands](#)(page 33)
- (17)[Capacity of the User Data Storage Area Protected When the "**PUD" Command or "**PUD" Query Is Executed](#)
The [*PUD?](#) command and [*PUD](#) query are not used.
There also is no user data storage area.
- (18)[Resources When the "RDT" Command or "**RDT?" Query Is Used](#)
The [*RDT?](#) command and [*RDT](#) query are not used.
There also is no user data storage area.
- (19)[Situations When the "**RST", "**LRN?", "**RCL", and "**SAV" Commands Are Affected](#)
The [*LRN?](#), [*RCL](#), and [*SAV](#) commands are not used.
The [*RST](#) command resets the instrument back to its initial state.
See: [Standard Commands](#) (page 33) and [Initialization Items](#) (page 12)
- (20)[Range of Self-testing Performed by the "**TST?" Query](#)
See: [Standard Commands](#)(page 33)
- (21)[Additional Status Data Structures Used for Reporting the Device Status](#)
See: [Event Registers](#) (page 8)
- (22)[Are Commands Overwrap or Sequential Commands](#)
All commands are sequential.
- (23)[Standards for Functions Required When Operation Complete Messages Are Generated as Command Responses](#)
Operation complete messages are generated when analysis of the command is performed.

- Please visit our website at <http://www.hioki.com> for the following:
 - Regional contact information
 - The latest revisions of instruction manuals and manuals in other languages.
 - Declarations of Conformity for instruments that comply with CE mark requirements.
- All reasonable care has been taken in the production of this manual, but if you find any points which are unclear or in error, please contact your supplier or the International Sales and Marketing Department at Hioki headquarters.
- In the interests of product development, the contents of this manual are subject to revision without prior notice.
- The content of this manual is protected by copyright.
No reproduction, duplication or modification of the content is permitted without the authorization of Hioki E.E. Corporation.

HIOKI

HIOKI E. E. CORPORATION

Headquarters

81 Koizumi, Ueda, Nagano 386-1192, Japan
TEL +81-268-28-0562 FAX +81-268-28-0568
E-mail: os-com@hioki.co.jp
(International Sales and Marketing Department)

<http://www.hioki.com/>

HIOKI USA CORPORATION

E-mail: hioki@hiokiusa.com <http://www.hiokiusa.com>

HIOKI (Shanghai) Sales & Trading Co., Ltd.

E-mail: info@hioki.com.cn <http://www.hioki.cn>

HIOKI INDIA PRIVATE LIMITED

E-mail: hioki@hioki.in <http://www.hioki.in>

HIOKI SINGAPORE PTE. LTD.

E-mail: info@hioki.com.sg

1407