

Max. **20 MS/s**  
high-speed sampling

All analog channels **isolated**  
Max. 16 channels

Logic channels  
Max. **64 ch**  
16 channels standard

### 5 new modules

Support for a total of 13 units

**NEW**

- ARBITRARY WAVEFORM GENERATOR UNIT
- HIGH VOLTAGE UNIT
- WAVEFORM GENERATOR UNIT
- PULSE GENERATOR UNIT
- DIGITAL VOLTMETER UNIT



## For on-site work and R&D testing Global Standard Recorder

### High-voltage 1000 V direct input measurement

**HIGH-VOLTAGE UNIT** Max. 1 MS/s high-speed sampling, 16-bit resolution measurement

### Generate and record in a single unit

**ARBITRARY WAVEFORM GENERATOR UNIT** Reproduce and output problematic waveform measurements  
No amp needed; max. 15 V output



# Testing



Vibration testing at the product development stage

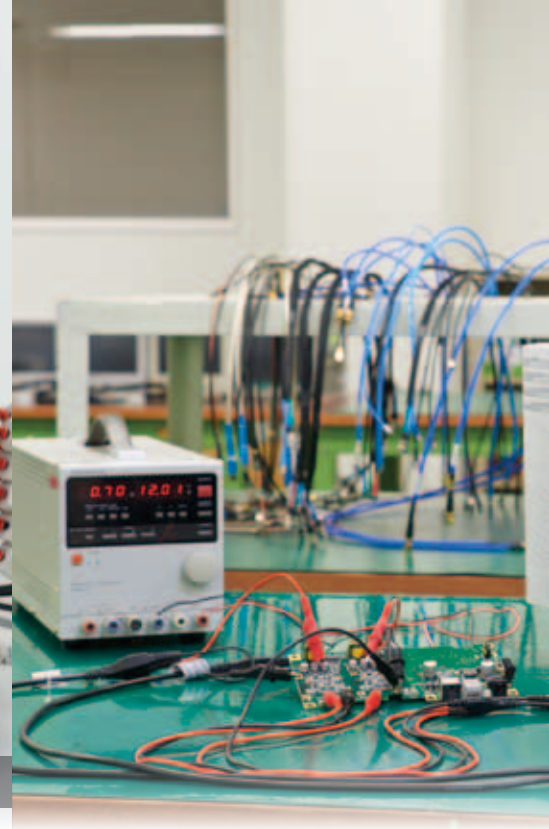

## A high-spec, high-quality versatile measuring device

### 20 MS/sec sampling speed

Perform multi-channel, high-speed sampling at 20 M samples/sec (time axis resolution: 50 nsec) for all channels at the same time.

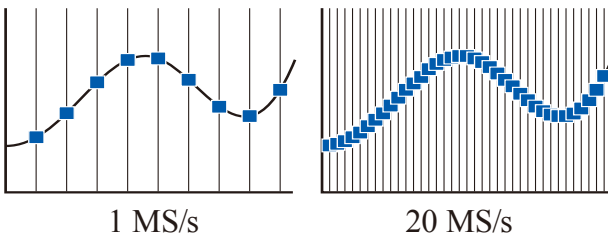

High-speed sampling allows you to measure the rising edge of pulses and detect anomaly operations and instantaneous waveforms that occur suddenly with high precision.

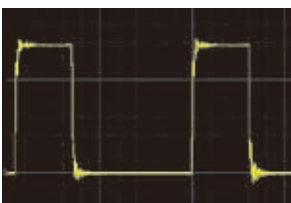

Observe the rising edge of pulses



Input amp with integrated A/D converter

### Isolated input for all channels

Connections between analog input channels, and between the input channel and the main unit, are isolated by isolation elements. So potential differences can be measured without any concerns, just like with an oscilloscope.

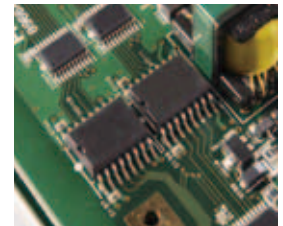

Isolation element

### A4 size built-in printer

Print large, high-definition hard copies for easy on-site checking. Paper is easy to replace by inserting a new roll, rolling out the paper slightly, and then closing the cover.



Simply open the cover, insert the new paper, and then close the cover.

# Development

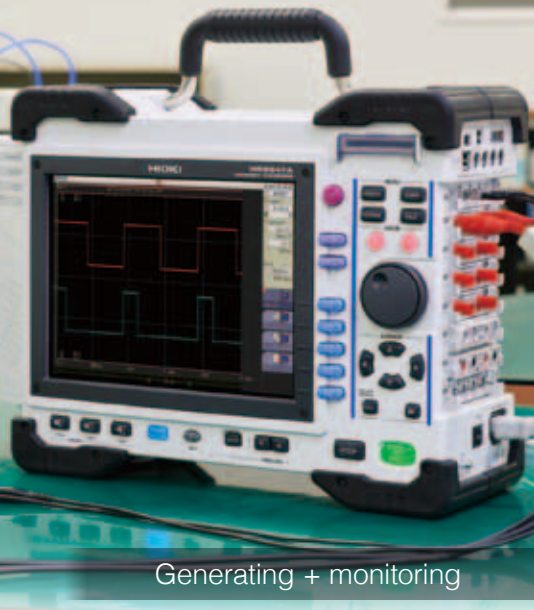

Generating + monitoring

# Surveys



Power supply surveys for power equipment

## 5 new modules added

Hioki has added new high-performance modules in response to overwhelming demand.

The Memory HiCorder now supports a wide variety of measurements with a total of 13 plug-in modules.

- NEW** ARBITRARY WAVEFORM GENERATOR UNIT U8793 ▶
- NEW** HIGH VOLTAGE UNIT U8974 ▶
- NEW** WAVEFORM GENERATOR UNIT MR8790 ▶
- NEW** PULSE GENERATOR UNIT MR8791 ▶
- NEW** DIGITAL VOLTMETER UNIT MR8990 ▶

NEW



## 64 logic input channels +10 analog channels

The MR8847A has 16 built-in logic input channels. Add 3 logic input units to record a total of 64 channels at once. You can also display the waveforms for all channels on a single screen—ideal for timing measurements.

Up to 10 channels of analog waveforms can be recorded at the same time for efficiency.

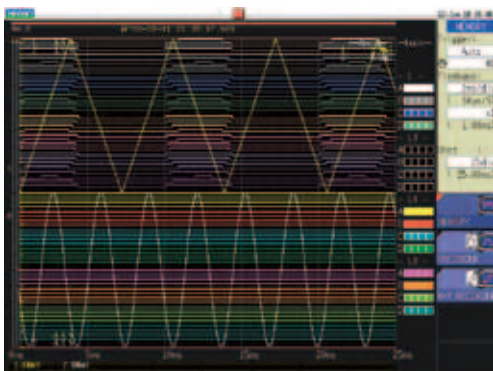

Measure and display multiple relays at the same time

## Large 512 MW capacity (MR8847-53 only)

Hioki has developed an internal storage FPGA for super-high-speed access. Used in combination with large capacity high-speed memory, this enables many hours of high-speed sampling to be recorded.

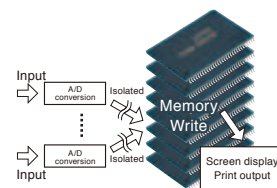

## NEW SSD 128 GB storage media

The new internal SSD unit (available as an additional option) has 128 GB of capacity, allowing large amounts of data to be stored.



## Durable design, with resistance to dropping up to 50 cm

The MR8847A is resistant to strong mechanical shock and vibration, such as short drops.

The durable design has been tested to withstand vertical drops of up to 50 cm.



\* Tested based on in-house conditions. A dropped unit is not guaranteed to be free of damage or trouble.

**NEW** HIGH VOLTAGE UNIT U8974

# Directly input high voltage without a differential probe



2 channels, banana input terminal  
Both channels support 1000 V input

## 1000 V DC, 700 V AC high-voltage direct input

Since you can directly input up to 1000 V DC and 700 V AC, a differential probe is no longer necessary. Maximum rated voltage to ground is 1000 V for CAT III and 600 V for CAT IV environments.

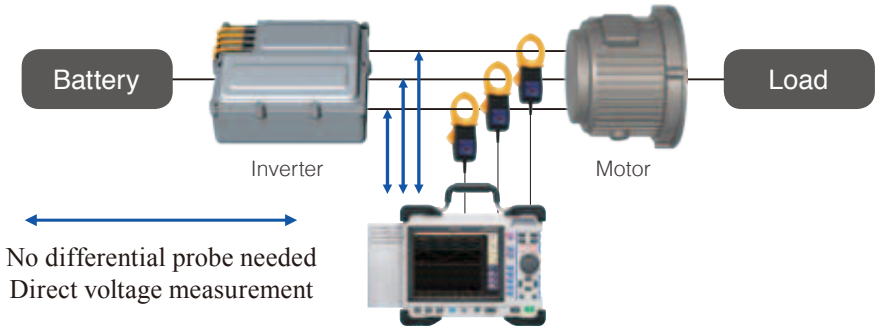

## Global power supply line measurement

Ideal for primary and secondary measurements of UPS power supplies and commercial power supply transformers, and for recording the primary and secondary waveforms of inverters. It can also be used to measure high-voltage power supply lines, such as 380 V and 480 V systems used in many countries.



Supports high voltage systems around the world

## Applicable to a variety of characteristics tests

Maximum 1 MS/s high-speed sampling and 16-bit resolution allow the MR8847A to be used for interruption testing and switch testing.

The voltage of each battery cell can be input separately. This uses 1000 V DC input, which can withstand even if high voltage is applied when a cell shorts.

The digital voltmeter unit, which allows input up to 500 V DC, is suitable for the testing of individual battery cells.

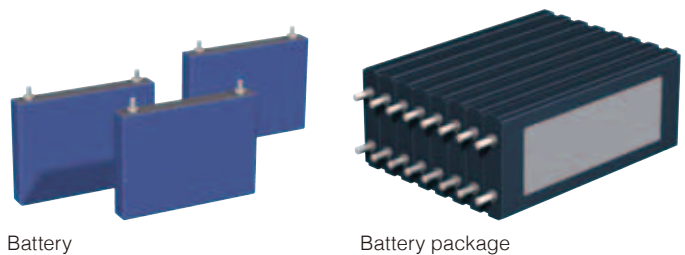

Battery

Battery package

## Transformer Dump Tests

Interchannel isolation allows for safe circuit connections. Simultaneous high-speed sampling can record waveforms before and after the dump. Input large numbers of control and circuit signals.

**Recommended units**



HIGH VOLTAGE UNIT  
U8974

CURRENT UNIT  
8971

LOGIC UNIT  
8973

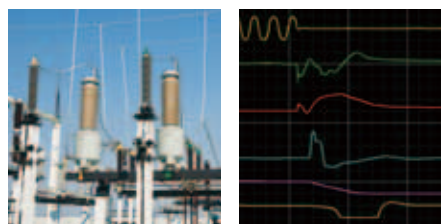

Application of each unit allows analysis of the correlation between voltage before and after the interruption of a generator, RPM fluctuation rate, governor servo motor operation conditions, and suppression machine switch timing.

- Maximum 1 MS/s high-speed sampling and 16-bit resolution in the high-voltage unit allow the MR8847A to be used for interruption and switch testing.

**NEW** ARBITRARY WAVEFORM GENERATOR UNIT U8793

# Generate and record in a single unit

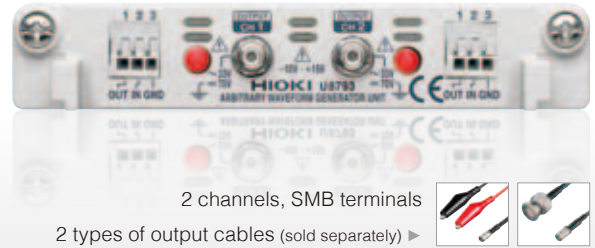

## Output and record results seamlessly

Just one MEMORY HiCORDER gives you a function generator mode, arbitrary waveform generator mode, and waveform measurement mode. This makes it easy to observe waveforms while varying test conditions, such as changing the signal's amplitude and frequency and programming various waveforms to output in order.



### Output recorded waveforms without modification

For example, you could output actual waveforms recorded from a car without modification, and then use them for standalone testing. You can also generate isolated output of up to 15 V without a generator or amplifier, which is traditionally necessary in order to generate output while varying the signal's amplitude and frequency.

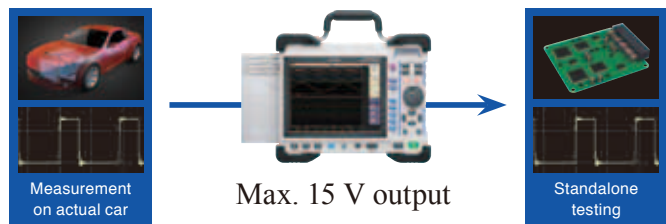

### Process actual waveforms for reproducibility testing

Process and calculate signals recorded with the MEMORY HiCORDER and output the arbitrary waveforms that you create.

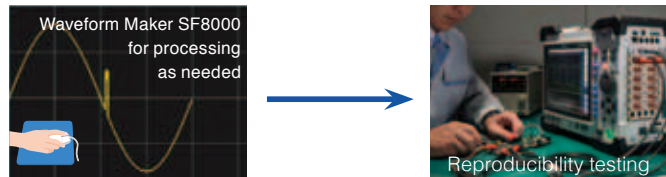

### Waveform Maker Software included

After you install the included SF8000 Waveform Maker software on your computer, you can create waveforms easily by either entering them directly or by entering the functions behind them. You can also quickly add noise and multiply waveforms.

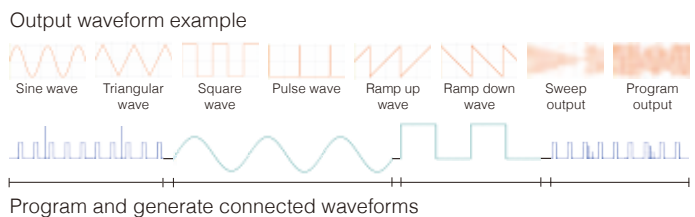

## Anomaly Simulation

Reproduce and output the observed waveforms without modification. When resolving problems observed during research or development, you can reproduce such problems for efficient testing.

**Recommended units**

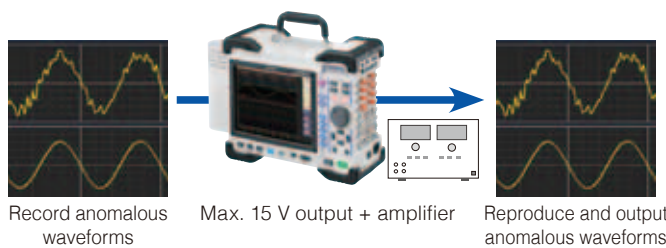

- Create power supply waveforms such as power supply dips, instantaneous interruptions, and voltage fluctuations for immunity tests to regulate malfunctions in equipment caused by power supply harmonics to perform evaluation testing.

# The right unit for your measurement needs

## Inverter / UPS Test

- Operation testing and evaluation during load fluctuation
- Confirmation of UPS switching

Recommended units	ANALOG UNIT 8966
	LOGIC UNIT 8973
	CURRENT UNIT 8971

Perfect for inverter and UPS evaluation / start-up tests. Record using both logic (control signals) and analog (primary/secondary voltage or current for a UPS or inverter).



UPS



Inverter

## Power Monitor and Logger

- Identify power fluctuations when power supply is turned ON/OFF and during load fluctuations
- Long-term fluctuations in power

Recommended units	ANALOG UNIT 8966
	HIGH RESOLUTION UNIT 8968
	FREQ UNIT 8970

Load the analog output for the rms (instant power / voltage / current, etc.) calculated by the power analyzer, or import the waveform output from the power analyzer to observe data for long-term tests or irregular waveforms.

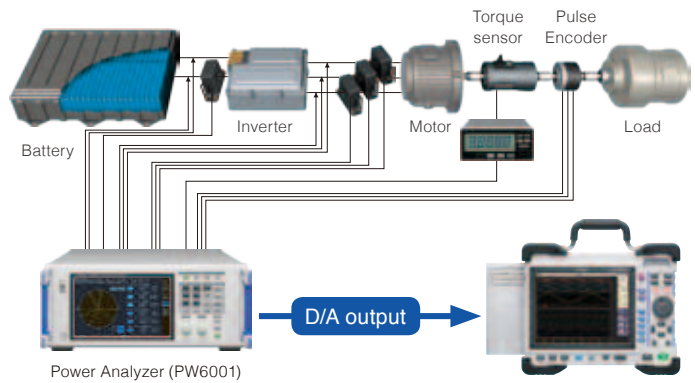

## Control Simulation

- Generate simulated output of each type of sensor signal
- Fluctuating simulated output for 12 V DC car batteries

Recommended units	ARBITRARY WAVEFORM GENERATOR UNIT U8793
	WAVEFORM GENERATOR UNIT MR8490
	PULSE GENERATOR UNIT MR8791

Use actual waveforms to perform testing on control boards, such as for engine control, airbags, brake systems, power steering, and active suspension. This allows efficient simulation of actual waveforms obtained from cars.



Perfect for control testing of automobiles, high speed trains, and traditional trains

13 units to choose from

Generation	Voltage	DC voltage	Generation	Pulse	Voltage
<b>ARBITRARY WAVEFORM GENERATOR UNIT U8793</b> 	<b>HIGH VOLTAGE UNIT U8974</b> 	<b>DIGITAL VOLTMETER UNIT MR8990</b> 	<b>WAVEFORM GENERATOR UNIT MR8790</b> 	<b>PULSE GENERATOR UNIT MR8791</b> 	<b>ANALOG UNIT 8966</b> 
No. of channels: 2 Arbitrary waveform output	Measurement resolution: 16-bit 1/1600 of measurement range	Measurement resolution: 24-bit 1/50 000 of measurement range	No. of channels: 4 Waveform output	No. of channels: 8 Pulse output	Measurement resolution: 12-bit 20 MS/s high-speed sampling
<ul style="list-style-type: none"> <li>• Output frequency range 10m Hz to 100 kHz</li> <li>• Max. output: 15 V</li> </ul>	<ul style="list-style-type: none"> <li>• High voltage</li> <li>• Commercial power supply (primary/secondary)</li> <li>• Power equipment characteristics testing</li> </ul>	<ul style="list-style-type: none"> <li>• Multi-channel</li> <li>• Minute sensor voltage</li> <li>• EV battery voltage</li> </ul>	<ul style="list-style-type: none"> <li>• DC output: -10 V to 10 V</li> <li>• Sine wave output 10 mHz to 20 kHz</li> </ul>	<ul style="list-style-type: none"> <li>• Pulse output 0.1 Hz to 20 kHz</li> <li>• Pattern output</li> </ul>	<ul style="list-style-type: none"> <li>• Various amps</li> <li>• Transducers</li> <li>• Sensors</li> <li>• Industrial meters</li> </ul>

## Vibration / Endurance Tests

- Analyze the relationship between engine control and vibration
- Confirm equipment durability

Recommended units	ARBITRARY WAVEFORM GENERATOR UNIT U8793
	HIGH RESOLUTION UNIT 8968
	STRAIN UNIT 8969

512 MW of high-capacity memory makes it easy to observe vibration waveforms for many hours while performing high-speed sampling. This feature is perfect for detecting waveform peaks.

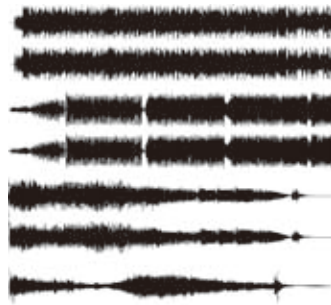

Observe minor vibrations with high precision



Vibration testing equipment

## Replace multiple DMMs with a single unit

Save space by replacing multiple desktop DMM units with a single MEMORY HiCORDER. This eliminates the need to control multiple units and simplifies your system.

Recommended units	DIGITAL VOLTMETER UNIT MR8990
-------------------	-------------------------------



2 channels, banana input terminal  
High precision, high resolution



Install up to 8 DVM Units to expand up to 16 channels

### DIGITAL VOLTMETER UNIT MR8990

NEW

### Fine precision and resolution

Proprietary specifications for DC voltage measurements

Measure minute fluctuations in sensor output for automobiles or voltage fluctuations in batteries with high precision and at high resolution. The maximum voltage that you can input is 500 V DC. Another feature is high input resistance.

Measurement range		Effective input range (Guaranteed measurement accuracy range)	Max. resolution	Input resistance	Measurement accuracy	
					NPLC: less than 1	NPLC: 1 or more
5 mV/div	(f.s. = 100 mV)	-120 mV to 120 mV	0.1 $\mu$ V	100 M $\Omega$ or more	$\pm$ 0.01% rdg. $\pm$ 0.015% f.s.	$\pm$ 0.01% rdg. $\pm$ 0.01% f.s.
50 mV/div	(f.s. = 1000 mV)	-1200 mV to 1200 mV	1 $\mu$ V		$\pm$ 0.01% rdg. $\pm$ 0.0025% f.s.	
500 mV/div	(f.s. = 10 V)	-12 V to 12 V	10 $\mu$ V	10 M $\Omega$ $\pm$ 5%	$\pm$ 0.025% rdg. $\pm$ 0.0025% f.s.	
5 V/div	(f.s. = 100 V)	-120 V to 120 V	100 $\mu$ V			
50 V/div	(f.s. = 1000 V)	-500 V to 500 V	1 mV			

● 6.5-digit display (Resolution: 0.1  $\mu$ V), 24-bit high resolution

Temperature	Voltage	Distortion	Frequency, RPM	Current	Voltage	Contact
TEMP UNIT 8967	HIGH RESOLUTION UNIT 8968	STRAIN UNIT 8969	FREQ UNIT 8970	CURRENT UNIT 8971	DC/RMS UNIT 8972	LOGIC UNIT 8973
Measurement resolution: 16-bit 1/1000 of measurement range	Measurement resolution: 16-bit 1/1600 of measurement range	Measurement resolution: 16-bit 1/1250 of measurement range	Measurement resolution: 16-bit 1/2000 of measurement range	Measurement resolution: 12-bit Clamp sensor direct connection	Measurement resolution: 12-bit RMS measurement	No. of channels: 16 Observation of control signal
• Thermocouple K, J, E, T, N, R, S, B, W	• Supply voltage • Primary / secondary inverter voltage • Motor voltage, etc.	• Strain gauge converter • Dynamic strain * Vibration • Pressure * Acceleration • Weight, etc.	• Encoder • Rotating pulse	• Supply current • Inverter current • Motor current, etc.	• Supply voltage • Primary / secondary inverter voltage • Motor voltage, etc.	• Voltage / non-voltage contacts • Relay signals • AC / DC signals

# Full range of supporting functions

## On-site assistance

### Help function

Understand operation methods without even reading the instruction manual using the built-in Help function. Place the cursor on a field in the settings and press the HELP button to view a detailed description of that setting.

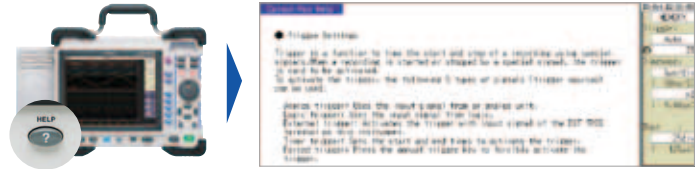

Press the HELP button.

A detailed description of the setting is displayed.

## Master triggers

### Set triggers while viewing waveforms

Set input triggers while checking waveforms. You can also display the settings screen separately as a floating screen.

### Trigger functions for monitoring all measurement channels

- Level trigger for comparing a single voltage value
- Window trigger for comparing 2 voltage values
- Voltage drop trigger for detecting voltage drops in commercial power lines
- Period trigger for monitoring periods
- Glitch trigger for detecting anomalies in pulses
- Pattern trigger for comparisons when the logic signal is ON/OFF

### Acquiring data with triggers, and post-acquisition searching

The MR8847A includes a search function for finding abnormal waveforms within all of the acquired data. You can use this function to search for anomalies after data has been acquired, when it is too difficult to set triggers because it is not possible to predict what types of anomalies might be observed.

### Set the number of events for each source

\* Only for level and glitch triggers

Set trigger conditions in a variety of combinations.

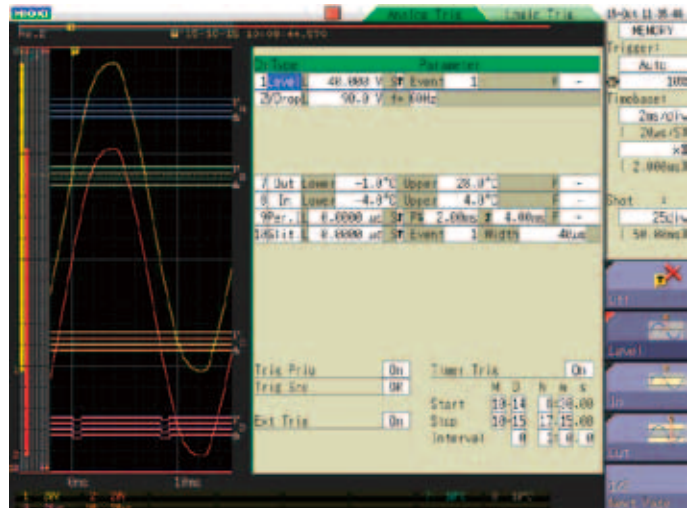

Adjust levels while displaying waveforms

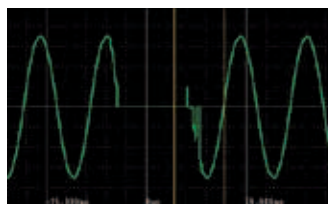

Detect instantaneous outages

Ch Type	Parameter	Event
1LevelL	100.0 V	1
2LevelL	80.00 V	5
3LevelL	0.000 V	1
4LevelL	0.000 V	1
5LevelL	0.000 V	1

Setting screen for number of events

## Label each channel

### Comment entry function

Set comments for each channel and display them on the screen, even when observing multiple channels, making identification easy.

When printing, you can also print the channel comments.

Input comments directly on the unit or by using a USB keyboard.

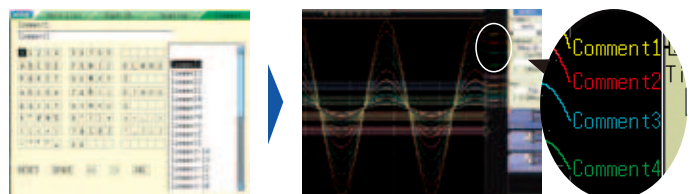



## Enlarge waveforms

### Zoom function

Display time axis reduced waveforms at the top of the screen, and time axis enlarged waveforms at the bottom of the screen. You can use the scroll function to display the entire waveform while also observing specific parts.

Collapse waveform



Check the entire waveform.

Expand waveform



Enlarge/shrink along the time/vertical axes.

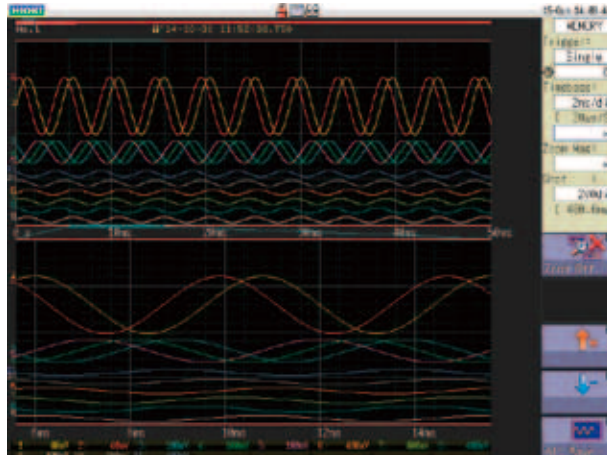

Enlarge to observe waveform details

## Scan and clip

### AB cursor function

Apply the Zoom function to set point A and point B for the area you want to clip.

Scan



Scan data at the cursor and the waveform's cross point.

Extract



Specify the segment to save as binary or CSV data.

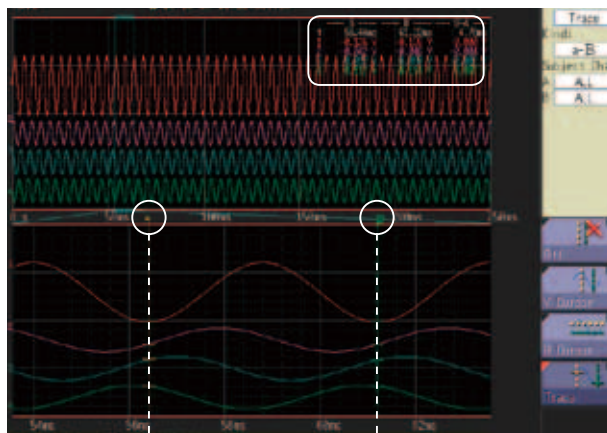

Conveniently manage scanned data on your computer

## PC operations

### Connect to LAN for HTTP/FTP server functions

Use the HTTP function to operate the MEMORY HiCORDER with a browser on a PC connected via LAN. You can also use the FTP function to acquire data from the internal memory or from storage media inserted in the MEMORY HiCORDER.

You can even acquire data from the internal memory or from storage media connected to the MEMORY HiCORDER via USB.

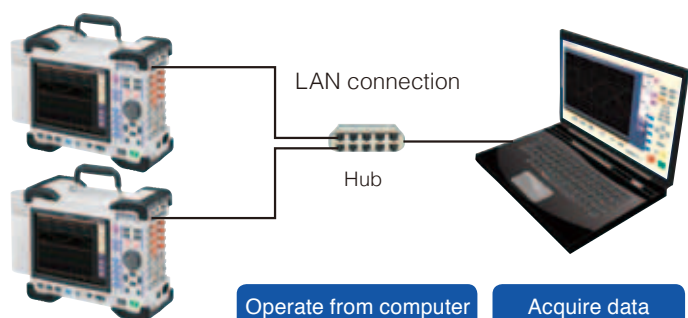

# Record the data you need

## Simultaneous recording on storage media

### Memory functions

**Recording method** Sampling is done at the set period, and all data is recorded.

- Automatic data saving on SSD / CF card or USB memory stick
- During high-speed sampling, data is written to internal memory first and later saved on other media
- During low-speed sampling, data is written to internal memory while also saved on other media
- Highly effective for long-term recording

Maximum Recording Time to internal memory (excerpt)

		MR8847-51 (64 MW)	MR8847-52 (256 MW)	MR8847-53 (512 MW)
Maximum recording length fluctuates depending on number of channels used.		16 analog channels + 16 internal logic channels	16 analog channels + 16 internal logic channels	16 analog channels + 16 internal logic channels
Time axis	Sampling period	40 000 divisions	160 000 divisions	320 000 div
5 μs/div	50 ns	0.2 s	0.8 s	1.6 s
10 μs/div	100 ns	0.4 s	1.6 s	3.2 s
100 μs/div	1 μs	4 s	16 s	32 s
1 ms/div	10 μs	40 s	2 min 40 s	5 min 20 s
100 ms/div	1 ms	1 h 06 min 40 s	4 h 26 min 40 s	8 h 53 min 20 s
1 s/div	10 ms	11 h 06 min 40 s	1 d 20 h 26 min 40 s	3 d 16 h 53 min 20 s
1 min/div	600 ms	27 d 18 h 40 min 00 s	111 d 02 h 40 min 00 s	222 d 05 h 20 min 00 s
5 min/div	3.0 s	138 d 21 h 20 min 00 s	555 d 13 h 20 min 00 s	1111 d 02 h 40 min 00 s

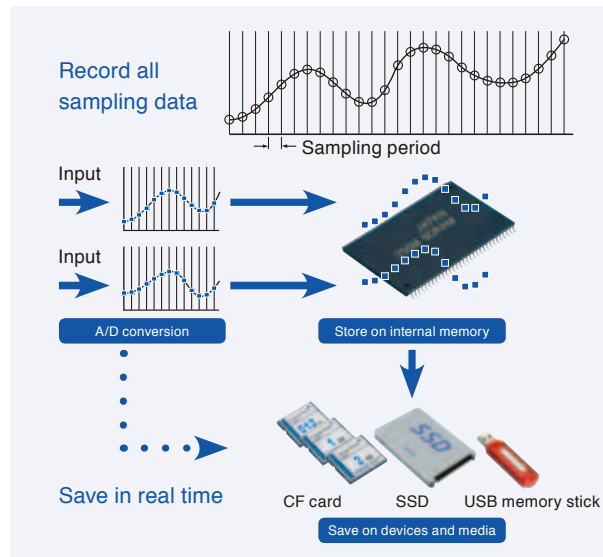

- Caution: Available recording duration is determined by internal RAM capacity, not by external media.
- Caution: Although USB memory sticks enable automatic data saving, for more reliable data protection, we recommend use of HIOKI CF cards, which are guaranteed to work with the instrument.
- Note: Table shows maximum values at arbitrary recording length settings.
- Note: Saving to media in near real-time is possible at sampling speeds of 100 ms/div (1 msec sampling) or slower.

## Analysis software

### WAVE PROCESSOR 9335

(Software sold separately)

- Waveform display, calculations
- Print function

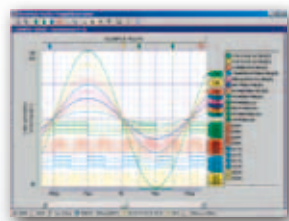

#### 9335 Brief Specifications

Operating environment	Windows 10/8/7 (32/64-bit), Vista (32-bit), XP
Functions	- Display functions: Waveform display, X-Y display, Cursor function, etc. - File loading: Readable data formats (.MEM, .REC, .RMS, .POW) / Maximum loadable file size: Maximum file size that can be saved by a given device (file size may be limited depending on the computer configuration) - Data conversion: Conversion to CSV format, Batch conversion of multiple files, etc.
Printing	- Print function: Printing image file output (expanded META type, *.EMF) - Print formatting: 1 up, 2-to-16 up, 2-to-16 rows, X-Y 1-to-4 up, preview, hard copy

### LAN COMMUNICATOR 9333

(Software sold separately)

- Auto-save waveform data to PC
- Remote control via LAN connection
- Save in CSV format and transfer to spreadsheet programs

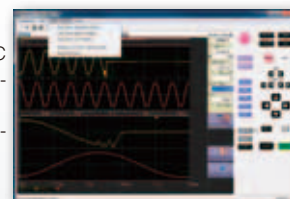

#### 9333 Brief Specifications

Operating environment	Windows 10/8/7 (32/64-bit), Vista (32-bit), XP, (9333 ver.1.09 or later)
Functions	- Auto-saves waveform data to PC, Remote control of Memory HiCorder (by sending key codes and receiving images on screen), print report, print images from the screen, receive waveform data in same format as waveform files from the Memory HiCorder (binary only) - Waveform data acquisition: Accept auto-saves from the Memory HiCorder, same format as auto-save files of Memory HiCorder (binary only), print automatically with a Memory HiCorder from a PC. The Memory HiCorder's print key launches printouts on the PC - Waveform viewer: Simple display of waveform files, conversion to CSV format, etc.

# Chart recording without missing transient events

## Recorder functions

**Recording method**

Sampling is done at the set period, and data other than the maximum and minimum values is thinned out for recording.

- High-speed sampling ensures that transient events are captured also with slow recording
- Data compression achieved by recording maximum/minimum value pairs
- Max. 833-day (1 hr/div) long-term recording even for 64 MW model
- Continuous recording until paper runs out for chart output

### Maximum Recording Time with the Recorder function

REC time axis	Sampling period	To internal memory 20000 divisions	Continuous (approx. recording time with 30 m paper roll) <small>*Calculated as 30 m = 2,970 divisions *Changing paper enables semi-permanent continuation of recording.</small>
100 ms/div		33 min 20 s	Display only
200 ms/div		1 h 6 min 40 s	Display only
500 ms/div		2 h 46 min 40 s	24 min 45 s
1 s/div	1 μs, 10 μs,	5 h 33 min 20 s	49 min 30 s
2 s/div	100 μs,	11 h 6 min 40 s	1 h 39 min 00 s
5 s/div	1 ms, 10 ms,	1 d 3 h 46 min 40 s	4 h 7 min 30 s
10 s/div	100 ms	2 d 7 h 33 min 20 s	8 h 15 min 00 s
30 s/div		6 d 22 h 40 min 00 s	24 h 45 min 00 s
50 s/div	* Limited by combination of selections under 1/100 on time axis and time axis setting for memory recording	11 d 13 h 46 min 40 s	1 d 17 h 15 min 00 s
100 s/div		23 d 3 h 33 min 20 s	3 d 10 h 30 min 00 s
1 min/div		13 d 21 h 20 min 00 s	2 d 1 h 30 min 00 s
2 min/div		27 d 18 h 40 min 00 s	4 d 3 h 00 min 00 s
5 min/div		69 d 10 h 40 min 00 s	10 d 7 h 30 min 00 s
10 min/div		138 d 21 h 20 min 00 s	20 d 15 h 00 min 00 s
30 min/div		416 d 16 h 00 min 00 s	61 d 21 h 00 min 00 s
1 hr/div		833 d 8 h 00 min 00 s	123 d 18 h 00 min 00 s

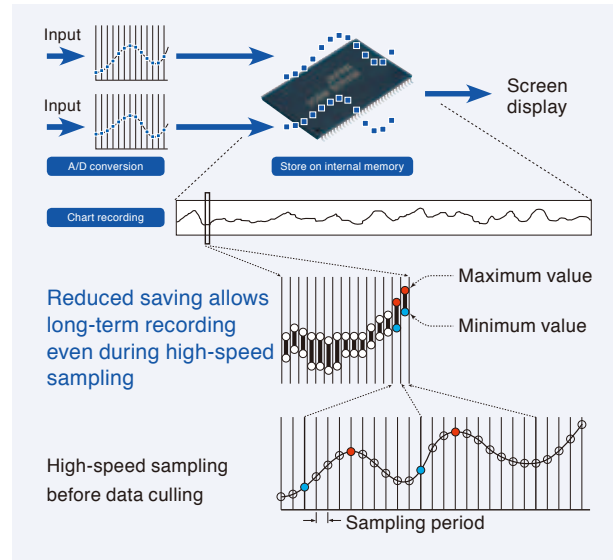

- Notes
- When opening data created with the Recorder function on a computer, the maximum and minimum data pairs are lined up in a time series.
  - Length of printer paper roll is 30 meters. Paper can be changed during operation without stopping the recording process.
  - With settings between 100 ms and 200 ms/div on the time axis, continuous recording is not possible if printer is ON.
  - The table shows values for the MR8847-51 (64 M-words memory capacity). Model MR8847-52 (256 MW) can record four times and Model MR8847-53 (512 MW) eight times as much. At "Continuous" setting in recording length, total recording time cannot be increased.

## iPad App for Memory HiCorder HMR Terminal

Free app (exclusively for iPad) downloadable from the App Store

- Freely control waveforms using iPad's gesture controls
- Fingertip operation of Max. 32 channels of waveform data
- Operate the Memory HiCorder via network  
You can change settings, and monitor waveforms during measurement.  
\*New function on Ver 2.0



### HMR Terminal Brief specifications (free software)

Operating environment	iOS on the iPad (Apple Inc.)
Functions	- Data acquisition: Send to iPad via FTP using a WiFi router, or load to iPad via iTunes (PC app) - Intuitively operate waveform level searches, maximum / minimum / average values, zero position adjustment, and more at your fingertips - Waveform monitoring - Meter setting  * Logic waveforms and computational waveforms are not supported.

## Wave Viewer Wv

(Bundled software)

- Check waveforms with binary data on a PC
- Save data in CSV format and transfer to spreadsheet programs

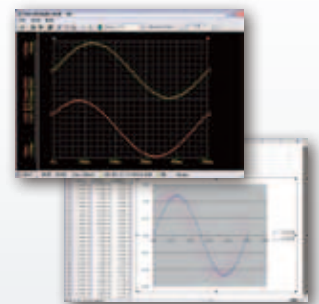

### Wave Viewer (Wv) Brief Specifications

Operating environment	Windows 10/8/7 (32/64-bit), Vista (32-bit), XP
Functions	- Simple display of waveform files - Convert binary data files to text format, CSV, etc. - Scroll function, enlarge/reduce display, jump to cursor/trigger position, etc.

# Definitive analysis of important data

## Calculate parameter values from measured waveforms

The MR8847A can perform 24 calculations, including RMS, peak value, and maximum value, from measured waveforms. It can also perform time difference measurements, histogram measurements, phase difference measurements, histogram measurements for HIGH level and LOW level, and statistical processing. Calculation results are displayed together on the waveform observation screen.

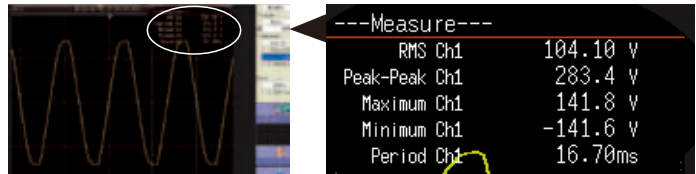

## Process waveforms with formulas

If you know the required formulas, you can also perform complicated calculations. By entering formulas, you can perform a variety of calculations even after measurements are complete. For example, you can make the settings shown on the right to find the RMS value from a measured waveform.

$$RMS = \sqrt{\frac{1}{n} \sum_{i=1}^n d_i^2}$$

RMS = RMS value  
 n = Data number  
 di = Data for channel i

```
Z1 = SQR(MOV(CH2*CH2,500))
```

Enter formula

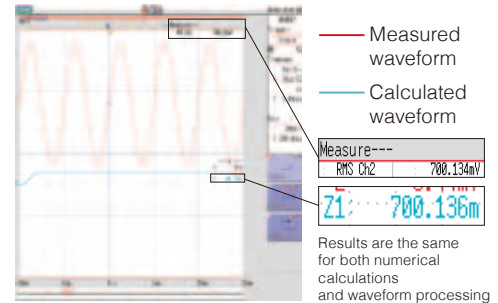

## FFT analysis function

The MR8847A can perform one-signal FFT for analyzing frequency components, two-signal FFT for analyzing transfer functions, and octave analysis for acoustics.

### FFT calculations from memory waveforms

When performing FFT analysis of data measured with the memory function, you can use the jog shuttle to specify analysis points while also viewing the calculation results at the same time. You can also display both the raw data measured with the memory function and the calculation results for storage waveforms at the same time, which improves operability during analysis by displaying spectrum waveforms while checking the results of window functions.

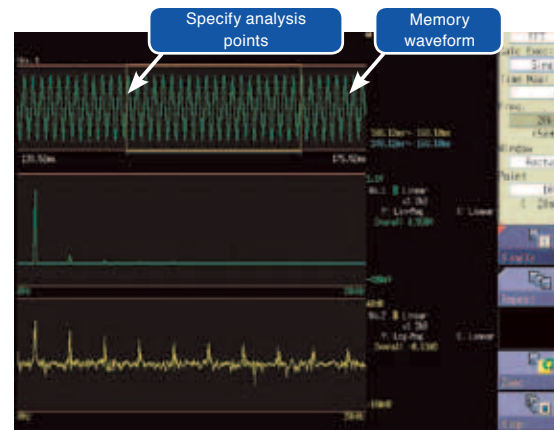

Display the calculation source (memory waveform) and FFT calculation results at the same time

### Running spectrum display

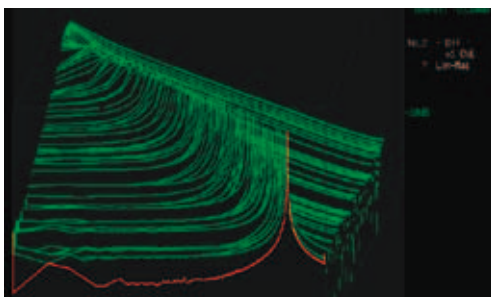

Display the spectrum as it changes over time in 3D

### Change the number of calculation points after measurement

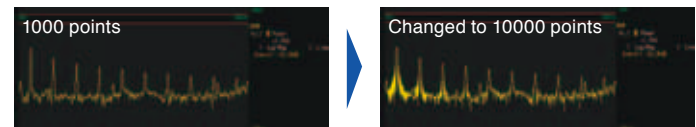

### Scaling by "dB"

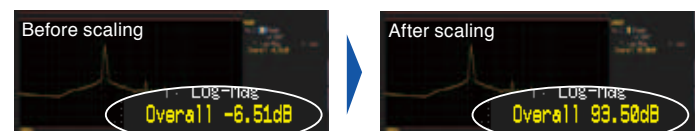

## X-Y RECORDER

Now even easier to use with independent pen up/down control. Saving data in chronological order allows records to be saved as digital data, rather than paper hardcopies that need to be stored.

### Pen up/down control

Pen up/down during X-Y recording is controlled independently. Press the function button or use an external control terminal (EXT. IN 1, 2, 3) for external control.

### Replaces mechanical pen recorders

Use pen up/down control to record only the required data. This allows you to reduce the amount of unnecessary data that is recorded, and lower the running cost for paper.

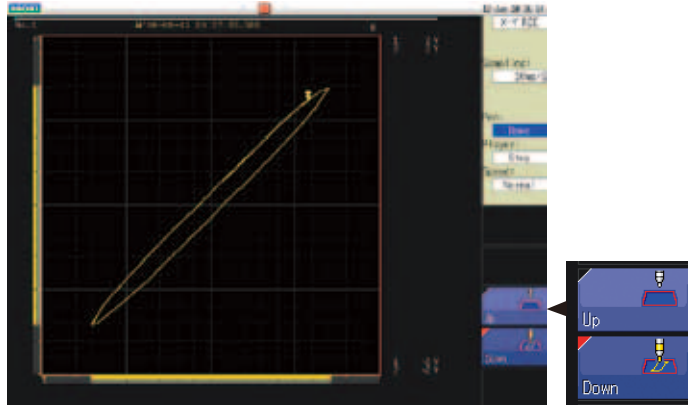

Pen up/down while recording X-Y waveforms



Control terminals

## Determine waveform quality

Use the waveform judgment function, which monitors whether a waveform extends beyond the given area, to easily determine the quality of signal waveforms that are normally difficult to judge.

For time axis ranges that are slower than 100 msec/div, you can even make judgments while loading waveforms. This allows you to take the appropriate action the moment a poor waveform is detected on the production line. You can stop the line as soon as an abnormality is detected.

### Judge FFT analysis waveforms

Judge FFT analysis waveforms in the same way.

### Judge X-Y waveforms

In addition to time axis signals, the MR8847A also has a waveform judgment function for X-Y waveforms built in. Use this to detect:

- Displacement and pressure of presses
- Pressure and flow rate of pumps

The X-Y waveforms of the above and other data can be tested automatically based on area judgment.

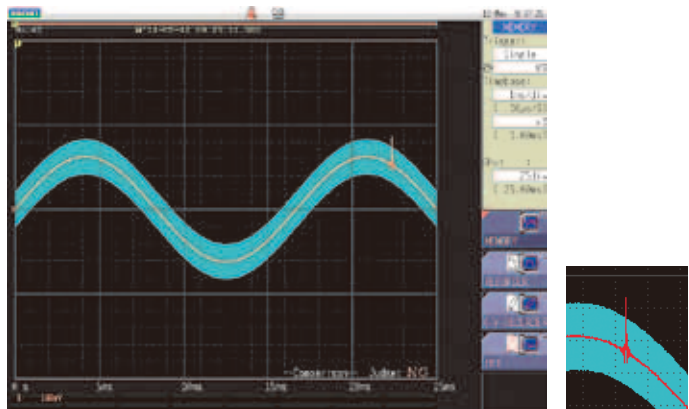

Judge waveform quality by area

Judgment: Poor

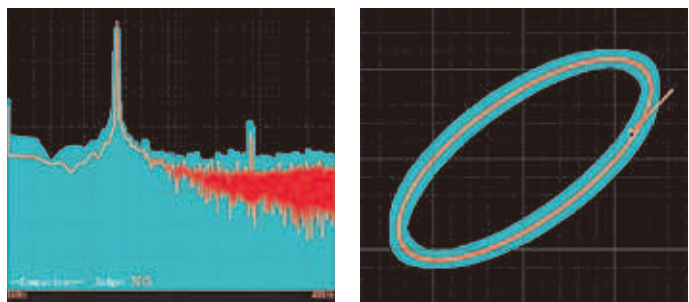

Judge FFT analysis waveforms and X-Y waveforms by area

# Product Specifications

## Basic specifications (Accuracy guaranteed for 1 year, Post-adjustment accuracy guaranteed for 1 year)

Measurement functions	MEMORY (high-speed recording), RECORDER (real-time recording) X-Y RECORDER, FFT
Number of input units	[8 analog input modules]: 16 analog channels + 16 logic channels (built-in) [5 analog input modules + 3 logic input modules]: 10 analog channels + 64 logic channels (16 built-in channels + 48 channels in logic input modules) * For analog units, channels are isolated from each other and from frame GND. For logic units and internal standard logic terminals, all channels have a common ground.
Max. sampling speed	20 MS/second (50 ns period, all channels simultaneously) External sampling (10 MS/second, 100 ns period)
Memory capacity	MR8847-51: Total 64 M-words (Memory expansion: none) 32 MW/ch (using 2 Analog channels), to 4 MW/ch (using 16 Analog channels) MR8847-52: Total 256 M-words (Memory expansion: none) 128 MW/ch (using 2 Analog channels), to 16 MW/ch (using 16 Analog channels) MR8847-53: Total 512 M-words (Memory expansion: none) 256 MW/ch (using 2 Analog channels), to 32 MW/ch (using 16 Analog channels)
Removable storage	CF card slot (standard) × 1 (up to 2GB, FAT, or FAT-32 format), SSD (128 GB, optional), USB memory stick (USB 2.0)
Backup function (At 25°C/77°F)	Clock and parameter setting backup: at least 10 years, Waveform backup function: none
Control terminals	External trigger input, Trigger output, External sampling input, Two external outputs (GO, NG), Three external inputs (START, STOP, PRINT)
External interface	LAN: 100BASE-TX (FTP server, HTTP server) USB: USB2.0 compliant, series A receptacle ×1, series B receptacle ×1, (File transfer internal drive/CF card to PC, or remote control from PC)
Environmental conditions (no condensation)	Operation: -10°C to 40°C (14°F to 104°F), 20% to 80% RH With printer and/or SSD in use: 0°C to 40°C (32°F to 104°F), 20% to 80% RH Storage: -20°C to 50°C (-4°F to 122°F), 90% RH or less
Compliance standard	Safety: EN61010 EMC: EN61326, EN61000-3-2, EN61000-3-3
Power supply	100 to 240 V AC, 50/60 Hz 10 to 28 V DC (use the DC POWER UNIT 9784: Factory installation only)
Power consumption	130 VA max. (Printer not used), 220 VA max. (Printer used)
Dimensions and mass	Approx. 351 mm (13.82 in) W × 261 mm (10.28 in) H × 140 mm (5.51 in) D, 7.6 kg (268.1 oz) (main unit only)
Accessories	Instruction Manual ×1, Measurement Guide ×1, Application Disk (Waveform Maker Software SF8000, Wave Viewer Wv, Communication Commands table) ×1, Power cord ×1, Input cord label ×1, USB cable ×1, Printer paper ×1, Roll paper attachment ×2, Ferrite clamp ×1

## Internal printer

Features	Printer paper one-touch loading, high-speed thermal printing
Recording Paper	216 mm (8.50 in) × 30 m (98.43 ft), thermal paper roll (use 9231 paper) Waveform section recording width: 200 mm (7.87 in) 20 division full scale, 1 div = 10 mm (0.39 in) 80 dots
Recording speed	Max. 50 mm (1.97 in)/sec
Paper feed density	10 dots/mm

## Display

Display section	10.4 inch SVGA-TFT color LCD (800 × 600 dots) (Time axis 25 div × Voltage axis 20 div, X-Y waveform 20 div × 20 div)
Display languages	English, Japanese, Korean, Chinese
Waveform display zoom/compression	Time axis: x10 to x2 (zoom at MEMORY function only), x1, x1/2 to x1/20 000 Voltage axis: x100 to x2, x1, x1/2 to x1/10
Variable display	Upper/Lower limit set, display/div set
Scaling	10:1 to 1000:1, automatic scaling for various probes Manual scaling (conversion ratio setting, 2-point setting, unit setting)
Comment entry	Alphanumeric input (title, analog and logic channels), Simple input, history input, phrase input
Logic waveform	Display point move 1% step, Line width 3 types
Display partition	Max. 16 graphs
Monitor functions	- Level monitor - Numerical value (sampling 10 kS/s fixed, refresh rate 0.5 s)
Other display functions	- Waveform inversion (positive/negative) - Cursor measurement (A, B, 2-cursor, for all channels) - Vernier function (amplitude fine adjustment) - Zoom function (horizontal screen division, zoomed waveform shown in lower section) - 16 selectable colors for waveform display - Zero position shift in 1% steps for analog waveform - Global zero adjust for all channels and all ranges

## MEMORY (High-speed recording)

Time axis	5 μs to 5 min/div (100 samples/div) 26 ranges, External sampling (100 samples/div, or free setting), Time axis zoom: x2 to x10 in 3 stages, compression: 1/2 to 1/200 000 in 16 stages
Sampling period	1/100 of time axis range (minimum 50 ns period)
Recording length	MR8847-51: 16 ch mode: 25 to 20 000 div, 2 ch mode: 25 to 200 000 div (built-in presets) or arbitrary setting in 1-div steps (max. 320 000 div) MR8847-52: 16 ch mode: 25 to 100 000 div, 2 ch mode: 25 to 1 000 000 div (built-in presets) or arbitrary setting in 1-div steps (max. 1 280 000 div) MR8847-53: 16 ch mode: 25 to 200 000 div, 2 ch mode: 25 to 2 000 000 div (built-in presets) or arbitrary setting in 1-div steps (max. 2 560 000 div)
Pre-trigger	Record data from before the trigger point at 0 to +100% or -95% of the recording length in 15 stages, or in 1 div step settings
Numerical calculations	- Simultaneous calculation for up to 16 selected channels Average value, effective (rms) value, peak to peak value, maximum value, time to maximum value, minimum value, time to minimum value, period, frequency, rise time, fall time, standard deviation, area value, X-Y area value, specified level time, specified time level, pulse width, duty ratio, pulse count, four arithmetic operations, time difference, phase difference, high-level and low-level - Calculation result evaluation output: GO/NG (with open-collector 5 V output) - Automatic saving of calculation results
Waveform processing	- For up to 16 freely selectable channels, the following functions can be performed (results are automatically stored): Automatic saving of four arithmetic operations, absolute value, exponentiation, common logarithm, square root, moving average, differentiation (primary, secondary), integration (primary, secondary), parallel displacement along time axis, trigonometric functions, reverse trigonometric functions, calculation results
Memory segmentation	- Max. 1024 blocks, sequential storage, multi-block storage
Other	- No logging - X-Y waveform synthesis (1-screen, 4-screens) - Overlay (always overlay when started/overlay only required waveforms) - Automatic/ Manual/ A-B cursor range printing/ Report printing

## RECORDER (Real-time recording)

Time axis	10 ms to 1 hour/div, 19 ranges, time axis resolution 100 points/div * Out of data acquired at selected sampling rate, only maximum and minimum value data determined using 100 points/div units are stored. Time axis compression selectable in 14 steps, from ×1/2 to ×1/50 000
Sampling period	1/10/100 μs, 1/10/100 ms (selectable from 1/100 or less of time axis)
Real-time printing	Supported * Real-time printing is possible at time axis settings slower than 500 ms/div * Delayed print is performed when recording length is not set to "Continuous" and time axis setting is 10 ms to 200 ms/div * When recording length is set to "Continuous" and time axis setting is 10 ms to 200 ms/div, manual printing can be performed after measurement stop
Recording length	MR8847-51: Built-in presets of 25 to 20 000 div, or "Continuous" or arbitrary setting in 1-div steps (max. 20 000 div) MR8847-52: Built-in presets of 25 to 50 000 div, or "Continuous" or arbitrary setting in 1-div steps (max. 80 000 div) MR8847-53: Built-in presets of 25 to 100 000 div, or "Continuous" or arbitrary setting in 1-div steps (max. 160 000 div)
Additional recording	Supported (recording is resumed without overwriting previous data)
Waveform memory	MR8847-51: Store data for most recent 20 000 div in memory MR8847-52: Store data for most recent 80 000 div in memory MR8847-53: Store data for most recent 160 000 div in memory * Backward scrolling and re-printing available
Auto saving	Data are automatically saved on CF card, USB memory stick or internal drive after measurement stops.
Other	- No logging - Manual/ A-B cursor range printing/ Report printing

## X-Y RECORDER (X-Y real-time recording)

Sampling period	1/10/100 ms (dot), 10/100 ms (line)
Recording length	Continuous
Screen, Printing	Split screen (1 or 4), Manual printing only
Number of X-Y	1 to 8 phenomena
X-Y channel setting	Any 8 channels out of 16 can be selected for X axis and Y axis respectively
X-Y axis resolution	25 dots/div (screen), horizontal 80 dots/div × vertical 80 dots/div (printer)
Waveform memory	Sampling data for last 4 000 000 points are stored in memory
Pen up/down	Simultaneous for all phenomena
External pen control	Possible via external input connector (simultaneous up/down for all phenomena)

Trigger functions	
Trigger mode	MEMORY (high-speed recording), FFT: Single, Repeat, Auto RECORDER (real-time recording): Single, Repeat
Trigger source	CH1 to CH16 (analog), Standard Logic 16ch + Logic Unit (Max. 3 units 48 channels), External (a rise of 2.5V or terminal short circuit), Timer, Manual (either ON or OFF for each source), Logical AND/OR of sources
Trigger types	<ul style="list-style-type: none"> <li>- Level: Triggering occurs when preset voltage level is crossed (upwards or downwards)</li> <li>- Voltage drop: Triggering occurs when voltage drops below peak voltage setting (for 50/60 Hz commercial power supply only)</li> <li>- Window: Triggering occurs when window defined by upper and lower limit is entered or exited</li> <li>- Period: Rising edge or falling edge cycle of preset voltage value is measured and triggering occurs when defined cycle range is exceeded</li> <li>- Glitch: Triggering occurs when pulse width from rising or falling edge of preset voltage value is under run</li> <li>- Event setting: Event count is performed for each source, and triggering occurs when a preset count is exceeded</li> <li>- Logic: 1, 0, or ×, Pattern setting</li> </ul>
Level setting resolution	0.1% of full scale (full scale = 20 divisions)
Trigger filter	Selectable 0.1 div to 10.0 div, or OFF (high-speed recording) ON (10 ms fixed) or OFF (at RECORDER function)
Trigger output	Open collector (5 voltage output, active Low) At Level setting: pulse width (Sampling period × data number after trigger) At Pulse setting: pulse width (2 ms)
Other functions	Trigger priority (OFF/ON), Pre-trigger function for capturing data from before / after trigger event (at MEMORY function), Level display during trigger standby, Start and stop trigger (at RECORDER function), Trigger search function

Other	
Waveform judgment function (In MEMORY or FFT function)	<ul style="list-style-type: none"> <li>- Area comparison with reference waveform area for time domain waveform, X-Y waveform, or FFT analysis waveform</li> <li>- Parameter calculated value comparison with reference value</li> <li>- Output: GO/NG decision, Open-collector 5V, *100 msec/div (1 msec sampling) and thereafter allows for evaluation in almost real-time.</li> </ul>
FFT function	
Analysis mode	Storage waveform, Linear spectrum, RMS spectrum, Power spectrum, Density of power spectrum, Cross power spectrum, Auto-correlation function, Histogram, Transfer function, Cross-correlation function, Impulse response, Coherence function, 1/1 Octave analysis, 1/3 Octave analysis, LPC analysis, Phase spectrum
Analysis channels	Selectable from all analog input channels
Frequency range	133 mHz to 8 MHz, External (resolution 1/400, 1/800, 1/2000, 1/4000)
Number of sampling points	1000, 2000, 5000, 10 000 points
Window functions	Rectangular, Hanning, Hamming, Blackman, Blackman-Harris, Flat-top, Exponential
Display format	Single, Dual, Nyquist, Running spectrum
Averaging function	Time axis / frequency axis simple averaging, Exponential averaging, Peak hold (frequency axis), Averaging times: 2 times to 10000 times
Print functions	Same as the MEMORY function (partial print not available)

- Maximum Internal Memory Recording Time (MEMORY Function)

		MR8847-51 (64 MW)		MR8847-52 (256 MW)		MR8847-53 (512 MW)	
		Analog 16 ch + Internal Logic 16 ch	Analog 2 ch + Internal Logic 16 ch	Analog 16 ch + Internal Logic 16 ch	Analog 2 ch + Internal Logic 16 ch	Analog 16 ch + Internal Logic 16 ch	Analog 2 ch + Internal Logic 16 ch
Time axis	Sampling period	40 000 divisions	320 000 div	160 000 divisions	1 280 000 divisions	320 000 div	2 560 000 divisions
5 μs/div	50 ns	0.2 s	1.6 s	0.8 s	6.4 s	1.6 s	12.8 s
10 μs/div	100 ns	0.4 s	3.2 s	1.6 s	12.8 s	3.2 s	25.6 s
20 μs/div	200 ns	0.8 s	6.4 s	3.2 s	25.6 s	6.4 s	51.2 s
50 μs/div	500 ns	2 s	16 s	8 s	1 min 04 s	16 s	2 min 08 s
100 μs/div	1 μs	4 s	32 s	16 s	2 min 08 s	32 s	4 min 16 s
200 μs/div	2 μs	8 s	1 min 04 s	32 s	4 min 16 s	1 min 04 s	8 min 32 s
500 μs/div	5 μs	20 s	2 min 40 s	1 min 20 s	10 min 40 s	2 min 40 s	21 min 20 s
1 ms/div	10 μs	40 s	5 min 20 s	2 min 40 s	21 min 20 s	5 min 20 s	42 min 40 s
2 ms/div	20 μs	1 min 20 s	10 min 40 s	5 min 20 s	42 min 40 s	10 min 40 s	1 h 25 min 20 s
5 ms/div	50 μs	3 min 20 s	26 min 40 s	13 min 20 s	1 h 46 min 40 s	26 min 40 s	3 h 33 min 20 s
10 ms/div	100 μs	6 min 40 s	53 min 20 s	26 min 40 s	3 h 33 min 20 s	53 min 20 s	7 h 06 min 40 s
20 ms/div	200 μs	13 min 20 s	1 h 46 min 40 s	53 min 20 s	7 h 06 min 40 s	1 h 46 min 40 s	14 h 13 min 20 s
50 ms/div	500 μs	33 min 20 s	4 h 26 min 40 s	2 h 13 min 20 s	17 h 46 min 40 s	4 h 26 min 40 s	35 h 33 min 20 s
100 ms/div	1 ms	1 h 06 min 40 s	8 h 53 min 20 s	4 h 26 min 40 s	1 d 11 h 33 min 20 s	8 h 53 min 20 s	2 d 23 h 06 min 40 s
200 ms/div	2 ms	2 h 13 min 20 s	17 h 46 min 40 s	8 h 53 min 20 s	2 d 23 h 06 min 40 s	17 h 46 min 40 s	5 d 22 h 13 min 20 s
500 ms/div	5 ms	5 h 33 min 20 s	1 d 20 h 26 min 40 s	22 h 13 min 20 s	7 d 09 h 46 min 40 s	44 h 26 min 40 s	14 d 19 h 33 min 20 s
1 s/div	10 ms	11 h 06 min 40 s	3 d 16 h 53 min 20 s	1 d 20 h 26 min 40 s	14 d 19 h 33 min 20 s	3 d 16 h 53 min 20 s	29 d 15 h 06 min 40 s
2 s/div	20 ms	22 h 13 min 20 s	7 d 09 h 46 min 40 s	3 d 16 h 53 min 20 s	29 d 15 h 06 min 40 s	7 d 09 h 46 min 40 s	59 d 06 h 13 min 20 s
5 s/div	50 ms	2 d 07 h 33 min 20 s	18 d 12 h 26 min 40 s	9 d 06 h 13 min 20 s	74 d 01 h 46 min 40 s	18 d 12 h 26 min 40 s	148 d 03 h 33 min 20 s
10 s/div	100 ms	4 d 15 h 06 min 40 s	37 d 00 h 53 min 20 s	18 d 12 h 06 min 40 s	148 d 03 h 33 min 20 s	37 d 00 h 53 min 20 s	296 d 07 h 06 min 40 s
30 s/div	300 ms	13 d 21 h 20 min 00 s	111 d 02 h 40 min 00 s	55 d 13 h 20 min 00 s	444 d 10 h 40 min 00 s	111 d 02 h 40 min 00 s	888 d 21 h 20 min 00 s
50 s/div	500 ms	23 d 03 h 33 min 20 s	185 d 04 h 26 min 40 s	92 d 14 h 13 min 20 s	740 d 17 h 46 min 40 s	185 d 04 h 26 min 40 s	"H"
1 min/div	600 ms	27 d 18 h 40 min 00 s	222 d 05 h 20 min 00 s	111 d 02 h 40 min 00 s	888 d 21 h 20 min 00 s	222 d 05 h 20 min 00 s	"H"
100 s/div	1.0 s	46 d 07 h 06 min 40 s	370 d 08 h 53 min 20 s	185 d 04 h 26 min 40 s	"H"	370 d 08 h 53 min 20 s	"H"
2 min/div	1.2 s	55 d 13 h 20 min 00 s	444 d 10 h 40 min 00 s	222 d 05 h 20 min 00 s	"H"	444 d 10 h 40 min 00 s	"H"
5 min/div	3.0 s	138 d 21 h 20 min 00 s	"H"	555 d 13 h 20 min 00 s	"H"	"H"	"H"

Notes

- The above table shows maximum values at arbitrary recording length settings.
- Saving to media in near real-time is possible at sampling speeds of 100 ms/div (1 msec sampling) or slower.
- Operation cannot be guaranteed for extended recording periods one year or longer. The above table represents theoretical values.

- Measurement Indices (Input units sold separately)

Measurement targets	With use input unit	Display range	Max. resolution
Voltage	ANALOG UNIT 8966	100 mV f.s. to 400 V f.s.	50 μV
	HIGH RESOLUTION UNIT 8968	100 mV f.s. to 400 V f.s.	3.125 μV
	DC/RMS UNIT 8972	100 mV f.s. to 400 V f.s.	50 μV
	HIGH-VOLTAGE UNIT U8974	4 V f.s. to 1000 V f.s.	0.125 mV
Current	CURRENT UNIT 8971 + optional current sensor	20 A f.s. or larger When driving current sensors with separate power supply, measurement can be conducted with voltage input units.	1 mA or larger
RMS AC voltage	DC/RMS UNIT 8972	100 mV f.s. to 400 V f.s.	50 μV
Temperature (Thermocouple input)	TEMP UNIT 8967	200°C (392°F) f.s. to 2000°C (3632°F) f.s. Note: Upper and lower limit values depend on the thermocouple	0.01°C (0.02°F)
Frequency, RPM	FREQ UNIT 8970	20 Hz f.s. to 100 kHz f.s. 2 (kr/min) f.s. to 2000 (kr/min) f.s.	2 mHz 0.2 (r/min)
Power supply frequency	FREQ UNIT 8970	40 to 60 Hz, 50 to 70 Hz, 390 to 410 Hz	0.01 Hz
Integration count	FREQ UNIT 8970	40 k-counts f.s. to 20 M-counts f.s.	1 count
Pulse duty ratio	FREQ UNIT 8970	100% f.s.	0.01%
Pulse width	FREQ UNIT 8970	0.01 s f.s. to 2 s f.s.	1 μs
Vibration stress	STRAIN UNIT 8969	400 μe f.s. to 20000 μe f.s.	0.016 μe
Relay contacts, voltage on/off	LOGIC UNIT 8973	—	—

Notes

- Each unit has two input channels, except Logic Unit.
- Besides logic units (16 channels), the MR8847A series comes standard with 16 logic inputs integrated in the device.

# Optional Specifications (sold separately)

Dimensions and mass: approx. 106 mm (4.17 in) W × 19.8 mm (0.78 in) H × 196.5 mm (7.74 in) D, approx. 250 g (8.8 oz)  
Accessories: None



<b>ANALOG UNIT 8966</b> (Accuracy at 23 ±5°C/73 ±9°F, 20 to 80% rh after 30 minutes of warm-up time and zero adjustment; Accuracy guaranteed for 1 year, Post-adjustment accuracy guaranteed for 1 year)	
Measurement functions	Number of channels: 2, for voltage measurement
Input terminals	Isolated BNC connector (input impedance 1 MΩ, input capacitance 30 pF), Max. rated voltage to ground: 300 V AC or DC (with input isolated from the main unit, the maximum voltage that can be applied between input channel and chassis, and between input channels without damage)
Measurement range	5 mV to 20 V/div, 12 ranges, full scale: 20 div, AC voltage for possible measurement/display using the memory function: 280 V rms, Low-pass filter: 5/50/500 Hz, 5 k/50 k/500 kHz
Measurement resolution	1/100 of range (using 12-bit A/D conversion)
Maximum sampling rate	20 MS/s (simultaneous sampling in 2 channels)
Measurement accuracy	±0.5% of full scale (with filter 5 Hz, zero position accuracy included)
Frequency characteristics	DC to 5 MHz -3 dB, (with AC coupling: 7 Hz to 5 MHz -3 dB)
Input coupling	AC/DC/GND
Maximum input voltage	400 V DC (maximum voltage that can be applied between input connectors without damage)

Dimensions and mass: approx. 106 mm (4.17 in) W × 19.8 mm (0.78 in) H × 204.5 mm (8.05 in) D, approx. 240 g (8.5 oz)  
Accessories: Ferrite clamp × 2



<b>TEMP UNIT 8967</b> (Accuracy at 23 ±5°C/73 ±9°F, 20 to 80% rh after 30 minutes of warm-up time and zero adjustment; Accuracy guaranteed for 1 year, Post-adjustment accuracy guaranteed for 1 year)	
Measurement functions	Number of channels: 2, for temperature measurement with thermocouple (voltage measurement not available)
Input terminals	Thermocouple input: plug-in connector, Recommended wire diameter: single-wire, 0.14 to 1.5 mm <sup>2</sup> , braided wire 0.14 to 1.0 mm <sup>2</sup> (conductor wire diameter min. 0.18 mm), AWG 26 to 16 Input impedance: min. 5 MΩ (with line fault detection ON/OFF), Max. rated voltage to ground: 300 V AC or DC (with input isolated from the main unit, the maximum voltage that can be applied between input channel and chassis, and between input channels without damage)
Temperature measurement range	10°C (50°F)/div (-100°C to 200°C (-148°F to 392°F)), 50°C (122°F)/div (-200°C to 1000°C (-328°F to 1832°F)), 100°C (212°F)/div (-200°C to 2000°C (-328°F to 3632°F)), 3 ranges, full scale: 20 div, Measurement resolution: 1/1000 of measurement range (using 16-bit A/D conversion)
Thermocouple range (JIS C 1602-1995) (ASTM E-988-96)	K: -200°C to 1350°C (-328°F to 2462°F), J: -200°C to 1100°C (-328°F to 2012°F), E: -200°C to 800°C (-328°F to 1472°F), T: -200°C to 400°C (-328°F to 752°F), N: -200°C to 1300°C (-328°F to 2372°F), R: 0°C to 1700°C (32°F to 3092°F), S: 0°C to 1700°C (32°F to 3092°F), B: 400°C to 1800°C (752°F to 3272°F), W (WRεS-26): 0°C to 2000°C (32°F to 3632°F), Reference junction compensation: internal/ external (switchable), Line fault detection ON/OFF possible
Data refresh rate	3 methods, Fast: 1.2 ms (digital filter OFF), Normal: 100 ms (digital filter 50/60 Hz), Slow: 500 ms (digital filter 10 Hz)
Measurement accuracy	Thermocouple K, J, E, T, N: ±0.1% of full scale ±1°C (±1.8°F) (±0.1% of full scale ±2°C (±3.6°F) at -200°C to 0°C (-328°F to 32°F)), Thermocouple R, S, B, W: ±0.1% of full scale ±3.5°C (±6.3°F) (at 0°C (32°F) to less than 400°C (752°F)); However, no accuracy guarantee of less than 400°C (752°F) for B, ±0.1% f.s. ±3°C (±5.4°F) (at 400°C (752°F) or more) Reference junction compensation accuracy: ±1.5°C (±2.7°F) (added to measurement accuracy with internal reference junction compensation)

Dimensions and mass: approx. 106 mm (4.17 in) W × 19.8 mm (0.78 in) H × 196.5 mm (7.74 in) D, approx. 250 g (8.8 oz)  
Accessories: None



<b>HIGH RESOLUTION UNIT 8968</b> (Accuracy at 23 ±5°C/73 ±9°F, 20 to 80% rh after 30 minutes of warm-up time and zero adjustment; Accuracy guaranteed for 1 year, Post-adjustment accuracy guaranteed for 1 year)	
Measurement functions	Number of channels: 2, for voltage measurement
Input terminals	Isolated BNC connector (input impedance 1 MΩ, input capacitance 30 pF), Max. rated voltage to ground: 300 V AC, DC (with input isolated from the unit, the maximum voltage that can be applied between input channel and chassis and between input channels without damage)
Measurement range	5 mV to 20 V/div, 12 ranges, full scale: 20 div, AC voltage for possible measurement/display using the memory function: 280 V rms, Low-pass filter: 5/50/500 Hz, 5k/50k Hz
Anti-aliasing filter	Integrated filter for suppressing aliasing distortion caused by FFT processing (automatic cutoff frequency setting/OFF)
Measurement resolution	1/1600 of measurement range (using 16-bit A/D conversion)
Maximum sampling rate	1 MS/s (simultaneous sampling in 2 channels)
Measurement accuracy	±0.3% of full scale (with filter 5 Hz, zero position accuracy included)
Frequency characteristics	DC to 100 kHz -3 dB (with AC coupling: 7 Hz to 100 kHz -3 dB)
Input coupling	AC/DC/GND
Maximum input voltage	400 V DC (maximum voltage that can be applied between input connectors without damage)

Dimensions and mass: approx. 106 mm (4.17 in) W × 19.8 mm (0.78 in) H × 196.5 mm (7.74 in) D, approx. 220 g (7.8 oz)  
Accessories: Conversion cable 9769 × 2 (cable length 50 cm/1.64 ft)



<b>STRAIN UNIT 8969</b> (Accuracy at 23 ±5°C/73 ±9°F, 20 to 80% rh after 30 minutes of warm-up time and auto-balance, Accuracy guaranteed for 1 year, Post-adjustment accuracy guaranteed for 1 year)	
Measurement functions	Number of channels: 2, for distortion measurement (electronic auto-balancing, balance adjustment range within ±10 000 μe or less)
Input terminals	Weidmuller SL 3.5/7/90G (via Conversion Cable 9769, TAJIMI PRC03-12A10-7M10.5) Max. rated voltage to ground: 33 V rms or 70 V DC (with input isolated from the unit, the maximum voltage that can be applied between input channel and chassis and between input channels without damage)
Suitable transducer	Strain gauge converter, Bridge impedance: 120 Ω to 1 kΩ, Bridge voltage: 2 V ±0.05 V, Gauge rate: 2.0
Measurement range	20 μe to 1000 μe/div, 6 ranges, full scale: 20 div, Low-pass filter: 5/10/100 Hz, 1 kHz
Measurement resolution	1/1250 of measurement range (using 16-bit A/D conversion)
Maximum sampling rate	200 kS/s (simultaneous sampling across 2 channels)
Measurement accuracy After auto-balancing	±(0.5% f.s. +4 μe) (5 Hz filter ON)
Frequency characteristics	DC to 20 kHz +1/-3 dB

Dimensions and mass: approx. 106 mm (4.17 in) W × 19.8 mm (0.78 in) H × 196.5 mm (7.74 in) D, approx. 250 g (8.8 oz)  
Accessories: None



<b>FREQ UNIT 8970</b> (Accuracy at 23 ±5°C/73 ±9°F, 20 to 80% rh after 30 minutes of warm-up time; Accuracy guaranteed for 1 year, Post-adjustment accuracy guaranteed for 1 year)	
Measurement functions	Number of channels: 2, for voltage input based frequency measurement, rotation, power frequency, integration, pulse duty ratio, pulse width
Input terminals	Isolated BNC connector (input impedance 1 MΩ, input capacitance 30 pF), Max. rated voltage to ground: 300 V AC or DC (with input isolated from the main unit, the maximum voltage that can be applied between input channel and chassis, and between input channels without damage)
Frequency mode	Range: Between DC to 100 kHz (minimum pulse width 2 μs), 1 Hz/div to 5 kHz/div (full scale = 20 div), 8 settings Accuracy: ±0.1% f.s. (exclude 5 kHz/div), ±0.7% f.s. (at 5 kHz/div)
Rotation mode	Range: Between 0 to 2 million rotations/minute (minimum pulse width 2 μs), 100 (r/min)/div to 100 k (r/min)/div (full scale = 20 div), 7 settings Accuracy: ±0.1% f.s. (excluding 100 k (r/min)/div), ±0.7% f.s. (at 100 k (r/min)/div)
Power frequency mode	Range: 50 Hz (40 to 60 Hz), 60 Hz (50 to 70 Hz), 400 Hz (390 to 410 Hz) (full scale = 20 div), 3 settings Accuracy: ±0.03 Hz (50, 60 Hz), ±0.1 Hz (400 Hz range)
Integration mode	Range: 2 k counts/div to 1 M counts/div, 6 settings Accuracy: ±range/2000
Duty ratio mode	Range: Between 10 Hz to 100 kHz (minimum pulse width 2 μs), 5%/div (full scale = 20 div) Accuracy: ±1% (10 Hz to 10 kHz), ±4% (10 kHz to 100 kHz)
Pulse width mode	Range: Between 2 μs to 2 sec, 500 μs/div to 100 ms/div (full scale = 20 div), Accuracy: ±0.1% f.s.
Measurement resolution	1/2000 of range (Integration mode), 1/500 of range (exclude integration, power frequency mode), 1/100 of range (power frequency mode)
Input voltage range and threshold level	±10 V to ±400 V, 6 settings, selectable threshold level at each range
Other functions	Slope, Level, Hold, Smoothing, Low-pass filter, Switchable DC/AC input coupling, Frequency dividing, Integration over-range keep/return

Dimensions and mass: approx. 106 mm (4.17 in) W × 19.8 mm (0.78 in) H × 196.5 mm (7.74 in) D, approx. 250 g (8.8 oz)  
Accessories: CONVERSION CABLE 9318 × 2 (To connect the current sensor to the 8971)



<b>CURRENT UNIT 8971</b> (Accuracy at 23 ±5°C/73 ±9°F, 20 to 80% rh after 30 minutes of warm-up time and zero adjustment; Accuracy guaranteed for 1 year, Post-adjustment accuracy guaranteed for 1 year)	
Measurement functions	Number of channels: 2, Current measurement with optional current sensor,
Input terminals	Sensor connector (input impedance 1 MΩ, exclusive connector for current sensor via conversion cable the 9318, common GND with recorder)
Compatible current sensors	CT6863, CT6862, 9709, CT6841, CT6843, CT6844, CT6845, 9272-10 (To connect the 8971 via conversion cable the 9318)
Measurement range	Using 9272-10 (20 A), CT6841: 100 mA to 5 A/div (f.s. = 20 div, 6 settings) Using CT6862: 200 mA to 10 A/div (f.s. = 20 div, 6 settings) Using 9272-10 (200 A), CT6843, CT6863: 1 A to 50 A/div (f.s. = 20 div, 6 settings) Using CT6844, CT6845, 9709: 2 A to 100 A/div (f.s. = 20 div, 6 settings)
Measurement accuracy (with 5 Hz filter ON)	±0.65% f.s. RMS amplitude accuracy: ±1% f.s. (DC, 30 Hz to 1 kHz), ±3% f.s. (1 kHz to 10 kHz) RMS response time: 100 ms (rise time from 0 to 90% of full scale), Crest factor: 2
Note: Add the accuracy and attributes of the current sensor being used.	Frequency characteristics: DC to 100 kHz, ±3 dB (with AC coupling: 7 Hz to 100 kHz)
Measurement resolution	1/100 of range (using 12-bit A/D conversion)
Maximum sampling rate	1 MS/s (simultaneous sampling in 2 channels)
Other functions	Input coupling: AC/DC/GND, Low-pass filter: 5, 50, 500, 5 k, 50 kHz

Dimensions and mass: approx. 106 mm (4.17 in) W × 19.8 mm (0.78 in) H × 196.5 mm (7.74 in) D, approx. 250 g (8.8 oz)  
Accessories: None



<b>DC/RMS UNIT 8972</b> (Accuracy at 23 ±5°C/73 ±9°F, 20 to 80% rh after 30 minutes of warm-up time and zero adjustment; Accuracy guaranteed for 1 year, Post-adjustment accuracy guaranteed for 1 year)	
Measurement functions	Number of channels: 2, for voltage measurement, DC/RMS selectable
Input terminals	Isolated BNC connector (input impedance 1 MΩ, input capacitance 30 pF), Max. rated voltage to ground: 300 V AC or DC (with input isolated from the main unit, the maximum voltage that can be applied between input channel and chassis, and between input channels without damage)
Measurement range	5 mV to 20 V/div, 12 ranges, full scale: 20 div, AC voltage for possible measurement/display using the memory function: 280 V rms, Low-pass filter: 5/50/500 Hz, 5 k/100 kHz
Measurement resolution	1/100 of range (using 12-bit A/D conversion)
Maximum sampling rate	1 MS/s (simultaneous sampling in 2 channels)
Measurement accuracy	±0.5% of full scale (with filter 5 Hz, zero position accuracy included)
RMS measurement	RMS amplitude accuracy: ±1% f.s. (DC, 30 Hz to 1 kHz), ±3% of full scale (1 kHz to 100 kHz) Response time: SLOW 5 s (rise time from 0 to 90% of full scale), MID 800 ms (rise time from 0 to 90% of full scale), FAST 100 ms (rise time from 0 to 90% of full scale), Crest factor: 2
Frequency characteristics	DC to 400 kHz -3 dB, (with AC coupling: 7 Hz to 400 kHz -3 dB)
Input coupling	AC/DC/GND
Maximum input voltage	400 V DC (maximum voltage that can be applied between input connectors without damage)

Dimensions and mass: approx. 106 mm (4.17 in) W × 19.8 mm (0.78 in) H × 196.5 mm (7.74 in) D, approx. 190 g (6.7 oz)  
Accessories: None



<b>LOGIC UNIT 8973</b>	
Measurement functions	Number of channels: 16 channels (4 ch/1 probe connector × 4 connectors)
Input terminals	Mini DIN connector (for HIOKI logic probes only), Compatible logic probes: 9320-01, 9327, MR9321-01



NEW

Dimensions and mass: approx. 106 mm (4.17 in) W × 19.8 mm (0.78 in) H × 196.5 mm (7.74 in) D, approx. 260 g (9.2 oz)  
Accessories: None



DIGITAL VOLTMETER UNIT MR8990 <small>(Accuracy at 23 ±5°C/73 ±9°F, 20 to 80% rh after 30 minutes of warm-up time and calibration, Accuracy guaranteed for 1 year, Post-adjustment accuracy guaranteed for 1 year)</small>	
Measurement functions	Number of channels: 2, for DC voltage measurement
Input terminals	Banana input connectors (Input resistance: 100 MΩ or higher with 100 mV f.s. to 10 V f.s. range, otherwise 10 MΩ) Max. rated voltage to ground: 300 V AC or DC (with input isolated from the main unit, the maximum voltage that can be applied between input channel and chassis, and between input channels without damage)
Measurement range	100 mV f.s. (5 mV/div) to 1000 V f.s. (50 V/div), 5 ranges, full scale: 20 div
Measurement resolution	1/50 000 of measurement range (using 24 bit ΔΣ modulation A/D)
Integration time	20 ms ×NPLC (during 50 Hz), 16.67 ms ×NPLC (during 60 Hz)
Response time	2 ms + 2 × integration time or less (rise - f.s. → + f.s., fall + f.s. → - f.s.)
Basic measurement accuracy	±0.01% rdg. ±0.0025% f.s. (at range of 1000 mV f.s.)
Maximum input voltage	500 V DC (maximum voltage that can be applied between input connectors without damage)

Note: Cannot use with legacy models of the 8847 or MR8847

NEW

Dimensions and mass: approx. 106 mm (4.17 in) W × 19.8 mm (0.78 in) H × 196.5 mm (7.74 in) D, approx. 230 g (8.1 oz)  
Accessories: None

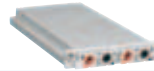

HIGH-VOLTAGE UNIT U8974 <small>(Accuracy at 23 ±5°C/73 ±9°F, 20 to 80% rh after 30 minutes of warm-up time and zero adjustment, Accuracy guaranteed for 1 year, Post-adjustment accuracy guaranteed for 1 year)</small>	
Measurement functions	Number of channels: 2, for voltage measurement, DC/RMS selectable Maximum rated voltage to ground: 1000 V AC or DC (CAT III), 600 V AC or DC (CAT IV)
Input terminals	Banana input terminal (Input impedance: 4 MΩ, Input capacitance: 5 pF)
Measurement range	200 mV, 500 mV, 1, 2, 5, 10, 20, 50 V/div (DC mode) 500 mV, 1, 2, 5, 10, 20, 50 V/div (RMS mode)
Measurement resolution	1/1600 of measurement range (using 16-bit A/D conversion)
Maximum sampling rate	1 MS/s
Measurement accuracy	±0.25% f.s. (with filter 5 Hz, zero position accuracy included)
RMS measurement	RMS accuracy: ±1.5% f.s. (DC, 30 Hz to 1 kHz), ±3% f.s. (1 kHz to 100 kHz) Response time: High speed 150 ms, Medium speed 500 ms, Low speed 2.5 s
Frequency characteristics	DC to 100 kHz -3 dB
Input coupling	DC / GND
Maximum input voltage	1000 V DC, 700 V AC

NEW

Dimensions and mass: approx. 106 mm (4.17 in) W × 19.8 mm (0.78 in) H × 196.5 mm (7.74 in) D, approx. 250 g (8.8 oz)  
Accessories: None



ARBITRARY WAVEFORM GENERATOR UNIT U8793 <small>(Accuracy at 23 ±5°C/73 ±9°F, 80% rh or less after 30 minutes or more of warm-up time, Power supply frequency range of installed MEMORY HiCORDER at 50 Hz/60 Hz ±2 Hz, Accuracy guaranteed for 1 year, Post-adjustment accuracy guaranteed for 1 year)</small>	
Output terminal	Number of channels: 2, SMB terminal (Output impedance: 1 Ω or less) Max. rated voltage to ground: 33 V rms AC or 70 V DC
Output voltage range	-10 V to 15 V (Amplitude setting range: 0 V to 20 V p-p, Setting resolution: 1 mV)
Max. output current	10 mA (Allowable load resistance: 1.5 kΩ or more)
FG function	DC, Sine wave, Square wave, Pulse wave, Triangular wave, Ramp wave, Output frequency: 0 Hz to 100 kHz
Arbitrary waveform generator mode	Waveforms measured by MR8847A, etc., generated by Hioki Model 7075 or SF8000, CSV waveforms D/A refresh rate: 2 MHz (using 16-bit D/A)
Sweep function	Frequency, Amplitude, Offset, Duty (Pulse only)
Program function	Max. 128 steps (Number of loops for each step, Number of total loops)
Other	Self-test function (Voltage), External input/output control

Note: Cannot use with legacy models of the 8847 or MR8847

NEW

Dimensions and mass: approx. 106 mm (4.17 in) W × 19.8 mm (0.78 in) H × 196.5 mm (7.74 in) D, approx. 230 g (8.1 oz)  
Accessories: None



WAVEFORM GENERATOR UNIT MR8790 <small>(Accuracy at 23 ±5°C/73 ±9°F, 80% rh after 30 minutes of warm-up time, Accuracy guaranteed for 1 year, Post-adjustment accuracy guaranteed for 1 year)</small>	
Output terminal	Number of channels: 4, SMB terminal (Output impedance: 1 Ω or less) Max. rated voltage to ground: 33 V rms AC or 70 V DC
Output voltage range	-10 V to 10 V (Amplitude setting range: 0 V to 20 V p-p, Setting resolution: 1 mV)
Max. output current	5 mA
Output function	DC, Sine wave (Output frequency range: 0 Hz to 20 kHz)
Accuracy	Amplitude accuracy: ±0.25% of setting ±2 mV p-p (1 Hz to 10 kHz) Offset accuracy: ±3 mV DC output accuracy: ±0.6 mV
Other	Self-test function (Voltage, Current)

Note: Cannot use with legacy models of the 8847 or MR8847

NEW

Dimensions and mass: approx. 106 mm (4.17 in) W × 19.8 mm (0.78 in) H × 196.5 mm (7.74 in) D, approx. 230 g (8.1 oz)  
Accessories: None



PULSE GENERATOR UNIT MR8791 <small>(Accuracy at 23 ±5°C/73 ±9°F, 80% rh or less with no condensation, Accuracy guaranteed for 1 year)</small>	
Output terminal	Number of channels: 8, Connector: D-sub, half-pitch, 50-pin Max. rated voltage to ground: 33 V rms AC or 70 V DC (between unit and output channels) Logic output/Open collector output
Output mode 1	Pattern output: Read frequency: 0 Hz to 120 kHz, 2048 logic patterns Pulse output: Frequency 0 Hz to 20 kHz, Duty 0.1% to 99.9%
Output mode 2	Logic output: Output voltage level: 0 V to 5 V (H level: 3.8 V or more, L level: 0.8 V or less) Open collector output: Absolute maximum rated voltage for collector/emitter: 50 V Overcurrent protection: 100 mA
Other	Self-test function

Note: Cannot use with legacy models of the 8847 or MR8847

Cable length and mass: Input side: 70 cm (2.30 ft), Output side: 1.5 m (4.92 ft), Approx. 170 g (6.0 oz)



DIFFERENTIAL PROBE P9000 <small>(Accuracy guaranteed for 1 year, Post-adjustment accuracy guaranteed for 1 year)</small>	
Measurement modes	P9000-01: For waveform monitor output, Frequency characteristics: DC to 100 kHz -3 dB P9000-02: Switches between waveform monitor output/AC effective value output Wave mode frequency characteristics: DC to 100 kHz -3 dB, RMS mode frequency characteristics: 30 Hz to 10 kHz, Response time: Rise 300 ms, Fall 600 ms
Division ratio	Switches between 1000:1, 100:1
DC output accuracy	±0.5% f.s. (f.s. = 1.0 V, division ratio 1000:1), (f.s. = 3.5 V, division ratio 100:1)
Effective value measurement accuracy	±1% f.s. (30 Hz to less than 1 kHz, sine wave), ±3% f.s. (1 kHz to 10 kHz, sine wave)
Input resistance/capacity	H-L: 10.5 MΩ, 5 pF or less (At 100 kHz)
Maximum input voltage	1000 V AC, DC
Maximum rated voltage to ground	1000 V AC, DC (CAT III)
Operating temperature range	-40°C to 80°C (-40°F to 176°F)
Power supply	(1) AC adapter Z1008 (100 to 240 V AC, 50/60 Hz), 6 VA (including AC adapter), 0.9 VA (main unit only) (2) USB bus power (5 V DC, USB micro-B connector), 0.8 VA (3) External power source 2.7 V to 15 V DC, 1 VA
Accessories	Instruction manual ×1, Alligator clip ×2, Carrying case ×1

Cable length and mass: Main unit cable 1.3 m (4.27 ft), input section cable 46 cm (1.51 ft), approx. 350 g (12.3 oz)



DIFFERENTIAL PROBE 9322 <small>(Accuracy guaranteed for 1 year)</small>	
Functions	For high-voltage floating measurement, power line surge noise detection, RMS rectified output measurement
DC mode	For waveform monitor output, Frequency characteristics: DC to 10 MHz (±3 dB), Amplitude accuracy: ±1% of full scale (at max. 1000 V DC), ±3% of full scale (at max. 2000 V DC) (full scale: 2000 V DC)
AC mode	For detection of power line surge noise, Frequency characteristics: 1 kHz to 10 MHz ±3 dB
RMS mode	DC/AC voltage RMS output detection, Frequency characteristics: DC, 40 Hz to 100 kHz, Response speed: 200 ms or less (400 V AC), Accuracy: ±1% of full scale (DC, 40 Hz to 1 kHz), ±4% of full scale (1 kHz to 100 kHz) (full scale: 1000 V AC)
Input	Input type: balanced differential input, Input impedance/capacitance: H-L 9 MΩ/10 pF, H/L-unit 4.5 MΩ/20 pF Max. rated voltage to ground: when using grabber clip 1500 V AC/DC (CAT II), 600 V AC/DC (CAT III), when using alligator clip: 1000 V AC/DC (CAT II), 600 V AC/DC (CAT III)
Maximum input voltage	2000 V DC, 1000 V AC (CAT II), 600 V AC/DC (CAT III)
Output	Voltage divider for 1/1000 of input, BNC connectors (output switchable for 3 modes DC, AC, RMS)
Power supply	Any of the following: (1) AC Adapter 9418-15, (2) Power Cord 9248 with Probe Power Unit 9687, (3) Power Cord 9324 + Conversion Cable 9323 with HiCORDER logic terminal, (4) Power Cord 9325 with F/V Unit 8940

Cable length and mass: Main unit cable 1.5 m (4.92 ft), input section cable 30 cm (0.98 ft), approx. 150 g (5.3 oz)

Note: The unit-side plug of the 9320-01 and 9327 is different from the 9320.



LOGIC PROBE 9320-01/9327	
Functions	Detection of voltage signal or relay contact signal for High/Low state recording
Input	4 channels (common ground between unit and channels), digital/contact input, switchable (contact input can detect open-collector signals) Input resistance: 1 MΩ (with digital input, 0 to +5 V) 500 kΩ or more (with digital input, +5 to +50 V) Pull-up resistance: 2 kΩ (contact input: internally pulled up to +5 V)
Digital input threshold	1.4 V / 2.5 V / 4.0 V
Contact input detection resistance	1.4 V: 1.5 kΩ or higher (open) and 500 Ω or lower (short) 2.5 V: 3.5 kΩ or higher (open) and 1.5 kΩ or lower (short) 4.0 V: 25 kΩ or higher (open) and 8 kΩ or lower (short)
Response speed	9320-01: 500 ns or lower, 9327: detectable pulse width 100 ns or higher
Maximum input voltage	0 to +50 V DC (the maximum voltage that can be applied across input pins without damage)

Cable length and mass: Main unit cable 1.5 m (4.92 ft), input section cable 1 m (3.28 ft), approx. 320 g (11.3 oz)

Note: The unit-side plug of the MR9321-01 is different from the MR9321.



LOGIC PROBE MR9321-01	
Functions	Detection of AC or DC relay drive signal for High/Low state recording Can also be used for power line interruption detection
Input	4 channels (isolated between unit and channels), HIGH/LOW range switching Input resistance: 100 kΩ or higher (HIGH range), 30 kΩ or higher (LOW range)
Output (H) detection	170 to 250 V AC, ±DC 70 to 250 V (HIGH range) 60 to 150 V AC, ±DC 20 to 150 V (LOW range)
Output (L) detection	0 to 30 V AC, ±DC 0 to 43 V (HIGH range) 0 to 10 V AC, ±DC 0 to 15 V (LOW range)
Response time	Rising edge 1 ms max., falling edge 3 ms max. (with HIGH range at 200 V DC, LOW range at 100 V DC)
Maximum input voltage	250 V rms (HIGH range), 150 V rms (LOW range) (the maximum voltage that can be applied across input pins without damage)

# System Chart of Options

**Model : MEMORY HiCORDER MR8847A**

Model Name (Order Code) (Note)

MR8847-51	(MR8847A, 64MW memory, main unit only)
MR8847-52	(MR8847A, 256MW memory, main unit only)
MR8847-53	(MR8847A, 512MW memory, main unit only)

*\*Cannot operate alone. You must install other options*

**NEW**



Note: Main unit MR8847A cannot operate alone. You must install one or more optional input modules in the unit.

**Power supply unit** \* Manufacturing option that must be specified upon order.



**DC POWER UNIT 9784**  
Factory-installed option - not user installable, built in on the bottom case. 10 to 28 V DC drive.

**Storage media** \* SSD is a built-in option that must be specified upon order. \* The CF card includes a PC card adapter.

**NEW** **SSD UNIT U8331**  
Specified upon order; built-in type, 128 GB

\* CF Card Precaution  
Use only CF Cards sold by HIOKI. Compatibility and performance are not guaranteed for CF cards made by other manufacturers. You may be unable to read from or save data to such cards.



**PC CARD 2G 9830**  
(2 GB)

**PC CARD 1G 9729**  
(1 GB)

**PC CARD 512M 9728**  
(512 MB)

**PC Software**



**WAVE PROCESSOR 9335**  
Convert data, print and display waveforms



**LAN COMMUNICATOR 9333**  
• Waveform data collect function  
• Remote control with the PC



**iPad App for MEMORY HiCORDER HMR Terminal**  
Download from the App Store (exclusively for Apple iPad)



**LAN CABLE 9642**  
Straight Ethernet cable, supplied with straight to cross conversion cable, 5 m (16.41 ft) length

**Printer options**



**RECORDING PAPER 9231**  
A4 width 216 mm (8.50 in) x 30 mm (98.43 ft), 6 rolls/set

**Case**



**CARRYING CASE 9783**  
Hard trunk type to protect unit during transport

**Input modules** \* Input cords not included. Please purchase them separately. \* When using 9709 with Current Unit 8971, a total of 7 current probes can be used.



**ANALOG UNIT 8966**  
2 ch, Voltage input, DC to 5 MHz bandwidth



**TEMP UNIT 8967**  
2 ch, thermocouple temperature input



**HIGH RESOLUTION UNIT 8968**  
2 ch, voltage input, DC to 100 kHz bandwidth



**STRAIN UNIT 8969**  
2 ch, strain gauge type converter amp  
**Conversion Cable 9769**  
(For and bundled with the strain unit)



**FREQ UNIT 8970**  
2 ch, for measurement of frequency, RPM, pulse, etc.



**CURRENT UNIT 8971**  
2 ch, for measuring current using dedicated current sensors, bundled two Conversion cable 9318  
Note: Max. up to 4 modules can be installed in the MR8847A, MR8827



**DC/RMS UNIT 8972**  
2 ch, voltage/DC to 400 kHz, RMS rectifier, DC and 30 to 100 kHz bandwidth



**LOGIC UNIT 8973**  
4 terminals, 16 ch  
Note: Max. up to 3 modules can be installed in the MR8847A



**NEW** **DIGITAL VOLTMETER UNIT MR8990**  
2ch, high-precision DC V, 0.1  $\mu$ V resolution, maximum sampling rate 500 times/s



**NEW** **HIGH-VOLTAGE UNIT U8974**  
2ch, voltage input, max. 1000 V DC and 700 V AC

**Output modules** \* Input cords not included. Please purchase separately.



**NEW** **WAVEFORM GENERATOR UNIT MR8790**  
4ch, DC Output:  $\pm$ 10 V, Sine wave output: 10 mHz to 20 kHz



**NEW** **PULSE GENERATOR UNIT MR8791**  
8ch, Pulse output: 0.1 Hz to 20 kHz, Pattern output



**NEW** **ARBITRARY WAVEFORM GENERATOR UNIT U8793**  
2ch, 10 mHz to 100 kHz function generator, arbitrary waveform generator with 2 MHz D/A refresh rate, -10 V to 15 V output

**Output cable** \* Please contact your local HIOKI distributor for connectors that support Model MR8791.





**NEW** **CONNECTION CABLE L9795-01**  
Maximum rated voltage to ground: 33 V AC rms or 70 V DC, SMB terminal - alligator clip, Cord length: 1.5 m (4.92 ft)





**NEW** **CONNECTION CABLE L9795-02**  
Maximum rated voltage to ground: 33 V AC rms or 70 V DC, SMB terminal - BNC terminal, Cord length: 1.5 m (4.92 ft)

**Logic signal measurement**



**LOGIC PROBE 9327**   
4-channel type, for voltage/contact signal ON/OFF detection (response pulse width 100 ns or more, miniature terminal type)



**LOGIC PROBE MR9321-01**   
4 isolated channels, ON/OFF detection of AC/DC voltage (miniature terminal type)



**LOGIC PROBE 9320-01**  
4-channel type, for voltage/contact signal ON/OFF detection (response pulse width 500 ns or more, miniature terminal type)



**CONVERSION CABLE 9323**  
\* Used for connecting the 9320/9321/MR9321 and the 9324 to the Memory HiCorder with small logic terminal models \* This cable is not required for the small-terminal types 9327, 9320-01, 9321-01 and MR9321-01.

**INPUT CORD (A)** \* Voltage is limited to the specifications of the input modules in use



**CONNECTION CORD L9790**  
Flexible  $\phi$  4.1 mm (0.16 in) thin dia. cable allowing for up to 600 V input, 1.8 m (5.91 ft) length \* The end clip is sold separately.

**ALLIGATOR CLIP L9790-01**  
Red/black set attaches to the ends of the cables L9790

**GRABBER CLIP 9790-02**  
Red/black set attaches to the ends of the cables L9790 \* When this clip is attached to the end of the L9790, input is limited to CAT II 300 V. Red/black set.

**CONTACT PIN 9790-03**  
Red/black set attaches to the ends of the cables L9790

**INPUT CORD (B)** \* Voltage is limited to the specifications of the input modules in use



**CONNECTION CORD L9198**  
 $\phi$  5.0 mm (0.20 in) dia., cable allowing for up to 300 V input, 1.7 m (5.58 ft) length, small alligator clip

**CONNECTION CORD L9197**  
 $\phi$  5.0 mm (0.20 in) dia., cable allowing for up to 600 V input, 1.8 m (5.91 ft) length, detachable large alligator clips are bundled

**GRABBER CLIP 9243**  
Attaches to the tip of the banana plug cable, CAT III 1000 V, 196 mm (7.72 in) length

**INPUT CORD (C)** \* This probe does not expand the maximum rated voltage above ground of an isolated input.



**10:1 PROBE 9665**  
Max. rated voltage to earth is same as for input module, max. input voltage 1 kV rms (up to 500 kHz), 1.5 m (4.92 ft) length

**10:1 PROBE 9666**  
Max. rated voltage to earth is same as for input module, max. input voltage 5 kV peak (up to 1MHz), 1.5 m (4.92 ft) length

**INPUT CORD (D)** \* Voltage to ground is within this product's specifications, separate power source is also required.



**DIFFERENTIAL PROBE P9000-01**  
(Wave Only) For Memory HiCorder, 1 kV AC, DC, Frequency band: 100 kHz

**DIFFERENTIAL PROBE P9000-02**  
(Switch between Wave/RMS) For Memory HiCorder, 1 kV AC, DC, Frequency band: 100 kHz

**AC ADAPTER Z1008**  
100 to 240 V AC

**INPUT CORD (E)** \* Voltage to ground is within this product's specifications, separate power source is also required.



**DIFFERENTIAL PROBE 9322**  
1 kV AC, 2 kV DC, Frequency band: 10 MHz

**AC ADAPTER 9418-15**  
100 to 240 V AC

**INPUT CORD (F)** \* Voltage input via banana terminals limited by the voltage specifications of the respective input unit.



**CONNECTION CABLE L4940**  
Banana plug - banana plug, Cord length: 1.5 m (4.92 ft)

**EXTENSION CABLE L4931**  
Extend the length of banana plug cables, Cable length: 1.5 m (4.92 ft)

**ALLIGATOR CLIP L4935**  
Attach to the tip of banana plug cables, CAT IV 600 V, CAT III 1000 V

**BUS BAR CLIP L4936**  
Attach to the tip of banana plug cables, CAT III 600 V

**MAGNETIC ADAPTER L4937**  
Attach to the tip of banana plug cables, CAT III 1000 V

**GRABBER CLIP 9243**  
Attach to the tip of banana plug cables, red/black set, full length: 196mm (7.72 in), CAT III 1000 V

**INPUT CORD (G)** \*For the MR8990 \*Voltage is limited to the specifications of the input modules in use



**TEST LEAD L2200**  
Cable length: 70 cm, tips interchangeable with a pin test lead or alligator clip, maximum input voltage: CAT IV 600 V, CAT III 1000 V

\* You can connect up to 4 Current Unit 8971 to the Memory HiCorder main unit, allowing up to 8 current sensors to be used.  
\* There is no limit if you connect a current sensor to the voltage input analog unit.

**Up to 200 A (High precision)**

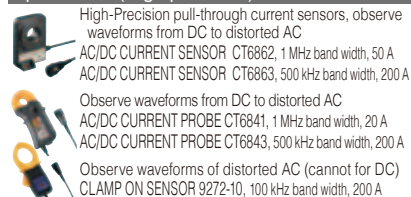

High-Precision pull-through current sensors, observe waveforms from DC to distorted AC  
**AC/DC CURRENT SENSOR CT6862**, 1 MHz band width, 50 A  
**AC/DC CURRENT SENSOR CT6863**, 500 kHz band width, 200 A

Observe waveforms from DC to distorted AC  
**AC/DC CURRENT PROBE CT6841**, 1 MHz band width, 20 A  
**AC/DC CURRENT PROBE CT6843**, 500 kHz band width, 200 A

Observe waveforms of distorted AC (cannot for DC)  
**CLAMP ON SENSOR 9272-10**, 100 kHz band width, 200 A

**Up to 1000 A (High precision)**

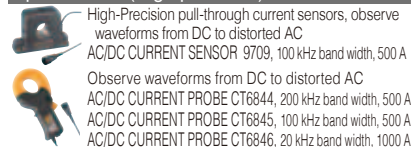

High-Precision pull-through current sensors, observe waveforms from DC to distorted AC  
**AC/DC CURRENT SENSOR 9709**, 100 kHz band width, 500 A

Observe waveforms from DC to distorted AC  
**AC/DC CURRENT PROBE CT6844**, 200 kHz band width, 500 A  
**AC/DC CURRENT PROBE CT6845**, 100 kHz band width, 500 A  
**AC/DC CURRENT PROBE CT6846**, 20 kHz band width, 1000 A

**Power supply** \* Not necessary when using Current Unit 8971.

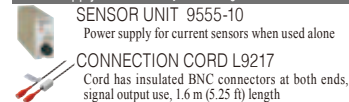

**SENSOR UNIT 9555-10**  
Power supply for current sensors when used alone

**CONNECTION CORD L9217**  
Cord has insulated BNC connectors at both ends, signal output use, 1.6 m (5.25 ft) length

**10 mA class to 500 A (High speed)**

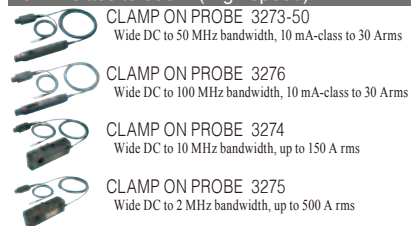

**CLAMP ON PROBE 3273-50**  
Wide DC to 50 MHz bandwidth, 10 mA-class to 30 Arms

**CLAMP ON PROBE 3276**  
Wide DC to 100 MHz bandwidth, 10 mA-class to 30 Arms

**CLAMP ON PROBE 3274**  
Wide DC to 10 MHz bandwidth, up to 150 A rms

**CLAMP ON PROBE 3275**  
Wide DC to 2 MHz bandwidth, up to 500 A rms

**Power supply** \* Necessary for use high speed current probes

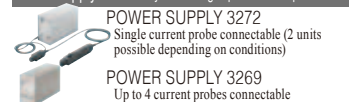

**POWER SUPPLY 3272**  
Single current probe connectable (2 units possible depending on conditions)

**POWER SUPPLY 3269**  
Up to 4 current probes connectable

**100 A to 2000 A (Medium speed) A**

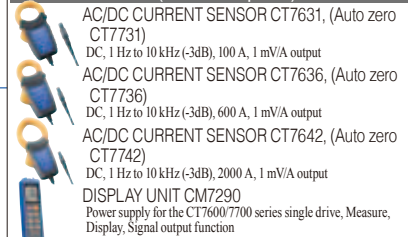

**AC/DC CURRENT SENSOR CT7631**, (Auto zero CT7731)  
DC, 1 Hz to 10 kHz (-3dB), 100 A, 1 mV/A output

**AC/DC CURRENT SENSOR CT7636**, (Auto zero CT7736)  
DC, 1 Hz to 10 kHz (-3dB), 600 A, 1 mV/A output

**AC/DC CURRENT SENSOR CT7642**, (Auto zero CT7742)  
DC, 1 Hz to 10 kHz (-3dB), 2000 A, 1 mV/A output

**DISPLAY UNIT CM7290**  
Power supply for the CT7600/7700 series single drive, Measure, Display, Signal output function

**100 A to 2000 A (Medium speed) B**

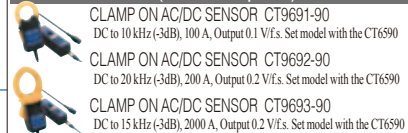

**CLAMP ON AC/DC SENSOR CT9691-90**  
DC to 10 kHz (-3dB), 100 A, Output 0.1 V/Es. Set model with the CT6590

**CLAMP ON AC/DC SENSOR CT9692-90**  
DC to 20 kHz (-3dB), 200 A, Output 0.2 V/Es. Set model with the CT6590

**CLAMP ON AC/DC SENSOR CT9693-90**  
DC to 15 kHz (-3dB), 2000 A, Output 0.2 V/Es. Set model with the CT6590

**500 A to 5000 A \*For commercial power lines, 50/60 Hz**

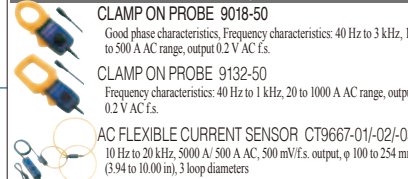

**CLAMP ON PROBE 9018-50**  
Good phase characteristics, Frequency characteristics: 40 Hz to 3 kHz, 10 to 500 A AC range, output 0.2 V AC f.s.

**CLAMP ON PROBE 9132-50**  
Frequency characteristics: 40 Hz to 1 kHz, 20 to 1000 A AC range, output 0.2 V AC f.s.

**AC FLEXIBLE CURRENT SENSOR CT9667-01/-02/-03**  
10 Hz to 20 kHz, 5000 A/ 500 A AC, 500 mV/Es. output,  $\phi$  100 to 254 mm (3.94 to 10.00 in), 3 loop diameters

**LEAK CURRENT \*For commercial power lines, 50/60 Hz**

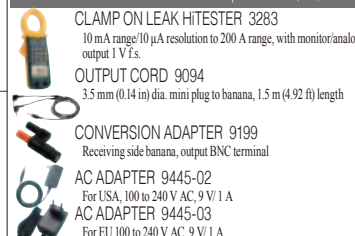

**CLAMP ON LEAK HITESTER 3283**  
10 mA range/10  $\mu$ A resolution to 200 A range, with monitor/analog output 1 V/Es.

**OUTPUT CORD 9094**  
3.5 mm (0.14 in) dia. mini plug to banana, 1.5 m (4.92 ft) length

**CONVERSION ADAPTER 9199**  
Receiving side banana, output BNC terminal

**AC ADAPTER 9445-02**  
For USA, 100 to 240 V AC, 9 W/1 A

**AC ADAPTER 9445-03**  
For EU 100 to 240 V AC, 9 W/1 A

**Custom cable** \*For P9000. Inquire with your local Hioki distributor.

- (1) Bus powered USB cable
- (2) USB(A)- Micro B cable
- (3) 3-prong cable

**Other options for Input**

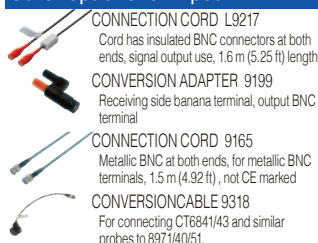

**CONNECTION CORD L9217**  
Cord has insulated BNC connectors at both ends, signal output use, 1.6 m (5.25 ft) length

**CONVERSION ADAPTER 9199**  
Receiving side banana terminal, output BNC terminal

**CONNECTION CORD 9165**  
Metallic BNC at both ends, for metallic BNC terminals, 1.5 m (4.92 ft), not CE marked

**CONVERSION CABLE 9318**  
For connecting CT6841/43 and similar probes to 8971/40/51.

**Temperature sensor**

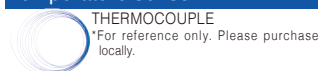

**THERMOCOUPLE**  
\*For reference only. Please purchase locally.

# Example sets

8 ch  
voltage  
output

8 ch  
voltage  
measurement

## Anomaly simulation testing

Output measured anomalous waveforms and processed arbitrary waveforms at max. 15 V, and record the results without modification.

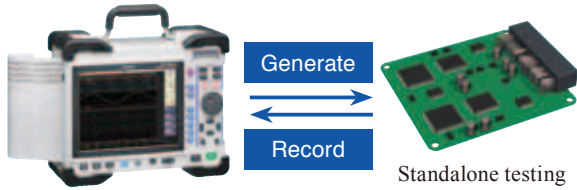

Set example

MEMORY HiCORDER	MR8847-51	1 unit
ARBITRARY WAVEFORM GENERATOR UNIT	U8793	4
ANALOG UNIT	8966	4
CONNECTION CABLE	L9795-01	8
CONNECTION CORD	L9198	8



Reproduce anomalous waveforms  
Record results while testing

Output both measured anomalous waveforms and waveforms that you created yourself for testing. You can also measure the results at the same time.



Arbitrary waveforms generated for 8 units,  
max. 16 channels  
Isolated output for all channels

Channels can be expanded without connecting additional recorders. Isolation between the Memory HiCorder and each channel and between the channels allows connections with devices with different potentials.

3 ch  
voltage  
measurement

3 ch  
current  
measurement

## High-voltage direct input measurement

Direct input is also possible without a differential probe for high voltage of 1000 V DC and 700 V AC.

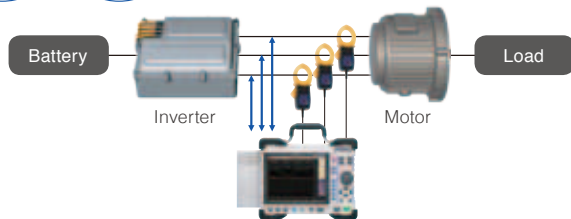

Set example

MEMORY HiCORDER	MR8847-51	1 unit
HIGH-VOLTAGE UNIT	U8974	2
CURRENT UNIT	8971	2
CLAMP ON SENSOR	9272-10	3
CONNECTION CABLE	L4940	3
ALLIGATOR CLIP	L4935	3



No DIFFERENTIAL PROBE  
needed for direct high-voltage  
measurements

Perform direct measurement of up to 1000 V DC and 700 V AC for high-voltage power equipment as well as 380 V and 480 V systems used globally.

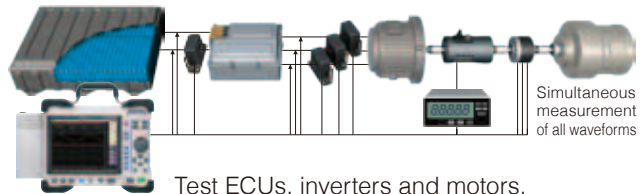

Test ECUs, inverters and motors.

Video  
recording

Multi-type  
multi-  
channel  
measurement

## Simultaneous measurement with high-speed camera recording

Synchronize high-speed video with multi-channel signals for recording.



Visualize prototype evaluations and  
problem analyses together with  
measurement data.

Easily visualize the relationship between various factors through the simultaneous measurement of data such as multi-system voltage, current and vibration together with high-speed camera recording.



\* Please contact your local Hioki distributor for more information about the use of high-speed cameras.

Set example

MEMORY HiCORDER	MR8847-51	1 unit
ANALOG UNIT	8966	1
CONNECTION CORD	9197	1
High-speed camera	—	1 unit

Note: Company names and Product names appearing in this catalog are trademarks or registered trademarks of various companies.

# HIOKI

HIOKI E. E. CORPORATION

HEADQUARTERS

81 Koizumi, Ueda, Nagano, 386-1192, Japan  
TEL +81-268-28-0562 FAX +81-268-28-0568  
http://www.hioki.com / E-mail: os-com@hioki.co.jp

HIOKI USA CORPORATION

TEL +1-609-409-9109 FAX +1-609-409-9108  
http://www.hioki.com / E-mail: hioki@hioki.com

HIOKI (Shanghai) SALES & TRADING CO., LTD.  
TEL +86-21-63910090 FAX +86-21-63910360  
http://www.hioki.cn / E-mail: info@hioki.com.cn

HIOKI SINGAPORE PTE. LTD.  
TEL +65-6634-7677 FAX +65-6634-7477  
E-mail: info-sg@hioki.com.sg

HIOKI KOREA CO., LTD.  
TEL +82-2-2183-8847 FAX +82-2-2183-3360  
E-mail: info-kr@hioki.co.jp

DISTRIBUTED BY