



MEMORY HiCORDER MR8740/MR8741

Recorders 



Fully Integrate into High-Speed, Multi-channel Measurement Systems

Multi-channel

Up to 54 channels (MR8740)

The MR8740 uses a two-block internal architecture, essentially giving it the capabilities of two MEMORY HiCORDERs.

Up to 16 channels (MR8741)

High-speed isolated measurement

20 MS/s isolated sampling

Simultaneous 20M sampling within the same block

DVM UNIT MR8990

Digital Voltage Meter

Measure minute changes in voltage at a high level of precision. Simultaneous measurement of all channels--rather than scanner-type measurement--dramatically reduces cycle times.

Systems Integration

Ideal for rack-mounting

Height of 4U (180 mm) or less
MR8740: 177 (H) × 426 (W) mm
MR8741: 160 (H) × 350 (W) mm



ISO 9001
JMI-0216



ISO 14001
JQA-E-90091



www.hioki.com

HIOKI company overview, new products, environmental considerations and other information are available on our website.

Are you having problems with multi-channel measurement or testing?

“We're using multiple DMM units with a scanner to switch inputs. Measurement takes too long...”

Reduced cycle times

“We need to perform many different types of measurements on a large number of channels.”

Measure across multiple channels at the same time

“We're using multiple measuring instruments, and it's hard to control them all. The wiring is a mess...”

Simplified systems

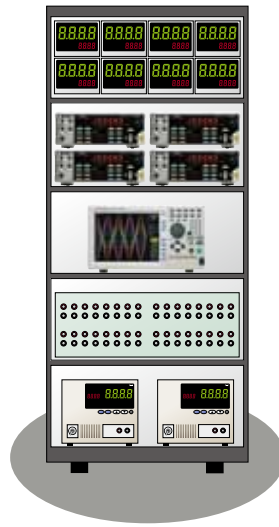

“We can't embed our oscilloscope, so we use it on a shelf. Our setup would be a lot sleeker if we could fit it in.”

Rack-mountable design

“Tall, large racks are dangerous in a production setting. I wonder if our setup can be made smaller...”

Space-saving design

“I wish we could make measurements faster and at a higher level of precision.”

High-speed, high-precision performance

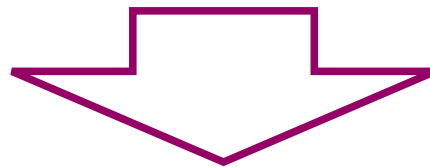

Solve these issues with the MR8740/MR8741 MEMORY HiCORDER.

A single-instrument solution for measuring multiple signal types and channels featuring rack-style measurement units that can be selected freely according to the target application



Solution: The MR8990 DVM Unit (→ page 6)

The MR8990 can measure even minute voltages previously measured with a DMM. Thanks to a $0.1 \mu\text{V}$ resolution and precision of $\pm 0.01\%$ rdg, $\pm 0.0025\%$ f.s., the MR8990 can capture minute voltage fluctuations as waveforms.

By switching from a bench-type DMM to a DVM unit, you can cut down on the amount of space taken up by measuring instruments. With no need to control multiple instruments, you can also simplify your system.

Solution: Extensive selection of measurement units (→ page 7)

Thanks to a unit-based architecture that can accommodate voltage, current, temperature, frequency, distortion, and control signal (logic) measurement units, the MR8740/MR8741 is a single-instrument solution for measuring multiple parameters. As a bonus, the ability to simultaneously record different signals on multiple channels cuts down on measurement times.

Solution: Rack-mountable design (→ page 4)

The MR8740/MR8741 can be mounted in a rack system for a clean, uncluttered installation.

Application

Function testing of ECUs and EV inverter motors

The MR8740/MR8741 can be used to perform a range of waveform measurements of inverter output.

■ Hardware combinations

MR8740	MEMORY HiCORDER	×1
8966	ANALOG UNIT	×17
8971	CURRENT UNIT	×2
9709	CLAMP SENSOR	×3
MR8990	DVM UNIT	×8

The MR8740 simultaneously measures 34 analog voltage waveform channels, 3 current waveform channels, and 16 DC voltage channels. DC voltage is measured at a high level of precision with a DVM unit. (The instrument provides functionality for time-difference and statistical calculations for voltage waveforms.)

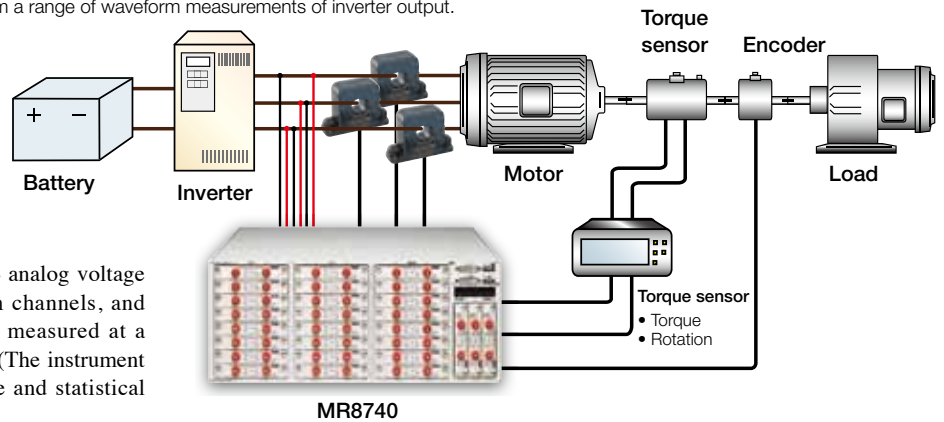

Testing of EV batteries

The MR8740/MR8741 supports high-precision voltage measurement with advanced functionality.

■ Hardware combinations

MR8740	MEMORY HiCORDER	×1
MR8990	DVM UNIT	× As needed

The recorders can take voltage measurement of battery cells, a task that requires a high level of precision and advanced functionality, at 24-bit resolution and precision of $\pm 0.01\%$ rdg. $\pm 0.0025\%$ f.s. Since measurement units have a high input resistance, the effect on the measurement target can be reduced.

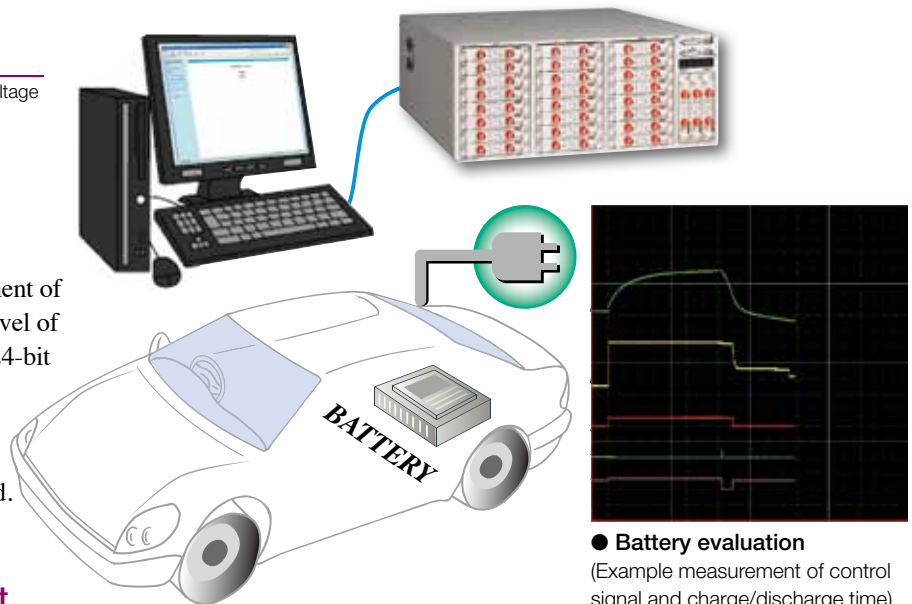

● Battery evaluation

(Example measurement of control signal and charge/discharge time)

Testing of power equipment

The MR8740/MR8741 can be embedded in systems used to test equipment.

■ Hardware combinations

MR8740	MEMORY HiCORDER	×1
8966	ANALOG UNIT	×17
8973	LOGIC UNIT	×6

The MR8740/MR8741 can perform characteristics testing of power equipment (load rejection tests and switch tests), measuring 42 channels of three-phase voltage and current or sensor output and 112 channels of switch on/off input.

● Timed, multi-channel measurement with a logic unit

The MR8740/MR8741 ships standard with 16 channels of logic input^{*1}. You can add up to three^{*2} 8973 Logic Units (16 channels each), making the instruments ideal for timed measurement of multiple channels.

*1 The MR8740 ships standard with 8 channels each in blocks I and II.

*2 The MR8740 can accommodate up to three measurement units in each block.

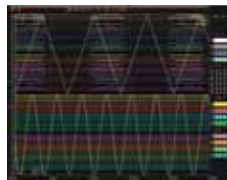

● Load rejection testing

Analyze correlation among factors such as the generator voltage before and after rejection, the rate of frequency variability, the status of governor servo operation, and voltage regulator switching timing.

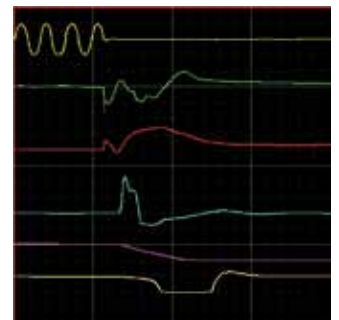

The MR8740 is a rack-mountable instrument that can measure up to 54 channels. It uses a two-block architecture, essentially giving it the capabilities of two MEMORY HiCORDERs.

MR8740 54ch model

- Accommodates up to 27 measurement units.
- Two-block architecture
(Block I: 16 units; block II: 11 units)
- Standard support for 16 logic channels

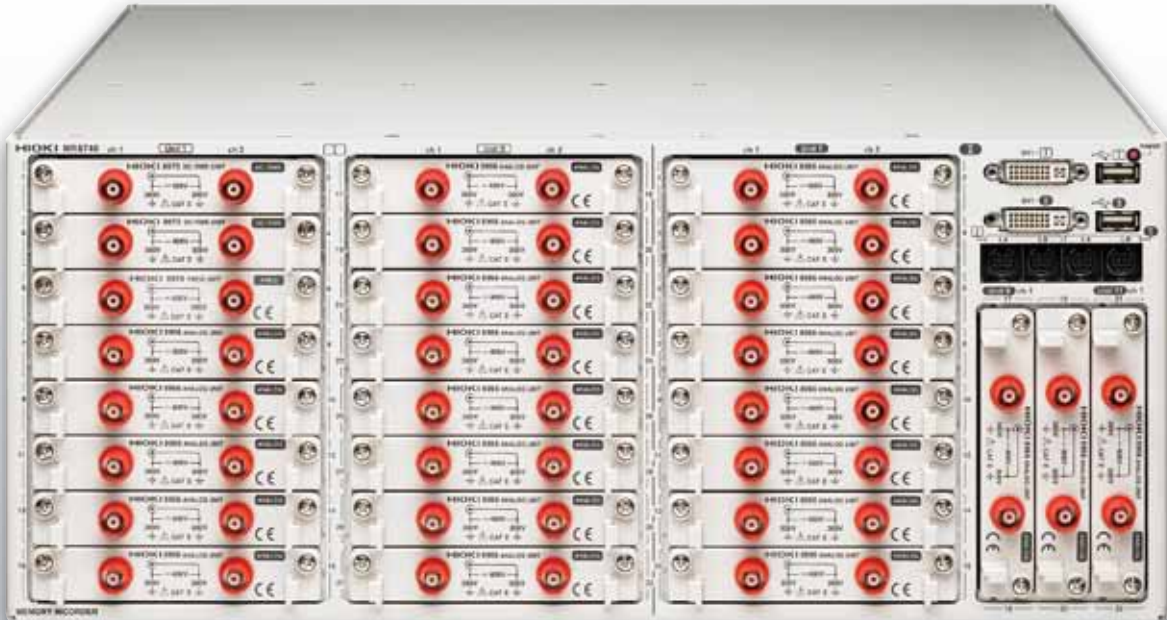

- Support for multi-channel measurement of up to 54 channels
- Switchable inter-block trigger synchronization

- Independent block operation
- Support for applications using different functions

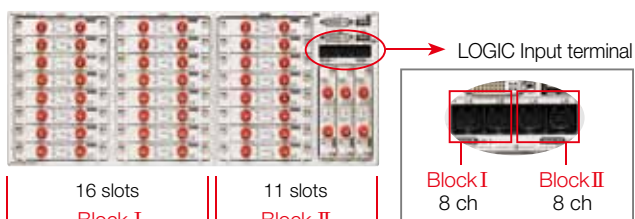

Block I : Analog 32ch, Logic 8ch
Block II : Analog 22ch, Logic 8ch

(There may be a lag of up to 1 μ s or 3 samples between blocks I and II.)

Since blocks I (32 channels) and II (22 channels) perform measurements independently, it is possible to set different function and sampling speeds for each block. Operations such as starting measurement are performed separately by each block, and different measurement data files are used by each block.

For example...

Block I : MEMORY function, 20MS/s
Block II : FFT function, 20MS/s

A single instrument supports a variety of measurements, expanding the range of applications in which the device can be used.

Ideal for rack-mounting

The MR8740/MR8741 ship standard with EIA standard-compliant rack-mounting hardware.

The instruments also support JIS standard racks. Please contact HIOKI for more information.



[Rear]
LAN (100BASE-TX) and USB (type A, for USB flash memory or a mouse) connectors are standard on the rear of the instrument. The power inlet and power switch are also located here.

The MR8741 is a bench-top instrument that delivers affordable measurement performance. It features area judgment functionality and external control terminals.

MR8741 16ch model

- Accommodates up to 8 measurement units.
- Standard support for 16 logic channels
- Area judgment function and external control terminals

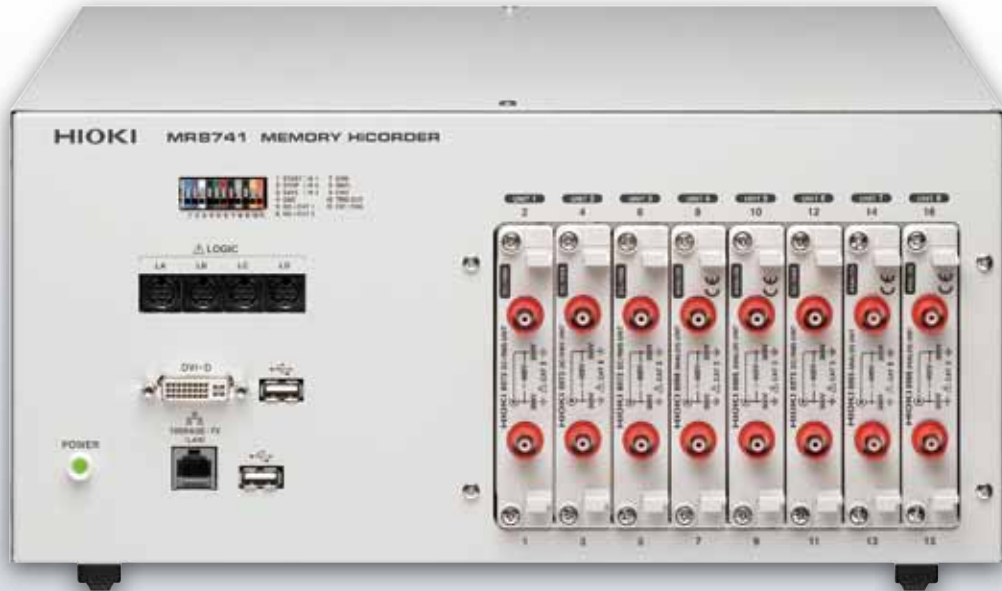

[Rear] A vent (fan), power inlet, and power switch are located on the rear of the instrument.

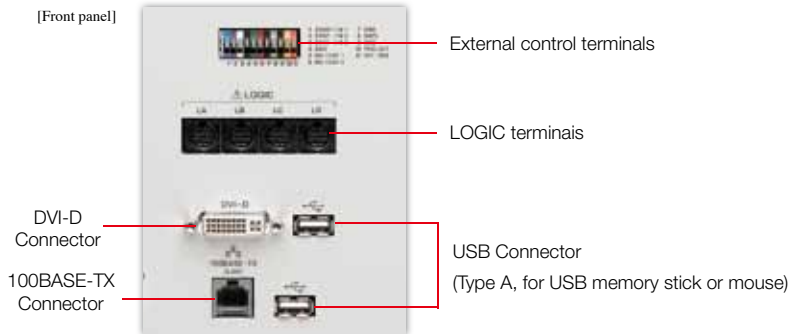

Use as a multi-channel WAVE COMPARATOR.

High-speed waveform judgment function

The MR8741's waveform judgment function, which monitors whether a target waveform has diverged from an area with a safe margin, makes it easy to measure signal waveforms for which it can otherwise be difficult to make pass/fail judgments. The instrument can measure waveforms on multiple channels at the high speed of 20 MS/s, providing immediate pass/fail judgments in maintenance and production line applications.

When using a time-axis range slower than 100msec/div, measured waveforms can be compared in near real-time, enabling you to detect failures on the spot. Production can be halted in time to minimize resource waste.

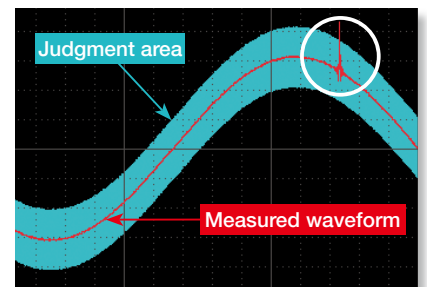

Compare captured waveform with reference area

Setting the waveform evaluation	[OUT] Return NG if any part of the waveform leaves the evaluation area. [ALL OUT] Return NG if the entire waveform leaves the evaluation area.
Setting the GO/NG stop mode	[GO] Stop recording on GO result. [NG] Stop recording on NG result. [GO] Stop recording on GO or NG result.

Unit-based architecture accommodates a variety of measurement applications.

High precision and high resolution

DIGITAL VOLTAGE METER

DVM UNIT MR8990

New unit designed exclusively for the MR8740/MR8741



The MR8990 DVM UNIT is a two-channel DC voltage measurement unit designed exclusively for use with the MR8740/MR8741. It can measure minute fluctuations in output from sensors in automobiles and other equipment and voltage fluctuations in devices such as batteries at high levels of precision and resolution.

Features

High resolution: 24bit, 6.5-digit display

Thanks to a resolution of $0.1\mu\text{V}$, the MR8990 can measure even minute fluctuations in the output voltage of sensors and other equipment.

High accuracy: $\pm 0.01\%$ rdg. $\pm 0.0025\%$ f.s.

The MR8990 performs measurements at a high precision of $\pm 0.01\%$ rdg. $\pm 0.0025\%$ f.s. and at speeds of up to 500 samples per second.

Max. allowable input: DC 500 V

The MR8990 can accommodate input ranging from minute to high voltages.

High input resistance

5mV/DIV to 500mV/DIV range: $100\text{ M}\Omega$ or greater

5V/DIV to 50V/DIV range : $10\text{ M}\Omega \pm 5\%$

Input Unit Comparison Chart (Sampling Period and Accuracy)

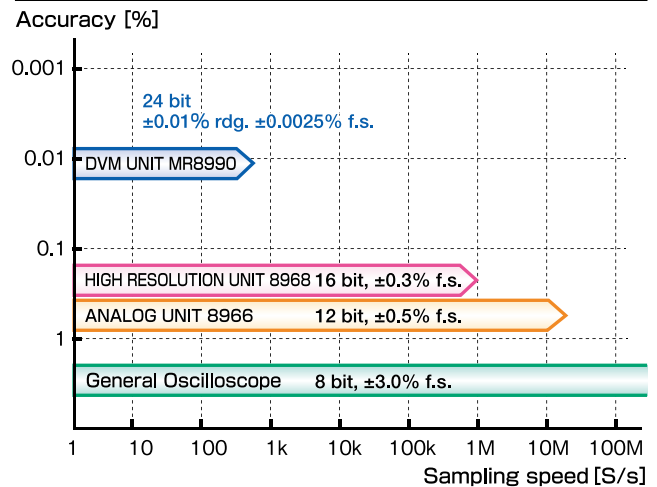

Specifications

Product guaranteed for one year
Accuracy guaranteed for one year

Measurement range

Measurement range	Effective input range ^(*)	Measurement resolution	Input resistance
5 mV/div (f.s. = 100 mV)	-120 mV to 120 mV	0.1 μV	More than 100 M Ω
50 mV/div (f.s. = 1000 mV)	-1200 mV to 1200 mV	1 μV	
500 mV/div (f.s. = 10 V)	-12 V to 12 V	10 μV	10 M $\Omega \pm 5\%$
5 V/div (f.s. = 100 V)	-120 V to 120 V	100 μV	
50 V/div (f.s. = 1000 V)	-500 V to 500 V	1 mV	

*Measurement guaranteed accuracy range

Measurement accuracy

Measurement range	NPLC: Less than 1	NPLC: More than 1
5 mV/div (f.s. = 100 mV)	$\pm 0.01\%$ rdg. $\pm 0.015\%$ f.s.	$\pm 0.01\%$ rdg. $\pm 0.01\%$ f.s.
50 mV/div (f.s. = 1000 mV)	$\pm 0.01\%$ rdg. $\pm 0.0025\%$ f.s.	
500 mV/div (f.s. = 10 V)	$\pm 0.01\%$ rdg. $\pm 0.0025\%$ f.s.	
5 V/div (f.s. = 100 V)	$\pm 0.025\%$ rdg. $\pm 0.0025\%$ f.s.	
50 V/div (f.s. = 1000 V)	$\pm 0.025\%$ rdg. $\pm 0.0025\%$ f.s.	

Integration time

Power supply frequency	Integration time
50 Hz	20 ms \times NPLC
60 Hz	16.67 ms \times NPLC

NPLC: Settable from 0.1 to 0.9 (in increments of 0.1), 1 to 9 (in increments of 1), and 10 to 100 (in increments of 10).

The number of power line cycles (NPLC), representing the number of cycles in the power supply (50 Hz or 60 Hz) period, determines the integration time. Larger NPLC values result in more effective rejection of noise caused by the power supply at the expense of lower sampling speeds.

Temperature characteristics: $\pm (0.002\% \text{ rdg. } \pm 0.00025\% \text{ f.s.}) / ^\circ\text{C}$

- A/D conversion measurement method : $\Delta\Sigma$ modulation method 24bit
- Measurement functions : DC V
- Number of channels : 2ch
- Maximum sampling rate : 2 ms (500 sampling/sec)
- Max. allowable input : DC 500 V
- Max. rated voltage to earth : AC, DC 300 V

Input Unit Comparison Chart (Input Voltage and Sampling Speed)

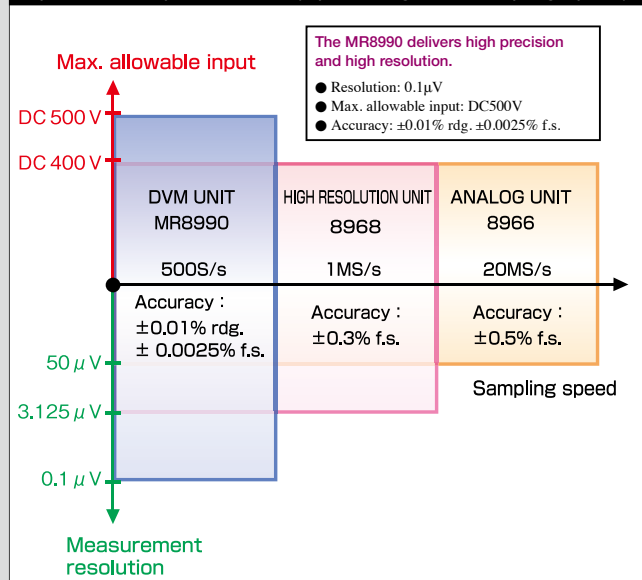

Option for MR8990



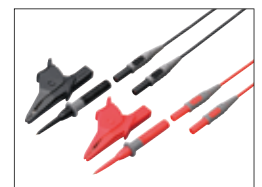

TEST LEAD L2200

One set (Redx1, Blackx1), 70cm (2.30ft) length
Unit jack: Banana terminal
The tip can be replaced with a pin lead or alligator clip.
Max. allowable input: CAT IV 600V, CAT III 1000V







Choose from nine input units according to your measurement application.

The MR8740/MR8741 uses the same measurement units as the MR8847 MEMORY HiCORDER.

	12-bit, 20 MS/s High-speed sampling	16-bit, 1 MS/s High resolution	RMS measurement	Distortion measurement
	ANALOG UNIT 8966	HIGH RESOLUTION UNIT 8968	DC/RMS UNIT 8972	STRAIN UNIT 8969
				
Measurement functions	Voltage measurement	Voltage measurement	Voltage measurement (DC/RMS selectable)	Distortion measurement
Number of channels	2ch	2ch	2ch	2ch
Input connectors	Isolated BNC connector (input impedance 1 MΩ, input capacitance 30 pF), Max. rated voltage to earth ^(*) : 300 V AC, DC	Isolated BNC connector (input impedance 1 MΩ, input capacitance 30 pF), Max. rated voltage to earth ^(*) : 300 V AC, DC	Isolated BNC connector (input impedance 1 MΩ, input capacitance 30 pF), Max. rated voltage to earth ^(*) : 300 V AC, DC	Weidmuller SL 3.5/7/90G (via Conversion Cable 9769, TAJIMI PRC03-12A10-7M10.5) Max. rated voltage to earth ^(*) : 33 Vrms, or 70V DC
Measurement range	5 mV to 20 V/div, 12 ranges	5 mV to 20 V/div, 12 ranges	5 mV to 20 V/div, 12 ranges	20 με to 1000 με/div, 6 ranges
Measurement resolution	1/100 of measurement range using 12-bit A/D conversion	1/1600 of measurement range using 16-bit A/D conversion	1/100 of measurement range using 12-bit A/D conversion	1/1250 of measurement range using 16-bit A/D conversion
Highest sampling rate	20 MS/s	1 MS/s	1 MS/s	200 kS/s
Measurement accuracy	±0.5 % f.s.	±0.3 % f.s.	±0.5 % f.s. RMS amplitude accuracy: ±1 % f.s. (DC, 30 Hz to 1 kHz)	±0.5 % f.s.
Frequency characteristics	DC to 5MHz (-3dB) (with AC coupling: 7 Hz to 5 MHz -3dB)	DC to 100 kHz (-3dB) (with AC coupling: 7 Hz to 100 kHz -3dB)	DC to 400 kHz (-3dB) (with AC coupling: 7 Hz to 400 kHz -3dB)	DC to 20 kHz+1 (-3dB)
Input coupling	AC/DC/GND	AC/DC/GND	AC/DC/GND	-
Max. allowable input	DC 400V	DC 400V	DC 400V	-

(*) with input isolated from the unit, the maximum voltage that can be applied between input channel and chassis and between input channels without damage

	Temperature measurement using a thermocouple	Frequency • Rotation	Clamp sensor direct-coupled current measurement	Control signal observation
	TEMP UNIT 8967	FREQ UNIT 8970	CURRENT UNIT 8971	LOGIC UNIT 8973
				
Measurement functions	Temperature measurement with thermocouple	Frequency measurement using voltage input	Current measurement using an optional sensor	Logic measurement using an optional probe
Number of channels	2ch	2ch	2ch	16 channels (up to 4 logic probes can be connected)
Measurement resolution	1/1000 of measurement range using 16-bit A/D conversion	1/2000 of measurement range using 16-bit A/D conversion (Integration mode)	1/100 of measurement range using 12-bit A/D conversion	Mini-DIN terminal (HIOKI logic probes only) Compatible logic probes: ■ 9320-01/9327
Specifications	<p>Input connectors: Thermocouple input: plug-in connector, Recommended wire diameter: single-wire, 0.14 to 1.5 mm², braided wire 0.14 to 1.0 mm² (conductor wire diameter min. 0.18 mm), AWG 26 to 16 Input impedance: Min. 5 MΩ Max. rated voltage to earth^(*): 300 V AC, DC</p> <p>Temperature measurement range: 10°C/div (-100 °C to 200°C) 50°C/div (-200 °C to 1000 °C) 100°C/div (-200 °C to 2000°C)</p> <p>Thermocouple range: K: -200 to 1350 °C J: -200 to 1100 °C E: -200 to 800 °C T: -200 to 400 °C N: -200 to 1300 °C R: 0 to 1700 °C S: 0 to 1700 °C B: 400 to 1800 °C W (WRe5-26): 0 to 2000 °C Reference junction compensation: internal/ external (switchable), Line fault detection ON/OFF possible</p> <p>Measurement accuracy: Thermocouple K, J, E, T, N: ±0.1 % f.s. ±1 °C (±0.1 % f.s. ±2 °C at -200 °C to 0 °C), Thermocouple R, S, W: ±0.1 % f.s. ±3.5 °C (at 0 °C to 400 °C or less), ±0.1 % f.s. ±3 °C (at 400 °C or more), Thermocouple B: ±0.1 % f.s. ±3 °C (at 400 °C or more) Reference junction compensation accuracy: ±1.5 °C (added to measurement accuracy with internal reference junction compensation)</p>	<p>Input connectors: Isolated BNC connector (input impedance 1 MΩ, input capacitance 30 pF) Max. rated voltage to earth^(*): 300 V AC, DC</p> <p>Frequency measurement range: Between DC to 100kHz (Min. pulse width 2μs), 1Hz/div to 5kHz/div (full scale=20 div), 8 settings Accuracy: ±0.1% f.s. (exclude 5kHz/div), ±0.7% f.s. (at 5kHz/div)</p> <p>Rotation measurement range: Between 0 to 2 million rotations/minute (Min. pulse width 2μs), 100 (r/min)/div to 100k (r/min)/div (full scale=20 div), 7 settings Accuracy: ±0.1% f.s. (excluding 100k (r/min)/div), ±0.7% f.s. (at 100k (r/min)/div)</p> <p>Power frequency measurement range: 50Hz (40 to 60Hz), 60Hz (50 to 70Hz), 400Hz (390 to 410Hz) (full scale=20 div), 3 settings Accuracy: ±0.03Hz (exclude 400Hz range), ±0.1Hz (400Hz range)</p> <p>Integration measurement range: 2k counts/div to 1M counts/div, 6 settings Accuracy: ±range/2000</p> <p>Duty ratio measurement range: Between 10Hz to 100kHz (minimum pulse width 2μs), 5%/div (full scale=20 div) Accuracy: ±1% (10Hz to 10kHz), ±4% (10kHz to 100kHz)</p> <p>Pulse width measurement range: Between 2μs to 2sec, 500μs/div to 100ms/ dv (full scale=20 div) Accuracy: ±0.1% f.s.</p>	<p>Input connectors: Sensor connector (input impedance 1 MΩ, exclusive connector for current sensor via conversion cable the 9318, common ground with recorder)</p> <p>Compatible current sensors: CT6865, CT6863, CT 6862, 9709, 9279, 9278, 9277, 9272-10 (To connect the 8971 via conversion cable the 9318)</p> <p>Measurement range: Using 9272-10 (20A), 9277: 100mA to 5A/div (f.s.=20div, 6 settings) Using CT6862: 200mA to 10A/div (f.s.=20div, 6 settings) Using 9272-10 (200A), 9278, CT6863: 1A to 50A/div (f.s.=20div, 6 settings) Using 9279, 9709: 2A to 100A/div (f.s.=20div, 6 settings)</p> <p>Accuracy: Using 9278, 9279: ±0.85% f.s. Using other sensor: ±0.65% f.s. RMS amplitude accuracy: ±1% f.s. (DC, 30Hz to 1kHz), ±3% f.s. (1kHz to 10kHz) RMS response time: 100ms (rise time from 0 to 90% f.s.), Crest factor: 2 Frequency characteristics: DC to 100kHz, ±3dB (with AC coupling: 7Hz to 100kHz)</p> <p>Highest sampling rate: 1 MS/s (simultaneous sampling across 2 channels)</p> <p>8971 Current Unit precautions</p> <ul style="list-style-type: none"> • Cannot be used with the MR8741. • Up to four units can be installed in a single instrument. • When using the 9709/CT6865, up to 7 current probes can be used. 	<p>Detection of voltage signal or relay contact signal for High/Low state recording Input: 4 channels (common ground between unit and channels), digital/contact input, switchable (contact input can detect open-collector signals) Input resistance: 1 MΩ (with digital input, 0 to +5 V) 500 kΩ or more (with digital input, +5 to +50V) Pull-up resistance: 2 kΩ (contact input: internally pulled up to +5 V) Digital input threshold: 1.4V/ 2.5V/ 4.0V Contact input detection resistance: 1.4 V: 1.5 kΩ or higher (open) and 500 Ω or lower (short) 2.5 V: 3.5 kΩ or higher (open) and 1.5 kΩ or lower (short) 4.0 V: 25 kΩ or higher (open) and 8 kΩ or lower (short) Response speed: 9320-01: 500ns or lower 9327: Detectable pulse width 100ns or higher Max. allowable input: 0 to +50V DC (the maximum voltage that can be applied across input pins without damage)</p> <p>■ MR9321-01 Detection of AC or DC relay drive signal for High/Low state recording. Can also be used for power line interruption detection Input: 4 channels (isolated between unit and channels), HIGH/LOW range switching Input resistance: 100 kΩ or higher (HIGH range), 30 kΩ or higher (LOW range) Output (H) detection: 170 to 250 V AC, ±DC 0 to 250 V (HIGH range) 60 to 150 V AC, ±DC 20 to 150 V (LOW range) Output (L) detection: 0 to 30 V AC, ±DC 0 to 43 V (HIGH range) 0 to 10 V AC, ±DC 0 to 15 V (LOW range) Response time: Rising edge 1 ms max., falling edge 3 ms max. (with HIGH range at 200 V DC, LOW range at 100 V DC) Max. allowable input: 250 Vrms (HIGH range), 150 Vrms (LOW range) (the maximum voltage that can be applied across input pins without damage)</p> <p>Up to three units can be installed in a single instrument (or 1 block)</p>

(*) with input isolated from the unit, the maximum voltage that can be applied between input channel and chassis and between input channels without damage

Analyze data on a computer

Easy recording of measurement data

Compatible to USB memory sticks

Measurement data can be saved on any generic USB memory device.

Measurement data can be easily recorded, and a USB flash drive can be used to easily copy data to a computer.

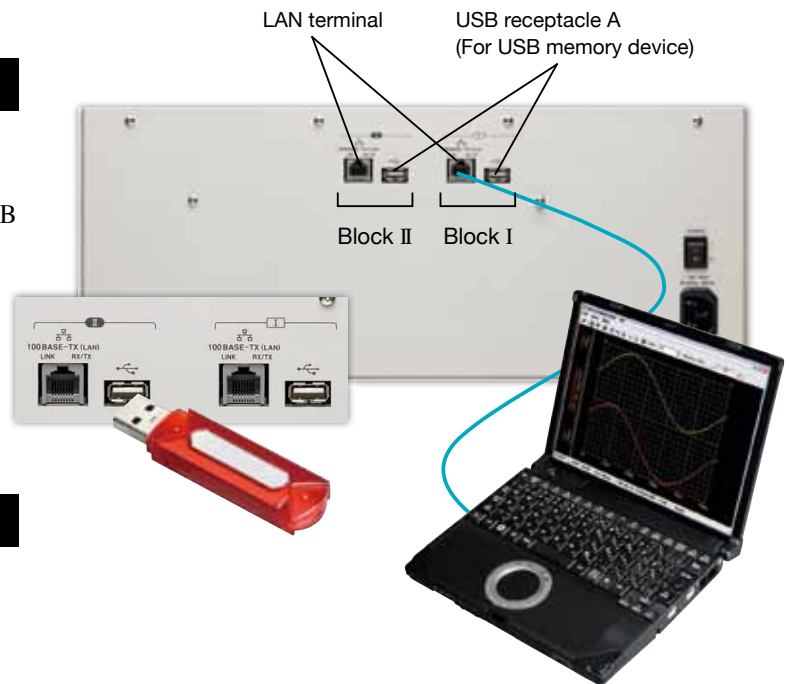

LAN communications capability

HTTP/FTP server function

A 100BASE-TX LAN port is built in as standard equipment.

<HTTP server capability>

Access the unit via a web browser running on a computer, for waveform observation and remote operation. Waveform data of the MR8740/MR8741 series can also be downloaded and pasted onto Excel.

<FTP server capability>

Copy the memory contents of the MR8740/MR8741 (USB memory, internal RAM) to a computer.

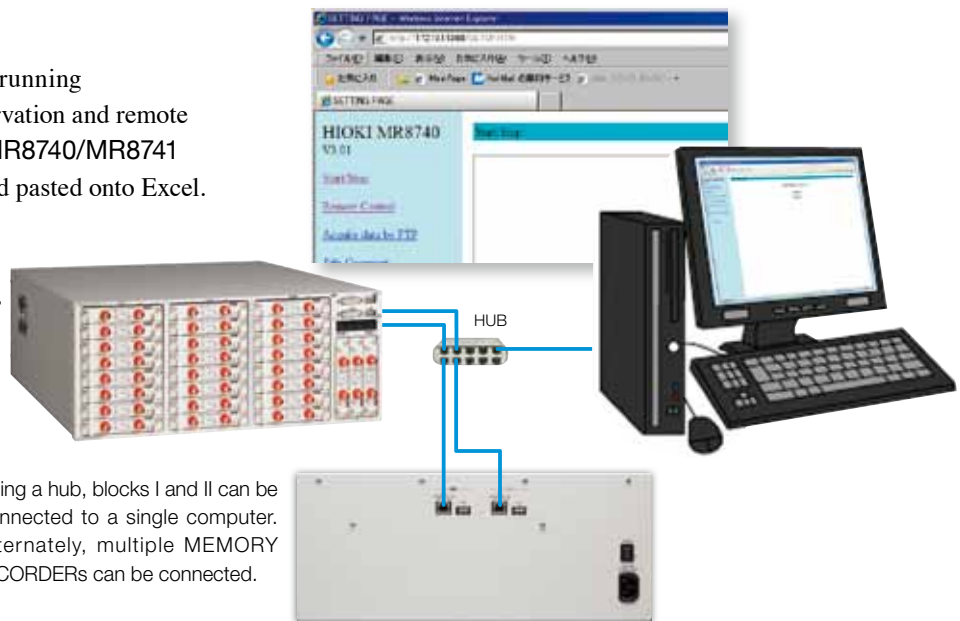

Using a hub, blocks I and II can be connected to a single computer. Alternately, multiple MEMORY HiCORDERs can be connected.

Waveform observation/CSV conversion software bundled as standard

Standard application disc (Wv Wave Viewer)

- Binary data collected with the MEMORY HiCORDER can be observed as waveforms on a computer.
- Data can be converted to CSV format for importing into Excel. The software is supplied free of charge with the product, and the latest version can also be downloaded from the HIOKI web site.

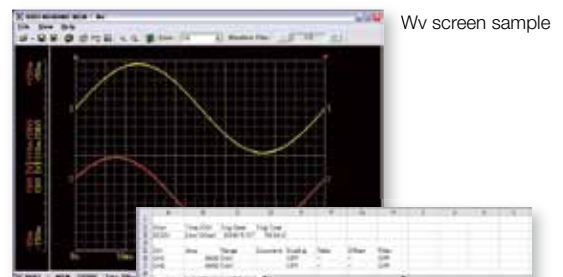

Wv screen sample

Wave Viewer (Wv) Software Specifications (Bundled with the MR8740/MR8741 in the CD-R)

Functions	<ul style="list-style-type: none"> • Simple display of waveform file • Text conversion: convert binary data file to text format, with selectable space or tab separators in addition to CSV, and specifiable section, thinning available • Display format settings: scroll functions, enlarge/reduce display, display channel settings • Others: voltage value trace function, jump to cursor/trigger position function
Operating environment	Windows 7 (32bit/64bit)/Vista (32bit)/XP/2000

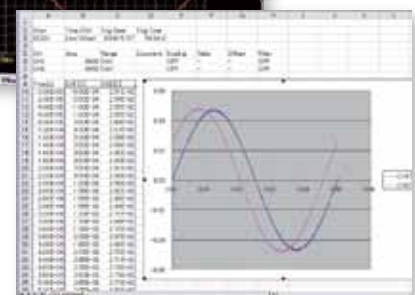

EXCEL sheet sample

Convenient functions

Display and mouse connectivity

Measure without using a PC.

By connecting a display and mouse to the MR8740/MR8741, you can display waveforms and operate the instrument with a mouse.

The monitor display screen uses the same layout as the MR8847 Memory HiCorder series display. A mouse can be used to operate and configure the instrument, providing a user experience that approximates use of a keyboard. (Display and mouse not included.)

Connect a display and mouse to enable standalone use.

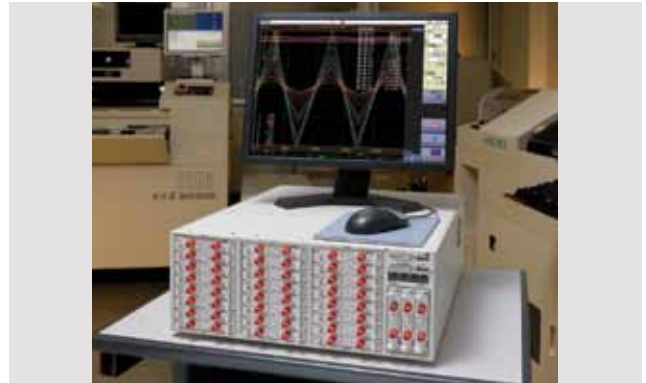

X-Y wave comparator MR8741 only

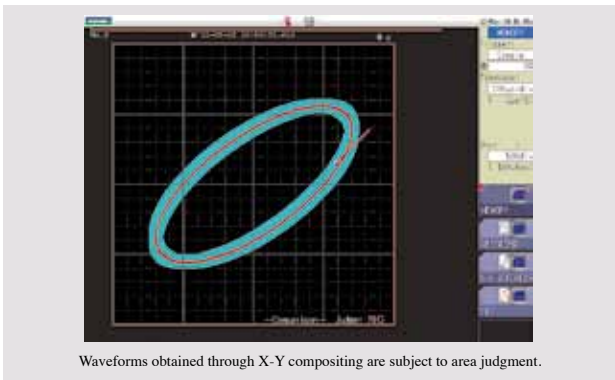

The MR8741 includes functionality for judging X-Y waveforms. Waveforms measured using the memory function and created with X-Y compositing are subject to area judgment.

The X-Y waveforms captured from these and many other applications can be tested against reference waveforms automatically:

- Alteration and pressure at press machines
- Pump pressure and flow

Numerical calculation function

Calculate parameter values from measured waveform

20 different built-in calculation types including effective (rms) value, peak value, and maximum value.

Multiple channels can be measured and judged at once, minimizing cycle times. Inter-channel calculations can also be performed at high speed by means of internal processing, and the results can be transferred to a computer.

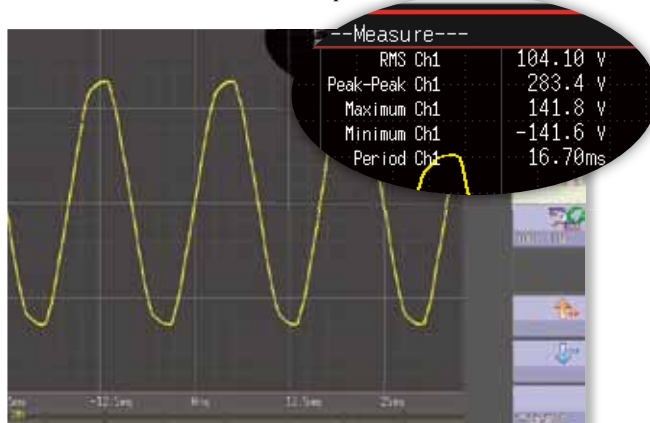

Numerical calculation results can be shown on waveform display

Value monitor (DMM display)

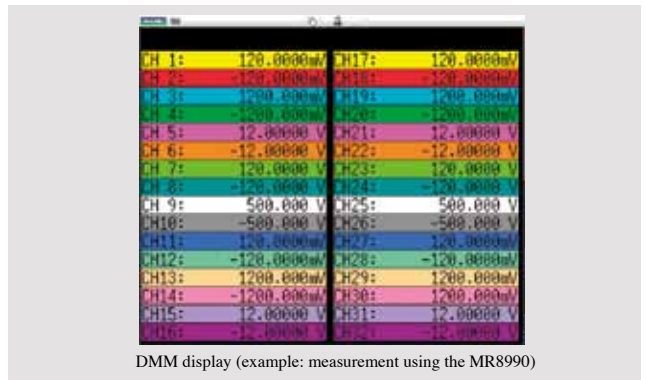

Input values can be monitored numerically in the manner of a digital multimeter (DMM).

Numerical calculation settings

Evaluation settings

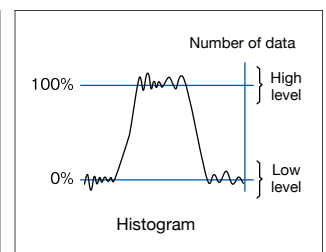
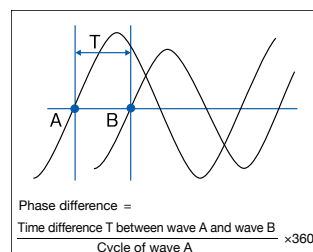

FFT function

Frequency area data analysis (FFT function)

Electrical distortion analysis/mechanical vibration analysis

FFT analysis function

This function comprises single-signal FFT for tasks such as frequency component analysis, dual-signal FFT for transfer function analysis, and octave analysis for acoustic measurements. The signal source for analysis are selectable from 1,000 to 10,000 data points.

FFT analysis from captured time domain data (used with Memory function)

To use measurement data captured with the Memory function, the mouse serves to specify analysis points, and processing results can now be displayed at the same time. There is no need to go back and forth between the Memory and FFT Functions to set the calculation start point. It is also possible to view raw data measured with the Memory function and processing results obtained from stored waveforms side by side. You can then check the effects of window functions while viewing spectrum waveforms, resulting in a dramatic improvement in operation convenience during use of the analysis functions.

Running spectrum display (MR8741 only)

Waveform comparison can be conducted even for FFT-analyzed waveforms.

Recalculate by changing the number of calculation points after measurement

Even for measurement data currently based on a lower number of calculation points, it is possible to increase the number later and perform analysis again. For example, data measured at a setting of 1,000 points can be converted and reanalyzed with a 10,000 point setting. This will result in a tenfold increase in frequency analysis resolution. Of course, the opposite is also possible, going for example from 10,000 points to 1,000 points.

Note: Recalculation with a different number of calculation points is not possible if frequency averaging is set to ON.

Running spectrum display

Display ever-changing time-based spectrums in 3D and use the mouse to load previously captured waveform. Data can be saved as text for further graphical processing on Excel or other spreadsheet applications.

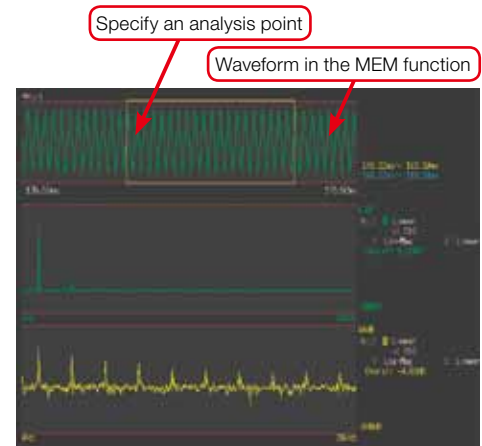

Source waveform (captured in Memory function), and FFT analyzed waveform display simultaneously

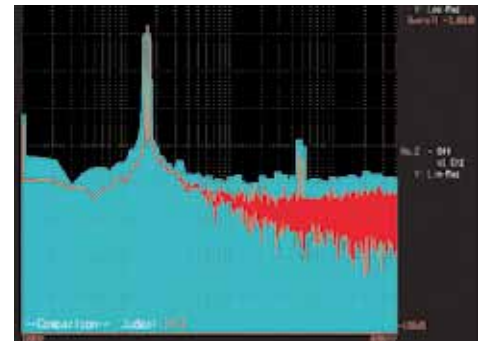

Waveform judgment display in FFT

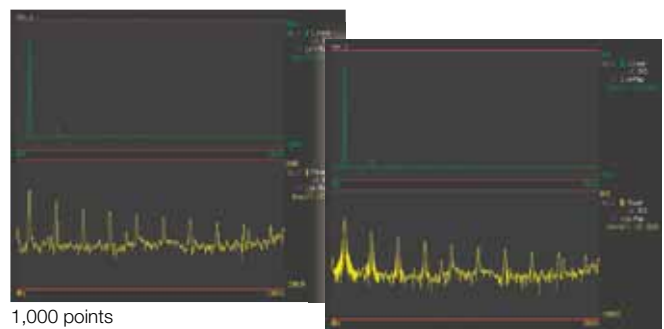

1,000 points

Convert 1,000 to 10,000 points

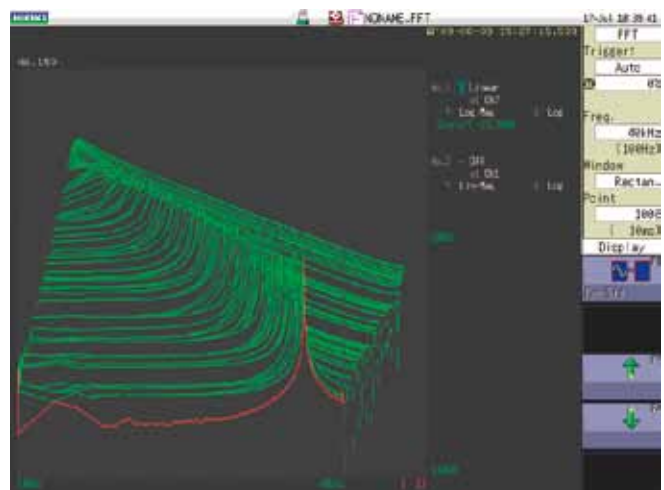

Specifications

Basic specifications (product guaranteed for one year)	
Measurement functions	MEMORY (high-speed recording, X-Y), RECORDER (real-time recording), FFT (frequency analysis) (Recorder functionality scheduled to be available by the end of 2012.)
Number of input units	MR8740 : 27units + 16 logic channels (standard) MR8741 : 8units + 16 logic channels (standard) * For analog units, channels are isolated from each other and from frame GND. For logic units and internal standard logic terminals, all channels have common GND.
Maximum sampling rate	20 MS/second (50 ns period, all channels simultaneously) External sampling (10 MS/second, 100 ns period)
Internal memory	MR8740: Block I: Total 512 M-words (16MW/ch) Block II: Total 352 M-words (16MW/ch) MR8741: Total 256 M-words (16MW/ch)
Data storage media	USB memory stick (USB 2.0)
Backup functions (At 25°C/ 77°F)	Clock and parameter setting backup: at least 10 years Waveform backup function: none
External control connectors (MR8741only)	Terminal block: External trigger input, Trigger output, External sampling input, Two external outputs (GO/NG output), Three external inputs (start, stop, save)
External interfaces	LAN: 100BASE-TX (DHCP, DNS supported, FTP server, HTTP server) USB: USB2.0 compliant, series A receptacle x2
Environmental conditions (No condensation)	Operation: 0°C (32°F) to 40°C (104°F), 20 % to 80 % rh Storage: -10°C (14°F) to 50°C (122°F), 90 % rh or less
Compliance standard	Safety: EN61010
Power supply	100 to 240 V AC, 50/60 Hz
Power consumption	MR8740: 250 VA, MR8741: 120 VA
Dimensions and mass (main unit only)	MR8740: Approx. 426 mm (16.77 in) W × 177 mm (6.97 in) H × 505 mm (19.88 in) D, 10.8 kg (381.0 oz) MR8741: Approx. 350 mm (13.78 in) W × 160 mm (6.30 in) H × 320 mm (12.60 in) D, 5.4 kg (190.5 oz)
Supplied accessories	Instruction Manual × 1, Application Disk (Wave Viewer Wv, Communication Commands table) × 1, Power cord × 1, rack-mounting hardware (EIA standard) × 1set (MR8740 only)

MEMORY (high-speed recording)	
Time axis	5 μs to 5 min/div (100 samples/div) 26 ranges, External sampling (MR8740 only), Time axis zoom: ×2 to ×10 in 3 stages, compression: 1/2 to 1/20,000 in 13 stages
Sampling period	1/100 of time axis range (minimum 50 ns period)
Recording length	25 to 100,000 div, or arbitrary setting in 1-div steps (max. 160,000 div)
Pre-trigger	Record data from before the trigger point at 0 to +100% or -95% of the recording length in 15 stages, or in 1 div step settings
Numerical calculation	<ul style="list-style-type: none"> • Simultaneous calculation for up to 16 selected channels Average value, effective (rms) value, peak to peak value, maximum value, time to maximum value, minimum value, time to minimum value, period, frequency, rise time, fall time, standard deviation, area value, X-Y area value, specified level time, specified time level, pulse width, duty ratio, pulse count, four arithmetic operations, Time difference, phase difference, high-level and low-level • Calculation result evaluation output: GO/NG • Automatic storing of calculation results
Waveform processing	For up to 16 freely selectable channels, the following functions can be performed (results are automatically stored): Four arithmetic operations, absolute value, exponentiation, common logarithm, square root, moving average, differentiation (primary, secondary), integration (primary, secondary), parallel displacement along time axis, trigonometric functions, reverse trigonometric functions
Memory segmentation	Max. 1024 blocks
Other functions	<ul style="list-style-type: none"> • No logging • X-Y waveform synthesis (1-screen, 4-screens) • Overlay (always overlay when started/overlay only required waveforms)

RECORDER (real-time recording)	
Time axis	10 ms to 1 hour/div, 19 ranges, time axis resolution 100 points/div <i>Note: Out of data acquired at selected sampling rate, only maximum and minimum value data determined using 100 points/div units are stored. Time axis compression selectable in 13 steps, from × 1/2 to × 1/20,000</i>
Sampling rate	1/10/100 μs 1/10/100 ms (selectable from 1/100 or less of time axis)
Recording length	Built-in presets of 25 - 50,000 div, or "Continuous" or arbitrary setting in 1-div steps (max. 80,000 div)
Waveform memory	Store data for most recent 80,000 div in memory
Auto save	Data is automatically saved in USB memory stick after measurement stops

Trigger functions	
Trigger mode	MEMORY (high-speed recording), FFT: Single, Repeat, Auto RECORDER* (real-time recording): Single, Repeat
Trigger sources	CH1 to CH16 (analog), Standard Logic 16ch + Logic Unit (Max. 3 units 48 channels), External, Timer, Manual (either ON or OFF for each source), Logical AND/OR of sources
Trigger types	<ul style="list-style-type: none"> • Level: Triggering occurs when preset voltage level is crossed (upwards or downwards) • Voltage drop: Triggering occurs when voltage drops below peak voltage setting (for 50/60 Hz AC power lines only) • Window: Triggering occurs when window defined by upper and lower limit is entered or exited • Period: Rising edge or falling edge cycle of preset voltage value is monitored and triggering occurs when defined cycle range is exceeded • Glitch: Triggering occurs when pulse width from rising or falling edge of preset voltage value is under run • Event setting: Event count is performed for each source, and triggering occurs when a preset count is exceeded • Logic: 1, 0, or x, Pattern setting
Level setting resolution	0.1% of full scale (full scale = 20 divisions)
Trigger filter	Selectable 0.1div to 10.0div, or OFF (at MEMORY function) ON (10ms fixed) or OFF (at RECORDER function*)
Trigger output (MR8741 only)	Open collector (5 voltage output, active Low) At Level setting: pulse width (Sampling period × data number after trigger) At Pulse setting: pulse width (2ms)
Other functions	Trigger priority (OFF/ON), Pre-trigger function for capturing data from before / after trigger event (at MEMORY function), Level display during trigger standby, Start and stop trigger (At RECORDER function*), Trigger search function

FFT	
Analysis mode	Storage waveform, Linear spectrum, RMS spectrum, Power spectrum, Density of power spectrum, Cross power spectrum, Auto-correlation function, Histogram, Transfer function, Crosscorrelation function, Impulse response, Coherence function, 1/1 Octave analysis, 1/3 Octave analysis, LPC analysis, Phase spectrum
Analysis channels	Selectable from all analog input channels
Frequency range	133 mHz to 8 MHz, External, (resolution 1/400, 1/800, 1/2000, 1/4000)
Number of sampling points	1000, 2000, 5000, 10000 points
Window functions	Rectangular, Hanning, Hamming, Blackman, Blackman-Harris, Flattop, Exponential
Display format	Single, Dual, Nyquist, Running spectrum
Averaging function	Time axis / frequency axis simple averaging, Exponential averaging, Peak hold (frequency axis), Averaging times: 2 times to 10,000 times

Other functions	
Waveform judgment function (In MEMORY or FFT function) (MR8741 only)	<ul style="list-style-type: none"> • Area comparison with reference waveform area for time domain waveform, X-Y waveform, or FFT analysis waveform • Parameter calculated value comparison with reference value • Output: GO/NG decision, Open-collector 5V, <i>Note: Judge waveforms in near real-time at samplings speeds of 100msec/div (1ms sampling) or slower.</i>

WAVE PROCESSOR 9335 (option)	
Supported units	Model MR8741/8740 (9335 Ver1.24 or later), or other
Operating environment	Computer running under Windows 8/7 (32/64-bit), Vista (32-bit), XP, 2000
Display functions	Waveform display, X-Y display, Digital value display, Cursor function, Scroll function, Maximum number of channels (32 channels analog, 32 channels logic), Gauge display (time, voltage axes), Graphical display
File loading	Readable data formats (MEM, REC, RMS, POW), Maximum loadable file size: Maximum file size that can be saved by a given device (file size may be limited depending on the computer configuration)
Data conversion	Conversion to CSV format , Tab delimited, Space delimited, Data culling (simple), Convert for specified channel, Batch conversion of multiple files
Print functions	Printing image file output (expanded META type, "EMF"), Supported printer: usable on any printer supported by operating system Print formatting: (1 up, 2-to-16 up, 2-to-16 rows, X-Y 1-to-4 up, preview, hard copy)
Other	Parameter calculation, Search, Clipboard copy, Launching of other applications

Maximum Recording Time for the internal memory (At MEMORY Function)

Time axis	5μs/div	10μs/div	20μs/div	50μs/div	100μs/div	200μs/div	500μs/div	1ms/div	2ms/div	5ms/div	10ms/div	20ms/div	50ms/div
Sampling period	50ns	100ns	200ns	500ns	1μs	2μs	5μs	10μs	20μs	50μs	100μs	200μs	500μs
Recording Time	0.8s	1.6s	3.2s	8s	16s	32s	1min 20s	2min 40s	5min 20s	13min 20s	26min 40s	53min 20s	2h 13min 20s
Time axis	100ms/div	200ms/div	500ms/div	1s/div	2s/div	5s/div	10s/div	30s/div	50s/div	1min/div	100s/div	2min/div	5min/div
Sampling period	1ms	2ms	5ms	10ms	20ms	50ms	100ms	300ms	500ms	600ms	1.0s	1.2s	3.0s
Recording Time	4h 26min 40s	8h 53min 20s	22h 13min 20s	1d 20h 26min 40s	3d 16h 53min 20s	9d 06h 13min 20s	18d 12h 06min 40s	55d 13h 20min 00s	92d 14h 13min 20s	111d 02h 40min 00s	185d 04h 26min 40s	222d 05h 20min 00s	555d 13h 20min 00s

Configuration of options



MR8740



MR8741

Input modules

Input cables are not supplied. Please purchase the appropriate cable for the intended application.

Install by inserting into the main unit. Can be replaced by user.

ANALOG UNIT	8966
TEMP UNIT	8967
HIGH RESOLUTION UNIT	8968
STRAIN UNIT	8969
<i>CONVERSION CABLE 9769, Two cables included</i>	
FREQ UNIT	8970
CURRENT UNIT	8971
DC/RMS UNIT	8972
LOGIC UNIT	8973
DVM UNIT	MR8990

For individual units' specifications, see pages 6 and 7.

Voltage measurement

*Input voltages are limited to the voltage specifications of the input unit to which the cord, clip, or probe is attached.



CONNECTION CORD L9198
φ 5.0 mm (0.20 in) dia., cable allowing for up to 300 V input. 1.7 m (5.58 ft) length, small alligator clip

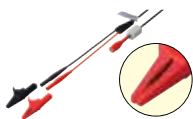

CONNECTION CORD 9197
φ 5.0 mm (0.20 in) dia., cable allowing for up to 600 V input. 1.8 m (5.91 ft) length, a detachable large alligator clips are bundled



GRABBER CLIP 9243
Attaches to the tip of the Cord 9197, Red/Black set, 196 mm (7.72 in) length

High-Voltage measurement - requires separate power supply shown below



DIFFERENTIAL PROBE 9322
For up to 2 kV DC or 1 kV AC. Use with either AC Adapter 9418-15



AC ADAPTER 9418-15
For powering Differential probe 9322, 100 to 240 V AC

Voltage measurement for MR8990



TEST LEAD L2200
One set (Redx1, Blackx1) 70cm (2.30ft) length
Max. allowable input: CAT IV 600V, CAT III 1000V

Current measurement

* Use a conversion cable to power via the 8971 Current Unit, or power with the 9555-10 Sensor Unit when used with other analog units.



AC/DC CURRENT SENSOR 9709
Pass through & high precision type, observe waveforms from DC to distorted AC. DC to 100kHz response, input 500A / output 2V AC



UNIVERSAL CLAMP ON CT 9279
Observe waveforms from DC to distorted AC. DC to 20kHz response, input 500A / output 2V AC
*Not CE marked



AC/DC CURRENT SENSOR CT6863
Pass through & high precision type, observe waveforms from DC to distorted AC. DC to 500kHz response, input 200A / output 2V AC



UNIVERSAL CLAMP ON CT 9278
Observe waveforms from DC to distorted AC. DC to 100kHz response, input 200A / output 2V AC



AC/DC CURRENT SENSOR CT6862
Pass through & high precision type, observe waveforms from DC to distorted AC. DC to 1MHz response, input 50A / output 2V AC



UNIVERSAL CLAMP ON CT 9277
Observe waveforms from DC to distorted AC. DC to 100kHz response, input 20A / output 2V AC



SENSOR UNIT 9555-10
Power supply unit for the 9272-10 to the 9279 clamp sensors, except for connecting to the Current unit 8971, for signal output L9217 is necessary.



CLAMP ON SENSOR 9272-10
Enables observation of AC current waveforms. Input: 1 to 100kHz, selectable 20 and 200A rms ranges, 2V AC output



CONNECTION CORD L9217
Cord has insulated BNC connectors at both ends, and connects to the 9555-10 and input module.

Current measurement

*Connect directly to the analog input module



CLAMP ON PROBE 3276
DC to 100MHz wideband response, mA-class current up to 30A rms



CLAMP ON PROBE 3273-50
DC to 50MHz wideband response, mA-class current up to 30A rms



CLAMP ON PROBE 3275
DC to 2MHz wideband response, mA-class current up to 500A rms



POWER SUPPLY 3272
Connect and power up to one CLAMP ON PROBE to use in combination with voltage input modules



CLAMP ON PROBE 3274
DC to 10MHz wideband response, mA-class current up to 150A rms



POWER SUPPLY 3269
Connect and power up to four CLAMP ON PROBES to use in combination with voltage input modules

*The 3273-50, 3274, 3275, and 3276 cannot be used with the 8971 Current Unit.

Current measurement

* For commercial power lines, 50/60Hz (separate power supply not required)



CLAMP ON PROBE 9018-50
Enables observation of AC current waveforms, 40 Hz to 3 kHz response, input 10 A to 500 A range, output 0.2 V AC/range



CLAMP ON PROBE 9132-50
Enables observation of AC current waveforms, 40 Hz to 1 kHz response, input 20 A to 1000 A range, output 0.2 V AC/range

Logic signal measurement



LOGIC PROBE 9327
4-channel type, for voltage/contact signal ON/OFF detection (response pulse width 100 ns or more, miniature terminal type)



LOGIC PROBE MR9321-01
4 isolated channels, ON/OFF detection of AC/DC voltage (miniature terminal type)



LOGIC PROBE 9320-01
4-channel type, for voltage/contact signal ON/OFF detection (response pulse width 500 ns or more, miniature terminal type)



CONVERSION CABLE 9323
Used for connecting the 9320/9321/ MR9321 and the 9324 relay to the Memory HiCorder with small logic terminal models

PC Software

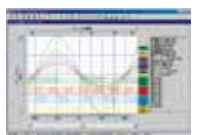

WAVE PROCESSOR 9335
Convert data, print and display waveforms. Windows 8/7 (32-bit/64-bit), Windows Vista (32-bit), XP, 2000

Other options



CONVERSION ADAPTER 9199
Female banana terminals to BNC plug (output), use to connect to BNC terminal on Input Module



LAN CABLE 9642
Straight Ethernet cable, supplied with straight to cross conversion adapter, 5 m (16-4 ft) length

Also available: MR8847 MEMORY HiCORDER series

Same specifications as the MR8741!

Featuring a built-in display and printer



- Portable recorder is designed for maximum mobility.
- Record data to a CF card and the built-in hard disk.
- X-Y recorder functionality.
- Available in three models with different memory capacities.

Cannot be used with the MR8990 DVM Unit.

Note: Company names and Product names appearing in this catalog are trademarks or registered trademarks of various companies.

HIOKI

HIOKI E. E. CORPORATION

HEADQUARTERS:

81 Koizumi, Ueda, Nagano, 386-1192, Japan
TEL +81-268-28-0562 FAX +81-268-28-0568
http://www.hioki.com / E-mail: os-com@hioki.co.jp

HIOKI USA CORPORATION:

TEL +1-609-409-9109 FAX +1-609-409-9108
http://www.hiokiusa.com / E-mail: hioki@hiokiusa.com

HIOKI (Shanghai) SALES & TRADING CO., LTD.:

TEL +86-21-63910090 FAX +86-21-63910360
http://www.hioki.cn / E-mail: info@hioki.com.cn

HIOKI INDIA PRIVATE LIMITED:

TEL +91-124-6590210 FAX +91-124-6460113
E-mail: hioki@hioki.in

HIOKI SINGAPORE PTE. LTD.:

TEL +65-6634-7677 FAX +65-6634-7477
E-mail: info@hioki.com.sg

HIOKI KOREA CO., LTD.:

TEL +82-42-936-1281 FAX +82-42-936-1284
E-mail: info-kr@hioki.co.jp

DISTRIBUTED BY