

# ST5520

# HIOKI

# ST5520-01

## Instruction Manual

# INSULATION TESTER



**Be sure to read this manual before using the instrument.**

Safety Notes

▶ p.3



**When using the instrument for the first time**

Parts Names and Functions ▶ p.17

Basic Settings ▶ p.33



**Troubleshooting**

Maintenance and Service ▶ p.169

Troubleshooting ▶ p.171

Error display and solutions ▶ p.175

## EN

Jan. 2020 Revised edition 5  
ST5520A981-05 20-01H





# Contents

Introduction.....	1
Verifying Package Contents .....	1
Safety Notes.....	3
Usage Notes.....	7

## **1 Overview** **15**

<b>1.1 Product Overview and Features .....</b>	<b>15</b>
■ Overview .....	15
■ Features .....	16
<b>1.2 Parts Names and Functions.....</b>	<b>17</b>
<b>1.3 Measurement Workflow.....</b>	<b>19</b>
<b>1.4 Screen Configuration and Operation Overview .....</b>	<b>20</b>
■ Measurement screen.....	20
■ Settings screen.....	21

## **2 Preparations** **23**

<b>2.1 Connecting the Power Cord.....</b>	<b>23</b>
<b>2.2 Connecting the Measurement Leads .....</b>	<b>24</b>
■ Removing and attaching the sleeves .....	25
<b>2.3 Connecting to the Equipment to be Measured.....</b>	<b>26</b>
<b>2.4 Turning the Power On and Off .....</b>	<b>26</b>
■ Turning on the power .....	26
■ Turning off the power.....	26
<b>2.5 Pre-Operation Inspection .....</b>	<b>27</b>
■ Checking the insulation resistance test.....	28
■ Checking the contact check function.....	29

## **3 Basic Settings** **33**

<b>3.1 Setting the Test Voltage.....</b>	<b>34</b>
--	-----------

<b>3.2</b>	<b>Setting the Range.....</b>	<b>36</b>
<b>3.3</b>	<b>Switching the Measurement Speed (FAST/SLOW) .....</b>	<b>38</b>
<b>3.4</b>	<b>Setting the Test Duration and Response Time.....</b>	<b>39</b>
■	Setting how long to apply the test voltage.....	39
■	Setting the response time.....	41
<b>3.5</b>	<b>Judging Measured Values (Comparator function) .....</b>	<b>44</b>
<b>3.6</b>	<b>Setting the Test Mode .....</b>	<b>46</b>
<b>3.7</b>	<b>Announcing the Judgment Results Using a Beep Sound.</b>	<b>47</b>
<b>4</b>	<b>Testing</b>	<b>49</b>
<b>4.1</b>	<b>Starting Measurements .....</b>	<b>49</b>
<b>4.2</b>	<b>During Measurement .....</b>	<b>51</b>
<b>4.3</b>	<b>Measured Value Display .....</b>	<b>52</b>
<b>4.4</b>	<b>Completing Measurement .....</b>	<b>53</b>
<b>4.5</b>	<b>Automatic Discharge Function .....</b>	<b>54</b>
<b>5</b>	<b>Useful Functions</b>	<b>55</b>
<b>5.1</b>	<b>Checking Faulty Contact and Contact Status (Contact check function).....</b>	<b>56</b>
■	Connecting test leads.....	58
■	Example of connection to equipment to be measured .....	58
■	2-terminal contact check function.....	59
<b>5.2</b>	<b>Checking Short Circuit before Applying the Set Voltage (Short circuit check function) .....</b>	<b>60</b>
<b>5.3</b>	<b>Enabling/Disabling the Key Operations .....</b>	<b>65</b>
<b>5.4</b>	<b>Setting the Key Operation Sound.....</b>	<b>67</b>
<b>5.5</b>	<b>Preventing Operation Errors at the Start of Testing (Double action function).....</b>	<b>68</b>
<b>5.6</b>	<b>Adjusting the Screen Contrast .....</b>	<b>69</b>
<b>5.7</b>	<b>Adjusting the Backlight .....</b>	<b>70</b>
<b>5.8</b>	<b>Setting the Frequency of Power Supply Manually.....</b>	<b>71</b>
<b>5.9</b>	<b>Initializing the System (Reset) .....</b>	<b>72</b>

5.10	Default Setting List .....	73
------	----------------------------	----

## **6 Saving and Loading Measurement Conditions (Memory function) 75**

6.1	Saving the Measurement Conditions (Panel save function) .....	76
-----	--	----

6.2	Loading the Measurement Conditions (Panel load function) .....	77
-----	---	----

6.3	Changing the Panel Name .....	78
-----	-------------------------------	----

6.4	Deleting the Panel Data .....	79
-----	-------------------------------	----

## **7 External Control (EXT.I/O) 81**

7.1	External Input/Output Terminal and Signals .....	82
-----	--	----

■	Switching between current sink (NPN) and current source (PNP) .....	82
---	---	----

■	Connector type and signal pinouts .....	83
---	---	----

■	Signal descriptions .....	86
---	---------------------------	----

7.2	Timing Chart .....	88
-----	--------------------	----

7.3	Internal Circuit Configuration .....	96
-----	--------------------------------------	----

■	Electrical specifications .....	98
---	---------------------------------	----

■	Connection examples .....	99
---	---------------------------	----

7.4	Setting the TEST Signal OFF Timing .....	101
-----	--	-----

7.5	Checking External Control .....	103
-----	---------------------------------	-----

■	Performing an I/O test (EXT.I/O test function) .....	103
---	--	-----

7.6	Using Analog Output .....	104
-----	---------------------------	-----

■	Connecting the output cord .....	105
---	----------------------------------	-----

■	Setting the analog output .....	105
---	---------------------------------	-----

7.7	Interlock Function .....	106
-----	--------------------------	-----

7.8	Using the Switched Probe .....	108
-----	--------------------------------	-----

■	Connecting the 9299 Switched Probe .....	109
---	--	-----

7.9	Accessory Connector Assembly .....	111
-----	------------------------------------	-----

3

4

5

6

7

## **8 Communications (RS-232C interface) 113**

<b>8.1</b>	<b>Interface Overview and Features .....</b>	<b>113</b>
<b>8.2</b>	<b>Using the RS-232C Interface .....</b>	<b>114</b>
	■ Setting communications conditions .....	114
	■ Connecting the RS-232C cable .....	116
<b>8.3</b>	<b>Automatically Exporting Measured Values at the Ends of Tests (Data output function) .....</b>	<b>118</b>
<b>8.4</b>	<b>Controlling the Instrument and Acquiring Data with Commands.....</b>	<b>120</b>
	■ Remote and local states .....	120
	■ Displaying communications commands (Communications monitor function).....	121
<b>8.5</b>	<b>Data Format Table .....</b>	<b>126</b>
<b>8.6</b>	<b>Command Reference .....</b>	<b>127</b>

## **9 Specifications 153**

■	Environment and safety .....	153
■	Output (output accuracy).....	153
■	Resistance measurement .....	155
■	Input .....	156
■	Guaranteed accuracy .....	157
■	Test duration .....	157
■	Response time .....	159
■	Functions.....	159
■	External interface .....	162
■	Other specifications.....	165
■	Accessories .....	167
■	Options .....	167

## **10 Maintenance and Service 169**

<b>10.1</b>	<b>Maintenance .....</b>	<b>169</b>
<b>10.2</b>	<b>Troubleshooting .....</b>	<b>171</b>

■ Error display and solutions ..... 175

**Appendix** **Appx.1**

Appx. 1 Block Diagram ..... Appx.1  
 Appx. 2 Contact Check Function ..... Appx.2  
 Appx. 3 Output Voltage and Measurement Resistance ... Appx.3  
 Appx. 4 Influence of Capacitive Load ..... Appx.4  
 Appx. 5 Influence of Cable Length ..... Appx.6  
 Appx. 6 Influence of Noise ..... Appx.7  
 Appx. 7 Changes in Current Running through Insulator  
 ..... Appx.10  
 Appx. 8 Rack Mounting ..... Appx.12  
 Appx. 9 Dimensional Diagram ..... Appx.16

**Index** **Ind.1**







## Introduction

Thank you for choosing the HIOKI ST5520/ST5520-01 Insulation Tester. To obtain maximum performance from the product, please read this manual first, and keep it handy for future reference.

The ST5520-01 is equipped with the BCD output function of the ST5520. The artwork of the ST5520 is used in this manual.

## Verifying Package Contents

When you receive the instrument, inspect it carefully to ensure that no damage occurred during shipping. In particular, check the accessories, panel switches, and connectors. If damage is evident, or if it fails to operate according to the specifications, contact your authorized Hioki distributor or reseller.

Check the package contents as follows.

- ST5520 or ST5520-01  
Insulation Tester ..... 1
- Power cord ..... 1
- Instruction Manual (this document) ..... 1
- EXT.I/O connector (pin contacts)..... 1
- EXT.I/O connector cover..... 1 set

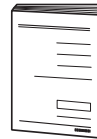
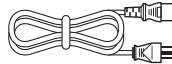
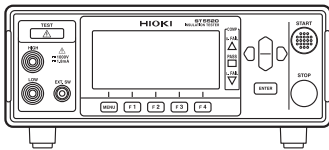

Instruction manuals may also be available in other languages.

Please visit our website at <http://www.hioki.com>.

## Options

The following options are available for ST5520/ST5520-01. Contact your authorized Hioki distributor or reseller when ordering.

The options are subject to change. Visit our website for updated information.

- L2200 Test Lead

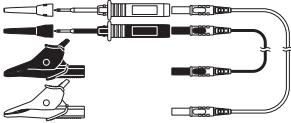

- L9257 Connection Cord

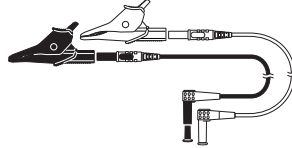

- 9299 Switched Probe

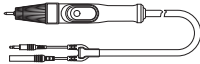

- 9094 Output Cord (analog output)

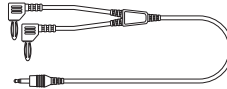

- 9637 RS-232C Cable (9pin-9pin/1.8 m)

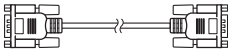

- 9638 RS-232C Cable (9pin-25pin/1.8 m)

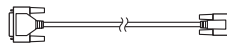

## Safety Notes

This instrument is designed to conform to IEC 61010 Safety Standards, and has been thoroughly tested for safety prior to shipment. However, using the instrument in a way not described in this manual may negate the provided safety features.

Before using the instrument, be certain to carefully read the following safety notes.

### **DANGER**



**Mishandling during use could result in injury or death, as well as damage to the instrument. Be certain that you understand the instructions and precautions in the manual before use.**







### **WARNING**









**With regard to the electricity supply, there are risks of electric shock, heat generation, fire, and arc discharge due to short circuits. If persons unfamiliar with electricity measuring instruments are to use the instrument, another person familiar with such instruments must supervise operations.**

## Notation



In this manual, the risk seriousness and the hazard levels are classified as follows.

 <b>DANGER</b>	Indicates an imminently hazardous situation that will result in death or serious injury to the operator.
 <b>WARNING</b>	Indicates a potentially hazardous situation that may result in death or serious injury to the operator.
 <b>CAUTION</b>	Indicates a potentially hazardous situation that may result in minor or moderate injury to the operator or damage to the instrument or malfunction.
<b>IMPORTANT</b>	Indicates information related to the operation of the instrument or maintenance tasks with which the operators must be fully familiar.
	Indicates a high voltage hazard. If a particular safety check is not performed or the instrument is mishandled, this may give rise to a hazardous situation; the operator may receive an electric shock, may get burnt or may even be fatally injured.
	Indicates prohibited actions.
	Indicates the action which must be performed.
*	Additional information is presented below.
[□]	Indicates set items and buttons on the display in [□].
<b>SET</b> (Boldface)	Bold-faced alphanumeric characters in the text indicate characters shown on the operation keys.

## Symbols affixed to the instrument

	Indicates cautions and hazards. When the symbol is printed on the instrument, refer to a corresponding topic in the Instruction Manual.
	Indicates that dangerous voltage may be present at this terminal.
	Indicates the power "ON".
	Indicates the power "OFF".
	Indicates DC (Direct Current).
	Indicates AC (Alternating Current).

## Symbols for various standards

	Indicates the Waste Electrical and Electronic Equipment Directive (WEEE Directive) in EU member states.
	Indicates that the instrument conforms to regulations set out by the EU Directive.

## Accuracy

We define measurement tolerances in terms of f.s. (full scale), rdg. (reading), and dgt. (digit) values, with the following meanings:

<b>f.s.</b>	(Maximum display value, scale length) The maximum display value or the full length of the scale. This is usually the maximum value of the currently selected range.
<b>rdg.</b>	(Reading or displayed value) The value currently being measured and indicated on the measuring instrument.
<b>dgt.</b>	(Resolution) The smallest displayable unit on a digital measuring instrument, i.e., the input value that causes the digital display to show a "1" as the least-significant digit.

## Measurement categories

To ensure safe operation of measuring instruments, IEC 61010 establishes safety standards for various electrical environments, categorized as CAT II to CAT IV, and called measurement categories.

### DANGER



- Using a measuring instrument in an environment designated with a higher-numbered category than that for which the instrument is rated could result in a severe accident, and must be carefully avoided.
- Using a measuring instrument without categories in an environment designated with the CAT II to CAT IV category could result in a severe accident, and must be carefully avoided.

- CAT II: When directly measuring the electrical outlet receptacles of the primary electrical circuits in equipment connected to an AC electrical outlet by a power cord (portable tools, household appliances, etc.)
- CAT III: When measuring the primary electrical circuits of heavy equipment (fixed installations) connected directly to the distribution panel, and feeders from the distribution panel to outlets
- CAT IV: When measuring the circuit from the service drop to the service entrance, and to the power meter and primary overcurrent protection device (distribution panel)

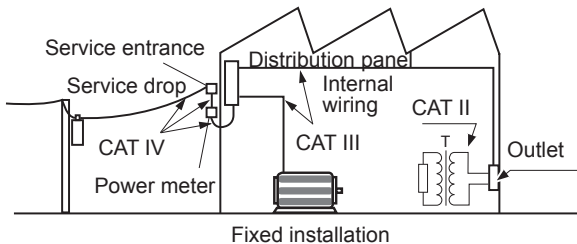

## Usage Notes

Follow these precautions to ensure safe operation and to obtain the full benefits of the various functions.

### Preliminary checks

#### DANGER

If the probe or the instrument is damaged, there is a risk of electric shock. Before using the instrument, perform the following inspection.



- Before using the instrument, check that the coating of the probes are neither ripped nor torn and that no metal parts are exposed. Using the instrument under such conditions could result in electric shock. Replace the probes with those specified by our company.
- Before using the instrument the first time, verify that it operates normally to ensure that no damage occurred during storage or shipping. If you find any damage, contact your authorized Hioki distributor or reseller.

### Installation

Installing the instrument in inappropriate locations may cause a malfunction of instrument or may give rise to an accident. Avoid the following locations.

For details on the operating temperature and humidity, refer to the specifications. (p. 153)

#### CAUTION



- Exposed to direct sunlight or high temperature
- Exposed to corrosive or combustible gases
- Exposed to water, oil, chemicals, or solvents
- Exposed to high humidity or condensation
- Exposed to high quantities of dust particles
- Susceptible to vibration

### Installation precaution

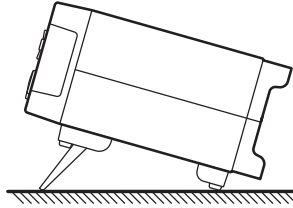

#### CAUTION



Do not position the instrument on an unstable table or inclined surface. If the instrument falls or tips, a malfunction of the instrument or injury may be caused.

### Handling the instrument

#### DANGER



To avoid electric shock, do not remove the instrument's case. The internal components carry high voltage and high temperature.

#### WARNING



Customers are not allowed to modify, disassemble, or repair the instrument. Doing so may cause fire, electric shock, or injury.

#### CAUTION



- To avoid damage to the instrument, protect it from vibrations and physical shock when transporting and handling. Be especially careful to avoid physical shock from dropping.
- To avoid damage to the instrument, do not apply voltage or current to EXT.SW terminal, analog output terminal, or maintenance terminal.

This instrument may cause interference if used in residential areas. Such use must be avoided unless the user takes special measures to reduce electromagnetic emissions to prevent interference to the reception of radio and television broadcasts.



## Handling the cords and leads

### DANGER



To avoid electric shock, be careful to avoid shorting live lines with the test leads.

### WARNING



Before using the instrument, check that the coating of the cords are not either ripped or torn and that no metal parts are exposed. If any damage is found, contact your authorized Hioki distributor or reseller to prevent electric shock.

- To avoid electric shock, do not exceed the lower of the ratings shown on the instrument and measurement leads.

### CAUTION



- To avoid damage to the instrument, do not short connectors or output components or input voltage.
- To avoid damage to the instrument, do not apply voltage or current to the analog output terminal or EXT.SW terminal.
- Avoid stepping on or pinching the cables, which could damage the cable insulation.
- To avoid breaking cables or lead wires, do not bend or pull them at the base.
- Bare conductors could be exposed if the insulation melts. Do not touch the heat sources.

To avoid electric shock and damage to the instrument, observe the cautions listed below when connecting the analog output terminal, RS-232C connector, and EXT.I/O terminal.



- Always turn off the power on the instrument and on any devices to be connected before making connections.
- Be careful to avoid exceeding the rating of the analog output terminal, RS-232C connector, or EXT.I/O terminal signal.
- During operation, a wire becoming dislocated and contacting another conductive object can cause serious hazard. Use screws to secure the external connectors.
- Properly isolate the devices and equipment to which the analog output terminal, RS-232C connector, and EXT.I/O terminal are connected.
- To avoid damaging the cord, grasp the plug, not the cord, when unplugging the output connector.
- The cables can become hard in the environment at a temperature of 0°C or lower. When the cables are bent or pulled, the coating of the cables may become damaged or may break.

**IMPORTANT**

When using the instrument, be sure to use the connecting lead wires, etc. specified by our company. When other cords and lead wires are used, accurate measurement may not be possible because the connection becomes poor, etc.

**Before connecting the power cord**

 **WARNING**



- To avoid electric shock and to maintain the safety specifications of this instrument, connect the power cord provided only to a 3-contact (two-conductor + ground) outlet.
- Use only the designated power cord with this instrument. Use of other power cords may cause fire.

 **CAUTION**



To avoid damaging the power cord, grasp the plug, not the cord, when unplugging it from the power outlet.

**IMPORTANT**

Turn off the power before disconnecting the power cord.

**Before connecting measurement leads**

 **DANGER**



To avoid electric shock and short circuit accidents, turn off all power of the measurement target before connecting measurement leads.

 **WARNING**



To avoid electrical accidents, use the designated wires or ones with more than enough dielectric strength and current capacity.

Cable insulation material:	Polyethylene (PE)
Cable insulation withstand voltage:	1000 V DC or higher
Recommended cable:	AWM 3239, AWG 22

## Before connecting switched probes

### CAUTION



To avoid damage to the probes, do not bend or pull the probe base.



To ensure safe operation, use only the probes specified by our company.

## Residual risk

### WARNING



The test leads generate high voltage. To avoid electric shock, do not touch the metal ends of the test leads.

### CAUTION



The ends of the probes are sharp. Be careful to avoid injury.

## Before connecting data cables

### WARNING



- Failure to fasten the connectors properly may result in sub-specification performance or damage to the equipment.
- Always turn off both devices when connecting and disconnecting an interface connector. Otherwise, an electric shock accident may occur.

**⚠ CAUTION**

- To avoid equipment failure, do not disconnect the connecting data cable while communications are in progress.
- Use a common ground for both the instrument and the computer. Using different ground circuits will result in a potential difference between the instrument's ground and the computer's ground. If the connecting data cable is connected while such a potential difference exists, it may result in equipment malfunction or failure.
- Before connecting or disconnecting any connecting data cable, always turn off the instrument and the computer. Failure to do so could result in equipment malfunction or damage.
- After connecting the connecting data cable, tighten the screws on the connector securely. Failure to secure the connector could result in equipment malfunction or damage.

**Before switching between current sink (NPN) and current source (PNP)****⚠ CAUTION**

Do not operate the EXT.I/O mode switch (NPN/PNP) while the instrument is on.



Configure the NPN/PNP setting to accommodate externally connected equipment.

**Before connecting EXT.I/O****⚠ WARNING**

- **External power cannot be supplied to the instrument's EXT.I/O connector. Do not apply external power. (The ISO\_5V pin of the EXT. I/O connector is a 5 V (NPN)/-5 V (PNP) power output.)**

To avoid electric shock or damage to the equipment, always observe the following precautions when connecting to the EXT.I/O connector.



- **Always turn off the main power switch on the instrument and on any devices to be connected before making connections.**
- **Be careful to avoid exceeding the ratings of external terminals. (p.162) During operation, a wire becoming dislocated and contacting another conductive object can cause serious hazard. Use screws to secure the external connectors.**

**⚠ CAUTION**

- To avoid damage to the instrument, observe the following cautions:
- Do not short circuit ISO\_5V and ISO\_COM.

**⚠ CAUTION**

- When connecting the relay coil to the EXT.I/O output terminal, be sure to install diodes to absorb current-electromotive force.

**Before turning the power on****⚠ WARNING**

- While insulation resistance is being measured or the **START** key is pressed, hazardous voltage may be generated in the measurement terminal. To avoid electric shock, do not touch the measurement leads.



- Before turning the instrument on, make sure that the supply voltage matches that indicated on its power connector. Connection to an improper supply voltage may damage the instrument and present electrical hazard.

**⚠ CAUTION**

- Avoid using an uninterruptible power supply (UPS) or DC/AC inverter with rectangular wave or pseudo-sine-wave output to power the instrument. Doing so may damage the instrument.



- When connecting to the measurement object or not using the instrument, be sure to unplug the power cord from the instrument and completely disconnect it from the power supply for safety.
- Do not connect a wrong power voltage. Doing so may damage the internal circuit.

**IMPORTANT**

- Turn off the power before disconnecting the power cord.
- To suppress noise, it is necessary to switch the power frequency setting on the instrument. Set the frequency to the frequency of the commercial power supply to be used before starting the measurement.  
In the manual setting, a measured value does not stabilize unless the power frequency setting is switched properly.

**Precautions during shipment**

Observe the following during shipment.

Hioki cannot be responsible for damage that occurs during shipment.

 **CAUTION**



When shipping the instrument, use the packaging materials used when the instrument is delivered.

### Overview

---

The HIOKI ST5520/ST5520-01 Insulation Tester is an insulation resistance tester that performs insulation resistance testing on components and equipment using direct current voltage.

The test duration is 50 ms at the fastest and high speed testing can be performed. Because this Insulation Tester is equipped with selectable test voltages and EXT.I/O, RS-232C interface, and analog output terminal, it can be used in various fields including production and inspection lines as well as laboratories.

## Features

---

### Test duration 50 ms (fastest)

Judgment results can be displayed in 50 ms at the fastest.

### Selectable test voltage

The test voltage can be selected from 25 V to 1000 V in increments of a resolution of 1 V. The comparator function (p.44) and test duration function (p.39) support a wide variety of insulation resistance testing according to safety standards.

### Easy-to-read display

High definition LCD display for a high level of visibility

### Saved setting conditions

Up to ten patterns of test conditions can be saved. When the power is turned on again after it is turned off, the settings before the power is turned off are replicated. (p.76)

### External interface

EXT.I/O outputs a signal according to the ST5520/ST5520-01 status. The start/stop signal input and test conditions can be selected. Extended insulation resistance fluctuation can be recorded when analog output is used. (p.81)

### Equipped with RS-232C interface

A personal computer (PC) can be connected for automated testing and recording test results. (p.120)

### Switched probe

The optional 9299 Switched Probe enables efficient manual testing.

### Automatic discharge function

Any charge remaining in pieces of equipment to be measured is released inside the instrument after tests. As the TEST lamp blinks during discharge, the discharge status can be checked.  
Equipment can be protected from possible damage during successive insulation resistance testing.



# 1.2 Parts Names and Functions

## Front panel

Measurement terminals (p.24)

TEST lamp (p.49)

Display screen (Monochrome graphical LCD)

△ Refer to p.10.

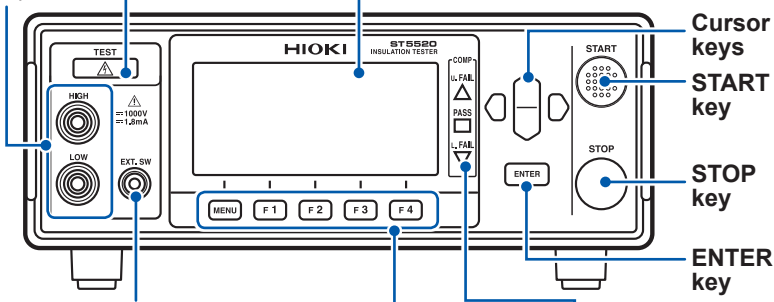

EXT.SW terminal (p.109)  
For 9299 Switched Probe

**MENU key**  
 Switching of pages

**F keys**  
    Selection of settings displayed on the screen

**COMP lamps (p.44)**

- U.FAIL Upper limit value ≤ Measured value
- PASS Within judgment standard
- L.FAIL Lower limit value ≥ Measured value

## Rear panel

Power switch (p.26)

RS-232C connector (p.116)

Maintenance terminal (Do not use.)

EXT.I/O mode switch (NPN/PNP) (p.82)

Left: Current sink (NPN), Right: Current source (PNP)

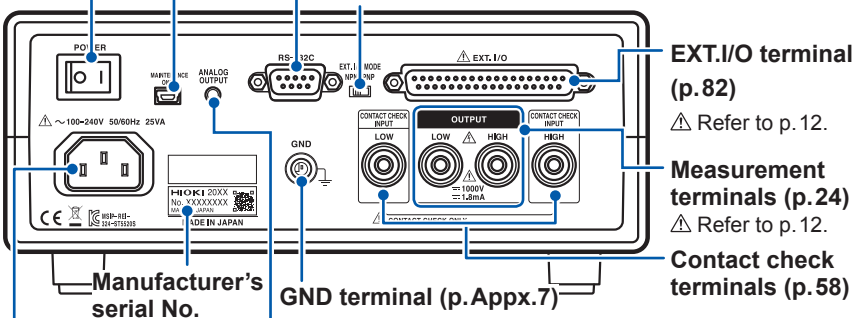

Power inlet (p.23)

Analog output terminal (p.105)

△ Refer to p.10.

For 9094 Output Cord

### Bottom panel

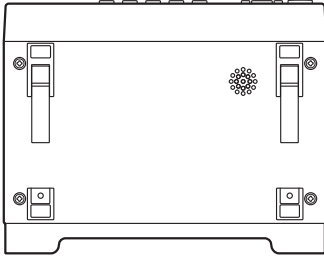

This instrument can be rack-mounted.  
Refer to “Appx. 8 Rack Mounting” (p.Appx.12).

The parts removed from this instrument  
should be stored in a safe place for future  
reuse.

### Side panel

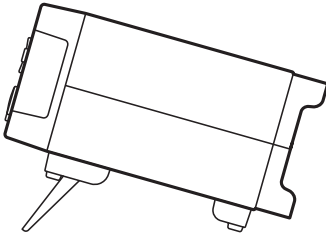

#### When using the stand

Extend the legs all the way.  
Make sure to extend both legs of the stand.

#### When collapsing the stand

Do not collapse the stand partway. Be sure to  
collapse it all the way.

### CAUTION



When the instrument is set on the stand, do not apply a strong force from  
above. Doing so may damage the stand.

## 1.3 Measurement Workflow

Be sure to refer to “Usage Notes” (p.7) before use.

1

### 1 Preparing for measurement (p.23)

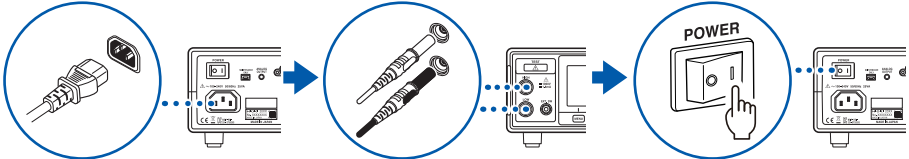

(Use the measurement terminals on the rear panel in case of 4-terminal measurements.)

### 2 Checking before measurement (p.27)

### 3 Setting measurement conditions (p.33)

Item	Description	Reference
Test voltage	Select from 25 V to 1000 V.	p.34
Resistance range	Select either manual range (2 M $\Omega$ , 20 M $\Omega$ , 200 M $\Omega$ , 2000 M $\Omega$ , 4000 M $\Omega$ ) or auto range.	p.36
Measurement speed	Select either FAST or SLOW.	p.38
Test duration	Set how long to apply the test voltage (test duration function).	p.39
	Set the response time.	p.41
Comparator (upper/lower limit values)	Set the upper/lower resistance values.	p.44
Test mode	Select from continuous mode, FAIL STOP mode, PASS STOP mode, or forced termination judgment mode.	p.46
Beep sound	Set the conditions to announce the judgment result with a beep sound.	p.47

### 4 Performing measurement

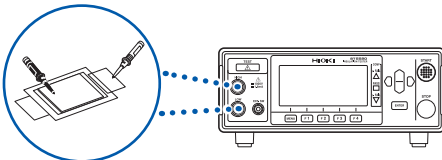

### 5 Turning off the power after use

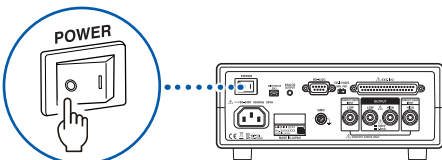

# 1.4 Screen Configuration and Operation Overview

This instrument consists of a measurement screen and various settings screens. The screen examples in this manual appear reversed (black on white) for best visibility. The instrument screens, however, can actually be displayed only as white characters on a black background.

## Measurement screen

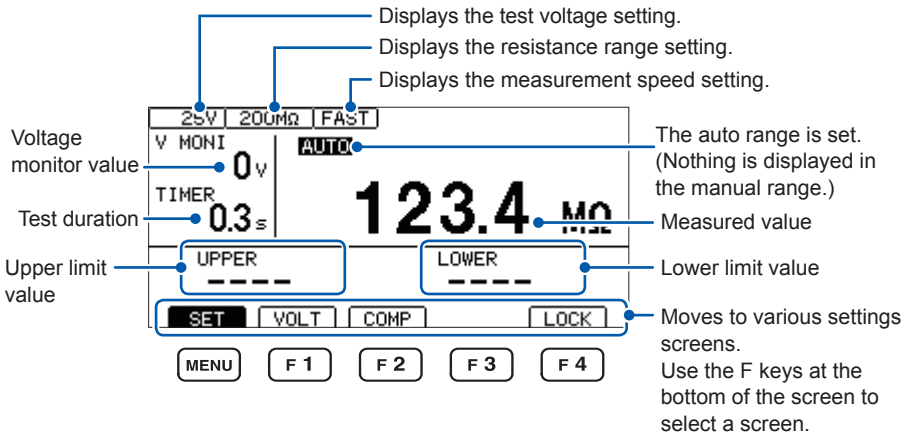

### F key set items

<b>SET</b>	Moves to the Settings screen. (p.33)
<b>VOLT</b>	Moves to the Test Voltage Settings screen. (p.34)
<b>COMP</b>	Moves to the Comparator Settings screen. (p.44)
<b>LOCK</b>	Executes the key lock function. (p.65)

## Settings screen

### MEAS (MEAS screen)

Setting the test voltage (p.34)	MEAS	SYS	PANEL	I/O	IF
Setting the range (p.36)	VOLTAGE		0025	V	
Setting the measurement speed (p.38)	RANGE		AUTO		
Setting the test duration (p.39)	SPEED		FAST		
Setting the response time (p.41)	TIMER		OFF		
Setting the test mode (p.46)	DELAY		AUTO		
Setting the beep sound (p.47)	COMP MODE		CONTINUE		
	COMP BEEP		FAIL		
	EXIT				

### SYS (SYS screen)

Setting the contact check function (p.56)	MEAS	SYS	PANEL	I/O	IF
Setting the short circuit check function (p.60)	CONTACT CHECK			OFF	
Setting the key beeper (p.67)	SHORT CHECK			OFF	
Setting the double action function (p.68)	KEY CLICK			ON	
Setting the screen contrast (p.69)	DOUBLE ACTION			OFF	
Setting the backlight (p.70)	CONTRAST			50	
Setting the power frequency (p.71)	BACKLIGHT			2	
Initializing the system (p.72)	POWER FREQ			AUTO	
	RESET			EXEC	
	EXIT				

### PANEL (PANEL screen)

Setting the panel save/panel load (p.75)	MEAS	SYS	PANEL	I/O	IF
	01	-----			
	02	-----			
	03	-----			
	04	-----			
	05	-----			
	06	-----			
	07	-----			
	08	-----			
	EXIT				

**I/O** (I/O screen)

- Setting the analog output range (p. 104) —
- Setting the Switched Probe operation (p. 108) —
- Setting the test signal OFF timing (p. 101) —
- Setting the INTERLOC test function (p. 108) —
- Setting the EXT.I/O test function (p. 103) —

MEAS	SYS	PANEL	I/O	IF
			ANALOG OUT RANGE	FULL
			EXT SWITCH MODE	CONT
			EXT I/O TEST-PIN	SLOW
			EXT I/O INTERLOCK	OFF
			EXT I/O TEST	EXEC
<b>EXIT</b>				

**IF** (IF screen)

- Setting the RS-232C interface (p. 114) —
- Setting the data output function (p. 118) —
- Setting the communications monitor function (p. 121) —

MEAS	SYS	PANEL	I/O	IF
			RS-232C SPEED	9600bps
			DATA OUT	OFF
			CMD MONITOR	OFF
<b>EXIT</b>				

**INFO** (INFO screen)

- Model name —
  - Version —
  - Manufacturer's serial No. —
- The serial number consists of 9 digits. The first two (from the left) indicate the year of manufacture, and the next two indicate the month of manufacture.

MEAS	SYS	PANEL	I/O	IF	INFO
			MODEL		ST5520
			VERSION		1.000
			SERIAL NO.		020140317
<b>EXIT</b>					

## 2 Preparations

### 2.1 Connecting the Power Cord

#### ⚠ CAUTION



To avoid electric shock and short circuits, use the voltage input cord supplied with the instrument.

Power switch

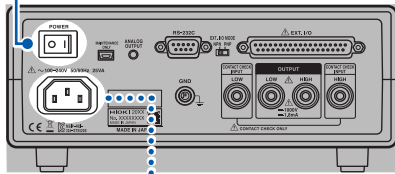

Power inlet

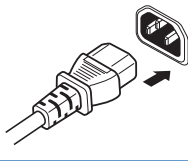

- 1 Check that the instrument power switch (rear panel) is OFF (○).
- 2 Check that the power supply voltage is within the display range (100 V to 240 V), and then connect the power cord to the power inlet.
- 3 Plug the power cord into the outlet.

## 2.2 Connecting the Measurement Leads

Connect the optional Hioki measurement leads to the measurement terminals. Refer to “Options” (p.2) for details.

Use the measurement leads (optional) specified by our company.

### Connecting to the measurement terminals on the front panel

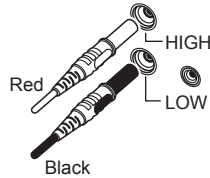
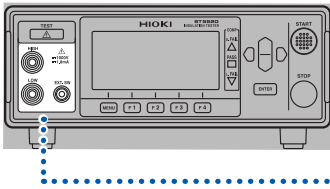

Connect the red plug to the HIGH terminal and the black plug to the LOW terminal.

### Connecting to the measurement terminals on the rear panel

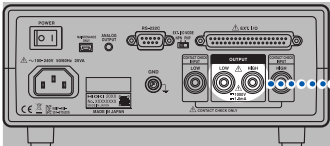

Connect the red plug to the inside HIGH terminal and the black plug to the inside LOW terminal. (Do not use the outside terminals on the both ends.)

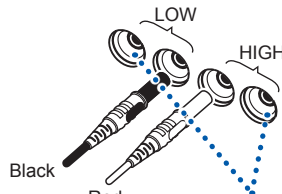

For contact check (p.58)

(Do not use for 2-terminal measurements.)

### ⚠ CAUTION



- When the HIGH terminal is short-circuited to the ground, the voltage of the LOW terminal will become high and it is dangerous for you to touch it. Do not touch the equipment to be measured, measurement leads, HIGH terminals, or LOW terminals during measurement (while the TEST lamp is blinking).
- During testing, the test voltage will be output simultaneously from the measurement terminals on the front of the instrument and the measurement terminals on the rear of the instrument. Do not connect any plugs to set of measurement terminals that is not in use.



## Removing and attaching the sleeves

### ⚠ CAUTION



The tips of the metal pins are sharp and may cause injury. Do not touch the tips.

The metal tips of the test leads are covered with the removable sleeves. The test leads can be used without the sleeves.

### Removing the sleeves

Hold the bottom of the sleeves and pull the sleeves off.

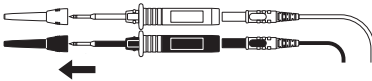

Safely store the removed sleeves so as not to lose them.

### Attaching the sleeves

Insert the metal pins of the test leads into the holes of the sleeves, and firmly push them all the way in. (Do not touch the tip of the pins.)

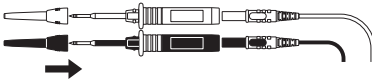

## 2.3 Connecting to the Equipment to be Measured

### WARNING



To avoid electric shock and to maintain the safety specifications of this instrument, connect the power cord provided only to a 3-contact (two-conductor + ground) outlet.

### IMPORTANT

- Use only the test leads specified by our company with this instrument. When other cords are used, accurate measurement may not be possible because the connection becomes poor, etc.
- When charged equipment to be measured is connected, the instrument may fail. Connect the test leads after the equipment to be measured is completely discharged.

### Example of connection to equipment to be measured

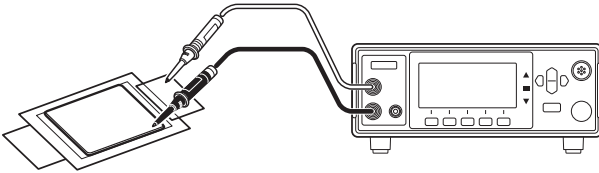

## 2.4 Turning the Power On and Off

### Turning on the power

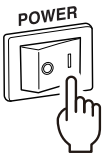

Turn ON ( I ) the power switch on the rear panel.

### Turning off the power

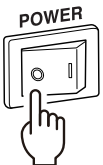

Turn OFF ( O ) the power switch on the rear panel.

## 2.5 Pre-Operation Inspection

Before using the instrument the first time, check that it operates normally to ensure that no damage occurred during storage or shipping. If any damage is found, contact your authorized Hioki distributor or reseller.

2

### Accessory and optional equipment inspection

Check item	Action
Is the power cord coating ripped or torn, or is any metal exposed?	Do not use the instrument if damage is found, as electric shock or short circuit accidents could result. Contact your authorized Hioki distributor or reseller.
Is the probe coating ripped or torn, or is any metal exposed?	Replace the probes with those specified by our company if damage is found, as electric shock could result.

### Instrument inspection

Check item	Action
Is there any damage to the instrument?	If damage is found, send out the instrument for repair.

### Insulation resistance test inspection

To ensure safe operation of the instrument, check the following before starting measurements.

- Checking the insulation resistance test (p.28)  
Check that the measured resistance matches the resistance value of the prepared resistor.
- Checking the contact check function (p.29)  
Check that the contact check function operates properly.

## Checking the insulation resistance test

### Required items

Recommended resistor: High voltage high resistance thick film resistor GS series  
Manufacturer: KOA Corporation or equivalent  
(Be careful with the working voltage and power.)

### ⚠ CAUTION



If the test voltage (power) exceeds the rated voltage (power) of the prepared resistor, the resistor may become damaged.

(Example) When the insulation resistance of the equipment to be measured is 100 MΩ

Maximum working voltage	1000 V
Rated power	0.5 W
Test voltage	500 V

- 1 Prepare a resistor.
- 2 Check that the test voltage is lower than the maximum working voltage of the prepared resistor.

Test voltage < Maximum working voltage of the prepared resistor  
(Example: 500 V < 1000 V)

- 3 Check that the value calculated from the test voltage and resistance is smaller than the rated power of the prepared resistor. (If the value calculated from the test voltage and resistance is larger than the rated power of the prepared resistor, change the resistor or the test voltage.)

Squared test voltage ÷ Resistance < Rated power of the prepared resistor  
(Example:  $\frac{500 \text{ V} \times 500 \text{ V}}{100 \text{ M}\Omega} = 0.0025 \text{ W} < 0.5 \text{ W}$ )

- 4 Set the test voltage to 500 V.
- 5 Set the lower limit value to 90 MΩ and the upper limit value to 110 MΩ.
- 6 Connect the test leads to the prepared resistor.
- 7 Start a test and check that the measured resistance matches the resistance of the prepared resistor and the comparator judgment result is [PASS].

## Checking the contact check function

### **WARNING**



**Test leads generate high voltage. To avoid electric shock, do not touch the metal ends of the test leads.**

**2**

Check that the contact check function operates properly.  
Check the following three items.

- Checking HIGH side contact (p.30)
- Checking LOW side contact (p.31)
- Checking the operation of the contact check function (p.32)

**Checking HIGH terminal contact**

To ensure safety, perform the following check with the HIGH side test leads removed. It is recommended to set test conditions as follows.

**(Example) When the insulation resistance of the equipment to be measured is 100 MΩ**

Test voltage	25 V
Lower limit value	1 MΩ
Test duration	10 s

(As there is a step to start a tes in the check procedure, set the test voltage low.)

**1 Turn off the instrument power.**



**2 Connect the test leads to the LOW terminals. (Do not connect the test leads to the HIGH terminals.)**

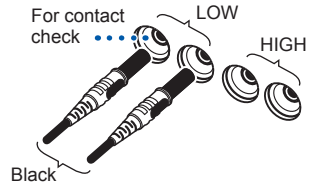

**3 Turn on the instrument power.**

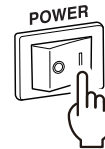

**4 Set the contact check function to [ON].**  
(p.56)

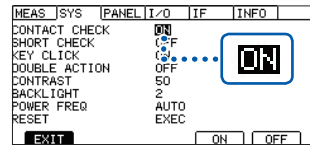

**5 Allow the test leads to short circuit.**



**6 Start a test.**



**7 Check that a contact error occurs.**  
(If the test still starts even under these conditions, the contact check function may not be [ON] or the instrument may be damaged.)

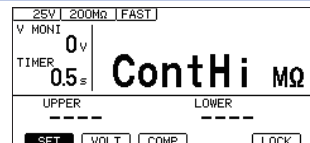

## Checking LOW side contact

Perform the following check with the LOW terminal test leads removed.

- 1 Turn off the instrument power.



- 2 Connect the test leads to the HIGH terminals. (Do not connect the test leads to the LOW terminals.)

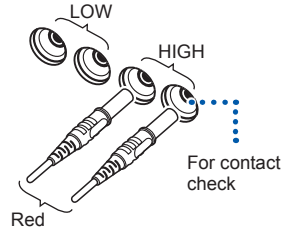

- 3 Turn on the instrument power.

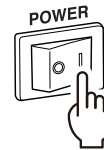

- 4 Set the contact check function to [ON]. (p. 56)

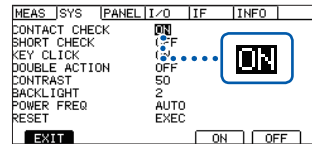

- 5 Allow the test leads to short circuit.

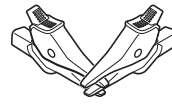

- 6 Start a test.



- 7 Check that a contact error occurs. (If the test still starts even under these conditions, the contact check function may not be [ON] or the instrument may be damaged.)

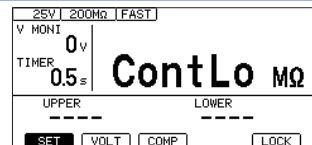

**Checking the operation of the contact check function**

**1** Turn off the instrument power.



**2** Connect the test leads to the LOW and HIGH terminals.

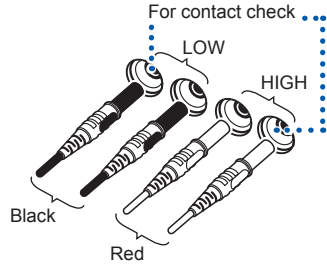

**3** Turn on the instrument power.

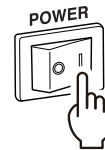

**4** Set the contact check function to [ON].  
(p. 56)

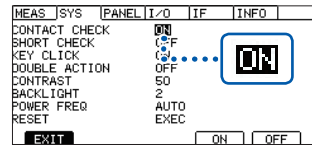

**5** Allow the test leads to short circuit.  
(Short circuit the black test leads and red test leads. Do not short circuit the black test lead and red test lead.)

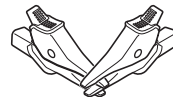

**6** Start a test.



**7** Check that the test starts.  
(If the test does not start, the test leads may be broken or the instrument may be damaged.)

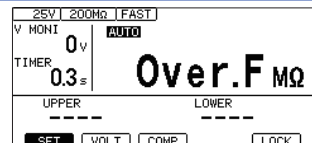



# 3 Basic Settings

This chapter describes basic operation settings for the instrument.

“3.1 Setting the Test Voltage” .....	p. 34
“3.2 Setting the Range” .....	p. 36
“3.3 Switching the Measurement Speed (FAST/SLOW)” .....	p. 38
“3.4 Setting the Test Duration and Response Time”	p. 39
• “Setting how long to apply the test voltage” .....	p. 39
• “Setting the response time” .....	p. 41
“3.5 Judging Measured Values (Comparator function)” .....	p. 44
“3.6 Setting the Test Mode” .....	p. 46
“3.7 Announcing the Judgment Results Using a Beep Sound” .....	p. 47

## 3.1 Setting the Test Voltage

Set the test voltage between 25 V and 1000 V.

As the measurement range is set based on the test voltage, a measurement range that is not appropriate for the settings is switched automatically. The test voltage can be set in the Measurement or the settings screen.

### ⚠ CAUTION



Setting at improper voltage may damage equipment to be measured.

### Setting the test voltage in the Measurement screen

#### 1 Select [VOLT].

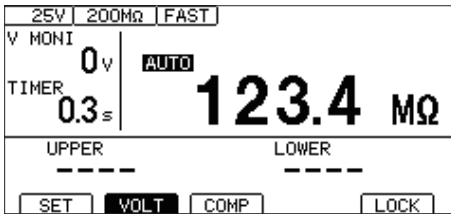

F1 Select [VOLT].

#### 2 Change and then confirm the test voltage value.

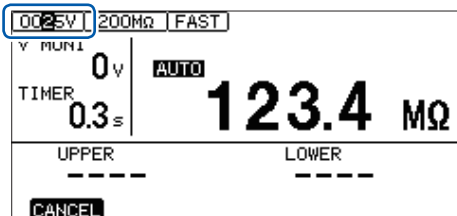

- Change the value. (Up/Down keys)
- Change the cursor position. (Left and right keys)

ENTER Confirm the value.

MENU Cancel the change.

## Setting the test voltage in the Settings screen

### 1 Open the Settings screen.

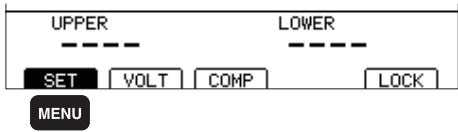

MENU Select [SET].

### 2 Set [VOLTAGE] to edit mode.

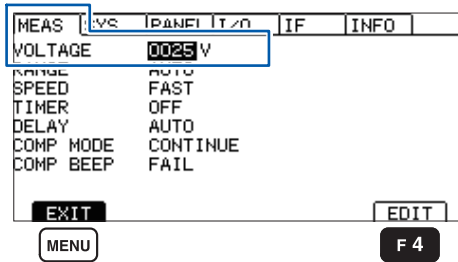

◀ Selection

F 4 Edit the value.

MENU Return to the Measurement screen.

### 3 Change and then confirm the test voltage value.

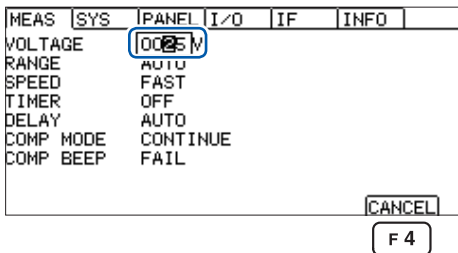

• Change the value. (Up/Down keys)

• Change the cursor position. (Left and right keys)

ENTER Confirm the value.

F 4 Cancel the change.

When a voltage that is higher than the set test voltage is output (set voltage + 20%), **[Output voltage Error]** is displayed on the screen. The test is stopped and no further key operations can be performed. Turn OFF the power switch on the rear panel.

Refer to “10.2 Troubleshooting” (p. 171).

## 3.2 Setting the Range

There are two range settings, auto and manual. For the manual range setting, the range can be chosen from 2 MΩ, 20 MΩ, 200 MΩ, 2000 MΩ, and 4000 MΩ. Note, however, that the ranges that can be set varies depending on the test voltage. (p.155) The auto range may require some time before a measured value is displayed as the range has to shift after a test starts. To eliminate this time, set the range manually according to the object to be measured.

### Setting the manual range

- 1 Open the Settings screen.

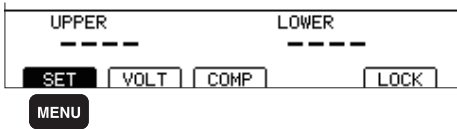

**MENU** Select **[SET]**.

- 2 Set **[RANGE]** to **[HOLD]**.

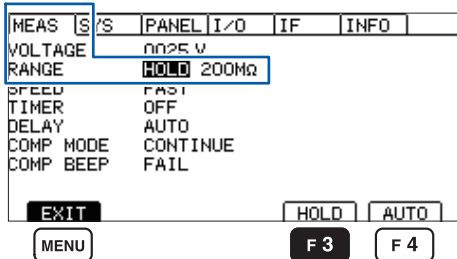

Selection

**F3** **[HOLD]**

**MENU** Return to the Measurement screen.

- 3 Select the range.

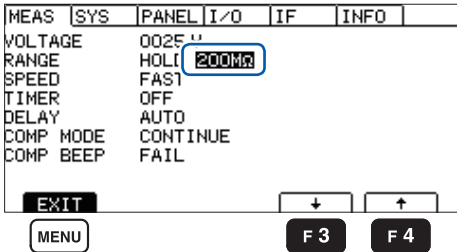

Item selection

**F3**  
**F4** Select the range.

**MENU** Return to the Measurement screen.

When analog output is used, 0 to 4 V is output from the analog output terminal according to each resistance range. (p.105)

## Setting the auto range

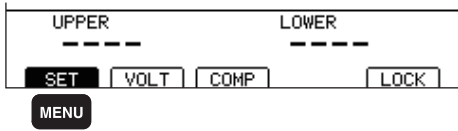
**1** Open the Settings screen.

**MENU** Select **[SET]**.

**2** Set **[RANGE]** to **[AUTO]**.

When the auto range is set, **[AUTO]** is displayed in the Measurement screen. (p. 20)

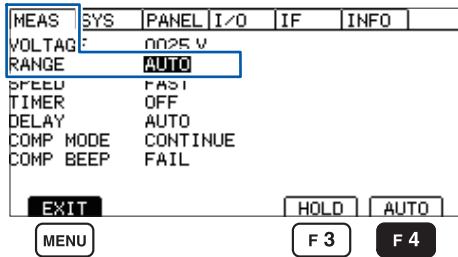

Selection

**F 4** **[AUTO]**

**MENU** Return to the Measurement screen.

### 3.3 Switching the Measurement Speed (FAST/SLOW)

There are two measurement speeds, **[FAST]** and **[SLOW]**. The resistance is measured and displayed in 30 ms when the measurement speed is set to **[FAST]** and in 500 ms when the speed is set to **[SLOW]**.

Setting the measurement speed to **[SLOW]** is effective if a measured value fluctuates and it is difficult to read the value.

#### 1 Open the Settings screen.

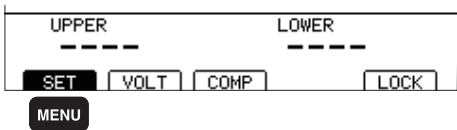

**MENU** Select **[SET]**.

#### 2 Set the test speed.

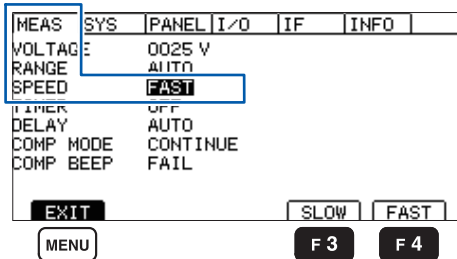

Selection

**F 3** **[SLOW]**

**F 4** **[FAST]**

**MENU** Return to the Measurement screen.

#### IMPORTANT

- The sampling time is 100 ms even when the measurement speed is set to **[FAST]** if the contact check function is ON.  
(The sampling time is 500 ms if the measurement speed is set to **[SLOW]** regardless of the function check setting.)
- If the test duration is set to less than 500 ms when the measurement speed is set to **[SLOW]**, the measured value is not displayed. Set a test duration that is longer than the sampling time.

## 3.4 Setting the Test Duration and Response Time

### Setting how long to apply the test voltage

The test duration determines how long the test voltage will be applied. The same test duration is applicable at any test voltage.

#### IMPORTANT

- In the auto range, if the test duration is set to a short time period, a test may finish without displaying a measured value because of a range shift. If the auto range is used, check the time required for a measured value to stabilize and set the test duration.
- The measured resistance can become low over time depending on the equipment to be measured. (Example: When the terminal to ground capacity is large, etc.) Setting an improper test duration could result in erroneous judgment. Carefully check the time required for a measured value to stabilize and set the test duration.
- Measured values may not stabilize due to the humidity and other environmental factors. Check how long it takes measured values to stabilize and then set the test duration accordingly.

#### 1 Open the Settings screen.

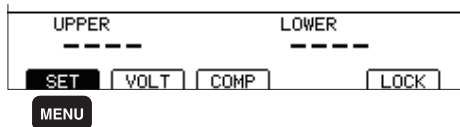

MENU Select [SET].

#### 2 Set [TIMER] to [ON].

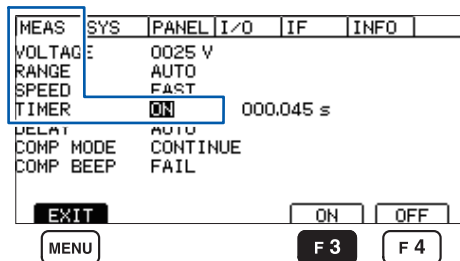

Selection (Up/Down keys)

F 3 [ON]

F 4 [OFF]

MENU Cancel the change.

### 3 Set [TIMER] to edit mode.

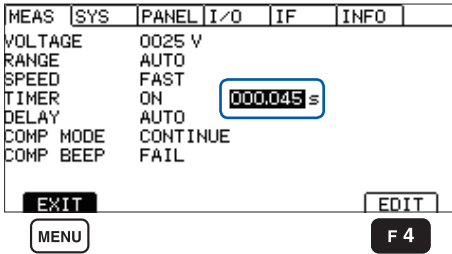

Selection (Left and right keys)



Edit the value.



Return to the Measurement screen.

### 4 Set the test duration.

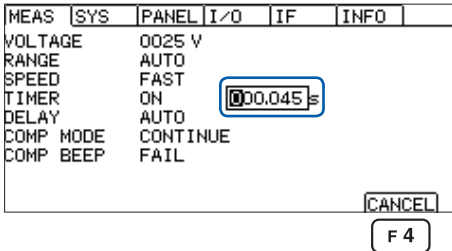

- Change the value. (Up/Down keys)
- Change the cursor position. (Left and right keys)



Confirm the value.



Cancel the change.



## Setting the response time

Response time is the time to prohibit comparator judgment after a test starts until the set response time elapses. No measured value is displayed during the response time. The response time is included in the test duration. The same response time is applicable at any test voltage.

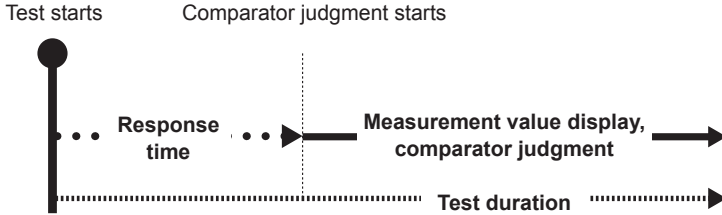

3

- The response time varies depending on the equipment to be measured. If a capacitive load is connected, it may take time for the output voltage to rise.
- When the response time is set to **[AUTO]**, the output is monitored and the measurement starts after the voltage is stabilized. The time required for the voltage to stabilize varies depending on the equipment to be measured.
- If the electrostatic capacity of the equipment to be measured is 1 $\mu$ F or more, the **[AUTO]** function may not operate properly because it takes time to charge the equipment to be measured. Check the time required for the value on the voltage monitor to reach the set voltage, and then set it after **[MANUAL]** is selected.
- When the response time is set to **[MANUAL]**, the measurement starts anytime. The measurement may start before the output voltage rises depending on the equipment to be measured. Set the response time according to the equipment to be measured.

During the response time, **[D]** is displayed to the left of the test duration indication on the measurement screen.

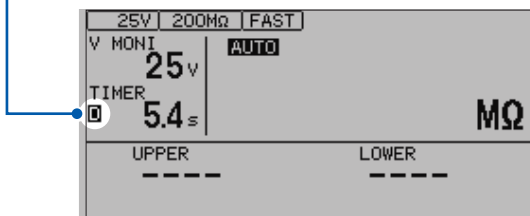

## Setting to MANUAL

### 1 Open the Settings screen.

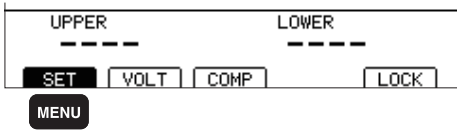

**MENU** Select **[SET]**.

### 2 Set **[DELAY]** to **[MANUAL]**.

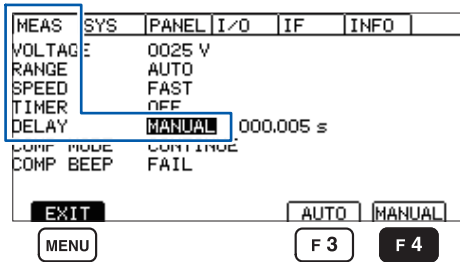

Selection

**F 4** **[MANUAL]**

**MENU** Return to the Measurement screen.

### 3 Set **[DELAY]** to edit mode.

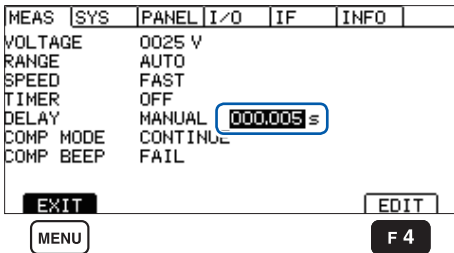

Selection

**F 4** Edit the value.

**MENU** Return to the Measurement screen.

### 4 Set the response time.

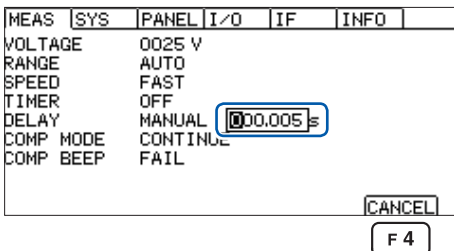

- Change the value. (Up/Down keys)
- Change the cursor position. (Left and right keys)

**ENTER** Confirm the value.

**F 4** Cancel the change.

**Setting to AUTO**

**1** Open the Settings screen.

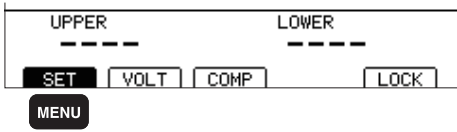

MENU Select **[SET]**.

**2** Set **[DELAY]** to **[AUTO]**.

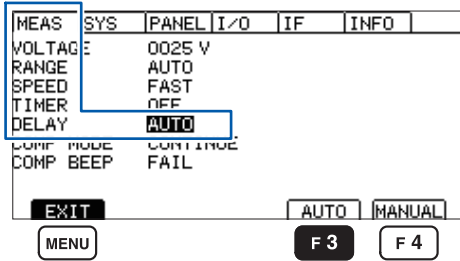

Selection  
F3 **[AUTO]**

MENU Return to the Measurement screen.

**3**

## 3.5 Judging Measured Values (Comparator function)

The following are enabled with the comparator function.

- The instrument displays a judgment result (COMP lamp U.FAIL/PASS/L.FAIL).

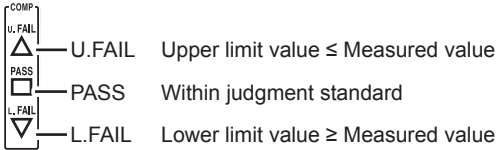

- A buzzer sounds (default value FAIL). Refer to “3.7 Announcing the Judgment Results Using a Beep Sound” (p.47).
- A judgment result is externally output. Refer to “7 External Control (EXT.I/O)” (p.81).

**There are the following three comparator judgment methods.**

Upper/lower limit value setting range: 0.000 to 4000 M $\Omega$

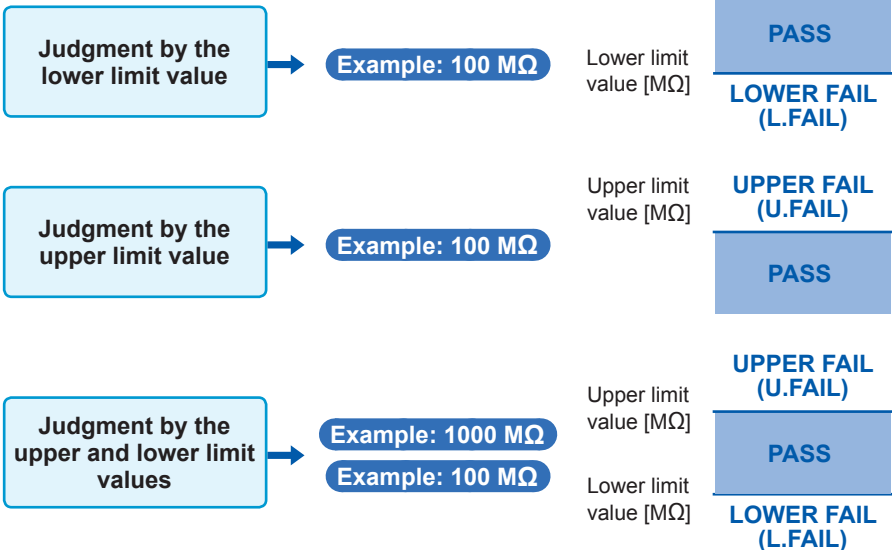

If the upper and lower limit values are set to values outside of the accuracy range, the U.FAIL and L.FAIL lamps turn on at the same time.

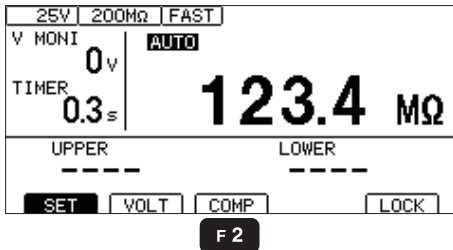
**1** Select [COMP].

F 2 Select [COMP].

**2** Set the comparator function to [ON].

The comparator function can be set to ON and OFF for each of the upper and lower limit values.

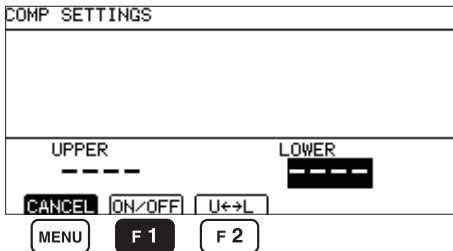

F 1 Select [ON/OFF].

(A value is displayed when ON is selected and “---” is displayed when OFF is selected.)

F 2 Switch the upper and lower limit values.

MENU Cancel the change.

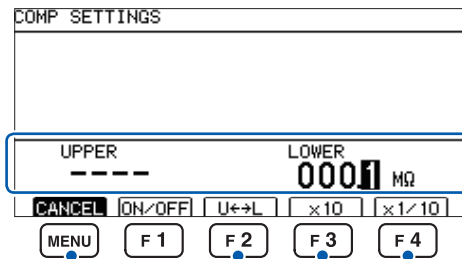
**When ON is selected****When OFF is selected****3** Set and confirm the values.

- Change the value. (Up/Down keys)
- Change the cursor position. (Left and right keys)

ENTER Confirm the value.

Cancel the change.

Switch the upper and lower limit values.

Change the decimal point position.

The upper limit value can be set to any value. Set the upper limit value to perform a 2-terminal contact check or when the upper limit value can be estimated.

## 3.6 Setting the Test Mode

There are four test modes: Continuous test, PASS STOP, FAIL STOP, and Forced termination judgment.

### 1 Open the Settings screen.

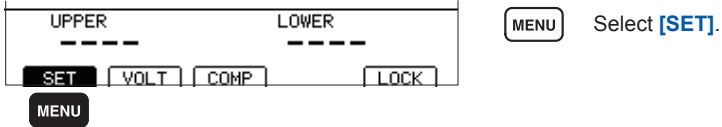

### 2 Set the test mode.

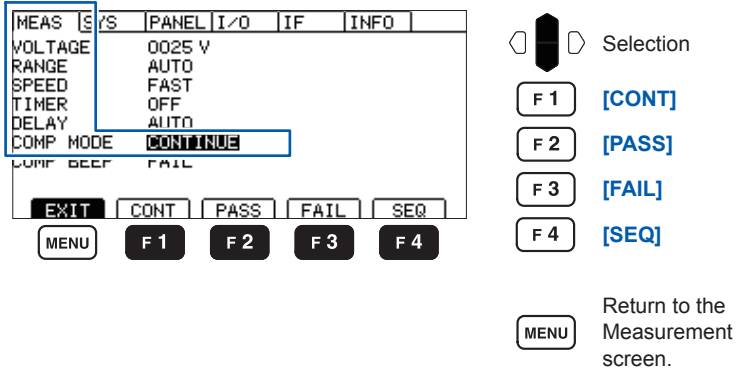

<b>[CONT]</b> (Continuous test mode)	Continues tests until the set test duration elapses and outputs the judgment result every sampling.
<b>[PASS]</b> (PASS STOP mode)	Terminates a test and outputs the judgment result when PASS judgment is made.
<b>[FAIL]</b> (FAIL STOP mode)	Terminates a test and outputs the judgment result when FAIL judgment is made.
<b>[SEQ]</b> (Forced termination judgment mode)	Outputs the judgment result when the set test duration elapses or at the time of STOP input (key, RS-232C command, or EXT.I/O).

## 3.7 Announcing the Judgment Results Using a Beep Sound

Judgment results are announced with a beep sound under the four conditions, OFF, PASS, FAIL, and END.

### 1 Open the Settings screen.

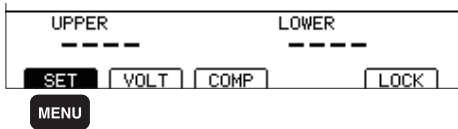

MENU Select **[SET]**.

3

### 2 Set the conditions for the beep sound.

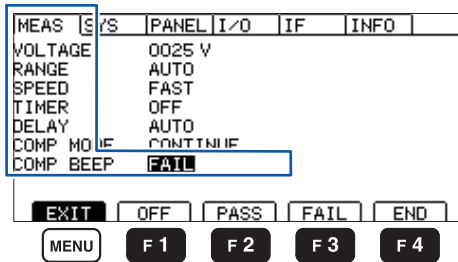

◀ ▶ Selection

F 1 **[OFF]**

F 2 **[PASS]**

F 3 **[FAIL]**

F 4 **[END]**

MENU Return to the Measurement screen.

<b>[OFF]</b>	No beep sound.
<b>[PASS]</b>	Beeps for PASS judgment.
<b>[FAIL]</b>	Beeps for FAIL judgment.
<b>[END]</b>	Beeps when a measurement is completed.

Announcing the Judgment Results Using a Beep Sound



# 4 Testing

This chapter describes testing procedures for the instrument.

## 4.1 Starting Measurements

### ⚠ WARNING

Observe the following to avoid electric shock.



- When the TEST lamp is blinking, do not touch the equipment to be measured, the tip of the probe, and measurement terminals.
- The measurement terminals on the front panel and the corresponding ones on the rear panel are connected each other in the instrument. Do not touch the measurement terminals.
- Do not touch the equipment to be measured, the tip of the probes, and measurement terminals immediately after tests are completed. High voltage charge may cause electric shock.



- To avoid electric shock, use the discharge function on the instrument to release charge in pieces of equipmentS to be measured after tests. (p.54)

**1** Set the measurement items. (p.33)

**2** Press the **START** key to start a measurement.

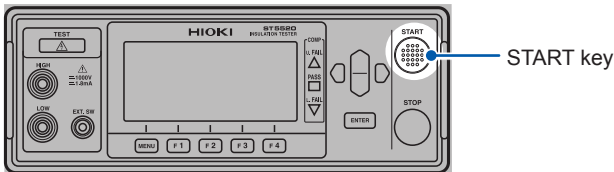

**3** The TEST lamp blinks at intervals of 250 ms during measurement.

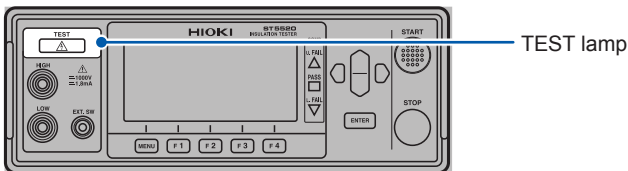

- A test can be started or completed by the EXT.I/O, RS-232C, and switched probe in addition to the operation keys. A test can be started and completed by different methods.
- Check that the test leads are securely connected before starting a test.
- A test does not start when the EXT.I/O STOP signal is LOW.
- A test does not start when the interlock function is enabled.

# 4.2 During Measurement

The instrument applies test voltage to equipment to be measured during measurement.

## 1 When the test duration is set to [ON] (p.39)

1. When the **START** key is pressed, test voltage is applied to the equipment to be measured, and the timer countdown starts. The remaining time is displayed in the test duration indicator (TIMER).
2. During the response time, **[D]** is displayed on the left edge of the countdown time indicator, and the measured value indicator becomes blank (no display). The display during the response time is the same for both response time settings, **[AUTO]** and **[MANUAL]**.
3. After the response time has elapsed, the resistance measurement is performed for the time specified for the timer, and the measured value is displayed. (Unit: MΩ) When the comparator function is set, judgment is performed according to the test mode setting.

## 2 When the test duration is set to [OFF] (p.39)

1. When the **START** key is pressed, test voltage is applied to the equipment to be measured, and the timer count-up starts. The time elapsed since the **START** key was pressed is displayed in the test duration indicator (TIMER).
2. During the response time, **[D]** is displayed on the left edge of the count-up time indicator, and the measured value indicator becomes blank (no display). The display during the response time is the same for both response time settings, **[AUTO]** and **[MANUAL]**.
3. After the response time has elapsed, the resistance measurement is performed until the **STOP** key is pressed, and the measured value is displayed. (Unit: MΩ) The elapsed time is counted and displayed up to 999.9 s, but the resistance measurement is performed until the **STOP** key is pressed. When the comparator function is set, judgment is performed according to the test mode setting.

## 3 PASS/FAIL judgment display for the comparator function

Upper limit value ≤ Measured value	U.FAIL turns on.
Lower limit value < Measured value < Upper limit value	PASS turns on.
Measured value ≤ Lower limit value	L.FAIL turns on.

Refer to “3.7 Announcing the Judgment Results Using a Beep Sound” (p.47) to set beep sound for PASS/FAIL judgment.

When the upper and lower limit values are not set, the indicator displays “----” and PASS/FAIL judgment is not performed. If either of the upper and lower limit values is set, PASS/FAIL judgment is performed according to the value. (p.44)

If both the upper and lower limit values are set outside the display range, the U.FAIL and L.FAIL lamps turn on at the same time.

## 4 The timer indicator indicates the test duration countdown. When the test duration is not set, the indicator displays elapsed time.

## 4.3 Measured Value Display

A measured value outside of the accuracy range can also be displayed.

Measurement voltage	Display range
$25 \text{ V} \leq V < 100 \text{ V}$	0.002 M $\Omega$ to 999.9 M $\Omega$
$100 \text{ V} \leq V < 500 \text{ V}$	0.002 M $\Omega$ to 9990 M $\Omega$
$500 \text{ V} \leq V \leq 1000 \text{ V}$	0.002 M $\Omega$ to 9990 M $\Omega$

When the measure value is outside of the display range, “Over.F” or “Under.F” is displayed.

Refer to “9 Specifications” (p.153) for the accuracy range.

### IMPORTANT

- The guaranteed accuracy range is different from the display range.
- When the range is set to AUTO, it may take time to display a measured value immediately after a test starts due to range shift. To check a measured value immediately, set the range to MANUAL.  
(Refer to “3.2 Setting the Range” (p. 36) for the setting procedure.)
- If PASS/FAIL judgment is obtained with a command in the auto range when the range is not set or before a measured value is displayed, ULFAIL (no judgment) is returned. Extend the test duration.
- When test terminates without the range having been determined while using auto-ranging, no measured value will be displayed. Use a longer test time.
- In the auto range, the measured value may fluctuate between two ranges. Set the range to MANUAL.
- “Over.F” (overflow) is displayed when the measured value exceeds the display range maximum value in the auto range and when the measured value exceeds the maximum display value in each range in the MANUAL range.
- “Under.F” (underflow) is displayed when the measured value is less than 190 dgt. in the MANUAL range excluding 2 M $\Omega$  range. “Under.F” is not displayed in the AUTO range.
- The more electrostatic capacitance components the equipment to be measured contains, the more the measured value fluctuates. Also it takes for an output voltage to rise.
- When the processing is performed at high speed (for example, the test duration is less than 100 ms), there is a possibility that the voltage monitor cannot be updated in time. To check the output voltage, monitor the waveform on an oscilloscope or other instruments using a high-pressure probe or other probes.

## 4.4 Completing Measurement

### WARNING



To avoid electric shock, remove the measurement leads from an equipment to be measured after the TEST lamp is turned off after a test.

- 1** Tests are completed by one of the following.
  - The **STOP** key is pressed, the EXT.I/O STOP signal is LOW, or a test completion command is sent from the RS-232C.
  - The set test duration elapses.
  - The test mode is set to FAIL STOP mode and FAIL judgment is made.
  - The test mode is set to PASS STOP mode and a PASS judgment is made.
  - The test mode is set to PASS STOP mode and PASS judgment is made.
  - The **\*RST**, or **:STOP** command or a command related to test conditions (**:TIMer**, **:DELay**, etc.) is sent from the RS-232C interface.
- 2** The measured value and COMP lamp displayed immediately before the test is completed continue to be displayed.
- 3** The TEST lamp may not turn off and continue to blink even after the test is completed. This indicates that any charge remaining in the equipment to be measured and instrument is being released. Follow “4.5 Automatic discharge function” to release any remaining charge.
- 4** After the TEST lamp turns off, remove the test leads.

## 4.5 Automatic Discharge Function

### **WARNING**



**When an insulation resistance test is performed on equipment to be measured that contains capacitance components, a test voltage equivalent load is charged which may result in electric shock.**

A residual electric charge can be released through the internal circuit of the instrument.

After tests, follow the procedure below to release any remaining charge.

- 1** Complete the test without removing the test leads from the equipment to be measured.
- 2** The charge remaining in the equipment to be measured is automatically released in this instrument.
- 3** During discharge, the TEST lamp blinks.
- 4** When the voltage falls below approximately 10 V, the TEST lamp turns off.

# 5 Useful Functions

This chapter describes useful functions of the instrument.

“5.1 Checking Faulty Contact and Contact Status (Contact check function)” ..	<b>p. 56</b>
“5.2 Checking Short Circuit before Applying the Set Voltage (Short circuit check function)” .....	<b>p. 60</b>
“5.3 Enabling/Disabling the Key Operations” .....	<b>p. 65</b>
“5.4 Setting the Key Operation Sound” .....	<b>p. 67</b>
“5.5 Preventing Operation Errors at the Start of Testing (Double action function)” .....	<b>p. 68</b>
“5.6 Adjusting the Screen Contrast” .....	<b>p. 69</b>
“5.7 Adjusting the Backlight” .....	<b>p. 70</b>
“5.8 Setting the Frequency of Power Supply Manually” .....	<b>p. 71</b>
“5.9 Initializing the System (Reset)” .....	<b>p. 72</b>
“5.10 Default Setting List” .....	<b>p. 73</b>

## 5.1 Checking Faulty Contact and Contact Status (Contact check function)

The faulty contact of the equipment to be measured and probes and the broken wires of the measurement cables are detected.

The measurement terminals on the rear panel of the instrument are used for contact check. The contact check function monitors the contacts from the start to the end of measurement in every sampling and can detect faulty contacts and broken wires of the probes not only before and after tests but also during the tests. If faulty contacts are detected, a contact error (ContLo M $\Omega$ , ContHi M $\Omega$ , or ContHL M $\Omega$ ) is displayed in the measured value display section, and the test stops. (The ERR signal is output from EXT.I/O.) When this error is displayed, check the probe contact and for any broken wires of the measurement cables. (The instrument needs to be repaired if the error does not disappear even when the measurement cables that are not broken are short circuited.)

### IMPORTANT

- Even if the measurement speed is set to **[FAST]**, the sampling time takes 100 ms when the contact check function is ON. (The sampling time is 500 ms if the measurement speed is set to **[SLOW]** regardless of the function check setting.)
- When the contact check function is set to OFF, a measured value is displayed even if the probe is not in contact with the equipment to be measured.
- If the set test duration is shorter than the sampling time, a proper measurement cannot be performed. (The measured value may not be displayed.) Set a test duration that is longer than the sampling time.
- No contact error occurs with the instrument whose current measuring unit is detecting a measurement current of 500  $\mu\text{A}$  or more even when any test lead for the contact check is in imperfect contact with the equipment to be measured.



## 1 Open the Settings screen.

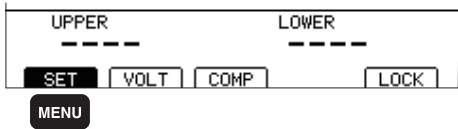

**MENU** Select **[SET]**.

## 2 Set **[CONTACT CHECK]** to **[ON]**.

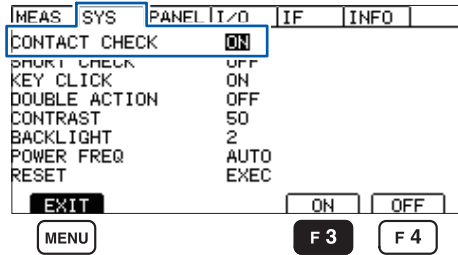

Selection

**F 3** **[ON]**

**F 4** **[OFF]**

**MENU** Return to the Measurement screen.

## Connecting test leads

### Rear panel

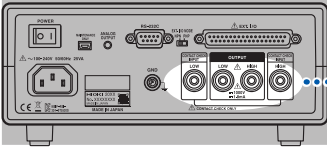

#### L2200

Connect the red plug to the HIGH terminal and the black plug to the LOW terminal.  
(The left and right side terminals are for contact check.)

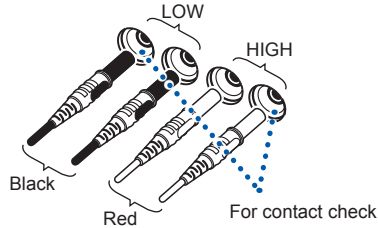

## Example of connection to equipment to be measured

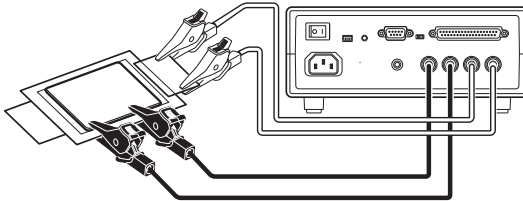

### IMPORTANT

Securely connect the test leads for the contact check to the equipment to be measured. When the test leads are not connected securely, a contact error occurs and no test can start. For the principles of the contact check function, refer to “Appx. 2 Contact Check Function” (p. Appx.2).

## 2-terminal contact check function

If the insulation resistance of the equipment to be measured is within the measurable range of the instrument, a 2-terminal contact check can be performed by setting the upper and lower limit values of the comparator.

**(Example) When the insulation resistance of the equipment to be measured is 100 MΩ**

Test voltage	500 V
Upper limit value	110 MΩ
Lower limit value	90 MΩ
Test duration	1 s

- 1** Set the test voltage to 500 V.
- 2** Set the lower limit value to 90 MΩ and the upper limit value to 110 MΩ.
- 3** Set the test duration to 1 s.
- 4** Connect the HIGH and LOW side test leads to the equipment to be measured.
- 5** Start a test.
- 6** When the measured value is Over.F and the U.FAIL lamp turns on, the contact may be faulty or the probe wires may be broken.

## 5.2 Checking Short Circuit before Applying the Set Voltage (Short circuit check function)

This is a function to check for short circuit by applying a low voltage (2 V to 4 V) to the equipment to be measured after starting a test and before applying the set voltage. If the equipment to be measured is short-circuited, a short circuit error (Short MΩ) is displayed in the measured value display section, and the test stops. The set voltage is not applied. This function can prevent a judgment error when short circuit disappears when a high voltage is applied if the equipment to be measured is short-circuited by whiskers. The short circuit check function determines whether the equipment to be measured is short-circuited or not by applying direct current voltage and then measuring the current value. During the period immediately after the check is started, a difference cannot be identified between the short circuit of the insulator and the charging current to the electrostatic capacity. In this instrument, the current value is measured after the set time has elapsed to determine whether a short circuit occurs or not.

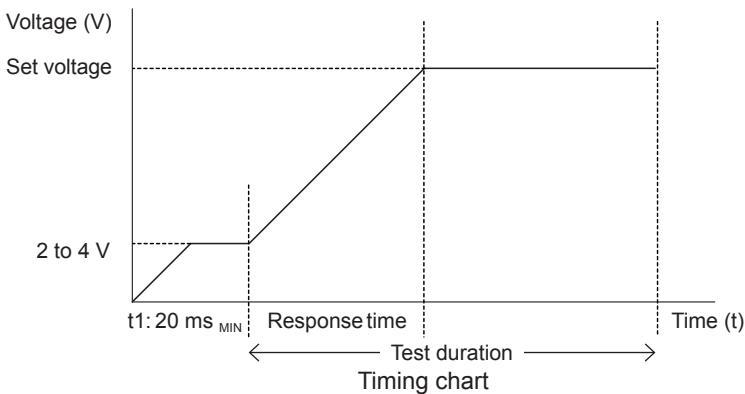

### IMPORTANT

- If the equipment to be measured contains electrostatic capacitance components, t1 becomes longer. Set the time using the automatic measurement function for short circuit check time.
- The voltage to be applied fluctuates between 2 and 4 V depending on the equipment to be measured.

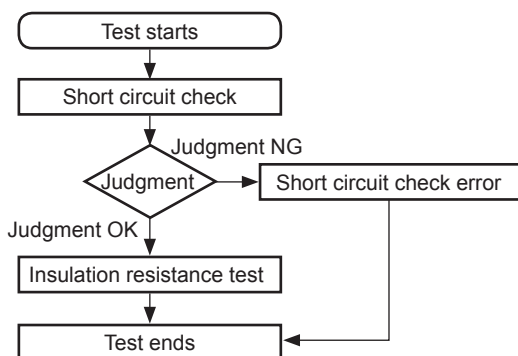

The time required for the automatic short circuit check is different between the correctly operating product and the short-circuited product. Each check takes up to 0.5 s.

[AUTO] is also used for checking the shortest short circuit check execution time.

#### How to check the shortest execution time

##### [AUTO]

When a correctly operating product is connected and a test is started, the short circuit check finishes as soon as the effect of the charging current has disappeared, and then the time taken is displayed.

Perform this process for multiple units of the equipment to be measured, and then set the longest time displayed (plus a little extra time) after [MANUAL] is selected.

The time taken for the short circuit check is displayed at the upper right of the measured value display section.

##### [MANUAL]

[MANUAL] is used to execute a short circuit check in the shortest time.

The short circuit check time can be set freely in the range of 0.010 s to 1.000 s. (When the time required for a short circuit check is unknown, it is possible to determine an approximate time by setting [SHORT CHECK TIME] to [AUTO] and then performing the measurement several times. When [MANUAL] is selected, set the time in consideration of any variations in the characteristics of the measurement objects.)

**Setting to AUTO**

**1** Open the Settings screen.

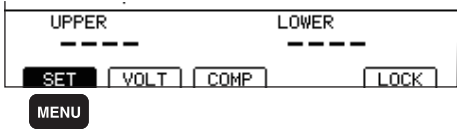

MENU Select **[SET]**.

**2** Set **[SHORT CHECK]** to **[ON]**.

(When **[ON]** is selected, the **[SHORT CHECK TIME]** setting is displayed below.)

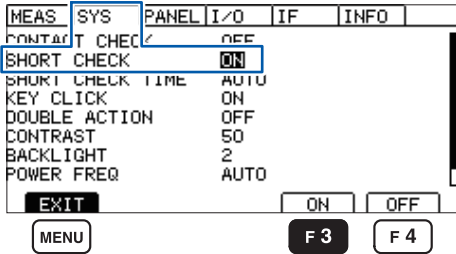

Selection

F3 **[ON]**

F4 **[OFF]**

MENU Return to the Measurement screen.

**3** Set **[SHORT CHECK TIME]** to **[AUTO]**.

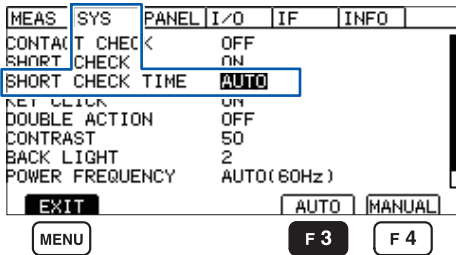

Selection

F3 **[AUTO]**

MENU Return to the Measurement screen.

**4** On completion of the short circuit check following starting the measurement, the short circuit check time is displayed.

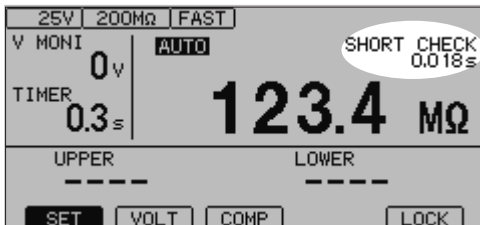

- The short circuit check function is operated using 100 kΩ as a criterion. Therefore, if equipment operating at 100 kΩ or less is measured, a short circuit check error occurs.
- When **[SHORT CHECK TIME]** is set to **[AUTO]** and the equipment to be measured is short-circuited, it takes 0.5 s for a short circuit check and “SHORT CHECK 0.000 s” is displayed.

## Setting to MANUAL

### 1 Open the Settings screen.

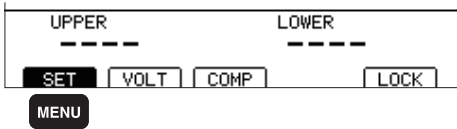

**MENU** Select **[SET]**.

### 2 Set **[SHORT CHECK]** to **[ON]**. (When **[ON]** is selected, the **[SHORT CHECK TIME]** setting is displayed below.)

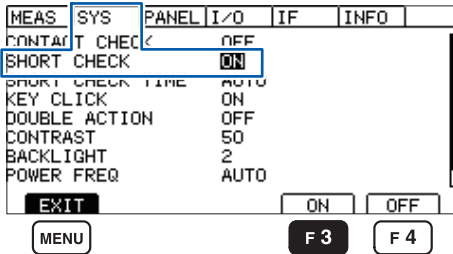

**Selection**

**F 3** **[ON]**

**F 4** **[OFF]**

**MENU** Return to the Measurement screen.

### 3 Set **[SHORT CHECK TIME]** to **[MANUAL]**.

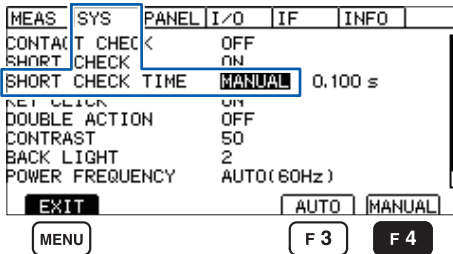





**Selection**

**F 4** **[MANUAL]**

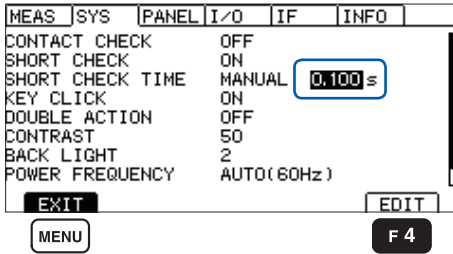
**MENU** Return to the Measurement screen.



#### 4 Set [SHORT CHECK TIME] to edit mode.

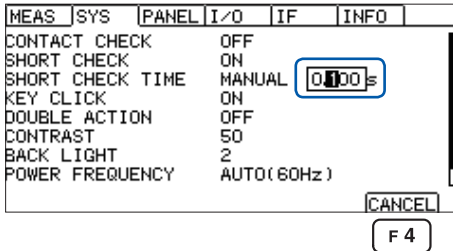

-  Selection
-  Edit the value.
-  Return to the Measurement screen.

#### 5 Set the test duration.



- 
  - Change the value. (Up/Down keys)
  - Change the cursor position. (Left and right keys)
-  Confirm the value.
-  Cancel the change.



## 5.3 Enabling/Disabling the Key Operations

By executing the key lock function, the key operations other than **UNLOCK**, **START**, or **STOP** can be disabled.

### Disabling the key operations (Key lock engaged)

- 1 Execute the key lock function.

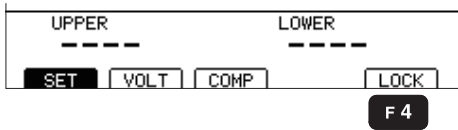

F 4 Key lock

- 2 **[LOCK]** is displayed at the upper right corner and the key operations other than **START** or **STOP** are disabled.

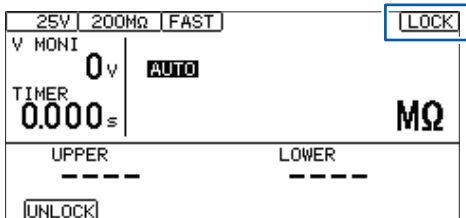

**Enabling the key operations (Key lock cancelled)**

**1** Cancel the key lock function.

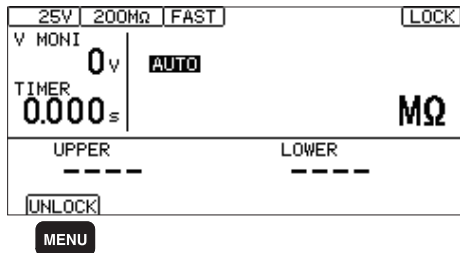

Reset key lock (hold down for 1 second).

**2** [LOCK] at the upper right corner disappears and the key operations are enabled.

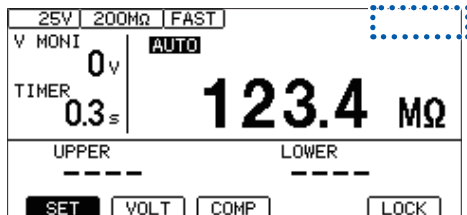

## 5.4 Setting the Key Operation Sound

The key operation sound ON/OFF can be selected.  
In the default setting, the key sound is set to ON (beeps).

### 1 Open the Settings screen.

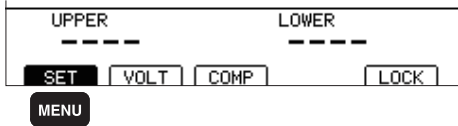

**MENU** Select **[SET]**.

### 2 Set **[KEY CLICK]** to **[ON]**.

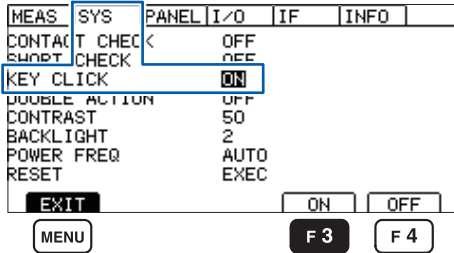

 Selection

**F 3** **[ON]**

**F 4** **[OFF]**

**MENU** Return to the Measurement screen.

## 5.5 Preventing Operation Errors at the Start of Testing (Double action function)

This is a function to prevent operation errors at the start of test and ensure safer test. No tests start unless the **START** key is pressed within 1 s after the **STOP** key is pressed when the double action function is set to ON. When the START is enabled, **D.ACTION** is displayed in the Measurement screen.

Operation errors can be prevented since the **STOP** key must be pressed before the **START** key is pressed.

### 1 Open the Settings screen.

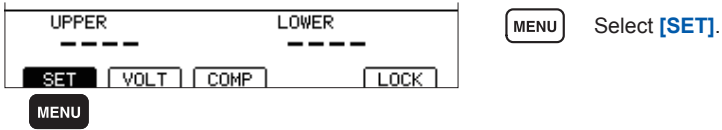

### 2 Set **[DOUBLE ACTION]** to **[ON]**.

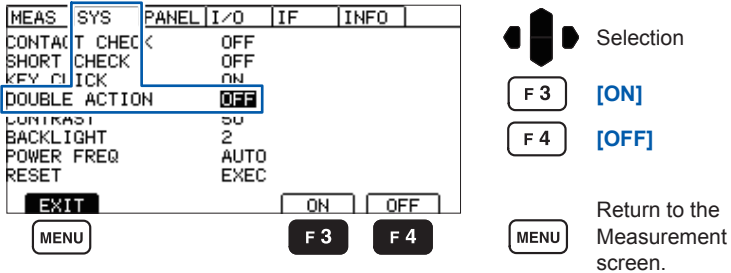

- When the double action function is set, the beeper sounds and the Error screen is displayed if the **START** key is pressed without pressing the **STOP** key.

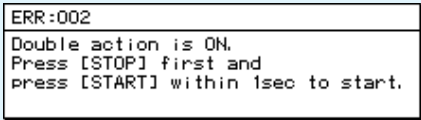

- When the **START** is enabled, **D.ACTION** is displayed in the Measurement screen.

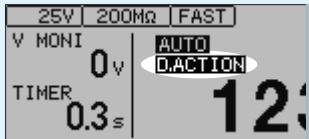

## 5.6 Adjusting the Screen Contrast

The screen contrast can be set between 0 and 100% in increments of 5%.

The screen may become difficult to see when ambient temperature changes.

### 1 Open the Settings screen.

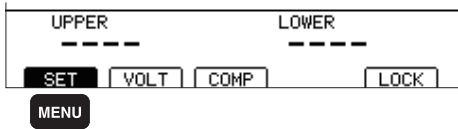

MENU Select [SET].

### 2 Set the value for [CONTRAST].

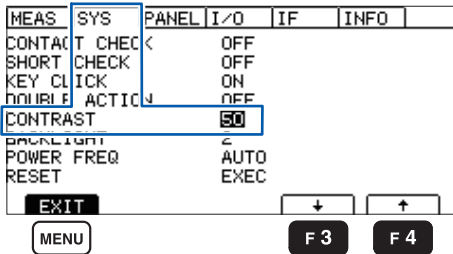

Selection

F 3

Decrease the contrast.

F 4

Increase the contrast.

MENU

Return to the Measurement screen.

## 5.7 Adjusting the Backlight

The backlight brightness can be adjusted to the illumination of the installation location.

The brightness can be set to 0 for communications. Be aware that the display may be difficult to see when the brightness is set to 0.

### 1 Open the Settings screen.

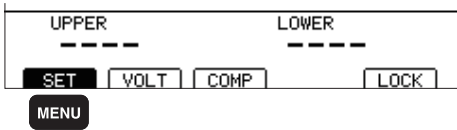

MENU Select **[SET]**.

### 2 Set the value for **[BACKLIGHT]**.

The smaller the value is, the lower the brightness becomes.

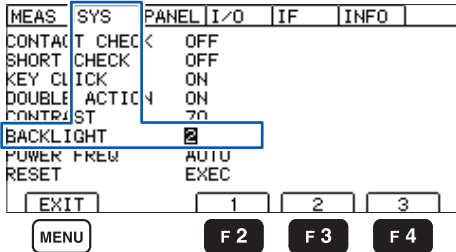

Selection

F 2 **[1]**

F 3 **[2]**

F 4 **[3]**

MENU Return to the Measurement screen.

## 5.8 Setting the Frequency of Power Supply Manually

There are three power supply frequency settings: AUTO, 50 Hz, and 60 Hz. To eliminate any noise, the supply power frequency needs to be set properly. In the default setting, the power supply frequency is supposed to be identified automatically (AUTO) when the power is supplied, however, it also can be set manually.

If the power supply frequency is not set properly, a measured value does not stabilize. Even in the AUTO setting, if the power supply frequency cannot be detected properly due to significant power noise, an error (ERR:097) is displayed when the power is supplied. Set the frequency according to the power supply.

### 1 Open the Settings screen.

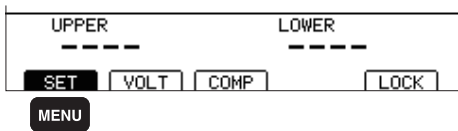

MENU Select **[SET]**.

### 2 Set **[POWER FREQ.]**. (When **[AUTO]** is set, the automatically identified power frequency is displayed on the right.)

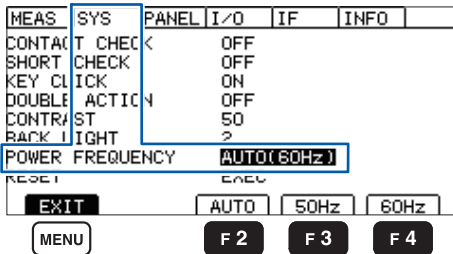

Selection

F 2 **[AUTO]**

F 3 **[50 Hz]**

F 4 **[60 Hz]**

MENU Return to the Measurement screen.

The power frequency is identified automatically only once when the power is supplied.

After the power supply frequency setting is changed from **[50Hz]** or **[60Hz]** to **[AUTO]**, turn off the power supply and then turn it on again.

## 5.9 Initializing the System (Reset)

All measurement conditions and panel data are reset to the default settings. There are three ways to reset.

- Reset in the System Settings screen.
  - With the power off, turn on the power while pressing **[MENU]** (**MENU**) and  (up cursor key) at the same time.
  - Reset with the communication command.
- \*RST** command (The interface setting is not initialized.)

This section describes the procedure to reset in the System Settings screen.

### 1 Open the Settings screen.

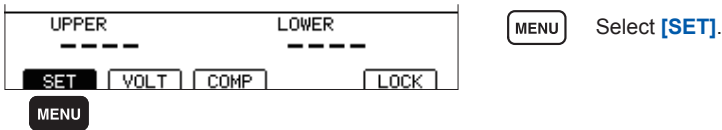

### 2 Execute **[RESET]**.

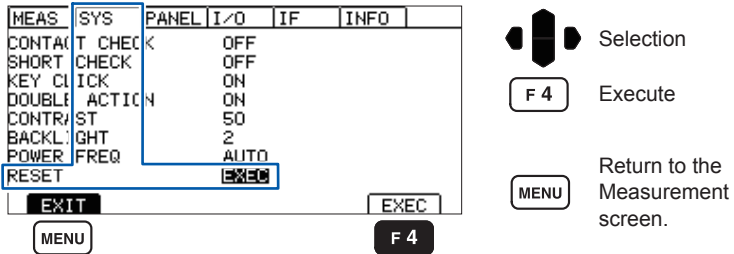

### 3 Select **[OK]**.

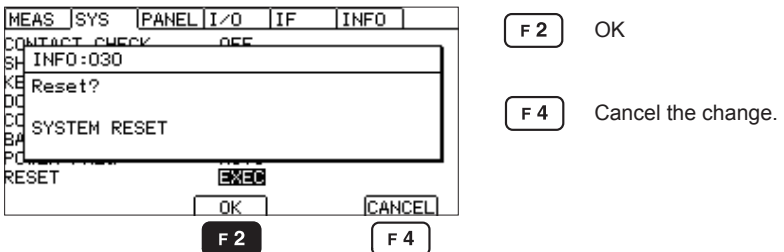



## 5.10 Default Setting List

Screen		Setting and key	Default setting	Reference
		COMP UPPER	OFF	p.44
		COMP LOWER	OFF	p.44
		LOCK	OFF	p.65
Settings screen (SET)	Measurement Settings screen (MEAS)	VOLTAGE	25 V	p.34
		RANGE	AUTO	p.36
		DATA CLEAR (only communications)	ON	p.135
		SPEED	FAST	p.38
		TIMER	OFF	p.39
		DELAY	AUTO	p.39
		COMP MODE	CONTINUE	p.46
		COMP BEEP	FAIL	p.47
	System screen (SYS)	CONTACT CHECK	OFF	p.56
		SHORT CHECK	OFF	p.60
		KEY CLICK	ON	p.67
		DOUBLE ACTION	OFF	p.68
		CONTRAST	50	p.69
		BACKLIGHT	2	p.70
		POWER FREQ	AUTO	p.71
	RESET	EXEC	p.72	
	Memory function	1 to 10	None	p.75
	EXT.I/O Settings screen (I/O)	ANALOG OUT RANGE	FULL	p.104
		EXT.SWITCH MODE	CONT	p.108
		EXT.I/O TEST-PIN	SLOW	p.101
		INTERLOCK	OFF	p.106
		EXT.I/O TEST	EXEC	p.103
	Communications Interface Settings screen (IF)	RS-232C SPEED	9600 bps	p.114
		DATA OUT	OFF	p.118
		CMD MONITOR	OFF	p.121

The interface settings are not initialized when the instrument is reset with the \*RST command.



## Saving and Loading Measurement Conditions (Memory function)

### Panel save function

The current measurement conditions can be saved.

Up to 10 patterns of measurement conditions can be saved and retained even when the power is turned off.

### Settings that can be saved with the panel save function

- Test voltage
- Range (auto range ON/OFF, resistance range when using a fixed range, and auto-range operation measured value clear setting)
- Test speed
- Test duration
- Response time
- Comparator upper and lower limit values (including comparator ON/OFF)
- Test mode
- Judgment beep sound

### Panel load function

The measurement conditions saved by the panel save function are loaded.

The measurement conditions can be loaded by the operation key, RS-232C command, or EXT.I/O.

## 6.1 Saving the Measurement Conditions (Panel save function)

### 1 Open the Settings screen.

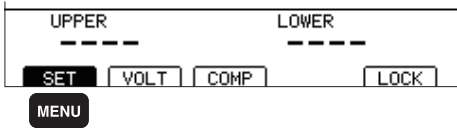

**MENU** Select **[SET]**.

### 2 Select the panel number to be saved.

The panel description is displayed on the right side of the screen.

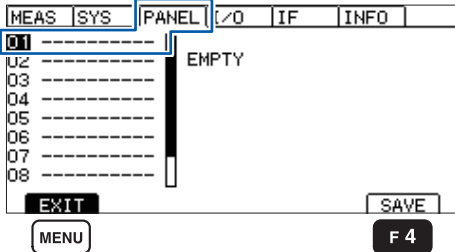

Selection

**F4** Save the panel.

**MENU** Return to the Measurement screen.

### 3 Enter and confirm the panel name.

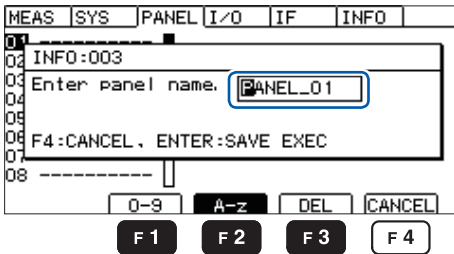

Selection

**ENTER** Confirm the panel name.

**F4** Cancel saving the panel.

Key operations for entering a panel name

Key	Operation
	Moves the cursor.
	Changes the characters and values.
<b>F1</b>	Enters a number from 0 to 9.
<b>F2</b>	Enters a letter from A to Z or an underscore character (_).
<b>F3</b>	Deletes a character.

## 6.2 Loading the Measurement Conditions (Panel load function)

The measurement conditions saved by the panel save function are loaded.

### 1 Open the Settings screen.

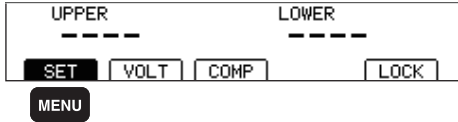

MENU Select [SET].

### 2 Select and load the panel number.

The panel description is displayed on the right side of the screen.

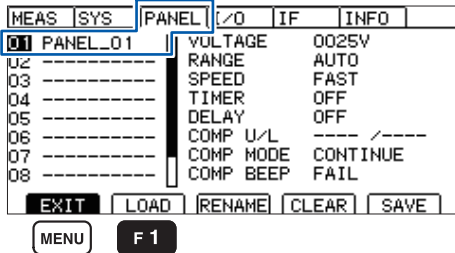

Selection

F1 Load the panel.

MENU Return to the Measurement screen.

### 3 Select [OK] in the confirmation screen.

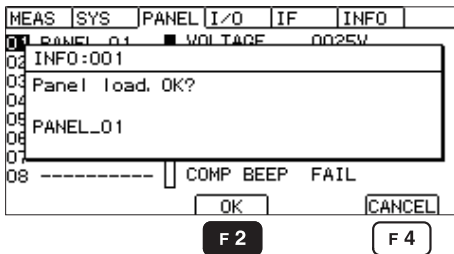

Selection

F2 OK

F4 Cancel loading the panel.

### 4 The panel name is displayed in the Measurement screen.

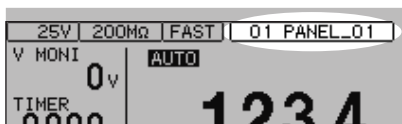

Measurement conditions can be loaded with the EXT.I/O control by using LOAD0 to LOAD3 or the communications commands. Refer to p.127 for details on commands. When the measurement conditions are changed after loading, the panel name is no longer displayed.

## 6.3 Changing the Panel Name

**1** Open the Settings screen.

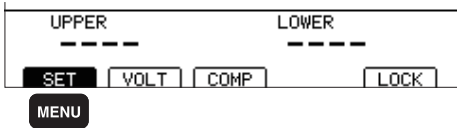

**MENU** Select **[SET]**.

**2** Select the panel number and select **[RENAME]**.

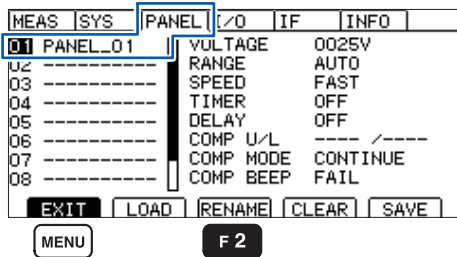

Selection

**F 2** Edit the panel name.

**MENU** Return to the Measurement screen.

**3** Change and confirm the panel name.

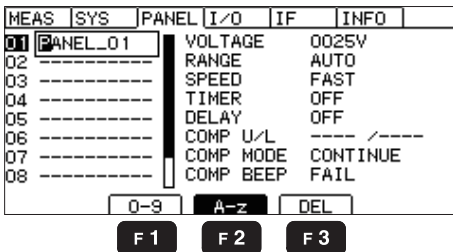

**ENTER** Confirm the panel name.

Key operations for entering a panel name

Key	Operation
	Moves the cursor.
	Changes the characters and values.
<b>F 1</b>	Enters a number from 0 to 9.
<b>F 2</b>	Enters a letter from A to Z or an underscore character (_).
<b>F 3</b>	Deletes a character.

## 6.4 Deleting the Panel Data

The measurement conditions saved by the panel save function are deleted.

### 1 Open the Settings screen.

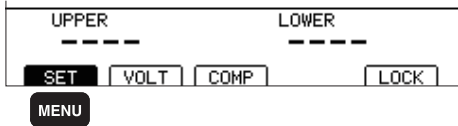

MENU Select **[SET]**.

### 2 Select and delete the panel number.

The panel description is displayed on the right side of the screen.

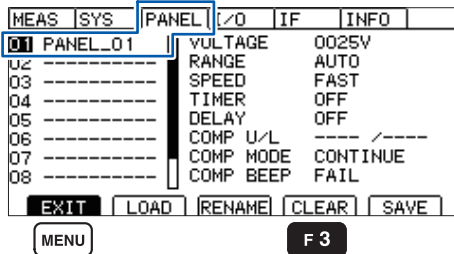

Selection

F3 Delete the panel number.

MENU Return to the Measurement screen.

### 3 Select **[OK]** in the confirmation screen.

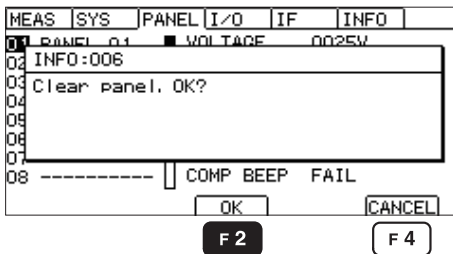

F2 OK

F4 Cancel deleting the panel.

The panel data cannot be restored once it is deleted.





# 7

## External Control (EXT.I/O)

The EXT.I/O terminal on the rear panel of the instrument supports external control by providing output of the TEST and comparator judgment signals, and accepting input of the START and STOP signals.

All signals are isolated with photocouplers. (The input/output common terminals are shared.) The input circuit can be switched to accommodate either current sink output (NPN) or current source output (PNP) by the internal settings of the instrument.

Check the input/output ratings and internal circuit structure, understand the safety precautions for connecting a control system, and use accordingly.

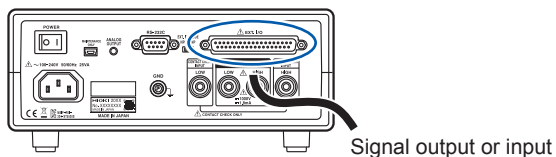

**Check the controller input and output specifications.**



**Set the EXT.I/O mode switch (NPN/PNP) on the instrument.  
(Operate the switch after the instrument power is turned off.)**



**Connect the EXT.I/O terminal to the signal output and input.**



**Set the instrument.**

# 7.1 External Input/Output Terminal and Signals

## Switching between current sink (NPN) and current source (PNP)

Before switching, thoroughly read “Before switching between current sink (NPN) and current source (PNP)” (p. 12).

The EXT.I/O mode switch (NPN/PNP) allows you to change the type of PLC (programmable controller) that is supported.

The instrument ships with the switch set to the NPN position.

	EXT.I/O mode switch (NPN/PNP) setting	
	NPN	PNP
Input circuit	Supports sink output.	Supports source output.
Output circuit	Non-polar	Non-polar
ISO_5 V output	+5 V output	-5 V output

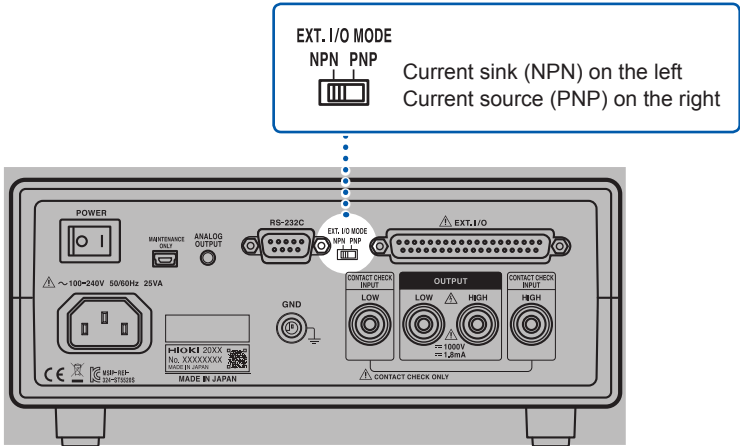

### ⚠ CAUTION



Do not operate the EXT.I/O mode switch (NPN/PNP) while the instrument is on.

## Connector type and signal pinouts

Before connecting a connector, thoroughly read “Before connecting EXT.I/O” (p. 12).

Use of EXT.I/O enables the following control functionality:

- Measurement start (START) → Measurement end (rising TEST signal) → Acquisition of judgment results (UPPER\_FAIL, LOWER\_FAIL, PASS and various ERR)
- Panel load (LOAD0 to LOAD3)

The functionality described in “Performing an I/O test (EXT.I/O test function)” (p. 103) provides a convenient way to check the EXT.I/O operation.

ST5520

Connector (instrument side)  
37-pin D-sub (socket contacts)  
with #4-40 screws  
Mating connectors

- DC-37P-ULR (solder type)
- DCSP-JB37PR (insulation displacement type)

Japan Aviation Electronics Industry Ltd.

ST5520-01

EXT.I/O terminal (instrument side)

**ST5520**

Pin	Signal name	I/O	Function	Logic	Pin	Signal name	I/O	Function	Logic
1	START	IN	Measurement start	Edge	20	STOP	IN	Measurement end	Edge
2	(Not used)	-	-	-	21	(Not used)	-	-	-
3	INTERLOCK	IN	Interlock	Level	22	LOAD0	IN	Panel number selection	Level
4	LOAD1	IN	Panel number selection	Level	23	LOAD2	IN	Panel number selection	Level
5	LOAD3	IN	Panel number selection	Level	24	(Not used)	-	-	-
6	(Not used)	-	-	-	25	(Not used)	-	-	-
7	(Not used)	-	-	-	26	(Not used)	-	-	-
8	ISO_5V	-	Isolated power supply +5 V (-5 V) output	-	27	ISO_COM	-	Isolated common signal ground	-
9	ISO_COM	-	Isolated common signal ground	-	28	TEST	OUT	During measurement	Level
10	ERR	OUT	Contact check error Short circuit check error Output voltage error	Level	29	(Not used)	-	-	-
11	UPPER FAIL	OUT	Comparator judgment	Level	30	PASS	OUT	Comparator judgment	Level
12	LOWER FAIL	OUT	Comparator judgment	Level	31	(Not used)	-	-	-
13	(Not used)	-	-	-	32	(Not used)	-	-	-
14	(Not used)	-	-	-	33	(Not used)	-	-	-
15	(Not used)	-	-	-	34	(Not used)	-	-	-
16	(Not used)	-	-	-	35	(Not used)	-	-	-
17	(Not used)	-	-	-	36	(Not used)	-	-	-
18	(Not used)	-	-	-	37	(Not used)	-	-	-
19	(Not used)	-	-	-					

- The connector frame is connected to the metal part on the instrument rear panel as well as the power inlet protective ground terminal.
- When switching panel load operation using commands or key operation, fix pins 4 and 5 as well as 22 and 23 to ON or OFF. (p.87)
- Output timing of the TEST signal varies depending on the setting of the TEST signal OFF timing.  
Refer to “7.4 Setting the TEST Signal OFF Timing” (p. 101).

## ST5520-01

Pin	Signal name	I/O	Function	Logic	Pin	Signal name	I/O	Function	Logic
1	START	IN	Measurement start	Edge	20	STOP	IN	Measurement end	Edge
2	(Not used)	-	-	-	21	(Not used)	-	-	-
3	INTERLOCK	IN	Interlock	Level	22	LOAD0	IN	Panel number selection	Level
4	LOAD1	IN	Panel number selection	Level	23	LOAD2	IN	Panel number selection	Level
5	LOAD3	IN	Panel number selection	Level	24	DP0	OUT	Decimal point output	Level
6	(Not used)	-	-	-	25	DP1	OUT	Decimal point output	Level
7	BCD0	OUT	BCD	Level	26	DP2	OUT	Decimal point output	Level
8	ISO_5V	-	Isolated power supply +5 V (-5 V) output	-	27	ISO_COM	-	Isolated common signal ground	-
9	ISO_COM	-	Isolated common signal ground	-	28	TEST	OUT	During measurement	Level
10	ERR	OUT	Contact check error Short circuit check error Output voltage error	Level	29	BCD8	OUT	BCD	Level
11	UPPER FAIL	OUT	Comparator judgment	Level	30	PASS	OUT	Comparator judgment	Level
12	LOWER FAIL	OUT	Comparator judgment	Level	31	BCD9	OUT	BCD	Level
13	BCD1	OUT	BCD	Level	32	BCD10	OUT	BCD	Level
14	BCD2	OUT	BCD	Level	33	BCD11	OUT	BCD	Level
15	BCD3	OUT	BCD	Level	34	BCD12	OUT	BCD	Level
16	BCD4	OUT	BCD	Level	35	BCD13	OUT	BCD	Level
17	BCD5	OUT	BCD	Level	36	BCD14	OUT	BCD	Level
18	BCD6	OUT	BCD	Level	37	BCD15	OUT	BCD	Level
19	BCD7	OUT	BCD	Level					

7

- The connector frame is connected to the metal part on the instrument rear panel as well as the power inlet protective ground terminal.
- When switching panel load operation using commands or key operation, fix pins 4 and 5 as well as 22 and 23 to ON or OFF. (p.87)
- Output timing of the TEST signal varies depending on the setting of the TEST signal OFF timing.  
Refer to “7.4 Setting the TEST Signal OFF Timing” (p. 101).

## Signal descriptions

### 1 Isolated power supply

Pin	Signal name	EXT.I/O mode switch (NPN/PNP) setting	
		NPN	PNP
8	ISO_5V	Isolated power supply +5 V	Isolated power supply -5 V
9, 27	ISO_COM	Isolated common signal ground	

### 2 Input signals

START	The START signal starts a test and generates output voltage.
STOP	The STOP signal ends a test and shuts off output voltage.
INTERLOCK	The signal to switch the interlock function between ON and OFF (When the interlock function is set to be enabled) Open the signal to switch to ON; or short-circuit, OFF. When the interlock function is ON, no tests can be started. In addition, if the interlock function is changed to ON during a test, the test stops. Refer to "7.7 Interlock Function"(p. 106) to set the interlock function.
LOAD0 to LOAD3	Saved test conditions can be selected. While a LOAD signal is input, the instrument enters the key lock state, accepting no key operations.

### 3 Output signals

PASS	This signal is output when the comparator judgment is PASS.
UPPER FAIL	This signal is output when the comparator judgment is UPPER FAIL.
LOWER FAIL	This signal is output when the comparator judgment is LOWER FAIL.
TEST	This signal is output during tests (During discharge, it is output based on the setting of TEST signal OFF timing).
ERR	This signal is output at the time of a contact check error, short circuit check error, output voltage error judgment. It is output when the contact check function or the short circuit check function is set to ON.
DP0 to DP2	The decimal point position is output in 4 bits when BCD output is used. (ST5520-01 only)
BCD0 to BCD15	A 4-digit and 16-bit measured value is output. (ST5520-01 only)

EXT.I/O input and output signals cannot be used while measurement conditions are changed.

## 4 Signal correspondence chart

LOAD0 to LOAD3

LOAD3	LOAD2	LOAD1	LOAD0	Panel number
OFF	OFF	OFF	OFF	No change
OFF	OFF	OFF	ON	1
OFF	OFF	ON	OFF	2
OFF	OFF	ON	ON	3
OFF	ON	OFF	OFF	4
OFF	ON	OFF	ON	5
OFF	ON	ON	OFF	6
OFF	ON	ON	ON	7
ON	OFF	OFF	OFF	8
ON	OFF	OFF	ON	9
ON	OFF	ON	OFF	10

\* External switch or transistor status

### Decimal point output

DP2	DP1	DP0	Decimal point output
ON	ON	ON	2000
ON	ON	OFF	200.0
ON	OFF	ON	20.00
OFF	ON	ON	2.000

\* Internal photocoupler status

### BCD output

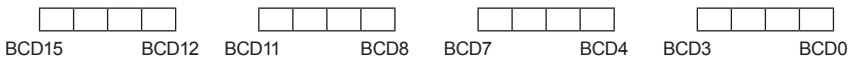

### Output example

For 2.481 MΩ

**2.**                      **4**                      **8**                      **1**                      **MΩ**

BCD output                          
 1: ON, 0: OFF

Decimal point      OFF (DP2), ON (DP1), ON (DP0)

## 7.2 Timing Chart

The each signal level indicates the ON/OFF status of a contact. In the current source (PNP) setting, the signal level is the same as the voltage level of EXT.I/O terminal. In the current sink (NPN) setting, the High and Low voltage levels are reversed.

Set the signal before starting a test to control the measurement conditions at the EXT.I/O terminal (LOAD0 to LOAD3). The measurement conditions cannot be changed during tests.

### IMPORTANT

When the START signal is input after the test voltage is changed, a time of up to 500 ms is added to detect the START signal.

#### Example

When the test voltage is changed by using the LOAD signal

When the test voltage is changed by using the RS command

### Continuous test mode timing chart (1)

When the test duration setting (TIMER) is OFF and the measurement is performed by the /START signal or /STOP signal input from EXT.I/O or when the test duration setting (TIMER) is OFF and the measurement is performed by the START key or STOP key on the panel

#### Setting

Test duration (TIMER)	Response time (DELAY)	TEST signal OFF timing
OFF	AUTO, 5 ms to 999.9 s	FAST



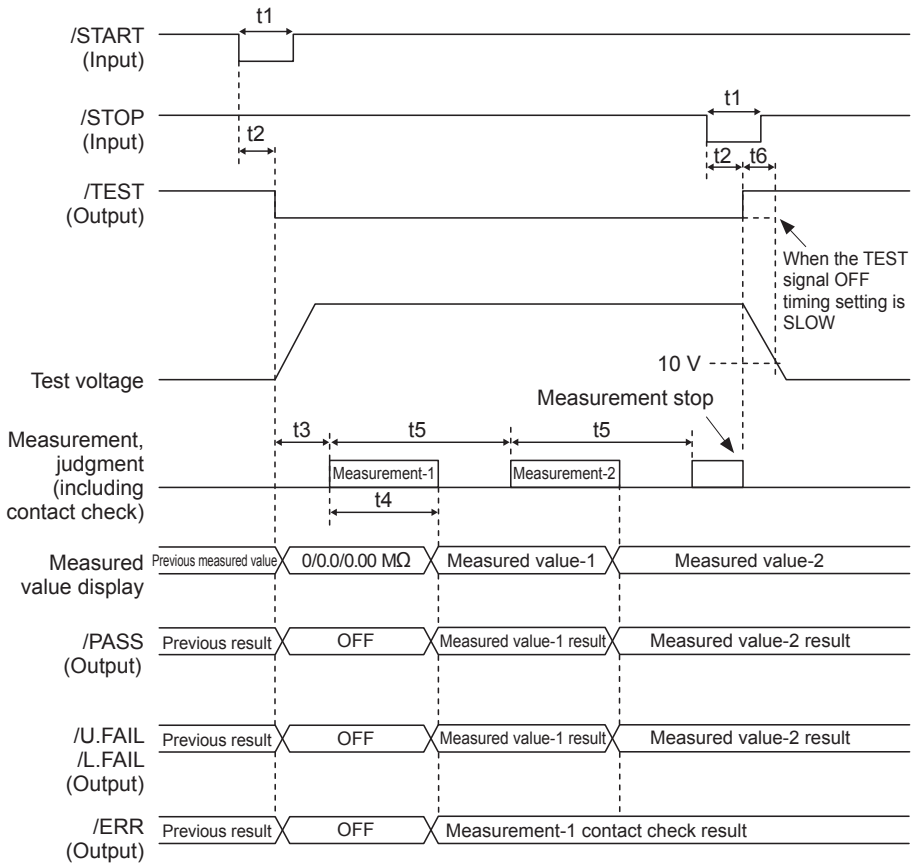

	Item	Time
t1	START, STOP signal pulse width	5 ms <sub>MIN.</sub>
t2	START, STOP signal detection time	5 ms <sub>MAX.</sub> *
t3	Response time (DELAY)	AUTO, 5 ms to 999.9 s
t4	Measurement time	Contact check: OFF 30 ms (FAST), 480 ms (SLOW)
	Contact check: ON	80 ms (FAST), 480 ms (SLOW)
t5	Measurement interval	Contact check: OFF 50 ms (FAST), 500 ms (SLOW)
	Contact check: ON	100 ms (FAST), 500 ms (SLOW)
t6	Discharge time (time for the output voltage to drop below 10 V)	20 ms <sub>MAX.</sub> (during pure resistance measurement)

\* When the START signal is input after the test voltage is changed, a time of up to 500 ms is added to detect the START signal.

**Continuous test mode timing chart (2)**

When the test duration setting (TIMER) is ON and the measurement is performed by the /START signal input from EXT.I/O or when the test duration setting (TIMER) is ON and the measurement is performed by the START key on the panel

**Setting**

Test duration (TIMER)	Response time (DELAY)	TEST signal OFF timing
ON, 45 ms to 999.9 s	AUTO, 5 ms to 999.9 s	FAST

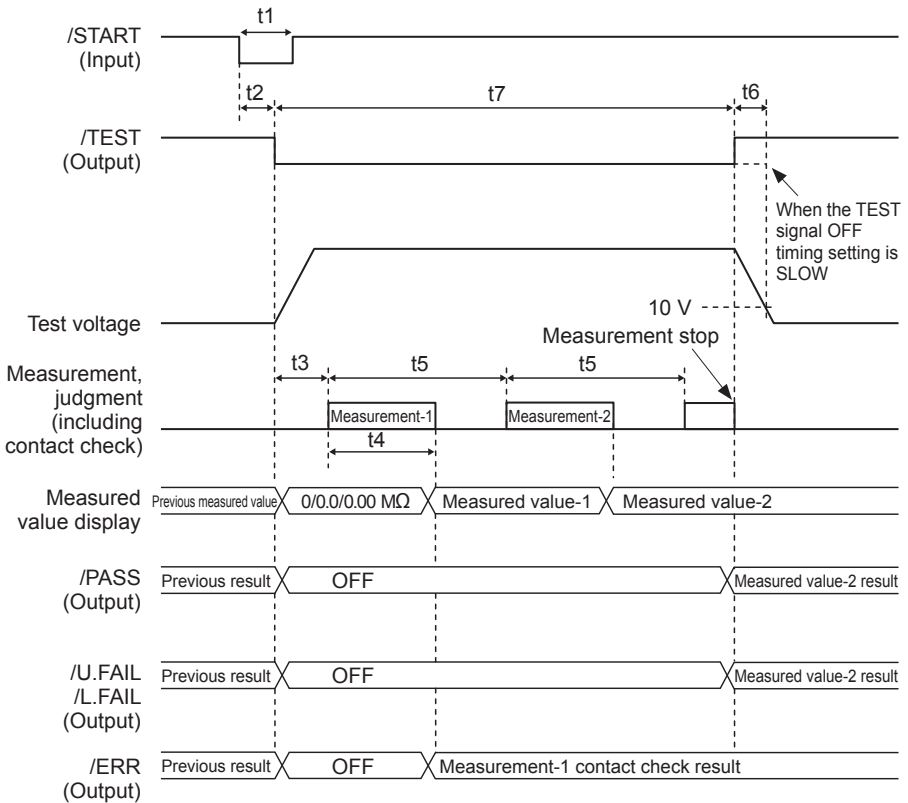

Item		Time	
t1	START, STOP signal pulse width	5 ms <sub>MIN.</sub>	
t2	START, STOP signal detection time	5 ms <sub>MAX.</sub> *	
t3	Response time (DELAY)	AUTO, 5 ms to 999.9 s	
t4	Measurement time	Contact check: OFF	30 ms (FAST), 480 ms (SLOW)
		Contact check: ON	80 ms (FAST), 480 ms (SLOW)
t5	Measurement interval	Contact check: OFF	50 ms (FAST), 500 ms (SLOW)
		Contact check: ON	100 ms (FAST), 500 ms (SLOW)
t6	Discharge time (time for the output voltage to drop below 10 V)	20 ms <sub>MAX.</sub> (during pure resistance measurement)	
t7	Test duration (TIMER)	45 ms to 999.9 s	

\* When the START signal is input after the test voltage is changed, a time of up to 500 ms is added to detect the START signal.

### PASS STOP mode timing chart

When the test duration setting (TIMER) is ON and the measurement is performed by the /START signal input from EXT.I/O or when the test duration setting (TIMER) is ON and the measurement is performed by the START key on the panel

#### Setting

Test duration (TIMER)	Response time (DELAY)	TEST signal OFF timing
ON, 45 ms to 999.9 s	AUTO, 5 ms to 999.9 s	FAST

When the test duration (TIMER) is set to OFF, tests are performed continuously until a PASS judgment is made.

# Timing Chart

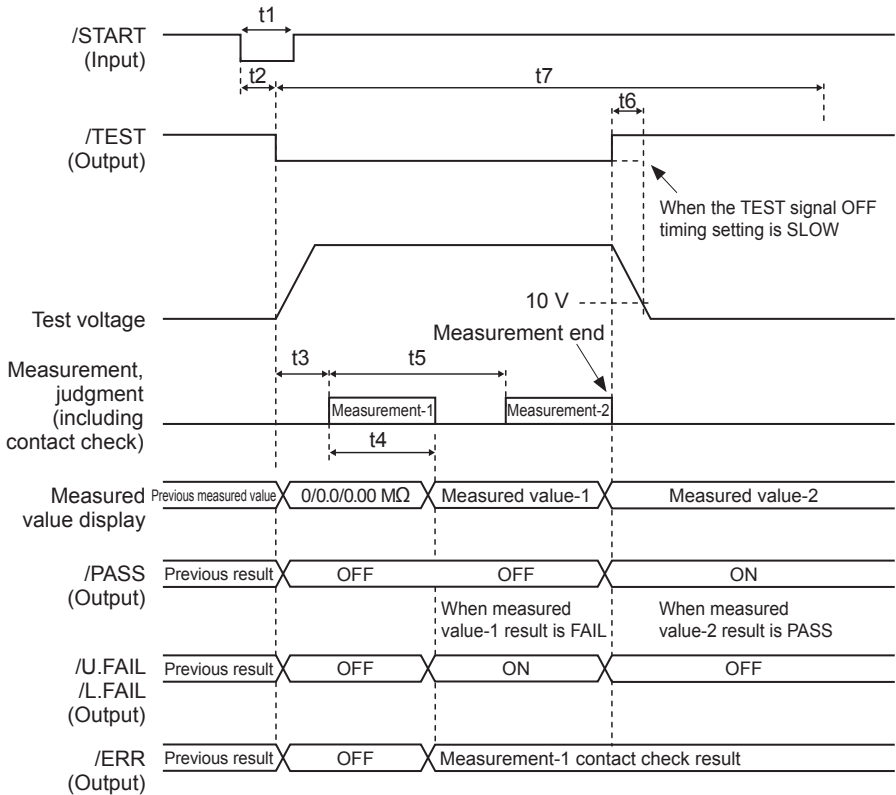

Item		Time
t1	START, STOP signal pulse width	5 ms <sub>MIN.</sub>
t2	START, STOP signal detection time	5 ms <sub>MAX.</sub> *
t3	Response time (DELAY)	AUTO, 5 ms to 999.9 s
t4	Measurement time	Contact check: OFF 30 ms (FAST), 480 ms (SLOW)
	Contact check: ON	80 ms (FAST), 480 ms (SLOW)
t5	Measurement interval	Contact check: OFF 50 ms (FAST), 500 ms (SLOW)
	Contact check: ON	100 ms (FAST), 500 ms (SLOW)
t6	Discharge time (time for the output voltage to drop below 10 V)	20 ms <sub>MAX.</sub> (during pure resistance measurement)
t7	Test duration (TIMER)	45 ms to 999.9 s

\* When the START signal is input after the test voltage is changed, a time of up to 500 ms is added to detect the START signal.

**FAIL STOP mode timing chart**

When the test duration setting (TIMER) is ON and the measurement is performed by the /START signal input from EXT.I/O or when the test duration setting (TIMER) is ON and the measurement is performed by the START key on the panel

**Setting**

Test duration (TIMER)	Response time (DELAY)	TEST signal OFF timing
ON, 45 ms to 999.9 s	AUTO, 5 ms to 999.9 s	FAST

When the test duration (TIMER) is set to OFF, tests are performed continuously until a FAIL judgment is made.

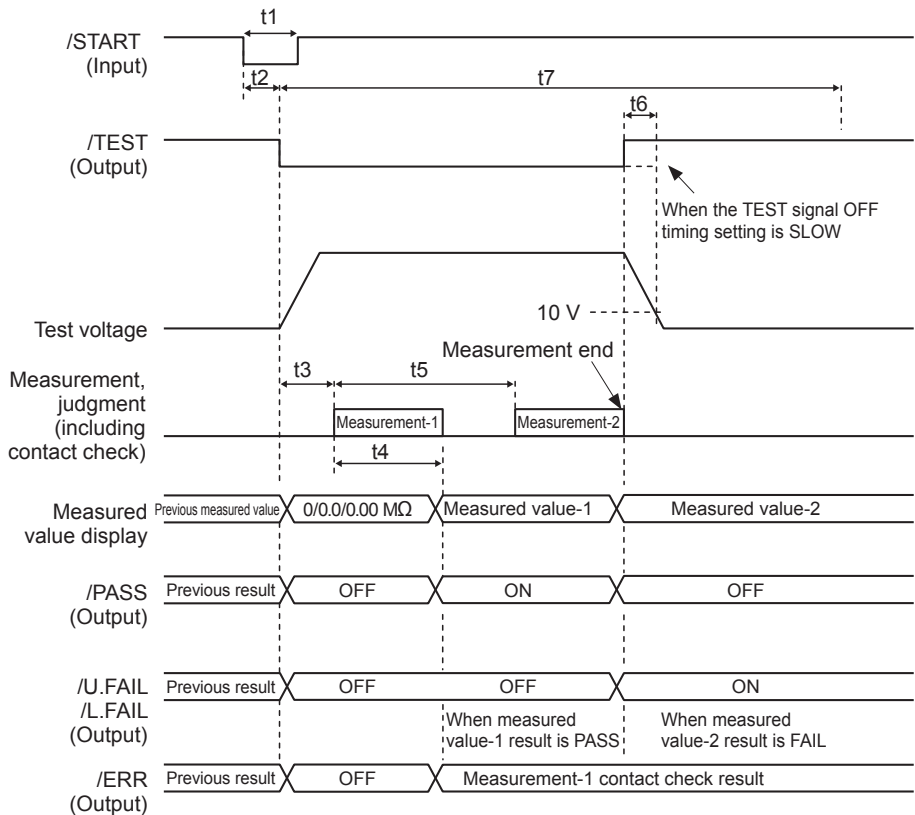

## Timing Chart

Item		Time	
t1	START, STOP signal pulse width	5 ms <sub>MIN.</sub>	
t2	START, STOP signal detection time	5 ms <sub>MAX.</sub> *	
t3	Response time (DELAY)	AUTO, 5 ms to 999.9 s	
t4	Measurement time	Contact check: OFF	30 ms (FAST), 480 ms (SLOW)
		Contact check: ON	80 ms (FAST), 480 ms (SLOW)
t5	Measurement interval	Contact check: OFF	50 ms (FAST), 500 ms (SLOW)
		Contact check: ON	100 ms (FAST), 500 ms (SLOW)
t6	Discharge time (time for the output voltage to drop below 10 V)	20 ms <sub>MAX.</sub> (during pure resistance measurement)	
t7	Test duration (TIMER)	45 ms to 999.9 s	

\* When the START signal is input after the test voltage is changed, a time of up to 500 ms is added to detect the START signal.

### Forced termination judgment mode timing chart

When the test duration setting (TIMER) is OFF and the measurement is performed by the /START signal or /STOP signal input from EXT.I/O or when the test duration setting (TIMER) is OFF and the measurement is performed by the START key or STOP key on the panel

### Setting

Test duration (TIMER)	Response time (DELAY)	TEST signal OFF timing
OFF	AUTO, 5 ms to 999.9 s	FAST

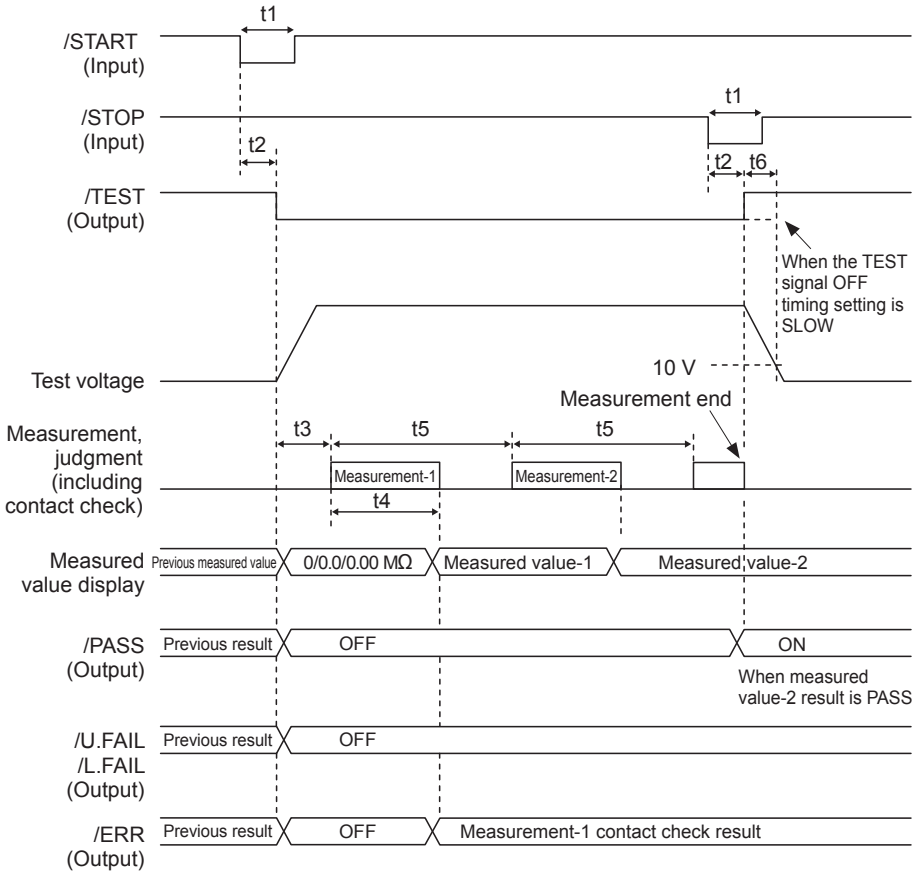

Item		Time
t1	START, STOP signal pulse width	5 ms <sub>MIN.</sub>
t2	START, STOP signal detection time	5 ms <sub>MAX.</sub> *
t3	Response time (DELAY)	AUTO, 5 ms to 999.9 s
t4	Measurement time	Contact check: OFF
		Contact check: ON
t5	Measurement interval	Contact check: OFF
		Contact check: ON
t6	Discharge time (time for the output voltage to drop below 10 V)	20 ms <sub>MAX.</sub> (during pure resistance measurement)

\* When the START signal is input after the test voltage is changed, a time of up to 500 ms is added to detect the START signal.

## 7.3 Internal Circuit Configuration

### NPN setting

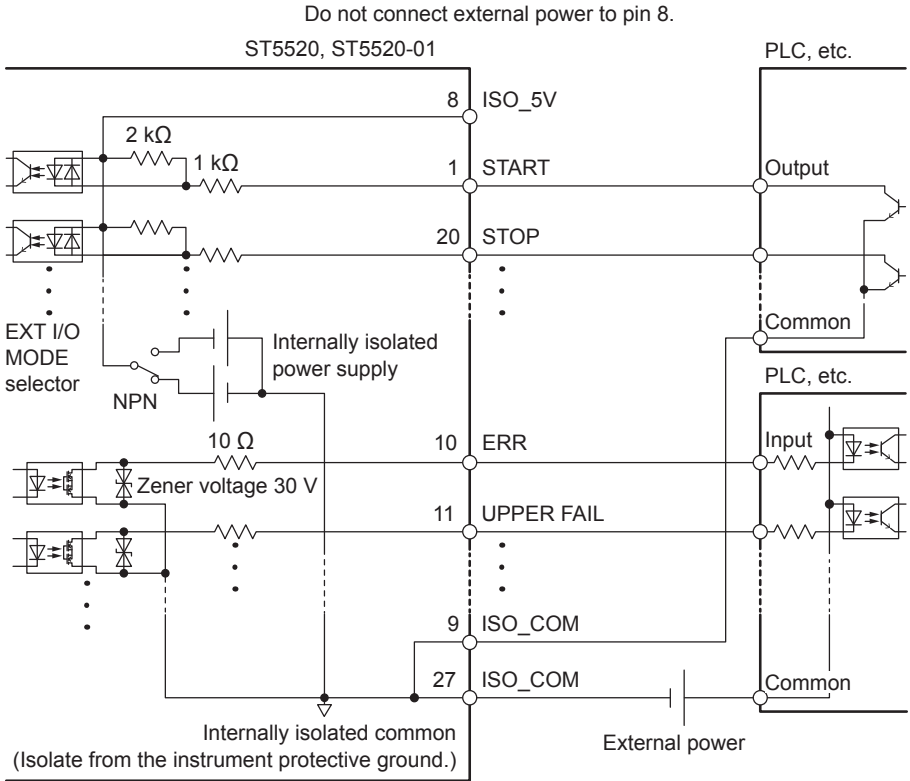

- Use ISO\_COM as the common terminal for both input and output signals.
- If a high current flows to common wiring, branch the output signal common wiring and input signal common wiring from the position close to the ISO\_COM terminal.
- When supplying power from an external device, supply power to the external power supply shown in the above figure.



## PNP setting

Do not connect external power to pin 8.

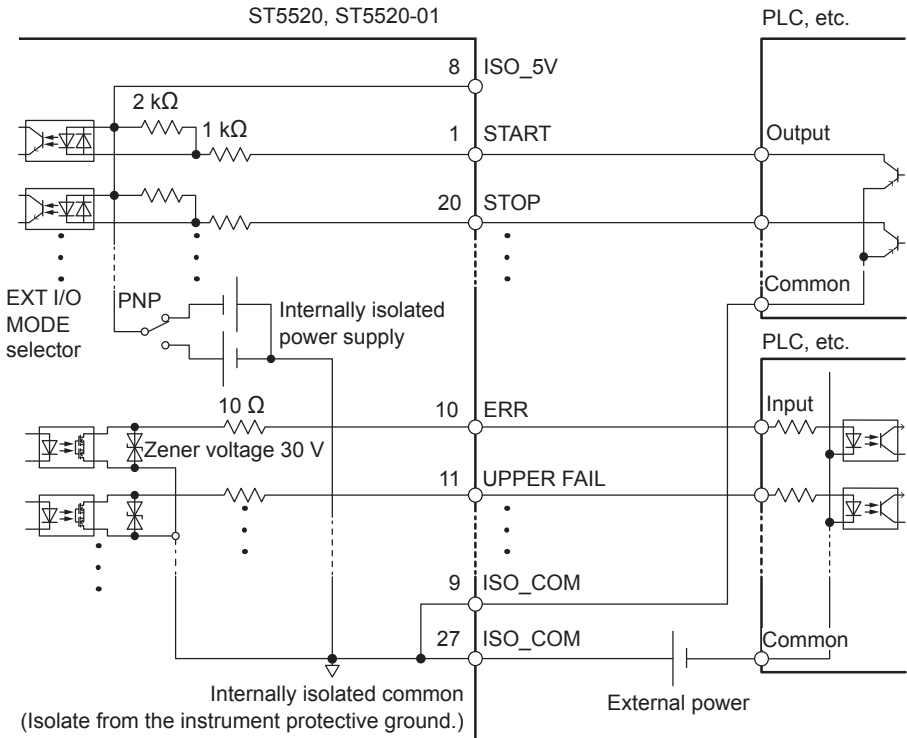

- Use ISO\_COM as the common terminal for both input and output signals.
- When supplying power from an external device, supply power to the external power supply shown in the above figure.

## Electrical specifications

<b>Input signals</b>	Input type	Photocoupler-isolated, non-voltage contact inputs (Current sink/source output compatible)
	Input ON	Residual voltage 1 V or less (Input ON current 4 mA (reference value))
	Input OFF	OPEN (Shutoff current 100 $\mu$ A or less)
<b>Output signals</b>	Output type	Photocoupler-isolated, open drain output (non-polar)
	Maximum load voltage	30 V DC <sub>MAX</sub>
	Maximum output current	50 mA/ch
	Residual voltage	1 V or less (load current 50 mA)/0.5 V or less (load current 10 mA)
<b>Internally isolated power supply</b>	Output voltage	Sink output: 5.0 V $\pm$ 10%, source output: -5.0 V $\pm$ 10%
	Maximum output current	100 mA
	External power input	None
	Isolation	Floating from protective ground potential and measurement circuit
	Isolation rating	Terminal to ground voltage 50 V DC, 30 V AC <sub>RMS</sub> , and 42.4 V AC <sub>PEAK</sub> or less

## Connection examples

### Input circuit connection examples

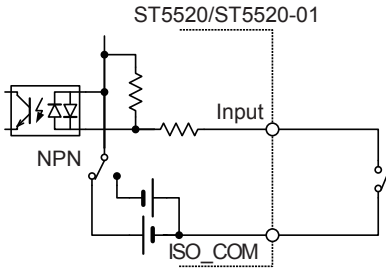

Switch connections

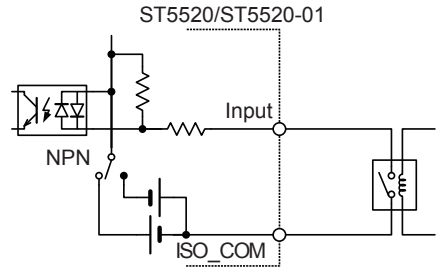

Relay connections

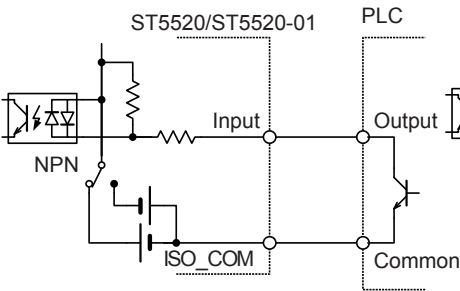

PLC output (NPN output) connections

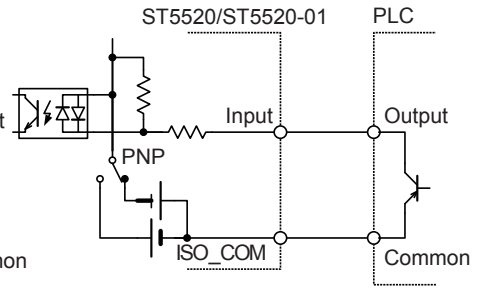

PLC output (PNP output) connections

**Output circuit connection examples**

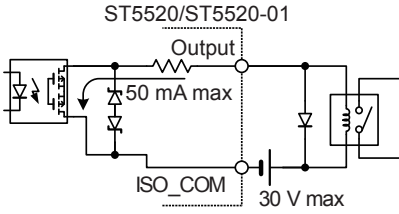

Relay connections

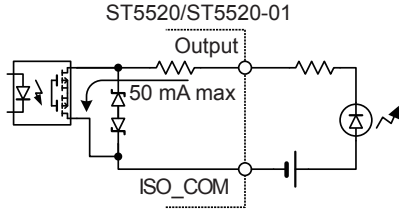

LED connections

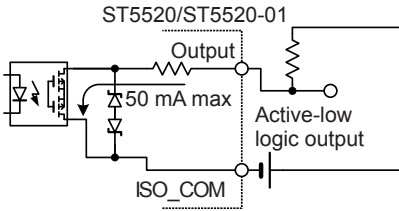

Active-low logic output

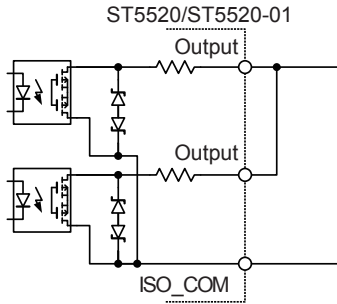

Wired OR

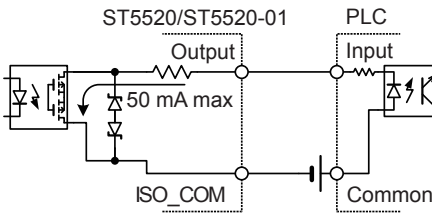

PLC input (plus common input) connections

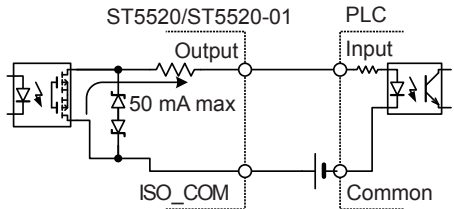

PLC input (minus common input) connections

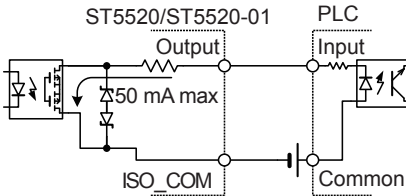

PLC input (plus common input) connections

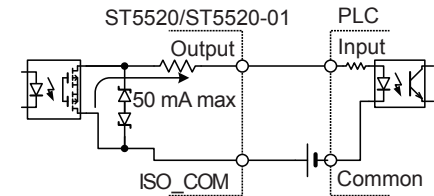

PLC input (minus common input) connections

## 7.4 Setting the TEST Signal OFF Timing

There are two timing options for the EXT.I/O TEST signal output to return from LOW to HIGH when a test is completed.

### 1 Open the Settings screen.

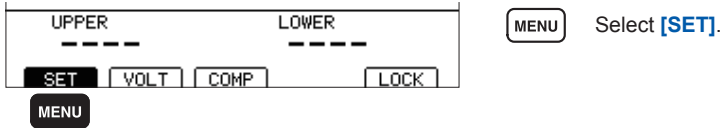

### 2 Select the operation mode for [EXT.I/O TEST-PIN].

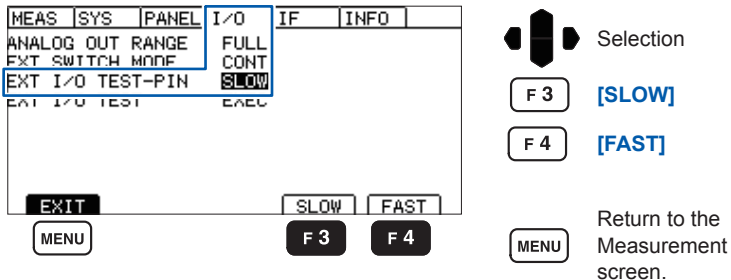

<b>[SLOW]</b>	After a test is completed, LOW (status during the test) is maintained until the voltage of the equipment to be measured drops to approximately 10 V due to the discharge function.
<b>[FAST]</b>	Regardless of the level of discharge, the status returns to HIGH almost simultaneously after a test is completed.

# Setting the TEST Signal OFF Timing

## SLOW

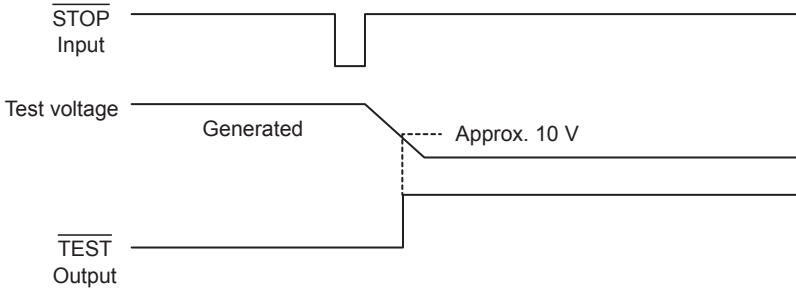

## FAST

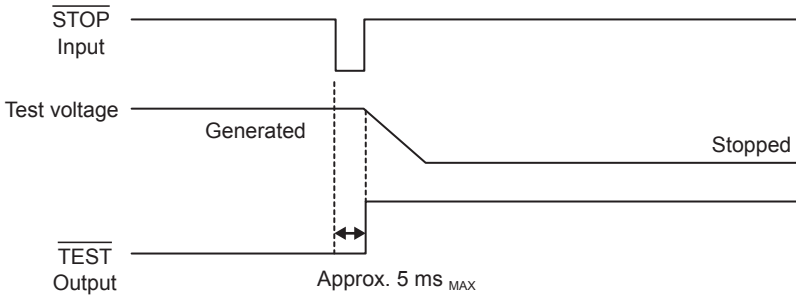

## 7.5 Checking External Control

### Performing an I/O test (EXT.I/O test function)

In addition to switching output signals between ON and OFF manually, the input signal status can be viewed on the screen.

#### 1 Open the Settings screen.

MENU Select **[SET]**.

#### 2 Select the operation mode for **[EXT.I/O TEST]**.

Selection

F 4 Execute

MENU Return to the Measurement screen.

#### 3 Perform the EXT.I/O test.

**Output signals**

Allows you to perform signal operations.  
(ON: Reverse display, OFF: Normal display)

Select the signal.

F 3 Turn ON the signal.

F 4 Turn OFF the signal.

MENU Return to the EXT.I/O Settings screen.

**Input signals**

Displays the signal status. (ON: Reverse display, OFF: Normal display)  
Displays LOCK in reverse video. (ON: Normal display, OFF: Reverse display)

## 7.6 Using Analog Output

There are two voltage output ranges of analog output.

During a test, analog output is output at the same timing as the measured value display. After the test is completed, analog output continues to output and hold the final voltage.

### 1 0 to 4 V is output within the all measured resistance ranges. ([FULL])

The voltages indicated in the table below are output without regard to the resistance range.

The instrument outputs no voltage (0 V) for the minimum value of the resistance value range of each test voltage, and a voltage of 4 V for the maximum value.

The voltage proportional to the resistance is output in the middle.

Measurement voltage	Resistance value range	Output voltage (DC)
$25\text{ V} \leq V < 100\text{ V}$	0.000 M $\Omega$ to 400.0 M $\Omega$	0 V to 4 V
$100\text{ V} \leq V < 500\text{ V}$	0.000 M $\Omega$ to 4000 M $\Omega$	0 V to 4 V
$500\text{ V} \leq V \leq 1000\text{ V}$	0.000 M $\Omega$ to 4000 M $\Omega$	0 V to 4 V
All measurement voltages	Over. F	4 V
	Under. F	0 V

### 2 The voltage is output according to each resistance range. ([EACH])

The voltages indicated in the table below are output according to the resistance range.

When the maximum value in each resistance range is displayed, 4 V is output.

For the procedure to set and check the resistance range, refer to “3.2 Setting the Range” (p.36).

Resistance range	Resistance value range	Output voltage (DC)
2 M $\Omega$	0.000 M $\Omega$ to 4.000 M $\Omega$	0 V to 4 V
20 M $\Omega$	0.00 M $\Omega$ to 40.00 M $\Omega$	0 V to 4 V
200 M $\Omega$	0.0 M $\Omega$ to 400.0 M $\Omega$	0 V to 4 V
2000 M $\Omega$ ( $100\text{ V} \leq V < 500\text{ V}$ )	0 M $\Omega$ to 4000 M $\Omega$	0 V to 4 V
4000 M $\Omega$ ( $500\text{ V} \leq V \leq 1000\text{ V}$ )	0 M $\Omega$ to 4000 M $\Omega$	0 V to 4 V
All resistance ranges	Over. F	4 V
	Under. F	0 V

“Under. F” is displayed and 0 V is output when the measured value is less than 1.90 M $\Omega$  in 20 M $\Omega$  range, less than 19.0 M $\Omega$  in 200 M $\Omega$  range, or less than 190 M $\Omega$  in 2000/4000 M $\Omega$  range.



## Connecting the output cord

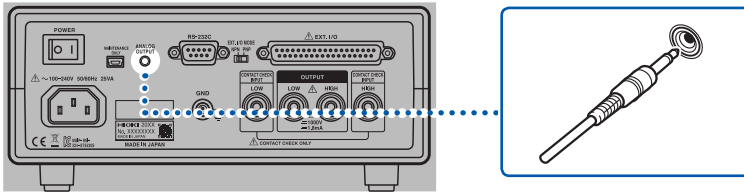

The analog output terminal on the rear panel outputs direct voltage proportional to the resistance.

When connecting to a recorder, etc., use an output cord with an input resistance of 1 MΩ or more.

When the input resistance is low, accurate measurement cannot be performed.

### ⚠ CAUTION



To avoid damage to the instrument or the output cord, do not input voltage or current externally to the analog output terminal. Do not connect the output cord plug to the measurement terminal of the instrument.

## Setting the analog output

### 1 Open the Settings screen.

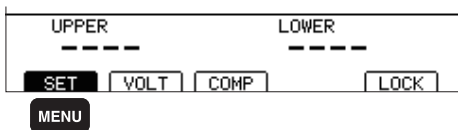

**MENU** Select **[SET]**.

### 2 Select **[ANALOG OUT RANGE]**.

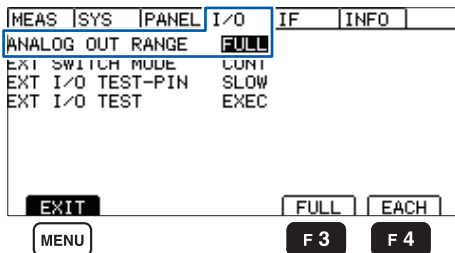

**Selection**

**F 3** **[FULL]**

**F 4** **[EACH]**

**MENU** Return to the Measurement screen.

**[FULL]** 0 to 4 V is output within the all measured resistance ranges.

**[EACH]** The voltage is output according to each resistance range.

## 7.7 Interlock Function

The interlock function is used to cut off any output from the instrument by linking with an external device.

Once the interlock function is activated, all key operations are disabled.

When the interlock function is enabled in the I/O screen of the EXT.I/O Settings screen, the interlock function runs when Pin 3 of EXT.I/O (INTERLOCK) is ON.

**1** Connect pin 3 of EXT.I/O (INTERLOCK) to ISO\_COM (pin 9, pin 27). (p.83)

**2** Check that **[LOCK]** at the upper right corner is not lit on the Measurement screen.

If **[LOCK]** is lit, there is a possibility of a connection failure. Check the connection performed in step **1**.

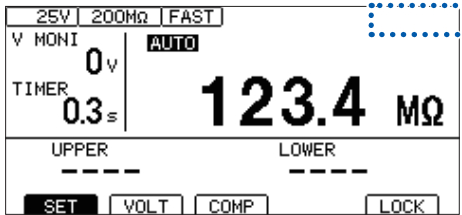

**3** Open the Settings screen.

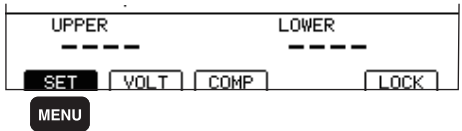

MENU Select **[SET]**.

**4** Make the settings for **INTERLOCK**.

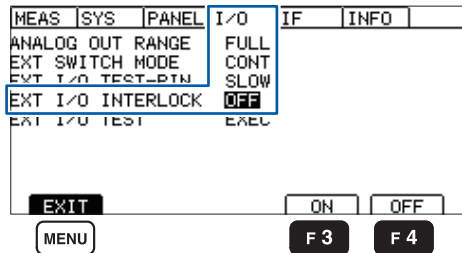

Selection

F 3 **[ON]**

F 4 **[OFF]**

MENU Return to the Measurement screen.

<b>[ON]</b>	The interlock function is activated. All key operations are disabled. In addition, no tests can be started using EXT.I/O, any command, or a switched probe. If the interlock function is changed to ON during the test, the test is stopped.
<b>[OFF]</b>	The interlock function is not set. (Default setting) Normal tests can be performed.

There are two ways available to release the interlock.

- Turning on the power while pressing the **MENU** + Down keys.
- Sending the **:IO:ILock OFF** command

### If a key is pressed when the interlock function is active

When the interlock function is active, **[LOCK]** is displayed at the upper right corner of the screen. If a key is pressed in this status, an error message appears.

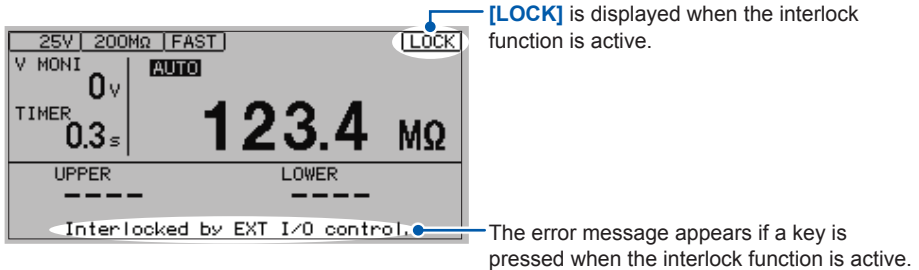

When the interlock function is enabled and INTERLOCK of EXT.I/O is open, once the interlock function is turned to ON, the interlock cannot be canceled from the Settings screen.  
Refer to “10.2 Troubleshooting” (p. 171).

## 7.8 Using the Switched Probe

The optional switched probe enables the start and stop operations of the ST5520/ST5520-01 while the probe is held in hand.

Before a test, set the push switch mode to either trigger (**[TRIG]**) or continuous (**[CONT]**). It is initially set to continuous mode (**[CONT]**).

### 1 Open the Settings screen.

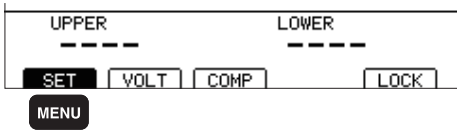

**[MENU]** Select **[SET]**.

### 2 Select the operation mode for **[EXT.SWITCH MODE]**.

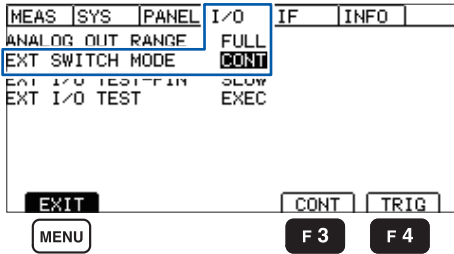

**[Selection]**

**[F 3]** **[CONT]**

**[F 4]** **[TRIG]**

**[MENU]** Return to the Measurement screen.

<b>[CONT]</b> (Continuous mode)	A test is performed only when the push switch is pressed. When the push switch is released, the test is terminated.
<b>[TRG]</b> (Trigger mode)	Press the push switch to start a test. The test continues even when the push switch is released. When the push switch is pressed during the test, the test is terminated.

- For the operation of the ST5520 and ST5520-01 when the switched probe is used, refer to “Enabled/disabled input list” (p. 166).
- The 9299 Switched Probe can be used as an ordinary probe when the switch signal line plug is not connected to the EXT.SW terminal.

## Connecting the 9299 Switched Probe

### ⚠ WARNING



- When the switch signal line plug is inserted into the terminal, the TEST lamp may blink and high voltage may occur in the measurement terminal or the probe tip. To avoid the risk of electric shock, make sure to remove the measurement probe from the measurement terminal before connecting the switch signal line plug to the instrument.
- Do not press the push switch on the switched probe when connecting and disconnecting the switched probe. Unintentional high voltage may be generated which may cause electric shock or damage to the connected equipment.

### IMPORTANT

When the switched probe is used, one more measurement probe is required. Prepare the extra L2200 (black).

### Connecting the Switched Probe

- 1 Connect the 9299 switch signal line plug to the EXT.SW terminal on the front of the instrument. (Insert the plug completely until the metal part of the signal line plug is not exposed.)

When the TEST lamp blinks, press the push switch of the 9299 or the **STOP** key of the ST5520/ST5520-01 to turn off the TEST lamp.

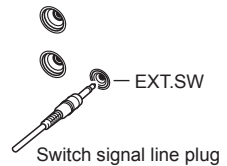

- 2 Check that the TEST lamp is off and then connect the 9299 measurement plug to the HIGH terminal on the front panel.

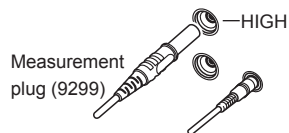

- 3 Connect the L2200 Test Lead (black) to the LOW terminal on the front panel.

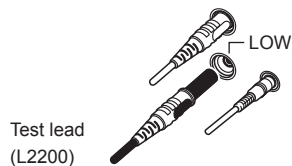

- 4 Press the push switch of the switched probe and check that the TEST lamp of the instrument blinks.



**Disconnecting the switched probe**

**IMPORTANT**

When disconnecting the switched probe from the instrument, remove the switch signal line plug last.

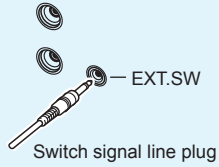

## 7.9 Accessory Connector Assembly

The EXT.I/O connector and covers, etc. are supplied with the instrument. Assemble the connector according to the following procedure.

- Use a shielded cable to connect the EXT.I/O connector and a PLC, etc. If a shielded cable is not used, the influence of noise could cause the system to malfunction.
- Connect the shield to the ISO\_COM terminal of EXT.I/O.
- If any of the supplied screws are missing or damaged, contact your authorized Hioki distributor or reseller.

### Required items

- Screwdriver
- Shielded cable
- Soldering iron

### Accessories

- |   |                  |
|---|------------------|
| • <b>A</b> Cover                                  | 1 set (2 pieces) |
| • <b>B</b> Screw (+/-) #4-40UNC (length: 16.9 mm) | 2 pieces         |
| • <b>C</b> Screw (+/-) #4-40UNC (length: 12.6 mm) | 2 pieces         |
| • <b>D</b> Screw (-) #4-40UNC (length: 15.0 mm)   | 2 pieces         |
| • <b>E</b> Nut #4-40UNC                           | 2 pieces         |
| • <b>F</b> Retainer (for cable)                   | 2 pieces         |
| • <b>G</b> Retainer (case protection)             | 2 pieces         |
| • <b>H</b> Connector                              | 1 piece          |

### Assembly procedure

1. Solder the cable (shielded cable) to connector (H) of EXT.I/O.
2. Attach retainers (F) to the cable using screws (C).
3. Position retainers (F) according to the specified positions of covers (A).
4. Insert screws (D) through retainers (G).
5. Place connector (H), retainers (F), retainers (G), and screws (D) on one of covers (A).
6. Place the other cover (A).
7. Secure covers (A) using screws (B) and nuts (E). Note that tightening the screws excessively can damage the covers.

Accessory Connector Assembly

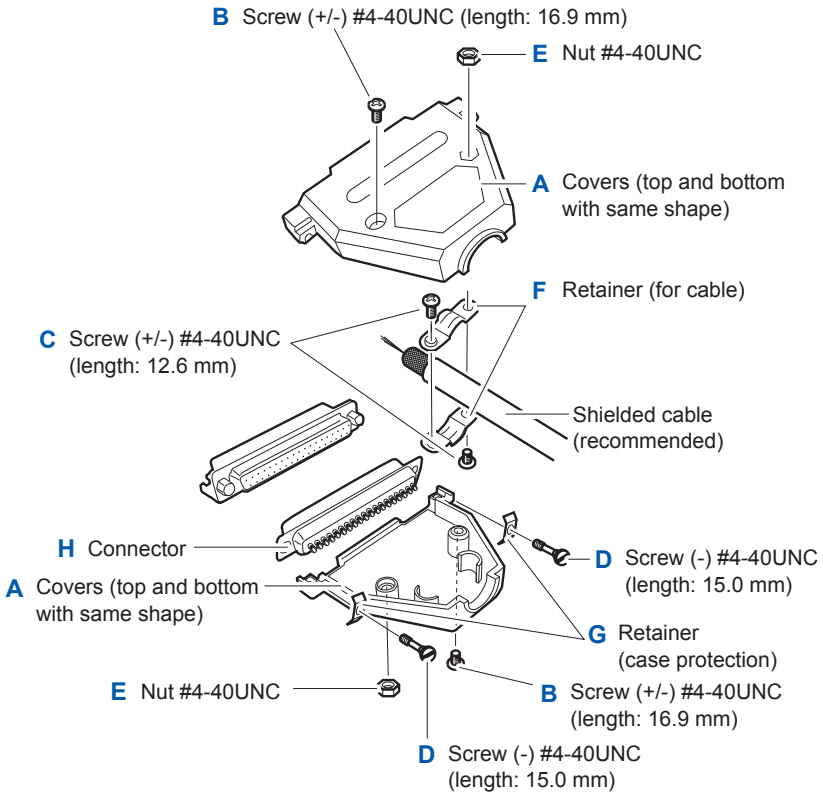





# Communications (RS-232C interface)

Before connecting the communication cables, thoroughly read “Usage Notes” (p. 7).

## 8.1 Interface Overview and Features

The communications interface can be used to control the instrument and acquire data.

Refer to the section that is relevant to your application.

- To control the instrument with commands  “8.4 Controlling the Instrument and Acquiring Data with Commands” (p. 120)
- To create a control program
- To acquire measured values without using commands  “8.3 Automatically Exporting Measured Values at the Ends of Tests (Data output function)” (p. 118)

### Communications time

- There may be a delay in display processing depending on the frequency and nature of any communications processing performed.
- The data transfer time must be added when communicating with a controller.  
The RS-232C transfer time can be approximated with the following formula, where the transfer speed (baud rate) is N bps using 1 start bit, 8 data bits, no parity, 1 stop bit, for a total of 10 bits.  
Transfer time T [1 character/sec.] = Baud rate N [bps]/10 [bits]  
Since measured values are 11 characters in length, the transfer time for 1 piece of data is 11/T.  
(Example) For a 9,600 bps connection,  $11/(9600/10)$  = Approximately 11 ms

### Output Queue and Input Buffer

#### Output Queue

Response messages are stored in the output queue until read by the controller. The output queue is also cleared in the following circumstances:

- Power on
- Query Error

The output queue capacity of the instrument is 64 bytes. If response messages overflow the buffer, a query error is generated and the output queue is cleared.

#### Input Buffer

The input buffer capacity of the instrument is 256 bytes. More than 256 bytes of data will not be accepted.

Ensure that the no command ever exceeds 256 bytes.

## 8.2 Using the RS-232C Interface

### CAUTION



- To avoid damage to the instrument, do not short connectors or output components or input voltage.



- To avoid electric shock or damage to the instrument, turn off the instrument before connecting or disconnecting the RS-232C interface connectors.
- To avoid equipment failure, do not disconnect the connecting data cable while communications are in progress.
- Use a common ground for both the instrument and the computer. Using different ground circuits will result in a potential difference between the instrument's ground and the computer's ground. If the connecting data cable is connected while such a potential difference exists, it may result in equipment malfunction or failure.
- Before connecting or disconnecting any connecting data cable, always turn off the instrument and the computer. Failure to do so could result in equipment malfunction or damage.
- After connecting the connecting data cable, tighten the screws on the connector securely. Failure to secure the connector could result in equipment malfunction or damage.

## Setting communications conditions

Make the following instrument settings.

**1**

Open the Settings screen.

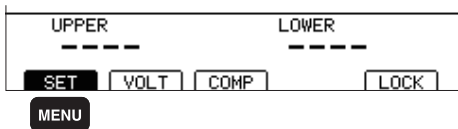

**MENU** Select **[SET]**.

## 2 Select the interface transfer speed (baud rate) for [RS-232 SPEED].

MEAS	SYS	PANEL I/O	IF	INFO
RS-232C SPEED		9600bps		
DATA OUT	OFF			
CMD MONITOR	OFF			
EXIT		9600	19200	38400
MENU	F 2	F 3	F 4	



Selection

F 2 [9600] (bps)

F 3 [19200] (bps)

F 4 [38400] (bps)

MENU Return to the Measurement screen.

The transfer speed (baud rate) setting may not be usable with some computers due to a large margin of error. In this case, switch to a slower setting.

### Set the controller (computer or PLC, etc.).

Make sure to set the controller as shown below.

- Start-stop synchronization
- Transfer speed: 9,600 bps / 19,200 bps / 38,400 bps (Set to match the instrument setting.)
- Stop bit: 1
- Data length: 8
- Parity check: None
- Flow control: None

### Connecting the RS-232C cable

Connect the RS-232C cable to the RS-232C connector. When connecting the cable, be sure to tighten the connector in place with screws.

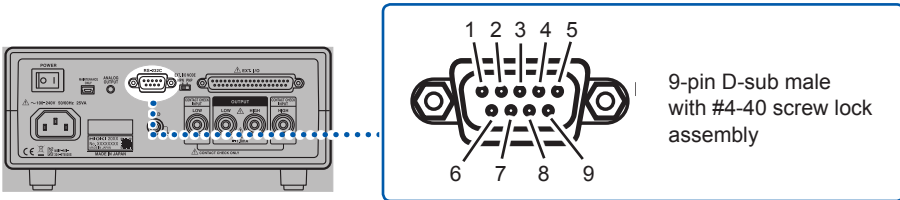

Rear panel

To connect the instrument to a controller (DTE), use a crossover cable compatible with the connectors on the instrument and the controller.

The I/O connector is a terminal (DTE) configuration.

This instrument uses pin numbers 2, 3, and 5. Other pins are not connected.

Pin No.	Signal name			Signal	Remarks
	Common	EIA	JIS		
1	DCD	CF	CD	Carrier detect	Not used
2	RxD	BB	RD	Receive data	
3	TxD	BA	SD	Transmit data	
4	DTR	CD	ER	Data terminal ready	ON level (+5 to +9 V) fixed
5	GND	AB	SG	Signal ground	
6	DSR	CC	DR	Data set ready	Not used
7	RTS	CA	RS	Request to send	ON level (+5 to +9 V) fixed
8	CTS	CB	CS	Clear to send Not used	
9	RI	CE	CI	Ring indicator	Not used

### When connecting the instrument with a computer

Use a crossover cable with 9-pin D-sub (socket contacts) connectors.

#### Crossover wiring

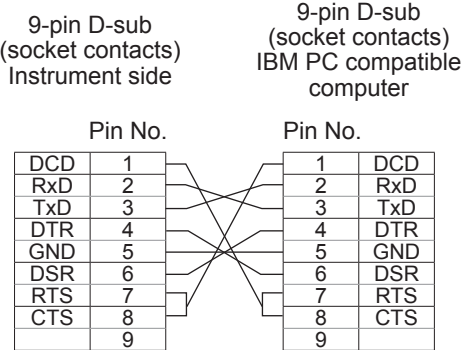

Recommended cable: Hioki 9637 RS-232C Cable (9pin-9pin/1.8 m)

### When connecting a controller with a 25-pin D-sub port

Use a crossover cable with a 9-pin D-sub (socket contacts) and a 25-pin D-sub (pin contacts) connector.

As in the figure shown below, the RTS and CTS pins are shorted and crossed to the DCD in the other connector.

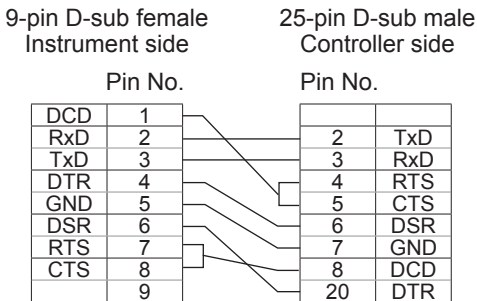

Recommended cable: Hioki 9638 RS-232C Cable (9pin-25pin/1.8 m)

The combination of a dual 25-pin D-sub (pin contacts) cable and a 9-pin to 25-pin adapter cannot be used.

## 8.3 Automatically Exporting Measured Values at the Ends of Tests (Data output function)

When a test is completed, the instrument can send measured values automatically as data to a computer via the RS-232C interface.

If the START key is pressed with TYPE 1 or TYPE 2 selected, do not send any commands to the instrument until the computer receives the measured values. Doing so may cause measured values to be sent twice.

### 1 Open the Settings screen.

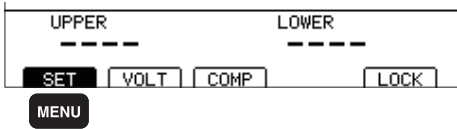

MENU Select [SET].

### 2 Set [DATA OUT] to [ON].

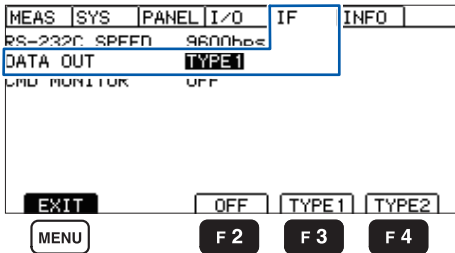

Selection

F 2

OFF (Automatic exporting is disabled.)

F 3

TYPE1 (Automatic exporting in TYPE 1 format is enabled.)

F 4

TYPE2 (Automatic exporting in TYPE 2 format is enabled.)

MENU

Return to the Measurement screen.

## Preparing connected equipment (computer, PLC, or others)

Set the equipment to the receive standby state. For a computer, start up the application software and set it to the receive standby state.

### Data output example

#### TYPE1

Blank		Blank									
Data No.		Measured value		Unit		Blank		Judgment			
				M o h m							
1		1 . 2 3 4						P A S S			
to		1 2 . 3 4						L F A I L			
6 5 5 3 5		1 2 3 . 4						U F A I L			
		1 2 3 4						U L F A I L			
								N O C O M P			
		O . F .									
		U . F .									
		C . H i									
		C . L o									
		C . H L									
		S h o r t									

• When the number reaches 65535, the next number returns to 1.

• With a range other than the 2 MΩ range used, a blank character is sent for each cell that contains a zero when the cell represents a digit greater than the leftmost digit of a measured value.

• When no measurement is performed, the measured value is shown as “-”(hyphen).

• When DATA OUT is set to OFF, the number returns to 1.

- \*1 The range is 2 MΩ
- \*2 The range is 20 MΩ
- \*3 The range is 200 MΩ
- \*4 The range is 2000/4000 MΩ
- \*5 Overflow
- \*6 Underflow
- \*7 Fail result for the contact check on the HIGH side
- \*8 Fail result for the contact check on the LOW side

- \*9 Fail result for the contact check on both the HIGH and LOW sides
- \*10 Fail result for the short circuit check
- \*11 PASS judgment
- \*12 L.FAIL judgment
- \*13 U.FAIL judgment
- \*14 Judgment is not possible
- \*15 Judgment is not performed

Refer to “Range display” (p.155) for the measurable ranges.

#### TYPE2

Data is output using the response format for the :MEASure? query. (Refer to “8.5 Data Format Table” (p.126))

## 8.4 Controlling the Instrument and Acquiring Data with Commands

For communications commands and query notation, refer to “8.6 Command Reference” (p. 127). When creating programs, the communications monitor function can be used to display commands and responses on the Measurement screen.

### Remote and local states

During remote control operation, **[RMT]** is displayed on the Measurement screen and all operation keys except for the **MENU** and **STOP** keys are disabled.

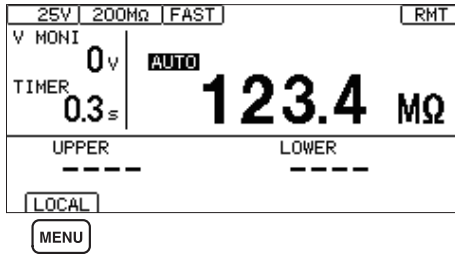

Cancel the remote state.



Stop measurement.

When the **MENU** key is pressed, the remote state is cancelled and the key operation is enabled.



## Displaying communications commands (Communications monitor function)

The communications monitor function can be used to display communications commands and query responses on the screen.

### 1 Open the Settings screen.

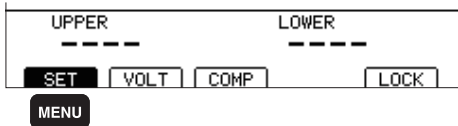

MENU Select **[SET]**.

### 2 Set **[CMD MONITOR]** to **[ON]**.

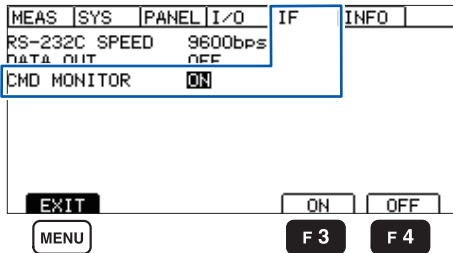

Selection

F3 **[ON]**

F4 **[OFF]**

MENU Return to the Measurement screen.

### 3 The communications command is displayed.

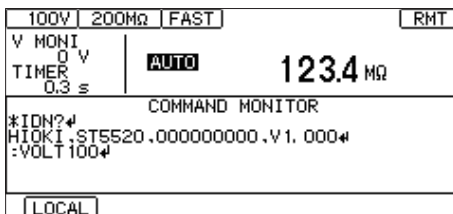

## Messages displayed in the communications monitor and their meanings

If an error occurs during command execution, the following information is displayed.

- Command error (improper command, improper argument format, etc.)

> #CMD ERROR

- Argument out of range

> #PARAM ERROR

- Execution error

> #EXE ERROR

The approximate location of the error is also displayed.

Argument error (1E-3 is out of range)

> :TIMer 1E-3

> #^ PARAM ERROR

- Spelling error (:SPED FAST instead of :SPEED FAST)

> :SPED FAST

> #^ CMD ERROR

### IMPORTANT

- If an illegal code is received, the character code is displayed in hexadecimal notation enclosed in "<>".  
For example, the character 0xFF is displayed as <FF>, and 0x00 as <00>.  
If only hexadecimal characters like this are displayed, check the communications conditions or lower the communications speed.

- If an RS-232C error occurs, the following information is displayed.

Overrun error (signal lost) .....#Overrun Error

Break signal received.....#Break Error

Parity error .....#Parity Error

Framing error .....#Framing Error

When these messages are displayed, check the communications conditions or lower the communications speed.

- When a series of consecutive commands are sent, the error position may shift.

## Command Format

### (1) Command Format

The ST5520 commands have the following structure.

Command (+Parameter) + Delimiter

The command and the parameter are separated by “ ” ( one character space )  
If there is no parameter, send the delimiter after the command.

The command may consist of both upper and lower case letters. Make sure to use one character space as the separator between the command and the parameter.

1. When the command contains a parameter

**:VOLTage 100** (+delimiter)

the command format consists of the command **:VOLTage**

followed by the separator “ ” ( one character space ). Then follows the parameter 100 . Following the parameter comes the delimiter

2. When the command contains no parameter

**:STOP** (+delimiter)

the command format consists of the command **:STOP** immediately followed by the delimiter.

The meaning of the delimiter is to separate commands and data. When the ST5520 receives the delimiter, it starts analysis of the command.

A command can abbreviated. The whole command form is referred to as the “long form” and the abbreviated form as the “short form.”

Although the short form is printed in upper case letters and the rest in lower case letters in this instruction manual, sending command (including parameter and delimiter) from personal computer in either upper or lower case letters is valid.

All responses returned from the ST5520 are in upper case letters.

<b>VOLTage</b>	OK (the long form)
<b>VOLT</b>	OK (the short form)
<b>VOLTA, VOL</b>	error

### (2) Command/Parameter/Delimiter

There are three types of command.

1. A command consisting of a single word beginning with a letter.

Examples **:VOLTage** etc.

2. A command consisting of a sequence of words separated by colons.

Examples **:BEEPPer:KEY** , **:MOHM:RANGe** etc.

3. A command beginning with an asterisk (\*) to indicate that is a particular command.

Examples **\*RST** etc.

## Command ON/OFF

Some response commands are set with command setting ON/OFF.

Use HEADER command to designate setting.

The below is an example of the response command ON and command OFF.

Example: Response when test voltage is set at 1000 V.

Query: **:VOLTage?** (Command querying current test voltage)

Response: (Test voltage is 1000 V)

When command is set to ON (command + parameter)

**:VOLTAGE 1000**

When command is set to OFF (only parameter)

**1000**

## Parameter

Character data and decimal data are used as the ST5520 parameter (data) and the command determines the type of data.

The ST5520 uses character string data and numeric data, and the type use varies according to the command in question.

### 1. Character data

Character string data must always begin with an alphabetic character, and the characters following can be either alphabetic characters or numerals. Although in character data either upper case letters or lower case letters are accepted, response message output by the 3154 are always in upper case letters.

Example: 200M

### 2. Decimal data

The numeric data values are all represented in decimal, in three formats identified as NR1, NR2 and NR3, and each of these can appear as either a signed number or an unsigned number. Unsigned numbers are taken as positive.

NR1 format: Integer data

Example: +12, -23, 34

NR2 format: Fixed point number

Example: +1.23, -23.45, 3.456

NR3 format: Floating point number

Example: +1E-2, -2.3E+4

The term NRf format includes all these three formats.

Each 3154 command designates a format.

Delimiter

Depending on transmission direction, the delimiter is as follows.

From computer to 3154: CR or CR + LF

From 3154 to computer: CR + LF

## Separators

### (1) Command unit separator

Multiple commands can be written in a line by connecting them with a semicolon (;)

Example: `:VOLTage 1000;:MOHM:RANGe AUTO;*IDN?`

When commands do not have a semicolon (;) between them or a statement has an error, the rest of the messages to the command terminator will not be executed.

Sending a query followed by a semicolon (;) and a command causes a query error.

### (2) Separator between command and parameter

Use space " " in command with both command and parameter to separate command and parameter.

Example: `:VOLTage 1000`

### (3) Parameter separator

Command with multiple parameters must be separated with comma , between parameters.

Example: `:COMParator 25,123.4E+06,FAILstop`

## 8.5 Data Format Table

### Measured value

2 MΩ range	0.000E+06 to 4.000E+06	4 digits + decimal point
20 MΩ range	1.90E+06 to 9.99E+06	3 digits + decimal point
	10.00E+06 to 40.00E+06	4 digits + decimal point
200 MΩ range	19.0E+06 to 99.9E+06	3 digits + decimal point
	100.0E+06 to 400.0E+06	4 digits + decimal point
2000 MΩ range	190E+06 to 999E+06	3 digits
	1000E+06 to 4000E+06	4 digits
4000 MΩ range	190E+06 to 999E+06	3 digits
	1000E+06 to 9990E+06	4 digits
Over Flow	9999E+06	4 digits
Under Flow	0000E+06	4 digits
Error <sup>*1</sup>	0000E+10	4 digits

\*1 When a contact check error, short circuit check error, or output voltage error occurs; otherwise no data are found.

### Comparator upper/lower limit values

Common to all the range	0.000E+06 to 9.999E+06	4 digits + decimal point
	10.00E+06 to 99.99E+06	4 digits + decimal point
	100.0E+06 to 999.9E+06	4 digits + decimal point
	1000E+06 to 9990E+06	4 digits

### Test duration timer

0.045 s to 999.999 s (resolution 0.001 s)
---

### Response time timer

0.005 s to 999.999 s (resolution 0.001 s)
---

## 8.6 Command Reference

### Command reference description

Syntax :**MOHM:RANGe** <data>

#### Reference

Specifies the syntax for the command.

<>:

Specifies the description of the message data (text or numerical parameter). A response is returned in capital letters for a text parameter.

Numerical parameter:

NRf: Format including NR1, NR2, and NR3.

NR1: Integer data (example: +12, -23, 34)

NR2: Decimal data (example: +1.23, -23.45, 3.456)

NR3: Floating decimal point index data (example: +1.0E-2, -2.3E+4)

<data> 2 M / 20 M / 200 M / 2000 M / 4000 M / AUTO (text data)

#### Reference

Explains parameter data.

Example

Set to 200 M $\Omega$  range.

PC> :**MOHM:RANGe** 200M

#### Reference

Example of the use of the command

PC> indicates a command from the computer.

ST5520> indicates a response from the ST5520.

Error

An execution error occurs if the 2000 M $\Omega$  range is executed when the test voltage is between 25 V and 99 V.

#### Reference

Explains the error.

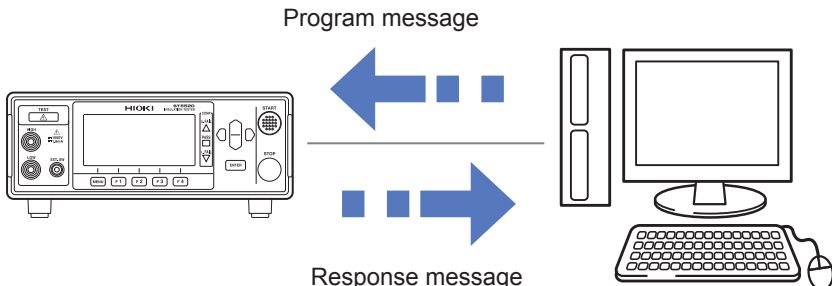

**Command list**

Classification	Command	Function	
Specialized command	<b>*CLS</b>	Clears event register	p. 130
	<b>*ESR?</b>	Queries event status register	p. 130
	<b>*IDN?</b>	Queries equipment ID	p. 131
	<b>*RST</b>	Resets equipment	p. 131
Testing status	<b>:START</b>	Starts a test	p. 131
	<b>:STOP</b>	Ends a test	p. 131
	<b>:STATe?</b>	Queries testing status	p. 132
Measurement result	<b>:MEASure?</b>	Queries measured value	p. 132
	<b>:MEASure:COMParator?</b>	Queries judgment result	p. 133
	<b>:MEASure:RESult?</b>	Queries measured value and judgment result	p. 133
	<b>:MEASure:CLEar</b>	Clears measured value and judgment result	p. 134
Measurement monitor	<b>:MEASure:MONitor?</b>	Queries the voltage monitor value	p. 134
Voltage setting	<b>:VOLTage</b>	Sets test voltage	p. 134
	<b>:VOLTage?</b>	Queries test voltage	p. 134
Resistance range	<b>:MOHM:RANGe</b>	Sets resistance range	p. 135
	<b>:MOHM:RANGe?</b>	Queries resistance range	p. 135
	<b>:MOHM:AUTO:DCLEar</b>	Sets whether to clear measured values during auto-range operation	p. 135
	<b>:MOHM:AUTO:DCLEar?</b>	Queries the status of the measured value clear function during auto-range operation	p. 136
Measurement speed	<b>:SPEed</b>	Sets measurement speed	p. 136
	<b>:SPEed?</b>	Queries measurement speed	p. 136
Timer	<b>:TIMer</b>	Sets test duration	p. 137
	<b>:TIMer?</b>	Queries test duration	p. 137
	<b>:DELay</b>	Sets response time	p. 137
	<b>:DELay?</b>	Queries response time	p. 138
Comparator	<b>:COMParator:LIMit</b>	Sets comparator upper/lower limit value	p. 138
	<b>:COMParator:LIMit?</b>	Queries comparator upper/lower limit value	p. 138
	<b>:COMParator:MODE</b>	Sets comparator test mode	p. 139
	<b>:COMParator:MODE?</b>	Queries comparator test mode	p. 139
	<b>:COMParator:BEEPer</b>	Sets judgment beep sound	p. 139
	<b>:COMParator:BEEPer?</b>	Queries judgment beep sound	p. 139



Classification	Command	Function	
Contact check	<b>:CONtactcheck</b>	Sets contact check function	p. 140
	<b>:CONtactcheck?</b>	Queries contact check function	p. 140
	<b>:CONtactcheck:RESult?</b>	Queries the contact check result	p. 140
Short circuit check	<b>:SHORtcheck</b>	Sets short circuit check function	p. 141
	<b>:SHORtcheck?</b>	Queries short circuit check function	p. 141
	<b>:SHORtcheck:TIME</b>	Sets the short circuit check time	p. 141
	<b>:SHORtcheck:TIME?</b>	Queries the short circuit check time	p. 142
	<b>:SHORtcheck:TIME :MONItor?</b>	Queries the short circuit check execution time	p. 142
	<b>:SHORtcheck:RESult?</b>	Queries the short circuit check result	p. 142
Key beep sound	<b>:KEY:BEEPer</b>	Sets key beep sound	p. 143
	<b>:KEY:BEEPer?</b>	Queries key beep sound	p. 143
Double action	<b>:DOUBleaction</b>	Sets double action	p. 143
	<b>:DOUBleaction?</b>	Queries double action	p. 143
LCD	<b>:DISPlay:CONTrast</b>	Sets LCD contrast	p. 144
	<b>:DISPlay:CONTrast?</b>	Queries LCD contrast	p. 144
	<b>:DISPlay:BACKlight</b>	Sets LCD backlight	p. 144
	<b>:DISPlay:BACKlight?</b>	Queries LCD backlight	p. 144
Power frequency	<b>:SYSTem:LFRequency</b>	Sets power frequency	p. 145
	<b>:SYSTem:LFRequency?</b>	Queries power frequency	p. 145
Save/Load	<b>:PANel:LOAD</b>	Loads test conditions	p. 145
	<b>:PANel:SAVE</b>	Saves test conditions	p. 145
	<b>:PANel:SAVE?</b>	Queries if conditions saved with designated number are to be saved	p. 146
	<b>:PANel:NAME</b>	Sets panel name	p. 146
	<b>:PANel:NAME?</b>	Queries panel name	p. 146
	<b>:PANel:CLEAr</b>	Deletes panel	p. 147
Analog output	<b>:AOUt:RANGe</b>	Sets analog output	p. 147
	<b>:AOUt:RANGe?</b>	Queries analog output	p. 147
Switched probe operation	<b>:PROBe</b>	Sets switched probe operation mode	p. 147
	<b>:PROBe?</b>	Queries switched probe operation mode	p. 148
TEST signal OFF timing	<b>:IO:SIGNal</b>	Sets TEST signal timing	p. 148
	<b>:IO:SIGNal?</b>	Queries TEST signal timing	p. 148

Classification	Command	Function	
Interlock	:IO:ILOCK	Sets interlock status	p. 149
	:IO:ILOCK?	Queries interlock status	p. 149
Key lock	:SYSTEM:KLOCK	Sets key lock status	p. 149
	:SYSTEM:KLOCK?	Queries key lock status	p. 150
Command header ON/OFF function	:HEADER	Sets response command header ON/OFF	p. 150
	:HEADER?	Queries response command header ON/OFF	p. 150
Communications	:SYSTEM:LOCAL	Resets remote state	p. 151

Lower-case characters in the commands are technically optional. The commands are case-insensitive.

**\*CLS**

Clears event status register (ESR).

Syntax      **\*CLS**

**\*ESR?**

Returns the value of the event status register (ESR) as a decimal notation numerical value in NR1 format 0 to 7 (<data>) and then clears the event status register status. No command header is included in response. The register is configured as shown in the table below. When an error occurs, it returns data as a numerical value calculated in decimal notation based on each error.

Syntax      **\*ESR?**

Response    <data>0 to 7 (NR1 numerical data)

Example     When all of bit0 (Command error), bit1 (Execution error), bit2 (Query error) are set as 1.  
 PC>\*ESR?  
 ST5520>7

**Event status register**

Decimal notation	–	–	–	–	–	4	2	1
Bit	bit7	bit6	bit5	bit4	bit3	bit2	bit1	bit0
Status	Unused	Unused	Unused	Unused	Unused	QYE	EXE	CME

QYE: Query error, EXE: Execution error, CME: Command error

**\*IDN?**

Queries manufacturer's name, model name, and software version. No header command is included in response.

First field: Manufacturer's name

Second field: Model name

Third field: Serial number

Fourth field: Software version

Syntax        **\*IDN?**

Response     **<data>**

Example      PC> **\*IDN?**  
ST5520>**HIOKI , ST5520 , 000012345 , v1 . 00**

**\*RST**

Resets the instrument setting. When this command is executed during a test, the test is stopped and the setting is reset. The saved test conditions are also cleared. The interface setting is not initialized.

To reset the setting, refer to "5.10 Default Setting List" (p.73).

Syntax        **\*RST**

Example      To execute resetting  
PC> **\*RST**

**:START**

Starts a test.

Syntax        **:START**

Example      PC> **:START**

Error         When this command is executed during tests, an execution error occurs.  
When this command is executed while the interlock function is activated, an execution error occurs.

**:STOP**

Ends a test.

Syntax        **:STOP**

Example      PC> **:STOP**

**:STATe?**

Returns the instrument status in numerical data (<data>). No command header is included in response.

Syntax	:STATe?
Response	<data>
<data>	0 to 2 (NR1 numerical data) 0: Stopped, 1: Testing, 2: Discharging
Example	To query the status (during tests) PC>:STATe? ST5520>1

**:MEASure?**

Queries the measured value. When this command is received during a test, the measured value is returned in NR3 numerical data (<data>).

After the test is completed, the measured value when the previous test was completed is returned. No command header is included in response.

Syntax	:MEASure?
Response	<data>
<data>	Measured value "8.5 Data Format Table" (p. 126)
Example	To query the measured value (when the measured value is 123.4 MΩ) PC>:MEASure? ST5520>123.4E+06

**:MEASure:COMParator?**

Queries judgment result.

When this command is received during tests, the judgment result is returned in text data (<data>).

When the comparator function is OFF, OFF is always returned as a judgment result.

When no judgment is made, NOCOMP is returned. When the response time timer is ON, DELAY is returned.

After the test is completed, the judgment result when the previous test was completed is returned.

No command header is included in response.

Syntax **:MEASure:COMParator?**

Response **<data>**

<data>	Judgment result	OFF /NOCOMP /DELAY /PASS /UFAIL /LFAIL / ULFAIL (text data) OFF: The judgment function is OFF. NOCOMP: No judgment is made. DELAY: The response time timer is ON. PASS: Within judgment standard UFAIL: Upper limit value $\leq$ Measured value LFAIL: Lower limit value $\geq$ Measured value ULFAIL: Judgment is not possible (the upper or lower limit value exceeds the range)
--------	-----------------	---

Example To query the judgment result (when the judgment result is PASS)  
PC> **:MEASure:COMParator?**  
ST5520> **PASS**

**:MEASure:RESult?**

Queries measured value and judgment result.

During a test the measured value and then the judgment result at the time this command is received are returned as <measured value> and then <judgment result> in data (<data1>, <data2>).

After the test is completed, the measured value and judgment result when the previous test was completed are returned.

No command header is included in response.

Syntax **:MEASure:RESult?**

Response **<data1>, <data2>**

<data1> Measured value "8.5 Data Format Table" (p. 126)

<data2> Judgment result: OFF /NOCOMP /DELAY /PASS /UFAIL /LFAIL /  
ULFAIL (text data)

Example To query the measured value and judgment result (when the measured  
value is 123.4 M $\Omega$  and the judgment result is PASS)  
PC> **:MEASure:RESult?**  
ST5520> **123.4E+06, PASS**

### **:MEASure:CLEAr**

Clears measured value and judgment result.  
The status is changed so that no judgment has been made.

Syntax	<b>:MEASure:CLEAr</b>
Example	To clear the measured value and judgment result PC> <b>:MEASure:CLEAr</b>

### **:MEASure:MONItor?**

Queries the voltage monitor value. The voltage monitor value is returned in NR1 numerical data (<data>).  
No command header is included in response.

Syntax	<b>:MEASure:MONItor?</b>
Response	<b>:&lt;data&gt;</b>
<data>	Voltage monitor value (unit: V) 0 to 1000 (resolution 1V) (NR1)
Example	To query the voltage monitor value (when the voltage monitor value is 25 V) PC> <b>:MEASure:MONItor?</b> ST5520> <b>25</b>

### **:VOLTage**

Sets the test voltage.  
When the testing start command, **:START** is sent sequentially after the test voltage is changed, a time of up to 500 ms is added until the test starts.

Syntax	<b>:VOLTage &lt;data&gt;</b>
<data>	Test voltage 25 to 1000 (NR1 numerical data)
Example	To set the test voltage to 100 V PC> <b>:VOLTage 100</b>

### **:VOLTage?**

Queries the test voltage. The test voltage is returned in NR1 numerical data (<data>).

Syntax	<b>:VOLTage?</b>
Response	<b>:VOLTAGE &lt;data&gt;</b> or simply <b>&lt;data&gt;</b>
<data>	Test voltage 25 to 1000 (NR1 numerical data)
Example	To query the test voltage (when the test voltage is 100 V) PC> <b>:VOLTage?</b> ST5520> <b>:VOLTAGE 100</b> (when the <b>:HEADer</b> command is ON) ST5520> <b>100</b> (when the <b>:HEADer</b> command is OFF)

**:MOHM:RANGe**

Sets the resistance range.

Syntax	<b>:MOHM:RANGe &lt;data&gt;</b>
<data>	2 M / 20 M / 200 M / 2000 M / 4000 M / AUTO (text data)
Example	To set to 200 MΩ range PC> <b>:MOHM:RANGe 200M</b>
Error	An execution error occurs if the 2000 MΩ range is set when the test voltage is 25 V to 99 V.

**:MOHM:RANGe?**

Queries the resistance range. The resistance range is returned in text data (<data>).

Syntax	<b>:MOHM:RANGe?</b>
Response	<b>:MOHM:RANGe &lt;data&gt;</b> or simply <b>&lt;data&gt;</b>
<data>	2 M / 20 M / 200 M / 2000 M / 4000 M / AUTO (text data)
Example	To query the resistance range (when the resistance range is 200 MΩ) PC> <b>:MOHM:RANGe?</b> ST5520> <b>:MOHM:RANGe 200M</b>  ST5520> <b>200M</b> (when the <b>:HEADer</b> command is ON) (when the <b>:HEADer</b> command is OFF)

**:MOHM:AUTO:DClear**

Enables or disables functionality for clearing measured values and judgment results during auto-range operation.

A setting of ON may cause a **:MEASure?** query to return an error value (0000E+10) if a range change occurs during auto-range testing.

Use the OFF setting if you wish to hold the previous value without clearing the measured value and judgment result when the range changes.

However, while using the OFF setting, you will be unable to determine that a range change has occurred since the no-data error value will not be returned.

Consequently, caution is necessary when using the OFF setting. If the insulation resistance value fell, for example due to an insulation breakdown, immediately before the test end time, a **:MEASure?** query issued after the completion of a test that included a range change would return the result from before the insulation breakdown.

When the OFF setting is used, the **RANGE** display on the Settings screen will show **[AUTO (DATA CLEAR: OFF)]** (during auto-range operation)

Syntax	<b>:MOHM:AUTO:DClear &lt;data&gt;</b>
<data>	ON/OFF (text data) ON: Measured value clear function enabled OFF: Measured value clear function disabled.
Example	To enable the measured value clear function PC> <b>:MOHM:AUTO:DClear ON</b>

**:MOHM:AUTO:DClear?**

Queries whether functionality for clearing measured values and judgment results during auto-range operation is enabled or disabled. The setting is returned as text data (<data>).

Syntax	:MOHM:AUTO:DClear?
Response	:MOHM:AUTO:DClear <data> or simply <data>
<data>	ON/OFF (text data) ON: Measured value clear function enabled OFF: Measured value clear function disabled.
Example	To query the status of the measured value clear function (if the function is enabled) PC> :MOHM:AUTO:DClear? ST5520>:MOHM:AUTO:DCLEAR ON (when the :HEADer command is ON) ST5520>ON (when the :HEADer command is OFF)

**:SPEed**

Sets the measurement speed to FAST/SLOW.

Syntax	:SPEed <data>
<data>	FAST/SLOW (text data)
Example	To set the measurement speed to FAST PC> :SPEed FAST

**:SPEed?**

Queries the measurement speed. The measurement speed setting FAST/SLOW is returned in text data (<data>).

Syntax	:SPEed?
Response	SPEED <data> or simply <data>
<data>	FAST/SLOW (text data)
Example	To query the measurement speed (when the speed is set to FAST) PC> :SPEed? ST5520>:SPEED FAST (when the :HEADer command is ON) ST5520>FAST (when the :HEADer command is OFF)



**:TiMer**

Sets the test duration.

Set 0.0 when the test duration is not to be set. During a test, the test is stopped and the test duration is set.

Syntax	<b>:TiMer &lt;data&gt;</b>
<data>	Test duration (unit: second) 0.0 and 0.045 to 999.999 (resolution 0.001), (NR2 numerical data) "8.5 Data Format Table" (p.126)

Example To set the test duration to 10 seconds  
PC> **:TiMer 10**

**:TiMer?**

Queries the test duration setting.

The test duration is returned in NR2 numerical data (<data>). 0.0 is returned when the test duration timer is not to be used.

Syntax	<b>:TiMer?</b>
Response	<b>:TiMer &lt;data&gt;</b> or simply <b>&lt;data&gt;</b>
<data>	Test duration (unit: second) 0.0 and 0.045 to 999.999 (resolution 0.001), (NR2 numerical data) "8.5 Data Format Table" (p.126)

Example To query the test duration setting (when the test duration is 10 seconds)  
PC> **:TiMer?**  
ST5520> **:TiMer 10.000** (when the **:HEADer** command is ON)  
ST5520> **10.000** (when the **:HEADer** command is OFF)

**:DELaY**

Sets the response time. Set 0.0 when the response time is set to auto (AUTO).

If a test is being performed, it is stopped and the response time is set.

Syntax	<b>:DELaY &lt;data&gt;</b>
<data>	Response time (unit: second) 0.0 and 0.005 to 999.999 (resolution 0.001) (NR2 numerical data) "8.5 Data Format Table" (p.126)

Example To set the response time to 5.5 seconds  
PC> **:DELaY 5.5**

### **:DElay?**

Queries the response time setting. The response time is returned in NR2 numerical data (<data>). 0.0 is returned when the response time is set to auto (AUTO).

Syntax	<b>:DElay?</b>	
Response	<b>:DELAY</b> <data> or simply <data>	
<data>	Response time (unit: second) 0.0 and 0.005 to 999.999 (resolution 0.001) (NR2 numerical data) "8.5 Data Format Table" (p.126)	
Example	To query the response time (when the response time is 5.5 seconds) PC> <b>:DElay?</b> ST5520> <b>:DELAY 5.500</b> (when the <b>:HEADer</b> command is ON) ST5520> <b>5.500</b> (when the <b>:HEADer</b> command is OFF)	

### **:COMParator:LIMit**

Sets the comparator upper/lower limit values.

Set the upper/lower limit values in <data1>, <data2> (NR3 numerical data).

Set the values to make the upper limit value ≥ lower limit value.

When the upper limit value is less than the lower limit value, an execution error occurs.

Syntax	<b>:COMParator:LIMit</b> <data1>,<data2>	
<data1>	OFF (text data) or comparator upper limit value (NR3 numerical data)	
<data2>	OFF (text data) or comparator lower limit value (NR3 numerical data)	
Example	To set the upper limit value to 15 MΩ and the lower limit value to 10 MΩ PC> <b>:COMParator:LIMit 15E+06,10E+06</b>	

### **:COMParator:LIMit?**

Queries the comparator upper/lower limit values.

The upper/lower limit values are returned in <data1>, <data2> (NR3 numerical data).

Syntax	<b>:COMParator:LIMit?</b>	
Response	<b>:COMPARATOR:LIMIT</b> <data1>,<data2> or simply <data1>,<data2>	
<data1>	OFF (text data) or comparator upper limit value (NR3 numerical data)	
<data2>	OFF (text data) or comparator lower limit value (NR3 numerical data)	
Example	To query the upper/lower limit values (when the upper limit value is set to 15 MΩ and the lower limit to 10 MΩ) PC> <b>:COMParator:LIMit?</b> ST5520> <b>:COMPARATOR:LIMIT 15.00E+06,10.00E+06</b> (when the <b>:HEADer</b> command is ON) ST5520> <b>15.00E+06,10.00E+06</b> (when the <b>:HEADer</b> command is OFF)	

**:COMParator:MODE**

Sets the comparator test mode.

Syntax	<code>:COMParator:MODE &lt;data&gt;</code>
<data>	CONTINUE, PASSSTOP, FAILSTOP, SEQUENCE (text data)
Example	To set the test mode to FAIL STOP PC> <code>:COMParator:MODE FAILSTOP</code>

**:COMParator:MODE?**

Queries the comparator test mode.  
The test mode is returned in text data (<data>).

Syntax	<code>:COMParator:MODE?</code>
Response	<code>:COMPARATOR:MODE &lt;data&gt;</code> or simply <code>&lt;data&gt;</code>
<data>	CONTINUE/PASSSTOP/FAILSTOP/SEQUENCE (text data)
Example	To query the comparator test mode (when the test mode is FAIL STOP) PC> <code>:COMParator:MODE?</code> ST5520> <code>:COMPARATOR:MODE FAILSTOP</code>  ST5520> <code>FAILSTOP</code> (when the <code>:HEADer</code> command is ON) (when the <code>:HEADer</code> command is OFF)

**:COMParator:BEEPer**

Sets the beep sound at the time of comparator judgment and at the end of the timed duration.

Syntax	<code>:COMParator:BEEPer &lt;data&gt;</code>
<data>	PASS/FAIL/OFF/END (text data)
Example	To set to beep at FAIL judgment PC> <code>:COMParator:BEEPer FAIL</code>

**:COMParator:BEEPer?**

Queries the beep sound setting at the time of comparator judgment and at the end of the timed duration.  
The beep sound setting is returned in text data (<data>).

Syntax	<code>:COMParator:BEEPer?</code>
Response	<code>:COMPARATOR:BEEPER &lt;data&gt;</code> or simply <code>&lt;data&gt;</code>
<data>	PASS/FAIL/OFF/END (text data)
Example	To query the beep sound setting at the time of judgment (when the beeper sounds at FAIL judgment) PC> <code>:COMParator:BEEPer?</code> ST5520> <code>:COMPARATOR:BEEPER FAIL</code>  ST5520> <code>FAIL</code> (when the <code>:HEADer</code> command is ON) (when the <code>:HEADer</code> command is OFF)

### **:CONtactcheck**

Sets the contact check function ON/OFF.

Syntax	<b>:CONtactcheck &lt;data&gt;</b>
<data>	ON/OFF (text data) ON: The contact check function is enabled. OFF: The contact check function is disabled.
Example	To set the contact check function to ON PC> <b>:CONtactcheck ON</b>

### **:CONtactcheck?**

Queries the contact check function ON/OFF setting. The setting is returned in text data (<data>).

Syntax	<b>:CONtactcheck?</b>
Response	<b>:CONTACTCHECK &lt;data&gt;</b> or simply <b>&lt;data&gt;</b>
<data>	ON/OFF (text data) ON: The contact check function is enabled. OFF: The contact check function is disabled.
Example	To query the contact check function (when the contact check function is enabled) PC> <b>:CONtactcheck?</b> ST5520> <b>:CONTACTCHECK ON</b>  ST5520> <b>ON</b> (when the <b>:HEADer</b> command is ON) (when the <b>:HEADer</b> command is OFF)

### **:CONtactcheck:RESult?**

Queries the contact check result.  
No command header is included in the response.

Syntax	<b>:CONtactcheck:RESult?</b>
Response	<b>&lt;data&gt;</b>
<data>	NOCHK/PASS/HFAIL/LFAIL/HLFAIL (text data) NOCHK: Not checked yet PASS: No error HFAIL: Contact check error on the HIGH side LFAIL: Contact check error on the LOW side HLFAIL: Contact check error on both the HIGH and LOW sides
Example	To query the contact check result (when the result is fail on the HIGH side) PC> <b>:CONtactcheck:RESult?</b> ST5520> <b>:HFAIL</b>

**:SHORTcheck**

Sets the short circuit check function ON/OFF.

Syntax        : **:SHORTcheck** <data>

<data>        ON/OFF (text data)  
                   ON: The short circuit check function is enabled.  
                   OFF: The short circuit check function is disabled.

Example        To set the short circuit check function to ON  
 PC> **:SHORTcheck ON**

**:SHORTcheck?**

Queries the short circuit check function ON/OFF setting. The setting is returned in text data (<data>).

Syntax        : **:SHORTcheck?**

Response      : **:SHORTCHECK** <data> or simply <data>

<data>        ON/OFF (text data)  
                   ON: The short circuit check function is enabled.  
                   OFF: The short circuit check function is disabled.

Example        To query the short circuit check function (when the short circuit check  
 function is enabled)  
 PC> **:SHORTcheck?**  
 ST5520> **:SHORTCHECK ON** (when the **:HEADER** command is ON)  
 ST5520>**ON** (when the **:HEADER** command is OFF)

**:SHORTcheck:TIME**

Sets the short circuit check time.

Set 0.0 when the short circuit check time is set to auto (AUTO).

Syntax        : **:SHORTcheck:TIME** <data>

<data>        Short circuit check time (unit: second) 0.0 and 0.010 to 1.000 (resolution  
 0.001) (NR2 numerical data)

Example        To set the short circuit check time to 0.5 seconds  
 PC> **:SHORTcheck:TIME 0.5**



**:KEY:BEEPer**

Sets the key beep sound ON/OFF.

Syntax `:KEY:BEEPer <data>`

<data> ON/OFF (text data)

Example To set the key beeper to sound  
PC> `:KEY:BEEPer ON`

**:KEY:BEEPer?**

Queries the key beep sound ON/OFF setting. The beep sound ON/OFF setting is returned in text data (<data>).

Syntax `:KEY:BEEPer?`

Response `:KEY:BEEPER <data>` or simply `<data>`

<data> ON/OFF (text data)

Example To query the key beep sound ON/OFF setting (when the setting is ON)  
PC> `:KEY:BEEPer?`  
ST5520> `:KEY:BEEPER ON` (when the `:HEADer` command is ON)  
ST5520> `ON` (when the `:HEADer` command is OFF)

**:DOUBleaction**

Sets the double action function ON/OFF.

Syntax `:DOUBleaction <data>`

<data> ON/OFF (text data)  
ON: The double action function is enabled.  
OFF: The double action function is disabled.

Example To set the double action function to ON  
PC> `:DOUBleaction ON`

**:DOUBleaction?**

Queries the double action function ON/OFF setting. The setting is returned in text data (<data>).

Syntax `:DOUBleaction?`

Response `:DOUBleACTION <data>` or simply `<data>`

<data> ON/OFF (text data)  
ON: The double action function is enabled.  
OFF: The double action function is disabled.

Example To query the double action function setting (when the setting is ON)  
PC> `:DOUBleaction?`  
ST5520> `:DOUBleACTION ON`  
(when the `:HEADer` command is ON)  
ST5520> `ON` (when the `:HEADer` command is OFF)





**:SYSTem:LFRequency**

Sets the power frequency.

When AUTO is set, 50 Hz and 60 Hz are automatically identified.

Syntax	<b>:SYSTem:LFRequency &lt;data&gt;</b>
<data>	AUTO/50/60 (text data) AUTO: The power frequency is automatically identified. 50: Power frequency 50 Hz 60: Power frequency 60 Hz

Example To set the power frequency to 60 Hz  
 PC> **:SYSTem:LFRequency 60**

**:SYSTem:LFRequency?**

Queries the power frequency setting. The setting is returned in NR1 number data (<data>).

Syntax	<b>:SYSTem:LFRequency?</b>
Response	<b>:SYSTEM:LFREQUENCY &lt;data&gt;</b> or simply <b>&lt;data&gt;</b>
<data>	AUTO/50/60 (text data)

Example To query the power frequency setting (when the power frequency is 60 Hz)  
 PC> **:SYSTem:LFRequency?**  
 ST5520> **:SYSTEM:LFREQUENCY 60**  
 (when the **:HEADer** command is ON)  
 ST5520> **60** (when the **:HEADer** command is OFF)

**:PANel:LOAD**

Loads the test conditions with the specified number. During a test, the test is stopped and the test conditions are loaded.

Syntax	<b>:PANel:LOAD &lt;data&gt;</b>
<data>	Test condition number 1 to 10 (NR1 numerical data)

Example To load No. 3 test conditions  
 PC> **:PANel:LOAD 3**

**:PANel:SAVE**

Saves the test conditions with the specified number.

Syntax	<b>:PANel:SAVE &lt;data&gt;</b>
<data>	1 to 10 (NR1 numerical data)

Example To save as No. 3  
 PC> **:PANel:SAVE 3**

**:PANel:SAVE?**

Queries if the test conditions are saved with the specified number. Whether the test conditions are saved is returned in numerical data (<data2>). No command header is included in response.

Syntax	<b>:PANel:SAVE? &lt;data1&gt;</b>
<data1>	Test condition number 1 to 10 (NR1 numerical data)
Response	<data2>
<data2>	0 to 1 (NR1 numerical data) 1: The test conditions are saved. 0: The test conditions are not saved.
Example	To query if the test conditions are saved as No. 3 (when the test conditions are saved as No. 3) PC>: <b>PANel:SAVE? 3</b> ST5520>1

**:PANel:NAME**

Changes the saved test condition name. The test condition name is enclosed in "" (double quotation marks).

Syntax	<b>:PANel:NAME &lt;data1&gt;,&lt;data2&gt;</b>
<data1>	Test condition number 1 to 10 (NR1 numerical data)
<data2>	Test condition name (text data: up to ten half-width characters)
Example	To set the test condition name for Test condition 1 to "TEST1" PC>: <b>PANel:NAME 1,"TEST1"</b>

**:PANel:NAME?**

Queries the test condition name. The specified number is returned in NR1 number data (<data1>) and the test condition name is returned in text data (<data2>).

Syntax	<b>:PANel:NAME? &lt;data1&gt;</b>
Response	<b>:PANel:NAME &lt;data1&gt;,&lt;data2&gt;</b> or simply <b>&lt;data1&gt;,&lt;data2&gt;</b>
<data1>	Test condition number 1 to 10 (NR1 numerical data)
<data2>	Test condition name (text data: up to ten half-width characters)
Example	To query the test condition name for Test condition 1 (when the test condition name is "TEST1") PC>: <b>PANel:NAME? 1</b> ST5520>: <b>PANel:NAME 1,"TEST1"</b> (when the <b>:HEADer</b> command is ON) ST5520>1, "TEST1" (when the <b>:HEADer</b> command is OFF)

**:Panel:CLEar**

Deletes the test conditions.

Syntax	<b>:Panel:CLEar &lt;data1&gt;</b>
<data1>	Test condition number 1 to 10 (NR1 numerical data)
Example	To delete Test condition 1 PC> <b>:Panel:CLEar 1</b>

**:AOUT:RANGe**

Sets whether the analog output is to be output in all measurement resistance ranges or in each range display area.

Syntax	<b>:AOUT:RANGe &lt;data&gt;</b>
<data>	FULL/EACH (text data) FULL: Output in all measurement resistance ranges EACH: Output in each range display area
Example	To set to output in all measurement resistance ranges PC> <b>AOUT:RANGe FULL</b>

**:AOUT:RANGe?**

Queries the analog output setting.

The FULL or EACH setting is returned in text data (<data>).

Syntax	<b>:AOUT:RANGe?</b>
Response	<b>:AOUT:RANGe &lt;data&gt;</b> or simply <b>&lt;data&gt;</b>
<data>	FULL/EACH (text data) FULL: Output in all measurement resistance ranges EACH: Output in each range display area
Example	To query the output method (when the setting is FULL) PC> <b>:AOUT:RANGe?</b> ST5520> <b>:AOUT:RANGe FULL</b>  ST5520> <b>FULL</b> (when the <b>:HEADer</b> command is ON) (when the <b>:HEADer</b> command is OFF)

**:PROBe**

Sets the 9299 Switched Probe operation mode.

During a test, the test is stopped and the operation mode is set.

Syntax	<b>:PROBe &lt;data&gt;</b>
<data>	CONTInue/TRIGGer (text data) CONTInue: Continuous mode TRIGGer: Trigger mode
Example	To set continuous mode PC> <b>: PROBe CONTInue</b>

**:PROBe?**

Queries the 9299 Switched Probe operation mode setting. The continuous or trigger setting is returned in text data (<data>).

Syntax	:PROBe?
Response	:PROBE <data> or simply <data>
<data>	CONTINUE/TRIGGER (text data) CONTINUE: Continuous mode TRIGGER: Trigger mode
Example	To query the operation mode (when the operation mode setting is CONTINUE) PC> :PROBe? ST5520>:PROBE CONTINUE (when the :HEADer command is ON) ST5520>CONTINUE (when the :HEADer command is OFF)

**:IO:SIGNal**

Sets the timing for the TEST signal to return from LOW to HIGH when a test is completed.

Syntax	:IO:SIGNal <data>
<data>	SLOW/FAST (text data)
Example	To set the timing to FAST PC> :IO:SIGNal FAST

**:IO:SIGNal?**

Queries the timing for the TEST signal to return from LOW to HIGH when a test is completed. The SLOW or FAST setting is returned in text data (<data>).

Syntax	:IO:SIGNal?
Response	:IO:SIGNal <data> or simply <data>
<data>	SLOW/FAST (text data)
Example	To query the timing (when the setting is FAST) PC> :IO:SIGNal? ST5520>:IO:SIGNal FAST (when the :HEADer command is ON) ST5520>FAST (when the :HEADer command is OFF)

**:IO:ILOCK**

Sets the interlock function.

Syntax	<b>IO:ILOCK &lt;data&gt;</b>
<data>	ON/OFF (text data) ON: The interlock function is enabled. OFF: The interlock function is disabled.

Example To set the interlock function to ON  
PC>**IO:ILOCK ON**

**:IO:ILOCK?**

Queries the interlock function setting. The ON or OFF setting is returned in text data (<data>).

Syntax	<b>IO:ILOCK?</b>
Response	<b>IO:ILOCK &lt;data&gt;</b> or simply <b>&lt;data&gt;</b>
<data>	ON/OFF (text data) ON: The interlock function is enabled. OFF: The interlock function is disabled.

Example To query the interlock function setting (when the setting is ON)  
PC>**IO:ILOCK?**  
ST5520>**IO:ILOCK ON** (when the **:HEADer** command is ON)  
ST5520>**ON** (when the **:HEADer** command is OFF)

**:SYSTEM:KLOCK**

Sets the key lock.

Syntax	<b>:SYSTEM:KLOCK &lt;data&gt;</b>
<data>	ON/OFF (text data) ON: The key lock is set. OFF: The key lock is cancelled.

Example To set the key lock  
PC> **:SYSTEM:KLOCK ON**

### **:SYSTem:KLOCK?**

Queries the key lock setting. The ON or OFF setting is returned in text data (<data>).

Syntax	<b>:SYSTem:KLOCK?</b>
Response	<b>:SYSTEM:KLOCK</b> <data> or simply <data>
<data>	ON/OFF (text data) ON: The key lock is set. OFF: The key lock is cancelled.
Example	To query the key lock (when the setting is ON) PC> <b>:SYSTem:KLOCK?</b> ST5520> <b>:SYSTEM:KLOCK ON</b>  ST5520> <b>ON</b> (when the <b>:HEADer</b> command is ON) (when the <b>:HEADer</b> command is OFF)

### **:HEADer**

Sets whether the command the instrument received is added to the reply data or not. When the power is turned on, the setting is reset to OFF.

Syntax	<b>:HEADer</b> <data>
<data>	ON/OFF (text data) ON: With a command header OFF: Without a command header
Example	To set to ON PC> <b>:HEADer ON</b>

### **:HEADer?**

Queries the setting of whether the command the instrument received is added to the head of the reply data or not. The ON/OFF setting is returned in text data (<data>).

Syntax	<b>:HEADer?</b>
Response	<b>:HEADER</b> <data> or simply <data>
<data>	ON/OFF (text data) ON: With a command header OFF: Without a command header
Example	To query whether the command header is added or not (when the setting is ON) PC> <b>:HEADer?</b> ST5520> <b>:HEADER ON</b> (when the <b>:HEADer</b> command is ON) ST5520> <b>OFF</b> (when the <b>:HEADer</b> command is OFF)

**:SYSTem:LOCa1**

Changes the communications remote state back to the local state. The key operation is enabled.

Syntax	<code>:SYSTem:LOCa1</code>
--------	----------------------------

Example	To cancel the remote state PC> <code>:SYSTem:LOCa1</code>
---------	--





## 9

## Specifications

## Environment and safety

<b>Operating environment</b>	Indoors, pollution degree 2, altitude up to 2,000 m (6,562-ft.)		
<b>Storage temperature and humidity</b>	-10°C to 50°C (-14°F to 122°F), 80% RH or less (no condensation)		
<b>Operating temperature and humidity</b>	0°C to 40°C (32°F to 104°F), 80% RH or less (no condensation)		
<b>Dielectric strength</b>	1.62 kV AC (sensed current 10 mA) for 1 minute Between all power terminals and protective ground		
<b>Applicable standards</b>	Safety	EN61010	
	EMC	EN61326	Class A
<b>Power supply</b>	Rated supply voltage	100 V to 240 V AC (Voltage fluctuations of $\pm 10\%$ from the rated supply voltage are taken into account.)	
	Rated supply frequency	50/60 Hz	
	Anticipated transient overvoltage	2500 V	
<b>Maximum rated power</b>	25 VA		
<b>Continuous operating time</b>	1 hour (Continuous short circuit state)		
<b>Dimensions</b>	Approx. 215W × 80H × 166D mm (8.46"W × 3.15"H × 6.54"D) Excluding protrusion		
<b>Mass</b>	Approx. 1.1 kg (6.8 oz.)		
<b>Product warranty period</b>	3 years		

## Output (output accuracy)

<b>Output voltage</b>	25 V to 1000 V (arbitrary) Display The set voltage is displayed at the top of the instrument screen.		
<b>Output voltage accuracy</b>	1% of set voltage $\pm 2$ V		
<b>Voltage resolution</b>	1 V		
<b>Voltage monitoring accuracy</b>	2% of output voltage $\pm 1$ V (Less than 1.8 mA at a constant voltage)		
<b>Charge (measurement) current</b>	1.8 mA		
<b>Short circuit current</b>	Less than 2.0 mA		

**Analog output**

Not isolated against the power supply protective ground terminal and isolated against the measurement terminals.

Output voltage: Switching between FULL and EACH

1. FULL 0 to 4 V is output in all measured resistance ranges.

Measurement voltage	Resistance value range	Output voltage (DC)
$25\text{ V} \leq V < 100\text{ V}$	0.000 M $\Omega$ to 400.0 M $\Omega$	0 V to 4 V
$100\text{ V} \leq V < 500\text{ V}$	0.000 M $\Omega$ to 4000 M $\Omega$	0 V to 4 V
$500\text{ V} \leq V \leq 1000\text{ V}$	0.000 M $\Omega$ to 4000 M $\Omega$	0 V to 4 V
All measurement voltages	Over. F	4 V
	Under. F	0 V

2. EACH 0 to 4 V is output according to each resistance range.

Resistance range	Resistance value range	Output voltage (DC)
2 M $\Omega$	0.000 M $\Omega$ to 4.000 M $\Omega$	0 V to 4 V
20 M $\Omega$	0.00 M $\Omega$ to 40.00 M $\Omega$	0 V to 4 V
200 M $\Omega$	0.0 M $\Omega$ to 400.0 M $\Omega$	0 V to 4 V
2000 M $\Omega$ ( $100\text{ V} \leq V < 500\text{ V}$ )	0 M $\Omega$ to 4000 M $\Omega$	0 V to 4 V
4000 M $\Omega$ ( $500\text{ V} \leq V \leq 1000\text{ V}$ )	0 M $\Omega$ to 4000 M $\Omega$	0 V to 4 V
All resistance ranges	Over. F	4 V
	Under. F	0 V

**Analog output accuracy**

$\pm 2\%$  f.s.

**Load resistance**

1 M $\Omega$  or more

# Resistance measurement

**Resistance range composition** Manual range (2 MΩ, 20 MΩ, 200 MΩ, 2000 MΩ, 4000 MΩ), Auto range

**Range display** The set range is displayed at the top of the screen.

Rated measurement voltage	Display range	Resistance range	Resolution
25 V ≤ V < 100 V	0.002 MΩ to 4.000 MΩ	2 MΩ	0.001 MΩ
	1.90 MΩ to 40.00 MΩ	20 MΩ	0.01 MΩ
	19.0 MΩ to 999.9 MΩ	200 MΩ	0.1 MΩ
100 V ≤ V < 500 V	0.002 MΩ to 4.000 MΩ	2 MΩ	0.001 MΩ
	1.90 MΩ to 40.00 MΩ	20 MΩ	0.01 MΩ
	19.0 MΩ to 400.0 MΩ	200 MΩ	0.1 MΩ
	190 MΩ to 9990 MΩ	2000 MΩ	1 MΩ
500 V ≤ V ≤ 1000 V	0.002 MΩ to 4.000 MΩ	2 MΩ	0.001 MΩ
	1.90 MΩ to 40.00 MΩ	20 MΩ	0.01 MΩ
	19.0 MΩ to 400.0 MΩ	200 MΩ	0.1 MΩ
	190 MΩ to 9990 MΩ	4000 MΩ	1 MΩ

- To display a value of 1000 MΩ or over, the last digit is fixed at 0 and the resolution is 10 MΩ.
- When the measured value exceeds the display range, “Over.F” or “Under.F” is displayed.
- Measured resistance values include an input resistance of 2 kΩ.

**Resistance measurement accuracy**

**Commonly Applicable to FAST and SLOW**

Rated measurement voltage	Guaranteed accuracy range	Resistance range	Basic accuracy
25 V ≤ V < 100 V	0.002 MΩ to 2.000 MΩ	2 MΩ	±2% rdg. ±5 dgt.
	1.90 MΩ to 20.00 MΩ	20 MΩ	
	19.0 MΩ to 200.0 MΩ	200 MΩ	±5% rdg.
	200.1 MΩ to 999.9 MΩ		±25% rdg.
100 V ≤ V < 500 V	0.002 MΩ to 2.000 MΩ	2 MΩ	±2% rdg. ±5 dgt.
	1.90 MΩ to 20.00 MΩ	20 MΩ	
	19.0 MΩ to 200.0 MΩ	200 MΩ	±5% rdg.
	190 MΩ to 2000 MΩ	2000 MΩ	±5% rdg.
	2010 MΩ to 9990 MΩ		±25% rdg.
500 V ≤ V ≤ 1000 V	0.002 MΩ to 2.000 MΩ	2 MΩ	±2% rdg. ±5 dgt.
	1.90 MΩ to 20.00 MΩ	20 MΩ	
	19.0 MΩ to 200.0 MΩ	200 MΩ	
	190 MΩ to 4000 MΩ	4000 MΩ	±5% rdg.
	4010 MΩ to 9990 MΩ		±25% rdg.

(The temperature coefficient is based on “Guaranteed accuracy” (p. 157).)

**Input**

**Over voltage input protection** 1100 V DC (positive polarity only)

## Guaranteed accuracy

<b>Conditions of guaranteed accuracy</b>	Warming-up time 15 minutes or more	
<b>Temperature and humidity for guaranteed accuracy</b>	23°C ± 5°C (73°F ± 9°F), 80% RH or less, no condensation	
<b>Temperature coefficient</b>	Add 0.1 × Basic accuracy × (T-23)	T: Operating temperature (°C)
<b>Accuracy warranty period</b>	1 year	

## Test duration

<b>Definition of test duration</b>	Test duration = Response time + Measurement time	
<b>Setting range</b>		
<b>Setting range</b>	0.045 s (45 ms) to 999.999 s	
<b>Test duration</b>	ON/OFF (- -)	
<b>Display</b>	000.000 s setting Screen display: 000.0 s, 0.000 s if less than 100 ms "000.0 s" is displayed when OFF is set, "HOLD" is displayed at the end of a test.	
<b>Operation</b>	The test duration counts down from the specified time after a test starts. When OFF is set, the test duration counts up after a test starts. "999.9 s" is displayed when the test duration exceeds the display range.	
<b>Guaranteed accuracy range</b>	0.050 s (50 ms) to 999.999 s	
<b>Set resolution</b>	1 ms	

**Test duration accuracy**

- ±0.005 s (setting range 0.045 s to 0.099 s)
- ±0.05 s (setting range 0.100 s to 9.999 s)
- ±0.5 s (setting range 10.000 s to 999.999 s)

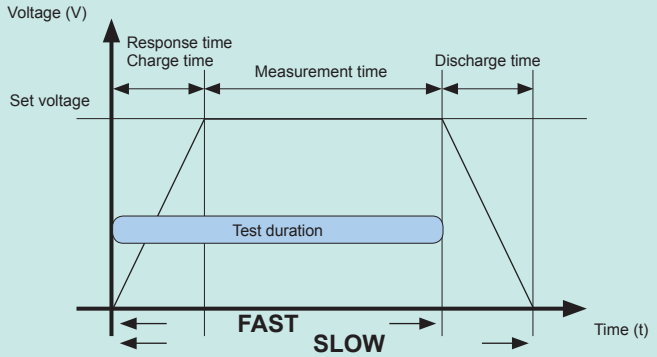

Time diagram  
(FAST, SLOW: TEST signal OFF timing setting)

## Response time

<b>Definition of response time</b>	No-judgment time
<b>Response time function</b>	
<b>Setting range</b>	AUTO, 0.005 s (5 ms) to 999.999 s
<b>Operation</b>	Comparator judgment is not performed after measurement starts until the response time elapses. The timer counts down along with the test duration timer (Test voltage is generated).
<b>Resolution</b>	1 ms

## Functions

<b>Voltage monitoring</b>	
<b>Update speed</b>	Displays a voltage value the instrument is outputting.
<b>Contact check</b>	
<b>Method</b>	4-terminal (For 2-terminal, the comparator upper and lower limit values are used.)
<b>Operation</b>	Contact check is performed for each sampling and a contact error occurs if a faulty contact is detected. (Obtained by using RS command or EXT.I/O)
<b>Sampling</b>	Sampling varies depending on the measurement speed setting. FAST: 100 ms, SLOW: 500 ms
<b>Comparator</b>	
<b>Display</b>	The upper and lower limit values are always displayed.
<b>Judgment</b>	UPPER_FAIL, PASS, LOWER_FAIL, UL_FAIL UPPER_FAIL Measured value $\geq$ Upper limit value PASS Upper limit value $>$ Measured value $>$ Lower limit value LOWER_FAIL Measured value $\leq$ Lower limit value UL_FAIL When no judgment can be made.
<b>Beep sound</b>	ON/OFF (based on the judgment beep sound setting)
<b>Display</b>	The LEDs for PASS, UPPER_FAIL, LOWER_FAIL are lit. Both UPPER_FAIL and LOWER_FAIL are lit at the same time for UL_FAIL. “----” is displayed when the comparator is set to OFF.
<b>Judgment output</b>	Based on the test mode. Both UPPER_FAIL and LOWER_FAIL are output at the same time for UL_FAIL. The last test result is held.

<b>Operation</b>	<p>No judgment is performed for forced termination (<b>STOP</b> key, STOP signal).</p> <p>However, a judgement result is output when forced termination judgment mode is set.</p> <p>(No judgment is performed if the STOP key is pressed before one measurement, with an elapsed time of less than 45 ms, is not completed.)</p> <p>No LED display or EXT.I/O signal output.</p>
<b>Memory function</b>	
<b>Items to be saved</b>	Rated measurement voltage, comparator upper and lower limit values (including comparator ON/OFF), test mode, judgment beep sound, test duration, response time (no-judgment time), resistance range (ON/OFF of auto range, including resistance range for fixed range), and measurement speed
<b>Number of memory data units</b>	Maximum of 10 patterns (can be saved and loaded)
<b>Measurement speed</b>	
<b>FAST</b>	Sampling: 30 ms/time
<b>SLOW</b>	Sampling: 500 ms/time
<b>Data hold</b>	Automatically holds the measurement value display at the time of measurement completion, judgment result display, EXT.I/O judgment result output, and analog output.



<b>Test mode</b>	<p>Switch a mode selecting from continuous mode, PASS STOP mode, FAIL STOP mode, or forced termination judgment mode.</p> <ul style="list-style-type: none"> <li>• <b>Continuous mode</b> Measurement is performed for the specified test duration, judgment is performed for each measurement, the judgment result is output, and the output voltage is cut off. The displayed measured value and judgment result display are held as they are at the end of a test.</li> <li>• <b>PASS STOP mode</b> A test is completed when a PASS judgment is made and the output voltage is cut off. The displayed measured value and PASS display are held as they are at the end of the test.</li> <li>• <b>FAIL STOP mode</b> A test is completed when a FAIL judgment is made and the output voltage is cut off. The displayed measured value and FAIL display are held as they are at the end of the test.</li> <li>• <b>Forced termination judgment mode</b> The judgment result based on the upper and lower limit values is displayed after the setting time elapsed or at the time of STOP is input (key, RS command, or EXT.I/O). Judgment result is output on the display, via RS command, or via EXT.I/O. The displayed measured value and judgment result display are held as they are at the end of a test.</li> </ul>
------------------	--

<b>Double action</b>	
<b>Operation</b>	The <b>START</b> key is enabled only for 1 s after the <b>STOP</b> key is pressed.
<b>Key lock function</b>	
<b>Reset means</b>	Hold down the <b>[UNLOCK]</b> key (for 1 s) when the key lock function is enabled.
<b>Display</b>	<b>[LOCK]</b> is displayed at the top of the screen when the key lock function is enabled. (The START key and STOP key are enabled.)
<b>Interlock function</b>	
<b>Display</b>	<b>[LOCK]</b> is displayed at the top of the screen when the interlock function is enabled.
<b>Operation</b>	No key operations are enabled. No tests can be started via EXT.I/O or RS command.

<b>Discharge and remaining voltage warning</b>	Any charge remaining in equipment to be measured is automatically discharged inside of the instrument when the testing is completed. The TEST lamp blinks during discharge and turns off when the voltage between the measurement terminals falls under $10\text{ V} \pm 3\text{ V}$ .
	During a test: Blinking interval 250 ms During discharge: Blinking interval 500 ms
<b>Judgment beep sound</b>	
<b>Setting</b>	PASS (beeps when a PASS judgment is made), FAIL (beeps when a FAIL judgment is made), END (beeps at the end of a test), or OFF (no beep sound) can be selected.
<b>Key beep sound</b>	ON/OFF can be switched.
<b>System reset</b>	The system is initialized.
<b>Short circuit check</b>	Before a test, apply approx. 2 V to 4 V to equipment to be measured and check for short circuits. No short circuit: A test starts. Short circuit: No tests start. A short circuit error is output.
<b>Short circuit check time automatic measurement function</b>	This function can be performed only when the short circuit check setting is ON. • AUTO setting A test starts after the automatic short circuit check has been completed. The time required for the short circuit check is displayed on the screen. When it takes 0.5 s or more, the short circuit check will time out. • MANUAL setting The time to be taken for the short circuit check can be set freely. Setting range: 0.010 s to 1.000 s
<b>Communications monitor function</b>	RS commands and query responses are displayed on the screen.

## External interface

The EXT.I/O mode can be switched between NPN (current sink output) and PNP (current source output).

The switching is set by using the switch on the back of the instrument.

### (1) Input signal

- Common specifications

Photocoupler-isolated, no voltage contact input (current sink output and current source output are supported)	
<b>Input ON</b>	Residual voltage 1 V or less (input ON current 4 mA (reference value))
<b>Input OFF</b>	OPEN (cutoff current 100 $\mu\text{A}$ or less)
<b>Response time</b>	Edge 1.0 ms <sub>MAX</sub>

- Signals

<b>START</b>	Starts a test and generates output voltage.
<b>STOP</b>	Ends a test and cuts off output voltage.
<b>INTERLOCK</b>	Open when the interlock function is enabled, short circuit when the interlock function is disabled.
<b>LOAD0 to LOAD3</b>	Selects a test condition from saved test conditions.

## (2) Output

- Common specifications

Photocoupler-isolated, open drain output (non-polar)	
<b>Maximum load voltage</b>	30 V DC <sub>MAX</sub> Residual voltage 1 V or less (load current 50 mA) / 0.5 V or less (load current 10 mA)
<b>Maximum output current</b>	50 mA <sub>MAX</sub> /ch

- Signals

<b>PASS</b>	The output transistor is ON when comparator PASS judgment is made.
<b>UPPER FAIL</b>	The output transistor is ON when comparator UPPER FAIL judgment is made. The output transistor is ON when comparator UL_FAIL judgment is made.
<b>LOWER FAIL</b>	The output transistor is ON when comparator LOWER FAIL judgment is made. The output transistor is ON when comparator UL_FAIL judgment is made.
<b>TEST</b>	The output transistor is ON during a test. The output transistor is ON or OFF during discharge depending on the TEST signal OFF timing setting.
<b>ERR</b>	The output transistor is ON at the time of a contact check error, short circuit error, output voltage error judgment
<b>(ST5520-01 only)</b>	
<b>DP0 to DP2</b>	Decimal point output 3 bits (p.87)
<b>BCD0 to BCD15</b>	BCD output 4 digits, 16 bits (p.87)

- Internal power output

<b>Output voltage</b>	Sink current output compatible 5.0 V $\pm$ 10% Source current output compatible -5.0 V $\pm$ 10%, 100 mA <sub>MAX</sub>
<b>Isolation</b>	Floating from protective ground potential and measurement circuit
<b>Isolation rating</b>	Terminal to ground voltage 50 V DC, 30 V AC <sub>RMS</sub> , and 42.4 V AC <sub>PEAK</sub> or less
<b>ISO.5 V</b>	Internal power supply

<b>ISO.COM</b>	Internal GND
----------------	--------------

- External interface pin arrangement list (p.84)

### (3) TEST signal OFF timing setting

After a test, timing for the TEST signal output transistor to turn OFF from ON can be set.

<b>FAST</b>	The TEST signal turns OFF immediately after a test is completed without waiting for the voltage between the measurement terminals to drop.
<b>SLOW</b>	The TEST signal turns OFF after the voltage between the measurement terminals drops below 10 V ± 3 V.

Refer to “Test duration accuracy” (p.158).

### EXT.SW (not isolated against the power supply protective ground terminal and isolated against the measurement terminals)

The switch signal line plug of the 9299 Switched Probe is connected.

The operation mode can be switched between two modes, CONT and TRIG (the instrument settings have priority).

<b>Continuous (CONT) mode</b>	Measurement is performed only while the 9299 switch is being pressed.
<b>Trigger (TRIG) mode</b>	A test starts and stops every time the 9299 switch is pressed.

### RS-232C (not isolated against the power supply protective ground terminal and isolated against the measurement terminals)

**RMT** is displayed at the top of the screen during communications and any keys other than the LOCAL key and STOP key are disabled.

Remote control and measured value output can be performed.

#### Output data setting: OFF/TYP1/TYP2

- TYP1  
Output: Measured value + judgment
- TYP2  
Output: Measured value (index display 000.0E+06)  
(Same as :MEASure? query) (p.126)

### (1) RS-232C interface

<b>Transfer method</b>	Communications: Full duplex Synchronization: Start-stop synchronization
<b>Baud rate</b>	9,600 bps (default) / 19,200 bps / 38,400 bps
<b>Data length</b>	8 bits
<b>Parity</b>	None
<b>Stop bit</b>	1 bit

<b>Message terminator (delimiter)</b>	Receiving: CR+LF, CR Transmitting: CR+LF
<b>Flow control</b>	None
<b>Electrical specifications</b>	Input voltage levels 5 to 15 V: ON, -15 to -5 V: OFF Output voltage levels 5 to 9 V: ON, -9 to -5 V: OFF
<b>Connector</b>	Interface connector pinout (9-pin D-sub, pin contacts, with #4-40 attachment screws) The I/O connector is a terminal (DTE) configuration. Recommended cables: 9637 RS-232C Cable (for PC) 9638 RS-232C Cable (for 25-pin D-sub connector)

Operating code: ASCII codes

## (2) Maintenance terminal

Communications cannot be performed. Used for upgrading software.

## Other specifications

### Display

<b>Display parameter</b>	Resistance value, voltage value, test duration, upper limit value (comparator), lower limit value (comparator), set voltage, set range, measurement speed, panel name, status display (remote, key lock), short circuit check time
<b>Contrast adjustment</b>	0 to 100 (resolution: 5)
<b>Backlight</b>	0, 1, 2, 3 (1: Dark, 2: Standard, 3: Bright, 0: OFF, OFF can be set only via communications.)
<b>Resistance</b>	Display range 0.002 M $\Omega$ to 9990 M $\Omega$ Measured resistance value 4 digits, Max. 9990 counts
<b>Voltage</b>	Display range 0 V to 1020 V Voltage value 4 digits, Max. 1020 counts
<b>Comparator</b>	4 digits
<b>Timer</b>	6 digits
<b>Lamp</b>	TEST, PASS, U.FAIL, L.FAIL

### Switch/Key

<b>Front (keys)</b>	START, STOP, ENTER, MENU, F1 to F4, and cursor keys
<b>Rear (switches)</b>	Power switch ON/OFF, EXT.I/O mode switch (NPN/PNP)
<b>MENU keys</b>	Measurement range, measurement speed, test mode, beep sound, contact check, external interface setting, memory (saving and deleting test conditions), and other settings.

<b>Key combination</b>	Initialization (Turn on the power while pressing the <b>MENU</b> + Up keys.) Interlock cancellation (Turn on the power while pressing the <b>MENU</b> + Down keys.)
------------------------	--

### Enabled/disabled input list

The following table shows the status (enabled/disabled) of the keys, switched probe, EXT.I/O, and RS command input. "✓" indicates enabled and "-" indicates disabled. Some combinations of status can occur simultaneously, however, the disabled status has priority.

Status \ Input	Key input				Switched Probe 9299
	START	STOP	UNLOCK/LOCAL	Others	START/STOP
The EXT.I/O STOP signal is LOW.	-	✓	✓	✓	-
The EXT.I/O INTERLOCK signal is LOW.	-	✓	-	-	-
Remote	-	✓	✓ (Resets the remote.)	-	✓
Key lock	✓	✓	✓ (Resets the lock.)	-	✓
TEST	-	✓	-	-	✓

Status \ Input	EXT.I/O			RS command		
	START	STOP	Others <sup>*1</sup>	:START	:STOP	Others
The EXT.I/O STOP signal is LOW.	-	/	✓	- Execution error	✓	✓
The EXT.I/O INTERLOCK signal is LOW.	-	✓	✓	-	✓	✓
Remote	✓	✓	✓	✓	✓	✓
Key lock	✓	✓	✓	✓	✓	✓
TEST	-	✓	✓ <sup>*2</sup>	- Execution error	✓	✓ <sup>*3</sup>

\*1: The interlock is enabled during panel load operation.

\*2: The test is stopped when panel is loaded during the test.

\*3: Some commands stop a test.

**External terminal (No switching between the measurement terminals on the front panel and those on the rear panel)**

<b>Front</b>	Measurement terminals (HIGH, LOW), EXT.SW terminal
<b>Rear</b>	Measurement terminals (HIGH, LOW), EXT.I/O terminal, contact check terminals, RS-232C connector, analog output terminal, USB connector (maintenance terminal)

**Accessories**

Instruction manual ..... 1  
Power cord ..... 1  
EXT.I/O connector (pin contacts) ..... 1  
EXT.I/O connector cover ..... 1 set

**Options**

L2200	Test Lead
L9257	Connection Cord
9299	Switched Probe
9094	Output Cord (analog output)
9637	RS-232C Cable (9pin-9pin/1.8 m)
9638	RS-232C Cable (9pin-25pin/1.8 m)





## 10.1 Maintenance

### WARNING



Some of the internal components carry high voltage, which is very hazardous. Customers are not allowed to modify, disassemble, or repair the instrument. Doing so may cause fire, electric shock, or injury.

### Calibrations

#### IMPORTANT

Periodic calibration is necessary in order to ensure that the instrument provides correct measurement results of the specified accuracy.

The calibration frequency varies depending on the status of the instrument or installation environment. We recommend that the calibration frequency be determined in accordance with the status of the instrument or installation environment and that you request that calibration be performed periodically.

### Transporting

- When shipping the instrument, use the packing materials used when the instrument was delivered.
- Pack the instrument so that it is not damaged during shipping and include a description of existing damage. Hioki cannot be responsible for damage that occurs during shipping.

### Cleaning

- To clean the instrument and optional equipment, wipe them gently with a soft cloth moistened with water or mild detergent.
- Wipe the display gently with a soft, dry cloth.

#### IMPORTANT

Never use solvents such as benzene, alcohol, acetone, ether, ketones, thinners, or gasoline. They can deform and discolor the instrument.

### Disposal

Handle and dispose of the instrument and optional equipment in accordance with local regulations.

### Replacement parts and lifetime

Some of the parts used for this instrument may deteriorate due to an extended period of use.

It is recommended to replace the parts so that the instrument can be used for a long period of time.

Contact your authorized Hioki distributor or reseller for replacement parts.

The lifetime of the parts varies depending on the operating environment and frequency of use. The recommended replacement timing is not guaranteed.

Part name	Recommended replacement timing	Remarks/Conditions
Electrolytic capacitor	Approx. 10 years	The board on which the capacitor is installed is to be replaced.
LCD backlight	Approx. 10 years	When the backlight is used for 24 hours/day at $25 \pm 5^{\circ}\text{C}$ and $50 \pm 10\% \text{RH}$ .

## 10.2 Troubleshooting

When a malfunction of the instrument is suspected, check the information in “Before sending the instrument for repair” and then, if necessary, contact your authorized Hioki distributor or reseller.

### Before sending the instrument for repair

Symptom	Solution	Reference
An error is displayed in the display screen.	When an error appears in the display, refer to Error display and solutions (p. 175).	-
Even after short circuit of the probe, the measured value does not appear.	If the measured value is not displayed when the probe is short circuited, the fuse may have blown or been damaged. Contact your authorized Hioki distributor or reseller.	-

### Measurement

Symptom	Cause and solution	Reference
The measurement value does not appear.	An appropriate measurement range may not be automatically defined. Extend the test duration.	p.39
The voltage is not output.	The probe wires may be broken. Use the contact check function or check the probe using a tester.	p.56
The set voltage is not output.	Check the resistance of the load. The measurement current is limited to less than 2.0 mA. The voltage cannot rise to the set voltage with the load carrying a current of 2.0 mA or more. Example) If the set voltage is 500 V and the resistance load is 100 kΩ, the voltage rises only to 200 V.	-
The comparator judgment result is wrong.	The resistance range may not be set to the range appropriate for the lower limit value. Refer to the resistance measurement specifications and change the range accordingly.	p.36
	The probe wires may be broken. Use the contact check function or check the probe using a tester.	-
	The measurement terminals may be connected to both the front and rear terminals. When the measurement terminals are connected to both the terminals, accurate measurement cannot be performed.	p.24

Symptom	Cause and solution	Reference
Unstable measured values	The power frequency setting may not be appropriate. Change the power frequency according to the customer environment.	p.71
	A load containing capacitance components may be connected. It may take time for the measured value to stabilize depending on the capacitance components. Extend the test duration.	p.39
	The measurement cable is long and the measured value may be affected by the wiring capacity.	p.Appx.6
	Noise may be causing the unstable measured value.	p.Appx.7
U.FAIL and L.FAIL lamps turn on at the same time.	The set upper and lower limits (comparators) and range setting may not match. Set the lower limit based on the set range's accuracy range.	p.44

### External Control

Symptom	Cause and solution	Reference
Communications cannot be performed smoothly.	Check the RS-232C transfer speed.	p.114
	Check the commands that are sent and received using the communications monitor function. The areas where command and execution errors occur can be checked.	p.121
Control cannot be performed with EXT.I/O.	The wiring may be wrong. <ul style="list-style-type: none"> <li>• The connectors may be disconnected.</li> <li>• The pin number may be wrong.</li> <li>• ISO_COM terminal wiring</li> <li>• NPN/PNP setting</li> <li>• Contact (or open collector) control (not controlled by voltage)</li> <li>• Power supply to EXT.I/O (It is not necessary to supply power to the instrument.)</li> </ul>	p.81
	Check the input and output signals using the EXT.I/O test function.	p.103
A test does not start.	Check the pulse width of the START and TEST signals. Refer to the timing chart.	p.88

Others

Symptom	Cause and solution	Reference
The power does not turn on.	The power may not be supplied. <ul style="list-style-type: none"> <li>• Check the power cord.</li> <li>• Check that the facility breaker is on.</li> <li>• Turn on the power switch (rear side).</li> </ul>	-
	The power voltage and frequency may not be correct. Check the power rating. (100 V to 240 V, 50/60 Hz)	-
The key operation cannot be performed.	<b>[LOCK]</b> is displayed. <ul style="list-style-type: none"> <li>• When the key lock function is set to ON, disable the function.</li> </ul>	p.65
	<ul style="list-style-type: none"> <li>• When the interlock function is set to ON, switch it to OFF. To disable the interlock function, turn on the power while holding down the MENU key and down key. Otherwise, send the communication command, <b>:IO: ILOCK OFF</b>.</li> </ul>	p.106
	<ul style="list-style-type: none"> <li>• While a LOAD signal is input, the instrument enters the key lock state, accepting no key operations.</li> </ul>	p.86
	<b>[RMT]</b> is displayed. Reset the remote.	p.120
	<b>[LOCK]</b> is displayed. Release the interlock. <ul style="list-style-type: none"> <li>• How to release the interlock Turn on the power while pressing the MENU + Down keys. The interlock can also be released using the "<b>:IO: ILOCK OFF</b>" communication command.</li> </ul>	p.106
The COMP lamp does not turn on.	When the measured value is displayed, the upper or lower limit value may not be set. Set the upper or lower limit value.	p.44
	When the measured value is not displayed, an appropriate measurement range may not be automatically defined. Extend the test duration.	p.39
A contact check error occurs.	The probe wires may be broken. Check the probe using a tester.	-
	The contact resistance between the measurement terminal and contact check terminal may be high.	-
	The equipment to be measured may not be in contact. Check the wiring again.	-

Symptom	Cause and solution	Reference
<p>[Output Voltage Error] is displayed.</p>	<p>A voltage that is higher than the set test voltage may be output. A malfunction may have occurred. Contact your authorized Hioki distributor or reseller.</p>	<p>-</p>
	<p>A voltage that is higher than the set voltage may be input during the test. Check that the equipment to be measured has been fully discharged. Example) If the voltage applied during a pressure test is not fully released when the pressure test is performed before an insulation resistance test is performed.</p>	<p>-</p>

## Error display and solutions

The following messages are displayed on the screen when there is a problem with the instrument or measurement.

If repair is required, contact your authorized Hioki distributor or reseller.

- If any damage is suspected, check “Troubleshooting” first and then contact your authorized Hioki distributor or reseller.
- If an error is displayed in the LCD display and repair is required, contact your authorized Hioki distributor or reseller.

Display		Meaning	Solution	Reference
ContHL		Contact check error	Check the wiring of the measurement cable for the contact check.	p.56
			Check the contact check function.	p.29
ContHi		HIGH side contact check error	Check the wiring of the measurement cable for the HIGH side contact check.	p.56
			Check the contact check function.	p.29
ContLo		LOW side contact check error	Check the wiring of the measurement cable for the LOW side contact check.	p.56
			Check the contact check function.	p.29
Short		Short circuit check error	The equipment to be measured may be short-circuited. Check the equipment to be measured.	p.60
ERR:001	LOW limit is higher than UPP limit.	The upper limit value cannot be set because the lower limit value is greater than the upper limit value.	Set the upper limit value so it is greater than the lower limit value.	p.44
ERR:002	Double action is ON. Press [STOP] first and press [START] within 1 sec to start.	Double action error	The double action function is set to ON.	p.68
ERR:003	Delay time is longer than test time.	Test duration error	The response time is set longer than the test duration.	p.39

Display		Meaning	Solution	Reference
ERR:004	Measurement aborted by interlock.	Interlock error	The test is canceled because the interlock function is activated during the test.	p.106
ERR:030	Command error.	Command error	Check that the command is correct.	-
ERR:031	Execution error. (Parameter error)	Execution error. The parameter setting is outside of the range.	Check that the parameter range is correct.	-
ERR:032	Execution error.	Execution error	Check that the command with an error does not fall under the execution error conditions.	-
ERR:090	ROM check sum error.	Program ROM check sum error	The instrument is malfunctioning. Send the instrument out for repair.	-
ERR:091	RAM error.	CPU RAM error	The instrument is malfunctioning. Send the instrument out for repair.	-
ERR:094	Output voltage error. Power off by rear power-sw.	Output voltage error. Turn off the power switch on the rear panel.	A voltage that is higher than the set test voltage may be output. Refer to "Troubleshooting" as well.	p.171
ERR:096	Backup data error.	Setting backup error	The settings have been initialized. Reset the measurement conditions, etc.	-
ERR:097	Power line detection error. Select power line cycle.	Power frequency detection error	Set the frequency according to the supply power.	p.71



# Appendix

## Appx. 1 Block Diagram

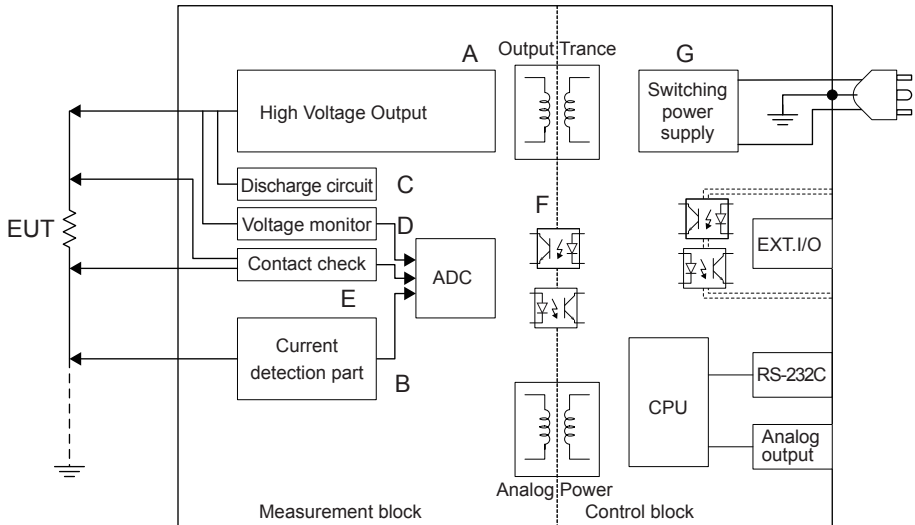

- With our unique technology, the ripple component in the DC voltage is reduced and DC voltage is output without overshoot. The DC voltage can be changed between 25 V and 1000 V in increments of 1 V resolution. (A)
- In order to conform to safety standard IEC61010, the short circuit current is controlled under 2.0 mA. (B)
- Any charge in the equipment to be measured can be released quickly. (C)
- The voltage monitor is operating any time in addition to during tests, the voltage between measurement terminals can always be monitored. (D)
- As a contact check circuit is installed and contacts are always monitored, the quality of an insulation resistance test can be improved. (E)
- An operational isolation structure of 1000 V DC with sufficient isolation performance is provided for the analog and digital units. (F)
- The auto-ranging 100-to-240 V switching power supply can provide stable measurements even in poor power quality environments. (G)

# Appx. 2 Contact Check Function

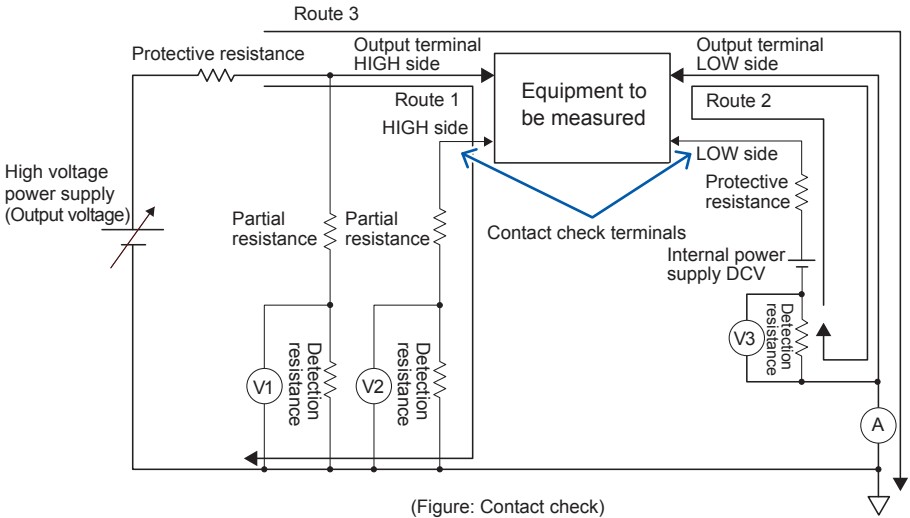

(Figure: Contact check)

A contact check is performed independently for the output terminal HIGH side and LOW side. The principle of a contact check is shown below.

### Principle

HIGH side contact check:

Using output voltage monitor V1 and contact check voltage monitor V2, the voltage of the measurement terminal is measured and whether the output voltage is reliably applied to the terminal is checked. (Route 1)

LOW side contact check:

Internal power supply (DCV) for a contact check on the LOW side and current (voltage) detector V3 are provided. A contact check is performed by V3 that detects the current from DCV flowing through the electrode of the equipment to be measured. (Route 2)

As resistance is normally detected by Route 3, DCV for a contact check on the LOW side does not affect resistance measurements.

## Appx. 3 Output Voltage and Measurement Resistance

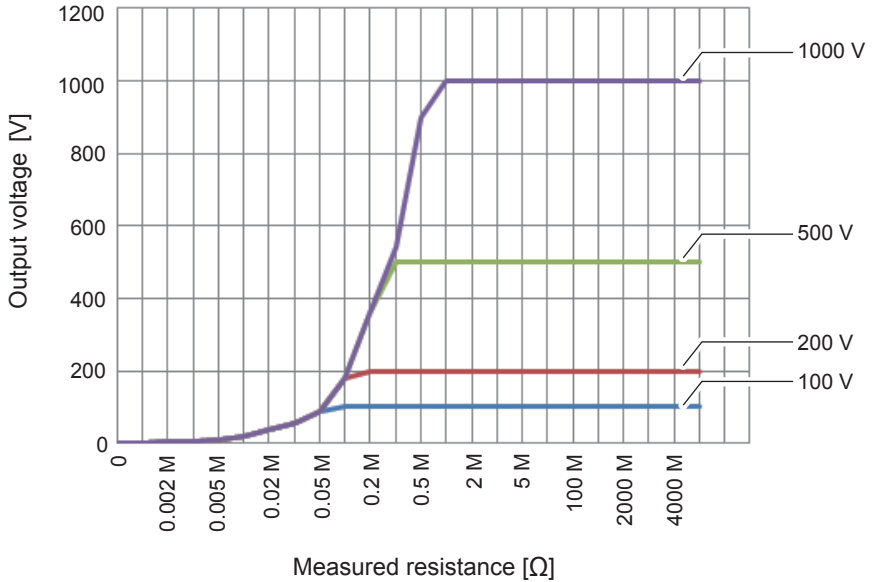

Output voltage depends on measurement current 1.8 mA.

If the equipment to be measured carries 1.8 mA or more, the voltage does not rise to the set output voltage.

## Appx. 4 Influence of Capacitive Load

Pure resistance is assumed in the instrument specifications, however, some capacitance components are contained in the equipment to be measured. The higher the resistance is (small detected current), the more variability the influence of a capacitive load causes.

### Influence on output voltage rise

The charge current of the instrument is 1.8 mA (less than 20 mA).

If a capacitive load, such as a capacitor, is connected, the time required for the output voltage to rise is affected. The time is calculated as follows.

$$CV = it \text{ (C: Capacitance (F), V: Voltage (V), i: Current (A), t: Time (s))}$$

Example: If a test voltage of 500 V is applied to a 1.0  $\mu\text{F}$  capacitor, the time required for the output voltage to rise to 500 V is approximately 0.28 s, calculated by  $(1.0 \mu\text{F} \times 500 \text{ V})/1.8 \text{ mA}$ .

If the equipment to be measured contains capacitive components, extend the test duration.

### Repeat accuracy

Test condition: Connect and measure the resistance load and capacitive load in parallel. (See the figure below.)

(A film capacitor is used.)

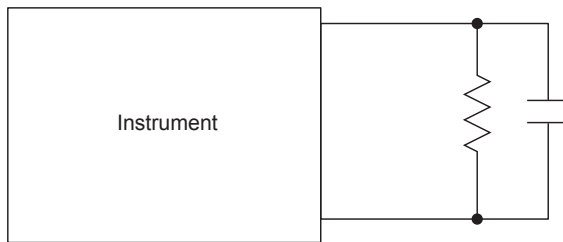

Connection diagram

As the test data shows below, measurements were performed for each resistance range and variation in the average of 100 measurements was calculated. The measured values were obtained with the capacitor charged.

(Test duration: Max. 100 s)

**FAST**

Capacitance \ Voltage	25 V	50 V	100 V	250 V	500 V	1000 V
0.001 $\mu\text{F}$	$\pm 1.0\%$	$\pm 1.0\%$	$\pm 1.4\%$	$\pm 1.3\%$	$\pm 1.3\%$	$\pm 1.4\%$
0.01 $\mu\text{F}$	$\pm 1.5\%$	$\pm 1.4\%$	$\pm 2.7\%$	$\pm 1.7\%$	$\pm 1.8\%$	$\pm 3.7\%$
0.05 $\mu\text{F}$	$\pm 3.0\%$	$\pm 2.5\%$	$\pm 7.0\%$	$\pm 3.0\%$	$\pm 5.8\%$	$\pm 7.7\%$
0.1 $\mu\text{F}$	$\pm 5.8\%$	$\pm 4.5\%$	$\pm 14.0\%$	$\pm 6.8\%$	$\pm 11.5\%$	$\pm 53.0\%$

**SLOW**

Capacitance \ Voltage	25 V	50 V	100 V	250 V	500 V	1000 V
0.001 $\mu\text{F}$	$\pm 1.0\%$	$\pm 1.0\%$	$\pm 1.0\%$	$\pm 1.0\%$	$\pm 1.0\%$	$\pm 1.0\%$
0.01 $\mu\text{F}$	$\pm 1.2\%$	$\pm 1.0\%$	$\pm 1.6\%$	$\pm 1.2\%$	$\pm 1.8\%$	$\pm 1.5\%$
0.05 $\mu\text{F}$	$\pm 1.5\%$	$\pm 1.2\%$	$\pm 2.2\%$	$\pm 2.0\%$	$\pm 2.8\%$	$\pm 1.4\%$
0.1 $\mu\text{F}$	$\pm 2.0\%$	$\pm 1.6\%$	$\pm 3.8\%$	$\pm 2.0\%$	$\pm 3.0\%$	$\pm 8.6\%$

Variation may be different depending on the capacitor type.

## Appx. 5 Influence of Cable Length

When the instrument is incorporated in a production line or automated machine, the measurement cable may be extended. When the measurement cable is extended, measured values can be affected by coupling capacitance between cables or line noise. The level of influence on measured values when the measurement cable is extended is shown below.

For the influence of a capacitive load, refer to “Appx. 4 Influence of Capacitive Load” (p.Appx.4). For the influence of line noise, refer to “Appx. 6 Influence of Noise” (p. Appx.7).

Cable: UL1032 AWG18  
Twisted wires 75 wires ×  $\phi$ 0.12 mm (extended optional L2200)

### Instrument settings

Test voltage: 1000 V  
Resistance range: 4000 M $\Omega$  range  
Load: 3600 M $\Omega$  + cable coupling capacitance (approx. 250 pF)

Measurement speed	Cable length			
	0.7 m	2 m	3 m	4 m
FAST	±0.1%	±0.4%	±0.7%	±0.9%
SLOW	±0.1%	±0.4%	±0.6%	±0.8%

The values above indicate the repeat accuracy.

### Cautions for measurement cable wiring

- When the measurement cable is laid on a metal ground, the influence of noise can be reduced.
- When the measurement cable is extended, the influence of power line noise becomes more significant. Position the measurement cable away from the power line.
- Position the measurement cable away from any noise sources (motor, welder, inverter, etc.).

## Appx. 6 Influence of Noise

### Noise infiltration pathway

Electrical interference in electronic circuits and devices is known as noise. Equipment such as motors, welders, and inverters is particularly noteworthy as a source of noise at industrial plants. Noise may infiltrate a circuit directly from a noise source via a communications, power, or ground line, or via the phenomenon of induction (either electrostatic or electromagnetic)(see “Figure. Conductive noise entry route”).

Noise also exists in the form of surges, which take the form of strong pulse-shaped waves across a broad range of frequencies. Finally, there is also power supply noise caused by the supply frequency. These types of noise may affect measured values.

Caution is necessary in the following instances as noise may affect measured values:

- If measurement cables lie close to a noise source
- If measurement cables run parallel to a power line used by a noise source
- If the instrument shares a power supply with a noise source
- If the measurement speed has not been synchronized with the commercial power supply frequency

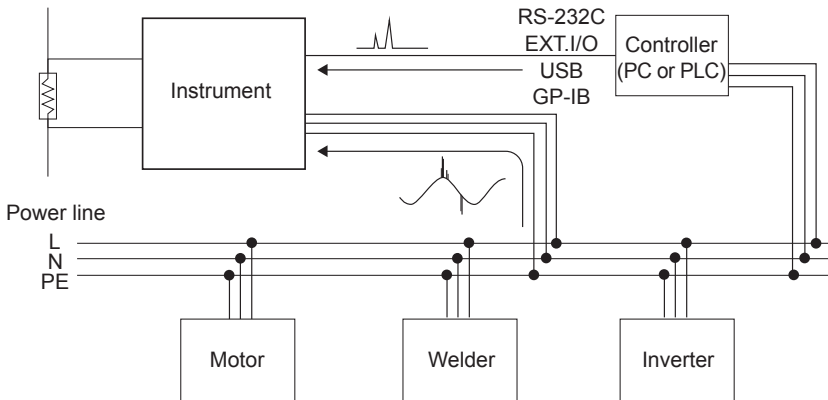

Figure. Conductive noise entry route

### Precautions when routing measurement cables

Take into account the following considerations in order to reduce the effects of noise on measured values

#### Keep measurement cables away from noise sources and power lines.

Signal lines are prone to coupling with nearby conductive materials such as metal due to the effects of stray capacitance. Electrostatically induced noise can infiltrate the circuit via this coupling. Since stray capacitance is inversely proportional to distance, it is necessary to separate measurement cables from noise sources. Similarly, it is good practice to separate different types of signal lines, power lines and signal lines, input and output lines, ground lines and signal lines, and other types of cabling.

#### Shield measurement cables.

By shielding measurement cables and connecting the shielding to the ground terminal on the rear of the instrument, noise that infiltrates measurement cables can be routed to the ground (see “Figure. Shielding effect”).

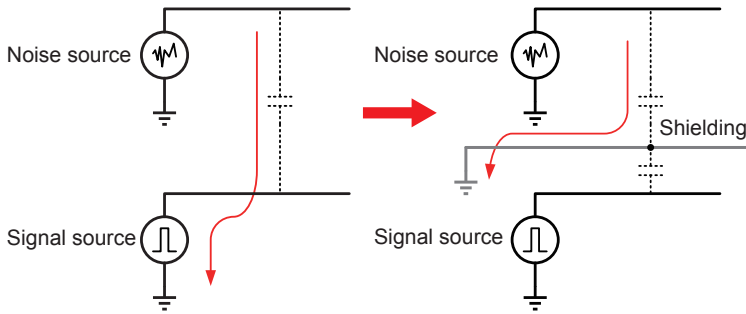

Figure. Shielding effect

Follow the procedure below to shield the measurement cable.

1. Connect the coaxial cable to the OUTPUT LOW terminal.  
(Select the cable insulated by polyethylene (PE), which provides good insulation.)
2. Connect the shield of the coaxial cable to the GND terminal.

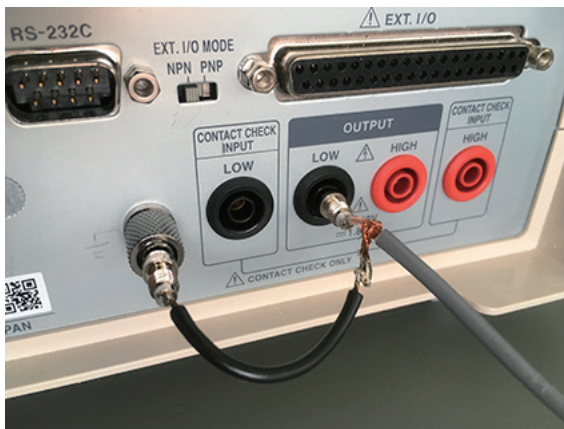

Figure. Shielding method



**Synchronize the measurement speed with the commercial power supply frequency.**

The instrument provides two measurement speeds: FAST and SLOW. When the instrument's frequency setting for the power supply is set to AUTO, both measurement speeds will be synchronized with the power supply frequency. Although you can also set the instrument's frequency setting manually to either 50 Hz or 60 Hz, caution is necessary as using the incorrect setting may cause measured values to exhibit instability.

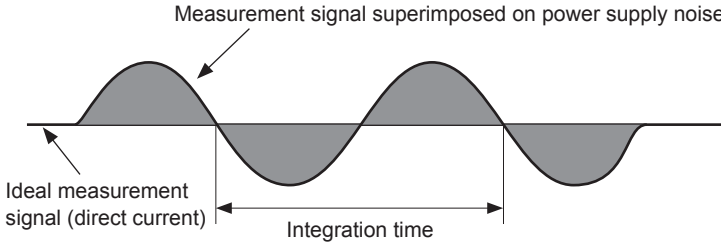

Figure. Noise caused by commercial power supply

**Separating the power line**

It is desirable to prepare a different power line for the power system, welder, etc. (see "Figure. Measures for conductive noise")

**Inserting a common mode filter (EMI choke) in the entry route**

Selecting and inserting several common mode filters with a high impedance level increases effectiveness (see "Figure. Measures for conductive noise").

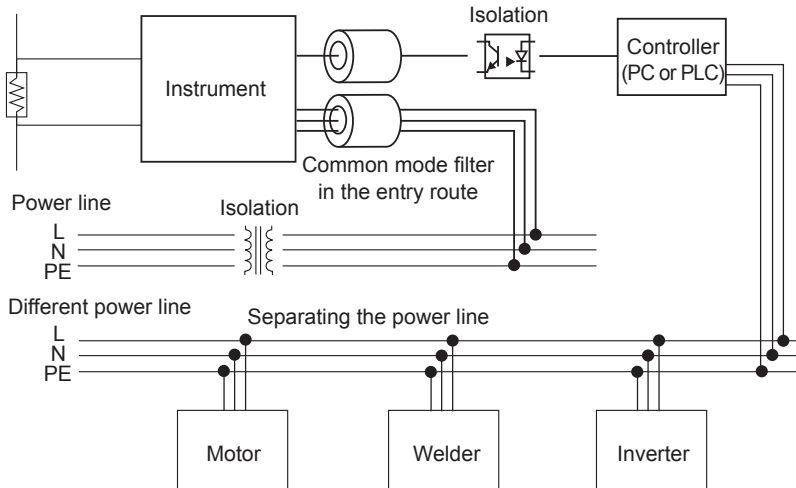

Figure. Measures for conductive noise

# Appx. 7 Changes in Current Running through Insulator

When measuring insulation resistance, a large current flows as voltage is applied, and gradually the current becomes smaller, not reaching a constant value. This is caused by charge current, absorption current, and leak current, and is generally called dielectric absorption. The equivalent circuit of an insulator is shown in Figure 1. In this figure, when voltage is applied, a charge current flows to  $C_0, C_1, C_2, \dots, C_n$ , and  $C_0$  is charged first, then  $C_1, C_2, \dots, C_n$ , during which the current becomes smaller, and finally only leak current from  $R_0$  remains. (Refer to Figure 2.)

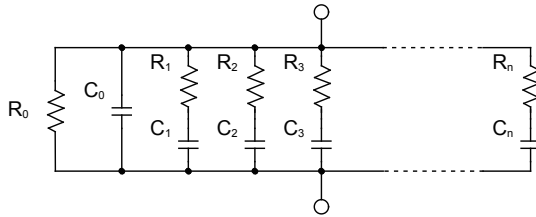

Figure 1 Equivalent Circuit of the Insulator

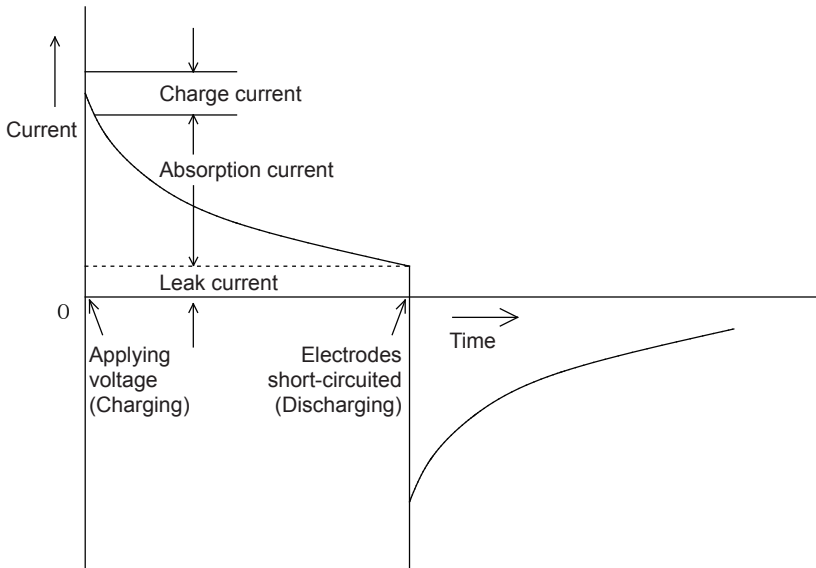

Figure 2 Dielectric Absorption

$R_0$  is the insulation resistance. Because the high resistance  $R_1, R_2, \dots, R_n$  are connected in series respectively with  $C_1, C_2, \dots, C_n$ , it is difficult to measure only  $R_0$  separately.

It is generally said that the time until convergence can be several hours to several days. Therefore, the resistance 1 minute after applying voltage is considered as the insulation resistance. It is called 1-minute insulation resistance, and is widely used in standards.

When measuring the 1-minute insulation resistance, the first value differs from the second or third consecutively measured values, so be sure to discharge the object with a voltage applied before a measurement.

It also depends on the amount of voltage across  $C_0$  shown in Figure 1; however, discharging the capacitance generally requires a period 5 to 6 times as long as the voltage-applying time during the measurement.

## Appx. 8 Rack Mounting

By removing the screws on the bottom, this instrument can be installed in a rack mounting plate.

### ⚠ WARNING



Observe the following precautions regarding the mounting screws to avoid instrument damage and electric shock accidents.

- When removing the Rack Mounting Plate to return the instrument to stand-alone use, replace the same screws that were installed originally. (Feet: M3 × 6 mm)

### Rack Mounting Plate template diagram and installation procedure

#### Rack Mounting Plate (EIA)

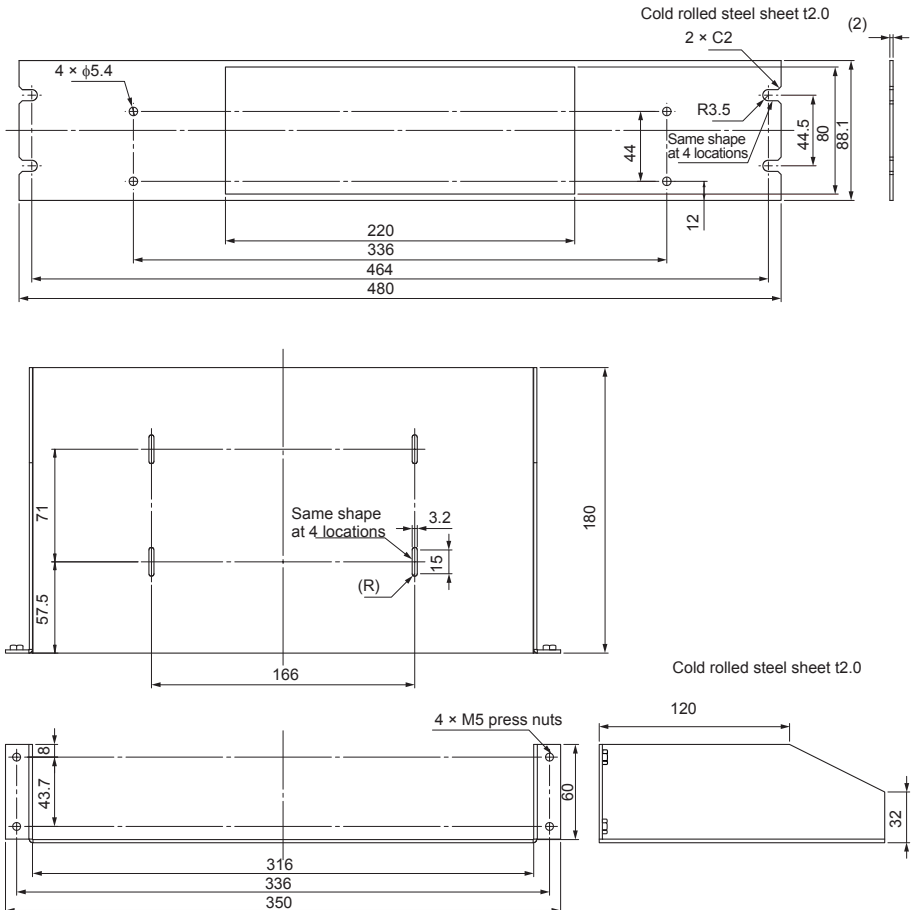

**Rack Mounting Plate (JIS)**

Cold rolled steel sheet t2.0

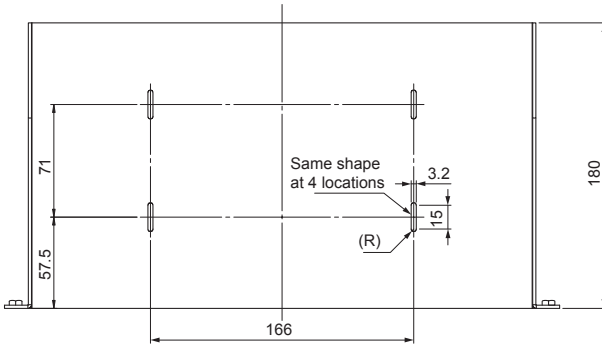
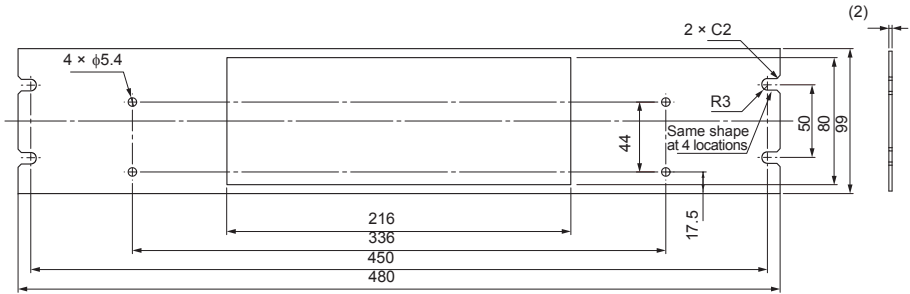

Cold rolled steel sheet t2.0

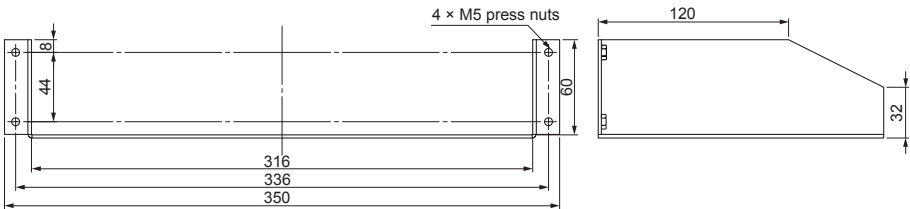

M3 × 6 mm

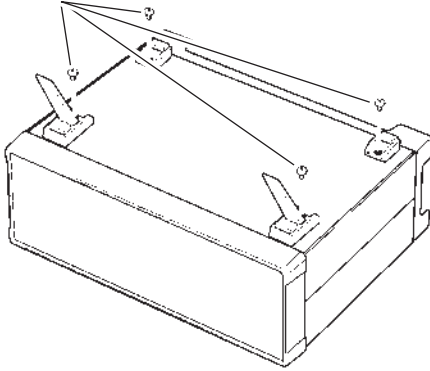

**1** Extend the legs on the bottom of the instrument and remove the four screws.

**2** Affix the Rack Mounting Plate with the M3 × 6 mm screws.

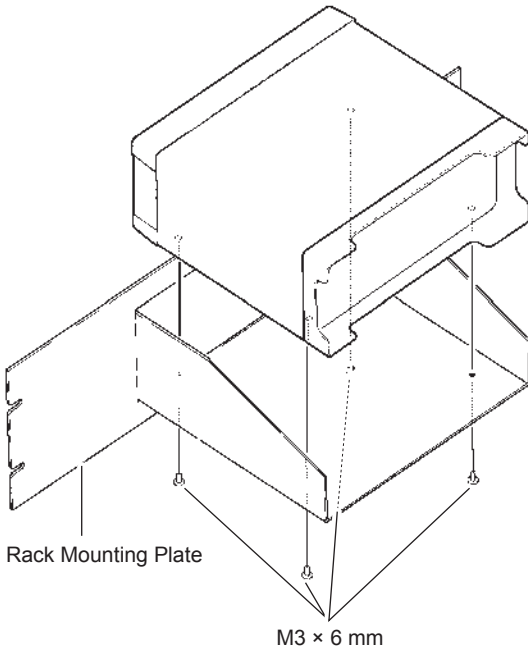

**IMPORTANT**

When installing into the rack, support the installation with a commercially available support stand.

### Screw location dimensional drawing

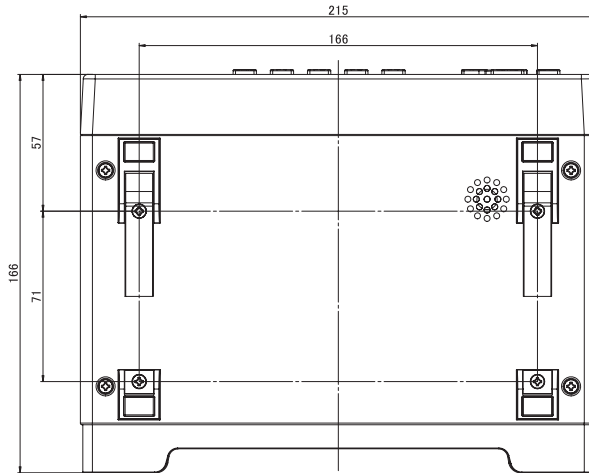

# Appx. 9 Dimensional Diagram

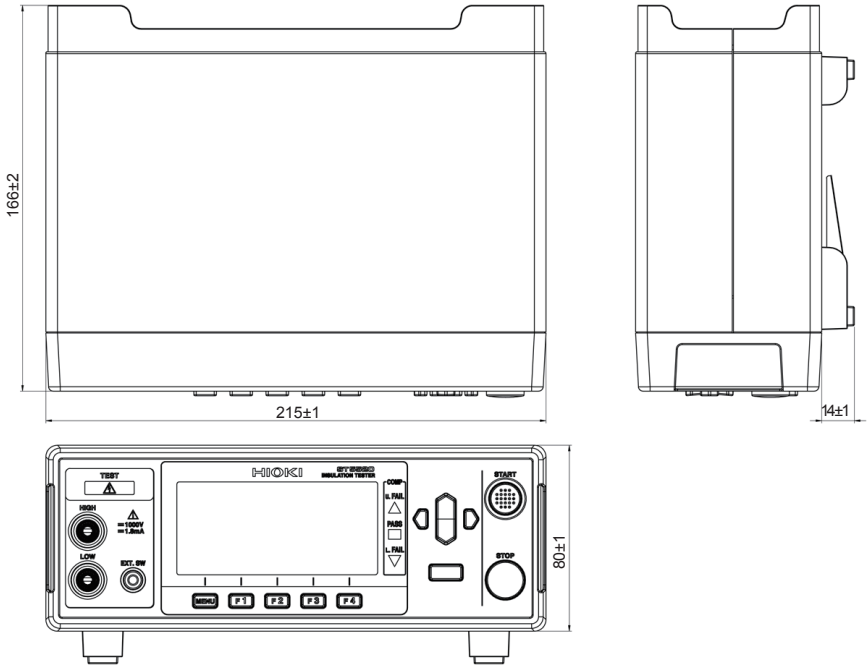



# Index

## A

Automatic discharge function ..... 54

## B

Backlight ..... 70

Block diagram ..... Appx.1

## C

Command

Control ..... 119

Data acquisition ..... 119

Command reference ..... 126

Comparator function ..... 44

Contact check function ..... 56, Appx.2

Check ..... 29

Contrast ..... 69

## D

Data format table ..... 125

Default setting list ..... 73

Dimensional diagram ..... Appx.16

Double action function ..... 68

## E

External control ..... 81

EXT I/O ..... 81

EXT I/O test function ..... 103

## F

Frequency ..... 71

## I

Influence of Cable Length ..... Appx.6

Influence of capacitive load ..... Appx.3

Initialization ..... 72

Inspection ..... 27

## J

Judgment results

Beep sound ..... 47

## K

Key operation

Disable ..... 65

Enable ..... 66

Key operation sound ..... 67

## M

Maintenance ..... 165

Measured value

Unstable ..... Appx.4

Measurement lead ..... 24

Make your own ..... Appx.6

Measurement speed ..... 38

## O

Option ..... 2, 164

## P

Panel

Change the panel name ..... 78

Delete data ..... 79

Panel load ..... 75, 77

Panel save ..... 75, 76

Power

Turn off ..... 26

Turn on ..... 26

Power cord ..... 23

## R

Rack mounting ..... Appx.12

Range ..... 36

Reset ..... 72

Response time ..... 41

RS-232C interface ..... 113

Connect ..... 115

Data output function ..... 117

Set ..... 114

## S

Short circuit check function ..... 60

Specifications ..... 151

Switched probe

Connect ..... 109

Use ..... 108

## T

---

Test duration .....	39
Testing	
Completing measurement.....	53
During measurement .....	51
Starting measurements.....	49
Test mode .....	46
TEST signal .....	96, 101
Test voltage .....	34
Timing chart.....	88
Troubleshooting.....	167

# Warranty Certificate

# HIOKI

Model	Serial number	Warranty period Three (3) years from date of purchase ( ___ / ___ )
-------	---------------	--

Customer name: \_\_\_\_\_  
Customer address: \_\_\_\_\_

### Important

- Please retain this warranty certificate. Duplicates cannot be reissued.
- Complete the certificate with the model number, serial number, and date of purchase, along with your name and address. The personal information you provide on this form will only be used to provide repair service and information about Hioki products and services.

This document certifies that the product has been inspected and verified to conform to Hioki's standards. Please contact the place of purchase in the event of a malfunction and provide this document, in which case Hioki will repair or replace the product subject to the warranty terms described below.

### Warranty terms

1. The product is guaranteed to operate properly during the warranty period (three [3] years from the date of purchase). If the date of purchase is unknown, the warranty period is defined as three (3) years from the date (month and year) of manufacture (as indicated by the first four digits of the serial number in YYMM format).
2. If the product came with an AC adapter, the adapter is warranted for one (1) year from the date of purchase.
3. The accuracy of measured values and other data generated by the product is guaranteed as described in the product specifications.
4. In the event that the product or AC adapter malfunctions during its respective warranty period due to a defect of workmanship or materials, Hioki will repair or replace the product or AC adapter free of charge.
5. The following malfunctions and issues are not covered by the warranty and as such are not subject to free repair or replacement:
  - 1. Malfunctions or damage of consumables, parts with a defined service life, etc.
  - 2. Malfunctions or damage of connectors, cables, etc.
  - 3. Malfunctions or damage caused by shipment, dropping, relocation, etc., after purchase of the product
  - 4. Malfunctions or damage caused by inappropriate handling that violates information found in the instruction manual or on precautionary labeling on the product itself
  - 5. Malfunctions or damage caused by a failure to perform maintenance or inspections as required by law or recommended in the instruction manual
  - 6. Malfunctions or damage caused by fire, storms or flooding, earthquakes, lightning, power anomalies (involving voltage, frequency, etc.), war or unrest, contamination with radiation, or other acts of God
  - 7. Damage that is limited to the product's appearance (cosmetic blemishes, deformation of enclosure shape, fading of color, etc.)
  - 8. Other malfunctions or damage for which Hioki is not responsible
6. The warranty will be considered invalidated in the following circumstances, in which case Hioki will be unable to perform service such as repair or calibration:
  - 1. If the product has been repaired or modified by a company, entity, or individual other than Hioki
  - 2. If the product has been embedded in another piece of equipment for use in a special application (aerospace, nuclear power, medical use, vehicle control, etc.) without Hioki's having received prior notice
7. If you experience a loss caused by use of the product and Hioki determines that it is responsible for the underlying issue, Hioki will provide compensation in an amount not to exceed the purchase price, with the following exceptions:
  - 1. Secondary damage arising from damage to a measured device or component that was caused by use of the product
  - 2. Damage arising from measurement results provided by the product
  - 3. Damage to a device other than the product that was sustained when connecting the device to the product (including via network connections)
8. Hioki reserves the right to decline to perform repair, calibration, or other service for products for which a certain amount of time has passed since their manufacture, products whose parts have been discontinued, and products that cannot be repaired due to unforeseen circumstances.

**HIOKI E.E. CORPORATION**

<http://www.hioki.com>

18-07 EN-3





# HIOKI

<http://www.hioki.com>



**All regional  
contact  
information**

## **HEADQUARTERS**

81 Koizumi  
Ueda, Nagano 386-1192 Japan

## **HIOKI EUROPE GmbH**

Rudolf-Diesel-Strasse 5  
65760 Eschborn, Germany  
[hioki@hioki.eu](mailto:hioki@hioki.eu)

1906 EN

---

Edited and published by HIOKI E.E. CORPORATION

Printed in Japan

- CE declarations of conformity can be downloaded from our website.
- Contents subject to change without notice.
- This document contains copyrighted content.
- It is prohibited to copy, reproduce, or modify the content of this document without permission.
- Company names, product names, etc. mentioned in this document are trademarks or registered trademarks of their respective companies.