

HIOKI

NON-CONTACT CAN SENSOR SP7001, SP7002

NEW

Easy CAN Acquisition Simply Pinch Over Wire Insulation



Even simpler and more convenient than the 1st generation of Hioki Non-contact CAN-sensors

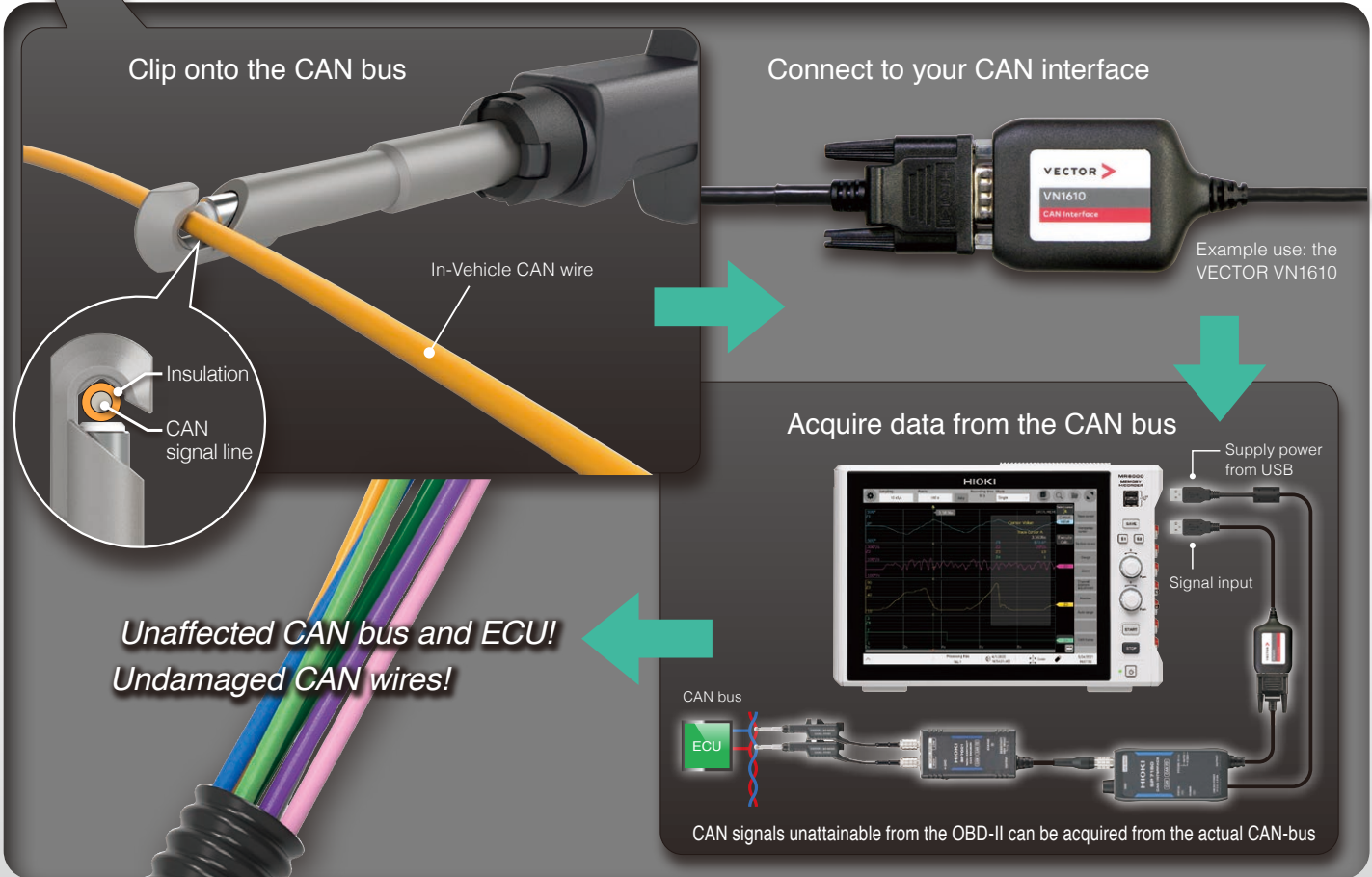

Pinch-and-acquire from outside the CAN sheath. Now you can...

Effectively utilize CAN data in every area of automotive development, reduce man-hours and improve quality.

Model Based Developing

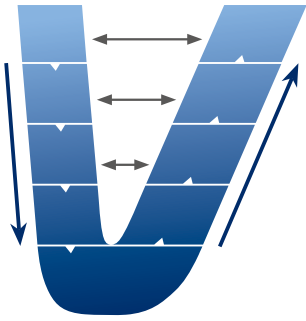

Utilize CAN data in earlier development processes

HIL Testing & Calibration Testing

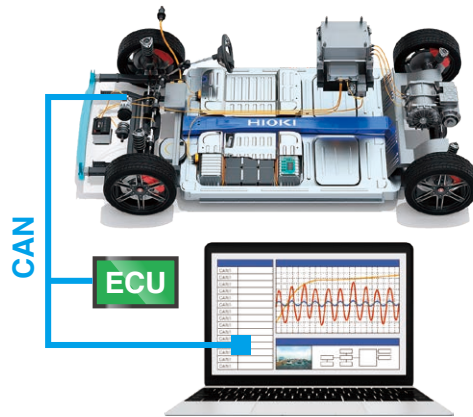

Monitor signals between the ECU and the controlled component

Real-driving Test

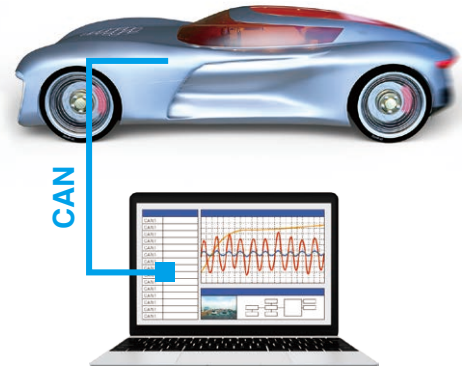

Monitor real-driving tests that are increasingly common (e.g. autonomous driving tests, upgrading of vehicle software)

All measurement tasks are simple and safe

1 No need for a sub-harness: Simply hook probes over wire insulation

Dramatically reduce man-hours

Capture CAN signals without the need to fabricate sub-harnesses or strip back wire insulation, which significantly reduces the number of man-hours spent on test preparation.



One-handed operation to open the probe tip

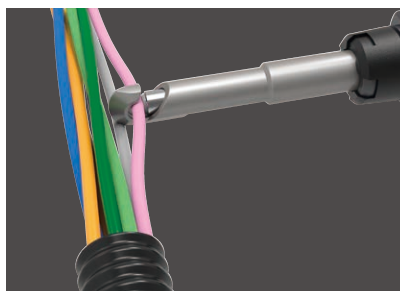

Hook the open end to the CAN bus

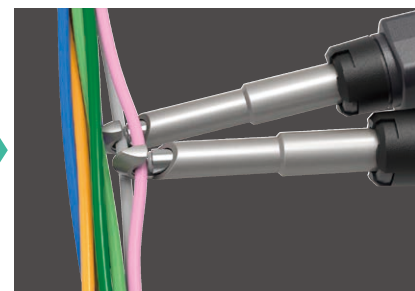

Automatically locks on when you release your hand

One-handed probing to easily reach hard-to-get-to areas that are tight, deep, and crowded with cables



Tight spaces and deep spaces



Quickly pinch with one hand from over the sheath



Undamaged wires for easy and safe measurement

2 Continue using your existing CAN analysis system

Industry-standard CAN output connector pin layout¹

Customers who already have a CAN analysis system such as those manufactured by Vector Informatik GmbH need only connect the sensor to that system's input terminal (via a D-sub 9-pin connector).

¹ Please refer to page 7 for pin assignments.

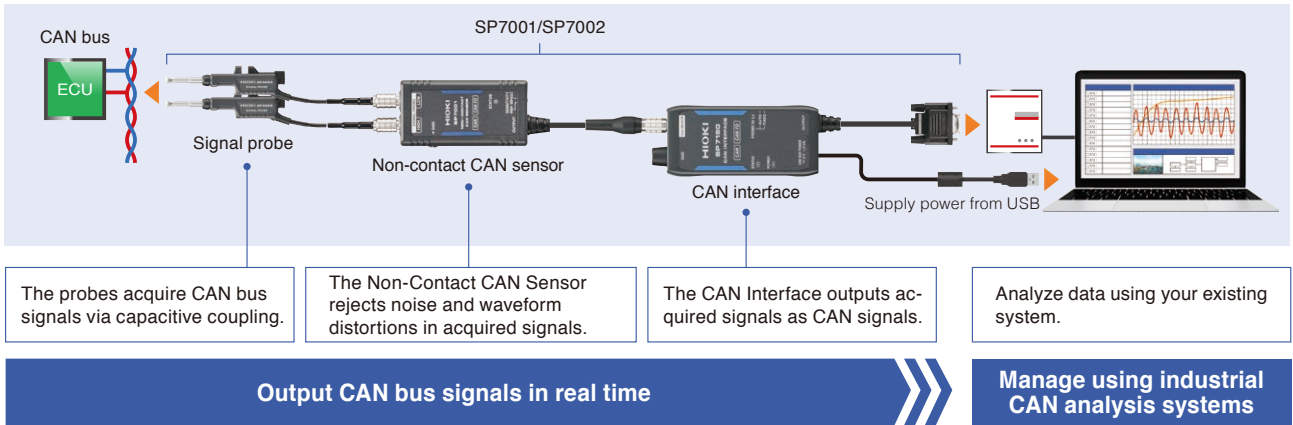

3 A Non-Contact CAN Sensor engineered to fully meet professional requirements

Wide -40°C to 85°C operating temperature

Acquire CAN signals in environments from -40°C to 85°C (-40°F to 185°F), the temperature range required in vehicle testing



Use in extreme temperature environments

Adjustable sensitivity accommodates a variety of conditions

Use high-sensitivity mode³ to broaden the detection level when the CAN signal amplitude is low relative to the CAN standard or when you are unable to detect a signal due to cable conditions.

³ It is recommended to use default mode under typical situations since it delivers the optimal level of vibration and noise immunity.

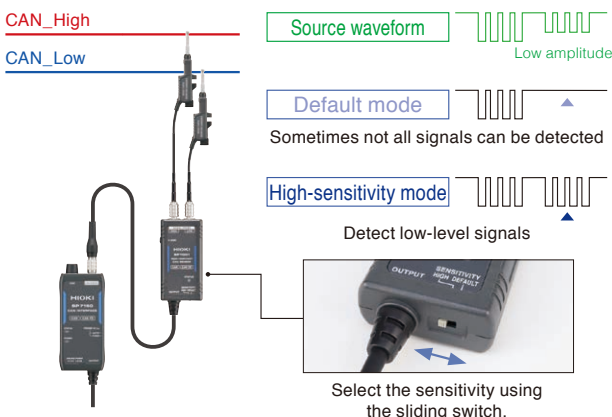

Connect probes without worrying about CAN bus polarity

If you're using automatic input polarity mode², the SP7001/SP7002 will automatically switch the input polarity to ensure you can capture CAN signals properly, even if the probes are connected in reverse relative to the CAN bus's polarity (CAN_High/CAN_Low).

² This function will operate as long as the CAN bus load factor is at least 5%.

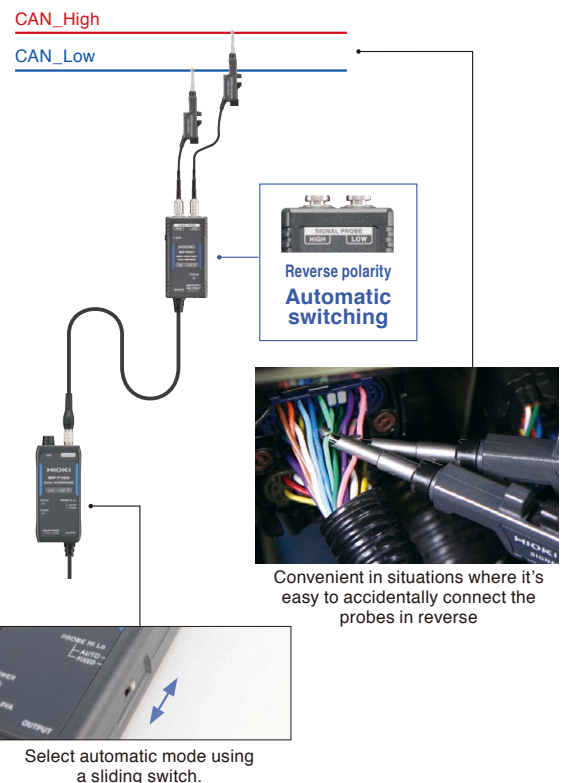

Eliminate testing concerns by using non-contact sensing technology

Designed not to trigger ECU security lock-outs

The SP7001/SP7002 acquires signals without changing the electrical characteristics of the CAN bus. Even if the vehicle is equipped with an ECU that has a security lock-out function designed to detect changes in the CAN bus's electrical characteristics, you'll be able to carry out testing without worrying about getting locked out.

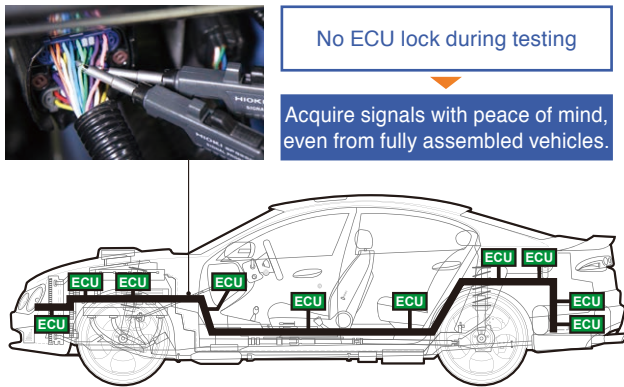

Vibration resistance designed for on-road testing

The sensor delivers noise immunity designed for in-vehicle testing in a variety of road environments. Acquire CAN signals in a stable manner in evaluation testing not only on test courses, but also in vehicles undergoing test-drives on public roads.

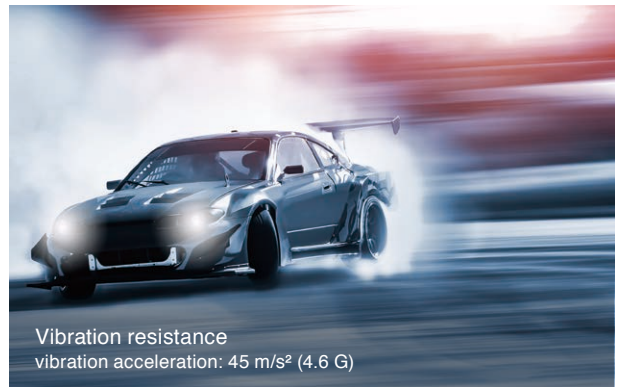

Noise immunity robust enough for use with EVs and HVs

The sensor delivers enough noise immunity to acquire CAN signals in a variety of noise environments. Acquire CAN signals in a stable manner, even with vehicles such as EVs and HVs that rely increasingly on electric equipment.

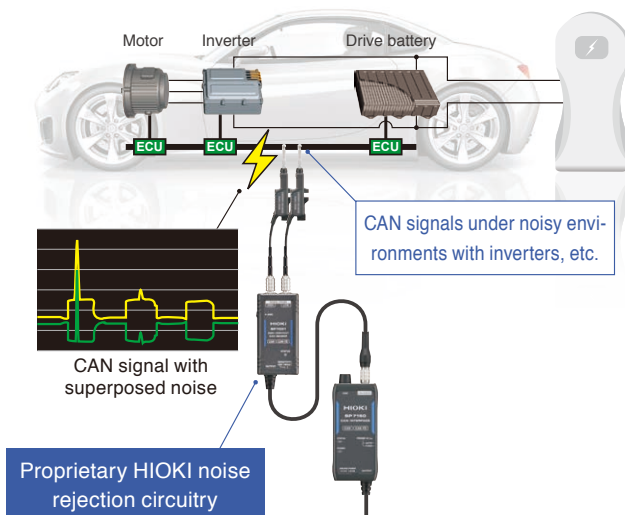

Carry out testing on public roads with peace of mind since no vehicle modifications are needed

Because it acquires signals without making electrical contact, the SP7001/SP7002 is ideal for use in tests where CAN bus insulation cannot be modified. Also apply in the development of advanced driver assistance systems (ADAS) and self-driving technology.

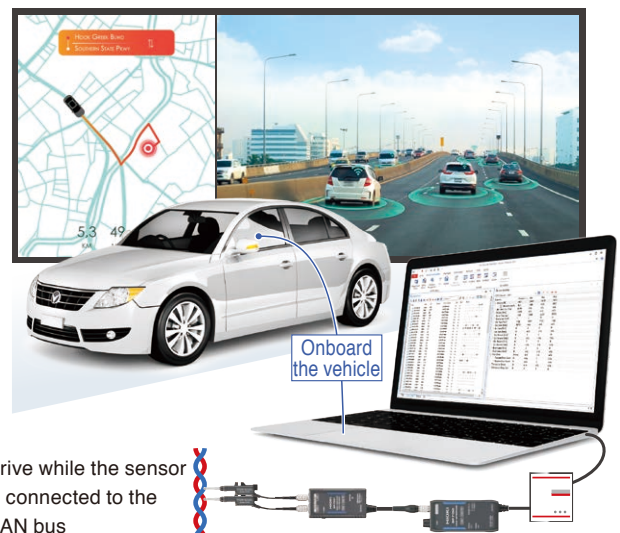

Accurate, thorough signal capture

Acquire CAN signals with the same accuracy as the contact method

The non-contact method captures CAN signals reliably and accurately, just like the contact method. In addition, with a CAN signal detection delay of just 130 ns, the sensor delivers real-time performance.

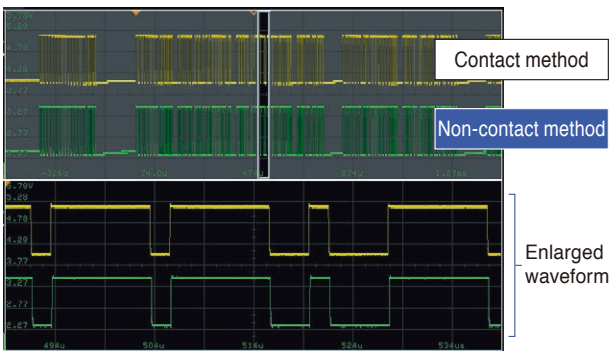

CAN waveform that's identical to one captured using the contact method

Non-contact method also excels with CAN FD high-speed signals

Unlike the contact method, the non-contact method does not distort the original signal when probing the CAN bus. This approach avoids communication errors caused by degraded communications quality.

*Model with CAN FD support: SP7001

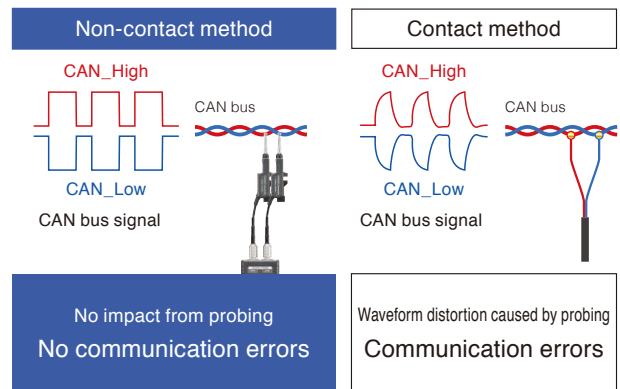

Reliably capture even infrequent events

The Non-Contact CAN Sensor does not affect the electrical characteristics of the CAN bus, allowing you to reliably catch the occasional CAN error events.

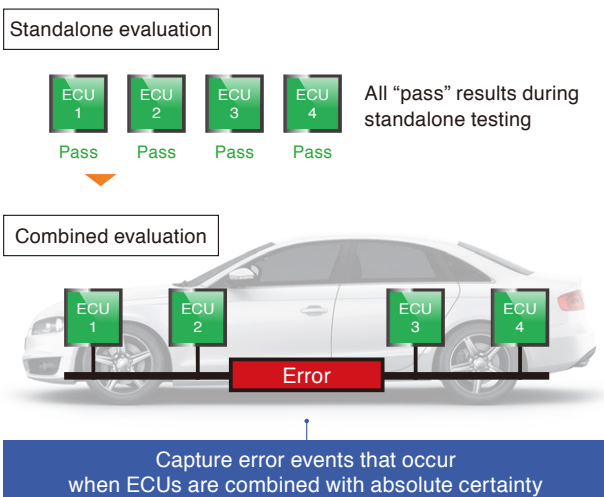

Acquire signals without needing to go through a central gateway

Only a tiny percentage of all CAN signals can be acquired from the OBD-II connector that is used in vehicle diagnostics. By using the product with the vehicle's internal CAN bus, you can acquire all CAN signals.

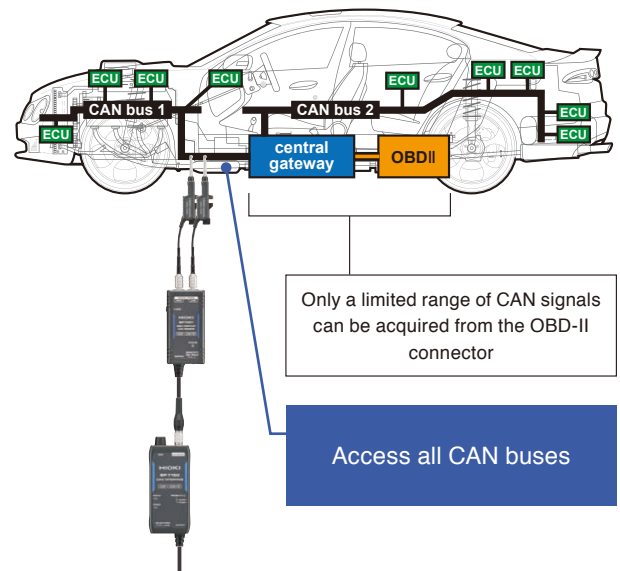

Example applications

Monitoring the vehicle CAN bus with minimal man-hours

You can acquire CAN data and analog data in a non-contact, wireless method by pairing the SP7001-95 with the LR450 family of memory HILOGGERS.

Reduce the number of man-hours required for exam preparation

- Battery life: approximately 5 hours*
*When SP7001-95 is combined with LR8535
- There is no need for a computer
- Minimal wiring with wireless units

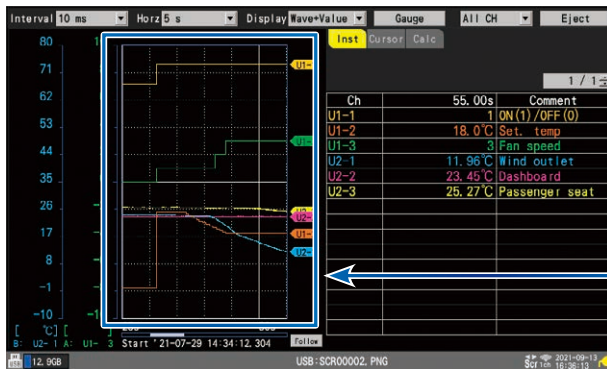
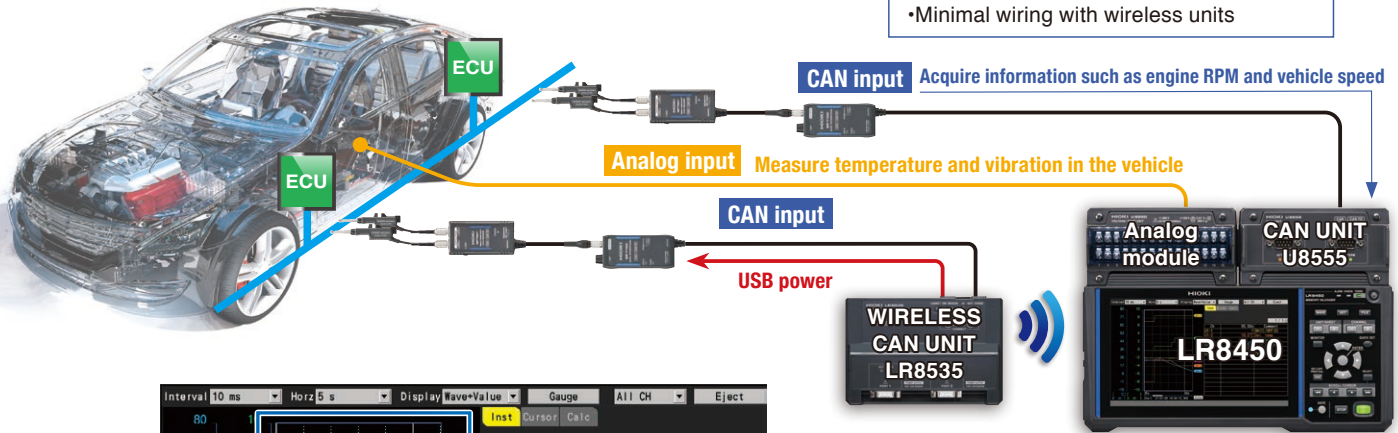

Graph CAN signal information and analog data simultaneously



The LR450 displays an analog waveform that is converted from a CAN transmission in real time. On the waveform, analog data such as voltage, temperature, strain, and information collected from the CAN bus such as vehicle Gate speed and RPM can be shown simultaneously.

Calibration task in unit and vehicle testing (example for a power control unit)

With complex systems such as power control units, in order for manufacturers to perform ECU calibration tasks, they have to monitor CAN bus data exchanged between ECUs, then assess the state of the vehicle. By using the SP7001/SP7002 with an ECU measurement and calibration tool like INCA* from ETAS in such applications, you can easily monitor CAN bus data. As a result, ECU calibration tasks can be performed more efficiently.

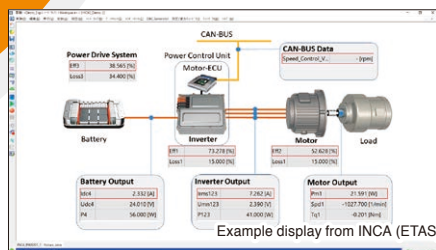
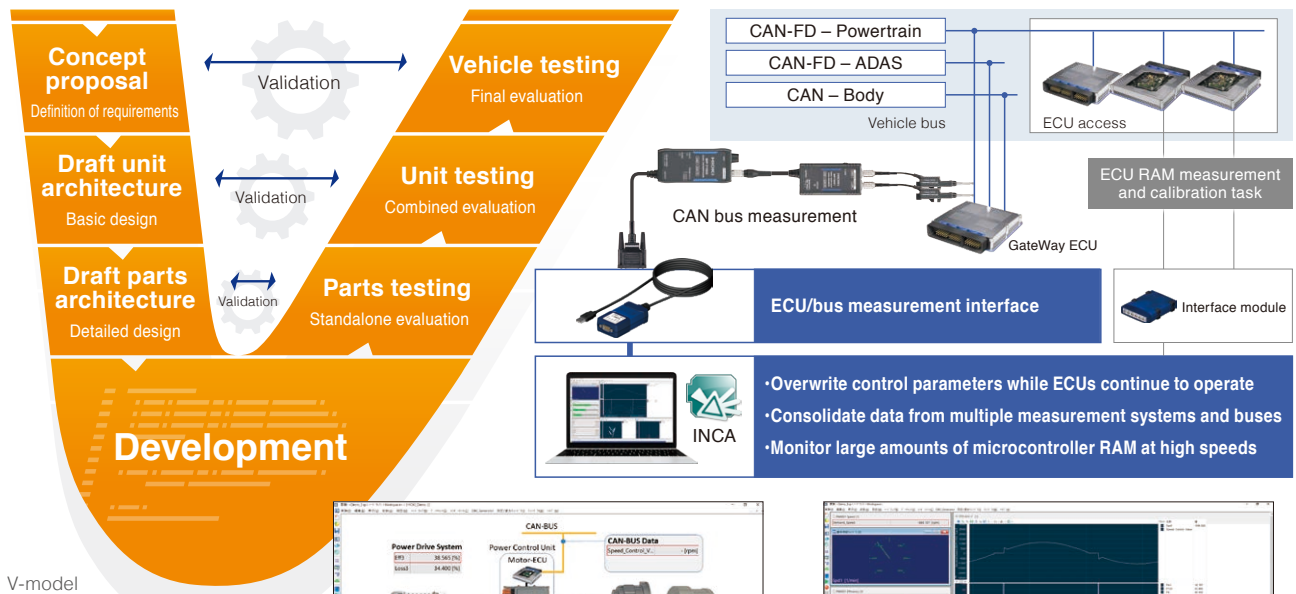

Power control unit measurement and calibration

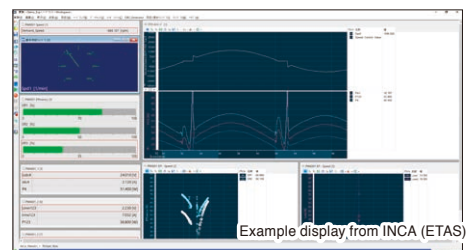

Comparison of measured values from a connected Power Analyzer PW6001, against CAN data and ECU RAM values



*INCA (from ETAS) is an ECU measurement and calibration tool that's capable of simultaneously reading and writing multiple ECU RAM values. Inquiries concerning ETAS tools should be directed to www.etas.com.

Further evolved usability

NEW SP7001-95



NEW SIGNAL PROBE
SP9250

Evolved points

One-handed, single-motion open/close of tip
Quickly hook and release the pincher for easy attachment to wires in tight or deep spaces.

NEW CAN INTERFACE
SP7150¹

Evolved points

USB power supply
Smaller body

Product video (3:54)
Includes measurement example ▶

<https://www.youtube.com/watch?v=qIhFBGU7SkM>



¹ Connect the GND cable and L9510 USB cable to the SP7150 (not shown on the pictures).

SP7001-90 SP7002-90



SIGNAL PROBE
SP9200

CAN INTERFACE
SP7100²

² Connect the GND cable and the L9500 power cable to the SP7100 (not shown on the pictures).

Specifications

| | |
|--|---|
| Detection method | Capacitive-coupled signal detection *No bare-wire connections |
| Detectable cables | AVS/AVSS-compliant cables External diameter: 1.2 to 2.0 mm (0.05 to 0.08 in) |
| Number of channels | 1 CH (SP7150), 2 CH (SP7100) |
| Compatible communications speeds | SP7001: CAN, CAN FD 125 kbit/s to 3 Mbit/s SP7002: CAN 125 kbit/s to 1 Mbit/s |
| Total delay time | 130 ns (typical) |
| CAN terminal resistance | 60 Ω (typical), built-in |
| Signal output connector | D-sub 9-pin female (CH1, CH2) |
| Operating temperature and humidity range | Temperature: -40°C to 85°C (-40°F to 185°F) Humidity: -40°C to 60°C (-40°F to 140°F), 80% RH or less (non-condensing) 60°C to 85°C (140°F to 185°F), 60% RH or less (non-condensing) |
| Storage temperature and humidity range | -40°C to 85°C (-40°F to 185°F), 80% RH or less (non-condensing) |
| Compliant standards | Safety: EN 61010, EMC: EN 61326 |
| Vibration resistance | JIS D 1601:1995 5.3 (1) Class 1: passenger cars; conditions: Class A equivalent 4h along X-axis and 2h along Y- and Z-axes at a vibration acceleration of 45 m/s ² (4.6G) |
| External dimensions and weight* | SP9250: 10.5W × 24.5H × 101D mm (0.41" × 0.96" × 3.98"D), 45 g (1.59 oz.) SP9200: φ 11.6 × 33.7H mm (φ 0.46" × 1.33"), 26 g (0.92 oz.) SP7001, SP7002: 44 W × 85H × 20D mm (1.73" × 3.35" × 0.79"D), 180 g (6.35 oz.) SP7150: 47W × 100H × 20D mm (1.85" × 3.94" × 0.79"D), 100 g (3.52 oz.) SP7100: 55W × 120H × 25D mm (2.17" × 4.72" × 0.98"D), 130 g (4.59 oz.) |
| Cable length | SP9250: 0.8 m (2.62') / SP9200: 0.5 m (1.64') SP7001, SP7002: 2.5 m (8.2') SP7150, SP7100: 0.3 m (0.98') |

| | |
|------------------|--|
| GND terminal | Banana input terminal |
| Power supply | <p>When using SP7001-95 or SP7150 USB bus power (DC 5V) Maximum rated power: 8 VA Z1013 AC Adapter Rated supply voltage: 100V to 240V AC Maximum rated power: 6 VA (including AC adapter), 1 VA (product only)</p> <p>When using SP7001-90, SP7002-90 or SP7100 Z1008 AC Adapter Rated supply voltage: 100V to 240V AC Maximum rated power: 8 VA (including AC adapter), 3 VA (product only) External power supply Rated supply voltage: 10V to 30V DC Maximum rated power: 3 VA</p> |
| Product warranty | SP7001, SP7002, SP7100, SP7150: 3 years |

CAN output connector pin assignment

| SP7150 | | SP7100 | |
|--------|------------|--------|--------------|
| Pin | Assignment | Pin | Assignment |
| 1 | N.C. | 1 | CH2 CAN Low |
| 2 | CAN Low | 2 | CH1 CAN Low |
| 3 | GND | 3 | CH1 GND |
| 4 | N.C. | 4 | N.C. |
| 5 | Shield | 5 | Shield |
| 6 | N.C. | 6 | CH2 GND |
| 7 | CAN High | 7 | CH1 CAN High |
| 8 | N.C. | 8 | CH2 CAN High |
| 9 | N.C. | 9 | N.C. |



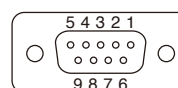

D-sub 9pin
FEMALE CONNECTOR



Basic configuration

This system requires three components: the signal probe, sensor, and CAN interface.

You can either order the set models or order the system components individually. When ordering the components, please make sure to use the specific model name of each.

| Signal probe | Sensor | CAN Interface |
|--|---|--|
|  <p>NEW SIGNAL PROBE SP9250</p>  <p>SIGNAL PROBE SP9200</p> |  <p>NON-CONTACT CAN SENSOR SP7001/SP7002</p> |  <p>NEW CAN INTERFACE SP7150 Power supply: USB bus power or Z1013</p>  <p>CAN INTERFACE SP7100 Power supply: 10 to 30 V DC or Z1008</p> |

Set model

| | | | |
|---|---|---|---|
|  <p>NEW NON-CONTACT CAN SENSOR SP7001-95 CAN FD / CAN</p> <p>set content</p> <p>SIGNAL PROBE SP9250 NON-CONTACT CAN SENSOR SP7001 CAN INTERFACE SP7150 (Includes L9510, GND cable)</p> |  <p>NON-CONTACT CAN SENSOR SP7001-90 CAN FD / CAN</p> <p>set content</p> <p>SIGNAL PROBE SP9200 NON-CONTACT CAN SENSOR SP7001 CAN INTERFACE SP7100 (Includes L9500, GND cable)</p> |  <p>NON-CONTACT CAN SENSOR SP7002-90 CAN</p> <p>set content</p> <p>SIGNAL PROBE SP9200 NON-CONTACT CAN SENSOR SP7002 CAN INTERFACE SP7100 (Includes L9500, GND cable)</p> | <p>2 CAN-bus acquisition</p>  <p>CH2 CH1</p> <p>CH1, CH2 output >>></p> <p>Add a sensor/probe to the SP7001-90, SP7002-90 or SP7100 to acquire 2 separate CAN-buses.</p> <p>Click here for more detailed combinations. </p> |
|---|---|---|---|

System components and options

| | | | | | |
|--|--|---|--|---|---|
|  <p>SIGNAL PROBE SP9250 Trigger Type, Set of 2</p> |  <p>NON-CONTACT CAN SENSOR SP7001 CAN FD/CAN support</p> |  <p>CAN INTERFACE SP7150 1 ch, USB power supply</p> <p>GND cable L9510 Includes</p> |  <p>USB CABLE L9510 USB A-C type, Power supply only</p> <p>Included with the SP7001-95, SP7150</p> |  <p>AC ADAPTER Z1013 Power can be supplied from a commercial power supply</p> <p>AC100V to 240V</p> <p>For SP7150</p> |  <p>CARRYING CASE C1013 Hard case with space for 2 channels</p> |
|  <p>SIGNAL PROBE SP9200 Screw type, Set of 2</p> |  <p>NON-CONTACT CAN SENSOR SP7002 CAN support</p> |  <p>CAN INTERFACE SP7100 2 ch, power supply +10 V to +30 V DC</p> <p>GND cable L9500 Includes</p> |  <p>POWER CABLE L9500 For supplying 10 V to 30 V DC</p> <p>Included with the SP7001-90, SP7002-90, SP7100</p> |  <p>AC ADAPTER Z1008 Power can be supplied from a commercial power supply</p> <p>AC100V to 240V</p> <p>For SP7100</p> |  <p>SPLIT CABLE SP9900 For branched CH1/CH2 output</p> |

Note: Company names and product names appearing in this brochure are trademarks or registered trademarks of various companies.

HIOKI
HIOKI E. E. CORPORATION

HEADQUARTERS
81 Koizumi,
Ueda, Nagano 386-1192 Japan
<https://www.hioki.com/>



Scan for all regional contact information

DISTRIBUTED BY