

# HIOKI

2005

## PRODUCT CATALOG

ELECTRICAL MEASURING INSTRUMENTS

[www.hioki.co.jp](http://www.hioki.co.jp)

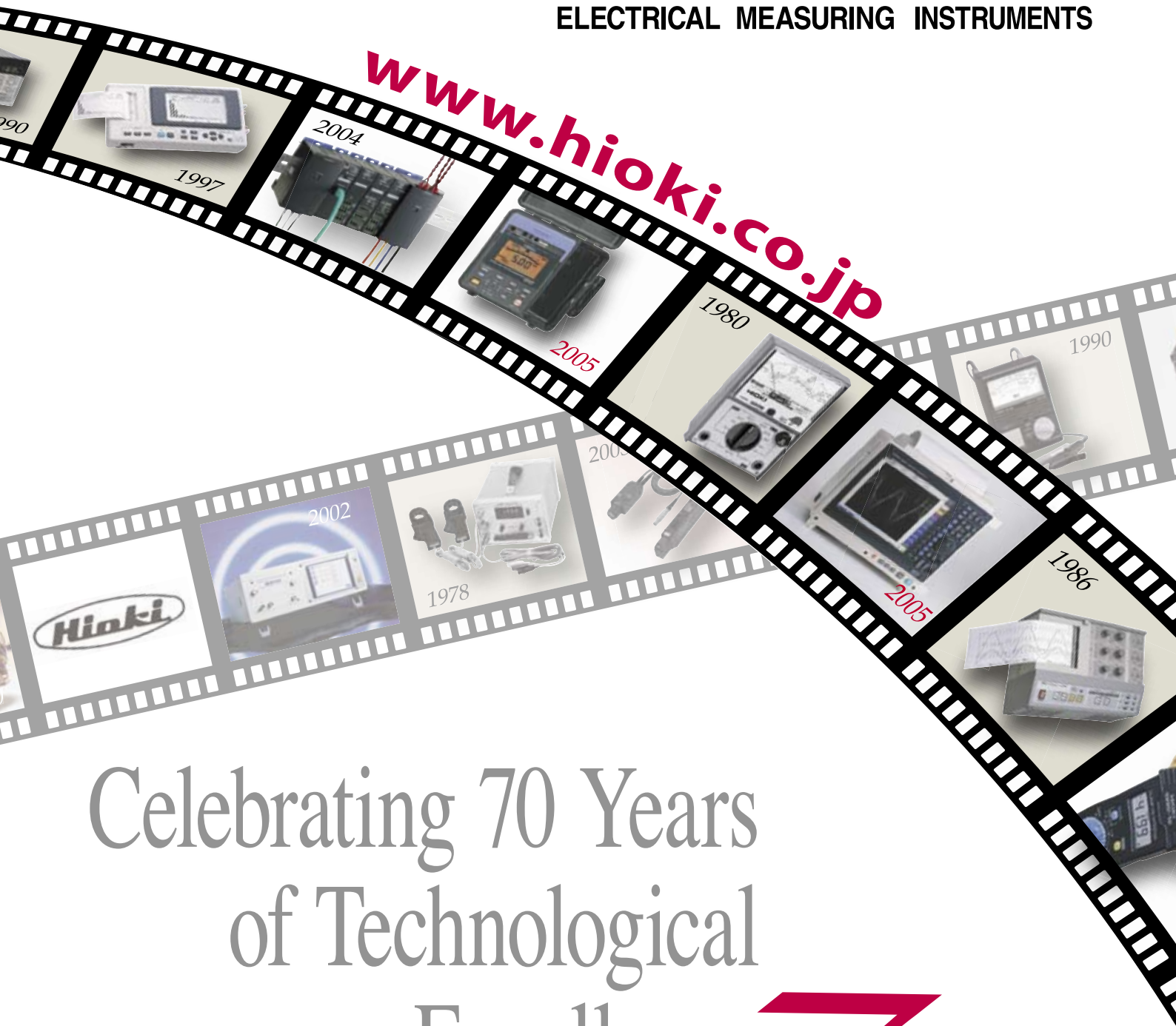

Celebrating 70 Years  
of Technological  
Excellence

**70<sup>th</sup>**  
Anniversary



ISO14001  
JQA-E-90091



ISO 9001  
JMI-0216

# About the Catalog

## Searching for product pages and notes ...

Products in this catalog are grouped according to functions so you can easily find the right instrument for your application by referring to the list of product groups in the table of contents on the first page, and moving directly to the indicated section.

### Dimensions and mass:

Exterior dimensions exclude protrusions, and are given in order of width(W), height(H), and depth(D), in mm units. Indicated weight represents an approximation of the mass of the main unit only, not including case, accessories, etc.



### ISO 14001

CERTIFICATE No. JQA-E-90091

HIOKI is certified under the international standard ISO 14001 for environmental management systems.



### ISO 9001

CERTIFICATE No. JM4-0216

HIOKI's product has been manufactured in conformity with the ISO9001 international standard on Quality Control and Quality Assurance.

## About the marks ...



New products in the 2004 Electrical Measuring Instruments PRODUCT CATALOG.



True RMS measuring capability for accurate measurement of even distorted waveforms.

**LAN** / **GP-IB** / **RS-232C** / **SCSI** / **FAX/modem** / **USB<sub>1.1</sub>**

Models are available with interfaces compatible with LAN, GP-IB, RS-232C, SCSI, FAX/modem and USB standards.

## Measurement categories (Overvoltage categories)

To ensure safe operation of measurement products, IEC 61010 establishes safety standards for various electrical environments, categorized as CAT I to CAT IV, and called measurement categories. These are defined as follows.

- CAT I** : Secondary electrical circuits connected to an AC electrical outlet through a transformer or similar device.
- CAT II** : Primary electrical circuits in equipment connected to an AC electrical outlet by a power cord (portable tools, household appliances, etc.)
- CAT III** : Primary electrical circuits of heavy equipment (fixed installations) connected directly to the distribution panel, and feeders from the distribution panel to outlets.
- CAT IV** : The circuit from the service drop to the service entrance, and to the power meter and primary overcurrent protection device (distribution panel).

Higher-numbered categories correspond to electrical environments with greater momentary energy, so a measurement product designed for **CAT III** environments can endure greater momentary energy than one designed for **CAT II**. Using a measurement product in an environment designated with a higher-numbered category than that for which the product is rated could result in a severe accident, and must be carefully avoided.

Never use a **CAT I** measuring product in **CAT II, III, or IV** environments.

The measurement categories comply with the Overvoltage Categories of the IEC60664 Standards.

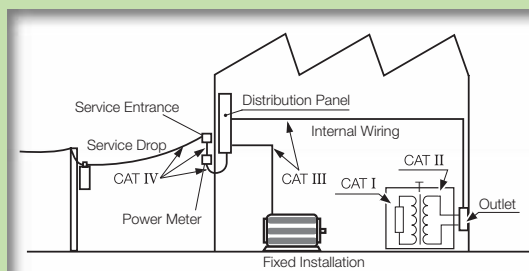

## Notes on accuracy ...

The specifications in this catalog include figures for "measurement accuracy" when referring to digital measuring instruments, and for "measurement tolerance" when referring to analog instruments.

The accuracy and tolerance figures in the product specifications are defined in terms of *full scale (f.s.) value* and *displayed reading (rdg.)* or *digit resolution (dgt.)* as described below.

**f.s.** (maximum display, or length of scale, ... full-scale)

Signifies the maximum display (scale) value or the length of the scale (in cases where the scale consists of unequal increments or where the maximum value cannot be defined). In general, this is the range value (the value written on the range selector, or equivalent) currently in use. However, be aware that in cases where the maximum display value is 2000V but the range value is only 600V, the maximum display value (scale value) is still used as the f.s. value.

**rdg.** (displayed or indicated value, ... reading value)

This signifies the value actually being measured, i.e., the value that is currently indicated or displayed by the measuring instrument.

**dgt.** (digital resolution, ... digit)

Signifies the smallest display unit on a digital measuring instrument, i.e., the value displayed when the last digit on the digital display is "1". Essentially, this indicates an error of 1 digit (based on decimal processing in analog-to-digital conversion), but in actuality this is the digit error combined with the f.s. error converted to a fraction of a digit unit. The accuracy associated with a particular measured value as shown in the product specifications is derived from these values.



### What is the CE Mark?

The CE mark certifies that a product complies with electrical safety standards established by European Community directives (EC directives). These EC directives require conformance of a product to EN/IEC standards for electrical safety.

- HIOKI's products bearing the CE Mark are designed to conform to the Low Voltage and EMC directives based on the EC directives.
- The Low Voltage directive is applicable to products operating from 50 to 1000V AC and 75 to 1500V DC, and require protection from electrical hazards such as electric shock.
- The EMC directive requires suppression of emissions of harmful electromagnetic radiation, and the ability to withstand exposure to external electromagnetic radiation without malfunction.



### WARNING



In some cases, power lines may carry voltage spikes of several times the normal supply voltage. For reasons of safety, ordinary testers should not be used to measure power lines carrying more than 250V. When measuring such power lines, always use a tester with built-in overcurrent protection to guard against short circuits, such as Model 3008 and CAT III marked products.

**Note** : An industrial power line refers to a high-capacity supply circuit to equipment in factories or offices. A high-capacity supply circuit refers generally to a line carrying 20 A or more. This does not therefore include supply lines protected by overcurrent protection (fuses) or distribution breakers.



### WARNING



1. To avoid short circuits and electric shock accidents when using a clamp-on sensor, use only with power lines carrying voltages within the rating limit of the sensor.
2. To avoid short circuits and electric shock accidents when the clamp-on sensor is open, do not use on bare conductors.

# Contents

About the Catalog ..... P.1  
 Model Index ..... P.3



**Recorders, Memory Recorders P.4 to 15**

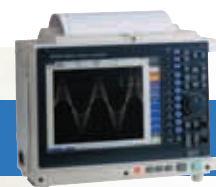

**Electronic Measuring Instruments P.16 to 26**



**Environmental Measuring Instruments P.27 to 31**



**Clamp Sensors P.32 to 34**



**Power Measuring Instruments P.35 to 39**



**Clamp Testers P.40 to 45**



**Field Measuring Instruments P.46 to 53**



**Options & Peripherals P.54 to 60**

Meter Relays ..... P.54  
 Test Leads, Test Probes ..... P.55 to P.56  
 Recording Paper, Temperature Sensors ..... P.57  
 All Accessories ..... P.58 to P.60



Service, Traceability, Calibration ..... P.61  
 Company Guide & Internet Website ..... P.62

# Model Index

## 1000 or later ...Peripherals

1195. .... p.58  
1196. .... p.58

## 2000 or later ...Meter relays

2103. .... p.54  
2104. .... p.54  
2300. .... p.28

## 7000 or later ...Signal sources

7011. .... p.26  
7016. .... p.26  
7075. .... p.26  
7075-01. .... p.26

## 3000 or later ...Multi meters, Current /Insulation /Earth /Rotation /Thermo /Illumination /Power meters

3008. .... p.46	3187. .... p.35	3280-10. .... p.42	3423. .... p.31	3540-01,-02,-03 . p.17	3662-20. .... p.50
3030-10. .... p.46	3193. .... p.39	3280-20. .... p.42	3441. .... p.30	3541. .... p.17	3663-20. .... p.50
3118-11,-12 . p.46	3194. .... p.39	3281. .... p.43	3442. .... p.30	3550. .... p.21	3801-50. .... p.48
3120. .... p.49	3196. .... p.37	3282. .... p.43	3443. .... p.30	3551. .... p.21	3802-50. .... p.46
3126-01. .... p.46	3237. .... p.22	3283. .... p.43	3444. .... p.30	3555. .... p.21	3803. .... p.48
3127-10. .... p.45	3238. .... p.22	3284. .... p.43	3445. .... p.30	3560. .... p.18	3804. .... p.46
3128-10. .... p.45	3239. .... p.22	3285. .... p.43	3446-01. .... p.27	3632-20. .... p.29	3805. .... p.46
3129. .... p.53	3244. .... p.48	3286-20. .... p.44	3447-01. .... p.27	3633-20. .... p.29	3851-10. .... p.55
3144-20. .... p.50	3245. .... p.46	3287. .... p.42	3452-11 to -15 . p.52	3634-20. .... p.29	3852. .... p.58
3151. .... p.53	3246. .... p.48	3288. .... p.42	3452-11 to -13 . p.52	3635-24,-25,-26 . p.29	3853. .... p.58
3153. .... p.23	3255-50. .... p.49	3290. .... p.45	3453. .... p.51	3636-20. .... p.29	3854. .... p.58
3154. .... p.24	3256-50,-51 . p.49	3290-10. .... p.45	3454-10 . .... p.52	3637-20. .... p.29	3909. .... p.58
3156. .... p.25	3257-50,-51 . p.49	3331. .... p.35	3454-11,-51 . p.52	3638-20. .... p.29	3911-20. .... p.29
3157-01. .... p.25	3269. .... p.33	3332. .... p.39	3501. .... p.16	3639-20. .... p.29	3912-20. .... p.29
3158. .... p.24	3270. .... p.32	3403. .... p.31	3503/3504 . p.16	3640-20. .... p.29	3930. .... p.23
3159. .... p.23	3272. .... p.33	3404. .... p.31	3511-50. .... p.18	3641-20. .... p.29	3931. .... p.24
3167. .... p.35	3273-50. .... p.33	3412-50. .... p.27	3522-50. .... p.20	3645-20. .... p.29	
3169-20,-21 . p.36	3274. .... p.33	3415-01. .... p.27	3532-50. .... p.20	3650. .... p.27	
3173. .... p.24	3275. .... p.33	3416-01. .... p.27	3535. .... p.19	3660. .... p.50	
3186. .... p.35	3276. .... p.33	3418. .... p.27	3540. .... p.17	3661-20. .... p.50	

## 8000 or later ...Recorders and Peripherals

8205-10. .... p.13	8807-01. .... p.10	8861. .... p.5	8947. .... p.7	8957. .... p.5
8206-10. .... p.13	8808-01. .... p.10	8910. .... p.13	8950. .... p.9	8958. .... p.5
8420-51. .... p.12	8807-51. .... p.10	8936. .... p.7	8951. .... p.9	8959. .... p.5
8421-51. .... p.12	8808-51. .... p.10	8937. .... p.7	8952. .... p.9	8992. .... p.10,12
8422-51. .... p.12	8826. .... p.6	8938. .... p.7	8953-10. .... p.9	8993. .... p.12
8715-01. .... p.4	8835-01. .... p.6	8939. .... p.7	8954. .... p.9	8994. .... p.9
8730-10. .... p.11	8855. .... p.9	8940. .... p.7	8955. .... p.9	8995. .... p.5
8731-10. .... p.11	8860. .... p.5	8946. .... p.7	8956. .... p.5	

## 9000 or later ...Peripherals

9005-01. .... p.32	9214. .... p.53	9318. .... p.59	9425. .... p.59	9603. .... p.39	9677. .... p.19
9010. .... p.34	9215. .... p.53	9319. .... p.59	9433. .... p.59	9604. .... p.39	9678. .... p.19
9010-10. .... p.34	9216. .... p.58	9320. .... p.8	9436. .... p.59	9605. .... p.39	9680. .... p.60
9014. .... p.55	9217. .... p.58	9320-01. .... p.8	9438. .... p.56	9612. .... p.10	9686. .... p.60
9017. .... p.55	9221. .... p.57	9321. .... p.8	9439. .... p.59	9613. .... p.60	9694. .... p.32
9018,-10 . p.34	9222. .... p.58	9321-01. .... p.9	9440. .... p.59	9614. .... p.60	9699. .... p.19
9021-01. .... p.55	9223. .... p.57	9322. .... p.8	9441. .... p.59	9615. .... p.60	9700-10. .... p.19
9032. .... p.31	9229. .... p.57	9323. .... p.59	9442. .... p.59	9617. .... p.60	9713. .... p.60
9033. .... p.31	9229-01. .... p.57	9324. .... p.8	9443-02. .... p.59	9618. .... p.60	9714. .... p.60
9050. .... p.53	9231. .... p.57	9325. .... p.8	9443-03. .... p.59	9624. .... p.37	9720. .... p.60
9060. .... p.55	9232. .... p.57	9326. .... p.56	9444. .... p.59	9624-01. .... p.37	9726. .... p.60
9067. .... p.55	9233. .... p.57	9327. .... p.9	9445-02,-03 . p.59	9625. .... p.36	9727. .... p.60
9081. .... p.58	9234. .... p.57	9328. .... p.9	9446. .... p.59	9626. .... p.60	9728. .... p.60
9084. .... p.58	9235. .... p.57	9332. .... p.14	9447. .... p.59	9627. .... p.60	ALLIGATOR CLIPS . p.60
9094. .... p.55	9236. .... p.57	9333. .... p.14	9451. .... p.59	9631. .... p.60	CT-101A . .... p.40
9132-10. .... p.32	9237. .... p.57	9334. .... p.15	9452. .... p.56	9632. .... p.60	CT-2MR . .... p.53
9140. .... p.55	9257. .... p.55	9335. .... p.15	9453. .... p.56	9633. .... p.60	CT-5MRN . .... p.53
9143. .... p.55	9261. .... p.55	9338-9340 . p.59	9454. .... p.18	9634. .... p.60	HB-1 . .... p.53
9148. .... p.58	9262. .... p.55	9344-9349 . p.59	9455. .... p.56	9635-9636 . p.44	HS-1 . .... p.53
9151-02. .... p.58	9263. .... p.55	9351. .... p.59	9458. .... p.37	9637-9638 . p.60	HS-2 . .... p.53
9151-04. .... p.58	9267. .... p.23	9355. .... p.59	9459. .... p.37	9639. .... p.60	220H . .... p.12
9165. .... p.58	9268. .... p.55	9360. .... p.59	9460. .... p.56	9641. .... p.12	
9168. .... p.55	9269. .... p.55	9363-9365 . p.59	9461. .... p.56	9642. .... p.12	
9170. .... p.55	9270. .... p.32	9371. .... p.59	9462. .... p.59	9643. .... p.12	
9177. .... p.55	9271. .... p.32	9372. .... p.59	9463-9464 . p.59	9645-01. .... p.9	
9178. .... p.55	9272. .... p.32	9375. .... p.59	9465. .... p.56	9646. .... p.9	
9180 to 83 . p.57	9274. .... p.32	9376. .... p.59	9466. .... p.56	9648. .... p.12	
9184. .... p.57	9276. .... p.32	9377. .... p.59	9467. .... p.56	9649. .... p.12	
9185. .... p.55	9277. .... p.34	9378. .... p.59	9472-9479 . p.57	9650. .... p.32	
9188. .... p.57	9278. .... p.34	9380. .... p.59	9517. .... p.59	9651. .... p.32	
9190. .... p.55	9279. .... p.34	9382. .... p.59	9518-01. .... p.20	9652. .... p.12	
9195. .... p.55	9287-10. .... p.56	9384. .... p.59	9540-01. .... p.59	9653. .... p.12	
9196. .... p.55	9288. .... p.56	9386. .... p.59	9549. .... p.9	9657. .... p.29	
9197. .... p.55	9290-10. .... p.32	9388. .... p.59	9555. .... p.34	9657-10. .... p.32	
9198. .... p.55	9292. .... p.56	9390. .... p.59	9557. .... p.59	9658. .... p.29	
9199. .... p.8	9293. .... p.56	9391. .... p.59	9558. .... p.59	9660-9661 . p.32	
9203. .... p.16	9294. .... p.56	9392. .... p.59	9588. .... p.60	9667. .... p.32	
9207-10. .... p.55	9296. .... p.56	9393. .... p.59	9593-01. .... p.20	9668. .... p.32	
9208. .... p.55	9297. .... p.56	9397. .... p.59	9598. .... p.60	9669. .... p.32	
9209. .... p.42	9299. .... p.56	9398. .... p.59	9599. .... p.60	9663. .... p.9	
9211. .... p.31	9303. .... p.12	9399. .... p.59	9600. .... p.39	9670. .... p.37	
9212. .... p.31	9305. .... p.59	9418-10,-15 . p.59	9601. .... p.39	9671. .... p.37	
9213. .... p.31	9315. .... p.59	9420. .... p.59	9602. .... p.39	9675. .... p.32	

# Recorders, Memory Recorders



## Recorders, Memory Recorders Index

### Handy units for service and maintenance recording

 <p><b>8205-10</b>    €€ Recorder (1ch) 100 sampling/sec. No memory ..... p.13</p>	 <p><b>8807-01</b>    €€ 400 kS/sec.(2 ch) 256 kW (1 ch) memory 12 bits A/D resolution Battery operation ..... p.10</p>	 <p><b>8808-01</b>    €€ 400 kS/sec.(4 ch) 256 kW (1 ch) memory 12 bits A/D resolution Battery operation ..... p.10</p>	 <p><b>8835-01</b>    €€ 1 MS/sec.(8 ch) 4 MW (1 ch) memory 12 bits A/D resolution ..... p.6</p>	 <p><b>8420-51/8421-51</b>    €€ Data logger (8 ch,16 ch) 100 ms to 1h interval 16 MW internal memory 16 bits A/D resolution Battery operation ..... p.12</p>	 <p><b>8422-51</b>    €€ Data logger (32 ch) 100 ms to 1h interval 16 MW internal memory 16 bits A/D resolution Battery operation ..... p.12</p>
---	--	--	---	--	---

### For simultaneous recording of multiple signals

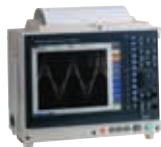
 <p><b>8826</b>    €€ 1 MS/sec. (32 ch) 4 MW (1 ch) memory (expandable up to four) 12 bits A/D resolution ..... p.6</p>	 <p><b>8860</b>    €€ 20 MS/sec. (12 bits 8 ch) 2 MS/sec. (16 bits 8 ch) 50 ms/all ch (16 bits 64 ch) 32 MW up to 1GW memory ..... p.5</p>	 <p><b>8861</b>    €€ 20 MS/sec. (12 bits 16 ch) 2 MS/sec. (16 bits 16 ch) 50 ms/all ch (16 bits 128 ch) 64 MW up to 2GW memory ..... p.5</p>	<p><b>WAVE COMPARATOR</b></p>  <p><b>8730-10/8731-10</b>    €€ Geared for the Production line 8730-10: 1ch input 8731-10: 2ch input ..... p.11</p>
---	--	---	--

### For waveform capture of high-speed signals

 <p><b>8855</b>    €€ 8 channels 20 MS/sec.(8 ch) Max. 512 MW memory 12 bits A/D resolution (16 bits A/D 1 MS/sec.) ..... p.9</p>
--

### Options for MEMORY HiCORDER series

 <p>..... p.5,7,8,14,15</p>	 <p><b>8910</b>    €€ CAN ADAPTER ..... p.13</p>
---	---

### For power line fault monitoring

 <p><b>8206-10</b>    €€ Recorder for power lines 100 sampling/sec.(2 ch) AC voltage and current No memory ..... p.13</p>	 <p><b>8715-01</b>    €€ Recorder for power lines 400 kS/sec.(4 ch) 64 kW/ch memory 12 bits A/D resolution Battery operation</p>	 <p><b>8807-51</b>    €€ Harmonic analysis 400 kS/sec (2 ch) 256 kW (1 ch)Memory 12 bits A/D resolution ..... p.10</p>	 <p><b>8808-51</b>    €€ Harmonic analysis 400 kS/sec (4 ch) 256 kW (1 ch)Memory 12 bits A/D resolution ..... p.10</p>
--	---	---	---

Recorders, Memory Recorders

# 8860 | 8861 | MEMORY HiCORDER

**HIOKI's Next Generation Recorder**  
**High Performance Isolated Oscilloscope and Data Logger**  
**All in One Complete Instrument**



- High and Low Speed Dual Sampling - High speed at 20MS/s (with 8956 input unit)
- Maximum 128 channels (8861) or 64 channels (8860) of data logging
- Large capacity memory, LAN/USB and other popular PC interfaces standard
- Intuitive operation using GUI/mouse/keyboard



**LAN**  
STANDARD

**USB<sub>1.1</sub>**  
STANDARD

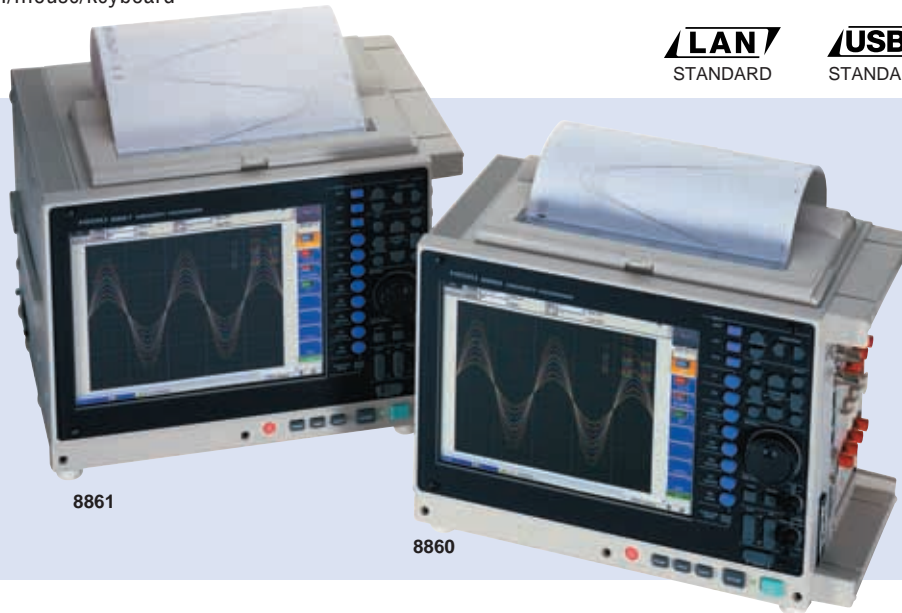

8861

8860

Recorders, Memory Recorders

**SPECIFICATIONS**

<b>Measurement ranges</b> <small>using 8956 ANALOG UNIT /option</small>	5 mV to 20 V/division, 12 ranges (20 division f.s.), resolution: 1/100 of range
<b>Frequency band</b>	DC to 10 MHz ±3 dB (using 8956 ANALOG UNIT /option)
<b>Time axis at memory function</b>	5µs to 5 minutes/division, 26 settings; external sampling (100 samples/division, desired setting)
<b>Measurement functions</b>	Memory, Recorder, Recorder & Memory (Version 2.00 or later), FFT (Version 2.00 or later)
<b>Number of input channels</b>	8860: Analog (up to 8 channels) + logic (16 channels standard) or Logger Input (up to 64 channels) 8861: Analog (up to 16 channels) + logic (16 channels standard) or Logger Input (up to 128 channels)
<b>Memory capacity</b>	8860: 32 M words/9715×1 (Total 1 GW, 9715-03 (×1)) 8861: 64 M words/9715×2 (Total 2 GW, 9715-03 (×2))
<b>Data storage</b>	Floppy disk drive (optional, USB), Type II PC card slot, MO drive (optional), Hard disk drive (optional)
<b>Interfaces</b>	USB1.1, LAN
<b>Recording and display</b>	10.4-inch TFT color LCD, 216 mm × 30 mm, thermal paper roll
<b>Other functions</b>	Scaling, Vernier function, cursor measurement, comment insertion, other functions
<b>Power supply</b>	100 to 240 V AC (50/60 Hz)
<b>Dimensions, mass (base unit only)</b>	8860: 330 mmW×250 mmH×184.5 mmD, 8.0 kg 8861: 330 mmW×250 mmH×284.5 mmD, 10.5 kg
<b>Accessories</b>	Power cord (1), input cord label (1), Application disk (1)

\*One MEMORY BOARD is required in Model 8860, and two MEMORY BOARDS of the same capacity is required in Model 8861



**Input modules**

- 8956 ANALOG UNIT
- 8957 HIGH RESOLUTION UNIT
- 8958 16ch SCANNER UNIT
- 8959 DC/RMS UNIT
- 8936 ANALOG UNIT
- 8937 VOLTAGE/TEMP UNIT
- 8938 FFT ANALOG UNIT
- 8939 STRAIN UNIT
- 8940 F/V UNIT
- 8946 4ch ANALOG UNIT
- 8947 CHARGE UNIT

**OPTIONS**

(The 8860 or 8861 cannot be used alone. Measurement requires optional input unit or similar peripheral.)

**●Options (Factory fitted)**

- |  |                          |
|--|--------------------------|
| 8995 A4 PRINTER UNIT                       | 9717 MO UNIT             |
| 9715-01,-02,-03 MEMORY BOARD(32MW to 1GW)* | 9718 HD UNIT             |
| 9716 FD UNIT                               | 9719 MEMORY BACK UP UNIT |

**●Options**

- |   |                                     |
|---|-------------------------------------|
| 9197 CONNECTION CORD (500V Max.)        | 9724 CARRYING CASE (for 8861)       |
| 9198 CONNECTION CORD (300V Max.)        | 9642 LAN CABLE                      |
| 9217 CONNECTION CORD (BNC-BNC)          | 9626 PC CARD 32MB                   |
| 9231 RECORDING PAPER (30m, 6rolls/1set) | 9627 PC CARD 64MB                   |
| 9322 DIFFERENTIAL PROBE                 | 9726 PC CARD 128MB                  |
| 9327 LOGIC PROBE                        | 9727 PC CARD 256MB                  |
| 9320-01 LOGIC PROBE                     | 9728 PC CARD 512MB                  |
| 9321-01 LOGIC PROBE                     | CLAMP ON SENSORs (refer to p.32-34) |
| 9723 CARRYING CASE (for 8860)           | Other common options (refer to p.8) |

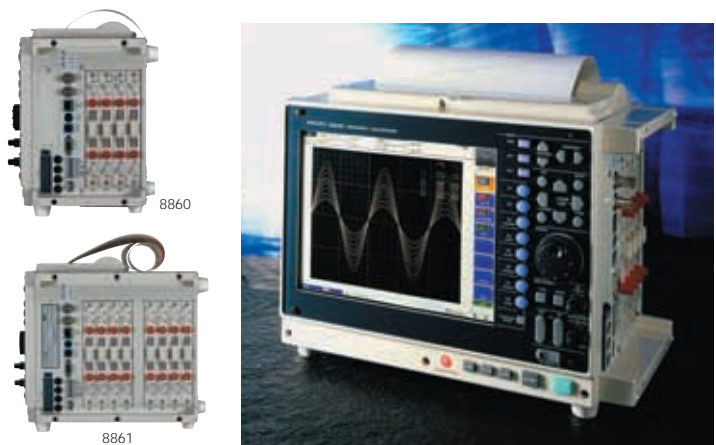

## 8835-01 MEMORY HiCORDER

High-visibility, Compact, Multi-channelled Field measurement has never been easier

- Compact 4/8 ch recorder saves space with slim profile
- 110mm-width recording paper and a large color display(6.4-inch)
- Maximum 8 analog channels and 16 logic
- Network Recording Instrument for LAN

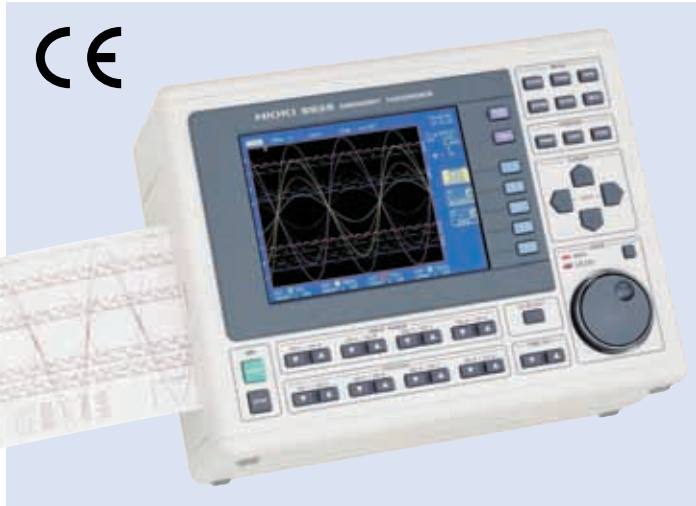

**LAN** OPTION    **GP-IB** OPTION    **RS-232C** OPTION

SPECIFICATIONS	
Measurement ranges using 8936 ANALOG UNIT /option	10mV to 50V/division, 12 ranges (10 division f.s.) resolution; 1/160 of range
Frequency band	DC to 400kHz, ±3dB
Time axis at memory function	100µs to 5 minutes/division, 20 ranges (1division =100samples)
Functions	Memory recorder, Recorder, RMS recorder (50/60Hz or DC only), *Recorder and Memory, *FFT
Number of input channels using 8936, 8946 ANALOG UNIT /option	4 analog channels plus 16 logic channels (using 8936) 8 analog channels plus 16 logic channels (using 8946)
Memory capacity	12bits- 4M words/channel (using 1 channel)
Data storage	FDD- 1, Type-III PC card- 1; 9626/9627/9726/9727/9728 PC CARD
Interfaces	LAN, GP-IB, or RS-232C (option, using PC card)
Recording and display	110mm- 30 m, roll type thermal paper, Recording speed: 25mm/s, 6.4-inch color TFT LCD
Other functions	Scaling, Waveform parameter calculations, Memory segmentation, Cursor readout, etc.
Power supply	100 to 120V AC or 200 to 240V AC (50/60 Hz) * 10 to 28V DC, using the 9439 DC POWER ADAPTER
Dimensions, mass	285W- 220H- 132D mm, 4.5kg
Accessories	Power cord(1), Recording paper(1 roll), Dust cover(1), PC card protector(1), Application disk(1)



### OPTIONS

(The 8835-01 cannot be used alone. Measurement requires optional input unit or similar peripheral.)

- 9221 RECORDING PAPER (30 m, 10 rolls /1 set)
- 9333 LAN COMMUNICATOR
- 9335 WAVE PROCESSOR
- 9388 CARRYING CASE
- 9439 DC POWER ADAPTER (using between 10 to 28 V DC)
- 9540-01 FUNCTION UP DISK (to enhance the 8835-01)
- 9151-02/04 GP-IB CONNECTION CABLE (2m /4m)
- CLAMP ON SENSORS (refer to p.32 - 34)
- Other common options (refer to p.8)

\*Note: An input cord is not supplied with the input unit. Requires the 9197 or 9198

## 8826 MEMORY HiCORDER

32-channel recorder with all isolated inputs

- Simultaneous sampling, display and recording of all 32 analog and 32 logic channels
- Large capacity memory of max. 16M-word Memory expandable four times (option)
- High resolution of 12-bit, 1 M-sampling /second
- B4-size (paper width 264 mm) wide printer
- High-visibility waveforms displayed on a 10.4-inch color TFT liquid crystal display

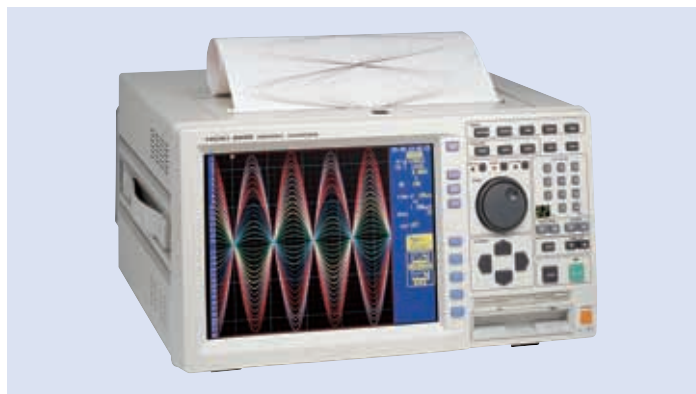

**LAN** OPTION    **SCSI** STANDARD    **GP-IB** OPTION    **RS-232C** OPTION

SPECIFICATIONS	
Measurement ranges	5 mV to 20 V/division, 12 ranges (normal f.s.; 20 division, wide f.s.; 24 division), resolution: 1/80 of range
Frequency band	DC to 400 kHz, ±3dB
Time axis at memory function	100µs to 5 minutes/division, 20 ranges (1 division =100 samples)
Functions	Memory recorder, Recorder (included X-Y), RMS recorder, Recorder and Memory, FFT
Number of input channels	32 analog channels plus 32 logic channels
Memory capacity	(analog 12 bits)- 4M words/channel (using 4ch) * Expandable up to four, using 9599 MEMORY BOARD
Data storage	FDD- 1, Type-III PC card- 1; SRAM, flash ATA, 9626/9627/9726/9727/9728 PC CARD
Recording and display	264 mm- 30 m, roll type thermal paper, Recording speed: 25 mm/s, 10.4-inch color TFT LCD
Other functions	Scaling, Waveform judgment, Waveform processing calculations, Waveform parameter calculations, Memory segmentation, Logging print, Clock, Cursor readout, Comment entry, etc.
Power supply	100 to 240 V AC, 50/60 Hz
Dimensions, mass	401W- 235H- 382D mm, 11 kg (excluding input units)
Accessories	Power cord(1), Recording paper(1 roll), Dust cover(1), PC card protector(1), Application disk(1)

### OPTIONS

(The 8826 cannot be used alone. Measurement requires optional input cord or similar peripheral.)

- 9229 RECORDING PAPER (30 m, 6 rolls /1 set)
- 9229-01 RECORDING PAPER (perforated)
- 9598 MO UNIT...factory fitted only
- 9599 MEMORY BOARD (48 M words)
- 9151-02/04 GP-IB CONNECTION CABLE (2 m /4 m)
- CLAMP ON SENSORS (refer to p.32 - 34)
- Other common options (refer to p.8)

\*Note: An input cord is not supplied with the input unit. Requires the 9197 or 9198

# INPUT Units for 8835-01, 8841, 8842, 8860, 8861

## Dimensions and mass:

Approx. 170W × 20H × 148D mm, approx. 290g



8936, 8938

### 8936 ANALOG UNIT

<b>Input</b>	Number of channels: 2, Connector: Insulated BNC * Input isolated from output, inter-channel isolation
<b>Measurement range</b>	5mV to 20V/division, 12 ranges, full-scale (f.s.) = 20 divisions, AC voltage for possible measurement/display using the memory function: 280V rms, Low-pass filter, 5/500/5k/100kHz, the measurement resolution is 1/80 of range * When used with 8841, 8842
<b>Maximum sampling rate</b>	1 MS/s (simultaneous sampling of two channels)
<b>Accuracy</b>	DC amplitude: ±0.4% f.s. Zero-position: ±0.1% f.s.
<b>Zero-position</b>	-50% to 150%, 1% step * With zero-adjustment function
<b>Frequency characteristics</b>	DC to 400kHz ±3 dB, with AC coupling: 7Hz to 400kHz ±3dB
<b>Input resistance and capacitance</b>	1MΩ, 30 pF approx. (at C 100kHz)
<b>Input coupling</b>	DC, GND, AC
<b>Max. allowable input</b>	400V DC (upper voltage which when applied to between input pins does not damage them)
<b>Max. grounding voltage</b>	370V AC, DC (upper voltage which when applied to input channel casing or between input channels does not damage them)
<b>Accessories</b>	None * Input cord optional

### 8938 FFT ANALOG UNIT

<b>Anti-aliasing filter</b>	Cutoff frequency 20, 40, 80, 200, 400, 800, 2k, 4k, 8k, 20k, 40kHz auto-select (linked to frequency range)
<b>Other functions</b>	Same as the <b>8936 ANALOG UNIT</b>
<b>Accessories</b>	None * Input cord optional

## Dimensions and mass:

Approx. 170W × 20H × 148D mm, approx. 300g



8937

### 8937 VOLTAGE/TEMPERATURE UNIT

<b>Inputs</b>	Number of channels: 2 each for voltage and temperature * Input isolated from output, inter-channel isolation Voltage input: isolated BNC, thermocouple input: plug-in terminal
<b>Voltage measurement range</b>	500μV to 2V/division; 12 settings, full-scale (f.s.) = 20 divisions, low-pass filter: 5/500/5k/100kHz, the measurement resolution is 1/80 of range * When used with 8841, 8842
<b>Temperature measurement range</b>	10°C to 100°C/division; 4 settings, full-scale (f.s.) = 20 divisions, low-pass filter: 5/500Hz, measurement resolution: 1/80 of range * When used with 8841, 8842
<b>Thermocouple range</b>	K: -200 to 1350°C, E: -200 to 800°C, J: -200 to 110°C, T: -200 to 400°C, N: -200 to 1300°C, R: 0 to 1700°C, S: 0 to 1700°C, B: 300 to 1800°C, Reference junction compensation: internal/ external (switchable)
<b>Max. sampling rate</b>	Voltage input: 1 MS/s, Temperature measurement: 4Ks/s (2-channel simultaneous sampling)
<b>Accuracy</b>	Voltage input: DC amplitude ±0.4% of f.s. Zero-position ±0.15% of f.s. Temperature measurement (K, E, J, T, N): ±0.1% of f.s. ±1°C, ±0.1% of f.s. ±2°C (-200 to 0°C), (R, S): ±0.1% of f.s. ±3°C, (B): ±0.1% of f.s. ±4°C (400 to 1800°C) Reference junction compensation accuracy: ±0.1% f.s. ±1.5°C (internal compensation)
<b>Zero position</b>	Voltage input: -50% to 150%, 1% steps * With zero-adjust function Temperature measurement: -100% to 100%, 1% steps
<b>Frequency characteristics</b>	Voltage input: DC to 400kHz + 1/-3dB Temperature measurement: DC to 1 kHz + 1/-3dB
<b>Input resistance and capacitance</b>	Voltage input: 1 MΩ, 50pF approx. (at C 100 kHz) Temperature measurement: 5.1MΩ
<b>Input coupling</b>	DC, GND, AC
<b>Max. allowable input</b>	30V rms or 60V DC (upper voltage which when applied to between input pins does not damage them)
<b>Max. grounding voltage</b>	30V rms or 60V DC (upper voltage which when applied to input channel casing or between input channels does not damage them)
<b>Accessories</b>	None * Input cord optional

## Dimensions and mass:

Approx. 170W × 20H × 148D mm, approx. 250g



8939

### 8939 STRAIN UNIT

<b>Inputs</b>	Number of channels: 2, Connector: Adapter cable connector * Input isolated from output, inter-channel isolation
<b>Converter connector</b>	Via adapter cable, TAJIMI PRC03-32A10-7M10.5
<b>Suitable converter</b>	Strain gage converter, bridge impedance: 120Ω to 1kΩ, gage factor 2.00, bridge voltage 2 ±0.05 V
<b>Measurement range</b>	20μe to 1000μe/division; 6 settings, full-scale (f.s.) = 20 divisions, low-pass filter: 10 Hz, 30 Hz, 300 Hz, 3 kHz, OFF the measurement resolution is 1/80 of range * Using 8841, 8842, 8720
<b>Maximum sampling rate</b>	1 MS/s (simultaneous sampling for 2 channels)
<b>Accuracy (after auto-balancing)</b>	DC amplitude: ±(0.5% f.s. + 2μe) Zero-position: ±0.5% f.s.
<b>Balancing</b>	Electronic auto-balancing, max. adjustment range ±10000μe
<b>Zero position</b>	-50% to 150%; in 1% steps * With auto-balancing
<b>Frequency characteristics</b>	DC to 20 kHz +1/-3 dB
<b>Max. allowable input</b>	10 V (DC + AC peak) (upper voltage which when applied to between input pins does not damage them)
<b>Max. grounding voltage</b>	30 V rms or 60 V DC (upper voltage which when applied to input channel casing or between input channels does not damage them)
<b>Accessories</b>	Conversion cable (2), PRC 03-12A10-7M 10.5(2)

9318



**9318 CONVERSION CABLE**  
(to connect the clamp-on sensor to the 8940)  
**9319 CONVERSION CABLE**  
(to connect the 3273 to the 8940)

## Dimensions and mass:

Approx. 170W × 20H × 148D mm, approx. 300g



8940

### 8940 F/V UNIT

<b>Input</b>	Number of channels: 2*1, Voltage input: BNC terminal *1 Input isolated from output, inter-channel isolation
<b>Sensor connector terminal</b>	Number of channels: 2 (for current measurement)*2 *2 Models that allow unit insertion up to a total of 4 channels: 8841, 8842, 8720
<b>Compatible current sensors</b>	<b>9270, 9271, 9272, 9277, 9278, 9279, 3273, 3273-50</b>
<b>Measurement range</b>	Frequency: 0.05Hz to 5kHz/division, 11 ranges, 5(r/min) to 500(r/min)/division, 5 ranges, P50 Hz (40 to 60 Hz), P60 Hz (50 to 70 Hz) Integration: 5 counts to 500 k counts/division, Pulse duty ratio: 100% f.s. Current: 5 mA to 100 A/division, 10 ranges, linked to use with type of the clamp-on sensor, Voltage: 0.5 mV to 2 V/division, 12 ranges, Max. allowable input: 30 V rms or 60 V DC, full-scale (f.s.) = 20 divisions, low-pass filter, 5/500/5k/100kHz or OFF, the measurement resolution is 1/80*3 of range *3 When used with 8841, 8842, and when used with 9279 CLAMP ON SENSOR, the resolution is 1/64 of range
<b>Max. sampling period</b>	1μs (voltage, current)
<b>Other functions</b>	Voltage input pull-up: ON (10kΩ)/ OFF Input coupling: DC, GND, AC (voltage, current), DC (others)
<b>Max. grounding voltage</b>	30V rms or 60V DC (upper voltage which when applied to input channel casing or between input channels does not damage them)
<b>Accessories</b>	None * Input cord and conversion cable optional

## Dimensions and mass:

Approx. 170W × 20H × 148D mm, approx. 310g



8946

### 8946 4ch ANALOG UNIT

<b>Inputs</b>	Number of channels: 4, Terminal: Metallic BNC * Input isolated from output, inter-channel isolation
<b>Measurement range</b>	10 mV to 2 V/division, 8 ranges, full-scale (f.s.) = 20 divisions, low-pass filter, 5/500/5k/50 kHz; the measurement resolution is 1/80 of range * When used in 8841
<b>Maximum sampling rate</b>	1 MS/s (simultaneous sampling of four channels)
<b>Accuracy</b>	DC amplitude: ±0.5% f.s. Zero-position: ±0.15% f.s.
<b>Zero-position</b>	-50% to 150%, 1% step * With zero-adjustment function
<b>Frequency characteristics</b>	DC to 100 kHz ±3 dB
<b>Input resistance and capacitance</b>	1 MΩ, 15 pF approx. (at C 100 kHz)
<b>Input coupling</b>	DC, GND
<b>Max. allowable input</b>	30 V rms or 60 V DC (upper voltage which when applied to between input pins does not damage them)
<b>Max. grounding voltage</b>	30 V rms or 60 V DC (upper voltage which when applied to input channel casing or between input channels does not damage them)
<b>Accessories</b>	None * Input cord optional

## Dimensions and mass:

Approx. 170W × 20H × 148D mm, approx. 310g



8947

### 8947 CHARGE UNIT

<b>Input</b>	Number of channels: 2 Measurement objects can be selected individually for each channel. Full isolation between inputs, and between inputs and recorder. Common GND for voltage input and charge input channels. Voltage and pre-amplifier internal inputs: BNC terminals (With voltage input: input resistance, 1MΩ; input capacitance, less than 200 pF) Charge input: miniature connector (#10-32 UNF)
<b>Suitable converters</b>	Charge input: piezoelectric charge output acceleration pickup sensors, Internal pre-amplifier input: acceleration pickup sensors with built-in pre-amplifier
<b>Measurement ranges</b>	50m (m/s <sup>2</sup> )/DIV to 10 k (m/s <sup>2</sup> )/DIV, 12 ranges: 6 types, the measurement resolution is 1/80 to 1/32 of range (changes according to measurement sensitivity) Measurement sensitivity: 0.1 to 10pC / (m/s <sup>2</sup> ), Pre-amplifier internal input measurement sensitivity: 0.1 to 10mV / (m/s <sup>2</sup> ), Amplitude accuracy: ±2% f.s., Frequency characteristics: 1 to 50 kHz +1/-3 dB, Low-pass filter: 500 / 5kHz, Pre-amplifier driving power supply: 2mA ±20%, +15V ±5%, Highest input charge: ±500pC (high sensitivity side 6 ranges), ±50000 pC (low sensitivity side 6 ranges)
<b>Measurement ranges</b>	500μV to 2V/DIV, 12 ranges, the measurement resolution is 1/80 to 1/32 of range (changes according to measurement sensitivity) Voltage input (BNC terminal) DC amplitude accuracy: ±0.4% f.s., Frequency characteristics: DC to 400kHz +1/-3 dB, Low-pass filter: 5 / 500 / 5k/ 100kHz, Input coupling: DC, AC, GND, Max. allowable input: 30V rms or 60V DC
<b>Maximum sampling rate</b>	1 MS/s (simultaneous sampling of two channels)
<b>Max. grounding voltage</b>	30V rms or 60V DC (upper voltage which when applied to input channel casing or between input channels does not damage them)
<b>Accessories</b>	None * Input cord optional



# Common options for 8800 series MEMORY HiCORDER

\*Designated products are not CE-Mark compliant

Note: Product names appearing herein are trademarks or registered trademarks of the various companies.

### Logic Signal Measurement



9321 (9321-01)  
**LOGIC PROBE**

4-channel isolated, on/off detection of AC/DC voltage

9320 (9320-01)  
**LOGIC PROBE**

4-channels, on/off detection of voltage/contact signal

### Storage Media



9626 PC CARD 32 MB  
9627 PC CARD 64 MB  
9726 PC CARD 128 MB  
9727 PC CARD 256 MB  
9728 PC CARD 512 MB

9231 RECORDING PAPER  
30 m / 98.43 feet, 6 rolls / 1 set

### PC Communication



9557 RS-232C CARD  
(compliance with the PCMCIA Standard)

9558 GP-IB CARD  
(compliance with the PCMCIA Standard) \* With a GP-IB cable, cord length : 2m (6.6 feet)

9333 LAN COMMUNICATOR  
software required to use LAN connection with Windows 95/ 98/ Me, WindowsNT 4.0 / XP



LAN CARD (HIOKI-tested)  
(compliance with the PCMCIA Standard)  
Manufactured by third parties.

9335 WAVE PROCESSOR

software required to convert the binary file to CSV text file, to remote control with Windows 95/ 98/ NT 4.0 /Me/ 2000/ XP



Instrument

9608 MEMORY BOARD  
Expands instrument memory by 4x  
Must specify when ordering: not user installable.  
(8841, 42 only)



9607 MO UNIT  
Installs on the bottom of the instrument. Must specify when ordering: not user installable.  
(8841, 42 only)

### Case



9397-01 CARRYING CASE  
(for 8841 and 8855)  
9349 CARRYING CASE  
(for 8842 only)  
with casters for convenient transportation.

### DC Power Supply



9433 DC POWER ADAPTER  
Supplies operating power in the range 10 to 28 V DC.  
(8841 and 8842)

### Input Modules



Various input modules  
Install by inserting into the instrument  
Can be replaced by user  
8936 ANALOG UNIT  
8937 VOLTAGE/TEMPERATURE UNIT  
8938 FFT ANALOG UNIT  
8939 STRAIN UNIT  
8940 F/V UNIT  
8946 4ch ANALOG UNIT  
8947 CHARGE UNIT

### High-voltage input

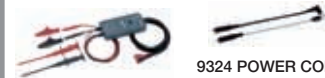

9322 DIFFERENTIAL PROBE  
for up to 2kV DC, 1 kV AC



9324 POWER CORD  
for logic terminal  
9325 POWER CORD  
for 8940 sensor terminal



9197 CONNECTION CORD  
for high voltage (up to 500V)



9198 CONNECTION CORD  
for low voltage (up to 300V)

### Current Measurement, other options



9018-10 CLAMP ON PROBE  
Input from 10 to 500 A  
40 Hz to 3 kHz for 0.2 V AC output. BNC terminal



\*9132-10 CLAMP ON PROBE  
Input from 20 to 1000 A  
40 Hz to 1 kHz for 0.2 V AC output. BNC terminal



\*9270 CLAMP ON SENSOR  
Enables observation of distorted AC current waveforms. Input: up to 20 A, 5 to 50 kHz for 2 VAC out  
\*9271 CLAMP ON SENSOR  
Enables observation of distorted AC current waveforms. Input: up to 200 A, 5 to 50 kHz for 2 VAC out  
\*9272 CLAMP ON SENSOR  
Enables observation of distorted AC current waveforms. Input selectable 20/200 A, 5 to 10 kHz for 2 VAC out

Note : Can only be used in combination with the 9555 SENSOR UNIT or 8940 F/V UNIT.  
9318 CONVERSION CABLE  
Connects 9270 to 9272, 9277 to 9279 clamp-on sensors to 8940 F/V UNIT.



9277 UNIVERSAL CLAMP ON CT  
Observe waveforms from DC to distorted AC. Input up to 200 A, DC to 100 kHz for 2 VAC out  
9278 UNIVERSAL CLAMP ON CT  
Observe waveforms from DC to distorted AC. Input up to 200 A, DC to 100 kHz for 2 VAC out  
\*9279 UNIVERSAL CLAMP ON CT  
Observe waveforms from DC to distorted AC. Input up to 500 A, DC to 20 kHz for 2 VAC out

Note : Can only be used in combination with the 9555 SENSOR UNIT or 8940 F/V UNIT.  
\*9555 SENSOR UNIT  
Used together with 9270 to 9272, 9277 to 9279 clamp-on sensors. Power supply unit.



\*9303 PT  
Insulation transformer. 400 V or 200 V AC input, 10 V AC output, for AC power line measurement.



\*220H PAPER WINDER  
Paper width 70 (2.75") - 220 (8.66") mm



3269/3272 POWER SUPPLY



9319 CONVERSION CABLE  
Connects 3273, 3273-50 to 8940 F/V UNIT.



9217 CONNECTION CORD  
Insulation BNC-to-insulation BNC, use to connect to insulation-BNC terminal on Input Module



\*9165 CONNECTION CORD  
Metal BNC-to-metal BNC, use to connect to metal-BNC terminal on Input Module

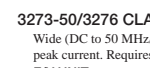

3273-50/3276 CLAMP ON PROBE  
Wide (DC to 50 MHz/100 MHz) range, mA-level to 15 A peak current. Requires power from 3272 or 3269 or 8940 F/V UNIT.

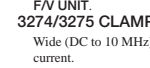

3274/3275 CLAMP ON PROBE  
Wide (DC to 10 MHz) range, mA-level to 500 A rms current. Requires power from 3272 or 3269 only and requires scaling operations

# 8855 MEMORY HiCORDER

8ch high-speed isolated inputs of 20MS/s, Max.  
512 M words long storage memory

- Maximum 8 analog channels and 16 logic channels
- 20MS/s, 8ch 12-bit high-speed isolated Input (8950/8951/8952)
- 1MS/s, 8ch 16-bit HIGH RESOLUTION Input (8953-10)
- Max. 512 M words long storage memory
- Zoom and scroll functions providing enlarged and compressed displays
- Standard LAN/SCSI interface

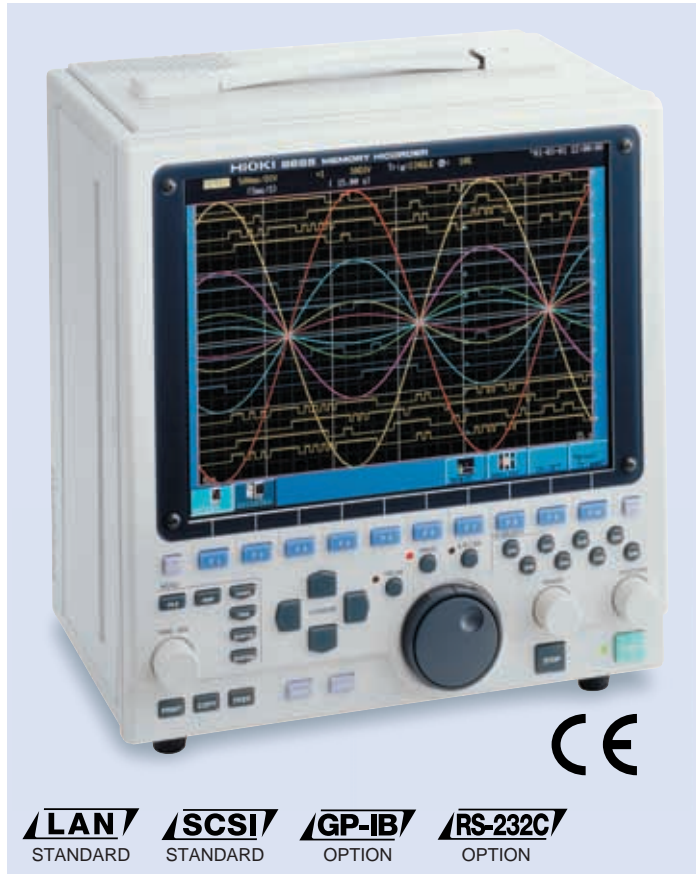

Recorders, Memory Recorders

SPECIFICATIONS	
Measurement ranges using 8950 ANALOG UNIT /option	5 mV to 20 V/division, 12 ranges (20 division f.s.) resolution: 1/100 of range
Frequency band	DC to 10 MHz $\pm$ 3dB Sampling speed max.20MS/s
Time axis at memory function	5 $\mu$ s to 5 minutes/division, 24 ranges (1 division =100 samples)
Functions	Memory, Recorder (Rec & Memory, FFT/function in ver.2.00 or later)
Number of input channels	8 analog channels plus 16 logic channels (analog inputs are isolated up to 370V)
Memory capacity	4M words/channel (Total 32MW) Max.64M words/channel (Total 512MW)(Option)
Data storage	FDD- 1, Type-II PC card- 1; 9626-9728 PC CARD (MO or HDD- 1/option)
Interfaces	LAN, SCSI, GP-IB or RS-232C (Option, use PC card)
Display and recording	10.4 inch TFT color LCD (option; 216mm $\times$ 30m, roll type thermal paper)
Other functions	Scaling, Waveform judgment, Waveform processing calculations, Waveform parameter calculations, Memory segmentation, Waveform zoom display, Clock, Cursor readout, Comment entry, etc.
Power supply	100 to 240V AC 50/60 Hz Max. 180VA
Dimensions, mass	275W $\times$ 285H $\times$ 170D mm, 6.3kg
Accessories	Power cord(1), PC card protector(1) Input cord label(1), Application disk(1)

## OPTIONS

(The 8855 cannot be used alone. Measurement requires optional input unit or similar peripheral.)

### Options (Factory fitted)

- 8994 PRINTER UNIT
- 9645 MEMORY BOARD (96MW)
- 9645-01 MEMORY BOARD (512MW)
- 9646 MO UNIT (1.3GB/640MB~128MB)
- 9663 HD UNIT (20GB)

### Options

- 8950 ANALOG UNIT
- 8951 VOLTAGE/CURRENT UNIT
- 8952 DC/RMS UNIT
- 8953-10 HIGH RESOLUTION UNIT
- 8954 VOLTAGE/TEMP UNIT
- 8955 F/V UNIT
- 9197 CONNECTION CORD (500V Max.)
- 9198 CONNECTION CORD (300V Max.)
- 9217 CONNECTION CORD (BNC-BNC)
- 9231 RECORDING PAPER (30m, 6 rolls /1set)
- 9322 DIFFERENTIAL PROBE
- 9328 POWER CORD (for 8950/8953-9322)
- 9327 LOGIC PROBE
- 9321-01 LOGIC PROBE
- 9333 LAN COMMUNICATOR
- 9335 WAVE PROCESSOR

- 9397-01 CARRYING CASE
- 9557 RS-232C CARD
- 9558 GP-IB CARD
- 9549 FUNCTION UP DISK
- 9642 LAN CABLE
- 9626 PC CARD 32 MB
- 9627 PC CARD 64 MB
- 9726 PC CARD 128 MB
- 9727 PC CARD 256 MB
- 9728 PC CARD 512 MB
- CLAMP ON SENSORs (refer to p.32-34)
- Other common options (refer to p.8)

- LAN** STANDARD
- SCSI** STANDARD
- GP-IB** OPTION
- RS-232C** OPTION



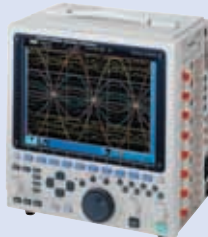

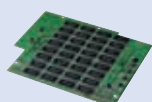

**9646 MO UNIT**  
Specify upon order, cannot be installed by user.



**9645 MEMORY BOARD**  
(total 128 megawords)  
Expands instrument memory by 4 times its original size. Specify upon order, factory installation only.



**9645-01 MEMORY BOARD**  
(total 512 megawords)  
Expands instrument memory by 16 times its original size. Specify upon order, factory installation only.



**9663 HD UNIT**  
Specify upon order; factory installation only. (20 GB)  
*Note: The MO and HDD UNITS cannot be mounted on the unit at the same time.*

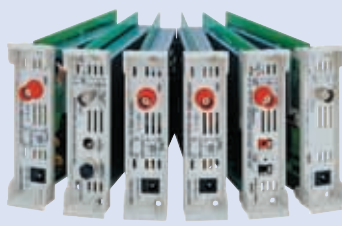

**Input modules**  
Install or replace simply by inserting the module into the base unit  
*Note: Input cords are not provided. Please purchase the appropriate input cord for the probe type and application separately.*

- 8950 ANALOG UNIT
- 8951 VOLTAGE/CURRENT UNIT
- 8952 DC/RMS UNIT
- 8953-10 HIGH RESOLUTION UNIT
- 8954 VOLTAGE/TEMP UNIT
- 8955 F/V UNIT

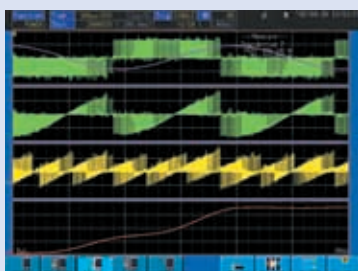

**9549 FUNCTION UP DISK**  
Voltage, current, and power waveforms on the secondary side of an inverter  
  
By installing the power monitor function in the 8855 MEMORY HiCORDER, you can monitor power transient waveforms and view power trend graphs. Use of this function requires the optional 9549 FUNCTION UP DISK, which is sold separately



**Logic input**

**9327 LOGIC PROBE**  
4 channels, ON/OFF detection of voltage/contact signals (high-speed type for use with the 8855)



**9321-01 LOGIC PROBE**  
4 isolated channels, ON/OFF detection of AC/DC voltage (small terminal-type for use with the 8855, 8807-01, and 8808-01)



**9323 ADAPTER CABLE**  
(Terminal conversion cable for connecting the all-purpose 9321 LOGIC PROBE and the 8855 when terminals do not match.)

## 8807-01 | 8808-01 | MEMORY HiCORDER

### New concept incorporating detachable printer, B5-sized handy recorder

- B5 book-sized, compact, and handy high-speed recorders
- 2 analog channels (8807-01) 4 analog channels (8808-01) isolated inputs (with 8 logic)
- PC card slot, 3-way power supply, and powerful trigger functions
- Fax/modem communication function (9332)

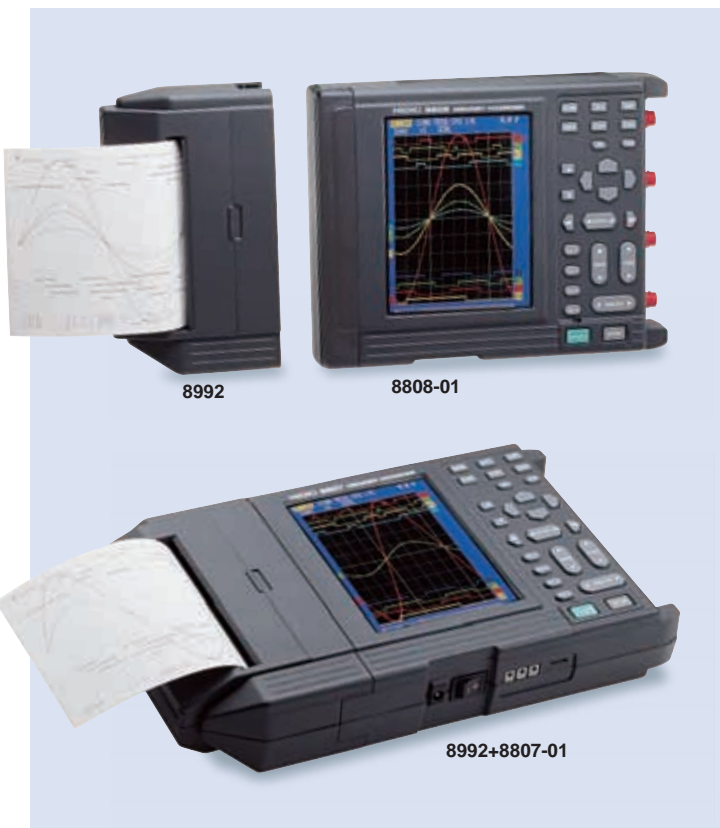

#### SPECIFICATIONS

Measurement ranges	10 mV to 100 V*/division, 13 ranges (10 division f.s.), resolution: 1/160 of range, *1 100 V/division excludes the RMS & memory recorder functions
Frequency band	DC to 50 kHz, ±3 dB
Time axis at memory function	200→s to 5 minutes/division, 19 ranges (1 division =80 samples)
Functions	Memory recorder, Recorder, RMS & memory recorder (50/60 Hz or DC only)
Number of input channels	8807-01: fixed input section, 2 analog*2 +8 logic 8808-01: fixed input section, 4 analog*2 +8 logic *2 analog inputs are isolated up to 450V
Memory capacity	(analog 12 bits+ logic 4 bits): 256 k words*/channel * using CH1
Data storage	PCMCIA Type-II PC card · 1 9626-9728 PC CARD
Interfaces	RS-232C, Printer (8992 PRINTER UNIT can be connected)
Recording and display	112 mm· 18 mm, roll type thermal paper, Recording speed: 10 mm/s (using AC adapter), 5 mm/s (using batteries), 5.7-inch STN color LCD
Power supply	9418-15 AC ADAPTER, LR6 (AA) · 6 (Continuous use 1 hour, LR6 batteries cannot be used with 8992 PRINTER UNIT), 9447 BATTERY PACK (Continuous use 3 hours)
Dimensions, mass	203W· 170H· 52D mm (printer detached) 280W· 170H· 52D mm (printer attached) 8807-01: 1.1 kg (printer detached), 1.5 kg (printer attached) 8808-01: 1.2 kg (printer detached), 1.6 kg (printer attached)
Accessories	LR6 (AA) Alkaline batteries(6), Alkaline battery box(1), Shoulder belt(1), Application disk(1)

#### OPTIONS

(The 8807-01 & 8808-01 cannot be used alone. Measurement requires optional INPUT CORD or similar peripheral.)

- 8992 PRINTER UNIT (print size 100 mm width)
- 9234 RECORDING PAPER (18m, 10 rolls /1 set)
- 9320-01 LOGIC PROBE (refer to p.8)
- 9321-01 LOGIC PROBE (refer to p.8)
- 9323 CONVERSION CABLE
- 9391 CARRYING CASE
- 9418-15 AC ADAPTER (universal 100 to 240VAC, 12VDC/2.5A output)
- 9447 BATTERY PACK (7.2V, 2400 mAh, recharging with the 9418-15)
- 9612 RS-232C CABLE (mini DIN 9-pin to Dsub 9-pin, 1.5 m)
- CLAMP ON SENSORS (refer to p.32~34)
- 9332 WAVE COMMUNICATOR
- 9335 WAVE PROCESSOR
- 9643 CHARGE STAND
- Other common options (refer to p.8)

\*Note: An input cord is not supplied with the 8807-01 & 8808-01. Requires the 9197 or 9198

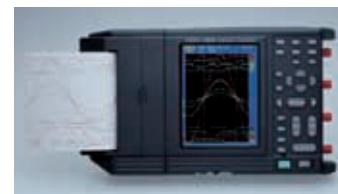

## 8807-51 | 8808-51 | MEMORY HiCORDER

### Instantaneous Analysis and Long-term Recording of Harmonic Waves for Maintenance of Commercial Power Systems

#### Instantaneous harmonic analysis

- Measure harmonics up to 40 orders from the fundamental wave
- Analysis display includes RMS value, content factor, phase angle, active power, and power phase angle for each order of harmonics (numeric and graphic display)
- Analysis display of total RMS value, total distortion, active/reactive/apparent power, and power factor (numeric display)
- Bar graph and numeric data display
- Power phase angle can be displayed as a vector

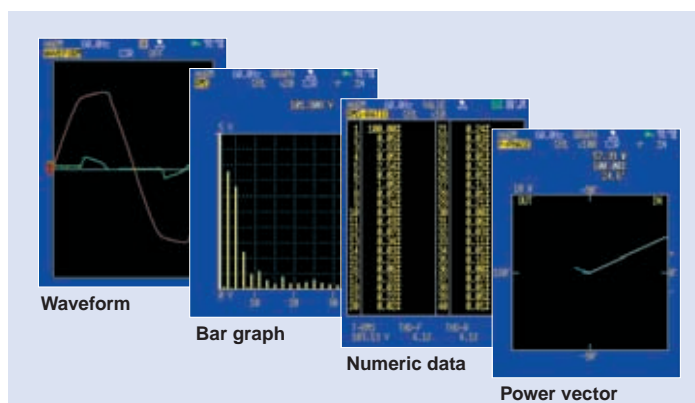

# 8730-10 | 8731-10 | WAVE COMPARATOR

## A MEMORY HiCORDER geared for the production line

- Easy installation into production lines for high speed measurement and assessment
- Compare the signals of manufactured components and devices with a memorized reference signal to conduct PASS/FAIL evaluations on a waveform level
- 8730-10: 1ch input/comparison 8731-10: 2ch input/2ch simultaneous comparison
- Connect to a PC via LAN for networking capabilities

### SPECIFICATIONS

Measurement ranges	100 mV to 5 V/division, 6 ranges (10 division f.s.) resolution: 1/160 of range
Frequency characteristic	DC to 400 kHz ±3 dB
Number of input channels	8730-10: Analog 1 channel 8731-10: Analog 2 channels
Memory capacity	12bits·50 k words/ch
Time axis	100µs to 5 minutes/division, 20 settings (1 division =100 samples) external sampling (up to 1 kHz, minimum sampling period 1 ms)
Measurement functions	Memory recorder with Wave Comparator
Data storage	PC card Type II slot
Interfaces	RS-232C LAN (10BASE-T) External I/O
Display	7.2-inch STN color LCD
Power supply	100 to 240 V AC (50/60 Hz)
Dimensions, mass	8730-10:288W·144H·190D mm, 3.6kg 8731-10:288W·144H·190D mm, 3.7kg
Accessories	Power cord(1), Application disk(1)

### OPTIONS

9333 LAN COMMUNICATOR	9726 PC CARD 128M
9335 WAVE PROCESSOR	9727 PC CARD 256M
9626 PC CARD 32M	9728 PC CARD 512M
9627 PC CARD 64M	

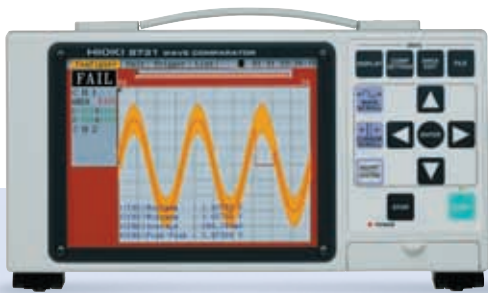

Rack-mount the 8730-10 or 8731-10 on existing facilities.



Set up the instruments on the Control Box.



Bring the unit to the local testing site for ultimate portability and convenience.

## 8420-51 | 21-51 | 22-51 | MEMORY HILOGGER

**All analog inputs fully isolated!**  
**Voltage/temperature loggers with PC networking support**

- 8420-51(8ch), 8421-51(16ch), 8422-51(32ch) All analog channels isolated.
- Temperature, voltage, humidity, cumulative pulses, rotations
- Max. 32-channel, 100ms high-speed multi-channel data collection
- Simultaneous numerical and graphical display
- Attachable Printer and I/O Module
- Up to 16 HiLOGGERS can be connected and controlled via LAN.



8421-51



Recorders, Memory Recorders

### 8420-51/8421-51 SPECIFICATIONS

<b>Input Channels</b>	8420-51: Analog 8 channels isolated by Photo-MOS relays 8421-51: Analog 16 channels isolated by Photo-MOS relays Pulse Inputs 4ch, Logic Inputs 16ch (using the 8993)
<b>Measurement objects</b>	Thermocouple : K,E,J,T,N,W(WRe5-26),R,S,and B Platinum measurement resistance type : Pt-100 JPt-100 Analog voltage input : 100mV,1V,10V,100V and 1-5V f.s.
<b>Recording interval</b>	100ms to 1hour (5 sec. to 1 hour for humidity measurement)
<b>A/D resolution</b>	16 bits
<b>Memory capacity</b>	Internal : 16MW DRAM (32MB) External : 9626-9728 PC CARD
<b>Interfaces</b>	RS-232C, LAN (10Base-T Ethernet connectors) Printer (8992), DIGITAL I/O UNIT (8993)
<b>Display and Recording</b>	5.7-inch STN color LCD, 8992 Printer (Option) 112 mm· 18 m, roll type thermal paper, Recording speed: 2 mm/s
<b>Function</b>	Waveform compression and magnification, Event search, Waveform scroll, cursor measurement, scaling, automatic save, start condition retention, setting save, comment entry, automatic set up, numerical calculation
<b>Power supply</b>	9418-15 AC ADAPTER, 9447 BATTERY PACK
<b>Dimensions, mass</b>	234W· 170H· 52D mm 1.4kg (instrument only) 310W· 170H· 52D mm 1.7kg (with printer ) 302W· 170H· 52D mm 1.7kg (with Digital I/O Unit )
<b>Accessories</b>	9418-15 AC ADAPTER(1), Terminal Cover(1), Screwdriver(1), Application disk(1)

### 8422-51 SPECIFICATIONS

<b>Input Channels</b>	8422-51: Analog 32 channels isolated by Photo-MOS relays Pulse Inputs 4ch, Logic Inputs 16ch (using the 8993)
<b>Measurement objects</b>	Thermocouple : K,E,J,T,N,W(WRe5-26),R,S,and B Analog voltage input : 100mV,1V,10V,100V and 1-5V f.s.
<b>Recording interval</b>	100ms to 1hour (16ch) (200 ms to 1 hour)
<b>A/D resolution</b>	16 bits
<b>Memory capacity</b>	Internal : 16MW DRAM (32MB) External : 9626-9728 PC CARD
<b>Interfaces</b>	RS-232C, LAN (10Base-T Ethernet connectors) Printer (8992), DIGITAL I/O UNIT (8993)
<b>Display and Recording</b>	5.7-inch STN color LCD, 8992 Printer (Option) 112 mm· 18 m, roll type thermal paper, Recording speed: 2 mm/s
<b>Function</b>	Waveform compression and magnification, Event search, Waveform scroll, cursor measurement, scaling, automatic save, start condition retention, setting save, comment entry, automatic set up, numerical calculation
<b>Power supply</b>	9418-15 AC ADAPTER, 9447 BATTERY PACK
<b>Dimensions, mass</b>	234W· 170H· 52D mm 1.4kg (instrument only) 310W· 170H· 52D mm 1.7kg (with printer ) 302W· 170H· 52D mm 1.7kg (with Digital I/O Unit )
<b>Accessories</b>	9418-15 AC ADAPTER(1), Terminal Cover(1), Screwdriver(1), Application disk(1)

### OPTIONS

- |   |   |
|---|---|
| 8992 PRINTER UNIT (print size 100 mm width)                     | 9641 CONNECTION CORD                          |
| 8993 DIGITAL I/O UNIT   | 9642 LAN CABLE                                |
| 9234 RECORDING PAPER (18m, 10 rolls /1 set)                     | 9643 CHARGE STAND                             |
| 9334 LOGGER COMMUNICATOR  | 9648 CARRYING CASE                            |
| 9418-15 AC ADAPTER(100 to 240 V AC, 12 V DC/2.5 A output)       | 9649 PROTECTIVE CASE (Basic water-resistance) |
| 9447 BATTERY PACK(7.2 V, 2400 mAh, recharging with the 9418-15) | 9652-01 FIXED STAND                           |
| 9612 RS-232C CABLE(mini DIN 9-pin to Dsub 9-pin, 1.5 m)         | 9681 HUMIDITY SENSOR                          |
| 9721 RS-232C CABLE(mini DIN 9-pin to Dsub 9-pin, 1.5 m)         | 9329 TERMINAL UNIT                            |

\*Note: An input cord is not supplied with the 8420-51, 8421-51 & 8422-51



# 8910 CAN ADAPTER

## Record and Analyze CAN-Bus Signals

- Select CAN-Bus information arbitrarily from recorder or data logger and convert them into analog/logic signals
- Up to 12ch analog output + 24bit logic output
- Record both CAN adapter analog output and actual analog data (i.e. sensor output) simultaneously
- Choose desired data from a PC or Memory HiCORDER

SPECIFICATIONS			
Input	CAN-Bus interface 2-channel (Receive only)		
Number of output channels	Up to 12 analog channels and 6 logic channels - 24bit		
Output resolution	16bit		
Output voltage	-5 to 5V (Analog), 0 to 5V (Logic)		
Response speed	Can follow up to a 1ms CAN-Bus refresh rate (1kS/sec max.)		
Interface	RS-232C (For data selection settings only)		
Functions	<table border="1"> <tr> <td>Function specifications</td> <td>                     (1) Settings of CAN-Bus defined data (Various parameter settings to capture required data from CAN-Bus)                      (2) CAN-Bus signal input port settings                      (3) Output channel settings (Settings to determine output channels for captured data), etc.                 </td> </tr> </table>	Function specifications	(1) Settings of CAN-Bus defined data (Various parameter settings to capture required data from CAN-Bus) (2) CAN-Bus signal input port settings (3) Output channel settings (Settings to determine output channels for captured data), etc.
Function specifications	(1) Settings of CAN-Bus defined data (Various parameter settings to capture required data from CAN-Bus) (2) CAN-Bus signal input port settings (3) Output channel settings (Settings to determine output channels for captured data), etc.		

Functions	Setting Methods	(1) From the 8910 Setting Software (standardly equipped), Items (1), (2) and (3) above can be set. (2) From Memory HiCORDERs (Models 8826, 8841 and 8842) and the 8910 Main Unit, Item (3) above can be set via the RS-232C interface or external recording media (FD, PC card and MO)
Power supply		(1) AC adapter (100 to 240Vac universal, 12V/2.5A dc output) (2) 10 to 30VDC (Can be supplied from a cigarette lighter socket in an automobile.) (3) Supplied from CAN-Bus signal input connector (10 to 30VDC)
Dimension and Mass		180W· 50H· 100D mm, 940g
Accessories		AC Adapter (1), RS-232C Cable (1), 9713-01 CAN Cable (1), CD-R (including 8910 Setting Software)

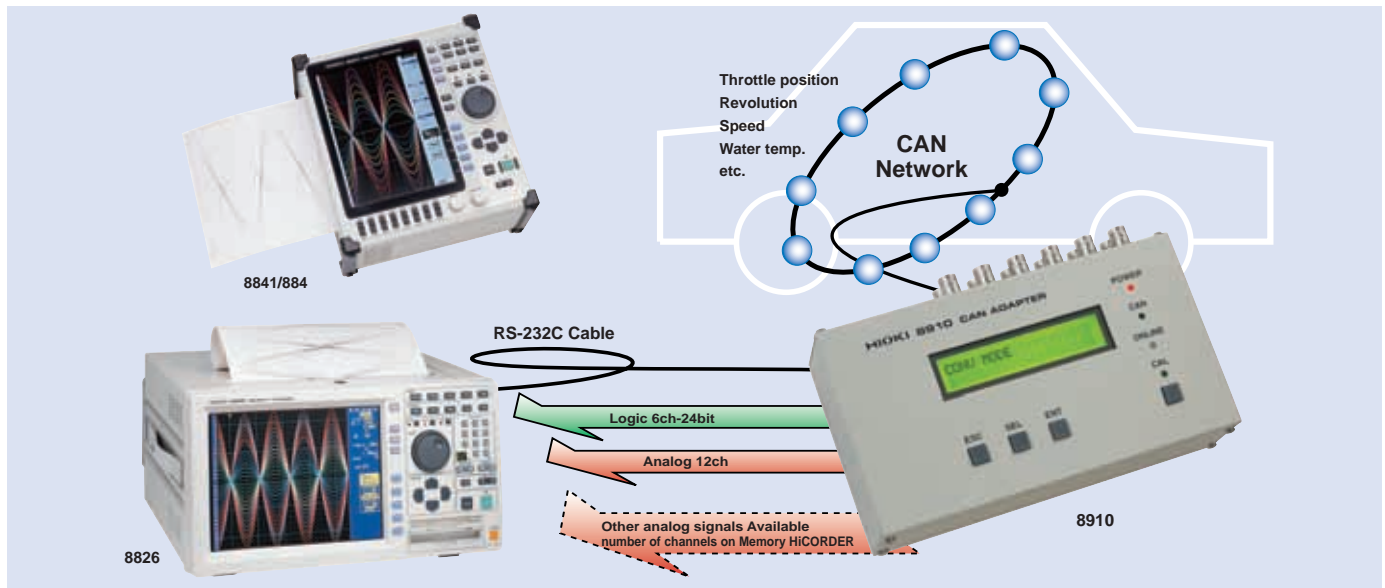

# 8205-10 | 8206-10 MICRO HiCORDER

Easy data recording as convenient as a simple tester, yet with broad functionality

- Record voltage and current variations simply with full line-up of optional clamp on sensors of up to 1000A
- Input levels can be monitored on the LCD like an analog display
- Built-in thermal printer for printing data such as time and amplitude axis



8205-10: SPECIFICATIONS	
Measurement ranges	DC / AC Voltage: 0.1V to 500V f.s. 12 ranges AC Current: 10A to 1000A f.s. 7 ranges (using CLAMP ON SENSOR / option)
Sampling period	10ms
Frequency band	20Hz to 30kHz, ±3 dB
Paper feed speed	20cm/minute to 2cm/hour, 5 ranges
Number of input channels	Voltage or Current, 1 channel
Accuracy	Voltage: ±2% f.s. Current: ±4% f.s. (using 9651 CLAMP ON SENSOR / option)
Power supply	100 to 240V AC (50/60 Hz) or 9.5 to 14V DC, 2 way
Dimensions, mass	250W· 122H· 93.5D mm, 1.2 kg
Accessories	Power cord(1), Recording paper(1 roll), 9257 CONNECTION CORD(1), 9344 CARRYING CASE(1)

8206-10: SPECIFICATIONS	
Measurement ranges	AC Voltage: 100/ 200/ 500 V extended scale, 3 ranges AC Current: 10A to 1000A f.s. 7 ranges (using CLAMP ON SENSOR / option)
Sampling period	10 ms
Frequency band	30Hz to 30kHz, ±3dB
Paper feed speed	60 cm/hour to 2 cm/hour, 5 ranges
Number of input channels	Voltage and Current, 2 channels alternate recording
Accuracy	Voltage: ±2% f.s. Current: ±4 % f.s. (using 9651 CLAMP ON SENSOR / option)
Power supply	100 to 240 V AC (50/60 Hz) or 9.5 to 14 V DC, 2 way
Dimensions, mass	250W· 122H· 93.5D mm, 1.2kg
Accessories	Power cord(1), Recording paper(1 roll), 9257 CONNECTION CORD(1), 9344 CARRYING CASE(1)



### OPTIONS

- 9650 CLAMP ON SENSOR (for 8205-10, 8206-10, 100A f.s., 40Hz~1kHz, 3m length)
- 9651 CLAMP ON SENSOR (for 8205-10, 8206-10, 500A f.s., 40Hz~1kHz, 3m length)
- 9668 CLAMP ON SENSOR (for 8205-10, 8206-10, 1000A f.s., 40Hz~1kHz, 3m length)
- 9235 RECORDING PAPER (15m, 10rolls/1 set)
- 9236-01 RECORDING PAPER (Climate-resistant, 15m, 10rolls/1set)
- 9326 CONNECTION CORD (for 8205-10 only)
- 220H PAPER WINDER (refer to p.8)

## 9332 WAVE COMMUNICATOR (for 8807-01, 8808-01, 8807-51 and 8808-51)

### Remotely measure and transfer measurement results through a telephone line and RS-232C

- RS-232C and telephone line connections
- Waveform data transfer and remote settings
- Transfer data files from remote locations
- Display waveforms on a PC
- Data conversion and importing into spreadsheet programs

#### Memory HiCORDERs

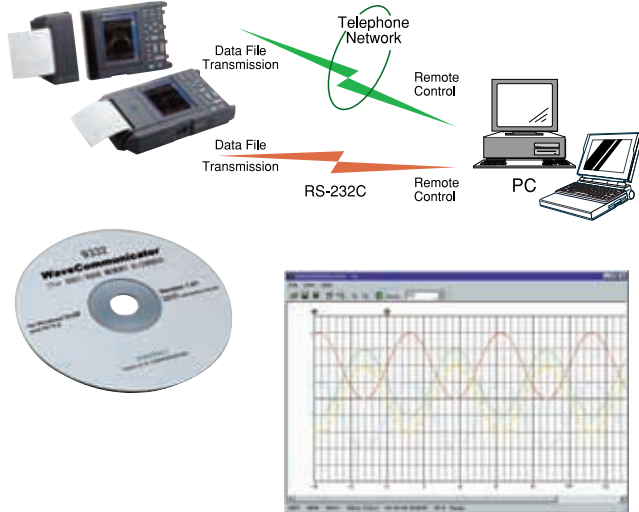

#### SPECIFICATIONS

Compatible Recorders	8807-01, 8808-01, 8807-51, 8808-51 MEMORY HiCORDERs (Vers. 2.00 or later)
Supplied Media	One CD-ROM or one CD-R
PC Operating Environment	IBM PC/AT Compatible (with at least 800-600 display resolution) Windows 95(SP1 or later), 98 or NT4.0(SP3 or later)
PC-Side Modem	Fax modem supported by Windows 95, 98, or NT4.0, 2000, XP
Recorder Compatible Modem	Fax modem card for analog public telephone lines (only specified models that have been pre-confirmed for operability)
Communication Methods	Standard telephone line or RS-232C (cannot be used at the same time)
PC Usage Limitations	While this application is running, other applications that use the modem or RS-232C cannot be used
Functions	Communications Functions / Trigger Acquisition Functions / Waveform Display Functions, Saving Converted Data / Connection Destination Registration / Setting File Creation Functions

Bottom left screen shows measured data displayed on a PC. (For use with 8808-01 data)

Bottom right screen shows MEMORY HiCORDER connection settings and data file acquisition, displaying connection conditions and a list of measurement files.

## 9333 LAN COMMUNICATOR (for 8720, 8826, 8835-01, 8841, 8842 and 8855)

### Connecting MEMORY HiCORDERs to LANs and high-speed transfer of waveform data to PCs

- High-speed communication with LAN connections
- Gathering and managing waveform data on PCs, and the waveform data collection function
- Remote and PC operations
- Data conversion and importing into spreadsheet programs

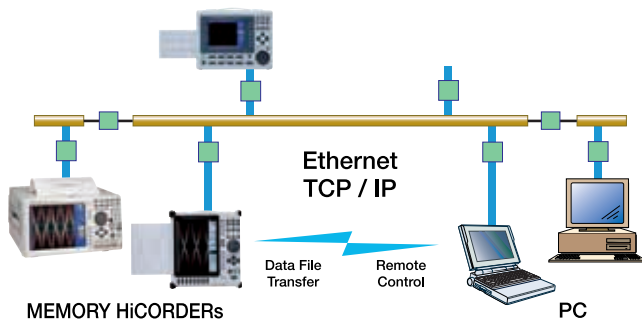

Images on right show an 8841 screen during measurements on a PC in real-time. The waveform screen is on the left and the control panel is on the right. In addition to displaying measured waveforms in real time, you can also use the keys displayed on the panel in the same way as the keys on the MEMORY HiCORDER.

#### SPECIFICATIONS

Compatible Recorders	8826 MEMORY HiCORDER (Vers. 2.30 or later) 8835-01 MEMORY HiCORDER*1 (Vers. 1.10 or later) 8841, 8842 MEMORY HiCORDERs (Vers. 2.30 or later) 8855 MEMORY HiCORDER 8720 VISUAL HiCORDER (Vers. 2.00 or later) 8730-10, 8731-10 WAVE COMPARATOR
Recorder Operating Environment	(*1) 8835 not compatible with the 9333. Compatible PC Card: 9578 10BASE-T LAN CARD Connector: 10BASE-T
Supplied Media	CD-ROM or CD-R (1 pc.)
PC Operating environment	IBM PC/AT Compatible (1024-768 or higher screen resolution is recommended when using the remote control functions) Windows 95(OSR2 or later), 98, or NT4.0, 2000, XP (network functions installed with a TCP/IP environment)
Communication System	Ethernet, TCP/IP
Functions	Remote Control Applications / Waveform Data Acquisition Applications / Waveform Viewer / GP-IB Command Functions

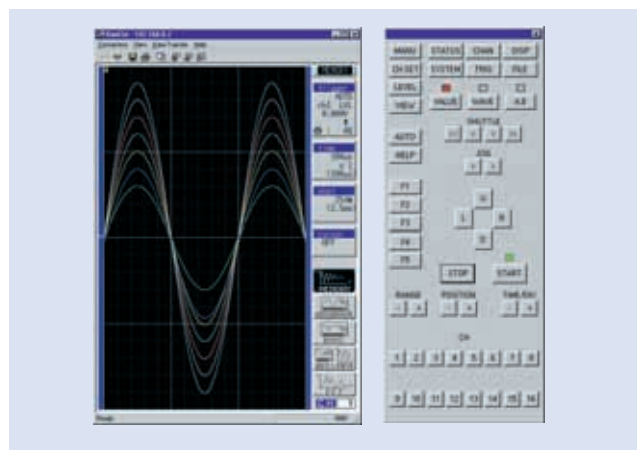

# 9334 LOGGER COMMUNICATOR (for 8420-51, 8421-51 and 8422-51)

Program that enables data collection using Ethernet and data analysis in Windows

## Real-Time Data Collection on a PC (TCP/IP Communications)

Supports Up to 16 HiLOGGERS

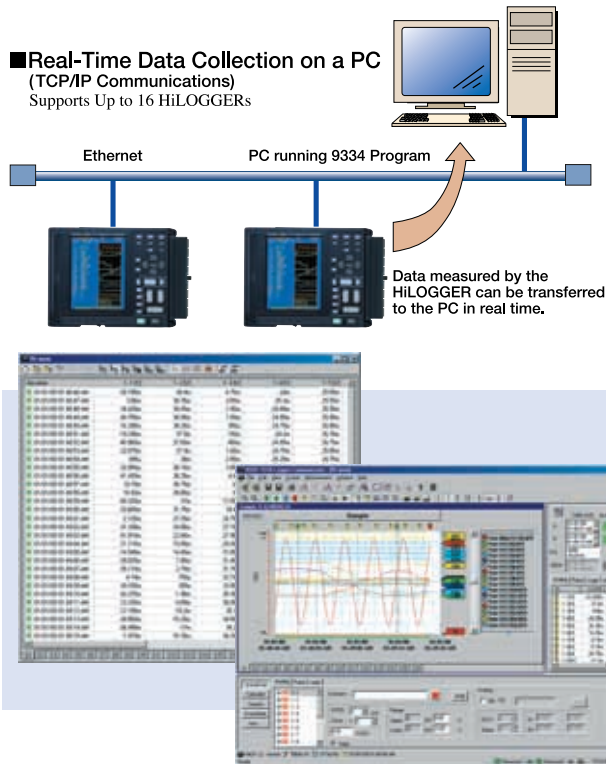

Recorders, Memory Recorders

### SPECIFICATIONS

<b>Compatible devices</b>	8420-51, 8421-51 and 8422-51 MEMORY HiLOGGERS
<b>Supplied Media</b>	One CD-R
<b>Operating environment</b>	Computers running under Windows 95/98/Me or WindowsNT/2000/XP. CPU: Pentium (133 MHz) or later, 32-MB memory or more OS: Windows 95/98/Me or Windows NT 4.0 SP3 or later / 2000/XP.
<b>Data transfer functions</b>	<ul style="list-style-type: none"> <li>Interface: Ethernet</li> <li>Number of units supported: 16</li> <li>Location of memory data: data can be loaded into the unit's internal memory</li> <li>Real-time transfer: data can be loaded in real time (maximum file size: up to 200 MB), real-time load settings can be made using the remote control</li> </ul>
<b>Display functions</b>	<ul style="list-style-type: none"> <li>Waveform Display: displays acquired waveform data as images</li> <li>Real-time Display: displays real-time transfers as images and allows the time axis to be split</li> <li>Digital Value Display: displays waveform data as digital values, and allows images and digital values to be displayed simultaneously</li> <li>Cursor function: allows you to display the time and potential differences between cursors A and B, the time and electrical potential between each cursor, and the absolute and relative times</li> <li>Scroll function</li> <li>Maximum number of channels: 512 analog channels, 256 logic channels, and 64 pulse channels</li> <li>Data load format: real-time and memory</li> <li>Alarm Output Display</li> </ul>
<b>Storage function</b>	<ul style="list-style-type: none"> <li>Memory content: criteria settings and measurement data (binary and text formats)</li> </ul>
<b>Data conversion functions</b>	<ul style="list-style-type: none"> <li>Target data: all data or data between cursors A and B</li> <li>Data interval: simple interval, average value, absolute and maximum values, maximum and minimum values (can be selected when saving)</li> <li>Data conversion: can convert analog and pulse waveform data into numerical values and logic data into binary</li> <li>Data conversion format: CSV</li> <li>Conversion channel: can be selected when saving</li> </ul>
<b>Print functions</b>	<ul style="list-style-type: none"> <li>Target data: all data or data between cursors A and B</li> <li>Print format: waveforms and numerical values</li> </ul>
<b>Parameter calculation functions</b>	<ul style="list-style-type: none"> <li>Target data: all data or data between cursors A and B</li> <li>Calculation items: average value, peak value, maximum value, maximum value time, minimum value, minimum value time, ON time, OFF time, number of times ON, number of times OFF, standard deviation, area</li> </ul>
<b>Other</b>	<ul style="list-style-type: none"> <li>Marking function: inserts an event marker at the start of measurement</li> <li>Search functions: Select from event marker, date (absolute and relative time), trigger, maximum, minimum, peak, valley, alarm, level, window, or volume of change</li> </ul>

# 9335 WAVE PROCESSOR (for MEMORY HiCORDER)

Display, Convert, Calculate and Print Waveforms on a PC

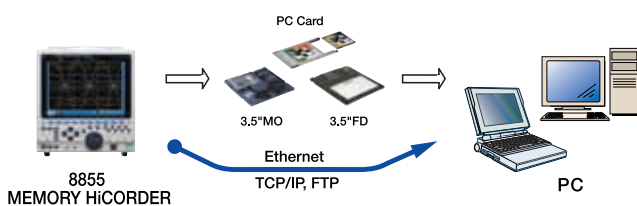

\*Note: The use of MO discs, PC cards, and floppy disks and the availability of a LAN connection depend on the specifications of the recorder model in question.

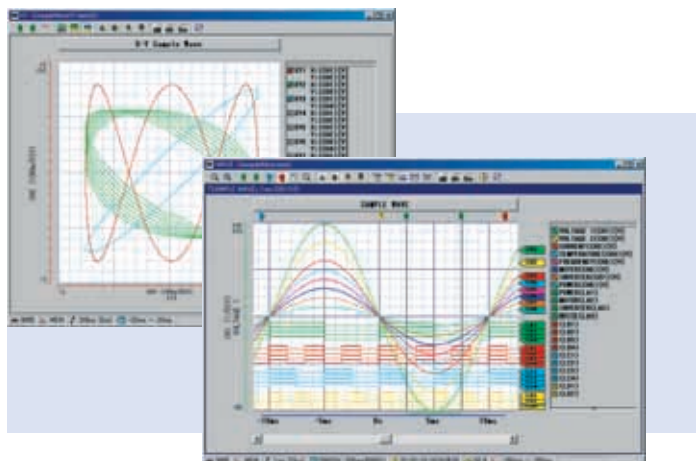

### SPECIFICATIONS

<b>Compatible devices</b>	MEMORY HiCORDER 8807 (-01/-51), 8808 (-01/-51), 8826, 8835 (-01), 8841, 8842, 8855; POWER HiCORDERs 8714 (-01), 8715 (-01); VISUAL HiCORDER 8720 WAVE COMPARATOR 8730-10, 8731-10 (Other than the 8855) 8936, 8937, 8938, 8939, 8940, 8946, 8947 (8855) 8950, 8951, 8952, 8953 (-10), 8954, 8955
<b>Supplied Media</b>	One CD-R disc
<b>Operating environment</b>	Computers running Windows 95, 98, Me, NT4.0, 2000 or XP Pentium (133MHz) or better, at least 32MB of memory (Recommended: Pentium (200MHz) or better, at least 64MB of memory)
<b>Display functions</b>	<ul style="list-style-type: none"> <li>Waveform Display: Displays image of loaded waveform data on screen</li> <li>X-Y display: Memory function format (.MEM file) only</li> <li>Digital Value Display: Displays waveform data as digital values, and allows images and digital values to be displayed simultaneously</li> <li>Cursor function: Allows you to display the time and potential differences between cursors A and B, the time and electrical potential between each cursor, and the absolute and relative times</li> <li>Scroll function: available</li> <li>Maximum number of channels: 32 analog channels, 32 logic channels</li> <li>Gauge display: Time gauge, voltage axis gauge</li> <li>Graphical input: Possible</li> </ul>
<b>File loading</b>	<ul style="list-style-type: none"> <li>Loading data format: Memory (.MEM, except for data stored in real time); recorder (.REC), effective value recorder (.RMS)</li> <li>Maximum loadable file size: Maximum size that can be stored by hardware. The maximum size that can be handled may be smaller in some PC environments.)</li> </ul>
<b>Data conversion functions</b>	<ul style="list-style-type: none"> <li>Target data: All data, data between cursors</li> <li>Data interval: Simple interval (number of samples can be specified)</li> <li>Data conversion: Converts analog waveform data into numeric values, converts logic data into binary</li> <li>Data conversion format: CSV format, tab delimited, space delimited (selectable when data is saved)</li> <li>Conversion channel: Can be selected when data is saved</li> <li>Batch conversion: Multiple files can be specified for batch conversion</li> </ul>
<b>Printing functions</b>	<ul style="list-style-type: none"> <li>Printing format: Can print no partitions, 2 to 16 partitions, 2 to 16 columns, X-Y 1 to 4 partitions, gauges, channel comments</li> <li>Print preview: Possible</li> <li>Waveform screen hard copy: Possible</li> <li>Compatible printers: Any printer supported by the OS (color or black and white)</li> </ul>
<b>Parameter calculation functions</b>	<ul style="list-style-type: none"> <li>Target data: All data, data between cursors</li> <li>Calculation items: Average value, effective value, peak value, maximum value, time of maximum value, minimum value, time of minimum value, rise time, fall time, standard deviation, area, cycle, frequency, pulse width, duty ratio, ON time, OFF time, number of times turned ON</li> </ul>
<b>Other</b>	<ul style="list-style-type: none"> <li>Search functions: Event mark, date and time (absolute time, time relative to trigger), maximum, minimum, absolute maximum, absolute minimum, level up/down, window in/out Clipboard copy: Waveform screen, cursor value, digital value, file information</li> <li>Startup of other applications: Other applications can be launched by specifying run file</li> </ul>



# Electronic Measuring Instruments



## Electronic Measuring Instruments Index

### For low resistance measurement



CE

Testing source DC  
100 ms response  
16 times/sec. sampling  
Comparator (buzzer only)

..... p.17



CE

Wide measurement range  
0.1 $\mu\Omega$  (20m  $\Omega$  range) to  
110M $\Omega$  High speed and  
High precision

..... p.17



CE

Testing source AC 1kHz  
50/60 times/sec. sampling  
Comparator output, full remote  
control, RS-232C included  
GP-IB or Printer interface option

..... p.18



CE

Prints out measurement  
data at fixed intervals  
for 3227, 3540, 3560,  
3550, 3551

..... p.18

### Battery Testers



CE

For medium to  
high-capacity lead-acid  
storage battery: UPS and  
similar applications  
Check battery deterioration

..... p.21



CE

For compact storage  
batteries: portable  
telephones and similar  
applications  
Check battery deterioration

..... p.21

### Inductance, Capacitance, or Impedance Meters



CE

7 measurement items  
Testing source frequency  
120Hz, 1kHz  
Comparator output, RS-232C  
included, GP-IB option

..... p.18



CE

14 measurement items  
Testing source frequency  
DC, 1mHz to 100kHz  
Comparator output,  
GP-IB or RS-232C option

..... p.20



CE

14 measurement items  
Testing source frequency  
42Hz to 5MHz  
Comparator output,  
GP-IB or RS-232C option

..... p.20



CE

14 measurement items  
Testing source frequency  
100kHz to 120MHz  
Comparator output  
GP-IB and RS-232C

..... p.19



CE

C, D Testing  
Testing source frequency  
120Hz, 1kHz  
Comparator output, RS-232C  
included, GP-IB option

..... p.19



C Testing  
Testing source signal  
4V DC/ one time  
Indicator type

### Signal Sources, Waveform Generators



CE

DC signal source  
Voltage, Current,  
Thermoelectric power  
Measurement function

..... p.26



CE

DC signal source Voltage,  
Current, Measurement function

..... p.26



CE

(4ch)  
(2ch)  
Arbitrary waveform generator  
Function generator, Sweep  
sequence function

..... p.26



CE

High speed DMM  
199999 count display

..... p.22

### PORTABLE WITHSTANDING VOLTAGE TESTER



CE

Basic AC withstand  
voltage tester  
3kV/30VA  
Economical and easy to  
operate

..... p.24

### HIGH VOLTAGE CONTACT CHECKER



CE

Monitor the voltage  
on test terminals for  
3153/3159/3158/3173

..... p.24

### Safety Standards Measuring Instruments

#### Insulation Test Equipment



CE

Testing voltage 25 /50  
/100 /250 /500 /1000 V  
Comparator output  
Timer function

..... p.24

#### Leakage current of Medical Equipment



CE

Leakage current for use  
in testing electric and  
medical appliances  
RS-232C

..... p.25

#### Protective ground Test Equipment



CE

Testing source AC  
Protective ground  
tester indispensable for  
standard certification

..... p.25

#### AC Withstanding Voltage Test Equipment



CE

5 kV/500VA  
AC withstanding voltage  
of electric appliances

..... p.24

#### Insulation/Withstanding Test Equipment



CE

2000M $\Omega$ /5kV  
Insulation and  
withstanding voltage  
tester

..... p.23

#### Automatic Insulation/Withstanding Test Equipment



CE

9999M $\Omega$ /5 kV AC/DC  
Automatic insulation  
and withstanding voltage  
tester

..... p.23

# 3541 RESISTANCE HiTESTER

Measure from very low ( $\mu\Omega$ ) to very high ( $M\Omega$ ) resistances with a single instrument

- **Wide Measurement Range**  
0.1  $\mu\Omega$  (20 m $\Omega$  range) to 110.000 M $\Omega$
- **High Speed & High Precision Measurements**  
As fast as 0.6 ms with 70 ppm precision (in the 2 k $\Omega$  to 110 k $\Omega$  range)
- **Two Types of Temperature Correction**  
Correction by Pt sensor or Infrared Thermometer
- **Equipped with EXT I/O, GP-IB and RS-232C interfaces**  
Easily integrates into automated production lines



## SPECIFICATIONS

Measurement	Four-terminal resistance measurement 0.1 $\mu\Omega$ (20 m $\Omega$ range) to 110.000 M $\Omega$ Low power four-terminal resistance measurement 10 $\mu\Omega$ (2 $\Omega$ range) to 2.00000 k $\Omega$ Temperature measurement (Pt) -10.0 to 99.9°C Temperature measurement (analog) 0 to 2V
Accuracy	70ppm of rdg+15ppm of f.s. (2k $\Omega$ .20k $\Omega$ range slow $\Omega$ )
Functions	Temperature correction, temperature conversion, self calibration, measurement fault detection, overflow detection, offset voltage compensation, average, statistical calculation, key lock, save/load, comparator, BIN measurement
Interface	GP-IB, RS-232C, EXT-I/O
Power supply	100 to 240 VAC 50/60 Hz
Dimensions	Approx. 215Wx80Hx295D mm (excluding projections)
Mass	Approx. 2.6 kg
Accessories	9287-10 CLIP TYPE LEAD, 9451 TEMPERATURE PROBE, Power Cord, EXT I/O Male Connector

## OPTIONS

- 9452 CLIP TYPE LEAD
- 9453 FOUR TERMINAL LEAD
- 9454 ZERO ADJUSTMENT BOARD
- 9455 PIN TYPE LEAD (for ultra precision)
- 9461 PIN TYPE LEAD
- 9465 PIN TYPE LEAD
- 9467 LARGE CLIP TYPE LEAD
- 9300 CONNECTION CABLE (for multipolar connectors)
- 9637 RS-232C CABLE (9pin-9pin/cross/1.8m)
- 9638 RS-232C CABLE (9pin-25pin/cross/1.8m)
- 9151-02 GP-IB CONNECTOR CABLE (2m)
- 9151-04 GP-IB CONNECTOR CABLE (4m)
- 9670 PRINTER
- 9671 AC ADAPTER (for 9670)
- 9672 BATTERY PACK (for 9670)
- 9673 BATTERY CHARGER (for 9672)
- 9237 RECORDING PAPER (80mm x 25m, 4 rolls)



# 3540 | 3540-01 | 3540-02 | 3540-03 | m $\Omega$ HiTESTER

Offers selectable manual measurement or system application

- 4-terminal method milli-ohmmeter (Fast 100-ms Response)
- Comparator function memorizes up to seven tables
- Temperature compensation function measures temperature and calculates value relative to copper at 20°C



## SPECIFICATIONS

Measurement ranges and Accuracy	30 m $\Omega$ to 30 k $\Omega$ , 7 ranges, 3500 full digits $\pm 0.1$ % rdg. $\pm 6$ dgt. (30 m $\Omega$ , 3 $\Omega$ range) $\pm 0.1$ % rdg. $\pm 4$ dgt. (300 m $\Omega$ , 30 $\Omega$ to 30 k $\Omega$ range)
Measurement current	100 mA (30 m $\Omega$ , 300 m $\Omega$ range) to 10 $\mu$ A (3 k $\Omega$ , 30 k $\Omega$ range)
Max. applied measurement voltage	3.5 mV DC (30 m $\Omega$ range) to 350 mV DC (30 k $\Omega$ range)
Sampling speed	16 times /second (fast mode), 4 times /second (slow mode)
Response time	100 ms (fast mode), 300 ms (slow mode)
Display	3500 full digits, Liquid Crystal Display
Measurement method	Four-terminal measurement
Open-circuit terminal voltage	4.0 V Max. (30 m $\Omega$ to 30 k $\Omega$ all ranges)
Digital input/output (-01, -02 and -03 Ver. only)	TTL output BCD, or other inputs /outputs for external control
Comparator functions	Setting: Upper and lower limit, or reference value and % for resistance, Up to 7 tables Output: 3 levels (Hi, In, Lo), Open-collector, LED display, beep sound
Interface	External printer (-02 only), RS-232C (-03 only)
Power supply	LR6 (AA) or R6P (AA)x6, or 9445-02, -03 AC ADAPTER (9V, 1A)
Dimensions, mass	215Wx61Hx213D mm, 900 g, 1 kg (-01,-02,-03)
Accessories	9287-10 CLIP-TYPE LEAD(1), 9451 TEMPERATURE PROBE(1), Fuse(1), Ferrite Clamp(2), External Connector Socket (-01 only)

## OPTIONS

- 9203 DIGITAL PRINTER
- 9233 RECORDING PAPER (10 m, 10 rolls /1set)
- 9425 CONNECTION CORD (for 9203-3540-02, 2m)
- 9445-02 AC ADAPTER (100 to 240 VAC, 9 V/1A output, for USA)
- 9445-03 AC ADAPTER (100 to 240 VAC, 9 V/1A output, for EU)
- 9452 CLIP-TYPE LEAD
- 9453 FOUR-TERMINAL LEAD
- \*9455 PIN-TYPE LEAD
- 9460 CLIP-TYPE LEAD WITH TEMPERATURE SENSOR
- 9461 PIN-TYPE LEAD
- 9467 LARGE CLIP-TYPE LEAD
- 9637 RS-232C CABLE (9pin-9pin)
- 9638 RS-232C CABLE (9pin-25pin)

\*Note: The 9455 probe is a precision instrument. Exercise appropriate care when handling it.

The 3540 is the low-price version without external control interfaces, for manual measurement. The 3540-01 adds BCD output and external control, the 3540-02 includes a printer interface and the 3540-03 includes an RS-232C interface.

## 3560 AC mΩ HiTESTER

For measurement requirements from contact resistance to internal resistance and voltage of batteries

- Fast response time approximately 84 ms (60 Hz)
- Low-power resistance measurement
- Battery measurement
- High-resolution (1μΩ in the 30mΩ. range)



### SPECIFICATIONS

Measurement ranges	30 mΩ to 3 kΩ, 6 ranges, ±0.5 % rdg. ±8 dgt. (all ranges)
Accuracy	In case of MEDIUM: Add 3 dgt. to the above dgt. error. FAST: ±0.5 % rdg. ±8 dgt. (30 mΩ), ±0.5 % rdg. ±6 dgt. (other ranges), However, in case of FAST, the display counter decreases 4 digits in all ranges.
Measurement current	7.4 mA (30 mΩ range) to 1.5μA (3 kΩ range)
Max. applied measurement voltage	60 V DC (AC input is not possible)
Sampling speed	50 times /s (FAST) to 1.56 times /s (SLOW) :at 50 Hz mode 60 times /s (FAST) to 1.88 times /s (SLOW) :at 60 Hz mode
Display	31000 full digits (resistance), 50000 full digits (voltage), Fluorescent tube.
Measurement method	1 kHz AC four-terminal measurement
Open-circuit terminal voltage	20mV peak max. (30 mΩ to 3 kΩ all ranges)
Comparator functions	<b>Setting:</b> Upper and lower limit, Up to 30 tables <b>Output:</b> 3 levels (Hi, In, Lo) or (Pass, Fail), open-collector, display, beep sound
Interface	RS-232C (standard), GP-IB or External printer (option)
Power supply	100 to 240 V AC, 50/60 Hz
Dimensions, mass	215W×80H×320D mm, 2.1 kg
Accessories	9287-10 CLIP-TYPE LEAD(1), Power cord(1)

### OPTIONS

- 9203 DIGITAL PRINTER
- 9233 RECORDING PAPER (10 m, 10 rolls /1set)
- 9425 CONNECTION CORD (for 9203-3560, 2m)
- 9452 CLIP-TYPE LEAD
- 9453 FOUR-TERMINAL LEAD
- 9454 ZERO ADJUSTMENT BOARD (when 9461 or 9465 is used)
- \*1 9455 PIN-TYPE LEAD
- 9461 PIN-TYPE LEAD
- 9465 PIN-TYPE LEAD
- 9466 REMOTE CONTROL SWITCH
- 9467 LARGE CLIP-TYPE LEAD
- \*2 9588 GP-IB INTERFACE
- 9589 PRINTER INTERFACE
- 9151-02/04 GP-IB CONNECTION CABLE (2 m /4 m)

- \*1Note: The 9455 probe is a precision instrument. Exercise appropriate care when handling it.
- \*2Note: Non-CE mark product

## 3511-50 LCR HiTESTER

Compact & powerful dedicated LCR measurement in 5m second timeframes

- High speed measurement : 5ms (1 kHz) or 13ms (120 Hz)
- High precision accuracy : ±0.08 %
- Built-in comparator



### SPECIFICATIONS

Measurement parameters	Z , θ, C, L, D, Q, R
Measurement method	<b>Source :</b> open terminal voltage 50mV, 500mV, 1Vrms (AC) <b>sense:</b> voltage, AC
Source frequency	120 Hz or 1 kHz
Measurement ranges	Z , R : 10 mΩ to 200.00 MΩ (depending on condition) θ : -90.00 to +90.00°, C : 0.940 pF to 999.99 mF, L : 1.600 μH to 200.00 kH, D : 0.0001 to 1.9900, Q : 0.85 to 999.99
Basic accuracy	Z  : ±0.08% rdg., θ : ±0.05°
Measurement times	<b>Fast :</b> 5 msec. to <b>Slow :</b> 300 msec. (at 1 kHz) <b>Fast :</b> 13 msec. to <b>Slow :</b> 400 msec. (at 120 Hz)
Display	99999 full digits, LED
Comparator functions	<b>Setting :</b> Upper and lower limit, absolute value, <b>Output :</b> 3 levels (Hi, In, Lo), Open-collector, Isolated
External printer	9442 (use with the 9443-02 or -03/9444)
Power supply	100 to 240 V AC, 50/60Hz
Dimensions, mass	210W×100H×168D mm, 2.5 kg
Accessories	Power cord(1), Fuse(1)

### OPTIONS

(The 3511-50 cannot be used alone. Measurement requires optional test fixture or probe.)

- 9140 FOUR-TERMINAL PROBE (DC to 100 kHz)
- 9143 PINCHER PROBE (DC to 5 MHz)
- 9261 TEST FIXTURE (cable connection type, DC to 5 MHz)
- 9262 TEST FIXTURE (direct connection type, DC to 5 MHz)
- 9263 SMD TEST FIXTURE (direct connection type, DC to 5 MHz)
- 9268 DC BIAS VOLTAGE UNIT (± 40 V DC max.)
- 9269 DC BIAS CURRENT UNIT (± 2 A DC max.)
- 9165 CONNECTION CORD (for 9268/9269; BNC to BNC, 1.5 m)
- 9166 CONNECTION CORD (for 9268/9269; BNC to clip, 1.5 m)
- 9151-02/04 GP-IB CONNECTION CABLE (2 m /4 m)
- 9518-01 GP-IB INTERFACE
- 9442 PRINTER
- 9443-02 AC ADAPTER (for the 9442, EU), 9443-03 (USA)
- 9444 CONNECTION CABLE (for the 3511-50/9442)
- 1196 RECORDING PAPER (25 m, 10 rolls/1 set, for the 9442)

# 3535 LCR HiTESTER

## High-speed LCR meter with up to 120MHz sampling

- Wide range from 100kHz to 120MHz
- High speed LCR testing (6ms/sample)
- Removable head amplifier
- "Load compensation function" for comparing standard component and providing compensation



The head amplifier can be removed from the main chassis.

9678 CONNECTION CABLE

HEAD AMP UNIT

### SPECIFICATIONS

Measurement parameters	Z ,  Y , Q, Rp, Rs(ESR), G, X, B, θ, Ls, Lp, Cs, Cp, D(tanδ)			
Measurement Range: Reference Value	1kΩ range	10kΩ range	100kΩ range	
	Z · R	100Ω to 2kΩ	1kΩ to 20kΩ	10kΩ to 300kΩ
	C	0.66pF to 15.9μF	0.066pF to 1.59nF	4.4fF to 159pF
	L	0.133nH to 3.18mH	1.33μH to 31.8mH	13.3μH to 477mH
	θ	-180.00° to 180.00°		
Measurement Frequency	Range	100kHz to 120MHz		
	Resolution setting	4digits (when using front panel to make setting)		
	100.0kHz to 1.000MHz	100Hz steps		
	1.000MHz to 10.000MHz	1kHz steps		
	10.00MHz to 100.0MHz	10kHz steps		
100.0MHz to 120.0MHz	100kHz steps			
	When using GP-IB or RS-232C interfaces, resolution is 1Hz.			
Measurement Levels	Accuracy	±0.005% max. against set value		
	Open Terminal Voltage (V) and Constant Voltage (CV) Modes	5mV to 1V, max. 20mA (up to 10.000MHz)		
	Resolution	1mV steps		
	Accuracy	±(5%+5mV)×(2+log f) (f in terms of MHz)		
	Constant Current (CC) Mode	200μA to 20mA, max. 1V (up to 10.00MHz)		
	Resolution	10μA steps		
	Accuracy	±(10%+50μA)×(2+log f) (f in terms of MHz)		
Basic accuracy	Z: ±0.5% rdg.; θ: ±0.3°			
Output impedance	50Ω ±10Ω (at 100kHz)			
Monitor	Voltage	0.000V to 1.000V		
	Current	0.000mA to 20.0mA		
Limit	Current (when set at V or CV)	0.20mA to 20.00mA		
	Voltage (when set a CC)	0.005V to 1.000V		
Average	OFF, 2, 4, 8, 16, 32, 64			
Trigger	Internal trigger, External trigger			
	Trigger delay	0.01s to 9.99s; 0.01s resolution		
Comparator	Available for two measurement parameters; percentage, Δ%, or absolute value settings (for Δ%, the offset of the measurement value from the standard value is displayed)			
Panel Memory and Load	Maximum 30 sets			
Zoom Display	Measurement value and judgment result using comparator			
Number of Lines Displayed	Can set at 3, 4, or 5; may differ depending on parameter			
Printer	Hard copy of measurement value or screen (requires 9442, 9444)			
Interfaces	GP-IB, RS-232C, EXT..I/O (All standard)			
Operating Environment	10 to 40°C, 80%rh max., no condensation			
Storage Environment	-10 to 55°C, 80%rh max., no condensation			
Power Supply	100V to 240V AC, 50/60Hz Approx. 50VA			
Dimensions, mass	Approx. 360W×130H×360D mm ; 8.3kg			

### OPTIONS

- (Model 3535 cannot be used alone. Measurement requires optional head amp unit and test fixture or Probe.)
- 9700-10 HEAD AMP UNIT 9151-02/04 GP-IB CONNECTION CABLE (2m/4m)
  - \*9677 SMD TEST FIXTURE 9442 PRINTER
  - 9699 SMD TEST FIXTURE 9443-02 AC ADAPTER (for the 9442, EU), 9443-03 (USA)
  - 9678 CONNECTION CABLE 9444 CONNECTION CABLE (for the 3535/9442)
  - 1196 RECORDING PAPER (25m, 10rolls/1set, for the 9442)

\*Note: Non-CE mark product

Electronic Measuring Instruments



9700-10+3535



9700-10 HEAD AMP UNIT



9678 CONNECTION CABLE (2m)



**9677 SMD TEST FIXTURE**  
 Operating Frequency : DC to 120 MHz  
 Measurable Object Size : 3.5 ±0.5 mm  
 Dimensions :  
 Approx. 103W × 37.1H × 47.6D mm  
 Mass : Approx. 135 g



**9699 SMD TEST FIXTURE**  
 Operating Frequency : DC to 120 MHz  
 Measurable Object Size : W ; 1.0 to 4.0 mm  
 H ; 1.5 mm  
 Dimensions :  
 Approx. 100.5W × 28.6H × 40.0D mm  
 Mass : Approx. 125 g

## 3522-50 LCR HiTESTER

Better functionality and performance at a low cost

- High speed measurement of 5 ms LCR meter
- Higher frequency range (DC or 1 mHz to 100 kHz)
- Fourteen parameters measured (High resolution and high accuracy)
- DC resistance measurement



**GP-IB**  
OPTION

**RS-232C**  
OPTION

### SPECIFICATIONS

Measurement parameters	Z ,  Y , $\theta$ , R <sub>p</sub> (DCR), R <sub>s</sub> (ESR, DCR), G, X, B, C <sub>p</sub> , C <sub>s</sub> , L <sub>p</sub> , L <sub>s</sub> , D(tan $\delta$ ), and Q
Measurement method	Source: constant current 10 $\mu$ to 100 mA(AC/DC), or constant voltage 10 mV to 5 V (AC/DC) open terminal voltage
Source frequency	DC, or 1mHz to 100kHz
Measurement ranges	Z ,  R , X: 10.00 m $\Omega$ to 200.00 M $\Omega$ (depending on condition) $\theta$ : -180.00 to +180.00°, C: 0.3200 pF to 1.0000 F, L: 16.000 nH to 750.00 kH, D: 0.00001 to 9.99999, Q: 0.01 to 999.99,  Y , G, B: 5.0000 nS to 99.999 S
Basic accuracy	Z : $\pm 0.08$ % rdg., $\theta$ : $\pm 0.05^\circ$
Measurement times typical values for displaying Z	Fast: 5 msec. to Slow2: 828 msec.
Display	99999 full digits, LCD with backlight display
Comparator functions	Setting: Upper and lower limit, percentage, or absolute value, Output: 3 levels (Hi, In, Lo), Open-collector, Isolated
External printer	9442 (use with the 9443-02 or -03/9446/9593-01)
Power supply	100 to 240 V AC, 50/60Hz
Dimensions, mass	313W $\times$ 125H $\times$ 290D mm, 4.5 kg
Accessories	Power cord(1), Fuse(1)

### OPTIONS

(The 3522-50 cannot be used alone. Measurement requires optional test fixture or probe.)

- 9140 FOUR-TERMINAL PROBE (DC to 100 kHz)
- 9143 PINCHER PROBE (DC to 5 MHz)
- 9261 TEST FIXTURE (cable connection type, DC to 5 MHz)
- 9262 TEST FIXTURE (direct connection type, DC to 5 MHz)
- 9263 SMD TEST FIXTURE (direct connection type, DC to 5 MHz)
- 9268 DC BIAS VOLTAGE UNIT ( $\pm 40$  V DC max.)
- 9269 DC BIAS CURRENT UNIT ( $\pm 2$  A DC max.)
- 9165 CONNECTION CORD (for 9268/9269; BNC to BNC, 1.5 m)
- 9166 CONNECTION CORD (for 9268/9269; BNC to clip, 1.5 m)
- 9151-02/04 GP-IB CONNECTION CABLE (2 m /4 m)
- 9518-01 GP-IB INTERFACE
- 9593-01 RS-232C INTERFACE
- 9442 PRINTER
- 9443-02 AC ADAPTER (for the 9442, EU), 9443-03 (USA)
- 9446 CONNECTION CABLE (for the 3522-50 /9442)
- 1196 RECORDING PAPER (25 m, 10 rolls /1 set, for the 9442)

## 3532-50 LCR HiTESTER

Impedance meter with a wide test frequency range

- Higher frequency range (42 Hz to 5 MHz)
- High speed measurement of 5 ms LCR meter
- Interactive touch panel operation
- Wide setting range for measurement voltage and current



**GP-IB**  
OPTION

**RS-232C**  
OPTION

### SPECIFICATIONS

Measurement parameters	Z ,  Y , $\theta$ , R <sub>p</sub> , R <sub>s</sub> (ESR), G, X, B, C <sub>p</sub> , C <sub>s</sub> , L <sub>p</sub> , L <sub>s</sub> , D(tan $\delta$ ), and Q
Measurement method	Source: constant current 10 $\mu$ to 100 mA (42 Hz to 1 MHz), 50 $\mu$ to 20 mA (1 MHz to 5 MHz), or constant voltage 10 mV to 5 V (42 Hz to 1 MHz), 50 mV to 1 V (1 MHz to 5 MHz) open terminal voltage
Source frequency	42 Hz to 5 MHz
Measurement ranges	Z , R, X: 10.00 m $\Omega$ to 200.00 M $\Omega$ (depending on condition) $\theta$ : -180.00 to +180.00°, C: 0.3200 pF to 370.00 mF, L: 16.000 nH to 750.00 kH, D: 0.00001 to 9.99999, Q: 0.01 to 999.99, Y,G,B: 5.0000 nS to 99.999 S
Basic accuracy	Z : $\pm 0.08$ % rdg., $\theta$ : $\pm 0.05^\circ$
Measurement times typical values for displaying  Z	Fast: 5 msec. to Slow2: 140 msec.
Display	99999 full digits, LCD with backlight display
Comparator functions	Setting: Upper and lower limit, percentage, or absolute value, Output: 3 levels (Hi, In, Lo), Open-collector, Isolated
External printer	9442 (use with the 9443-02 or -03/9446/9593-01)
Power supply	100 to 240 V AC, 50/60Hz
Dimensions, mass	352W $\times$ 124H $\times$ 323D mm, 6.5kg
Accessories	Power cord(1), Fuse(1)

### OPTIONS

(The 3532-50 cannot be used alone. Measurement requires optional test fixture or probe.)

- 9140 FOUR-TERMINAL PROBE (DC to 100 kHz)
- 9143 PINCHER PROBE (DC to 5 MHz)
- 9261 TEST FIXTURE (cable connection type, DC to 5 MHz)
- 9262 TEST FIXTURE (direct connection type, DC to 5 MHz)
- Note: Measurement ranges are limited when using the 9140, 9143
- 9263 SMD TEST FIXTURE (direct connection type, DC to 5 MHz)
- 9268 DC BIAS VOLTAGE UNIT ( $\pm 40$  V DC max.)
- 9269 DC BIAS CURRENT UNIT ( $\pm 2$  A DC max.)
- 9165 CONNECTION CORD (for 9268/9269; BNC to BNC, 1.5 m)
- 9166 CONNECTION CORD (for 9268/9269; BNC to clip, 1.5 m)
- 9151-02/04 GP-IB CONNECTION CABLE (2 m /4 m)
- 9518-01 GP-IB INTERFACE
- 9593-01 RS-232C INTERFACE
- 9442 PRINTER
- 9443-02 AC ADAPTER (for the 9442, EU), 9443-03 (USA)
- 9446 CONNECTION CABLE (for the 3532-50 /9442)
- 1196 RECORDING PAPER (25 m, 10 rolls /1 set, for the 9442)

# 3550 | 3551 | 3555

## BATTERY HiTESTER

### Instantaneous determination of battery deterioration

- Model 3551: support for high-capacity batteries
- Model 3555: for compact storage batteries (portable telephones)
- Model 3550: for medium-capacity lead-acid storage batteries
- Three-rank rating of battery state: Pass, Warning, or Fail



3550



3551



3555

#### 3550, 3551: SPECIFICATIONS

<b>Resistance Measurement</b>	3550: 30 mΩ to 3Ω, 3 ranges, 10μΩ resolution max. 3551: 3 mΩ to 300 mΩ, 3 ranges, 1μΩ resolution max.
<b>Voltage Measurement</b>	3 or 30 V DC, 2 ranges, 1 mV resolution max.
<b>Temperature Measurement</b>	-10 to 60°C, 1 range, 0.1°C resolution (platinum sensor)
<b>Sampling rate</b>	0.83 times/second
<b>Comparator functions</b>	Setting: Upper and lower limit for resistance, and lower limit for voltage, Output: LED, beep
<b>Other functions</b>	Data memory, Printer interface (9203 or Centronics)
<b>Power supply</b>	3550: LR6(AA)×6, 3551: LR6(AA)×6, or 9418-10
<b>Dimensions, mass</b>	3550: 196W×130H×50D mm, 710 g (including batteries) 3551: 196W×130H×65D mm, 860 g (including batteries)
<b>Accessories</b>	3550: 9460 CLIP-TYPE LEAD WITH TEMPERATURE SENSOR(1), 9382 CARRYING CASE(1), Dust cover(1), LR6(6) 3551: 9465 PIN-TYPE LEAD(1), 9466 REMOTE CONTROL SWITCH(1), 9377 CARRYING CASE(1), Dust cover(1), LR6(6)

#### 3555: SPECIFICATIONS

<b>Resistance Measurement</b>	300 mΩ to 30Ω, 3 ranges, 100μΩ resolution max.
<b>Voltage Measurement</b>	3 or 30V DC, 2 ranges, 1 mV resolution max.
<b>Sampling rate</b>	1.25 times/second
<b>Comparator functions</b>	Setting: Upper and lower limit, for resistance, and lower limit for voltage, Output: LED, beep
<b>Power supply</b>	LR6(AA), 6 pieces (Continuous use of 18 hours)
<b>Dimensions, mass</b>	196W×130H×50D mm, 680g (including batteries)
<b>Accessories</b>	9461 PIN-TYPE LEAD (1), LR6 (6)

#### OPTIONS

- 9203 DIGITAL PRINTER (for the 3550, 3551)
- 9425 CONNECTION CORD (for connecting the 3550/3551 to the 9203 / 2 m length)
- \*2 9467 LARGE CLIP-TYPE LEAD
- 9233 RECORDING PAPER (10 m, 10 rolls/1 set, for 9203)
- 9418-10 AC ADAPTER (for the 3551 only)
- \*1 9455 PIN-TYPE LEAD (for the 3550, 3555)
- 9287-10 CLIP-TYPE LEAD (for the 3555)

9382 CARRYING CASE (for the 3555)

\*1Note: The 9455 probe is a precision instrument. Exercise appropriate care when handling it.

\*2Note: Non-CE mark product



3551

Checking the battery in an Uninterruptible Power Supply (UPS) without shutting down



3555

On-the-spot testing of compact storage batteries -- portable telephones and similar applications

# 3238 | 3239 | DIGITAL HiTESTER

**High-accuracy, multi-functional model (3238)**  
**A new DMM with 4-terminal resistance measurement! (3239)**

- Samples at rates of up to 300 samples/sec. (3.3 ms/ sample)
- Comparator function provides high-speed pass/fail evaluation
- Equipped with external input and output for sequence control
- Useful Save/Load function helps work go faster
- Interface supports full remote operation
- AC/DC current and frequency functions



3238, 3239 SPECIFICATIONS	
DC voltage (DC V)	200m/2/20/200/1000V(±0.01% rdg. ±2dgt./2V)
AC voltage (AC V)	2/20/200/750V(±0.1% rdg. ±100dgt./45 to 10kHz) True RMS
DC current (DC A)	200m/2A(±0.1% rdg. ±6dgt./200mA)
AC current (AC A)	200m/2A(±0.3% rdg. ±100dgt./200mA, 45 to 3kHz) True RMS
Frequency	100/1k/10k/100k/300kHz (±0.015% rdg. ±2dgt./10 to 300kHz)
Resistance (Ω)	200/2k/20k/200k/2000k/20M/100MΩ (±0.02% rdg. ±2dgt./2k to 200kΩ)
Resistance (LPΩ)	2k/20k/200k/2000kΩ (±0.02% rdg. ±6dgt./2k to 200kΩ)
Open terminal voltage	6V DC max.(Ω, Diode check) 0.45V DC max.(LPΩ, Continuity check)
Continuity check	A built-in buzzer sounds when the resistance value is less than 50.00Ω.
Sampling rate	FAST approx. 300 samples/s , MEDIUM approx. 8 to 9 samples/s , SLOW approx. 1 sample/s
Display	LED max. 199999 (999999 for frequency)
Ancillary functions	Comparator, Average, Zero Adjust, Trigger and the Save/Load functions
Interface	External input/output,RS-232C, GP-IB(OPTION-01)
Power supply	AC 100V/120V/220V/240 V, (50/60Hz)
Dimensions and mass	approx. 215W×80H×265D mm, 2.6 kg
Accessories	9170 TEST LEAD(1)

**High-accuracy Type**  
 3238 DIGITAL HiTESTER  
 3239 DIGITAL HiTESTER  
 3238-01 DIGITAL HiTESTER (with GP-IB) 3239-01 DIGITAL HiTESTER (with GP-IB)

- OPTIONS**
- 9010 CLAMP ON PROBE (10/20/50/100/200/500 A AC)
  - 9018 CLAMP ON PROBE (10/20/50/100/200/500 A AC)
  - 9132 CLAMP ON PROBE (20/50/100/200/500/1000 A AC)
  - 9637 RS-232C CABLE (9pin-9pin, Reverse type/1.8m)
  - 9638 RS-232C CABLE (9pin-25pin, Reverse type/1.8m)
  - 9151-02/04 GP-IB CONNECTION CABLE (2 m /4 m)
  - 9442 PRINTER
  - 9443-02 AC ADAPTER (for the 9442, EU), 9443-03 (USA)
  - 9444 CONNECTION CABLE (for 9442 printer)
  - 1196 RECORDING PAPER (25 m, 10 rolls/1 set, for the 9442)

Electronic Measuring Instruments

# 3237 | DIGITAL HiTESTER

**High-speed DMM (3.3ms/sample)**  
**Minimizing tact time with sequence control at a truly affordable price**

- Samples at rates of up to 300 samples/sec. (3.3ms/ sample)
- Comparator function provides high-speed pass/fail evaluation
- Equipped with external input and output for sequence control
- Useful Save/Load function helps work go faster
- Interface supports full remote operation

3237 SPECIFICATIONS	
DC voltage (DC V)	200m/2/20/200/1000V(±0.025% rdg. ±2dgt./2V)
AC voltage (AC V)	2/20/200/750V(±0.2% rdg. ±100dgt./45 to 3kHz) True RMS
Resistance (Ω)	200/2k/20k/200k/2000k/20M/100MΩ (±0.05% rdg. ±2dgt./2k to 2MΩ)
Resistance (LPΩ)	2k/20k/200k/2000kΩ (±0.05% rdg. ±6dgt./2k to 200kΩ)
Open terminal voltage	6V DC max.(Ω, Diode check) 0.45V DC max.(LPΩ, Continuity check)
Continuity check	A built-in buzzer sounds when the resistance value is less than 50.00Ω.
Sampling rate	FAST approx. 300 samples/s , MEDIUM approx. 8 to 9 samples/s , SLOW approx. 1 sample/s
Display	LED max. 199999
Ancillary functions	Comparator, Average, Zero Adjust, Trigger and the Save/Load functions
Interface	External input/output,RS-232C, GP-IB(OPTION-01)
Power supply	AC 100V/120V/220V/240 V, (50/60Hz)
Dimensions and mass	approx. 215W×80H×265D mm, 2.6 kg
Accessories	9170 TEST LEAD(1)



**Economically Priced Type**  
 3237 DIGITAL HiTESTER  
 3237-01 DIGITAL HiTESTER (with GP-IB)

- OPTIONS**
- 9010 CLAMP ON PROBE (10/20/50/100/200/500 A AC)
  - 9018 CLAMP ON PROBE (10/20/50/100/200/500 A AC)
  - 9132 CLAMP ON PROBE (20/50/100/200/500/1000 A AC)
  - 9637 RS-232C CABLE (9pin-9pin, Reverse type/1.8m)
  - 9638 RS-232C CABLE (9pin-25pin, Reverse type/1.8m)
  - 9151-02/04 GP-IB CONNECTION CABLE (2 m /4 m)
  - 9442 PRINTER
  - 9443-02 AC ADAPTER (for the 9442, EU), 9443-03 (USA)
  - 9444 CONNECTION CABLE (for 9442 printer)
  - 1196 RECORDING PAPER (25 m, 10 rolls/1 set, for the 9442)



# 3153 AUTOMATIC INSULATION / WITHSTANDING HiTESTER

## Programmable testing, full remote control Automatic Insulation Withstanding Tester

- Insulation resistance test (DC50V~1200V), Withstanding voltage test (AC/DC5000V), full remote control in series
- Programmable testing (Testing Programs 32 files, Testing points 50 steps/file)
- Accurate testing voltage generation by PWM control method
- 3930 HIGH VOLTAGE SCANNER (Option)



### SPECIFICATIONS

<b>Withstanding test</b>	
Testing voltage	AC 0.2 to 5.00 kV 500VA (maximum 30 minutes) DC 0.2 to 5.00 kV 50VA (continuous)
Voltage setting method	Digital setting
Waveform	Sin wave
Frequency	50/60Hz DC
Measurement range	Current: 0.01 to 100.0 mA, $\pm(2\% \text{ rdg.} + 5\text{dgt.})$ 10mA/100mA(AC) AC (Average value rectified, RMS display)
<b>Insulation test</b>	
Testing voltage	DC50 to 1200V
Measurement range	0.1 to 9999M $\Omega$ , 4 ranges
Judgment function	Contents: UPPER-FAIL / PASS / LOWER-FAIL (Digital setting window comparator method)
Timer section	Setting range: 0.3 to 999 seconds
Interfaces	EXT I/O, EXT SW, RS-232C, GP-IB
Display	Fluorescent tube display (digital), Analog meter
Monitor function	Output voltage, detection current, Insulation resistance
Power supply	AC100-120V/AC200-240V, (50/60 Hz), 1000VA max.
Dimensions, mass	320W $\times$ 155H $\times$ 480D mm, 18 kg
Accessories	9615 H.V. TEST LEAD (high voltage side and return, 1 each), Power cord (1), spare fuse (1)



3930

### OPTIONS

- 9613 REMOTE CONTROL BOX (single)
- 9614 REMOTE CONTROL BOX (dual)
- 3930 HIGH VOLTAGE SCANNER
- 9267 SAFETY TEST DATA MANAGEMENT SOFTWARE
- 9637 RS-232C CABLE (Dsub 9pin-9pin, cross, 1.8m)
- 9638 RS-232C CABLE (Dsub 9pin-25pin, cross, 1.8m)



# 3159 INSULATION / WITHSTANDING HiTESTER

## Perform insulation resistance and withstand voltage testing in a single series

- Insulation resistance test (DC500V/1000V)
- Withstanding voltage test (AC5000V)
- Testing in series (Insulation resistance test to Withstanding voltage test)
- Standard Interfaces (EXT I/O, EXT SW, RS-232C, STATUS OUT)



### SPECIFICATIONS

<b>Withstanding test</b>	
Testing voltage	0 to 2.5 kV / 0 to 5.0 kV AC, dual-range configuration (Average value rectified, effective value display) 500 VA (maximum 30 minutes)
Voltage setting method	Manual adjusted transformer
Waveform	Same as the power supply waveform
Frequency	Same as the power supply frequency
Measurement range	Current: 0.01 to 120 mA, $\pm(3\% \text{ f.s.} + 20\mu\text{A})$ 2mA/8mA/32mA/120mA AC (Average value rectified, RMS display)
<b>Insulation test</b>	
Testing voltage	DC500V/1000V
Measurement range	2M $\Omega$ to 2000M $\Omega$ (500V), 4M $\Omega$ to 2000M $\Omega$ (1000V)
Judgment function	Contents: UPPER-FAIL / PASS / LOWER-FAIL (Digital setting window comparator method)
Timer section	Setting range: 0.5 to 999 seconds
Interfaces	EXT I/O, EXT SW, RS-232C
Display	Fluorescent tube display (digital), Analog meter
Monitor function	Output voltage, detection current, Insulation resistance
Power supply	120 V AC, 50/60 Hz (3159-01) 220 V AC, 50/60 Hz (3159-02) 230 V AC, 50/60 Hz (3159-03) 240 V AC, 50/60 Hz (3159-04)
Dimensions, mass	320W $\times$ 155H $\times$ 330D mm, 18 kg~21.5kg
Accessories	9615 H.V. TEST LEAD (high voltage side and return, 1 each), Power cord (1), spare fuse (1)



9267 SAFETY TEST DATA MANAGEMENT SOFTWARE

### OPTIONS

- 9613 REMOTE CONTROL BOX (single)
- 9614 REMOTE CONTROL BOX (dual)
- 9637 RS-232C CABLE (Dsub 9pin-9pin, cross, 1.8m)
- 9638 RS-232C CABLE (Dsub 9pin-25pin, cross, 1.8m)
- 9267 SAFETY TEST DATA MANAGEMENT SOFTWARE





## 3173 PORTABLE WITHSTANDING VOLTAGE HiTESTER

An Economical and Simple way to Handle Withstand Voltage Testing

- Measures between 0 to 3kV AC
- External Control (Standard)



SPECIFICATIONS	
<b>Basic Specifications</b>	
[Voltage generator]	
Output voltage range	0 to 3 kV AC (single range), 30 VA
Accuracy	±5% f.s.
Waveform	Power waveform, Synchronized to power
[Current detector]	
Current cut-off	0.1 to 9.9 mA
Current cut-off accuracy	Setting value ±(5%+0.05mA)
Evaluation method	Analog comparator PASS, FAIL a buzzer sound and external I/O
[Timer area]	
Setting range	1 to 99 sec (1-second resolution)
Timer accuracy	Setting value ±(1%+50msec)
<b>General Specifications</b>	
EXT I/O signal	START and STOP, PASS and FAIL, TEST
Power supply	120 V AC (3173-01), 220 V AC (3173-02) 230 V AC (3173-03), 240 V AC (3173-04) 50/60 Hz 50 VA
Dimensions, Mass	Approx. 149 (W) × 200 (H) × 215 (D) mm Approx. 7.0 kg (for 120 to 240 V AC)

## 3931 HIGH VOLTAGE CONTACT CHECKER

Monitor the voltage on test terminals Greatly increased reliability for voltage withstand tests



SPECIFICATIONS	
<b>Inputs</b>	
Max. allowable input voltage	5kV AC, 50/60 Hz
Max. rated voltage to earth	5kV AC, 50/60 Hz
Measurement range	200V to 5kV AC, 50/60 Hz
Waveform	Commercial power waveform, sine waveform
Threshold voltage adjustment	Manual adjustment
Voltmeter	Analog voltmeter, displays average rectified effective values 0 to 5kV AC, ± 5% f.s. (after warming up for at least 10 minutes)
Input impedance	High-voltage input, 150 MΩ ± 10% (High; 100 MΩ, Low ; 50MΩ)
<b>Detector</b>	
Threshold voltage setting range	200V to 5kV (rms)
Result output	Beeper, LED indication, EXT I/O output

## 3154 DIGITAL MΩ HiTESTER

For the laboratory to the production line, six test voltages from 25 to 1000V



RS-232C STANDARD



SPECIFICATIONS	
Measurement function	Insulation resistance (Applied DC voltage method)
Testing voltage	25, 50, 100, 250, 500, 1000 V DC
Measurement range	25 to 50 V: 2MΩ to 200 MΩ, 3 ranges 100 to 250 V: 2MΩ to 2000 MΩ, 4 ranges 500 to 1000 V: 2MΩ to 4000 MΩ, 4 ranges
Accuracy	±2 % rdg. ±5 dgt. (at 25 to 100 V testing voltage, 0 to 20.00 MΩ) (at 250 V testing voltage, 0 to 100.0 MΩ) (at 500 to 1000 V testing voltage, 0 to 999 MΩ) ±5 % rdg. (at 25 to 50V testing voltage, 19.0 to 200.0MΩ) (at 100V testing voltage, 19.0 to 2000MΩ) (at 250V testing voltage, 100.1 to 2000MΩ) (at 500 to 1000V testing voltage, 1000 to 4000MΩ)
Response times	Fast: less than 0.7 second, Slow:less than 1.5 seconds (at manual ranging)
Sampling rates	Fast: 10 samples/s, Slow:1 sample/s
Functions	Comparator functions: judgments PASS or FAIL Test time timer functions: 0.5 to 99 second Delay time timer functions: 0.1 to 99 second
Display	LED
Power supply	100 to 240 V AC (50/60 Hz)
Dimensions, mass	215W × 61H × 213D mm, 1.1 kg
Accessories	Power cord (1)

## 3158 AC WITHSTANDING VOLTAGE HiTESTER

Guarantees electrical and electronic equipment safety



RS-232C STANDARD



SPECIFICATIONS	
Test function	Withstanding test
Testing voltage	0 to 2.5kV / 0 to 5.0kV AC, dual-range configuration
Voltage testing method	Zero-toggle switch
Transformer capacity	500VA (maximum 30 minutes)
Voltage adjustment	Manually adjusted transformer
Waveform	Same as the power supply waveform
Frequency	Same as the power supply frequency
Measurement items	Voltage: 0 to 5kV AC (Average value rectified, RMS display) Current: 0.01 to 120mA AC (Average value rectified, RMS display)
Judgment function	Contents: UPPER-FAIL / PASS / LOWER-FAIL (Digital setting window comparator method)
Timer section	Setting range: 0.5 to 999 seconds
Interfaces	EXT I/O, EXT SW, RS-232C
Display	Fluorescent tube display (digital), Analog meter
Monitor function	Output voltage, detection current
Power supply	120V AC, 50/60Hz (3158-01) 220V AC, 50/60Hz (3158-03) 230V AC, 50/60Hz (3158-04)
Dimensions, mass	320W × 155H × 263D mm, 16kg (3158-01) 18kg (3158-03, -04)
Accessories	9615 HV. TEST LEAD (high voltage side and return, 1 each), Power cord (1), spare fuse (1)

# 3156 LEAK CURRENT HiTESTER

## Leakage Current Measurement Essential for Electrical Safety

- Automatically compatible with Networks stipulated by IEC/UL/JIS standards
- Automatic measurement function (Measuring power supply polarity switching as well as the normal state / single failure state)
- Stores data for 100 units
- Power supply separation



### SPECIFICATIONS

<b>Measurement mode</b>	Earth leakage current Leakage current between enclosure and earth / Leakage current between enclosure and enclosure / Leakage current between enclosure and line / Patient leakage current I / Patient leakage current II / Patient leakage current III / Patient auxiliary current
<b>Target current</b>	DC / AC / AC+DC (25mA max), AC peak (75mA max)
<b>Measurement range</b>	DC / AC / AC+DC mode ; 50µA / 500µA / 5 mA / 25 mA AC peak mode ; 500µA / 1 mA / 10 mA / 75 mA
<b>Measurement system</b>	Indication of a current value calculated based the measured drop in voltage caused by simulated resistance of the human body. Measurement of true effective value. The measurement section ; chassis-grounded and floating.
<b>Accuracy</b>	DC / AC / AC+DC mode ; ±(2.0 % rdg. + 6 dgt.) AC peak mode ; ±(2.0 % rdg. + 2 dgt.) DC mode ; ±(2.0 % rdg. + 3 dgt.)
<b>Input resistance</b>	1 MΩ ±1 % (Excluding voltmeter section, simulated resistance of the human body)
<b>Network (human simulated resistance)</b>	For medical electrical equipment / For IEC 60990 / For JIS / For UL / General-purpose 1 / General-purpose 2
<b>Functions</b>	110 % voltage application function / Wiring check function / Automatic measurement function / Application line selection function / Ground fault prevention function /

<b>Functions</b>	Setting of single-fault condition / Switching power supply polarity / Setting of measuring time / Measurement delay / Maximum value hold / Allowable value judgement / Data save / Clock / Data back up / etc.
<b>Interface</b>	EXT I/O , RS-232C , GP-IB
<b>Power supply</b>	100, 120, 220, 240 V AC (default setting) (50/60 Hz, Rated power ; 30VA)
<b>Dimensions, mass</b>	Approx. 320W × 110H × 263Dmm, 4.0 kg
<b>Accessories</b>	9170 TEST LEAD(2), 9195 ENCLOSURE PROBE(1), 9399 CARRYING CASE(1), Alligator clip(3)(2 red, 1 black) AC Power cord(2), Spare fuse(2)

### OPTIONS

- 9637 RS-232C CABLE (9-pin to 9-pin, crossing cable 1.8m)
- 9638 RS-232C CABLE (9-pin to 25-pin, crossing cable 1.8m)
- 9151-02 GP-IB CABLE (2.0m)
- 9151-04 GP-IB CABLE (4.0m)
- 9442 PRINTER
- 9443-02 AC ADAPTER (for printer, for use in EU)
- 9443-03 AC ADAPTER (for printer, for use in USA)
- 9444 CONNECTION CABLE (for printer)
- 1196 RECORDING PAPER (for printer)
- 9686 CARRYING CASE (with casters)
- 9267 SAFETY TEST DATA MEASUREMENT SOFTWARE

# 3157-01 AC GROUNDING HiTESTER

## Protective ground tester indispensable for standard certification



### SPECIFICATIONS

<b>Measurement items</b>	Low resistance, AC 4-terminal method
<b>Generator section</b>	Current generator principle: PWM constant current control, Current setting range: 3.0A to 31.0A (0.1A resolution), into 0.1Ω load, Maximum output power: 130VA (at output terminals) Subject to derating according to ambient temperature (80% at 40°C) Frequency: 50Hz or 60Hz sine wave Soft start function: Apply current only after checking load connection
<b>Monitor section</b>	Resistance measurement: 0 to 1.800Ω (0.001Ω resolution), Accuracy: ±2% rdg. ±4 dgt. (after zero-adjust), Current monitoring range: 0 to 35.0A AC (0.1A resolution), Monitoring cycle: 2 times/second
<b>Other functions</b>	Timer setting: Counts down time after start until preset time, or shows elapsed time after start, Setting range: 0.5 to 999 second, Comparator: Pass/Fail evaluation using preset upper/lower limit, I/O output, Memory function: max. 20 settings (with save/load)
<b>Display</b>	Fluorescent tube digital display
<b>Power supply</b>	100 to 120V, 200 to 240V AC (auto-switching), 50/60Hz
<b>Dimensions, mass</b>	320W × 90H × 263D mm, 7kg
<b>Accessories</b>	Power cord(1), Spare fuse(1), Shorting bar(2)



## 7016 SIGNAL SOURCE



### Signal Generator with DMM

- Constant voltage 0 to ± 1.5000V 0 to ± 15.000V
- Constant current 0 to ± 25.000mA
- Pulse generation and measurement



#### OPTIONS

- 3856-01 COMMUNICATION PACKAGE(RS-232C)
- 3856-02 COMMUNICATION PACKAGE(USB)
- \*9180 SHEATH TYPE TEMPERATURE PROBE
- \*9181 SURFACE TYPE TEMPERATURE PROBE
- \*9182 SHEATH TYPE TEMPERATURE PROBE
- \*9183 SHEATH TYPE TEMPERATURE PROBE(class1)
- 9472 SHEATH TYPE TEMPERATURE PROBE(class1)
- 9473 SHEATH TYPE TEMPERATURE PROBE(class1)
- 9474 SHEATH TYPE TEMPERATURE PROBE(class1)
- 9475 SHEATH TYPE TEMPERATURE PROBE(class1)
- 9476 SURFACE TYPE TEMPERATURE PROBE
- 3851-10 TEST LEAD (Lead length:1m/standard accessories)

\*Non-CE mark products

#### SPECIFICATIONS

<b>Generator functions and Accuracy</b>	<b>Constant voltage:</b> 0 to ±1.5V, 100μV resolution, 0 to ±15V, 1mV resolution, Sink/source: ±25mA, ±0.03% of setting ±3dgt. <b>Constant current:</b> 0 to ±25mA, 1μA resolution, Sink/source: ±12V, ±0.03% of setting ±5dgt. <b>Pulse signal generation:</b> 0.5 to 4800Hz, 28 ranges, ±0.005% of setting ±0.01Hz
<b>Measurement functions and Basic accuracy</b>	<b>DC Voltage:</b> 50mV to 250V, 6 ranges, ±0.03% rdg. ±5dgt. <b>AC Voltage:</b> 50mV to 250V, 6 ranges, ±0.7% rdg. ±20dgt. <b>AC+DC Voltage:</b> 50mV to 250V, 6 ranges, ±0.8% rdg. ±25dgt. <b>DC Current:</b> 50 to 500mA, 2 ranges, ±0.03% rdg. ±5dgt. <b>AC Current:</b> -50 to 500mA, 2 ranges, ±0.6% rdg. ±20dgt. <b>AC+DC Current:</b> 50 to 500mA, 2 ranges, ±0.7% rdg. ±40dgt.
<b>Measurement functions and Accuracy</b>	<b>Resistance:</b> 500Ω to 50MΩ, 6 ranges, ±0.15% rdg. ±5dgt. <b>Diode &amp; Continuity check:</b> Possible <b>Temperature:</b> -40 to 1372°C, ±0.3% rgt. ±3°C (K type thermocouple, °F display possible) <b>Frequency:</b> 100Hz to 200kHz, 5 ranges, ±0.02% rdg. ±3dgt.
<b>Display</b>	LCD with backlight 51,000 counts
<b>Power supply</b>	LR6(AA)8pieces, included Ni-MH battery pack, or included AC adapter
<b>Dimensions, mass</b>	90W×192H×54D mm, 735g(instrument only)
<b>Accessories</b>	Carring case(1), AC adapter(1), Battery(8), 3851 TEST LEAD(1), Alligator clips(1), Yellow test lead(1), Test leads(1)

## 7011 DC SIGNAL SOURCE

### All-in-one Signal source

- Check thermocouple temperature sensors
- Generate various signals for electronic circuit and equipment testing
- Calibrate industrial equipment all with a single unit



#### OPTIONS

- 9184 RJ SENSOR (for reference contact compensation)
- 9380 CARRYING CASE
- 9418-10 AC ADAPTER
- 9420 BATTERY PACK (7.2V /700mAh)

#### SPECIFICATIONS

<b>Generator functions and Accuracy</b>	<b>Constant voltage:</b> 0 to ±2.5 V, 100μV resolution, 0 to ±25 V, 1 mV resolution, Sink /source: ±25 mA, ±0.03% of setting ±3 dgt. <b>Constant current:</b> 0 to ±25 mA, 1μA resolution, Sink /source: ±25 V, ±0.03 % of setting ±3 dgt.
<b>Thermoelectric power</b>	TC (0°C/TC(RJ) <b>K:</b> -176.0 to 1372.0°C, <b>E:</b> -220.0 to 839.0°C, <b>J:</b> -208.0 to 1108.0°C, <b>T:</b> -169.0 to 400.0°C, <b>R:</b> -50 to 100°C, 101 to 1769°C, <b>S:</b> -50 to 100°C, 101 to 1769°C, <b>B:</b> 300 to 600°C, 601 to 1820°C
<b>Basic Accuracy</b>	±0.05% of setting ±0.5°C (at Thermoelectric power K)
<b>Measurement functions and Accuracy</b>	<b>Voltage:</b> 0 to ±2.5 V, 100μV resolution, 0 to ±25 V, 1 mV resolution, Input resistance: 1 MΩ, ±0.03% rdg. ±2 dgt. <b>Current:</b> 0 to ±25 mA, 1μA resolution, Input resistance: 25Ω, ±0.03 % rdg. ±2 dgt.
<b>Temperature</b>	-25.0 to 80.0°C, 0.1°C resolution (using the 9184)
<b>Standard resistance</b>	100Ω, ±0.2 % rdg.
<b>Power supply</b>	LR6(alkaline) 6 pieces, 9420 BATTERY PACK(Ni-Cd), or 9418-10 AC ADAPTER
<b>Dimensions, mass</b>	104W×180H×58D mm, 590 g (excluding batteries)
<b>Accessories</b>	9168 INPUT CORD(1), 9170 TEST LEAD(1), Fuse(3)

## 7075 7075-01 WAVEFORM GENERATOR

### Arbitrary waveform generator with four independently controllable channels

- Even for complex signals, evaluation is made easy
- Easy touch panel operation
- Multiple channels, 4CH (7075), 2CH (7075-01)
- Large 128,000-Word/channel memory, sweep sequence functions



#### OPTIONS

- **Output cord**  
9165 CONNECTION CORD BNC to BNC, 1.5 m length  
9166 CONNECTION CORD BNC to clip, 1.5 m length
- **PC communication**  
9151-02 GP-IB CONNECTION CABLE 2 m length  
9151-04 GP-IB CONNECTION CABLE 4 m length

#### SPECIFICATIONS

<b>Number of channels</b>	7075: 4-channels, 7075-01: 2-channels
<b>Output functions</b>	Function generator, Arbitrary waveform generator (for each channel)
<b>Max. output voltage</b>	10 V range: 10 mV to 10 V o.c. (1 mV resolution) 1 V range: 1 mV to 1 V o.c. (0.1 mV resolution) 0.1 V range: 0.1 mV to 0.1 V o.c. (0.01 mV resolution) (o.c.:open-circuit)
<b>Minimum load impedance</b>	40 Ohm
<b>Output impedance</b>	50 Ohm±2 % (DC)
<b>Function generator mode</b>	Waveform types: sine, square (fixed 50 % duty), triangle, ramp-up, ramp-down, pulse, noise, DC, Frequency range:sine (10 mHz to 10 MHz), square (10 mHz to 10 MHz), triangle (10 mHz to 200 kHz), pulse (10 mHz to 200 kHz)
<b>Arbitrary waveform generation mode</b>	Voltage axis resolution: 16 bits (64000 counts) Waveform memory capacity: 128 kW/ch Filtering: 2-stage LPF, 50 Hz to 1 MHz, 14 steps, Waveform input methods: FD/GP-IB (direct download from MEMORY HiCORDER by FD or GP-IB), or RS-232C download (at use of 7990), Arbitrary waveform clock: Max. 4ch, Frequency range: 10 mHz to 10 MHz (10 mHz resolution)
<b>Display</b>	5.7-inch LCD (with touch panel)
<b>Data storage</b>	FDD×1, MS-DOS format
<b>Power supply</b>	100/120/200/230 V AC/auto selects, (50/60 Hz)
<b>Dimensions, mass</b>	345W×130H×286Dmm, 7075: 7.8 kg, 7075-01:7.5 kg
<b>Accessories</b>	7990 WAVEFORM CREATION SOFTWARE (CD-R×1)

# Environmental Measuring Instruments



## Environmental Measuring Instruments Index

### Temperature measurement



**3441/3442** €€  
-100 °C to 1300 °C  
Choose from Basic or  
Waterproof models

..... p.30



**3446-01, 3447-01** €€  
-100°C to 1000°C 1 ch (3446)  
-100°C to 300°C 2 ch (3447)  
with built-in memory



**3412-50**  
-50 °C to 999 °C  
With analog output

### Rotation, Illumination



**3403** Rotation €€  
30 to 100,000 r/min  
**3404** Rotation €€  
30 to 100,000 r/min,  
Max. /Min. /Total /Period  
..... p.31



**3423** Illumination €€  
20 to 200,000 lx, digital

..... p.31

### Non-contact temperature measurement (via infrared radiation energy)



**3415-01** €€  
-50 °C to 500 °C  
Two-beam laser marker  
Narrow field  
measurement



**3416-01** €€  
-50 °C to 500 °C  
LED spot marker  
Spot measurement



**3418** €€  
-50 °C to 500 °C  
Without laser marker  
Narrow field  
measurement



**3443** €€  
-50.0 °C to 500.0 °C  
Two-beam laser marker  
Narrow field measurement  
Data memory, Memory dump to  
printer, RS-232C interface  
..... p.30



**3444** €€  
-50.0 °C to 500.0 °C  
Two-beam laser marker  
Narrow field measurement  
MAX. MIN. indication, Analog  
output, RS-232C interface  
..... p.30



**3445** €€  
-50.0 °C to 500.0 °C  
Two-beam laser marker  
Spot measurement  
MAX. MIN. indication, Analog  
output, RS-232C interface  
..... p.30

### Data Loggers (Temperature/Humidity/Instrumentation/DC-Voltage/AC-Current/AC-Voltage/Leak-Current)



**2300 Series**  
Remote Measurement System  
Various measurement modules  
Internal memory  
LAN or SS Air Module

..... p.28



**3641-20, 3632-20, 3633-20** €€  
Temperature/Humidity  
-40~85°C 0~100% rh  
(using the 9680 sensor)  
-40.0 °C to 180.0 °C  
(external sensor)

..... p.29



**3634-20** €€  
Instrumentation  
0 to 20.00 mA DC

..... p.29



**3635-24, -25, -26** €€  
DC Voltage  
-24: ±500.0 mV DC  
-25: ±5.000 V DC  
-26: ±50.00 V DC

..... p.29



**3636-20** €€  
AC Current (2ch)  
0 to 50.00/500.0 A AC

**3637-20** €€  
AC Voltage (1ch)  
0 to 600.0 V AC

..... p.29



**3638-20** €€  
AC Leak Current  
(2ch) with clamp-on leak  
sensor

..... p.29

### Data Loggers (Pulse/Illumination/DC-Voltage/Communication Base)



**3639-20** €€  
Pulse Totalizer  
9,999counts/interval  
(1ch)

..... p.29



**3640-20** €€  
Illumination  
2000/20000/200000 lx  
(1ch)

..... p.29



**3645-20** €€  
Multi-range  
Voltage Logger  
with preheat  
signal function

..... p.29



**3911-20, 3912-20** €€  
Communication Base  
to analyze and process  
on a personal computer  
..... p.29

### Temp Logger



**3650**  
Temperature -40°C to 85°C  
Data memory of 2048 data  
Button battery size

## 2300 Series REMOTE MEASUREMENT SYSTEM

### Easily Construct a Centralized Data Management System for Monitoring Multiple Locations

LAN Module that paves the way for a low cost remote measuring system by utilizing existing data network

# Smart Site



- Various measurement modules for temperature and humidity, instrumentation, and pulse
- Power measurement module for multiple circuits
- Large internal memory to avoid data loss due to communication problems
- Communication module with built-in real-time clock tracks the data of each measurement module to the second
- SS Air Module for constructing wireless systems



**RS-232C** 2343-20  
**LAN** 2353-20

<b>2301-20 HUMIDITY MODULE</b>	Temperature 1ch and humidity 1ch. Use with optional sensor 9764 Temperature: -40.0 to 85.0°C Humidity: 0.0 to 100%RH
<b>2302-20 Pt MODULE</b>	Temperature 2ch (Pt100) 2 types of platinum resistance thermo sensors available
<b>2303-20 TC MODULE</b>	2ch temperature measurement using thermocouples (K, E, J, T). 4 TC types available
<b>2304-21 PULSE MODULE</b>	For 2ch pulse input (voltage, contact), maximum 16M pulses/ interval Input pulse: 4kHz max. (voltage/electronic contact signal) 25Hz max. (mechanical contact signal)
<b>2305-20 INSTRUMENTATION MODULE</b>	Voltage / current 2ch measurement, for 4-20mA, 1-5V instrumentation signals
<b>2331-20 POWER METER MODULE</b>	For single circuit power measurement. Single-phase 2-wire to 3-phase 4-wire Voltage: AC 100/200V Current: AC 5A (with 9695-02 CLAMP ON SENSOR), AC 50A (with 9695-02), AC 100A (with 9695-03 or 9661-01), AC 500A (with 9661-01)
<b>2332-20 POWER METER MODULE</b>	For multiple circuit power measurement: from 6 circuits of single-phase 2-wire to 3 circuits of 3-phase 3-wire installations Voltage: AC200V (100V accepted at 200V range) Current: AC 5A (with 9695-02 CLAMP ON SENSOR), AC 50A (with 9695-02), AC 100A (with 9695-03 or 9661-01), AC 500A (with 9661-01) *3-phase 4-wire circuit cannot be measured
<b>2341-20 INPUT MODULE</b>	For recording the status of contact signals Input 8 ch, Input internal bus isolated Easily capture on/off status with LED
<b>2342-20 OUTPUT MODULE</b>	Acts as receiver of higher order external control device, outputs control signals and monitors data of measurement modules Output 8ch (Open corrector output), Output internal bus isolated

<b>2343-20 RS LINK MODULE</b>	For communicating with RS-232C interface equipped instruments Interface: RS-232C, Transfer speed: 57.6kbps(max.) Please inquire regarding compatible instruments. (Existing compatible HIOKI instruments include Models 3331 and 3332.)
<b>2351 AIR MODULE</b>	2.4GHz band SS radio system (RS-232C equipped) Transfer speed: 51.9kbps(fixed), RS-232C: 57.6kbps(max.) 2351-20 : For EU 2351-21 : For USA
<b>2352-20 WIRE MODULE</b>	For small-scale measurement systems or built-in use Interface: RS-232C, Transfer speed: 57.6kbps(max.)
<b>2353-20 LAN MODULE</b>	For data logging via LAN Interface: 10BASE-T
<b>2361-20 AC POWER MODULE</b>	Power supply for the communication modules and measurement modules (max. 10 modules) Input: AC 100 to 240V, Output: DC5V/2.4A
<b>2362-20 DC POWER MODULE</b>	Power supply for the communication modules and measurement modules (max. 10 modules) Input: DC 19 to 36V, Output: DC5V / 2.4A
<b>2391 MODULE BASE</b>	For connecting modules (3 slots reserved for power supply and communication module) 2391-01: For relay and master station, 2391-02: 5 measurement module slots, 2391-03: 10 measurement module slots *Model 2331 uses 2 slots
<b>2392 MODULE BASE</b>	For connecting MODULE BASES (also connects with additional MODULE BASES for increased measurement capabilities) 2392-01: 1 slot; includes power and internal bus connection terminal 2392-02: 2 slots; connect with 2391-01 for additional measurement module slots * POWER MODULE not compatible; must use with Model 2392-01 to access POWER MODULE

# 3630 Data Loggers

## Data Loggers for All Types of Measurements

### For HACCP-related Temperature and Humidity Recording

#### HUMIDITY LOGGER

#### TEMPERATURE LOGGERS

3641-20



Can alternately record temperature and humidity on two channels for temperature and humidity measurement  
-40.0 °C to 85.0 °C  
0.0 %rh to 100.0 %rh

3632-20



Waterproof with built-in sensor for temperature measurement  
Range: -20.0 °C to 70.0 °C

3633-20



External sensor for temperature measurement  
-40.0 °C to 180.0 °C

### For Recording Voltage

#### VOLTAGE LOGGERS

3635-24, -25, -26



For measurement DC voltage  
-24: ± 500.0 mV DC  
-25: ± 5.000 V DC  
-26: ± 50.00 V DC

3645-20



With preheat function  
For measuring DC voltage  
Range: ± 50.00 mV to ± 50.00 V DC

3637-20



For measuring AC voltage  
Range: 600.0 V AC

### For Recording Precipitation or Illumination

#### PULSE LOGGER

#### ILLUMINATION LOGGER

3639-20



For cumulative pulse measurement for precipitation gauges, flow gauges, etc.

3640-20



For illumination measurement  
Range: 2,000 lux to 200,000 lux

### For Recording Load Current and Monitoring Leak Current

#### INSTRUMENTATION LOGGER

#### CLAMP LOGGER

#### LEAK LOGGER

3634-20



For measuring typical instrumentation signals  
Range: 20.00 mA DC

3636-20



For measuring alternating current on two channels  
Range: 50.00/500.0 A AC  
(Clamp sensors sold separately)

3638-20



For measuring alternating current on two channels  
Range: 100.0/1000 mA AC  
(Clamp sensors sold separately)



3912-20: OPTION

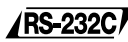

3911-20: OPTION



<b>Accessories</b>					
<p>9680 HUMIDITY SENSOR Cord length: 1 m</p>	<p>9632 CONNECTION CABLE Cord length: 1 m</p>	<p>9639 CONNECTION CORD Cord length: 3 m</p>	<p>9629 CONNECTION CABLE Cord length: 5 m</p>	<p>9662 LUX SENSOR Cord length: 2 m</p>	
<b>Options for 3634-20</b>		<b>Options for 3636-20</b>		<b>Options for 3638-20</b>	
<p>9633 CONNECTION CABLE Cord length: 1 m</p>	<p>9634 CONNECTION CABLE Cord length: 1 m</p>	<p>9650 CLAMP ON SENSOR AC 100 A f.s./Up to φ 15 mm Cord length: 3 m</p>	<p>9651 CLAMP ON SENSOR AC 500 A f.s./Up to φ 46 mm Cord length: 3 m</p>	<p>9657 CLAMP ON SENSOR AC 1.0 A f.s. / Up to φ 40 mm Cord length: 3 m</p>	<p>9658 CLAMP ON SENSOR AC 1.0 A f.s. / Up to φ 12 x 30 mm Cord length: 3 m</p>
<b>Options for 3641-20 / 3633-20</b>					
<p>9680/9680-01/9680-02 HUMIDITY SENSOR (for 3641-20) -40.0 °C to 85.0 °C 0.0 %rh to 100.0 %rh Cord length: 9680: 1 m (provided), 9680-01: 5 m, 9680-02: 10 m</p>	<p>9631-01/9631-11/9631-21 TEMPERATURE SENSOR (Molded plastic type) -40.0 °C to 180.0 °C Cord length: 9631-01: 1 m, 9631-11: 5 m, 9631-21: 10 m</p>	<p>9631-02 TEMPERATURE SENSOR (Needle type) -40.0 °C to 120.0 °C Cord length: 1 m</p>	<p>9631-03 TEMPERATURE SENSOR (Sheathed type) -40.0 °C to 120.0 °C Cord length: 1 m</p>	<p>9631-05 TEMPERATURE SENSOR (Molded plastic type) -40.0 °C to 180.0 °C Cord length: 30 mm</p>	<p>9631-04/9631-14/9631-24 TEMPERATURE SENSOR (Lug type) -30.0 °C to 180.0 °C Cord length: 9631-04: 1 m, 9631-14: 5 m, 9631-24: 10 m</p>

# 3911-20 | 3912-20 COMMUNICATION BASE

## Analyze and Process Data on a Personal Computer

The 3911-20, 3912-20 COMMUNICATION BASE are used to transfer data to a personal computer.



3912-20

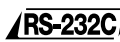

3911-20



3911-20

3912-20

Communication software included with the 3911-20, 3912-20  
Compatible OS: Windows 95/98/NT4.0/Me/2000/XP

### 3911-20, 3912-20 SPECIFICATIONS

<b>Recording Capacity</b>	Max. 16,000 data points × 16 ch, 32,000 data points × 8 ch,
<b>Communication method</b>	RS-232C (3911-20 to a PC) USB 1.1 (3912-20 to a PC)
<b>Power supply</b>	4 × 1.5 V, LR03 (AAA) alkaline dry cell batteries
<b>Dimensions and mass</b>	3911-20: 69W×92H×36D mm, 150g (including batteries) 3912-20: 69W×128H×36D mm, 180g (including batteries)
<b>Accessories</b>	3911-20: LR03 (AAA) alkaline dry cell batteries (4), Communication software (1) 3912-20: USB cable (1), LR03 (AAA) alkaline dry cell batteries (4), Communication software (1)

### Options for 3911-20

<p>9637 RS-232C CABLE 9-pin to 9-pin crossed cable/1.8 m</p>	<p>9638 RS-232C CABLE 9-pin to 25-pin crossed cable/1.8 m</p>
--	---

## 3441 | 3442 | TEMPERATURE HiTESTER

Supports temperature management demands of various applications

- Compact and weighing only 160g
- More than 200 hours of continuous operation on a single battery
- An assortment of 9 optional temperature sensors
- 3442 : Waterproof construction



3441,3442 : SPECIFICATIONS	
Material type	K type thermocouple (Chromel /Alumel)
Measurement range	-100°C to 1300°C (-148°F to 2372°F) The actual measurement range is restricted by the temperature probe.
Resolution	0.1°C*1 or 1°C*2
Unit Accuracy	±0.1% rdg. ±0.8°C (1.5°F)*1 or ±0.2% rdg. ±1°C (1.8°F)*2 (in addition to accuracy of temperature sensor) *1 during measurement from -100 to 199.9°C (-148°F to 392°F) *2 during measurement from 200 to 1300°C (392°F to 2372°F)
Display	LCD
Sampling rate	2 times/second
Contact compensation	Auto compensation
Functions	Max/Min temperature recording and display, display data hold, sensor discontinuity display, Over-range display, °C/°F display switching (3441-02, 3442-03), auto power save, low battery warning
Place of use	Indoor use to altitude of 2000 m
Power supply	R6P (AA)×4, or LR6 (AA)×4
Operating time	200 hours or better of continuous use (with manganese battery)
Dimensions, mass	74W×155H×24D mm, 160 g
Accessories	Strap band(1), R6P(AA) Batteries(4)

OPTIONS	
9180 SHEATH TYPE TEMPERATURE PROBE	(up to 750 °C)
9181 SURFACE TYPE TEMPERATURE PROBE	(up to 400 °C)
9182 SHEATH TYPE TEMPERATURE PROBE	(up to 750 °C)
9183 SHEATH TYPE TEMPERATURE PROBE	(up to 750 °C)
9386 CARRYING CASE	
9476 SURFACE TYPE TEMPERATURE PROBE	(up to 500 °C) (waterproof structure models)
9472 SHEATH TYPE TEMPERATURE PROBE	(up to 300 °C)
9473 SHEATH TYPE TEMPERATURE PROBE	(up to 800 °C)
9474 SHEATH TYPE TEMPERATURE PROBE	(up to 300 °C)
9475 SHEATH TYPE TEMPERATURE PROBE	(up to 500 °C) (refer to P.57)

## 3443 | 3444 | 3445 | TEMPERATURE HiTESTER

Non-contact measurement, quick and easy temperature management

- Ideal for daily temperature checks -- 3443 with integrated memory
- For temperature monitoring -- 3444, 3445 with real-time output
- Dedicated software (option) -- For date analysis and management
- Use in tough environments -- dust/splash-proof design (IP54)



3443 : SPECIFICATIONS	
Measurement range	-50.0°C to 500.0°C, 0.1°C resolution
Measurement field diameter	ø24mm at a distance of 1 m
Accuracy	±1 % rdg. (at 200.1 to 500.0 °C), ±2°C (at 0.0 to 200.0 °C), ±10 % rdg. ±2°C (at -50.0 to -0.1 °C)
Response time	1.6 seconds (95% response)
Date memory function	130 points of data, memory dump to printer
Analog output function	None
Interface	RS-232C output (requires 3909 INTERFACE PACK)
Other functions	Auto power save, low battery warning, auto-hold
Power supply	6F22(006P)× 1, or AC adapter
Operating time	Continuous use of 20 hours (light on) and 50 hours (light off)
Dimensions, mass	47W × 200H × 48D mm, 280 g
Accessories	Carrying case(1), hand strap(1), 6F22(1), screwdriver(1)

3444, 3445 : SPECIFICATIONS	
Measurement range	-50.0°C to 500.0°C, 0.1°C, 0.1 or 1°C resolution switchable
Measurement field diameter	3444 : ø24mm at a distance of 1 m 3445 : ø2.5mm at a distance of 7 cm
Accuracy	±1 % rdg. (at 200.1 to 500.0 °C), ±2°C (at 0.0 to 200.0 °C), ±10 % rdg. ±2°C (at -50.0 to -0.1 °C)
Response time	1.6 sec (95% at 0.1°C resolution), 0.7 sec (95% at 1°C resolution)
Date memory function	None
Analog output function	Possible (requires 3909 INTERFACE PACK)
Interface	RS-232C output (requires 3909 INTERFACE PACK)
Other functions	Auto power save, low battery warning
Power supply	6F22(006P)× 1, or AC adapter
Operating time	Continuous use of 20 hours (light on) and 50 hours (light off)
Dimensions, mass	47W × 200H × 48D mm, 280 g
Accessories	Carrying case(1), hand strap(1), 6F22(1), screwdriver(1)

- OPTIONS**
- 3909 INTERFACE PACK
  - \*BLACK BODY SPRAY  
(ε= 0.95, 180ml, 2-coat coverage about 1.0m<sup>2</sup>, good to 550 °C)
  - \*BLACK BODY TYPE  
(ε= 0.95, 50mm×10mm, 1roll, good to 180 °C)

\*Note: Used for accurate measurement of the temperature of objects which have low thermal emissivity (ε) such as polished metal, and for calibrating thermal emissivity.

# 3423 LUX HiTESTER

Digital illumination meter, maximum scale of 199,900 lx

- Easy-to-operate, hand-held unit
- From low light up to a maximum intensity of 199,900lx
- For illumination equipment, lighting work, and facility management



### 3423 : SPECIFICATIONS

Measurement range	20 to 200,000 lx full-scale, 5 ranges
Accuracy	±4 % rdg. ±1 dgt. (environment temperature: 23 ±5°C)
Display	1999 full digits, LCD with EL backlight (Note : in the 20,000 lx range, the maximum is 19990 /10 digits steps, and in the 200,000 lx range, the maximum is 199900 /100 digits steps)
Response time	5 sec. or less (auto range), 2 sec. or less (manual range)
Receptor element	Silicon photodiode
Other functions	Sensor separate: Permits remote measurement with the sensor separated from the main unit.(using the 9436) Analog output: 200 mV DC at full scale rate
Power supply	R6P (AA) × 2 (Continuous use of 25 hours) or AC adapter (6 V, 300 mA)
Dimensions, mass	74W × 170H × 30D mm, 310 g (including the dry cells)
Accessories	9376 CARRYING CASE(1), Sensor cap(1), R6P(2)

### OPTIONS

- 9436 CONNECTING CABLE (with case, 2 m length)
- 9094 OUTPUT CORD (1.5 m length)

# 3403 3404 TACHO HiTESTER

Precise rotation speed meter

- Minimum 0.01 r/min resolution and high ±1 digit precision make the tachometer effective for precise measurements.
- By using the optional 9213 contact adapter, the 3403/3404 become contact-type tachometers, while the period ring can be used in applications like measurement of conveyer line speed.
- LED and buzzer signals confirm that the light pulses reflected from the tape on the rotating body are being picked up.
- MIN/MAX mode, TOTAL mode, PERIOD mode, FAST/SLOW sampling mode, and Analog output Multi-function performance for the 3404 only.



### 3403: SPECIFICATIONS

Measurement ranges	r/min: rotation per minute, r/s: rotation per second r/min: (30.00 to 199.99)range to (20000 to 99990)range, 4 ranges, r/s: (0.5000 to 1.9999)range to (200.0 to 1600.0)range, 4 ranges
Sampling period	0.5 second to 2 seconds
Detection distance	Distance of 50 mm to 200 mm
Analog output	None
Power supply	R6P (AA) × 4 (continuous use of 17 hours) or AC Adapter (6 V, 300 mA)
Dimensions, mass	62W × 180H × 38D mm, 260 g
Accessories	9211 REFLECTIVE TAPE(1Sheet), Carrying case(1)

### 3404: SPECIFICATIONS

Measurement ranges	r/min: (30.00 to 199.99)range to (20000 to 99990)range, 4 ranges (at slow sampling mode) r/s: (0.5000 to 1.9999)range to (200.0 to 1600.0)range, 4 ranges (at slow sampling mode) Total: Total rotation counts from 0 to 599999 Period: Measure rotation pulses from 600µs to 2 sec.
Sampling period	Slow: 0.5 sec. to 2 sec., Fast: 0.1 sec. to 0.5 sec.
Detection distance	Distance of 50 mm to 200 mm
Analog output	1V DC at full-scale range output
Power supply	R6P (AA) × 4 (continuous use of 16 hours) or AC Adapter (6 V, 300 mA)
Dimensions, mass	62W × 180H × 38D mm, 260 g
Accessories	9211 REFLECTIVE TAPE (1Sheet), 9094 OUTPUT CORD (1), Carrying case (1)

### OPTIONS

- 9211 REFLECTIVE TAPE  
(30 pieces /sheet, 10 sheets /1 set, 12 mm×12 mm /1 piece size)
- 9213 CONTACT ADAPTER SET  
(includes 9032×1, 9033×2, 9212×1)

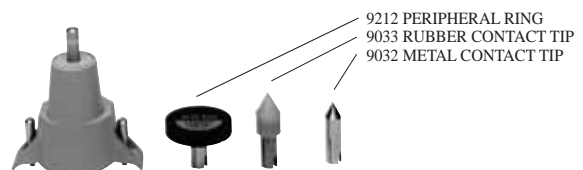









# Clamp Sensors









## Clamp Sensors Index

### Wide-band frequency, high-precision, ideal for observing waveforms (for AC / DC)

 <p><b>3273-50/3276</b> DC to 50 MHz / 100 MHz 15 A / 30 A maximum 0.1 V / A output ø 5 mm core jaw dia. ..... p.33</p>	 <p><b>3274</b> DC to 10 MHz 150 A maximum 0.01 V / A output ø 20 mm core jaw dia. ..... p.33</p>	 <p><b>3275</b> DC to 2 MHz 500 A maximum 0.01 V / A output ø 20 mm core jaw dia. ..... p.33</p>	 <p><b>3272/3269</b> Power supply for 3273-50, 3274, 3275, 3276 Single sensor (3272) Four sensors (3269) ..... p.33</p>	 <p><b>9274</b> DC to 10 MHz 20A rated 2V / 20A output ø5mm core jaw dia.</p>	 <p><b>9276</b> DC to 1 MHz 150A rated 1.5V / 150A output ø20mm core jaw dia.</p>	 <p><b>3270</b> Power supply &amp; amplifier for 9274,9276 1V / range output Single sensor connectable</p>
--	--	---	--	---	--	---

### High-precision sensors to view waveforms or to use with power meters (for AC/DC, or AC only)

 <p><b>9277</b> DC to 100 kHz 20 A rated 2 V / 20 A output ø 20 mm core jaw dia. ..... p.34</p>	 <p><b>9278</b> DC to 100 kHz 200 A rated 2 V / 200 A output ø 20 mm core jaw dia. ..... p.34</p>	 <p><b>9279</b> DC to 20 kHz 500 A rated 2 V / 500 A output ø 40 mm core jaw dia. ..... p.34</p>	 <p><b>9270</b> 5Hz to 50kHz, 20A rated 2V / 20A output ø 20 mm core jaw dia. <b>9271</b> 200A rated 2V / 200A output</p>	 <p><b>9272</b> 10 Hz to 10 kHz 20 or 200 A rated 2 V / 20 or 200 A output ø 46 mm core jaw dia.</p>	 <p><b>9555</b> Power supply for 9270, 9271, 9272, 9277, 9278, 9279 Single sensor connectable ..... p.34</p>
---	---	--	---	---	--







### For power lines (50/60 Hz use)

### Conversion Adapter

 <p><b>9010, 9010-10</b> 40Hz to 1kHz 10A to 500A range 200mV / range output ø46mm core jaw dia. ..... p.34</p>	 <p><b>9018, 9018-10</b> 40Hz to 3kHz 10A to 500A range 200mV / range output ø46 mm core jaw dia. ..... p.34</p>	 <p><b>9132, 9132-10</b> 40Hz to 1kHz 20A to 1000A range 200mV / range output ø55 mm core jaw dia.</p>	 <p><b>9005-01</b> 50Hz or 60Hz 3A to 300A range 300mV / range output ø46 mm core jaw dia.</p>	 <p><b>9290-10</b> AC current up to 1500 A, secondary current 1/10 of primary, ø 55 mm dia. or 88 mm width Superior phase angle characteristics</p>	 <p><b>CT-101A</b> AC current up to 15 A, secondary current 1/1 or 10 times of primary, ø 25 mm dia.</p>	 <p><b>9657-10/9675</b> 9657-10 LEAK CLAMP ON SENSOR AC 25mV/A Up to ø 40mm 9675 LEAK CLAMP ON SENSOR AC100mV/A Up to ø 30mm</p>
--	---	---	---	---	---	---

### Clamp Sensors for 3169/3196 Power meters

### Clamp Sensors for 8205-10/8206-10, 3636-20

 <p><b>9660</b> 45Hz to 5kHz (±1%) AC current up to 100A AC 1mV / A output ..... p.37</p>	 <p><b>9661</b> 45Hz to 5kHz (±1%) AC current up to 500A AC 1mV / A output ..... p.37</p>	 <p><b>9667</b> 10Hz to 20kHz (±3dB) AC current up to 5000/500A AC 0.1mV / A, AC 1mV / A output ..... p.37</p>	 <p><b>9669</b> 40Hz to 1kHz (2.0%) AC current up to 1000 A AC 0.5mV / A output ..... p.37</p>	 <p><b>9650</b> 40Hz to 1kHz (±8%) AC current up to 100A Secondary current 100mA AC ..... p.13</p>	 <p><b>9651</b> 40Hz to 1kHz (±3%) AC current up to 500A Secondary current 500mA AC ..... p.13</p>	 <p><b>9668</b> 40Hz to 1kHz (±3%) AC current up to 1000A Secondary current 1000mA AC ..... p.13</p>
--	--	---	---	--	---	---

# 3273-50 | 3274 | 3275 | 3276 | CLAMP ON PROBE

## 3269/3272 | POWER SUPPLY

Wide-range current probe allows direct input to oscilloscope

- 3273-50/3276: Wide Band from DC to 50/100 MHz, For Large Current Measurements (30 A rms)
- 3274/3275: Wide Band from DC to 10/2 MHz, For Large Current Measurements (150/500 A rms)



**3276: CLAMP ON PROBE**  
Wide-band model from DC to 100 MHz

**SPECIFICATIONS**

	<b>3273-50</b>	<b>3276</b>	<b>3274</b>	<b>3275</b>
<b>Frequency bandwidth</b>	DC to 50MHz (-3dB)	DC to 100 MHz (-3dB)	DC to 10MHz (-3dB)	DC to 2MHz (-3dB)
<b>Rise time</b>	7 ns or less	3.5 ns or less	35 ns or less	175 ns or less
<b>Continuous maximum input range</b>	30A rms	30A rms	150A rms	500A rms
<b>Maximum peak current</b>	Non-continuous 50A peak	Non-continuous 50 Apeak	Non-continuous 300A peak 500A peak at pulse width of ≤ 30μs	Non-continuous 700A peak
<b>Output voltage rate</b>	0.1V/A	0.1V/A	0.01V/A	0.01V/A
<b>Amplitude accuracy</b>	±1.0% rdg. ±1 mV (0 to 30 A) (DC, 45 to 66Hz)	±1.0% rdg. ±1 mV (0 to 30 A) (DC, 45 to 66 Hz)	±1.0% rdg. ±1mV (0 to 150A /DC, 45 to 66Hz) ±2.0% rdg. (150A to 300A peak / DC, 45 to 66Hz)	±1.0% rdg. ±5mV (0 to 500A / DC, 45 to 66Hz) ±2.0% rdg. (500A to 700A peak / DC, 45 to 66Hz)
<b>Noise</b>	2.5mA rms or less (measured with 20MHz bandwidth equipment)	2.5mA rms or less (measured with 20MHz bandwidth equipment)	25mA rms or less (measured with 20MHz bandwidth equipment)	25mA rms or less (measured with 20MHz bandwidth equipment)
<b>Sensitivity temperature characteristics</b>	Within ±2% (from 0 to 40°C)	Within ±2% (from 0 to 40°C)	Within ±2% (At 55Hz/150A input, 0 to 40°C)	Within ±2% (At 50Hz/500A input, 0 to 40°C)
<b>Maximum rated</b>	5.6VA	5.3 VA	5.5VA (Input within the maximum input range.)	7.2VA (Input within the maximum input range.)
<b>Power supply voltage</b>	±12V ±0.5V	±12 V ±0.5 V	±12V ±1V	±12V ±0.5V
<b>Ambient conditions for usage</b>	0 to 40°C, max. 80% rh (no condensation)	0 to 40°C, 80% rh or less (no condensation)	0 to 40°C, max. 80% rh (no condensation)	0 to 40°C, max. 80% rh (no condensation)
<b>External magnetic field resistance</b>	Max. 20mA (equivalent) (DC and 60Hz, Magnetic field of 400A/m)	Max. 5 mA (equivalent) (DC and 60 Hz, Magnetic field of 400 A/m)	Max. 150mA (equivalent) (DC and 60Hz, Magnetic field of 400A/m)	Max. 800mA (equivalent) (DC and 60Hz, Magnetic field of 400A/m)
<b>Maximum voltage in measurement circuit</b>	300V, CAT-I (insulated conductor)	300 V, CAT-I (insulated conductor)	600 V CAT-II, 300 V CAT-III (insulated conductor)	600 V CAT-II, 300 V CAT-III (insulated conductor)
<b>Measurement conductor</b>	Diameter max. 5mm	Diameter max. 5 mm	Diameter max. 20 mm	Diameter max. 20 mm
<b>Dimensions and mass</b>	Sensor: approx. 175W×18H×40D mm; 230g Termination unit: approx. 27W×55H×18D mm	Sensor: approx. 175W×18H×40D mm; 240g Termination unit: approx. 27W×55H×18D mm	Sensor: approx. 176W×69H×27D mm; 500g Termination unit: approx. 27W×55H×18D mm	Sensor: approx. 176W×69H×27D mm; 520 g Termination unit: approx. 27W×55H×18D mm
<b>Cable length</b>	Sensor cable: approx. 1.5 m (BNC connector) Power cable: approx. 1 m	Sensor cable: approx. 1.5 m (BNC connector) Power cable: approx. 1 m	Sensor cable: approx. 2 m (BNC connector) Power cable: approx. 1 m	Sensor cable: approx. 2 m (BNC connector) Power cable: approx. 1 m
<b>Supplied accessories</b>	Soft case 1	Hard case 1	Hard case 1	Hard case 1

● **Optional accessories**

### 3269/3272 POWER SUPPLY

Please specify voltage when ordering for use with 120 V, 220 V, or 240 V.



Use the 3269/3272 power supply for general measurements or when power is not available from the oscilloscope.



**3269**  
(Four sensors)

**3272**  
(Single sensor)

3273-50, 3274, 3275, 3276 CLAMP ON PROBE

**3269/3272 SPECIFICATIONS**

<b>Suitable sensor model</b>	3273-50, 3274, 3275, 3276 CLAMP ON PROBE
<b>Number of power supply connectors</b>	1 (3272), 4 (3269) (connector type: LEMO inc./ FFA..0S.304.CNAC42Z)
<b>Output voltage</b>	±12 V ±0.5 V
<b>Ambient conditions for usage</b>	0 to 40°C, max. 80%rh (no condensation)
<b>Power requirements</b>	Please specify voltage when ordering for use with 120V, 220V, or 240V.
<b>Maximum rated power consumption</b>	20VA max. (3272) 170VA max. (3269)
<b>Dimensions and mass</b>	Approx. 73W × 110H × 186D mm; 1.1kg (3272) Approx. 80W × 119H × 200D mm; 1.2kg (3269)
<b>Supplied accessories</b>	Power cord×1, spare fuse×1

## 9277 | 9278 | 9279 | UNIVERSAL CLAMP ON CT 9555 | SENSOR UNIT

High-precision sensors to view waveforms or to use with power meters (for AC/DC)

- 9277/9278/9279: Clamp on sensors
- Wide frequency ranges including DC
- Use together with the 9555 SENSOR UNIT for current waveform monitoring (with a waveform recorder or oscillograph)



9277, 9278

9279  
(Non-CE mark product)



### SPECIFICATIONS

	9277	9278	9279(Non-CE mark product)
<b>Rated current</b>	20 A AC/DC (continuous 50 A)	200 A AC/DC (continuous 350 A)	500 A AC/DC (continuous 650 A)
<b>Frequency band width</b>	DC to 100 kHz ( $\pm 5\%$ f.s.)	DC to 100 kHz ( $\pm 5\%$ f.s.)	DC to 20 kHz ( $\pm 5\%$ f.s.)
<b>Accuracy (DC or 45 to 66 Hz)</b>	$\pm 0.5\%$ rdg, $\pm 0.05\%$ f.s., phase $\pm 0.2^\circ$	$\pm 0.5\%$ rdg, $\pm 0.05\%$ f.s., phase $\pm 0.2^\circ$	$\pm 0.5\%$ rdg, $\pm 0.05\%$ f.s., phase $\pm 0.2^\circ$
<b>Output rate (with the 9555)</b>	2 V/rated current range (waveform output, with the 9555)	2 V/rated current range (waveform output, with the 9555)	2 V/rated current range (waveform output, with the 9555)
<b>Max. circuit voltage</b>	600 V peak (insulated wire)	600 V peak (insulated wire)	600 V peak (insulated wire)
<b>Core jaw dia.</b>	$\phi 20$ mm	$\phi 20$ mm	$\phi 40$ mm
<b>Power supply</b>	9555 SENSOR UNIT (required)	9555 SENSOR UNIT (required)	9555 SENSOR UNIT (required)
<b>Dimensions, mass</b>	176W $\times$ 63H $\times$ 34D mm, 430 g, cord length: 3 m	176W $\times$ 63H $\times$ 34D mm, 430 g, cord length: 3 m	220W $\times$ 103H $\times$ 43.5D mm, 860 g, cord length: 3 m
<b>Accessories</b>	9375 CARRYING CASE (1)	9375 CARRYING CASE (1)	9375 CARRYING CASE (1)

### Optional accessories

## 9555 POWER SUPPLY

power supply for the 9270/9271/9272/9277/9278/9279, single sensor connectable



### 9555 SPECIFICATIONS

<b>Suitable models</b>	9270/9271/9272/9277/9278/9279, 1 unit max.
<b>Power supply</b>	85 to 250 V AC, 47 to 440 Hz (universal type)
<b>Dimensions, mass</b>	50W $\times$ 100H $\times$ 180D mm, 700 g
<b>Accessories</b>	Power cord (1), Fuse (1), 9177 CONNECTION CORD (1), Setting parts (1)

## 9010 | 9010-10 | 9018 | 9018-10 | CLAMP ON PROBE

Easy-to-use, current to voltage transformer

- Intended primarily for application as an input sensor for a recorder
- A secondary output provides an AC voltage waveform, and can be connected to an input impedance over 1M $\Omega$



### 9010, 9010-10 : SPECIFICATIONS

<b>Rated current</b>	500 A AC (10 A to 500 A full scale, 6 ranges selectable)
<b>Frequency band width</b>	40 to 1 kHz ( $\pm 6\%$ max.)
<b>Accuracy (at 50 or 60 Hz)</b>	$\pm 3\%$ f.s.
<b>Output rate</b>	0.2 V AC at full scale range (waveform output)
<b>Output terminal</b>	Insulated BANANA (Model 9010), Insulated BNC (9010-10)
<b>Max. circuit voltage</b>	600 V AC rms (insulated wire)
<b>Core jaw dia.</b>	$\phi 46$ mm, or 50 mm $\times$ 20 mm busbar
<b>Power supply</b>	None
<b>Dimensions, mass</b>	74W $\times$ 184H $\times$ 37D mm, 420 g, cord length: 3m

### 9018, 9018-10 : SPECIFICATIONS

<b>Rated current</b>	500 A AC (10 A to 500 A full scale, 6 ranges selectable)
<b>Frequency band width</b>	40 to 3 kHz ( $\pm 1\%$ max.), phase $\pm 2.5^\circ$ max.
<b>Accuracy (at 50 or 60 Hz)</b>	$\pm 1.5\%$ rdg, $\pm 0.1\%$ f.s.
<b>Output rate</b>	0.2 V AC at full scale range (waveform output)
<b>Output terminal</b>	Insulated BANANA terminal(9018), Insulated BNC(9018-10)
<b>Max. circuit voltage</b>	600 V AC rms (insulated wire)
<b>Core jaw dia.</b>	$\phi 46$ mm, or 50 mm $\times$ 20 mm busbar
<b>Power supply</b>	None
<b>Dimensions, mass</b>	74W $\times$ 184H $\times$ 37D mm, 410 g, cord length: 3 m

# Power Measuring Instruments



## Power Measuring Instruments Index

### For high level performance



**3193** CE  
DC, or Single-phase to 3-phase  
4-wire Wide-band up to 1 MHz  
6 ch-Direct/ Clamp input  
..... p.39



**3194** CE  
Analysis station for Motor  
Evaluation Power, Harmonics,  
Rotation Speed, Torque,  
Converter efficiency  
..... p.39



**3196** CE  
Power quality analyzer  
DC, or Single-phase to 3-phase  
4-wire Clamp input  
..... p.37

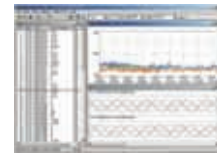

**9624/9624-10**  
PQA- HiVIEW  
Software application for 3196  
..... p.38

### For use on production lines



**3186**  
Single-phase V,A,W,VA  
Direct input only



**3331** CE  
Single-phase to 3-phase 3-wire  
V,A,W,VA,var,integ., PF Phase  
angle, Hz Direct input only



**3332** CE  
Single-phase 2-wire V,A,W,VA,  
var,integ., PF Phase angle, Hz  
Direct input only  
..... p.39

### Wide bandwidth, multi-purpose models



**3187**  
DC, or Single-phase V,A,W,VA,  
var,integ., PF Phase angle, Hz  
Direct/ Shunt input



**3167**  
DC, or Single-phase V,A,W,VA,  
var,integ., PF Phase angle, Hz  
Clamp input only

### For managing power lines



**3169-20/-21** CE  
Single-phase to 3-phase 4-wire  
V,A,W,VA,var,integ., PF, Hz  
Clamp input only  
..... p.36

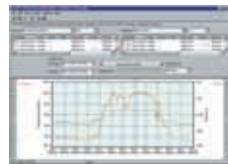

**9625**  
POWER MEASUREMENT  
SUPPORT SOFTWARE  
for 3169-20/21  
..... p.36



**3286-20** CE  
Clamp-On Power Meter  
V,A,W,VA,var, PF,Hz, Hamonics  
(V, A)  
..... p.44

## 3169-20 | 3169-21 | CLAMP ON POWER HiTESTER

Offering a new approach to energy-related measurement such as energy conservation, ISO14001 testing, equipment diagnosis, and harmonics measurement.



CAT III 600V



RS-232C  
STANDARD

RMS

- Measure up to two 3-phase, 3-wire systems
- Measure up to four single-phase, 2-wire systems
- 5 A to 5000 A range, PC card data storage
- Power recording for individual waveforms
- Simultaneous recording of demand values and harmonics



9661×2, 9669×2 (option)

SPECIFICATIONS	
Measurement lines	Single-phase 2-wire, single-phase 3-wire, three-phase 3-wire, and three-phase 4-wire systems (50/60 Hz)
Measurement item	Voltage, Current, Active power, Reactive power, Apparent power, Power factor, Integrated value, Frequency, Harmonics
Measurement range	Voltage: 150 V to 600 V, 3 ranges Current (When using 9660): 5 A to 100 A, 4 ranges Current (When using 9661): 5 A to 500 A, 5 ranges Current (When using 9669): 100 A to 1 kA, 3 ranges Current (When using 9667): 500 A / 5 kA, 2 ranges Current (When using 9694): 0.5 A to 5 A, 3 ranges Power: 75 W to 9 MW, 108 combination patterns
Basic accuracy	±0.2% rdg, ±0.1% f.s. + Clamp accuracy (for active power)
Clamp sensor accuracy	9660 (rated for 100 A): ±0.3% rdg, ±0.02% f.s. 9661 (rated for 500 A): ±0.3% rdg, ±0.01% f.s. 9669 (rated for 1000 A): ±1.0% rdg, ±0.01% f.s. 9667 (rated for 5000 A): ±2.0% rdg, ±1.5 mV 9694 (rated for 5 A): ±0.3% rdg, ±0.02% f.s.
Frequency characteristic	Fundamental waveforms up to the 50th order ±3% f.s. + measurement accuracy
Other functions	PC card, RS-232C, D/A output (3169-21 only, 4 channels), External I/O
Power supply voltage rating	100 to 240 V AC, 50/60 Hz
Dimensions, mass	210W×160H×60D mm ±5 mm, 1.2 kg ±100 g (3169-20, 3169-21)
Accessories	9438-03 Voltage cord set (1), Power cord (1), Input cord label (1), Operating manuals (2), CD-R (1), 9441 Connection cable (1) (for the 3169-21 only)

### OPTIONS

#### ● Current measurement

(The 3169-20/-21 cannot be used alone. Measurement requires one or more optional clamp-on sensors.)

- 9660 CLAMP ON SENSOR rated current 100 A AC
- 9661 CLAMP ON SENSOR rated current 500 A AC
- 9669 CLAMP ON SENSOR rated current 1000 A AC
- 9667 FLEXIBLE CLAMP ON SENSOR rated current 5000 A AC
- 9694 CLAMP ON SENSOR rated current 5 A AC
- 9290-10 CLAMP ON ADAPTER rated current 1500 A AC, output 150 A (10:1 ratio)

#### ● Voltage measurement

- 9438-03 VOLTAGE CORD (Supplied as standard with 3169-20/-21)

#### ● PC communication

- 9625 POWER MEASUREMENT SUPPORT SOFTWARE
- 9612 RS-232C CABLE for connection to PC
- 9626 PC CARD 32M
- 9627 PC CARD 64M
- 9726 PC CARD 128M
- 9727 PC CARD 256M
- 9728 PC CARD 512M

#### ● Other options

- 9720 CARRYING CASE
- 9440 CONNECTION CABLE for external I/O, 2 m length
- 9441 CONNECTION CABLE (3169-21 standard), for D/A output, 2 m length

#### ● Printer

- 9442 PRINTER
- 9443-02 AC ADAPTER for the 9442 PRINTER, EU type
- 9443-03 AC ADAPTER for the 9442 PRINTER, USA type
- 9721 RS-232C CABLE for connection to the 9442, 1.5 m length
- 1196 RECORDING PAPER 112 mm width×25 mm, roll type, 10 rolls per set



#### 9442 PRINTER

Print method : Thermal serial dot printing  
Paper width : 112 mm  
Print speed : 52.5cps  
Power supply : 9443-02/03 AC adapter, or supplied nickel-metal hydride battery (approx. 3000 lines of printing when fully charged and used with the 9443-02/03)  
Dimensions, mass : Approx. 160W × 66.5H × 17D mm, approx. 580g

When purchasing the 9442 printer, make sure you also purchase the 9721 RS-232C cable and 9443-02/03 AC adapter so that you can connect it to the 3169-20/21.

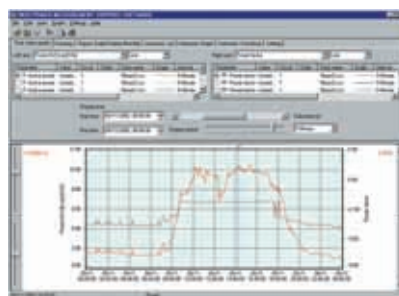

9625  
POWER MEASUREMENT  
SUPPORT SOFTWARE

# 3196 POWER QUALITY ANALYZER

Monitor and record the quality of power to analyze the cause of trouble when it occurs !

Most complete instrument for power quality troubleshooting

- Measure Dips, Swells, Interruptions, Flicker, Transients
- Harmonic to the 50th order
- High frequency transient over voltage
- Detection and waveform display
- 4 current and 4 voltage channels



CAT III 600V



**LAN**  
STANDARD

**RS-232C**  
STANDARD

**RMS**

9661x4 (option)

## SPECIFICATIONS

<b>Measurement lines</b>	Single-phase two-wires, Single-phase three-wires, Three-phase three-wires, Three-phase four-wires
<b>Voltage range</b>	ch1, ch2, ch3: 150/300/600V ch4: 60/150/300/600V(AC), 60/600V(DC)
<b>Current range</b>	9660: 50/100A, 9661:50/500A, 9667:500/5000A, 9669:1000A
<b>Measurement Method</b>	Transient overvoltage: 2MHz/s Arithmetic operation: 256points/cycle Harmonic/Inter-harmonic: 2048points/10cycles (for 50Hz) 2048points/12cycles (for 60Hz)
<b>Measurement Function</b>	1. Transient overvoltage 2. Voltage swell, Voltage dip, Voltage interruption 3. Frequency, Voltage, Current, Voltage/Current peak, Active/Reactive /Apparent power, Power factor, DPF 4. Voltage unbalance ratio, Current unbalance ratio 5. Harmonic voltage/current/power, Inter harmonic voltage/current, Harmonic voltage current phase angle, Total harmonic/inter harmonic distortion 6. IEC flicker[Pst, Plt], K factor / ΔV10(Japan)
<b>Internal memory</b>	13MB
<b>Interface</b>	PC card (Flash ATA card / up to 528 MB) RS-232C, LAN (10BASE-T), HTTP server function
<b>Power supply</b>	9458 AC adapter or 9459 battery pack
<b>Dimensions, mass</b>	298W×215H×67D mm, 2.0 kg
<b>Accessories</b>	Voltage cord (1set), 9458 AC adapter (1), 9459 Battery pack (1), strap (1)

## OPTIONS

(The 3196 cannot be used alone. Measurement requires one or more optional sensors.)

### ● Current measurement

- 9660 CLAMP ON SENSOR rated current 100A AC
- 9661 CLAMP ON SENSOR rated current 500A AC
- 9669 CLAMP ON SENSOR rated current 1000A AC
- 9667 FLEXIBLE CLAMP ON SENSOR rated current 5000A AC
- 9694 CLAMP ON SENSOR rated current 5A AC
- 9290-10 CLAMP ON ADAPTER rated current 1500A AC, output 150A (10:1 ratio)
- 9445-02 AC ADAPTER (for the 9667, for America, Japan)
- 9445-03 AC ADAPTER (for the 9667, for Europe)

### ● Voltage measurement

- 9438-02 VOLTAGE CORD (standard accessory)
- 9264-01 WIRING ADAPTER (3P3W)
- 9264-02 WIRING ADAPTER (3P4W)

### ● PC communication

- 9624 PQA HiVIEW (PC application software)
- 9624-10 PQA HiVIEW PRO (PC application software for advanced data processing)
- 9642 LAN CABLE (5m, with straight and crossover connectors)
- 9626 PC CARD 32 M
- 9627 PC CARD 64 M
- 9726 PC CARD 128 M
- 9727 PC CARD 256 M
- 9728 PC CARD 512 M

### ● Other options

- 9458 AC ADAPTER (included)
- 9459 BATTERY PACK (included)
- 9339 CARRYING CASE (soft)
- 9340 CARRYING CASE (hard)
- Printer
- 9670 PRINTER (with one roll of recording paper)
- 9671 AC ADAPTER (for 9670)
- 9672 BATTERY PACK (for 9670)
- 9673 BATTERY CHARGER (for 9672)
- 9237 RECORDING PAPER (80 mm×25 m, 4 rolls, for 9670)
- 9638 RS-232C CABLE (1.5 m, for printer connection)



**9660 CLAMP ON SENSOR**  
Current up to 100A  
**9694 CLAMP ON SENSOR**  
Current up to 5A AC



**9667 FLEXIBLE CLAMP-ON SENSOR**  
Current up to 5000A AC Diameter up to 254mm Rogovskii-type current sensor



**9661 CLAMP ON SENSOR**  
Current up to 500A



**9669 CLAMP ON SENSOR**  
Current up to 1000A

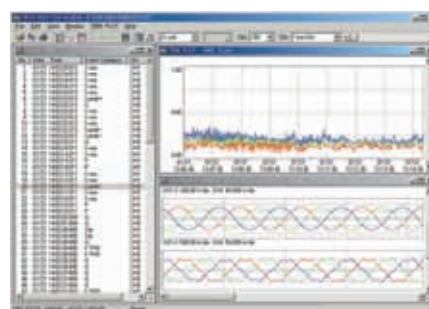

### 9624 PQA-HiVIEW

Model 9624 PQA-HiVIEW software application is a program for analyzing binary codes stored on a PC card by Model 3196.

# 9624 | PQA-HiVIEW

## Choose from 2 Easy-to-Use Application Software Packages for Further Data Analysis

### Viewer function

Use this function to display screens similar to those used for the 3196.

Select from the **TIME PLOT screen** (voltage fluctuation, RMS fluctuation, harmonic fluctuation, inter-harmonic fluctuation), **event list screen**, **event data screen** (waveforms, vectors, DMM, harmonics, event details), **ΔV10 screen**(Japanese standard), or **settings screen**. In the TIME PLOT screen, and use the two cursors (A and B) to calculate waveforms within a specified interval.

### Demand/integral power consumption function

Calculate demand and integral power consumption from TIME PLOT data for effective power.

### TIME PLOT screen

This screen enables you to select four different types of data, including RMS fluctuation, voltage fluctuation, harmonic fluctuation, and inter-harmonic fluctuation data, and display the data in graphs corresponding to the TIME PLOT screen of the 3196.

### Event list screen

This screen displays an event list corresponding to the event list on the 3196.

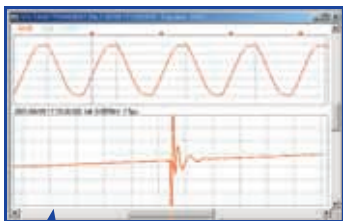

### Event data screen

1. Displays detailed data for the event that you selected in the event list.
2. Displays nine different screens that correspond to the VIEW screen on the 3196, such as the waveform, vector, harmonics, and DMM screens.

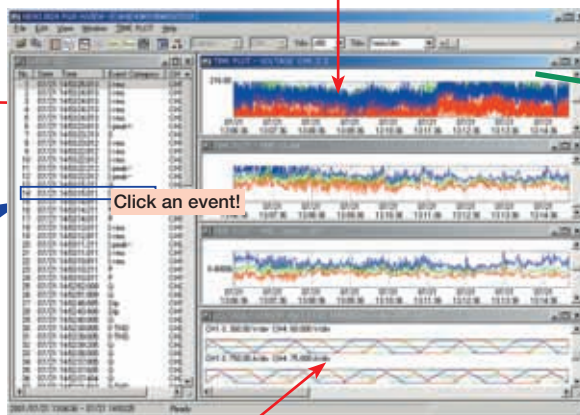

### Spot analysis using the cursor

Conduct spot analysis of time series data using the A and B cursors.

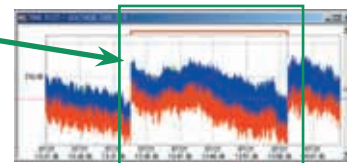

Calculations for the details within the specified interval are displayed.



View power, voltage, and current data at a single glance in the DMM screen!

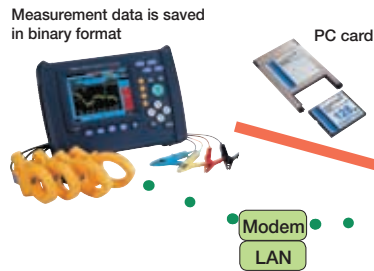
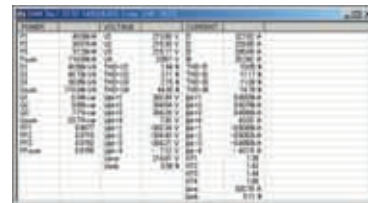

Data stored on a PC card can be transferred using remote operations via a LAN or modem

Data processing is quick and easy using the 9624 PQA-HiVIEW software

- Use it to create reports
- Use data converted to CSV format

### Binary CSV format conversion function

**Convert binary data into CSV format** for event waveforms within the specified range in the TIME PLOT screen or event waveforms selected in the event waveform screen. Files saved in CSV format can be used with spreadsheet software on your PC.

### Print function

Use this function in each screen to output reports to a printer connected to your PC.

# 9624-10 | PQA-HiVIEW PRO



## Advanced functions added to the standard Model 9624

### ITIC curve display function

Make ITIC (CBEMA) curve analyses (limit curve) based on the power quality control standards of the U.S.A.

### EN50160 display functions

(applicable standard is EN50160:1999)

Effectively evaluate and analyze the quality of power according to EU standards.

### Downloading from LAN

Data (BINARY/TEXT/BMP) recorded on a PC card or the internal memory of the 3196 can be downloaded via LAN to a personal computer. (\*This can be done without use of the freeware Down96. Measurement on the 3196 must be halted during download.)

### Report generation function

Choose from 3 types of report generation settings to take care of all the troublesome reporting operations, and either send the data to a printer or save as a Rich Text file. (Automatic: Output basic items. Individual setting: Select any item for output. Detailed setting: Specify a time-series graph in details for output.)

### Positive phase, negative phase, and zero phase function

Recalculate event data captured by 3P4W circuits, and display each component of the voltage/current of the positive phase, negative phase, and zero phase.

# 3332 POWER HiTESTER

Measure very low effective power, for stand-by mode of home use equipment

- Ultra high-sensitive measurement, for use to measure the effective power of equipment in stand-by mode: Current 1.0000 mA full-scale, 0.1  $\mu$ A resolution
- Wide measurement range, up to 50.000 A direct input



SPECIFICATIONS	
Measurement lines	Single-phase/two-wire
Measurement items	Voltage, Current, Current peak, Active power, Apparent power, Reactive power, Power factor, Phase angle, Frequency, Power integration, Current integration
Measurement ranges	Voltage: 15.000V to 600.00V, auto or 6 ranges Current: 1.0000mA to 50.000A, auto or 15 ranges Power: 15.000mW to 30.000kW, auto or 90 ranges Frequency: 4Hz to 100kHz, auto or 2 ranges
Integration range	0 to $\pm 999999$ MAh/ MWh, (integration time up to 10000 hours)
Wave peak measurement	Current (displays maximum absolute value)
Basic accuracy	$\pm 0.1\%$ rdg. $\pm 0.1\%$ f.s. (active power, at 45 to 66Hz)
Frequency characteristics	1Hz to 100kHz (1Hz to 100kHz at 10A or less, 10Hz to 10kHz at 20A to 30A, 50/60Hz at 30A to 50A)
Signal output	Analog level: Voltage, current, active power, 5V DC f.s. Waveform monitor: Voltage, current, 1V rms f.s.
Other function	Comparator function for 2 items Scaling function (PT /CT/SC), Displays a moving average function, GP-IB/RS-232C interface
Sampling rate	5 times /second
Power supply	100 to 240 V AC, 50/60 Hz
Dimensions, mass	210W $\times$ 100H $\times$ 261D mm, 2.5 kg
Accessories	Power cord (1), Connector for EXT I/O (1)

## OPTIONS

- 9151-02 GP-IB CONNECTION CABLE (2 m)
- 9151-04 GP-IB CONNECTION CABLE (4 m)
- 9442 PRINTER
- 9443-02 AC ADAPTER (for the 9442, EU), 9443-03 (USA)
- 9444 CONNECTION CABLE (for the 9442)
- 1196 RECORDING PAPER  
(25 m, 10 rolls /1 set, for the 9442)



# 3193 POWER HiTESTER

Wide spectrum power meter for comprehensive device assessment



\*Note: 9600 to 9605 : factory installation only  
\*Certain Clamp-on sensors are not CE-mark compliant. Please refer to p.32

SPECIFICATIONS	
Measurement lines	Single-phase/two-wires to three-phase/four-wires (Through the use of various input units)
Measurement items	(When using 9600, 9601, 9602, optional) Voltage, current, voltage /current peak, effective/reactive/apparent power, power factor, phase, frequency, current/power integration, load rate, efficiency (When using 9603, optional) Voltage, torque, RPM, frequency, motor output (When using 9605, optional) Harmonic, waveform, voltage fluctuation / flicker measurement function
Measurement ranges	Voltage: 6.0000V to 1.0000kV (depends on use of the input unit) Current: 200.00mA to 500.00A (depends on use of the input unit) Power: Depends on combination of voltage and current ranges
Integration range	0 to $\pm 999999$ TAh/ TWh, (integration time up to 10000 hours)
Basic accuracy	$\pm 0.1\%$ rdg. $\pm 0.1\%$ f.s. (voltage, current, power, at 45 to 66Hz) Note: When used together with the 9270 to 9272, and 9277 to 9279, resulting accuracy is the sum of that indicated above and the accuracy of these clamp sensors.
Frequency characteristics	using with 9600: DC, 0.5Hz to 1MHz using with 9601: 5Hz to 100kHz using with 9602: DC, 0.5 Hz to 200 kHz (depends on the clamp accuracy)
Signal output	Analog level: Voltage, current, active power, 5V DC f.s. Waveform monitor: Voltage, current, 1V rms f.s. D/A output: Outputs 8 arbitrarily selected items, DC $\pm 5$ V f.s.
Other functions	6.4 inch TFT color LCD, RMS/MEAN rectification, FDD, GP-IB/RS-232C interface, scaling, averaging
Power supply	100/120/200/230 V AC (switched automatically), 50/60 Hz
Dimensions, mass	430W $\times$ 150H $\times$ 370D mm, 15 kg (with all options)
Accessories	Power cord (1), Connector for EXT I/O (1)

## OPTIONS

- (The 3193 cannot be used alone. Measurement requires one or more input units.)
- 9600 AC/DC DIRECT INPUT UNIT
  - 9601 AC DIRECT INPUT UNIT
  - \*9602 AC/DC CLAMP INPUT UNIT
  - 9603 EXTERNAL SIGNAL INPUT UNIT
  - 9604 PRINTER UNIT
  - 9605 HARMONIC / FLICKER MEASUREMENTS UNIT
  - \*9270 series CLAMP ON SENSOR
  - \*9290-10 CLAMP ON ADAPTER

# 3194 MOTOR/HARMONIC HiTESTER

Analysis Station Extends Reach of Motor Evaluation!

Comprehensive measurement of power, rotation speed, torque, converter efficiency, and harmonics, all with a single unit

3194 Performs Comprehensive Evaluation of 3-phase Inverter Motors  
Using the 9603-01 EXTERNAL SIGNAL INPUT UNIT, a torque sensor (strain gauge) is directly connected to chA. By inputting the output of a tachometer (analog signal or pulse signal) to chB, a system for measuring torque, rpm and motor power can be obtained.

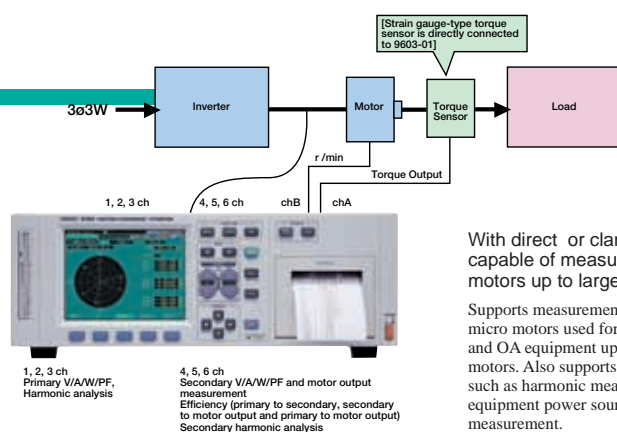

With direct or clamp input unit, capable of measuring from micro motors up to large-size motors

Supports measurements of everything from micro motors used for household appliances and OA equipment up to industrial large-size motors. Also supports various applications such as harmonic measurement of equipment power sources and power quality measurement.





# Clamp Testers



## Clamp Testers Index

### Current Meters (for AC only, basic type)

 <b>3127-10</b> AC current, up to 300A, ø 33 mm dia. <b>3128-10</b> AC current, up to 1500A, ø 55 mm dia. ..... p.45	 <b>3280-10</b>  <b>CE</b> AC current, up to 1000A, ø 33 mm dia., light 100g and slim 16 mm ..... p.42	 <b>3280-20</b>  <b>CE</b> AC current, up to 1000A, ø 33 mm dia., light 100g and slim 16 mm True RMS ..... p.42	 <b>3281</b> <b>CE</b> AC current, up to 600A, ø33mm dia., Multi-function ..... p.43 <b>3282</b> AC current, up to 1000A, ø46mm dia., Multi-function ..... p.43	 <b>3283</b> <b>CE</b> Leak current, high-sensitivity 10mA range 10µA resolution Load current up to 200A, ø40mm dia. ..... p.43	 <b>3286-20</b> <b>CE</b> Clamp-On Power Meter V,A,W,VA,var, PF,HZ, Harmonics (V, A only) ø55mm dia. or 80mm busbar ..... p.44
--	---	--	--	---	--

### Current Meters (for AC/DC, two-way type)

 <b>3284</b> <b>CE</b> DC and AC current, up to 200 A, ø 33 mm dia., Multi-function ..... p.43 <b>3285</b> DC and AC current, up to 2000 A, ø 55 mm dia., Multi-function ..... p.43	 <b>3287</b>  <b>CE</b> AC/DC current, up to 100 A, ø 35 mm dia., True RMS rectifier ..... p.42 <b>3288</b> AC/DC current, up to 1000 A, ø 35 mm dia., Average rectifier ..... p.42	 <b>New</b> <b>3290/3290-10</b> <b>CE</b> DC and AC current, up to 2000A Choice of three sensors ..... p.45	 <b>New</b> <b>9691</b> <b>CE</b> 3290(3290-10)+9691 Measure up to 100 A ø35 mm ..... p.45	 <b>New</b> <b>9692</b> <b>CE</b> 3290(3290-10)+9692 Measure up to 200 A ø33 mm ..... p.45	 <b>New</b> <b>9693</b> <b>CE</b> 3290(3290-10)+9693 Measure up to 2000 A ø55 mm ..... p.45
---	--	---	--	--	---

### Conversion Adapter (for AC only, clamp-on type)

 <b>9290-10</b> <b>CE</b> AC current up to 1500 A, secondary current 1/10 of primary, ø 55 mm dia. or 88 mm width Superior phase angle characteristics	 <b>CT-101A</b> AC current up to 15 A, secondary current 1/1 or 10 times of primary, ø 25 mm dia.
---	--

# CLAMP ON HiTESTERS

## Table of functions

	AC Current ranges	Other current ranges	AC Voltage ranges	Other voltage ranges	Other functions	Analog output Printer output	Accuracy (at 50 or 60Hz)	Frequency characteristics AC current / voltage
<b>3280-10</b> <b>3280-20</b> True RMS	42.00 to 1000A AC, 3 ranges 3280-10: Average rectifier effective value 3280-20: Effective value rectifier	None	4.200 to 600V AC, 4 ranges 3280-10 : Average rectifier effective value 3280-20 : Effective value rectifier	DC Voltage range: 420.0mV to 600V DC, 5 ranges	Resistance: 420.0 to 42.00 MΩ, 6 ranges Accuracy: ±2.0 % rdg. ±4 dgt. (at 420 to 420 kΩ range) Continuity: 420.0kΩ (Buzzer sounds at approx. 50Ω or less)	None	AC current: ±1.5 % rdg. ±5 dgt. AC voltage: ±2.3 % rdg. ±8 dgt. DC voltage: ±1.3 % rdg. ±4 dgt. Continuity: ±2.0 % rdg. ±6 dgt.	AC voltage: 50 to 500Hz AC current: 50 or 60Hz (3280-10) AC current: 40 to 1kHz (3280-20)
<b>3281</b> True RMS <b>3282</b> True RMS	3281: 30.00 to 600A AC, 3 ranges 3282: 30.00 to 1000A AC, 3 ranges Effective value rectifier	Wave peak value at AC Current 3281: 75.0 to 1000A peak, 3 ranges 3282: 75.0 to 1700A peak, 3 ranges	300.0 or 600V AC, 2 ranges Effective value rectifier	Wave peak value at AC Voltage up to 750 or 1000V peak, 2 ranges	Distortion check: 1 to 5 Crest factor Resistance: 1k or 10kΩ range Temperature*: -50 to 150°C Frequency: 30.0 to 1000 Hz Mode: Slow/Peak/C.F./RMS Record mode/Auto-off/ Conduction	None	AC current: ±1% rdg. ±5 dgt. AC voltage: ±1% rdg. ±3 dgt. Peak: ±3% rdg. ±5 dgt. Frequency: ±0.3% rdg. ±1 dgt.	40 to 1000 Hz
<b>3283</b> True RMS	10.00mA to 200 A AC, 5 ranges Effective value rectifier	None	None	None	Frequency: 30.0 to 1000 Hz Filter function: 180Hz±30Hz/-3dB	DC, or AC 1V / f.s. (200A range: 2V / f.s.) Level output with REC mode Waveform output with MON mode	10m to 10A range: ±1.0 % rdg. ±5 dgt. 200A range: ±1.5 % rdg. ±5 dgt. Frequency: ±0.3 % rdg. ±1 dgt.	40 to 2kHz
<b>3284</b> True RMS <b>3285</b> True RMS	AC, AC+DC(RMS or Peak value) 3284: 20.00 or 200.0A AC, 2 ranges 3285: 200.0 or 2000A AC, 2 ranges Effective value rectifier	DC (Average or Peak value) 3284: 20.00 or 200.0A DC, 2 ranges 3285: 200.0 or 2000A DC, 2 ranges	AC, AC+DC (RMS or Peak value) 30.00 to 600V AC, 3ranges Effective value rectifier	DC (Average or Peak value) 30.00 to 600V DC, 3 ranges	Frequency: 1 to 1000Hz Mode: Max./Min./AVE. /RMS Record mode/Auto-off	DC, or AC 1V / f.s. Level output with REC mode Waveform output with MON mode	AC current: ±1.3% rdg. ±3 dgt. AC voltage: ±1.0% rdg. ±3 dgt. Frequency: ±0.3% rdg. ±1 dgt.	3284: DC, 10 to 2kHz 3285: DC, 10 to 1kHz
<b>3286-20</b> True RMS	20.00 to 1000 A AC, 3 ranges Effective value rectifier	None	150.0/300.0/600 V AC, 3 ranges Effective value rectifier	None	Power(Single-phase or 3 phase): 3kW to 600kW(Single-phase) 6kW to 1200kW(3-phase) Power factor, Phase angle: Frequency: 30.0 to 1000Hz Voltage/current harmonic levels	9442 PRINTER (Option)	AC current: ±1.3 % rdg. ±3 dgt. AC voltage: ±1.0 % rdg. ±3 dgt. Power: ±2.3% rdg. ±5 dgt.(1φ) ±3.0% rdg. ±10 dgt.(3φ) (Accuracy guaranteed only for 50/60Hz cosφ=1)	AC current: 45 to 1kHz AC voltage: 30 to 1kHz
<b>3287</b> True RMS <b>3288</b>	3287: 10.00 or 100.0A AC, 2 ranges Effective value rectifier 3288: 100.0 or 1000A AC, 2 ranges Average rectifier effective value	DC mode 3287: 10.00 or 100.0 A DC, 2 ranges 3288: 100.0 or 1000 A DC, 2 ranges	3287: 4.200 to 600V AC, 4 ranges Effective value rectifier 3288: 4.200 to 600V AC, 4 ranges Average rectifier effective value	DC mode 420.0 mV to 600 V DC, 5 ranges	Resistance: 420.0 to 42.00MΩ, 6 ranges Accuracy: ±2.0% rdg. ±4 dgt. (at 420 to 420kΩ range)Continuity: 420.0Ω (Buzzer sounds at approx. 50Ω or less)	None	AC current: ±1.5 % rdg. ±5 dgt. AC voltage: ±2.3 % rdg. ±8 dgt. DC voltage: ±1.3 % rdg. ±4 dgt. DC current: ±1.5 % rdg. ±5 dgt. Continuity: ±2.0 % rdg. ±6 dgt.	3287 AC current: DC, 10 to 1kHz 3288 AC current: DC, 10 to 500Hz AC voltage: 30 to 500Hz
<b>3290</b> True RMS <b>3290-10</b> True RMS	3290+9691 : AC 20 to 100A 3290+9692 : AC 20 to 200A 3290+9693 : AC 200 to 2000A AC+DC, AC RMS, AC MEAN	3290+9691 : DC 20 to 100A 3290+9692 : DC 20 to 200A 3290+9693 : DC 200 to 2000A	None	None	Frequency : 10 to 1000 Hz	DC, or AC Current : 2V/f.s. Level output with REC mode Waveform output with MON mode Integ./Frequency : 1V/f.s.	AC/DC/AC+DC Current ±1.3 % rdg. + 3 dgt. (Typical) Frequency : ±0.3 % rdg. + 1 dgt. (Typical)	DC to 500Hz (9691) DC to 1kHz(9692, 9693) ±2.3 % rdg. + 8 dgt.
<b>3127-10</b> <b>3128-10</b>	3127: 6 to 300A AC, 5 ranges 3128: 15 to 1500A AC, 5 ranges Average rectifier effective value	None	150 to 750V AC, 3 ranges Average rectifier effective value	DC Voltage range: 75 V DC, 1 range	Resistance: 1k or 100kΩ range Temperature*: -50 to 200°C *9021-01TEMPERATURE PROBE required, (sold separately)	None	AC current: ±3% f.s. AC/DC voltage: ±3% f.s.	50 or 60 Hz

	Display	Sampling rate	Crest factor (RMS)	Effect of external magnetic fields	Max. circuit voltage	Core jaw dia.	Power supply	Dimensions/mass	Included accessories
<b>3280-10</b> <b>3280-20</b> True RMS	Digital /LCD, maximum 4199 dgt.	2.5 times /sec or 1 time /3 sec	None (3280-10) 2.5 (3280-20)	No provision	600V AC rms	φ33 mm	CR2032 (3 VDC) ×1	57W×175H× 16D mm /100 g	9208 TEST LEAD (1) 9398 CARRYING CASE (1)
<b>3281</b> True RMS <b>3282</b> True RMS	Digital /3000 dgt. Bar graph /35 seg.	2 or 4 times /sec (Slow: 1 time /3 sec)	2.5 (1.7 at 600A, 1000A, 600 V range)	3281: 1.5A equivalent max. at 400 A/m 3282: 0.2A equivalent max. at 400 A/m	600V AC rms (insulated wire)	3281: φ33 mm 3282: φ46 mm	6F22(006P) ×1	3281: 62W×218H× 39D mm /350 g 3282: 62W×230H× 39D mm /400 g	9207-10 TEST LEAD(1) 9399 CARRYING CASE(1) Hand strap(1)
<b>3283</b> True RMS	Digital /2000 dgt. Bar graph /35 seg.	2 or 4 times /sec (Slow: 1 time /3 sec)	2.5 (1.5 at 200A range)	corresponds to 5mA, max. 7.5 mA equivalent max. at 400A/m	300 V AC rms (insulated wire)	φ40 mm	6F22(006P) ×1 or AC adapter	62W×225H×39D mm/400 g	9399 CARRYING CASE(1) Hand strap(1)
<b>3284</b> True RMS <b>3285</b> True RMS	Current / 2500 dgt. Voltage / 3750 dgt. Bar graph /35 seg.	2 or 4 times /sec (Slow: 1 time /3 sec)	2.5 1.5 (3284: 200A range), 1.42 (3285: 2000A range)	3284: 0.5A equivalent max. at 400 A/m 3285: 2.0A equivalent max. at 400 A/m	600V AC rms (insulated wire)	3284: φ33 mm 3285: φ55 mm	6F22(006P) ×1 or AC adapter	3284: 62W×230H× 39D mm /460 g 3285: 62W×260H× 39D mm /540 g	9207-10 TEST LEAD(1) 9399 CARRYING CASE(1 for 3284) 9345 CARRYING CASE(1 for 3285) Hand strap(1)
<b>3286-20</b> True RMS	Digital /LCD, maximum 6000 dgt.	Normal: 1 time /sec (Slow: 1 time /3 sec)	2.5 (1.7 at 1000 A, 600 V range)	1.00 A equivalent max. at 400 A/m	600 V AC rms (insulated wire)	φ55 mm or 80mm busbar	6LR61/6LF22 (006P) ×1	100W×287H×39D mm /650 g	9635 VOLTAGE CORD(1) 9245 CARRYING CASE(1) Hand strap(1)
<b>3287</b> True RMS <b>3288</b>	Digital /LCD, maximum 4199 dgt.	2.5 times /sec	3287 2.5 or less (150A, 1000V maximum) 3288 None	No provision	600 V AC rms (insulated wire)	3287: φ35 mm 3288: φ35 mm	CR2032 (3VDC) ×1	3287: 57W×180H× 16D mm /170 g 3288: 57W×180H× 16D mm /150 g	9208 TEST LEAD (1) 9398 CARRYING CASE (1)
<b>3290</b> True RMS <b>3290-10</b> True RMS	Digital / LCD maximum 3000 dgt. Bar graph / 20 seg. 3290-10 maximum 9999 dgt.	Fast : 4 times / sec, (3290-10 FAST : 10 times/sec) Normal : 2 times / sec, Slow : 1 time / 3sec	2.5 or less	9691 : 0.5 A equivalent max.at 400 A/m 9692 : 0.7 A equivalent max.at 400 A/m 9693 : 2.0 A equivalent max.at 400 A/m	600 V AC rms (insulated wire)	9691 : φ35mm 9692 : φ33mm 9693 : φ55mm	Type 3 alkaline dry cell (LR6) ×4 or AC adapter	3290 : 155W×98H× 47D mm / 545g 9691 : 53W×129H× 18D mm / 230g 9692 : 62W×167H× 35D mm / 410g 9693 : 62W×196H× 35D mm / 500g	strap
<b>3127-10</b> <b>3128-10</b>	Indicator type	None	None	No provision	600V AC rms (insulated wire)	3127: φ33 mm 3128: φ55 mm, or 80 mm busbar	R6P(AA) ×1	3127: 78W×190H× 34D mm /340 g 3128: 99W×237H× 34D mm /570 g	9067 TEST LEAD (1) 9351 CARRYING CASE for 3127(1) 9148 CARRYING CASE for 3128(1)

# 3280-10 | CLAMP ON HiTESTER



## Easy operation !

- 1000 A rms, clamp aperture: 33 mm dia.
- Light 100 g, and Slim 16 mm
- Independent-opening double-lever design
- Slim body allows easy clamping even for narrow conductors
- No metal (iron core) exposure, ensuring enhanced safety



CAT III 600 V  
(Current range)  
CAT II 600 V  
(Voltage range)

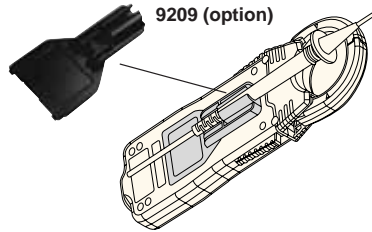

### OPTIONS

9209 TEST LEADS HOLDER  
\*CT-101A LINE SPLITTER

*\*Note: Non-CE mark product*

# 3280-20 | CLAMP ON HiTESTER

## True RMS !

- 1000 A rms, clamp aperture: 33 mm dia.
- Light 100 g, and Slim 16 mm
- Independent-opening double-lever design
- Slim body allows easy clamping even for narrow conductors
- No metal (iron core) exposure, ensuring enhanced safety



CAT III 600 V  
(Current range)  
CAT II 600 V  
(Voltage range)



### OPTIONS

9209 TEST LEADS HOLDER  
\*CT-101A LINE SPLITTER

*\*Note: Non-CE mark product*

# 3287 | 3288 | CLAMP ON AC/DC HiTESTER



## Compact & easy, one-touch maintenance on all types of AC/DC equipment

- The 3287 can handle even cogenerator / inverter energy-saving equipment (10/100A)
- Use the 3288 for high current measurements such as UPS emergency batteries and train motors (100/1000A)
- A slim core of only 10 mm (0.39") for easy clamping even in crowded wiring



CAT III 600 V  
(AC/DC A)  
CAT II 600 V  
(AC/DC V)



3287

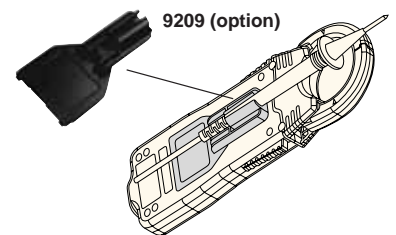

### OPTIONS

9209 TEST LEADS HOLDER  
\*CT-101A LINE SPLITTER

*\*Note: Non-CE mark product*



# 3281 | 3282

## DIGITAL CLAMP ON HiTESTER

True RMS is shown in the distorted waveform

3281: 600 A AC,  $\varnothing$  33 mm 3282: 1000 A AC,  $\varnothing$  46 mm

- AC Current/Voltage, Frequencies, Resistance, Conduction check, Temperature (probe sold separately)
- Wave peak value, Waveform distortion check
- Auto-power off to prevent the power from being left on
- Non-fuse type protects up to 600 V AC



### OPTIONS

- \*9462 THERMISTOR TEMPERATURE PROBE
- \*CT-101A LINE SPLITTER

\*Note: Non-CE mark product

# 3283 | CLAMP ON LEAK HiTESTER

Easily monitor leak current fluctuations



- High-sensitivity with a full scale of 10mA (resolution:10 $\mu$ A)
- High-accuracy at  $\pm$ 1%
- True RMS measurement
- Analyzer functions, for filtering and output signals
- Wide bandwidth, 5Hz to 15kHz (Monitor output)



### OPTIONS

- 9445-02 AC ADAPTER (for USA)
- 9445-03 AC ADAPTER (for EU)
- 9290-10 CLAMP ON ADAPTER
- \*CT-101A LINE SPLITTER (cannot be used for leakage current, for use on load current only)
- \*9094 OUTPUT CORD

\*Note: Non-CE mark product

# 3284 | 3285

## CLAMP ON AC/DC HiTESTER

Analysis for DC to distorted waves

- 3284: 200 Arms, clamp aperture: 33 mm dia.
- 3285: 2000 Arms, clamp aperture: 55 mm dia.
- Inrush current crest value
- RMS value of full-wave rectified waveforms
- Waveform and harmonic analysis



### OPTIONS

- 9445-02 AC ADAPTER (for USA)
- 9445-03 AC ADAPTER (for EU)
- 9290-10 CLAMP ON ADAPTER
- \*CT-101A LINE SPLITTER (cannot be used for DC, AC+DC current, for use on AC current only)
- \*9094 OUTPUT CORD

\*Note: Non-CE mark product

## 3286-20 CLAMP ON POWER HiTESTER

All powerful ! Easy operation !  
True-RMS Clamp-on Power Meter !

- Use as a single-phase power meter or power factor meter (3kW to 600kW range)
- Simple checking of three-phase lines (6kW to 1200kW range)
- Check power supply fluctuations
- 1000 A, 1000 Hz, peak and harmonic measurement
- True RMS (effective value) display method
- Optional printer (9442 PRINTER)



9636-01 RS-232C PACKAGE



### SPECIFICATIONS

Measurement items	Voltage, current, voltage/current peak, effective/ reactive / apparent power(Single-phase or 3-phase), power factor, reactivity, phase angle, frequency, phase detection(3-phase), voltage/current harmonic levels(up to 20th)
Measurable conductor diameter	φ55mm (2.16") max.
Display	LCD, digital (6000 counts)
Rectification method	RMS (true root mean square value)
Display update rate	NORMAL approx. 1 time/ sec, SLOW 1 time/ 3-sec at HARM meas. approx. 1 time/ 2-sec
Analog response time	4 seconds or less (when input is changed from 0% to 90% of range.)

### Voltage/ Current/ Power measurement

Range Table		AC Current			
		20.00 A	200.0 A	1000 A	
AC Voltage	150.0 V	Single-phase	3.000 kW	30.00 kW	150.0 kW
		*3-phase(balanced load)	6.000 kW	60.00 kW	300.0 kW
	300.0 V	Single-phase	6.000 kW	60.00 kW	300.0 kW
		*3-phase(balanced load)	6.000/12.00 kW	60.00/120.0 kW	600.0 kW
	600 V	Single-phase	12.00 kW	120.0 kW	600.0 kW
		*3-phase(balanced load)	24.00 kW	240.0 kW	600.0/1200 kW

\*3-phase power is calculated and displayed on the basis of a balanced, 50/60 Hz, sine wave input.  
For apparent power and reactive power, the unit of wats in the above table is replaced by VA and var respectively.

Effective value P.F.	0.000 (lead) to 1.000 to 0.000 (lag); 1φ only
Max. allowable current	1000 Arms cont.
Max. usable circuit voltage	600 Vrms (insulated conductor)
Effective input range	Voltage: 10 V to 600 V, Current: 10 A to 1000A, Power: 80 V to 600 V and 10 A to 1000 A
Min. Display value	Voltage: 0.6 Vrms, Current: 0.6 Arms
Display indication range (RMS value)	5 or less are zero-suppressed, and the upper limit is to 125% of the range setting (to 100% for the 1000 A range)
Circuit dynamic	2.5 or less (1000 A and 600 V range is 1.7 or less)

### Power factor/ Phase angle/ Reactivity measurement

Detection method	Phase discrimination by phase detection (zero crossing)
Power factor (cos θ)	0.000 (lead) to 1.000 to 0.000 (lag)
Phase angle	90.0°(lead) to 0.0° to 90.0°(lag)
Reactivity (sin θ)	0.000 (lead) to 1.000 to 0.000 (lag)

### Frequency measurement

Measurement range	30.0 Hz to 100 Hz (at 100.0Hz range) 100 Hz to 1000Hz (at 1000Hz range)
Min. input level	Voltage 10 Vrms-sine wave, Current 1 Arms-sine wave

### Wave peak measurement

Measurement range	150 (375 peak) / 300 (750 peak) / 600 (1020 peak) V 20 (50 peak) / 200 (500 peak) / 1000 (1700 peak) A
Effective Input Range	Effective value of sine wave is within effective input permissible in the range and within circuit dynamic

### Harmonic measurement

Measurement items	Level of each order, percentage of each order and total harmonic distortion (THD-F and THD-R)
Measurement range	Fundamental frequency 45 Hz to 65 Hz
Window width	1 cycle (45 Hz to 65 Hz), Data points: 256 points
Window type	Rectangular
Orders analyzed	Up to 20th

### Other functions

Phase detection	Normal/ reverse/ missing (at 3-phase balanced load)
Record	MAX. value and MIN. value (Effective in the voltage, current and effective / apparent power functions)
Battery capacity	Displayed in % when the unit is powered on
Data hold	Holds display
Auto power off	Approx. 10 minutes, buzzer sounds just before power is turned off, can be extended or cancelled
Data output	RS-232C interface by optical insulating coupler

### OPTIONS

9636-01 RS-232C PACKAGE  
9442 PRINTER  
9636 RS-232C CABLE (for 9442 printer)

9443-02 AC ADAPTER (for 9442 printer, EU)  
9443-03 AC ADAPTER (for 9442 printer, America)  
1196 RECORDING PAPER (for 9442 ,10 rolls)

# 3290/3290-10 CLAMP ON AC/DC HiTESTER New

## 9691 | 9692 | 9693 CLAMP ON AC/DC SENSOR

All the Functions You Need for Measurement at DC or 1Hz and up

- Choice of three sensors (Example combinations)  
3290+9691 : Measure up to 100A  
3290+9692 : Measure up to 200A  
3290+9693 : Measure up to 2000A
- Choice of measurement methods  
DC (for battery measurement)  
AC+DC RMS (for full-/half-wave rectification measurement)  
AC RMS (for current distortion measurement)  
PEAK (for peak value measurement) of inrush current, etc.)
- Choice of output (Simultaneous output)  
Effective value output, frequency output, waveform output
- Choice of response times (Switchable among three response times)
- LPF function (filters out unnecessary harmonics :  $f_c=550\text{Hz}$ )
- 3290-10 Functions  
Current integral measurement (obtain polarity-specific integrated DC values)  
Operating time/duty measurement



### 9691 Specifications

- Frequency range: DC to 10kHz(-3dB)
- Effect of conductor position: less than +/-1.0%
- Effect of external magnetic fields: equivalent to 0.5A or less (in a 400A/m external magnetic field)
- External dimensions: approximately 53W×129H×18D mm
- Weight: approximately 230g



### 9692 Specifications

- Frequency range: DC to 20kHz(-3dB)
- Effect of conductor position: less than +/-0.5%
- Effect of external magnetic fields: equivalent to 0.7A or less (in a 400A/m external magnetic field)
- External dimensions: approximately 62W×167H×35Dmm
- Weight: approximately 410g



### 9693 Specifications

- Frequency range: DC to 15kHz(-3dB)
- Effect of conductor position: less than +/-0.7%
- Effect of external magnetic fields: equivalent to 2A or less (in a 400A/m external magnetic field)
- External dimensions: approximately 62W×196H×35Dmm
- Weight: approximately 500g

### 3290 & Sensor Common Specification

- Accuracy at 50 or 60 Hz : AC/DC/AC+DC Current ( $\pm 1.3\%$  rdg. + 3 dgt.)
- Frequency range : DC to 1kHz ( $\pm 2.3\%$  rdg. + 8 dgt.)
- Cable length: 2m(6.56ft)
- Maximum circuit voltage: 600V



Model	Measurable conductor diameter	Rated input	Measurement range on 3290	Maximum display	
				Normal measurement	Peak measurement
9691	φ35mm	100Arms 150Apeak	20.00A	25.00A	50.00A
			200.0A	105.0A	150.0A
9692	φ33mm	200Arms 300Apeak	20.00A	25.00A	50.0A
			200.0A	210.0A	300.0A
9693	φ55mm	2000Arms 2840Apeak	200.0A	250.0A	500A
			2000A	2100A	3000A



9691

# 3127-10 | 3128-10 CLAMP ON HiTESTER

One meter drop-proof "Tested Tough!"

- With the range of 300 A (3127-10), 1500 A (3128-10)
- Temperature measurement
- Ohmmeter circuit tested to 250 V AC over voltage-OK
- Clamp-on measurement for busbars and thick conductors (3128-10)

### OPTIONS

- \*9021-01 THERMISTOR TEMPERATURE PROBE
- 9290-10 CLAMP ON ADAPTER ( for large AC current )
- \*CT-101A LINE SPLITTER

\*Note: Non-CE mark product



Clamp Testers

# Field Measuring Instruments



## Field Measuring Instruments Index

### Analog Multi Meters



**3030-10** €  
Basic type analog tester, Average rectifier



**3008**  
Use for industrial power lines, Average rectifier



**3660** €  
Affordable LAN cable testing, Wire-Map, Cable length, Direction-Check  
..... p.50

### OPTICAL POWER METER



**3661-20, 3662/63-20** €  
Optical loss measurement tool  
3662/63-20 LASER LIGHT SOURCE  
..... p.50

### Noise Search Tester Voltage Detector



**3144-20** €  
Noise Search Tester  
Frequency range 500 Hz to 30 MHz  
0 dBV and -20 dBV f.s., 2 ranges  
..... p.50



**3120** €  
Voltage Detector  
AC 70 to 600 V(50/60 Hz)  
..... p.49

### Digital Multi Meters (basic functions)



**3246** €  
Pencil type DMM, Average rectifier  
..... p.48



**3244** €  
Card size DMM with emphasis on safety, Average rectifier  
..... p.48



**3245** €  
A card size DMM with solar charged battery, Average rectifier



**3255-50** €  
Built tough for use with industrial power lines DMM, Average rectifier  
..... p.49



**3256-50, -51** €  
Terminal shutter interlock mechanism DMM, Average rectifier  
..... p.49

### Phase Detector



**3126-01** €  
Phase detector, Rotary disk style, 110 to 480V



**3129** €  
Phase Detector, Non-contact types, AC 70 to 600 V(50/60 Hz)  
..... p.53

### Digital Multi Meters (multi-functional and high precision)



**3257-50, -51** €  
Terminal shutter interlock mechanism DMM, True RMS rectifier  
..... p.49



**3801-50** €  
Multi-function type, 51000 count display, RS-232C/USB communication, True RMS rectifier  
..... p.48



**3802-50** €  
Low-cost type, 51000 count display, RS-232C/USB communication, True RMS rectifier



**3803** €  
Low-cost type, 4000 count display, RS-232C communication, Average rectifier  
..... p.48



**3804, 3805** €  
Multi-function type, 9999 count display (V range), RS-232C communication, True RMS rectifier (3805)



**3237, 3238, 3239** €  
High speed DMMs  
199999 count display  
..... p.22

### Insulation Testers



**3118-11 to -12**  
Testing voltage 250V to 1000V, Two ranges, Indicator type



**3451-11 to -15** €  
Testing voltage 125V to 1000V, Single range, Compact and lightweight, Luminous scale indicator type  
..... p.52



**3452-11 to -13** €  
Testing voltage 25V to 1000V, Three ranges, Compact and lightweight, Luminous scale indicator type  
..... p.52



**3453** €  
Testing voltage 125V to 1000V, Four ranges in one body, Compact and lightweight, Digital display, Comparator and memory function  
..... p.51



**3454-10/-11/-51** €  
Innovative and low-cost Insulation resistance tester with continuity function  
..... p.52



**3455** €  
Testing voltage 250V to 5000V, Five ranges  
10 MΩ to 5 TΩ  
Seven ranges  
..... p.51

### Earth Testers



**3151** €  
Grounding resistance meter, Two-wire or three-wire measurement method, Tough and durable design  
..... p.53

# DIGITAL HiTESTERS

## Table of functions

	DC Voltage ranges	AC Voltage ranges	Frequency characteristics at AC Voltage	Resistance ranges	DC Current ranges	AC Current ranges	Frequency characteristics at AC Current	Frequency ranges	Continuity
<b>3244</b>	420mV to 500V, 5 ranges Best accuracy: ±0.7% rdg. ±4 dgt.	4.2V to 500V, 4 ranges Accuracy: ±2.3 % rdg. ±8 dgt. Average rectifier effective value	50 to 500 Hz	420Ω to 42 MΩ, 6 ranges Best accuracy: ±2.0% rdg. ±4 dgt.	None	None	None	None	50Ω ±30Ω
<b>3246</b>	420.0mV to 600V, 5 ranges Best accuracy: ±1.3 % rdg. ±4 dgt.	4.2V to 600V, 4 ranges Accuracy: ±2.3% rdg. ±8 dgt. Average rectifier effective value	50 to 500 Hz	420.0Ω to 42.00MΩ, 6 ranges Best accuracy: ±2.0 % rdg. ±4 dgt.	None	None	None	None	(50Ω±30Ω)
<b>3256-50</b> <b>3256-51</b> <b>(3257)</b>	420.0mV to 1000V, 5 ranges Best accuracy: ±0.5% rdg. ±2 dgt.	420.0mV to 1000V, 5 ranges Best accuracy: ±1.2% rdg. ±4 dgt. Average rectifier effective value	50 to 500 Hz	420.0Ω to 42.00MΩ, 6 ranges Best accuracy: ±0.7% rdg. ±2 dgt.	42.00μA to 10.00A, 6 ranges Accuracy: ±1.5 % rdg. ±4 dgt.	42.00μA to 10.00 A, 6 ranges Best accuracy: ±2.5 % rdg. ±5 dgt. Average rectifier effective value	50 to 500Hz	0.50Hz to 500.0kHz, 5 ranges input level: 800mV to 1000V rms Accuracy: ±0.02% rdg. ±1 dgt.	50Ω ±30Ω or less
<b>3801-50</b> True RMS <b>3802-50</b> True RMS	51mV to 1000V, 7 ranges Best accuracy 3801-50: 0.025% rdg. ±5dgt. 3802-50: 0.03% rdg. ±10dgt.	51mV to 1000V, 7 ranges Best accuracy 3801-50: 0.4% rdg. ±25dgt. 3802-50: 0.6% rdg. ±25dgt.	3801-50: 20 to 100kHz 3802-50: 30 to 30kHz	510Ω to 510MΩ, 7(6) ranges (3802-50) Best accuracy 3801-50: 0.05% rdg. ±5 dgt. 3802-50: 0.08% rdg. ±5 dgt.	510μA to 10A, 6 ranges Best accuracy 3801-50: 0.05% rdg. ±25 dgt. 3802-50: 0.1% rdg. ±25 dgt.	510μA to 10A, 6 ranges Best accuracy 3801-50: 0.7% rdg. ±20 dgt. 3802-50: 0.9% rdg. ±25dgt.	3801-50: 20 to 100kHz 3802-50: 30 to 20kHz	99,999Hz to 999,99kHz Best accuracy 0.02% rdg. ±3 dgt.	10Ω or less (at 510Ω range)
<b>3803</b>	400.0mV to 1000V, 5 ranges Best accuracy: ±0.6% rdg. ±2 dgt.	400.0mV to 1000V, 5 ranges Best accuracy: ±2.0% rdg. ±2 dgt. Average rectifier effective value	40 to 500Hz	400.0Ω to 40.00MΩ, 6 ranges Best accuracy: ±0.6% rdg. ±3 dgt.	400.0μA to 10.00A, 5 ranges Best accuracy: ±1.5 % rdg. ±2 dgt.	400.0μA to 10.00A, 5 ranges Best accuracy: ±2.0 % rdg. ±2 dgt. Average rectifier effective value	40 to 500Hz	None	34.5Ω or less (at 400Ω range)
<b>3804</b>	999.9mV to 999.9V, 4 ranges Best accuracy: ±0.3% rdg. ±2 dgt.	999.9mV to 999.9V, 4 ranges Best accuracy: ±1.2 % rdg. ±5 dgt. Average rectifier effective value	40 to 500 Hz	400.0Ω to 40.00MΩ, 6 ranges Best accuracy: ±0.6 % rdg. ±3 dgt.	400.0μA to 10.00A, 6 ranges Best accuracy: ±0.2 % rdg. ±3 dgt.	400.0μA to 10.00A, 6 ranges Best accuracy: ±1.2 % rdg. ±5 dgt. Average rectifier effective value	50 to 2 kHz	None	10Ω or less (at 400Ω range)
<b>3805</b> True RMS	999.9mV to 999.9V, 4 ranges Best accuracy: ±0.1 % rdg. ±2 dgt.	999.9mV to 999.9V, 4 ranges Best accuracy: ±1.1 % rdg. ±5dgt. Effective value rectifier	40 to 2 kHz	400.0Ω to 40.00MΩ, 6 ranges Best accuracy: ±0.5 % rdg. ±3 dgt.	400.0μA to 10.00A, 6 ranges Best accuracy: ±0.1%rdg.±3dgt.	400.0μA to 10.00A, 6 ranges Best accuracy: ±0.1 % rdg. ±5 dgt. Effective value rectifier	50 to 2kHz	1Hz to 50kHz / 0.7V to 300V rms Best accuracy: ±0.05% rdg. ±4 dgt.	10Ω or less (at 400Ω range)
<b>3255-50</b>	420mV to 1000 V, 5 ranges, Best accuracy: ±0.5 % rdg. ±4 dgt.	420mV to 1000 V, 5 ranges, Best accuracy: ±1.2% rdg. ±4 dgt. Average rectifier effective value	50 to 500 Hz	420Ω to 42 MΩ, 6 ranges, Best accuracy: ±0.7 % rdg. ±4 dgt.	None	None	None	None	(45Ω ±35Ω or less)
<b>3030-10</b>	0.3V (16.7kΩ/V), 3/12/30/120/300/600V(20kΩ/V) Accuracy: ±2.5% f.s.	12V±4% f.s. (9kΩ/V) 30/120/300/600V ±2.5% f.s. Average rectifier effective value	None	0 to 3kΩ (center scale 30Ω) R×1, R×10, R×100, R×1k ±3.0% of scale length	60μA/30m/300mA (300mV internal voltage drop) Accuracy: ±3% f.s.	None	None	None	None

	Diode check	Other functions	Auto power save	Range switching	Display/Safety	Bar graph display	Sampling rate	Power supply	Dimensions/ mass	Included accessories
<b>3244</b>	None	None	(Cancel impossible)	Auto	Digital/LCD, maximum 4199 dgt Safety: IEC1010-1, Pollution degree 2, over voltage category II	None	2.5 times /sec	CR2032×1 batteries (Continuous use 150 hours)	55W×109H×9.5D mm/60g	Hard case(1)
<b>3246</b>	judgement only (3.4V open terminal voltage)	None	(Cancel possible)	Auto or Manual	Digital/LCD, with Back light max. 4199 dgt.	None	2.5 times/sec	CR2032×1 batteries (Continuous use 150 hours)	30W×182H×26.5D mm 80 g	
<b>3256-50</b> <b>3256-51</b> <b>(3257)</b>	(3.4 V open terminal voltage)	Voltage detect function Hold-auto function Relative function	(Cancel possible)	Auto or Manual	LCD, maximum 4200 dgt. (all mode) maximum 19999 dgt. (Frequency)	(Maximum 40 segments)	2.5 times/sec (all mode) 5 times/sec (Frequency) 25 times/sec (Bar graph)	R03(AAA)×2 dry batteries (Continuous use 100 hours)	76W×167H×33D mm/260 g	9170 TEST LEAD(1) Fuse(2) 9378 CARRYING CASE(1) (3256-50) Holster (3256-51)
<b>3801-50</b> True RMS <b>3802-50</b> True RMS	(3.1 V open terminal voltage)	3801-50 only: AC+DC measurement, Pulse output Common functions: Capacitance, Data hold, dBm measurement, Duty ratio/Pulse width, Temperature, 1ms peak hold Relative, Max/Min/Ave, RS-232C, USB	(Cancel possible)	Auto or Manual	LCD, max. 51000 dgt. with Back light	Maximum 21 dots	3 times/sec 1 times/sec	6LR61×1 (9.0V) (Continuous use 50 hours)	90W×192H×37D mm/940 g	3851-10 TEST LEAD(1), Holster(1)
<b>3803</b>	(3 V open terminal voltage)	RS-232C, Data hold	(Cancel possible)	Auto or Manual	LCD, max. 4000 dgt.	(Maximum 41 dots)	2.5 times/sec 13 times/sec (Bar graph)	6F22(006P)×1	76W×167H×33D mm/400 g	3851-10 TEST LEAD(1) Holster(1)
<b>3804</b>	(3.3 V open terminal voltage)	Capacitance, Data hold, Refresh hold, Max/Min/Ave/Relative/4-20mA% display, RS-232C	(Cancel possible)	Auto or Manual	LCD, max. 4000 dgt. max. 9999 dgt. (at V range)	(Maximum 41 dots)	3 times/sec 13 times/sec (Bar graph)	6F22(006P)×1	76W×167H×33D mm/400 g	3851-10 TEST LEAD(1) Holster(1)
<b>3805</b> True RMS	(3.3 V open terminal voltage)	Capacitance, Data hold, Refresh hold, Max/Min/Ave/Relative/4-20mA% display, RS-232C, Temperature	(Cancel possible)	Auto or Manual	LCD, max. 4000 dgt. max. 9999 dgt. (at V range)	(Maximum 41 dots)	3 times/sec (exclusive Hz range) 1 time/sec (Hz range) 13 times/sec (Bar graph)	6F22(006P)×1	76W×167H×33D mm/400 g	3851-10 TEST LEAD(1) Holster(1)
<b>3255-50</b>	judgement only (3.4 V open terminal voltage)	CLAMP (ACA) function (Clamp-on probe : Option) 10A to 1000A 7ranges	(Cancel possible)	Auto or Manual	LCD, maximum 4199 dgt.	None	2.5 times/sec	R03(AAA)×2 dry batteries (Continuous use 200 hours)	70 mmW×145 mmH×31 mmD/200 g	9207-10 TEST LEAD (1), 9371 CARRYING CASE (1)
<b>3030-10</b>	(3V open terminal voltage)	Battery check: 0.9 to 1.8V, load resistance 10Ω Temperature: -20 to 150, (9021-01 Thermister Temperature Probe is necessary, sold separately)	None	Manual	Indicator type	None	None	R6P(AA)×2 batteries	95W×141H×39D mm 280g	9207 TEST LEAD(1) fuse(1) 9390 CARRYING CASE(1)



# 3246 | PENCIL HiTESTER

## Pencil-type DMM with Penlight

In addition to being compact, this pencil-type tester comes with auto-range and data hold functions for incredibly easy measurement of electrical and electronic circuitry.

- Full-auto ranging, 4199 count display
- Penlight brightly illuminates test points
- Overload protection to 600 V (Ω and continuity functions)

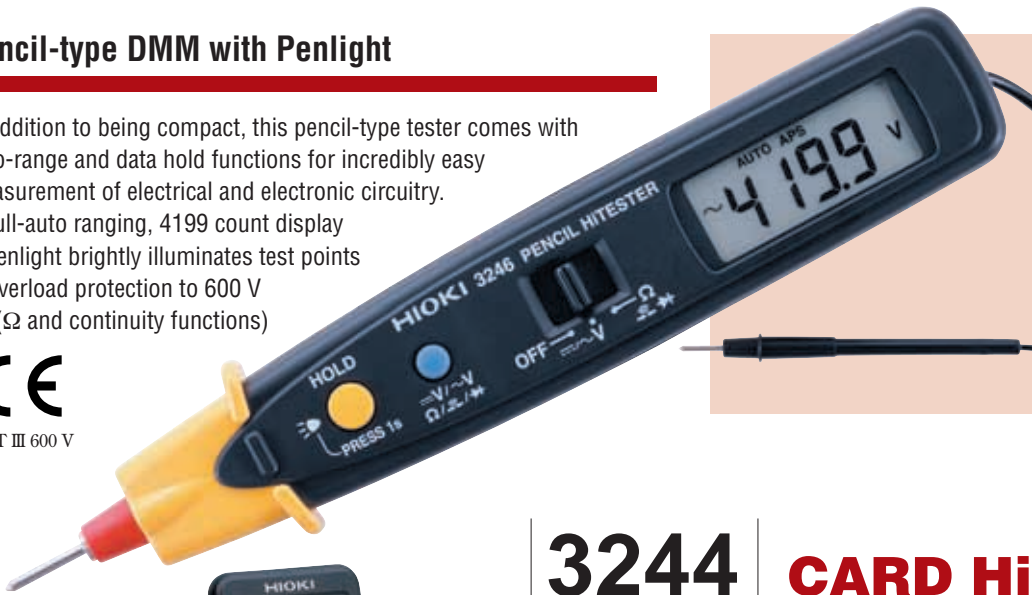

Penlight brightly illuminates test points

### OPTIONS

- \*9081 10A SHUNT
- \*Note: Non-CE mark product

# 3244 | CARD HiTESTER

## Card size DMM with emphasis on safety

- Only 9.5 mm thick and 60 g in weight
- 4199 count display
- Test leads fit neatly inside the case.
- Automatic power saving function saves your batteries even when you forget to turn off the power.

### OPTIONS

- \*9081 10A SHUNT
- \*Note: Non-CE mark product



# 3801-50 | DIGITAL HiTESTER



## High-precision, high-resolution, and multi-functional handy DMMs

- Display two different parameters simultaneously
- Optional RS-232C or USB package for transferring data captured by the 3801-50 to a PC
- Measures the AC components in DC voltage or DC current
- 1ms peak hold mode makes it possible to capture the peak value of a waveform



### OPTIONS

- 3856-01 RS-232C PACKAGE
- 3856-02 USB PACKAGE
- \*9014 HIGH-VOLTAGE PROBE
- \*9180 to \*9183 TEMPERATURE PROBE
- 9472 to 9476 TEMPERATURE PROBE
- 9617 CLIP ON BASE (for capacitance measurement)
- 9618 CLIP TYPE LEAD (for capacitance measurement)

\*Note: Non-CE mark product

# 3803 | DIGITAL HiTESTER

## Compact and basic DMM

- 4000 count display full scale
- Average rectified RMS indication type
- Optional RS-232C package for transferring data captured by the 3803 to a PC



### OPTIONS

- 3853 CARRYING CASE
  - 3854 RS-232C PACKAGE
  - \*9014 HIGH-VOLTAGE PROBE
- \*Note: Non-CE mark product



# 3256-50/-51 3257-50/-51

## DIGITAL HiTESTER

### Terminal shutter interlock mechanism

- Terminal shutter interlock mechanism exposes only the correct terminals for connection in the currently selected function
- Wide range, maximum reading 4200 digit
- High-speed response, bar graph display
- Conforms with IEC1010
- Hold-auto function automatically displays voltage or current value and resistance value



3256-50/-51  
CAT II 1000 V  
CAT III 600 V  
3257-50/-51  
CAT III 1000 V  
CAT IV 600 V

### Fail-safe!

Shutter mechanism prevents incorrect test lead connection

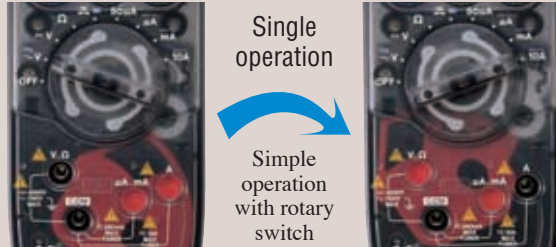

**Voltage ranges**  
Only V and COM terminals open  
**10A range**  
Only A and COM terminals open  
\* The above photograph shows a special model with a transparent cover.

### Check for live lines safely and easily

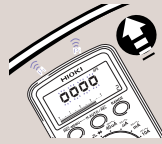

In the AC V range, the 3256-50 can be used to check whether power lines are live. When the sensitivity level is set to 4 and the test head is placed near a live power line, the built-in buzzer sounds and a display indicator lights. Sensitivity threshold: 100 V AC or higher



### Model

- 3256-50 (Standard type)
- 3256-51 (3256-50 with holster)
- 3257-50 (Standard type)
- 3257-51 (3257-50 with holster)

### OPTIONS

- \*9014 HIGH-VOLTAGE PROBE
- 3853 CARRYING CASE (for 3256-51)

\*Note: Non-CE mark product

# 3255-50

## DIGITAL HiTESTER

### Tough for use on industrial power lines

- Built-in current limiter and fuse capable of withstanding 1000 V to prevent short-circuit accidents
- Wide range, maximum reading 4199 digit
- Two-terminal configuration eliminates the need for probe reconnections
- Industrial grade test leads for enhanced safety



CAT II 1000 V  
CAT III 600 V

### OPTIONS

- 9207-10 TEST LEAD (Supplied as standard with the 3255-50)
- 9371 CARRYING CASE (Supplied as standard with the 3255-50)

# 3120 VOLTAGE DETECTOR

### Twin Light Audible Voltage Detector

- Green for Battery Check
- Red for Voltage Detection



CAT IV 600 V

### SPECIFICATIONS

Measurement Function	Voltage Detection
Voltage Range	AC 70 to 600 V, 50/60 Hz (when touching insulated wiring equivalent to IV2mm <sup>2</sup> )
Indication	Red LED and continuous beeping sound
Battery Check	Green LED
Power Source	"AAA" manganese (R03) or alkaline (LR03) battery x 2
Continuous Use	Approx. 200 hours (when switched to "ON" and in standby using LR03 batteries)
Dimensions*Mass	149H x 18.5mm (excl. protrusions), 38g (incl. batteries)



## 3144-20

## NOISE SEARCH TESTER

Identify noise in communication and power lines

### 3144-20 SPECIFICATIONS

Input unit configuration	9741 dedicated input terminal, BNC input terminal (9741 takes priority)
Frequency range band	500Hz to 30MHz, separated into 7 ranges (-3 dB) 500Hz to 3kHz (1 kHz range) 7.5kHz to 22.5kHz (15kHz range) 35kHz to 105kHz (70kHz range) 125kHz to 375kHz (250kHz range) 0.5MHz to 1.5MHz (1MHz range) 1.5MHz to 4.5kHz (3MHz range) 10MHz to 30MHz (20MHz range) (BNC input 50Ω termination)
Measurement range	×1 range 0 dBV (1V) f.s. Measurement range (0dBV to -30dBV) ×10 range -20 dBV (0.1V) f.s. Measurement range (-20dBV to -50dBV)
Detection method	RMS value conversion
Detection accuracy	500Hz to 1 MHz or less ±1.5dBV 1MHz to 30 MHz ±2.0dBV
Monitoring function	Display of measurement voltage level of each frequency range in levels on LCD (2.5dBV/SEG equivalent)
Logging function	Measurement data and time saved to internal memory according to specified recording interval
Recording interval	1/2/5/10/20/30 seconds 1/2/5/10/20/30/60 minutes
Output function	Wave monitoring (Output of input signal coming from 9741 or BNC input) Audible range monitoring (Output of detection signal envelope Earphone)
Interface	USB Ver.1.1
Power	AA-size alkaline batteries (LR6) × 6, DC 9 V 500mA (9445-02 or 9445-03 AC adapter, rated power voltage AC 100V to 240V, 50/60Hz, maximum rated current 250 mA)
Dimensions and mass	98(W) × 179(H) × 46(D) mm, 430g (excluding batteries)
Accessories	9741 Clamp-on Voltage Sensor, carrying case, PC application software CD-R, AA-size alkaline batteries (LR6) × 6, USB cable, strap, 9445-02 AC adapter (UL), 9445-03 AC adapter (CEE), earphone



### 9741 SPECIFICATIONS

Sensor configuration	Electrostatic coupling non-contact voltage sensor
Frequency range	600Hz to 30MHz (-3dB)
Conductor dia	φ20mm
Maximum rated voltage to earth	AC200V
Dimensions and mass	62(W) × 158(H) × 40(D) mm, 260g

## 3661-20

## OPTICAL POWER METER

## 3662-20

## 3663-20

## LASER LIGHT SOURCE

### 3661-20 SPECIFICATIONS

Measurement functions	Optical power measurement (dBm) Measure absolute value of input optical power Optical loss measurement (dB) Automatically compare measured power with previously input reference value to calculate and display loss
Calibration wavelength	850 nm, 1310 nm, 1550 nm
Range	-60 dBm to +9 dBm (auto range)
Accuracy	±0.22 dB (±5%) at -10dBm, CW, 23°C ±5°C
Resolution	0.01 dBm (optical power), 0.01 dB (optical loss)
Rated max.	+10 dBm
Connector	FC, SC (using optional connector adapter)
Fiber type	Single mode, multi mode (core dia. 62.5μm max. NA: 0.275 max.)
Light receiver	InGaAs (dia. 1 mm)
Display update rate	Approx. 3 times/s (approx. 350 ms)
Memory	Max. 1000 data per wavelength
Interface	USB (Ver. 1.1) Dedicated PC application software allows transfer of measurement data from the 3661-20 memory to a computer
Functions	Auto power save (after about 10 minutes of inactivity; defeatable) Settings backup (settings are automatically stored at power-off) Battery check (symbol appears when voltage drops below approx. 4 V)
Power supply	LR6(AA) alkaline battery × 4, 0.5 VA
Operating time	Approx. 40 hours (continuous use)
Dimensions and mass	Approx. 85 W × 192 H (including 36 mm cover) × 35 D mm, Approx. 300g (without batteries)



3661-20



3662-20 (1550mm)  
3663-20 (1310mm)

### 3662-20, 3663-20 SPECIFICATIONS

Light-emitting element	Laser diode
Output connector	FC, SC (using optional connector adapter)
Fiber type	Single mode
Output mode	Continuous wave (CW) or modulated light (270 Hz, 1 kHz, 2 kHz)
Output wavelength	1310 ± 20 nm (3663-20) 1550 ± 20 nm (3662-20)
Spectrum width	5 nm max.
Output level	-6 ± 2 dBm
Output level stability	Within ±0.1 dB (temperature constant, 5 minutes) Within 1.0 dB p-p (ambient temperature 0 to 40°C, 8 hours)
Functions	Battery check (indicator flashes when battery voltage drops)
Power supply	LR6(AA) alkaline battery × 2, 0.6 VA
Operating time	Approx. 20 hours (3662-20, continuous CW output) Approx. 36 hours (3663-20, continuous CW output)
Dimensions and mass	Approx. 76 W × 159 H (including 36 mm cover) × 35 D mm, Approx. 180g (without batteries)

## 3660

## LAN CABLE HITESTER



- **Simple operation**  
Simple checks can be made by pressing three operation keys.
- **Large LCD shows the wiring status**  
Can simultaneously display the results of the WireMap check for incorrect connections, wire breaks and short circuits, along with the results of the cable length check that indicates the location of the wire break or short circuit, giving you an accurate understanding of the wiring status.



### SPECIFICATIONS

Measurable cable	UTP cable: Characteristic impedance 100Ω, CAT 3, 4, 5, 5e
Measurable connector	RJ-45 connector
Measurement item <WireMap>	Can check wiring status using the 9336 WIREMAP TERMINATOR Error detection: Open, short, other wiring errors (Split pairs cannot be detected.)
<Cable length>	Measured length: 2 to 300m when results are displayed in feet: 6.6 to 984 ft Measurement accuracy: ± (15% rdg. + 1 m) when results are displayed in feet: ± (15% rdg. + 3.3 ft) Display resolution: 0.1 m when results are displayed in feet: 0.3 ft
<Direction>	Can identify five cables using the optional 9337 DIRECTION TERMINATOR
Display	LCD
Ancillary functions	Power saving mode: Power saving mode after measurement operation, recovery from power saving mode when measurement operation was initiated by pressing the TEST key Battery check: Battery indicator appears when batteries are nearly exhausted.
Applicable standards	Safety: EN61010-1:1993+A2:1995 EMC: EN61326-1:1997+A1:1998
Allowable input	3.5 V peak (between pins of the RJ-45 connector on the 3660)
Ambient temperature of use	0°C to 40°C, 80%rh or less, no condensation
Storage temperature	-10°C to 50°C, 80%rh or less, no condensation
Power supply	LR6(AA) alkaline battery × 6
Maximum rated power	1.6 VA
Operating time	Approx. 250 hours (when measuring once per minute)
Dimensions and mass	Approx. 98 W × 160 H × 38 D mm, Approx. 290g

# 3455 HIGH VOLTAGE INSULATION HiTESTER

Maximum 5kV Test Voltage - Up to 5TΩ of Insulated Resistance Testing  
Safely evaluate the insulation characteristics of high voltage transformers, motors and cables

- Wide voltage range (250V to 5kV) for maximum 5TΩ of insulation resistance measurements
- Automatically calculate and display the PI (Polarization Index) and DAR (Dielectric Absorption Ratio) for all types of insulation evaluations
- Temperature compensation to accurately respond to variations in insulation material
- Internal memory stores 100 blocks of manually recorded data and 10 sets of log data
- USB interface, compact rugged case, and safe design



SPECIFICATIONS	
250 V range	0.00 MΩ to 250 GΩ, Accuracy : ±5 % rdg. ±5 dgt. (0 to 2.50 GΩ) ±20 % rdg. ±5 dgt. (2.50 to 250 GΩ)
500 V range	0.00 MΩ to 500 GΩ, Accuracy : ±5 % rdg. ±5 dgt. (0 to 5.00 GΩ) ±20 % rdg. ±5 dgt. (5.00 to 500 GΩ)
1 kV range	0.00 MΩ to 1.00 TΩ, Accuracy : ±5 % rdg. ±5 dgt. (0 to 10.0 GΩ) ±20 % rdg. ±5 dgt. (10.0 to 500 GΩ) ±30 % rdg. ±50 dgt. (500 G to 1.00 TΩ)
2.5 kV range	0.00 MΩ to 2.50 TΩ, Accuracy : ±5 % rdg. ±5 dgt. (0 to 25.0 GΩ) ±20 % rdg. ±5 dgt. (25.0 to 500 GΩ) ±30 % rdg. ±50 dgt. (500 G to 2.50 TΩ)
5 kV range	0.00 MΩ to 5.00 TΩ, Accuracy : ±5 % rdg. ±5 dgt. (0 to 50.0 GΩ) ±20 % rdg. ±5 dgt. (50.0 to 500 GΩ) ±30 % rdg. ±50 dgt. (500 G to 5.00 TΩ)
Function	Insulation resistance mode: Data memory(100 data), measurement value hold, average, bar graph display, timer etc. Leak current: (1.00nA to 1.20mA), Temperature: (-10°C to 70°C) Voltage: (DC±50V to 1kV AC 50V to 750V) All measurement mode: live wire warning, battery indicators, auto power save
Interface	USB ver 2.0 (full speed)
Display	LCD with backlight
Power supply	LR6(AA) alkaline batteries × 6, 9459 BATTERY PACK 9753 AC ADAPTER
Dimensions, mass	260 mmW × 250.6 mmH × 119.5 mmD, 2.8 kg
Accessories	9750-01 to 03 TEST LEAD (red, black, blue 3m), ALLIGATOR CLIPS (red, black, blue), LR6(AA) Alkaline batteries × 6, USB CABLE(1)



## OPTIONS

- 9750-01 to 03 TEST LEAD (red, black, blue 3m)
- 9751-01 to 03 ALLIGATOR CLIPS (red, black, blue)
- 9631-01 TEMPERATURE SENSOR (1m)
- 9631-05 TEMPERATURE SENSOR (6cm)
- 9750-11 to 13 TEST LEAD (red, black, blue 10m)
- 9459 BATTERY PACK
- 9753 AC ADAPTER

# 3453 DIGITAL MΩ HiTESTER

For efficient insulation measurement!

- One body with four ranges: 125 V/40 MΩ, 250 V/2000 MΩ, 500 V/2000 MΩ, and 1000 V/4000 MΩ
- Accurate digital display
- Insulation measurement through sight and sound
- Memorizes on the spot (Memorizes up to 20 data points)
- Recognizes variations of resistance
- Ability to measure AC voltage and low resistance (continuity)



SPECIFICATIONS				
Testing voltage	125 V DC	250 V DC	500 V DC	1000 V DC
Measurement range	4.000 MΩ or 40.00 MΩ	4.000 /40.00 /400.0 /2000 MΩ, (+ 4000 MΩ range at 1000 V mode)		
First effective measurement range	±2 % rdg. ±3 dgt. at 0.100 to 10.00 MΩ	±2 % rdg. ±3 dgt. at 0.200 to 20.00 MΩ	±2 % rdg. ±3 dgt. at 0.200 to 50.00 MΩ	±2 % rdg. ±3 dgt. at 0.200 to 999 MΩ
Second effective measurement range	±5 % rdg. at 10.01 to 40.00 MΩ	±5 % rdg. at 20.01 to 2000 MΩ	±5 % rdg. at 50.1 to 2000 MΩ	±2 % rdg. ±6 dgt. at 0 to 0.199 MΩ ±5 % rdg. at 1000 to 4000 MΩ
Voltage with no load	Not more than 1.2 times rated testing voltage			
Min. resistance measurement value (Resistance value to maintain rated voltage)	0.125 MΩ	0.250 MΩ	0.500 MΩ	2.000 MΩ
Shorting measurement current	1.2 mA max.			0.6 mA max.
Response time	Infinitude to center, infinitude to zero-MΩ within 5 second (within accuracy range)			
Low resistance (conductivity)	±2 % rdg. ±8 % dgt. at 0 to 400.0Ω (aural warning below: 30Ω), Open terminal voltage: 4 V max.			
AC voltage range and accuracy	±3 % rdg. ±8 dgt. at 0 to 600 V, 50 to 60 Hz, Input resistance: 170 kΩ			

## Common SPECIFICATIONS

- Discharge function** : effective
- Display** : Digital/4000 dgt. LCD, Bar graph/42 seg. with backlight
- Functions** : **Insulation resistance mode**: comparator, memory (20 data), measurement value hold, auto discharge, bar graph display (measurement switch ON: insulation resistance; measure switch OFF: voltage across measurement terminals), auto display of measurement value 1 minute after measurement start, All measurement mode: live wire warning, battery indicators, auto power save
- Sampling rate** : 2 times/second
- Power supply** : R6P(AA) ×4 or LR6(AA) ×4
- Dimensions** : 155W×98H×80D mm, 500g
- Accessories** : 9294 TEST PROBE(1) display cover and suspension band(1)

## OPTIONS

- \*9289 TEST PROBE
- \*9288 BREAKER PIN
- \*Note: Non-CE mark product

## 3454-10/-11/-51 DIGITAL MΩ HiTESTER

Revolutionary insulation resistance tester with continuity function all in one low price



3454-11-51

Test voltage: 250V / 500V / 1000V DC  
(3454-51: Non-CE mark product)

### SPECIFICATIONS

Model	3454-10	3454-11/51
Insulation testing voltage	50 V DC / 125 V DC / 250 V DC / 500 V DC	250 V DC / 500 V DC / 1000 V DC
Measurement range	4.000/40.00/400.0/200.0 MΩ, 400.0/2000 (250V/500V range only) MΩ	4.000/40.00/400.0/500.0 MΩ, 4000 (1000V range only) MΩ
Accuracy	1st effective range: ±3 %rdg. ±4 dgt. / 2nd effective range: ±5 %rdg. ±5 dgt.	
Voltage with no load	Not more than 1.2.5 rated measurement voltage	
Short circuit current	1.2 mA max.	
Response time	∞ to center, ∞ to 0 MΩ within 5 s (within accuracy range)	
Low resistance (continuity)	Measurement range: 40.00 / 400.0 / 4.000 k / 40.00 k / 400.0 k / 4.000 MΩ Short circuit current: 200 mA Accuracy: ±3 %rdg. ±6dgt. (±5 %rdg. ±6dgt. at 400 kΩ range or higher) Open terminal voltage: 4 to 6 V Response time: 5 s max.	
AC voltage	Display indication range: 0 to 750 V Accuracy: ±3 %rdg. ±6 dgt.(up to 600V), Frequency range: 50 / 60 Hz, Input impedance: 100kΩ	

### OPTIONS

- 9294 TEST PROBE
- \*9288 BREAKER PIN
- \*9289 TEST PROBE
- \*Alligator Clips for Model 9289
- 9257 CONNECTOR CORD

\*Note: Non-CE mark product

Accessories : 9294 TEST PROBE (for 3454-11/3454-10), 9289 TEST PROBE. Alligator Clips (for 3454-51), Strap band (1)

- Other functions: Insulation and low resistance mode - comparator, measurement value hold; Insulation resistance mode - auto discharge; nsulation and AC voltage mode - live wire warning (when voltage of 70V ±10V exists across measurement terminals); Low resistance mode - zero adjust; All measurement modes - battery indicators, auto power save
- Display update rate: 2 times / second
- Power source: R6P manganese battery×4 or LR6 alkaline battery×4
- Dimensions and Mass: Approx. 175 W×148 H×56 D mm; Approx. 530g (with display cover closed)

## 3451-11 to 3451-15 MΩ HiTESTER

Compact and lightweight for perfect portability



### SPECIFICATIONS

Model	3451-11	3451-12	3451-13	3451-14	3451-15
Testing voltage	125 V DC	250 V DC	500 V DC	500 V DC	1000 V DC
Rated resistance	20 MΩ	50 MΩ	100 MΩ	1000 MΩ	2000 MΩ
First effective measurement range and tolerances	±5 % of scale indication at 0.02 MΩ to 10 MΩ	±5 % of scale indication at 0.05 MΩ to 20 MΩ	±5 % of scale indication at 0.1 MΩ to 50 MΩ	±5 % of scale indication at 1 MΩ to 500 MΩ	±5 % of scale indication at 2 MΩ to 1000 MΩ
Second effective measurement range and tolerances	±10 % of scale indication at more than 10 MΩ to 20 MΩ	±10 % of scale indication at more than 20 MΩ to 50 MΩ	±10 % of scale indication at more than 50 MΩ to 100 MΩ	±10 % of scale indication at more than 500 MΩ to 1000 MΩ	±10 % of scale indication at more than 1000 MΩ to 2000 MΩ
Excepting 1st and 2nd effective measurement range include 0 MΩ & infinity indication	0.7 % of scale length	0.7 % of scale length	0.7 % of scale length	0.7 % of scale length	0.7 % of scale length
Shorting measurement current	1.2 mA max.	1.2 mA max.	1.2 mA max.	0.6 mA max.	0.6 mA max.
Scale center indication	0.5 MΩ	1 MΩ	2 MΩ	20 MΩ	50 MΩ
AC voltage scale and tolerances	±5 % f.s. at 0 to 250 V (50/60 Hz)	±5 % f.s. at 0 to 300 V (50/60 Hz)	±5 % f.s. at 0 to 500 V (50/60 Hz)	±5 % f.s. at 0 to 500 V (50/60 Hz)	±5 % f.s. at 0 to 500 V (50/60 Hz)

### Common SPECIFICATIONS

Discharge function : effective  
Power supply : R6P(AA)×4  
Dimensions, mass :  
152W×95H×47D mm, 420 g

Accessories :  
9292 TEST PROBE(1)  
9384 CARRYING CASE(1)

Safety rating :  
Conformance to IEC1010, pollution degree 2, installation category III

### OPTIONS

- \*9288 BREAKER PIN
- 9293 PIN-TYPE EARTH PROBE
- \*Note: Non-CE mark product

## 3452-11 to 3452-13 MΩ HiTESTER

Compact analog three-range insulation resistance meter



### SPECIFICATIONS

Model	3452-11			3452-12			3452-13		
Testing voltage	25 V DC	50 V DC	100 V DC	125 V DC	250 V DC	500 V DC	250 V DC	500 V DC	1000 V DC
Rated resistance	10 MΩ	10 MΩ	20 MΩ	20 MΩ	50 MΩ	100 MΩ	50 MΩ	100 MΩ	2000 MΩ
First effective measurement range and tolerances	±5 % of scale indication at 0.01 MΩ to 5 MΩ			±5 % of scale indication at 0.02 MΩ to 10 MΩ			±5 % of scale indication at 0.05 MΩ to 20 MΩ		
Second effective measurement range and tolerances	±5 % of scale indication at 5 M to 10 MΩ, 0.005M to 0.01MΩ			±10 % of scale indication at 10 M to 20 MΩ, 0.01M to 0.02MΩ			±10 % of scale indication at 20 M to 50 MΩ, 0.02M to 0.05MΩ		
0MΩ & infinity indication	0.7 % of 100 V scale length			0.7 % of 500 V scale length			0.7 % of 1000 V scale length		
Open-circuit terminal voltage	Not more than 1.2 times rated testing voltage			Not more than 1.2 times rated testing voltage			Not more than 1.2 times rated testing voltage		
Rated measurement current	1 m to 1.2 mA			1 m to 1.2 mA			1 m to 1.2 mA		
Shorting measurement current	1.2 mA max.			1.2 mA max.			1.2 mA max.		
Scale center indication	0.2 MΩ	0.2 MΩ	0.5 MΩ	0.5 MΩ	1 MΩ	2 MΩ	1 MΩ	2 MΩ	50 MΩ
AC voltage scale & tolerances	±5 % f.s. at 0 to 150 V (50/60 Hz)			±5 % f.s. at 0 to 500 V (50/60 Hz)			±5 % f.s. at 0 to 500 V (50/60 Hz)		

### Common SPECIFICATIONS

Discharge function : effective  
Power supply : R6P(AA)×4  
Dimensions, mass :  
152W×95H×47D mm, 420g

Accessories :  
9292 TEST PROBE(1)  
9384 CARRYING CASE(1)

Safety rating :  
Conformance to IEC1010, pollution degree 2, installation category III

### OPTIONS

- \*9288 BREAKER PIN
- 9293 PIN-TYPE EARTH PROBE
- \*Note: Non-CE mark product

# 3151 EARTH HiTESTER

## Stable measurement for earth resistance

- Measurement range for grounding resistance increased to 115 % of normal range
- Elastomer rotary knob fits the hand perfectly.
- Select the "simple" two-wire measurement method, using a low ground conductor such as the ground side of a commercial power supply, or the conventional three-wire measurement method
- Select a measurement frequency to reduce the influence of harmonics of the power supply frequency on the ground current

SPECIFICATIONS	
Measurement item	Grounding resistance, Grounding voltage
Measurement ranges	10Ω (0 to 11.5Ω) to 1000Ω (0 to 1150Ω), 3 ranges 30V (0 to 30 VAC), 1 range *Using the two-wire measurement method; applied to 100Ω /1000Ω range only.
Operating method	AC phase difference
Open terminal voltage	50V AC max.
Measurement current	15mA AC max. *3mA AC max. using two-wire method.
Measurement frequency	575Hz or 600 Hz selectable
Basic accuracy	Grounding resistance: ±2.5% f.s. Grounding voltage: ±3% f.s.
Power supply	R6P (AA), 6 pieces (at least 500 operations) or LR6 (AA), 6 pieces (at least 1400 operations) *Operating time: 30 second measurement, 30 second off
Dimensions, mass	164W×119H×88D mm, 800g (main unit only)
Accessories	9214 AUXILIARY EARTHING ROD(2), 9215 MEASURING CABLE (one earth: black 5m, yellow 10m, red 20m, 9216 CABLE WINDER: 3), 9393 CARRYING CASE(1)



### OPTIONS

9050 EARTH NET (set of two)  
\*Use in location where there is no driven-in ground and where water seepage is present



CAT III 600 V

# 3129 PHASE DETECTOR

## Non-Metallic Contact for Optimal Safety

SPECIFICATIONS		
Measurement Function	Phase detection(positive, negative), live wire check(R-S/S-T only)	
Voltage Detection Method	Electrostatic induction method	
Voltage Range	70V to 600V AC(50/60Hz)(sine wave, continuous input)	
Clamp Diameter	17mm max.of insulated wiring	
Display	Phase Detection	Positive:4 LEDs lit in clockwise order and 3 short beeps Negative:4 LEDs lit in counterclockwise order and one continuous beep
	Live Wire Check	R-S and S-T lamps will light if voltage between wires are within voltage range
	Battery Check Function	ON lamp blinks to indicate battery low status when instrument is turned on
Auto Power Off	Auto shut off if no activity is detected after power is turned ON for 15 minutes	
Power Supply	Two "AA" size batteries; rated voltage:DC3.0V; maximum rated power:300mVA; continuous use:approx.70 hours(standby)	
Dimensions, Mass	70W×75H×30D mm, 200g; Cord length:0.7m	
Accessories	Carrying case×1, strap×1, R6P manganese battery×2, spiral tubex1, user manual	



# Options & Peripherals

## HS-1 | HS-2 | EXTERNAL SHUNTS

Used with a 50mV full scale meter

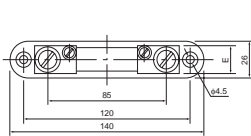

HS-1

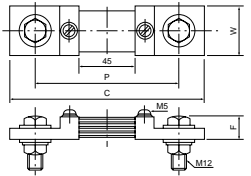

HS-2

HS-1 SPECIFICATIONS	
Model & rated current	HS-1(30A), HS-1(50A), HS-1(75A), HS-1(100A), HS-1(150A), HS-1(200A), HS-1(300A)
Accuracy (50/60 Hz)	JIS-Class 0.5 (±0.5% at rated current)
Rating	50 mV
Dimensions, mass	30A type:20(E), 6(F),M4(d), M5(d) mm, 110g 50A type:20(E), 8(F),M4(d), M8(d) mm, 150g 75A type:20(E), 8(F),M4(d), M8(d) mm, 155g 100A type:20(E),15(F),M5(d), M8(d) mm, 250g 150A type:20(E),15(F),M5(d), M8(d) mm, 250g 200A type:25(E),15(F),M5(d),M10(d) mm, 320g 300A type:25(E),15(F),M5(d),M10(d) mm, 330g
Accessories	None

HS-2 SPECIFICATIONS	
Model & rated current	HS-2(500A), HS-2(750A), HS-2(1000A)
Accuracy (50/60 Hz)	JIS-Class0.5 (±0.5% at rated current)
Rating	50mV
Dimensions, mass	500A type:115(P),155(C),45(W),20(F)mm,740g 750A type:135(P),175(C),60(W),30(F)mm 1000A type:135(P),175(C),60(W),30(F)mm
Accessories	None

Note: The total resistance of the connection cord must be 0.1Ω or less.

## CT-2MR | CT-5MRN | CURRENT TRANSFORMER

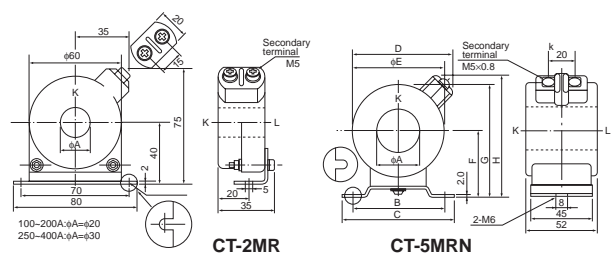

CT-2MR:SPECIFICATIONS	
Model & rated current	CT-2MR(100A), CT-2MR(120A), CT-2MR(150A), CT-2MR(200A), CT-2MR(250A), CT-2MR(300A)
Accuracy (50/60 Hz)	JIS-Class1.0 (±1% of rated value)
Rated load	2VA
Secondary current	5A (all models)
Conductor voltage rating	1150VAC
Dimensions	See figure
Accessories	None

CT-5MRN:SPECIFICATIONS	
Model & rated current	CT-5MRN(100A), CT-5MRN(120A), CT-5MRN(150A), CT-5MRN(200A), CT-5MRN(250A), CT-5MRN(300A), CT-5MRN(500A), CT-5MRN(600A)
Accuracy (50/60 Hz)	JIS-Class1.0 (±1% of rated value)
Rated load	5VA
Secondary current	5A (all models)
Conductor voltage rating	1150VAC
Dimensions	100-200A:23(φA),70(B),85(C),65(D),60(φE),45(F),75(G),83(H) mm 250-300A:32(φA),70(B),85(C),76(D),70(φE),50(F),85(G),91(H) mm 500-600A:50(φA),80(B),100(C),89.5(D),85(φE),58(F),100.5(G),105(H)mm
Accessories	None

Wiring: Pass the wire through center of the C.T. When measuring under 100 A, use the equation below to find the number of times that the wire is to be passed through. Number of turns = (Primary current of C.T.)÷(Maximum value measured) However, in order to make the number of turns a full number, select the primary current or full scale.

## HB-1 | EXTERNAL MULTIPLIER

Used with a 1mA full scale meter

HB-1 SPECIFICATIONS	
Model & rated voltage	HB-1(500V), HB-1(750V)
Accuracy (50/60 Hz)	JIS-Class 0.5 (±0.5% at rated voltage)
Rating	1mA
Dimensions, mass	See figure, 75g
Accessories	None

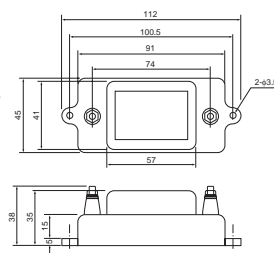

## Options & Peripherals

# 2103 | 2104 | METER RELAY

### Advancing power saving and automation

- Electronic design assures high accuracy and reliability
- Ultra sensitive 1 mA, 10 mV DC movement
- Replaces relays in plug-in systems
- Includes a display lamp to illuminate movement at a glance
- Relay action delays circuit closure upon power on
- Both power circuitry and relay built-in

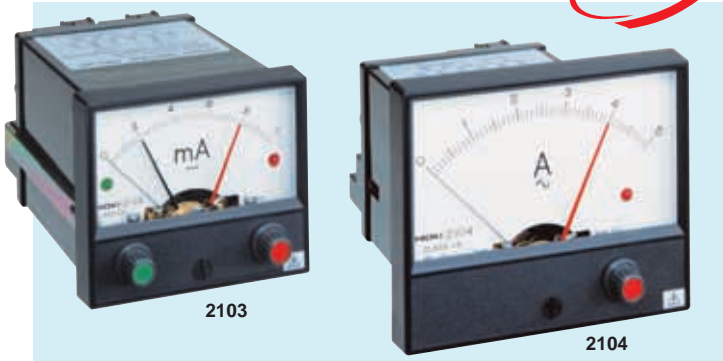

### Standard SPECIFICATIONS

Meter class	2103:±2.5% class, 2104: ±1.5% class
Deflecting range	Passing type, full scale
Setting pointer	Lance shape, upper limit and lower limit pointer
Setting accuracy	±1.5% of scale length
Minimum setting width	Within 3% of scale length
Relay power delay circuit	Approx. 2 second
Relay output response	Approx. 0.5 second
Output contact capacity	5A (under condition of 250V AC, 30V DC, resistance load)
Power supply	100/200V AC ±10%

### OPTIONS

(Special specifications)

- ±1.5% class: for Model 2103
- Extended scale: double or triple extended scale
- Segmented scale: magnified scale for up to 40 % of the maximum scale value
- Double deflection meter: for example, zero-centered scale
- Relay response time: time constant 0.05 second fixed (DC) and variable types also available
- Setting accuracy: Version with ±1.0 % type
- Delay time: Version with variable delay time after power on. 0.1 to 10 seconds: (for instruments input DC), 2 to 12 seconds: (for instruments input AC)
- Output signal: Version with 1 V DC f.s. output terminal
- \*not isolated from input circuit ground.
- Power supply: Version with 110, 120, 220, 230, 240 V AC ±10 %

### Dimensions

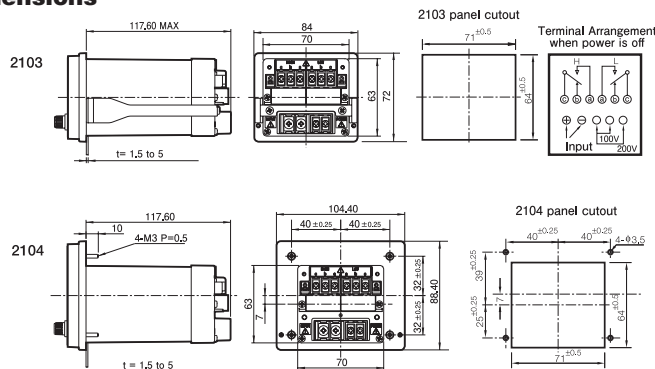

### Standard Scale Graduations

Full-Scale Value	Graduations	Graduation Illustration
1,10,100	50	0 2 4 6 8 10
1.5,15,150	30	0 5 10 15
2,20,200	40	0 5 10 15 20
2.5,25,250	50	0 5 10 15 20 25
3,30,300	30	0 1 2 3
5,50,500	50	0 1 2 3 4 5
6,60,600	30	0 2 4 6
7.5,75,750	37.5	0 2 4 6 7.5

### Standard Full-Scale Values

DC Ammeter		DC Voltmeter		Rectifying AC Ammeter		Rectifying AC Voltmeter	
Std. Full-Scale Value	Meter Sensitivity Spec.	Std. Full-Scale Value	Meter Sensitivity Spec.	Std. Full-Scale Value	Meter Sensitivity Spec.	Std. Full-Scale Value	Meter Sensitivity Spec.
1 μA	50mV	10 mV	100kΩ/V	200 μA	50mV	50 mV	10kΩ/V
10		15	100kΩ/V	500		100	10kΩ/V
20		30	100kΩ/V	1 mA*3		150	10kΩ/V
50		50*2	100kΩ/V	2		300	10kΩ/V
100		100	100kΩ/V	5		500	1kΩ/V
200		150	100kΩ/V	10		1	1kΩ/V
500		300	100kΩ/V	20		1.5	1kΩ/V
1 mA*1		500	10kΩ/V	50		3	1kΩ/V
2		1	10kΩ/V	100		5	1kΩ/V
5		1.5	10kΩ/V	200		10	1kΩ/V
10	3	10kΩ/V	500	15	1kΩ/V		
20	5	10kΩ/V	1	30	1kΩ/V		
50	10	10kΩ/V	2	50	1kΩ/V		
100	15	10kΩ/V	3	100	1kΩ/V		
200	30	10kΩ/V	5	150	1kΩ/V		
500	50	10kΩ/V	10	300	1kΩ/V		
1	100	10kΩ/V	1	5	1kΩ/V		
2	150	10kΩ/V	2	10	1kΩ/V		
5	300	10kΩ/V	3	15	1kΩ/V		
10			5	20	1kΩ/V		
20				30	1kΩ/V		
Full-Scale: 4-20mA	50mV	Full-Scale: 1-5V	10kΩ/V				

- When the full-scale value is larger than 20A, an external shunt device is used with the 50-mV instrument denoted by.\*2
- When the full-scale value is larger than 300V, an external multiplier is used with the 1-mA instrument denoted by.\*1

### Contact operation

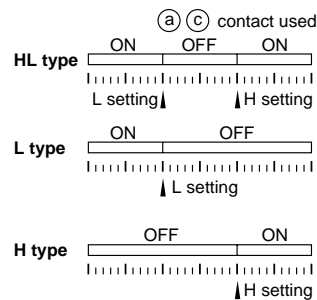

















- When the full-scale value is larger than 5A, an external CT is used with the 5A instrument denoted by.\*4
- When the full-scale value is larger than 300V, an external multiplier is used with the 1-mA instrument denoted by.\*3

# Options & Peripherals

Note: \* marked products are discontinued models.

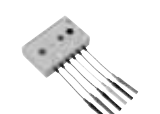
## Test Leads and Probes ...Included as accessories with main unit, or sold separately (optional products)

						
<b>3851-10</b> TEST LEAD ... for 3251*, 3252*, 3253* ... 3801, 3802, 3803 ... 3804, 3805, 7015	<b>9014</b> HIGH VOLTAGE PROBE ... for 3081*, 3205*, 3207* ... 3208*, 3209*, 3212* ... 3230*, 3250s	<b>9017</b> HIGH VOLTAGE PROBE ... for 3030*, 3012*, 3015* ... 3021*, 3030-10	<b>9021-01</b> THERMISTOR TEMPERATURE PROBE ... for 3000*, 3007*, 3015* ... 3021*, 3030-10, 3100	<b>9060</b> TEST LEAD ... for 3008, 3125*	<b>9060-01</b> TEST LEAD ... for 3108-01*, 3109-01* ... 3008	<b>9067</b> TEST LEAD ... for 3127-10, 3128-10 ... 3000*, 3021*, 3100* ... 3102*, 3104*, 3261* ... 3262*, 3264*, 3265*
						
<b>9094</b> OUTPUT CORD ... for 3412-50, 3283 ... 3284, 3285, 3225* ... 3404, 3422*	<b>9140</b> 4-TERMINAL PROBE ... for 3503, 3511-50 ... 3520*, 3521*, 3522-50 ... 3532-50	<b>9143</b> PINCHER PROBE ... for 3503, 3511-50 ... 3520*, 3521*, 3522-50 ... 3532-50	<b>9153</b> TEST LEADS WITH FUSE ... for 3021*, 3030, 3127 ... 3128	<b>9165</b> CONNECTION CORD ... for 3601*, 7075, 8850* ... 8852*, 8852-01*, 8855 ... LCR/Z HiTESTER	<b>9166</b> CONNECTION CORD ... for 3601*, 7075, 8850* ... 8852*, 8852-01*, ... LCR/Z HiTESTER	<b>9168</b> INPUT CORD ... for 7010*, 7011
						
<b>9170</b> TEST LEAD ... for 3156, 3155, 3200* ... 3210*, 3215*, 3216* ... 3222*, 3223*, 3230* ... 3231*, 3233*, 3234* ... 3236*, 3256*, 3257* ... 7011	<b>9177</b> INPUT CORD ... for 8815*, 8816*, 8830* ... 8831*, 8832* ... 8833* ... 8821* ... 9555	<b>9178</b> VOLTAGE CORD ... for 3165	<b>9179</b> VOLTAGE CORD ... for 3167, 3192*, 3195*	<b>9185</b> TEST LEAD ... for 3255*	<b>9186</b> INPUT CORD ... for 8852*, 8852-01*	<b>9190</b> VOLTAGE APPLY PROBE ... for 3155-01*
						
<b>9195</b> ENCLOSURE PROBE ... for 3155-01*	<b>9196</b> APPLY UNIT ... for 3155-01*	<b>9197</b> CONNECTION CORD ... for 8806*, 8807, 8808 ... 8826, 8835, 8841 ... 8842, 8855	<b>9198</b> CONNECTION CORD ... for 8806*, 8807, 8808 ... 8826, 8835, 8841 ... 8842, 8855	<b>9199</b> CONVERSION ADAPTOR ... for 8806*, 8807, 8808 ... 8826, 8835, 8841 ... 8842, 8855	<b>9207</b> TEST LEAD ... for 3030-10	<b>9207-10</b> TEST LEAD ... for 3281, 3282, 3284, 3285 3256-50/-51, 3257-50/-51
						
<b>9208</b> TEST LEADS ... for 3280*, 3280-01* ... 3280-10, 3280-11 ... 3280-20, 3287, 3288	<b>9209</b> TEST LEADS HOLDER ... for 3280*, 3280-01* ... 3280-10, 3280-11 ... 3280-20, 3287, 3288	<b>9215</b> MEASURING CABLE ... for 3151	<b>9217</b> CONNECTION CORD ... for 8806*, 8807, 8808 ... 8826, 8835, 8841 ... 8842, 8855	<b>9219</b> CONNECTION CABLE ... for 9695-02, 9695-03	<b>9257</b> CONNECTION CORD ... for 8205-10, 8206-10 ... 8220*, 3454-11 ... 3454-10, 3453 ... 3118-11, 3118-12	<b>9261</b> TEST FIXTURE ... for 3503, 3511-50 ... 3520*, 3521*, 3522-50 ... 3530*, 3531*, 3532-50
						
<b>9262</b> TEST FIXTURE ... for 3503, 3511-50 ... 3520*, 3521*, 3522-50 ... 3530*, 3531*, 3532-50	<b>9263</b> THERMISTOR TEMPERATURE PROBE ... 3503, 3511-50, 3520* ... 3521*, 3522-50, 3530* ... 3531*, 3532-50	<b>9264-01</b> WIRING ADAPTER ... for 3196	<b>9264-02</b> WIRING ADAPTER ... for 3196	<b>9265</b> MEASUREMENT CABLE ... for 3143	<b>9268</b> DC BIAS VOLTAGE UNIT ... for 3503, 3511-50 ... 3522-50, 3532-50	<b>9269</b> DC BIAS CURRENT UNIT ... for 3503, 3511-50 ... 3522-50, 3532-50



Note: \* marked products are discontinued models.



**9287-10**  
CLIP TYPE LEAD  
... for 3155-01\*, 3226\*  
... 3227\*, 3239, 3540  
... 3541, 3555, 3560



**9288**  
BREAKER PIN  
... for 3118-11, 3118-12,  
... 3451-11, 3451-12,  
... 3451-13, 3451-14,  
... 3451-15, 3452-11,  
... 3452-12, 3452-13,  
... 3453, 3454-10,  
... 3454-11



**9289**  
TEST PROBE  
... for 3118-11, 3118-12  
... 3154, 3453, 3454-10  
... 3454-11



**9292**  
TEST PROBE  
... for 3451-11, 3451-12  
... 3451-13, 3451-14  
... 3451-15, 3452-11  
... 3452-12



**9293**  
PIN TYPE EARTH PROBE  
... for 3451-11, 3451-12  
... 3451-13, 3451-14  
... 3451-15, 3452-11  
... 3452-12



**9294**  
TEST PROBE  
... for 3117s\*, 3118-11  
... 3118-12, 3154, 3453



**9296**  
CURRENT PROBE  
... for 3157, 3157-01



**9297**  
CURRENT APPLY PROBE  
... for 3157, 3157-01



**9299**  
SWITCHED PROBE  
... for 3154



**9300**  
CONNECTION CABLE  
... for 3541



**9326**  
CONNECTION CORD  
... for 8205\*, 8205-10



**9437**  
CONNECTION CABLE  
... for 8845\*/8846\*



**9438**  
VOLTAGE CORD  
... for 3166\*



**9438-02**  
VOLTAGE CORD  
... for 3196



**9438-03**  
VOLTAGE CORD  
... for 3169



**9452**  
CLIP TYPE LEAD  
... for 3227\*, 3239, 3540  
... 3541, 3555, 3560



**9453**  
FOUR TERMINAL LEAD  
... for 3227\*, 3239, 3540  
... 3541, 3555, 3560



**9454**  
ZERO ADJUSTMENT BOARD  
... for 3155-01\*, 3227\*,  
... 3239, 3540,  
3541, 3555, 3560

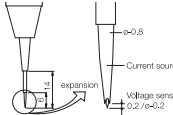

**9455**  
PIN TYPE LEAD  
... for 3227\*, 3239, 3540  
... 3541, 3555, 3560



**9460**  
CLIP TYPE LEAD WITH  
TEMPERATURE SENSOR  
... for 3540, 3550, 3551



**9461**  
PIN TYPE LEAD  
... for 3155-01\*, 3227\*  
... 3239, 3540, 3541  
... 3555, 3560



**9465**  
PIN TYPE LEAD  
... for 3239, 3540, 3541  
... 3550, 3551, 3555  
... 3560



**9466**  
REMOTE CONTROL  
SWITCH  
... for 3551, 3560



**9467**  
LARGE CLIP TYPE LEAD  
... for 3227\*, 3239, 3540  
... 3541, 3550, 3551  
... 3560



**9574**  
INPUT CORD  
... for 8840\*/45\*/46\*, 8853\*, 8851\*



**9615**  
H.V. TEST LEAD  
... for 3153, 3158, 3159  
... 3173, 3930



**9617**  
CLIP ON BASE  
... for 3501, 3801, 3802  
... 3804, 3805



**9618**  
CLIP-TYPE LEAD  
... for 3501, 3801, 3802  
... 3804, 3805



**9635**  
VOLTAGE CORD  
... for 3286\*, 3286-20

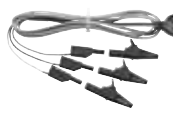

**9635-01**  
VOLTAGE CORD  
... for 3286-20



**9639**  
CONNECTION CABLE  
... for 3637, 3645



**9641**  
CONNECTION CABLE  
... for 8420.s1, 8421.s1, 8422.s1



**9665**  
10:1 PROBE  
... for 8855



**9666**  
100:1 PROBE  
... for 8855



**9677**  
SMD TEST FIXTURE  
... for 3503, 3511-50,  
3522-50, 3532-50, 3535



**9699**  
SMD TEST FIXTURE  
... for 3503, 3511-50,  
3522-50, 3532-50, 3535



**9699**  
ALLIGATOR CLIPS  
... (used with Test  
Lead, insert), for 9170,  
or similar devices

# Options & Peripherals

Note: \* marked products are discontinued models.

## RECORDING PAPERS ...Sold separately (optional products)

Model	Recording Paper	Paper Size
3155-01 LEAK CURRENT HITESTER*	9233	58 mm × 10 m, 10 rolls
3165 CLAMP ON POWER HITESTER*	9223	58 mm × 10 m, 10 rolls
3193 POWER HITESTER	9232	74 mm × 10 m, 10 rolls
3194 MOTOR/HARMONIC HITESTER	9232	74 mm × 10 m, 10 rolls
3196 POWER QUALITY ANALYZER	9237	80 mm × 25 m, 4 rolls
3541 RESISTANCE HITESTER	9237	80 mm × 25 m, 4 rolls
8205-10 MICRO HiCORDER	9235 9236-01	60 mm × 15 m, 10 rolls 60 mm × 15 m, climate-resistant, 10 rolls
8206-10 MICRO HiCORDER	9235 9236-01	60 mm × 15 m, 10 rolls 60 mm × 15 m, climate-resistant, 10 rolls
8420-01 MEMORY HILOGGER*	9234	112 mm × 18 m, 10 rolls
8420-51 MEMORY HILOGGER	9234	112 mm × 18 m, 10 rolls
8421-01 MEMORY HILOGGER*	9234	112 mm × 18 m, 10 rolls
8421-51 MEMORY HILOGGER	9234	112 mm × 18 m, 10 rolls
8422-01 MEMORY HILOGGER*	9234	112 mm × 18 m, 10 rolls
8422-51 MEMORY HILOGGER	9234	112 mm × 18 m, 10 rolls
8715-01 POWER HiCORDER	9234	112 mm × 18 m, 10 rolls
8807-01 MEMORY HiCORDER	9234	112 mm × 18 m, 10 rolls

Model	Recording Paper	Paper Size
8807-51 MEMORY HiCORDER	9234	112 mm × 18 m, 10 rolls
8808-01 MEMORY HiCORDER	9234	112 mm × 18 m, 10 rolls
8808-51 MEMORY HiCORDER	9234	112 mm × 18 m, 10 rolls
8826 MEMORY HiCORDER	9229 9229-01	264 mm × 30 m, 6 rolls perforated, 6 rolls
8835-01 MEMORY HiCORDER	9221	110 mm × 30 m, 10 rolls
8841 MEMORY HiCORDER	9231	216 mm × 30 m, 6 rolls
8842 MEMORY HiCORDER	9231	216 mm × 30 m, 6 rolls
8852, 8852-01 MEMORY HiCORDER*	9221	110 mm × 30 m, 10 rolls
8855 MEMORY HiCORDER	9231	216 mm × 30 m, 6 rolls
8860, 8861 MEMORY HiCORDER	9231	216 mm × 30 m, 6 rolls
8992 PRINTER UNIT	9234	112 mm × 18 m, 10 rolls
8994 PRINTER UNIT	9231	216 mm × 30 m, 6 rolls
9203 DIGITAL PRINTER	9233	58 mm × 10 m, 10 rolls
9442 PRINTER	1196	112 mm × 25 m, 10 rolls
9604 PRINTER UNIT	9232	74 mm × 10 m, 10 rolls
9670 PRINTER	9237	80 mm × 25 m, 4 rolls

## Temperature probes or sensors ...Included as accessories with main unit, or sold separately (optional products)

Model	Type/Note	Compatible Instrument
9021-01 THERMISTER TEMPERATURE PROBE	-50 to 200°C	3030-10, 3127-10, 3128-10
9180 TEMPERATURE PROBE	Sheath type, up to 750°C non-waterproof	3412-50, 3441, 3442
9181 TEMPERATURE PROBE	Surface type, up to 400°C non-waterproof	3412-50, 3441, 3442
9182 TEMPERATURE PROBE	Sheath type, up to 750°C non-waterproof	3412-50, 3441, 3442
9183 TEMPERATURE PROBE	Sheath type, up to 750°C non-waterproof	3412-50, 3441, 3442
9184 RJ SENSOR	reference contact compensation -25 to 80°C	7011
9188 TEMPERATURE PROBE	included with the 3227	3227
9451 TEMPERATURE PROBE	included with the 3540	3540
9462 THERMISTER TEMPERATURE PROBE	-50 to 150°C	3281, 3282
9463 TEMPERATURE HUMIDITY SENSOR	fixed type	3625
9464 TEMPERATURE HUMIDITY SENSOR	extension type, (2.7m)	3625
9472 TEMPERATURE PROBE	Sheath type, up to 300°C waterproof structure	3441, 3442
9472-50 TEMPERATURE PROBE	Sheath type, up to 300°C waterproof structure	3446-01
9473 TEMPERATURE PROBE	Sheath type, up to 800°C waterproof structure	3441, 3442
9473-50 TEMPERATURE PROBE	Sheath type, up to 800°C waterproof structure	3446-01
9474 TEMPERATURE PROBE	Sheath type, up to 300°C waterproof structure	3441, 3442
9475 TEMPERATURE PROBE	Sheath type, up to 500°C waterproof structure	3441, 3442

Model	Type/Note	Compatible Instrument
9476 TEMPERATURE PROBE	Surface type, up to 500°C non-waterproof	3441, 3442
9476-50 TEMPERATURE PROBE	Surface type, up to 500°C non-waterproof	3446-01
9478 TEMPERATURE PROBE	Sheath type, up to 300°C Waterproof structure	3447-01(Pt-100)
9479 TEMPERATURE PROBE	Sheath type, up to 300°C Waterproof structure	3447-01(Pt-100)
9680 HUMIDITY SENSOR	1 m length	3641-20
9680-01 HUMIDITY SENSOR	5 m length	3641-20
9680-02 HUMIDITY SENSOR	10 m length	3641-20
9631-01 TEMPERATURE SENSOR	1 m length	3632/3633/3641-20
9631-11 TEMPERATURE SENSOR	5 m length	3632/3633/3641-20
9631-21 TEMPERATURE SENSOR	10 m length	3632/3633/3641-20
9631-02 TEMPERATURE SENSOR	1 m length	3632/3633/3641-20
9631-03 TEMPERATURE SENSOR	1 m length	3632/3633/3641-20
9631-04 TEMPERATURE SENSOR	1 m length	3632/3633/3641-20
9631-14 TEMPERATURE SENSOR	5 m length	3632/3633/3641-20
9631-24 TEMPERATURE SENSOR	10 m length	3632/3633/3641-20
9631-05 TEMPERATURE SENSOR	30 mm length	3632/3633/3641-20

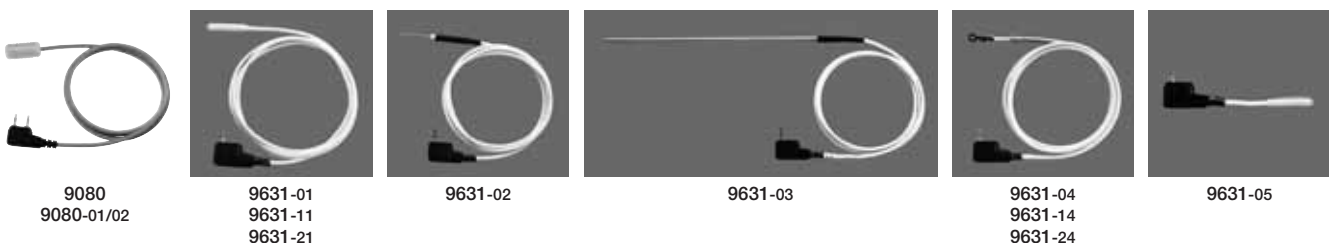
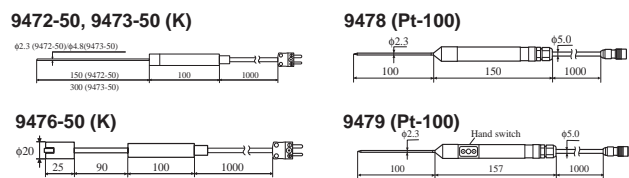
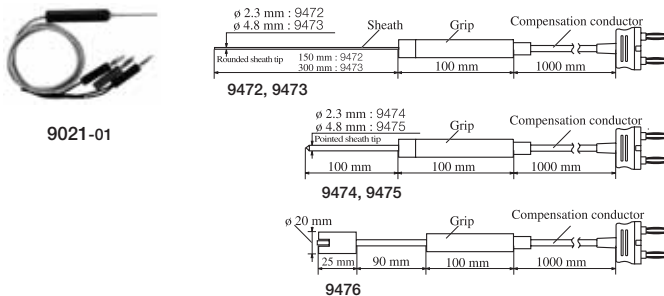

Note: \* marked products are discontinued models.

## All Accessories

<b>1195</b> RECORDING PAPER . . . . . for 3192 (10rolls)*	<b>9151-02</b> GP-IB CONNECTOR CABLE . . . . . for 3511, 3330-02*, 3332 (2m)	<b>9221</b> RECORDING PAPER . . . . . for 8801*, 8802*, 8835-01 (110mm × 30m 10rolls)
<b>1196</b> RECORDING PAPER . . . . . for 3154, 3332-02, 3511, 3196 (10rolls)	<b>9151-04</b> GP-IB CONNECTOR CABLE . . . . . for 3511, 3330-02*, 3332 (4m)	<b>9222</b> RECORDING PAPER . . . . . for 3224-02*, 3225-02*, 3235*
<b>3851-10</b> TEST LEAD . . . . . for 3801, 3802, 3803, 3804, 3805	<b>9153</b> TEST LEADS WITH FUSE . . . . . for 3030, 3127*, 3128*, 3127-11	<b>9223</b> RECORDING PAPER . . . . . 9200 (38mm × 8.5m 5rolls)
<b>3852</b> RS-232C PACKAGE . . . . . for 3801, 3802	<b>9165</b> CONNECTION CORD . . . . . for 3511, 3601*, 7075, 7075-01(BNC-BNC)	<b>9224</b> RECORDING PAPER . . . . . for 3165*, 3191 (80mm × 30m 5rolls)*
<b>3853</b> CARRYING CASE . . . . . for 3803, 3804, 3805	<b>9166</b> CONNECTION CORD . . . . . for 3511, 3601*, 7075, 7075-01 (BNC-Clip)	<b>9226</b> RECORDING PAPER . . . . . for 8820 (216mm × 50m 6rolls)*
<b>3854</b> RS-232C PACKAGE . . . . . for 3803, 3804, 3805	<b>9168</b> INPUT CORD . . . . . for 7010*, 7011	<b>9227</b> RECORDING PAPER . . . . . for 3234 (38mm × 3m 5rolls)*
<b>3909</b> INTERFACE PACK . . . . . for 3443, 3444, 3445	<b>9170</b> TEST LEAD . . . . . for 3200*, 10*, 16*, 22*, 23*, 33*, 34*, 36*, 7011	<b>9228</b> RECORDING PAPER . . . . . for 8850 (114mm × 30m 10rolls)*
<b>3920-01</b> DATA READER for 3650. . . . . for 3650	<b>9177</b> INPUT CORD . . . . . for 8904*, 8906*, 8932*, 9555	<b>9229</b> RECORDING PAPER . . . . . for 8825 (264mm × 30m 6rolls)*
<b>9005-01</b> CLAMP ON PROBE . . . . . for 3000*, 09*, 11*, 15*, 20*, 21*, 30, 3215*	<b>9178</b> VOLTAGE CORD . . . . . for 3165*	<b>9229-01</b> RECORDING PAPER(PERFORATED) . . . . . for 8826 (264mm × 30m 6rolls)
<b>9010</b> CLAMP ON PROBE . . . . . for 8200*, 3255	<b>9179</b> VOLTAGE CORD . . . . . for 3195*	<b>9231</b> RECORDING PAPER . . . . . for 8840*, 8841, 8842 (216mm × 30m 6rolls)
<b>9010-10</b> CLAMP ON PROBE . . . . . for 8714*, 8715	<b>9180</b> SHEATH TYPE TEMPERATURE PROBE . . . . . for 3412-50, 3441/42 (200°C)	<b>9232</b> RECORDING PAPER . . . . . for 8804*, 8205, 8206, 8806*
<b>9014</b> HIGH VOLTAGE PROBE . . . . . for 3081*, 3205*, 3207*, 3208*, 3209*, 3212*, 3230*, 3250S	<b>9181</b> SURFACE TEMPERATURE PROBE . . . . . for 3412-50, 3441/42 (400°C)	<b>9233</b> RECORDING PAPER . . . . . for 9203, 9203-01
<b>9017</b> HIGH VOLTAGE PROBE . . . . . for 3000*, 3012*, 3015*, 3021*, 3030	<b>9182</b> SHEATH TYPE TEMPERATURE PROBE . . . . . for 3412-50, 3441/42 (1000°C)	<b>9234</b> RECORDING PAPER . . . . . for 8807, 8808, 8420
<b>9018</b> CLAMP ON PROBE . . . . . for 8205, 8206, 8805, 8807, 8808	<b>9183</b> SHEATH TYPE TEMPERATURE PROBE . . . . . for 3412-50, 3441/42 (800°C)	<b>9235</b> RECORDING PAPER . . . . . for 8205, 8206
<b>9018-10</b> CLAMP ON PROBE . . . . . for 8714*, 8715	<b>9184</b> TEMPERATURE PROBE . . . . . for 7010*, 7011 (-25°C~80°C)	<b>9236-01</b> RECORDING PAPER . . . . . for 8205, 8206
<b>9021-01</b> THERMISTER TEMPERATURE PROBE . . . . . for 3000*, 3007*, 3015*, 3021*, 3030, -12, 3100*, 3127-11	<b>9185</b> TEST LEAD . . . . . for 3154, 3255	<b>9237</b> RECORDING PAPER . . . . . for 9670
<b>9032</b> METAL CONTACT TIP . . . . . 3402*, 3403, 3404	<b>9186</b> INPUT CORD . . . . . for 8851(10:1)*	<b>9245</b> CARRYING CASE . . . . . for 3286-20
<b>9033</b> RUBBER CONTACT TIP . . . . . for 3402*, 3403, 3404	<b>9188</b> TEMPERATURE PROBE . . . . . for 3227*	<b>9246</b> CARRYING CASE . . . . . for 3664, 9742
<b>9035</b> AC ADAPTER . . . . . for 3108*, 31*, 32*, 61*, 62*, 3220*, 05*, 09*, 3402-04, 22 (6V)*	<b>9190</b> VOLTAGE APPLY PROBE . . . . . for 3155*	<b>9257</b> CONNECTION CORD . . . . . for 8205, 8206, 8220*
<b>9036</b> AC ADAPTER . . . . . for 3110*, 3204*, 9005, 9006*, 3411 (9V)*	<b>9195</b> ENCLOSURE PROBE . . . . . for 3155*	<b>9261</b> TEST FIXTURE . . . . . for LCR
<b>9039</b> AC ADAPTER . . . . . for 3501 (12V )	<b>9196</b> APPLY UNIT . . . . . for 3155*	<b>9262</b> TEST FIXTURE . . . . . for 3502*, 3511, 3520*, 3531*, 3532
<b>9050</b> EARTH NETS . . . . . for 3124*, 3150*, 3151	<b>9197</b> CONNECTION CORD . . . . . for 8806*, -01*, 8807, 8808, 8826, 8835-01, 8841, 8842	<b>9263</b> THERMISTER TEMPERATURE PROBE . . . . . for 3511, 3522, 3532
<b>9060</b> TEST LEAD . . . . . for 3008, 3125*	<b>9198</b> CONNECTION CORD . . . . . for 8806*, -01*, 8807, 8808, 8826, 8835-01, 8841, 8842	<b>9264-01</b> WIRING ADAPTER . . . . . for 3196, (3P3Ø)
<b>9060-01</b> TEST LEAD . . . . . for 3108*, 3109*	<b>9199</b> CONVERSION ADAPTER . . . . . for 8806*, -01*, 8807, 8808, 8826, 8835-01, 8841, 8842	<b>9264-02</b> WIRING ADAPTER . . . . . for 3196, (3P4Ø)
<b>9067</b> TEST LEAD . . . . . for 3261*, 3262*, 3127-10, 3128-10	<b>9203</b> DIGITAL PRINTER . . . . . for 3227*, 3540, 3550, 3560	<b>9265</b> MEASUREMENT CABLE . . . . . for 3143
<b>9070</b> AC ADAPTER . . . . . for 3118, 3119*	<b>9207</b> TEST LEAD . . . . . for 3030-10, 3030-12, 3282-01, 3284, 3285	<b>9267</b> SAFETY TEST DATA MANAGEMENT SOFTWARE . . . . . for 3153, 3156/57/58/59, 3332
<b>9073</b> RECORDING PAPER . . . . . for 8201*, 8202*, 8204 (10rolls)*	<b>9207-10</b> TEST LEAD . . . . . for 3281, 82, 84, 85, 3256-51/51, 3257-50/51	<b>9268</b> DC BIAS VOLTAGE UNIT . . . . . for 3511, 3522, 3532
<b>9074</b> RECORDING PAPER . . . . . for 8203 (1ch) (10rolls)*	<b>9208</b> TEST LEADS . . . . . for 3287, 3280, -01, -10, -11, 3288	<b>9269</b> DC BIAS CURRENT UNIT . . . . . for 3511, 3522, 3532
<b>9081</b> EXTERNAL SHUNT . . . . . for 3245 (10A)*	<b>9209</b> TEST LEADS HOLDER . . . . . for 3287, 3280, -01, -10, -11, 3288	<b>9270</b> CLAMP ON SENSOR . . . . . for 3191*, 3165*, 3192*, 3167 (20A)
<b>9083</b> CARRYING CASE . . . . . for 3108*, 3109*, 3131*, 3132*	<b>9211</b> REFLECTIVE TAPE . . . . . for 3402*, 3403*, 3404	<b>9271</b> CLAMP ON SENSOR . . . . . for 3191*, 3165*, 3192*, 3167 (200A)
<b>9084</b> CARRYING CASE . . . . . for 3180*, 3222*, 3223*, 3235*	<b>9212</b> PERIPHERAL RING . . . . . for 3402*, 3403*, 3404	<b>9272</b> CLAMP ON SENSOR . . . . . for 3191*, 3165*, 3192*, 3167 (20/200A)
<b>9088</b> CARRYING CASE . . . . . for 3030*, 3021*	<b>9213</b> CONTACT ADAPTER . . . . . for 3403, 3404	<b>9274</b> CLAMP ON AC/DC SENSOR . . . . . for AC/DC20A
<b>9094</b> OUTPUT CORD . . . . . for 3154, 3225*, 3403, 04, 3412-50, 3422*, 3283, 84, 85	<b>9214</b> AUXILIARY EARTHING ROD . . . . . for 3151	<b>9276</b> CLAMP ON AC/DC SENSOR . . . . . for AC/DC150A
<b>9132</b> CLAMP ON PROBE . . . . . for AC1000A	<b>9215</b> MEASURING CABLE . . . . . for 3151	<b>9277</b> UNIVERSAL CLAMP ON CT . . . . . for 3192*, 3167 (AC/DC20A)
<b>9132-10</b> CLAMP ON PROBE . . . . . for 8714*, 8715	<b>9216</b> CABLE WINDER . . . . . for 3151	
<b>9135</b> RECORDING PAPER . . . . . for 3215 (5rolls)*	<b>9217</b> CONNECTION CORD . . . . . for 8806*, -01*, 8807, 08, 8826, 8841, 42	
<b>9140</b> 4-TERMINAL PROBE . . . . . for 3511, 3520*, 3521*, 3532	<b>9219</b> CONNECTION CABLE . . . . . for 3169, 3196, 9695-02, 9695-03	
<b>9143</b> PINCHER PROBE . . . . . for 3511, 3520*, 3521*, 3530*, 3532		
<b>9144</b> CARRYING CASE . . . . . for 3030*, 3021*		
<b>9148</b> CARRYING CASE . . . . . for 3128, 3261*, 3262*, 3263*		

# Options & Peripherals

Note: \* marked products are discontinued models.

9278 UNIVERSAL CLAMP ON CT ..... for 3192*, 3167 (AC/DC200A)	9364 CARRYING CASE ..... for 3118-12	..... for 3551, 3560
9279 UNIVERSAL CLAMP ON CT ..... for 3192*, 3167 (AC/DC 500A)	9365 CARRYING CASE ..... for 3165*	9455 PIN TYPE LEAD ..... for 3226*, 3227*, 3540, 3560
9287-10 CLIP TYPE LEAD ..... for 3226*, 3540	9371 CARRYING CASE ..... for 3255	9458 AC ADAPTER..... for 3196
9288 BREAKER PIN ..... for 3452	9372 CARRYING CASE ..... for 8804*, 8806*	9459 BATTERY PACK..... for 3196
9289 TEST PROBE..... for 3454-51	9375 CARRYING CASE ..... for 9277-9279	9460 CLIP TYPE LEAD WITH TEMPERATURE SENSOR ..... for 3550, 3551, 3551-03
9290-10 CLAMP ON ADAPTER ..... for 1000A CT 10 : 1	9376 CARRYING CASE ..... for 3423*	9461 PIN TYPE LEAD..... for 3155*, 3555, 3540
9291 CLAMP ON SENSOR ..... for 3166*	9377 CARRYING CASE ..... for 3551	9462 THERMISTER TEMPERATURE PROBE ..... for 3281*, 3282, 3282-01
9292 TEST PROBE..... for 3451, 3452	9378 CARRYING CASE ..... for 3256	9463 HUMIDITY SENSOR ..... for 3625
9293 PIN TYPE EARTH PROBE ... for 3451, 3452	9380 CARRYING CASE ..... for 7011	9464 HUMIDITY SENSOR ..... for 3625
9294 TEST PROBE..... for 3154, 3453	9382 CARRYING CASE ..... for 3550, 3555	9465 PIN TYPE LEAD ..... for 3550, 3551, 3552, 3555, 3540
9296 CURRENT PROBE ..... for 3157, 3157-01	9384 CARRYING CASE ..... for 3452	9466 REMOTE CONTROL SWITCH ..... for 3551, 9465
9297 CURRENT APPLY PROBE ..... for 3157, 3157-01	9386 CARRYING CASE ..... for 3441, -01, -02, 3442-02, -03	9467 LARGE CLIP TYPE LEAD ..... for 3550, 3226*, 3227*
9299 SWITCHED PROBE ..... for 3154	9386-01 CARRYING CASE ..... for 3441, 3442, 3446, 3447	9472 SHEATH TYPE TEMPERATURE PROBE ..... for 3441, -01, -02, 3442-02, -03, 7015*
9300 CONNECTION CABLE ..... for 3541	9388 CARRYING CASE .. for 8835*, 8835-01, 3155*	9472-50 SHEATH TYPE TEMPERATURE PROBE ..... for 3446 (K)
9303 PT ..... for 8815*, 25*, 30*, 32*, 51* (PT 40:1,20:1 )	9390 CARRYING CASE ..... for 3030-10, 3030-12	9473 SHEATH TYPE TEMPERATURE PROBE ..... for 3441, -01, -02, 3442-02, -03, 7015*
9305 TRIGGER CORD ..... for 8801*, 8802*, 8803*, 8820*, 8835-01	9391 CARRYING CASE ..... for 8807, 8808, 8420	9473-50 SHEATH TYPE TEMPERATURE PROBE ..... for 3446 (K)
9315 LOGIC PROBE..... for 8852*	9392 CARRYING CASE ..... for 3625	9474 SHEATH TYPE TEMPERATURE PROBE ..... for 3441, -01, -02, 3442-02, -03, 7015* (K)
9318 CONVERSION CABLE ..... for 8940	9393 CARRYING CASE ..... for 3151	9475 SHEATH TYPE TEMPERATURE PROBE ..... for 3441, -01, -02, 3442-02, -03, 7015* (K)
9319 CONVERSION CABLE ..... for 8940	9397-01 CARRYING CASE.... for 8855, 8841, 8720	9476 SURFACE TYPE TEMPERATURE PROBE ..... for 3441, -01, -02, 3442-02, -03, 7015* (K)
9320 LOGIC PROBE..... for 8800series	9398 CARRYING CASE ..... for 3280, -01*, -10, -11, 3287, 3288	9476-50 SURFACE TYPE TEMPERATURE PROBE ..... for 3446 (K)
9320-01 LOGIC PROBE ..... for 8807, 8808	9399 CARRYING CASE ..... for 3281, 3282, 3284, 3282-01	9478 SHEATH TYPE TEMPERATURE PROBE ..... for 3447 (PT-100)
9321 LOGIC PROBE..... for 8800series	9400 CARRYING CASE ..... for 3290	9479 SHEATH TYPE TEMPERATURE PROBE ..... for 3447 (PT-100 with switch)
9321-01 LOGIC PROBE ..... for 8807, 8808	9418-10 AC ADAPTER ..... for 3167, 3551, 7011	9496 NETWORK A ..... for 3155*
9322 DIFFERENTIAL PROBE ..... for 8800series	9418-15 AC ADAPTER ..... for 8420/21/22, 8714*/15, 8807/08	9497 NETWORK B ..... for 3155*
9323 CONVERSION CABLE ..... for 9320, 9321	9420 BATTERY PACK..... for 7011, 8804*	9498 NETWORK C ..... for 3155*
9324 POWER CORD ..... for 9322	9425 CONNECTION CABLE ..... for 9203, 9203-01	9499 NETWORK D ..... for 3155*
9325 POWER CORD ..... for 8940, 9322	9433 DC POWER ADAPTER ..... for 8841, 8842, 8720	9517 GP-IB INTERFACE ..... for 3186, 3227*
9326 CONNECTION CORD..... for 8205, 8206	9436 CONNECTION CABLE ..... for 3423*	9518-01 GP-IB INTERFACE ..... for 3511, 3531*, 3532
9327 LOGIC PROBE..... for 8800series	9437 CONNECTION CABLE ..... for 8927(8845)*	9518-02 GP-IB INTERFACE ..... for 3157, 3157-01
9328 POWER CORD ..... for 8855	9438 VOLTAGE CORD ..... for 3166*	9540-01 FUNCTION UP DISK ..... for 8835-01
9329 TERMINAL UNIT ..... for 8420-51, 8421-51, 8422-51	9438-02 VOLTAGE CORD..... for 3196	9549 FUNCTION UP DISK(POWER MONITOR) ..... for 8855
9330-01 WAVE PROCESSOR ..... for 8835	9438-03 VOLTAGE CORD..... for 3169	9555 SENSOR UNIT..... for 9270, 9271, 9272
9331-01 WAVE PROCESSOR ..... for 8806*	9439 DC POWER ADAPTER..... for 8835	9557 RS-232C CARD ..... for 8826, 8835*, 8835-01, 8841, 8842, 8720
9332 WAVE COMMUNICATOR..... for 8808	9440 CONNECTION CABLE ..... for 3166*	9558 GP-IB CARD ..... for 8826, 8835*, 8835-01, 8841, 8842, 8720
9333 LAN COMMUNICATOR ..... for 8800series	9441 CONNECTION CABLE ... for 3166*, 3169-01	9574 INPUT CORD..... for 8944(8851)*
9334 LOGGER COMMUNICATOR ..... for 8420	9442 PRINTER ..... for 3443, 44	9588 GP-IB INTERFACE ..... for 3227*, 3167, 3187, 3330*, 3330-02*
9335 WAVE PROCESSOR..... for 8800series	9443-02 AC ADAPTER ..... for 3166*, 3330-02*, 3332, 3511, 3154	
9336 WIREMAP TERMINATOR..... for 3660	9443-03 AC ADAPTER ..... for 3166*, 3330-02*, 3332, 3511, 3154	
9337 DIRECTION TERMINATOR..... for 3660	9444 CONNECTION CABLE ..... for 3154, 3166*, 3196, 3332, 9442, 3511	
9338 CARRYING CASE ..... for 3143	9445-02 AC ADAPTER ..... for USA, CANADA	
9339 CARRYING CASE ..... for 3196 (soft case)	9445-03 AC ADAPTER ..... for EU	
9340 CARRYING CASE ..... for 3196 (hard case)	9446 CONNECTION CABLE ..... for 3522, 3532, 3330*	
9344 CARRYING CASE ..... for 8205, 8206	9447 BATTERY PACK..... for 8807, 8808, 8420	
9345 CARRYING CASE ..... for 3285	9451 TEMPERATURE PROBE..... for 3540	
9347 CARRYING CASE ..... for 8220*	9452 CLIP TYPE LEAD..... for 3560, 3540	
9349 CARRYING CASE ..... for 8842	9453 FOUR TERMINAL LEAD..... for 3560, 3540	
9350 CARRYING CASE ..... for 3660	9454 ZERO ADJUSTMENT BOARD	
9351 CARRYING CASE .. for 3127*, 3127-11, 3100*		
9355 CARRYING CASE .... for 3265*, 3267*, 3286		
9359 CARRYING CASE ..... for 3117*		
9360 CARRYING CASE .... for 3165* (9270~9272)		
9363 CARRYING CASE ..... for 3118-11		

*Note: \* marked products are discontinued models.*

9589 PRINTER INTERFACE . . . . . for 3227*	9631-21 TEMPERATURE SENSOR (9631-01,10m) . . . . . for 3641 (10 m)	9680 HUMIDITY SENSOR . . . . . for 3641 (1m)
9593-01 RS-232C INTERFACE . . . . . for 3522, 3531*, 3532	9631-24 TEMPERATURE SENSOR (9631-04,10m) . . . . . for 3641 (10 m)	9680-01 HUMIDITY SENSOR . . . . . for 3641 (5m)
9593-02 RS-232C INTERFACE . . . for 3157, 3157-01	9632 CONNECTION CABLE . . . . . for 3634, 3635-04-06, 3635-24-26, 3636	9680-02 HUMIDITY SENSOR . . . . . for 3641 (10m)
9598 MO UNIT . . . . . for 8826	9633 CONNECTION CABLE . . . . . for 3634,3635	9681 HUMIDITY SENSOR . . . . . for 8420s
9599 MEMORY BOARD . . . . . for 8826 (48Mword)	9634 CONNECTION CABLE . . . for 3630, 3635-01,02	9685 CARRYING CASE . . . . . for 3246
9600 AC/DC DIRECT INPUT UNIT . . . . . for 3193	9635 VOLTAGE CORD . . . . . for 3286	9686 CARRYING CASE . . . . . for 3156
9601 AC DIRECT INPUT UNIT . . . . . for 3193	9635-01 VOLTAGE CORD . . . . . for 3268	9691 CLAMP ON AC/DC SENSOR . . . . . for 3290 AC100A
9602 AC/DC CLAMP INPUT UNIT . . . . . for 3193	9636 RS-232C CABLE . . . . . for 3286	9692 CLAMP ON AC/DC SENSOR . . . . . for 3290 AC200A
9603 EXTERNAL SIGNAL INPUT UNIT . . . for 3193	9636-01 RS-232C PACKAGE . . . . . for 3286	9693 CLAMP ON AC/DC SENSOR . . . . . for 3290 AC2000A
9603-01 EXTERNAL SIGNAL INPUT UNIT . . . . . for 3194	9637 RS-232C CABLE (9pin-9pin/1.8m) . . . . . for 3154, 3630S, 3911-20	9694 CLAMP ON SENSOR . . . . . for 3169, 3196 AC5A
9604 PRINTER UNIT . . . . . for 3193	9638 RS-232C CABLE (9pin-25pin/1.8m) . . . . . for 3154, 3630S, 3911-20	9699 SMD TEST FIXTURE . . . . . for 3511
9605 HARMONIC/FLICKER MEASUREMENTS UNIT . . . . . for 3193	9639 CONNECTION CABLE . . . . . for 3637	9700-10 HEAD AMP UNIT . . . . . for 3535
9605-01 HARMONIC MEASUREMENTS UNIT . . . . . for 3194	9641 CONNECTION CABLE . . . . . for 8420	9713-01 CAN CABLE . . . . . for 8910
9607 MO UNIT . . . . . for 8841, 8842	9642 LAN CABLE . . . . . for 8420	9713-02 CAN CABLE . . . . . for 8910
9608 MEMORY BOARD(24M-WORD) . . . . . for 8841, 8842	9643 CHARGE STAND . . . . . for 8420	9714-01 LOGIC CABLE . . . . . for 8910
9612 RS-232C CABLE . . . . . for DIN 9pin-Dsub 9pin 8807, 8808, 8420	9644 SCSI INTERFACE . . . . . for 8855	9714-02 LOGIC CABLE . . . . . for 8910
9613 REMOTE CONTROL BOX(SINGLE) . . . . . for 3158	9645 MEMORY BOARD . . . . . for 8855	9720 CARRYING CASE . . . . . for 3169
9614 REMOTE CONTROL BOX(DUAL) . . . . . for 3158	9645-01 MEMORY BOARD . . . . . for 8855	9721 RS-232C CABLE . . . . . for 3169
9615 H.V.TEST LEAD . . . . . for 3158	9646 MO UNIT . . . . . for 8855	9726 PC CARD 128M . . . . . for 8800S, 3169, 3196
9615-01 H.V.TEST LEAD . . . . . for 3931 Red (High Voltage)	9648 CARRYING CASE . . . . . for 8807, 8808, 8420, 8421, 8714*, 8715	9727 PC CARD 256M . . . . . for 8800S, 3169, 3196
9615-03 H.V. TEST LEAD . . . . . for 3931 Black (Return)	9649 PROTECTIVE CASE . . . . . for 8807, 8808, 8420, 8421	9728 PC CARD 512M . . . . . for 8800S, 3169, 3196
9616 WARNING LAMP . . . . . for 3158	9650 CLAMP ON SENSOR . . . . . for 100A 8205, 8206, 3636-20	9730 CARRYING CASE . . . . . for 3661, 3662, 3663
9617 CLIP ON BASE . . . . . for 3501, 3801, 3802, 3804, 3805	9651 CLAMP ON SENSOR . . . . . for 500A 8205*, 8206*, 3636-20	9731 FC CONNECTOR ADAPTER . . . . . for 3661
9618 CLIP-TYPE LEAD . . . . . for 3501, 3801, 3802, 3804, 3805	9652 FIXED STAND . . . . . for 8807, 8808, 8420, 8421	9732 SC CONNECTOR ADAPTER . . . . . for 3661
9623 POWER ANALYZER . . . . . for 3193	9652-01 FIXED STAND . . . . . for 8420-50, 8421-50, 8422-50, 8807, 8808	9733 FC CONNECTOR ADAPTER . . . . . for 3662, 3663
9624 POA-HIVIEW . . . . . for 3196	9653 HUMIDITY SENSOR . . . . . for 8420, 8421	9734 SC CONNECTOR ADAPTER . . . . . 3662, 3663
9624-10 POA-HIVIEW PRO . . . . . for 3196	9657 CLAMP ON LEAK SENSOR . . . . . for 3638	9735 FC-FC OPTICAL FIBER CABLE . . . . . for 3661, 3662, 3663
9625 POWER MEASUREMENT SUPPORT SOFTWARE . . . . . for 3166*, 3168, 3169	9657-10 CLAMP ON LEAK SENSOR . . . . . for 8808series (BNC)	9736 SC-SC OPTICAL FIBER CABLE . . . . . for 3661, 3662, 3663
9626 PC CARD 32M . . . . . for 8800S, 3169, 3196	9658 CLAMP ON LEAK SENSOR . . . . . for 3638	9737 SC-FC OPTICAL FIBER CABLE . . . . . for 3661, 3662, 3663
9627 PC CARD 64M . . . . . for 8800S, 3169, 3196	9660 CLAMP ON SENSOR . . . . . for 3196 AC100A	9738 OPTICAL CONNECTOR CLEANER . . . . . for 3661, 3662, 3663
9628 LAN CABLE . . . . . for 3660	9661 CLAMP ON SENSOR . . . . . for 3196 AC500A	9739 SPARE CLEANER . . . . . for 3661, 3662, 3663
9629 CONNECTION CABLE . . . . . for 3639	9662 LUX SENSOR . . . . . for 3640	CT-101A LINE SPLITTER . . . . . for 3127-11 etc.
9631-01 TEMPERATURE SENSOR . . . . . for 3641 (1m)	9663 HD UNIT . . . . . for 8855	220H PAPER WINDER . . . . . TEPTOM-220H
9631-02 TEMPERATURE SENSOR . . . . . for 3641 (1m)	9665 10:1PROBE . . . . . for 8855	ALLIGATOR CLIPS . . . . . 9170 or similar devices (used with Test Lead, inserted)
9631-03 TEMPERATURE SENSOR . . . . . for 3641 (1m)	9666 100:1PROBE . . . . . for 8855	
9631-04 TEMPERATURE SENSOR . . . . . for 3641 (1m)	9667 FLEXIBLE CLAMP ON SENSOR . . . . . for 3196 AC5000A	
9631-05 TEMPERATURE SENSOR . . . . . for 3641 (30 mm)	9668 CLAMP ON SENSOR . . . . . for 8205-10/8206-10 AC1000A	
9631-11 TEMPERATURE SENSOR (9631-01,5m) . . . . . for 3641 (5 m)	9669 CLAMP ON SENSOR . . . . . for 3196 AC1000A	
9631-14 TEMPERATURE SENSOR (9631-04,5m) . . . . . for 3641 (5 m)	9670 PRINTER . . . . . for 3196, 3446/47	
	9671 AC ADAPTER . . . . . for 9670	
	9674 RS-232C PACKAGE . . . . . for 3446/47	
	9677 SMD TEST FIXTURE . . . . . for 3511	
	9678 CONNECTION CABLE . . . . . for 3535	
	9679 CONNECTION CABLE . . . . . for 3503	

# HIOKI - Offering Top Quality Products and Services

HIOKI E.E. CORPORATION TRACEABILITY CHART

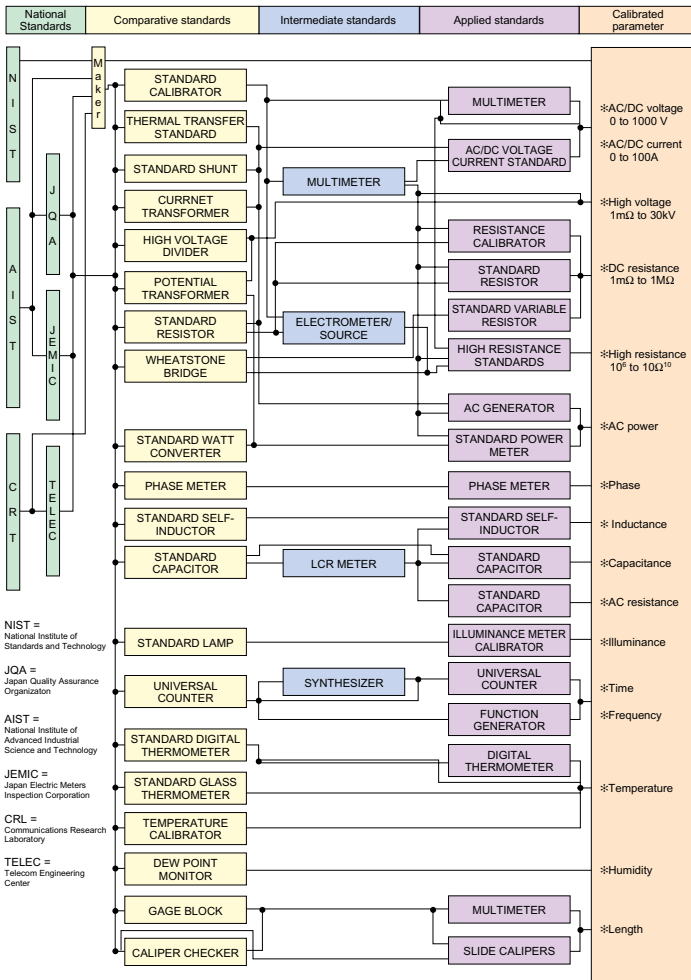

Note: Only the primary standards are indicated above. For details, please refer each product's TRACEABILITY CHART. Please also note that the naming of the standards indicated in this chart may differ from the naming used in each product's TRACEABILITY CHART.

Accuracy can be regarded as the heart of a measuring instrument. To maintain accuracy, traceability and accountability in the form of a coherent and comprehensive management system that reaches to the national standards are indispensable.

Traceability allows us to manage and maintain instrument accuracy characteristics that are tied to recognized national and international standards. How they are managed and maintained are dependent on the measurement facilities that offer accuracy testing at the various levels, skilled technicians, as well as a strong link between national standards, manufacturer reference equipment, field measuring instruments, and basic measuring instruments.

The HIOKI Traceability System as indicated by the chart on the left is strictly managed by accounting for each individual instrument - from reference instruments to field equipment - and their constant accuracy. As scientific techniques and manufacturing technology continue to expand and develop, we will strive to meet new demands by not only providing the appropriate measuring instruments for our users, but also enhancing the accuracy in our test instruments and maintaining our Traceability System so that they are constantly on par with global standards.

## HIOKI's Calibration System

In order to provide dependable and quality-assured products, HIOKI has acquired the international standard ISO/IEC17025 certification for calibration, which allows us to meet a wide variety of calibration needs. By regularly calibrating HIOKI instruments using reference calibrating equipment traceable to national standards while complying with the reference equipment organizational chart, customers are guaranteed complete accuracy. After purchase, it is highly recommended that customers regularly re-calibrate their HIOKI instruments to maintain their accuracy. Depending on your needs, calibration and adjustment can be conducted at HIOKI in one of 4 ways as illustrated on the right.

### Types of Calibration

Type	Action	Price
Type 1	The relationship between the measurement values of the instrument being serviced and those of the reference and testing instruments placed in the higher order in the calibration flow are observed and the results are recorded in a data sheet. (If the measurement values fall outside of the specifications for accuracy, these values are not indicated.) 	Calibration + Data Sheet
Type 2	The relationship between the measurement values of the instrument being serviced and those of the reference and testing instruments placed in the higher order in the calibration flow are observed and the results are recorded in a data sheet. The instrument is then adjusted, and once again compared to the same reference and testing instruments, and the results are recorded in a separate data sheet. 	Calibration + Adjustment + 2 Data Sheet
Type 3	The relationship between the measurement values of the instrument being serviced and those of the reference and testing instruments placed in the higher order in the calibration flow are observed and the results are recorded in a data sheet. If the values are within the specifications for accuracy, calibration is completed. If the values fall outside of the specifications, the instrument is then adjusted, compared again to the same reference and testing instruments, and the results are recorded in a separate data sheet. 	Calibration + Data Sheet Calibration + Adjustment + 2 Data Sheet
Type 4	Whether or not the instrument's measurement values fall within the specifications for accuracy, it is first adjusted, and then compared to the values of the reference and testing instruments placed in the higher order of the calibration flow. The results are then recorded in a data sheet. 	Calibration + Adjustment + Data Sheet

## About our Company



Established in 1935, HIOKI E. E. CORPORATION has grown to be a leading developer and manufacturer of advanced test and measurement technologies for use both in the field and leading edge facilities around the world. Our goal is simple: contribute to the advancement of society, while making sure the natural environment is not compromised. As a reliable producer and member of society, we pledge to continue to actively contribute to the cultural and educational development of the local community through activities such as greening efforts, scholarship programs and sponsoring children's sports teams. With the support of our customers and worldwide network, we are confident that our values and beliefs, and products and services, will be brought forth through the 21st century and beyond.

## Internet website



[www.hioki.co.jp](http://www.hioki.co.jp)

## Corporate History

- 1935 HIOKI starts manufacturing electrical measuring instruments in Tokyo
- 1945 Move to Nagano Prefecture due to war
- 1946 Tester No.1 put to market
- 1952 HIOKI E.E. CORPORATION established  
Designated as the manufacturer of MULTITESTER (MIL Standard) for the U.S. Far East Air Forces
- 1965 Mass production of VU instruments for recording level adjustments to tape recorders
- 1975 Independent development and sale of instruments with internal magnetic taut bands
- 1983 Multiple awards received for innovative clamp-style instruments
- 1990 Move to HIOKI Forest Hills
- 1991 Registered on the over-the-counter market
- 1992 Awarded the Afforestation Center Presidential Award for positively promoting afforestation
- 1993 ISO9001 certified
- 1997 ISO14001 certified
- 1998 HIOKI USA CORPORATION established
- 2001 HIOKI Shanghai Representative Office established  
Listed on the Second Section of the Tokyo Stock Exchange
- 2003 Listed on the First Section of the Tokyo Stock Exchange
- 2005 "Solution Fair" - 70th Anniversary Celebration



# Celebrating 70 Years

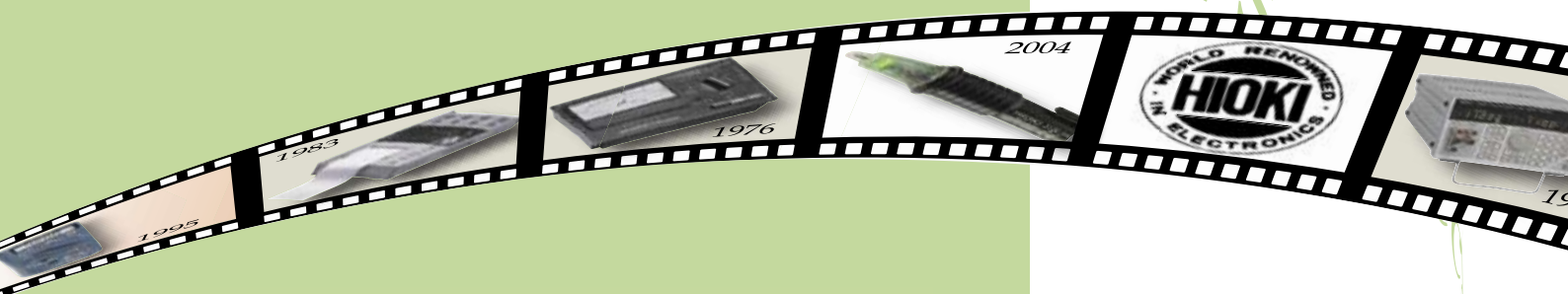

Technological Evolution

## HIOKI

HIOKI E. E. CORPORATION

### HEAD OFFICE:

81 Koizumi, Ueda, Nagano  
386-1192, Japan  
TEL+81-268-28-0562  
FAX+81-268-28-0568  
E-mail:os-com@hioki.co.jp

### HIOKI USA CORPORATION:

6 Corporate Drive  
Cranbury, NJ 08512 USA  
TEL+1-609-409-9109  
FAX+1-609-409-9108  
E-mail: hioki@hiokiusa.com

### Shanghai Representative Office:

1704, Shanghai Times Square Office  
93 Huaihai Zhong Road, Shanghai, 200021, P.R.China  
TEL +86-21-6391-0090/0092  
FAX +86-21-6391-0360  
E-mail: info@hioki.cn



DISTRIBUTED BY

All information correct as of April 10, 2005. All specifications are subject to change without notice.



This brochure has been printed on recycled paper with special ink blended with recycled soy oil.