

Lead-acid Battery Handbook

Facilitating Accurate Measurement of Lead-acid Batteries



Contents

■About lead-acid batteries	3
■Principles of lead-acid battery	4
■Detailed description of the discharge reaction in lead-acid batteries	5
■Detailed description of the charge reaction in lead-acid batteries	6
■Types of lead-acid batteries: Vented type	7
■Types of lead-acid batteries: Valve-regulated type (VRLA)	8
■Lead-acid battery electrodes	9
■Causes of self-discharge in lead-acid batteries	10
■Degradation of lead-acid batteries: Chemical degradation	11
■Degradation of lead-acid batteries: Physical degradation	12
■Internal resistance of lead-acid batteries	13
■Factors that determine internal resistance in lead-acid batteries	14
■Measuring the internal resistance of lead-acid batteries (JIS C 8704-1)	15
■Starting performance of lead-acid batteries: Cold-cranking amps (CCA)	16
■Measuring the internal resistance of lead-acid batteries: Impedance method	17
■Measuring the internal resistance of lead-acid batteries: Conductance method	18
■Charging lead-acid batteries: Trickle charging	19
■Charging lead-acid batteries: Float charging	20
■JIS standards related to lead-acid batteries (as of 2013)	21
■Lead-acid battery classifications	22

■About lead-acid batteries

The lead-acid battery was invented in France in 1869 by Gaston Planté. Production in Japan began in 1897 by Genzo Shimadzu the second. Lead-acid batteries are distinguished by comparatively high voltage of around 2 V and the ability to deliver currents ranging from dozens to hundreds of amperes. In addition, lead as a material is abundantly available as a resource and therefore inexpensive, with the result that the lead-acid battery continues to be the most widely used type of rechargeable battery today. Although lead-acid batteries are significantly less capable to lithium-ion batteries in terms of energy density, it is likely that they will continue to be used in applications where energy density is not a primary consideration, for example in permanently installed emergency power supplies, due to their cost advantages.

While lead has the image of being harmful for human health and the environment, Japan's Lead Recycling Program has achieved a recycling rate of almost 100%, with the result that lead-acid batteries generally receive excellent marks for recyclability. Ready recyclability is one advantage of lead-acid batteries.

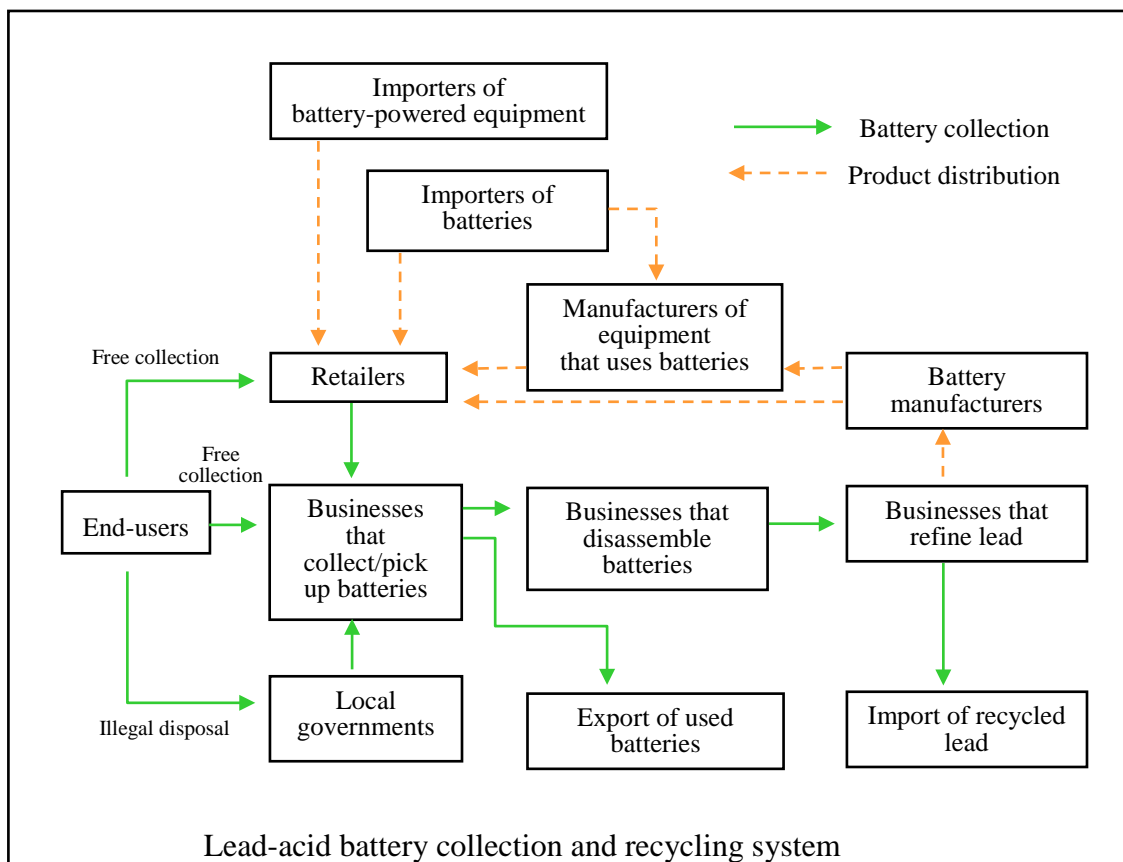

■ Principles of lead-acid battery

Lead-acid batteries use a lead dioxide (PbO₂) positive electrode, a lead (Pb) negative electrode, and dilute sulfuric acid (H₂SO₄) electrolyte (with a specific gravity of about 1.30 and a concentration of about 40%). When the battery discharges, the positive and negative electrodes turn into lead sulfate (PbSO₄), and the sulfuric acid turns into water. When the battery is charged, the opposite reaction occurs (Equation [1]).

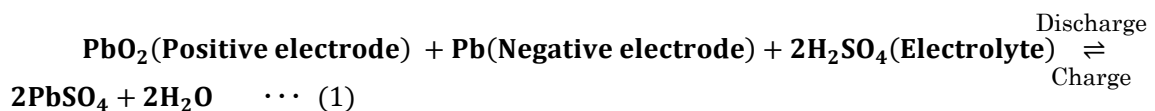

When a lead-acid battery is discharged, the battery's voltage gradually declines because the sulfuric acid in its electrolyte decreases. Theoretically, the concentration of H₂SO₄ is about 39.7% (the specific gravity of about 1.30) when the battery is fully charged at 2.14 V. The concentration will fall to about 6.6% (the specific gravity of about 1.05) when the battery is fully discharged at 1.9V. (In an actual battery, values may diverge from theoretical values depending on the conditions of use.)

Additionally, the specific gravity of the electrolyte in automotive batteries may be measured as part of battery maintenance. Since the sulfuric acid concentration declines when the battery degrades, this measurement serves as an indicator of when the battery needs to be replaced.

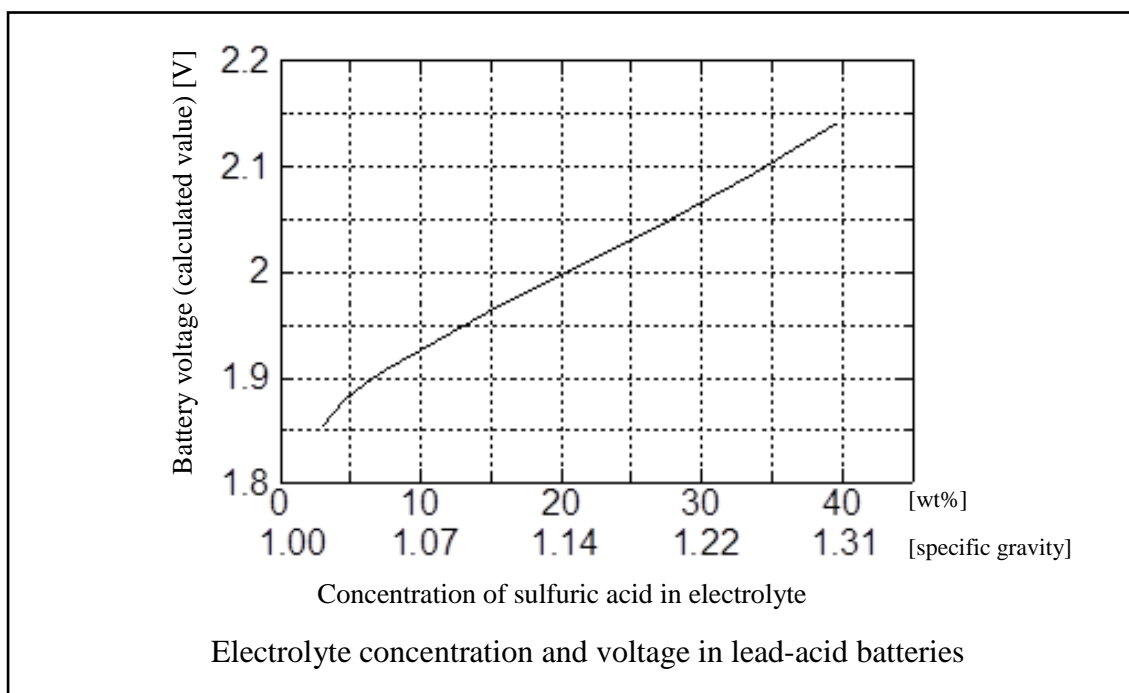

■Detailed description of the discharge reaction in lead-acid batteries

■Reaction at the negative electrode

When a lead-acid battery is discharged after connecting a load such as a light bulb between its positive and negative electrodes, the lead (Pb) in the negative electrode releases electrons (e^-) to form lead ions (Pb^{2+}).

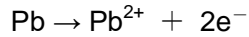

Then the lead ions immediately bond with sulfate ions (SO_4^{2-}) in the electrolyte to form lead sulfate ($PbSO_4$) and adhere to the surface of the negative electrode.

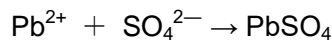

The above activity at the negative electrode is summarized by Equation (1):



■Reaction at the positive electrode

Electrons (e^-) that have flowed from the negative electrode through the load to the positive electrode give the positive electrode a negative charge, attracting hydrogen ions (H^+) in the electrolyte. The hydrogen ions strip oxygen ions (O^{2-}) from the lead dioxide (PbO_2) in the positive electrode to form water (H_2O). Meanwhile, the lead dioxide from which the oxygen was stripped remains as lead ions (Pb^{2+}).

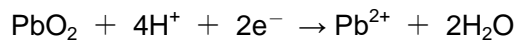

Those lead ions immediately bond with sulfate ions (SO_4^{2-}) in the electrolyte to become lead sulfate ($PbSO_4$) and adhere to the surface of the positive electrode.

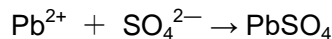

The above activity at the positive electrode is summarized by Equation (2):

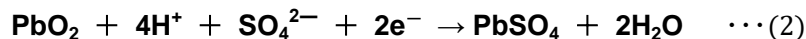

■Overall reaction

Equations (1) and (2) can be summarized to express the overall discharge reaction in a lead-acid battery as shown in Equation (3):

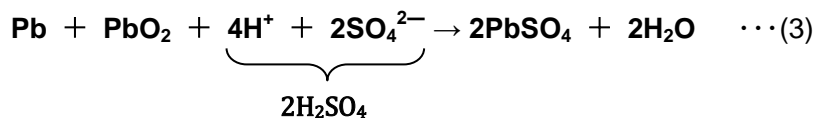

■Detailed description of the charge reaction in lead-acid batteries

■Reaction at the negative electrode

If a power supply is connected between a lead-acid battery's positive and negative electrodes so that electrons (e^-) are forced to flow to the negative electrode, the lead sulfate ($PbSO_4$) that formed while the battery was discharging will revert to lead (Pb) in a reaction that releases sulfate ions (SO_4^{2-}).



■Reaction at the positive electrode

Meanwhile, the positive electrode, from which electrons (e^-) were stripped, will gain a positive charge in a reaction in which water (H_2O) breaks down into oxygen (O_2) and hydrogen ions (H^+).



Then, because the lead sulfate ($PbSO_4$) at the positive electrode lacks electrons, it will immediately react with oxygen to form lead dioxide (PbO_2) in a reaction that releases sulfate ions (SO_4^{2-}).

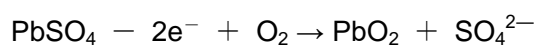

The above activity at the positive electrode is summarized by Equation (2):



■Overall reaction

Equations (1) and (2) can be summarized to express the overall reaction in a lead-acid battery as shown in Equation (3):

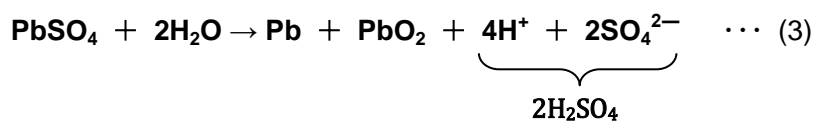

■Types of lead-acid batteries: Vented type

This type of battery is also known as a liquid or flooded battery.

It has a series of air holes to allow the oxygen and hydrogen gas formed by electrolysis of the electrolyte during charging to escape. This design uses the same basic structure that was in use when the lead-acid battery was invented, and most automotive lead-acid batteries use it.

Although it is necessary to replenish water in the electrolyte that is lost due to evaporation and electrolysis by adding purified water (water that is free of impurities), some designs allow longer intervals between replenishments by converting the hydrogen given off by the reaction back into water with a catalyst plug.

Vented batteries can be further classified as either clad or paste types based on the structure of their positive plate. The clad type incorporates the active material into a glass fiber tube so that it is less likely to fall off, giving the design superior durability. In the paste type, the electrode is created by applying the active material in paste form to a lead alloy lattice to increase the reaction area in a design that is used with large currents. In both cases, the negative electrode uses a paste design.

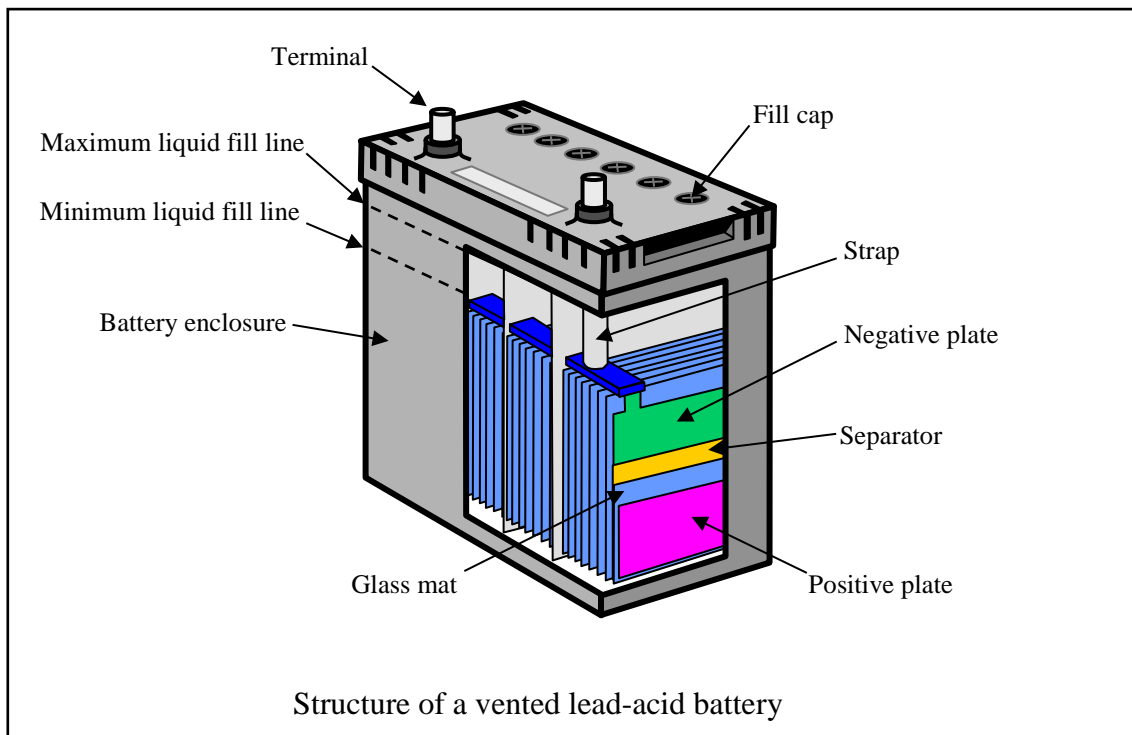

■Types of lead-acid batteries: Valve-regulated type (VRLA)

This type of battery is also known as a sealed battery. It is often used in uninterruptible power supplies (UPSs). Production began in 1970, when the debut of sealed designs, which had been considered impossible, led to a further broadening of the applications in which lead-acid batteries are used.

Lead-acid batteries emit gas when water in the electrolyte breaks down during charging. VRLA batteries incorporate an ingenious mechanism in which this gas is made to react with the battery's negative electrode (cathode) to convert the gas back into water. Since the battery is usually sealed* with a valve, water cannot evaporate, making unnecessary to add water.

Additionally, because the electrolyte is impregnated into a porous glass mat, the electrolyte lacks fluidity, allowing the battery to be placed on its side. However, the design cannot be used upside-down as any electrolyte that oozes out will cause the terminals to corrode. Both the positive and negative electrodes use a paste design.

*In the event a large quantity of gas is produced, the pressure will cause valve to open, releasing the gas.

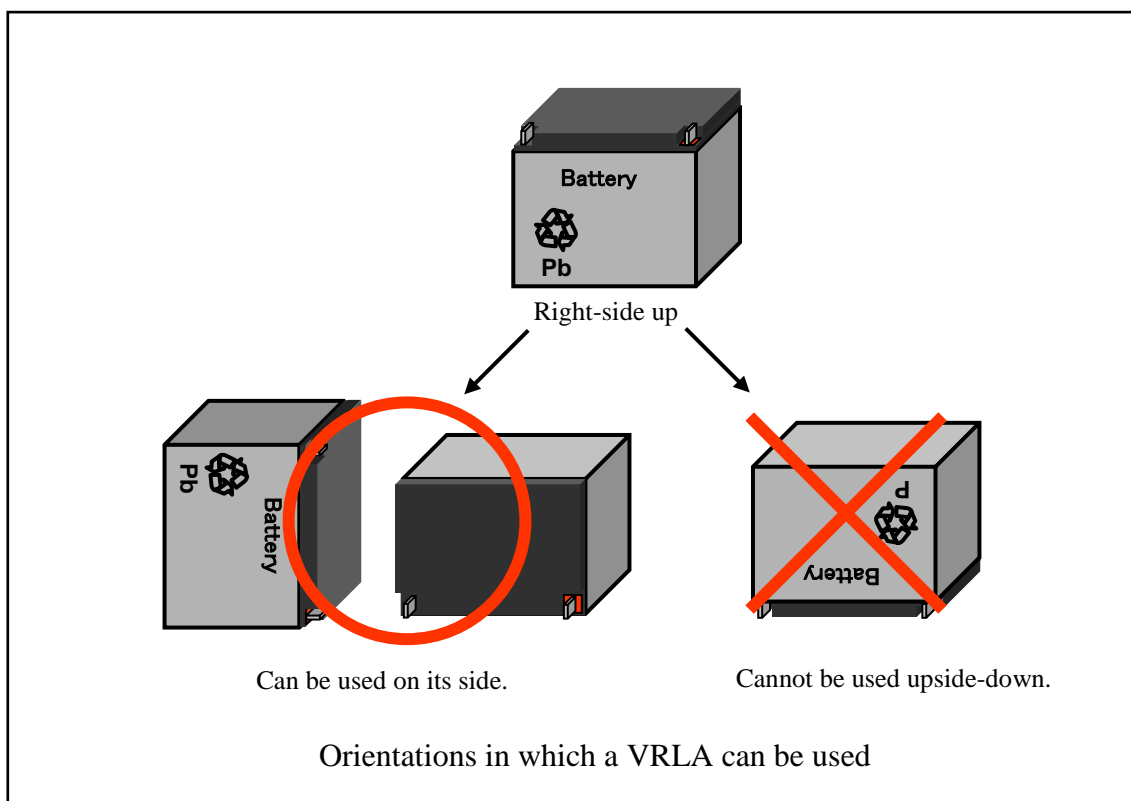

■Lead-acid battery electrodes

Electrodes in lead-acid batteries use one of the following two designs:

■Clad type

The clad design is used for positive electrodes. Because the lead dioxide powder that serves as the positive electrode's active material is characterized by low binding strength, it tends to fall off during charging and discharging, and when the battery is subjected to vibration. Falling off is prevented by injecting lead dioxide powder into a porous tube made of glass fiber or plastic fiber. Current can be extracted from the tube since it has a comb-shaped metal core made of lead alloy. Since the clad design has a smaller electrode surface area than the paste design, it is not well suited to large-current use, but its resistance to falling off gives it superior service life. It is also well suited to use in environments that are characterized by a large amount of vibration, for example in forklifts.

■Paste type

The paste design is used for both positive and negative electrodes. Active material powder that has been kneaded with sulfuric acid is applied to a lead alloy lattice to produce the electrode. Since the design would allow the active material to immediately degrade in the case of the positive electrode, a glass mat is pressure-bonded to the surface of the positive electrode to prevent falling off. The active material in a paste-type electrode has a sponge-like consistency that increases the electrode's surface area and allows it to be used in large-current applications. In control-valve batteries, both the positive and negative electrodes use the paste design.

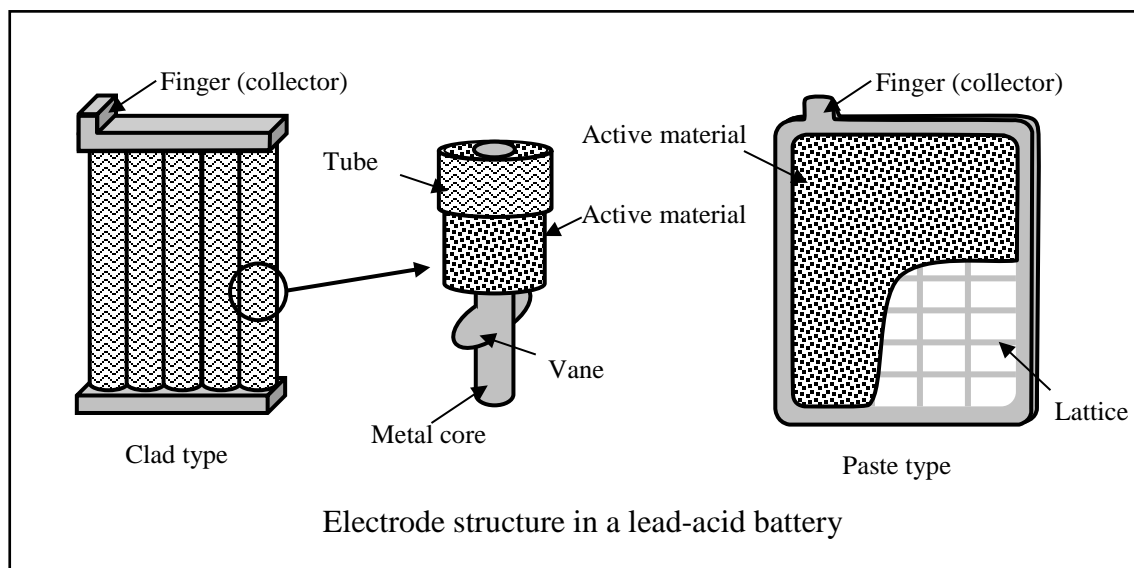

■ Causes of self-discharge in lead-acid batteries

Compared to other battery designs, lead-acid batteries have a comparatively high self-discharge rate of 0.5% to 1% per day. Self-discharge, which increases with battery temperature and electrolyte concentration, is primarily caused by the following three factors:

■ Electrolysis of water

Water in the electrolyte gradually undergoes electrolysis due to the potential difference between the positive and negative electrodes, causing the battery's energy to be consumed and its voltage to drop. While electrolysis of water theoretically occurs at 1.23V, the large overvoltage of the electrodes in lead-acid batteries means that electrolysis does not progress significantly until the battery voltage exceeds about 2.35 V. However, the low overvoltage of the antimony contained in the electrode lattice's lead alloy causes self-discharge to increase as hydrogen forms at the negative electrode.

■ Reaction between electrodes and electrolyte

Because the dilute sulfuric acid in the electrolyte is an acid that reacts readily with metals, it reacts with the electrodes and causes the battery voltage to drop, even if no load is connected to the battery. However, this reaction does not progress rapidly. The overvoltage also affects this process. Since gas is less likely to form in the presence of a large overvoltage, the reaction occurs little by little, causing the battery's voltage to fall gradually.

■ Impurities

Various ions contained in tap water oxidize more readily than the lead in the electrodes, causing them to react with the electrodes. In particular, iron ions (Fe^{2+}) are oxidized by the positive electrode to form trivalent iron (Fe^{3+}), which is then reduced at the negative electrode, converting it back into bivalent iron (Fe^{2+}). Since the reaction forms a cycle, even a small quantity of iron ions can cause self-discharge to increase. Consequently, it is necessary to replenish lead-acid batteries with purified water that lacks impurities.

■ Degradation of lead-acid batteries: Chemical degradation

Although completely opposite reactions occur in theory during charging and discharging of lead-acid batteries, as described in Equation (1), in fact irreversible reactions also occur, causing the battery to degrade gradually.

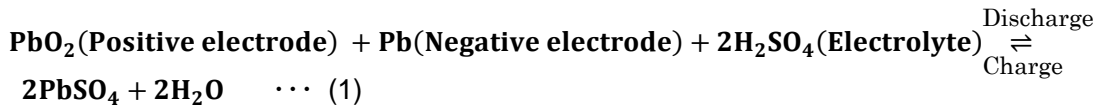

Discharging causes lead at the negative electrode to change into lead sulfate, which develops a stable crystalline structure over time. Since lead sulfate becomes less conductive once it crystallizes, it will not convert back into lead even if the battery is charged. The crystallization of lead sulfate in this manner is generally known as sulfation. When lead sulfate crystals adhere to the surface of the negative electrode, the reaction area between the electrode and electrolyte decreases, causing the battery's internal resistance to rise. Additionally, the electrolyte concentration will decrease since the sulfate ions in the electrolyte are not converted back into lead sulfate. Consequently, the battery voltage will fall, and no amount of charging will restore the initial voltage.

Crystallization of lead sulfate at the surface of the negative electrode is the most common cause in degradation when batteries such as automobile batteries are frequently charged and discharged or allowed to sit without being charged.

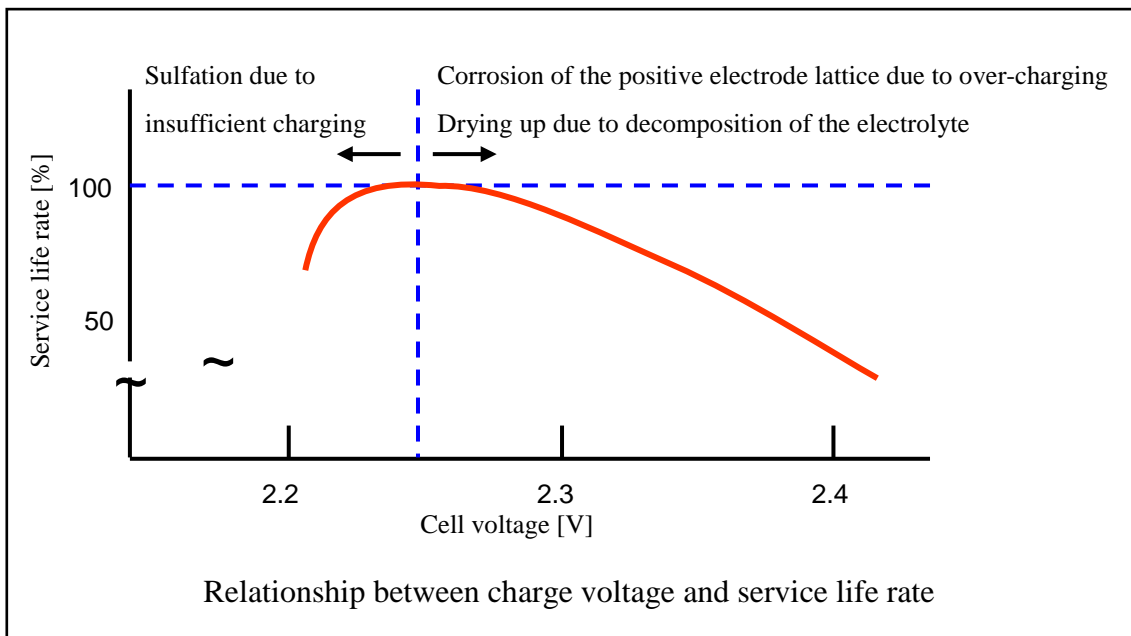

■Degradation of lead-acid batteries: Physical degradation

Lead-acid batteries are subject to degradation due to factors other than irreversible reactions, as described below.

■Corrosion of the positive electrode lattice

In lead-acid batteries, lead alloys that contain ingredients such as antimony and calcium are used to fabricate the lattice that draws current from the active material. Charging of the battery causes the lattice to corrode (oxidize), with the result that it elongates and becomes thinner, degrading its contact with the active material. These changes cause the internal resistance to increase and the amount of power that can be extracted from the battery to decrease. The phenomenon is accelerated when the battery is at high state of charge, and it is further accelerated by high temperatures. Most degradation in batteries that are used in a charged state, for example UPS batteries, is caused by deformation in the shape of the positive electrode lattice.

■Falling off of active material

Lead dioxide, which serves as the positive electrode active material, is packed into a porous tube and held in place by a lattice due to its weak binding strength. However, changes in volume due to charging and discharging cause the material to gradually soften and develop gaps so that it separates from the current-collecting metal core and lattice. The battery's capacity declines since the material will not return to its original state once it has separated in this manner.

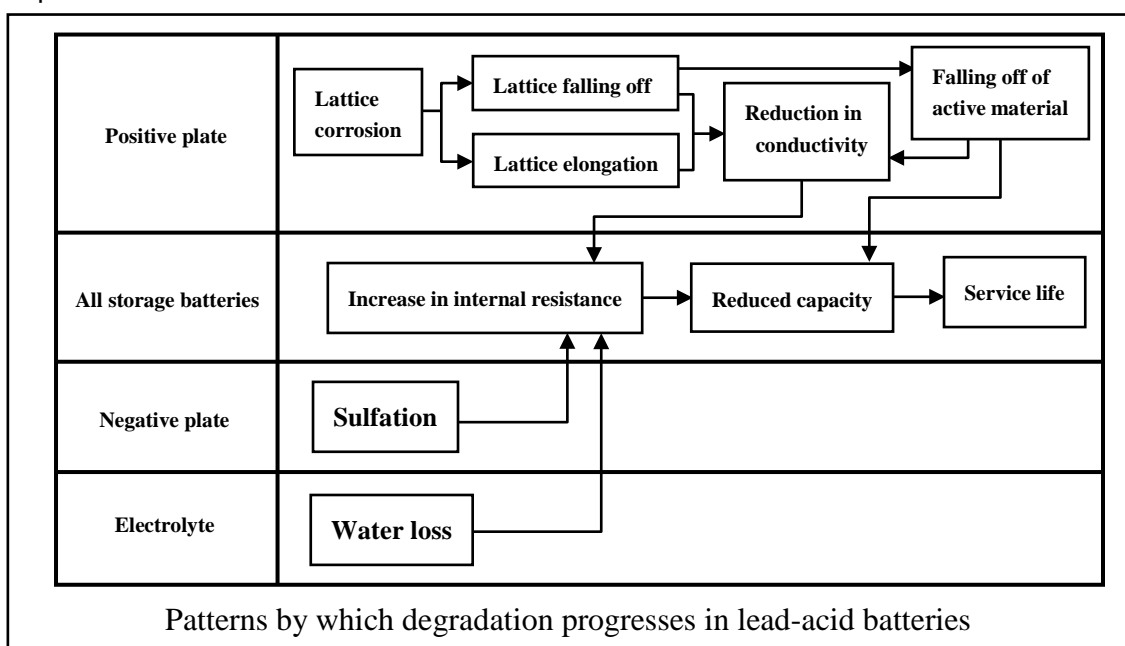

■ Internal resistance of lead-acid batteries

When a load is connected to a lead-acid battery such that current flows to it, the voltage between the battery's terminals falls abruptly. The drop is caused because voltage falls in proportion to the product of current and internal resistance. Consequently, how much power can be extracted momentarily from the battery is determined by the internal resistance. Internal resistance is important in applications that require a large momentary current, for example in batteries used to power automobile starter motors.

By contrast, battery capacity is more important than internal resistance in applications such as emergency power supplies, where the goal is to supply the necessary amount of power for a given period of time. Although internal resistance rises as capacity declines when a lead-acid battery degrades, it is difficult to gage how much the capacity has fallen by looking simply at the internal resistance. This difficulty arises for two reasons. First, a number of different factors are responsible for the increase in internal resistance. Second, the manner in which rising internal resistance and falling capacity are related varies depending on the conditions under which the battery is used. In addition, it's important to keep measurement conditions consistent since internal resistance varies significantly with the battery's state of charge and temperature. Consequently, estimating a battery's state based on its internal resistance requires assessing the relationship between internal resistance and capacity under certain conditions.

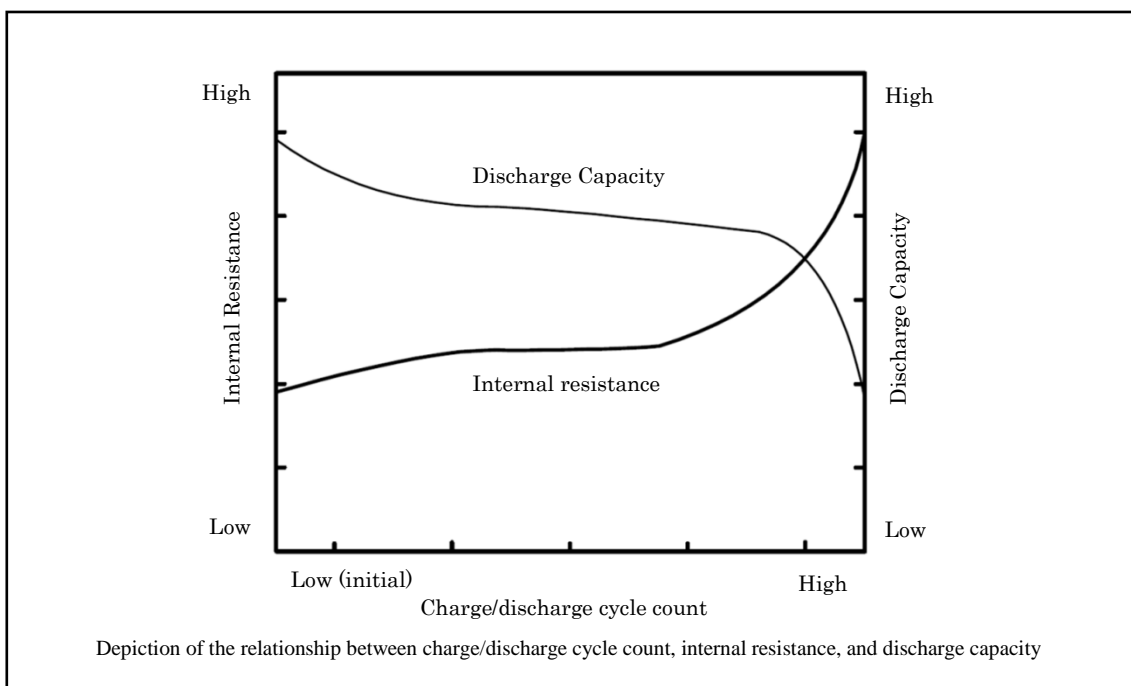

■ Factors that determine internal resistance in lead-acid batteries

Broadly speaking, internal resistance of all batteries--not only lead-acid batteries--can be attributed to the three factors described below. These factors are generally calculated by measuring the impedance spectrum (also known as Cole-Cole plot or Nyquist plot).

■ Ohmic resistance

Ohmic resistance is the resistance of electron conductors such as electrode lattices, terminals, and active material and ion conductors such as electrolyte and separators. Since it includes the contact resistance between the electrode lattice and the active material as well as the contact resistance between active material molecules, this resistance polarization increases when degradation of the lead-acid battery causes corrosion of the positive electrode lattice or falling off of active material.

■ Reaction resistance

Reaction resistance manifests itself in the reaction between the active material and the electrolyte. To reduce activation polarization, it is necessary to reduce the current density per unit of active material, for example by increasing the active material's surface area or using multiple, thinner electrodes. Activation polarization increases when lead-acid batteries degrade due to sulfation on the sponge-like surface of the negative electrode, reducing the contact area between the active material and electrolyte.

■ Diffusion resistance

Diffusion resistance is caused by too many or too few ions relative to the requirements of the battery's reaction. Ions are transported to the surface of the electrodes via diffusion, but if the battery reaction progresses faster than diffusion can supply ions, there will be a shortage of ions near the electrodes, impeding the reaction. Concentration polarization occurs in lead-acid batteries when the electrolyte concentration declines due to discharging or degradation.

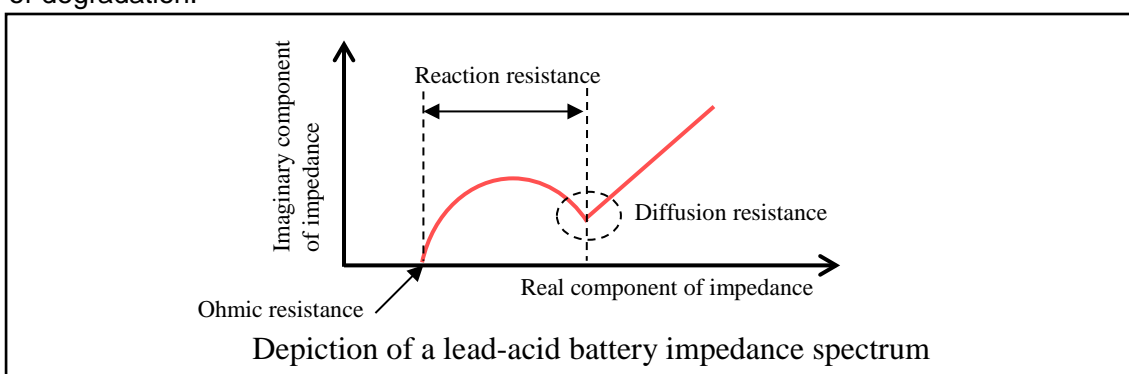

■ Measuring the internal resistance of lead-acid batteries (JIS C 8704-1)

JIS C 8704-1 Stationary lead-acid batteries: General requirements and methods of test, Part 1: Vent type

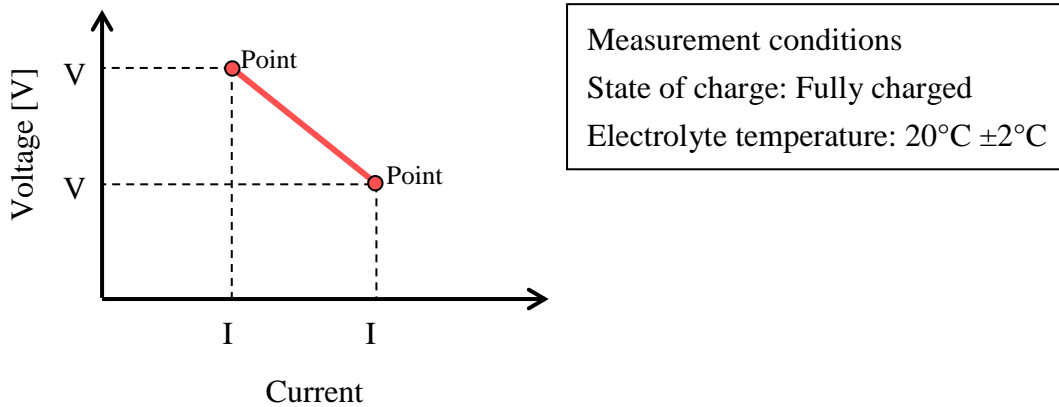

Measurement procedure

(1) Measure point 1 (V_1, I_1)

Current I_1 : 4x to 6x the 10-hour discharge rate

Voltage V_1 : Voltage 20 s after discharged at current I_1 (with discharging to stop within 25 s)

(2) Measure point 2 (V_2, I_2) after letting battery sit 2 to 5 min. without auxiliary charging after point 1 measurement is complete.

Current I_2 : 20x to 40x the 10-hour discharge rate

Voltage V_2 : Voltage 5 s after discharged at current I_2

(3) Calculate the internal resistance from the values obtained at points 1 and 2 using the following equation:

$$\text{Internal resistance } R = \frac{(V_1 - V_2)}{(I_1 - I_2)} \text{ } [\Omega]$$

*This test method yields an internal resistance value under static test conditions, but it does not indicate dynamic reactions such as those occurring during the first several milliseconds of a short-circuit.

In addition, the JIS standard notes that the precision of the results of this test is about ±10%.

■Starting performance of lead-acid batteries: Cold-cranking amps (CCA)

The most important function of automotive batteries is to start the engine. Since the performance of lead-acid batteries declines at low temperatures, the amount of current that can be extracted from them falls under such conditions. However, the automotive engine needs to start no matter how cold it is. Consequently, cold-cranking amps (CCA), defined as the discharge current value when the battery is discharged so as to yield a battery voltage of 7.2 V at -18°C (0°F), is used as an indicator of automotive battery performance.

An automotive battery's CCA value decreases as it degrades, until the engine can no longer start. The extent to which the CCA figure has declined compared to the original value provides a rough guide as to when the battery needs to be replaced. It's a simple matter to ascertain the CCA value for a battery prior to degradation since the JIS defines a rated CCA for each battery type. However, measuring CCA requires cooling the target battery to a temperature of -18°C and using an extremely large-scale test device capable of discharging the battery at a current of hundreds of amperes. Consequently, the battery testers used at mechanic shops and gas stations measure the battery's internal resistance as a substitute for measuring an accurate CCA value. This method is possible because a battery's internal resistance increases as it degrades, causing the CCA value to fall. Some battery testers use a proprietary method to convert the battery's internal resistance to a figure that approximates CCA, but such methods are not defined by JIS.

Class	Type	CCA value	Class	Type	CCA Value	Class	Type	CCA value
A	26B17L	185	A or B	55D23L	320	B	115E41L	610
	28B17L	195		65D23L	370		130E41L	680
	34B17L	240		75D23L	465		115F51	575
	34B19L	240		75D26L	450		145F51	735
	38B19L	265		80D26L	490		145G51	685
	38B20L	265		95D31L	565		165G51	710
	44B20L	300		105D31L	655		195G51	930
	46B24L	295					190H52	765
	55B24L	370					210H52	910
	50D20L	310					245H52	1170

JIS D 5301 Lead-acid starter batteries: Excerpt from Table 1

■ Measuring the internal resistance of lead-acid batteries: Impedance method

In the standard approach, a material's electrical resistance can be calculated using Ohm's law from the voltage that results when a current is applied to it. However, that method cannot be used to measure the internal resistance of batteries because charge and discharge reactions would consume any applied DC current, with the result that there would be no resistance-caused variations in the voltage. However, if the current is varied quickly enough that the charge and discharge reactions cannot keep pace, the voltage changes will be caused by the battery's internal resistance.

In the impedance method, an AC current is applied to the battery, and the internal resistance is calculated from the resulting voltage change and the phase shift between the current and voltage. Since AC current switches between current in the charge and discharge direction for the battery, internal resistance figures obtained using the impedance method include both the charging and discharging resistance. In addition, the impedance method allows internal resistance to be measured while the battery is connected to a host device since DC current is eliminated.

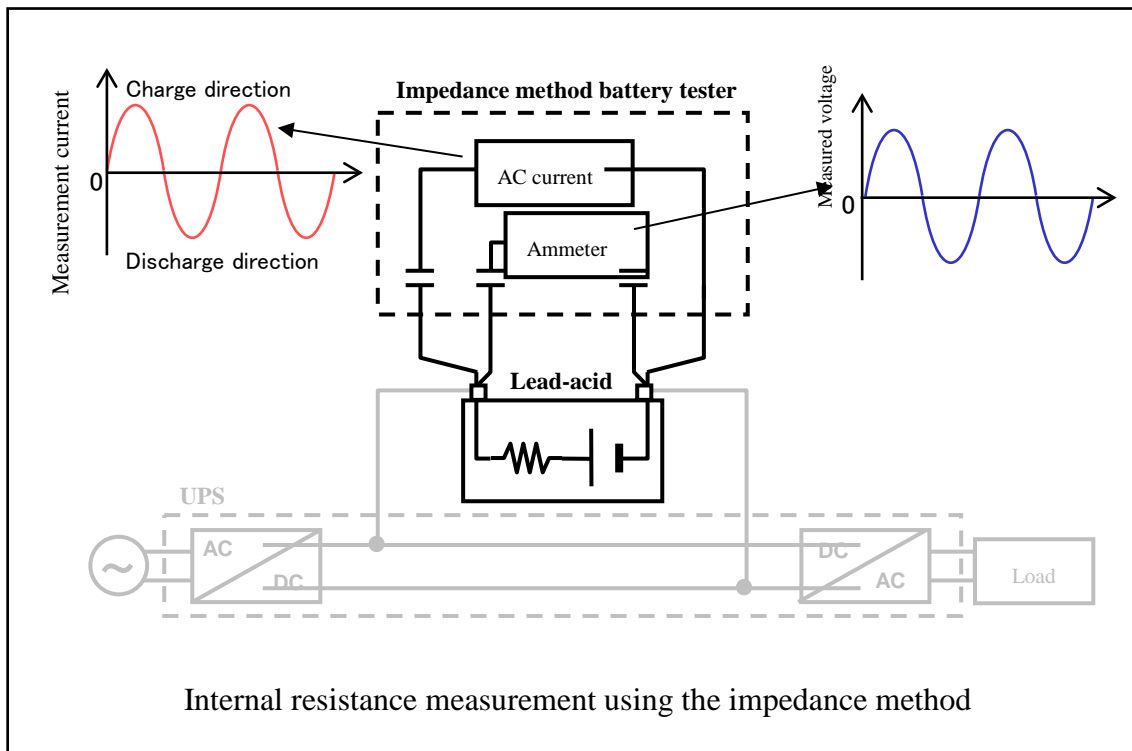

■ Measuring the internal resistance of lead-acid batteries:
Conductance method

The reciprocal of resistance is known as conductance, which indicates how readily a current will flow.

In the conductance method, the discharge current is controlled and then conductance is calculated from the resulting change in voltage. Whereas a measurement current is applied in both the charge and discharge directions in the impedance method, the conductance method is distinguished by allowing measurement with large currents on the order of several amperes since only the discharge current is controlled. In addition, although it requires a large power supply capable of applying a current of several amperes in the charge direction, the conductance method has the advantage of allowing more compact measurement devices since the measurement current is controlled by varying the measurement device's internal load resistance. However, a heat dissipation method is necessary since the discharge current is converted entirely to heat.

If a power supply is connected to the battery as during float charging, the current from the power supply will be superposed during measurement, preventing accurate measurement of conductance. Consequently, it is necessary to disconnect the battery from the power supply during measurement.

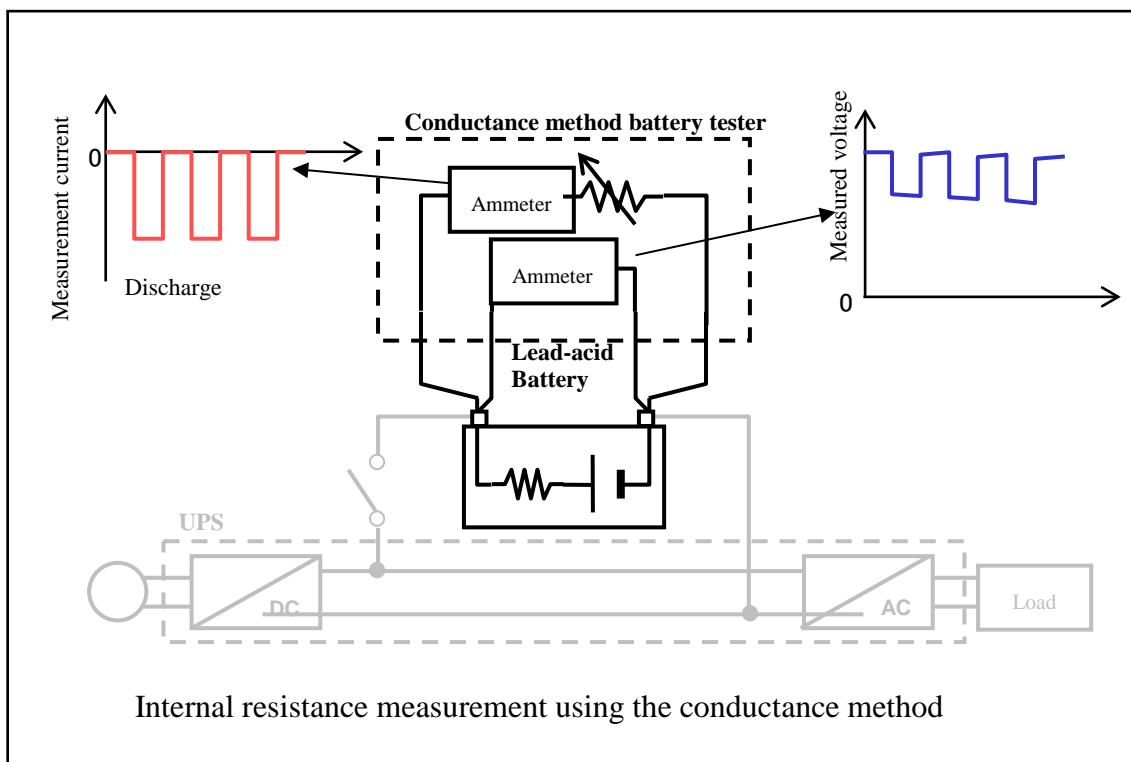

■Charging lead-acid batteries: Trickle charging

Lead-acid batteries exhibit self-discharge at a rate of about 0.5% to 1% per day, although the exact amount depends on the temperature. Consequently, if left untended, they will be unusable when needed. In addition, since degradation progresses when left in a discharged state, keeping batteries in a fully charged state serves to extend their service life.

Trickle charging refers to the process of continually charging a battery with a small current to compensate for self-discharge. If the charge current is too large, the battery will be over-charged, causing the electrolyte to break down. As a result, it is necessary to use a current that suits the size of the battery being used. Additionally, the charge current is small, so it may take a long time to charge the battery if it has been completely discharged.

In the case of UPSs (uninterruptible power supplies) that use trickle charging, the battery is disconnected from the load when the main power supply is available so that the battery only supplies power when the system activates during a power outage. This design results in a momentary loss of power when switching over to the battery, but it has the following advantages: no stress to the battery during normal operation, and reduction losses at the rectifiers and inverters..

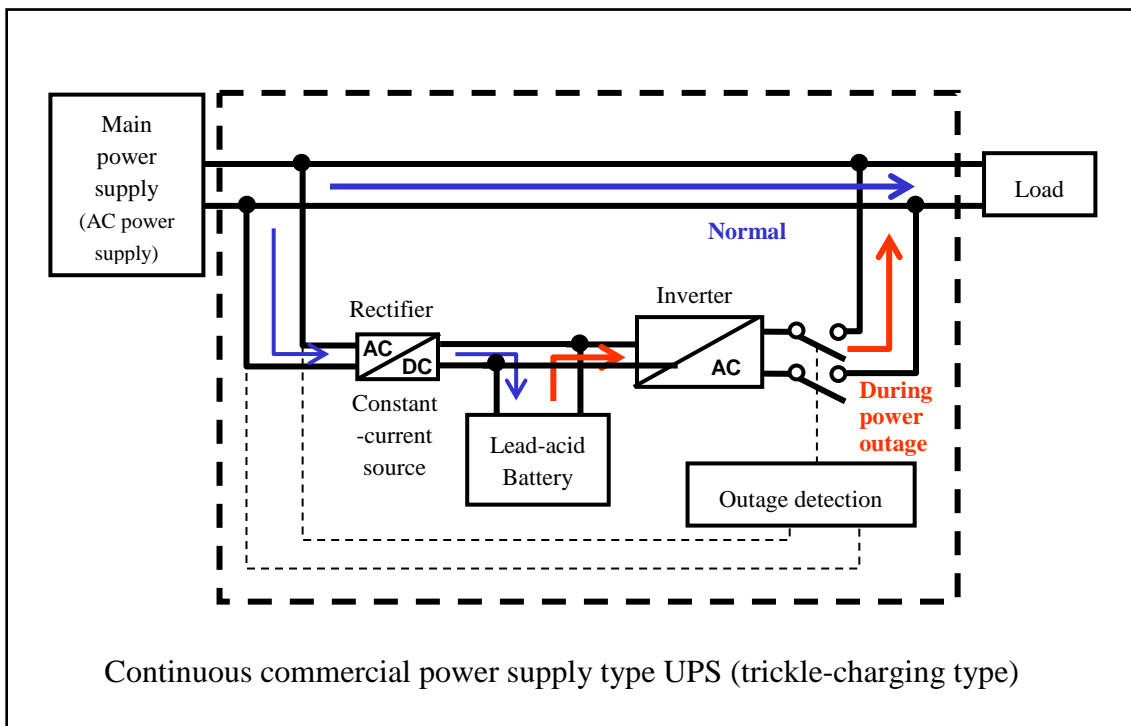

■Charging lead-acid batteries: Float charging

In float charging, a constant voltage is continuously applied to the lead-acid battery. Only the current necessary to maintain the voltage is supplied, compensating for self-discharge. This method has the advantage of supplying an appropriate charge current regardless of the size of the battery, making it less likely that the battery will be over-charged.

Since the battery in a UPS that uses float charging is connected in parallel between the rectifier and inverter, power can be supplied without any interruption in the event of an outage. Such systems also have the advantage of being able to deliver a stable supply of power even if the main power supply's voltage fluctuates or if the load's required power suddenly increases since the battery serves as a buffer.

Although continuous operation of the rectifier and inverter results in a large amount of conversion loss, such systems are widely used in applications that demand high reliability, for example data servers and medical devices. Additionally, since automobile alternators provide a constant-voltage source, batteries undergo float charging while the engine is running. (This does not apply to vehicles that use charge control.)

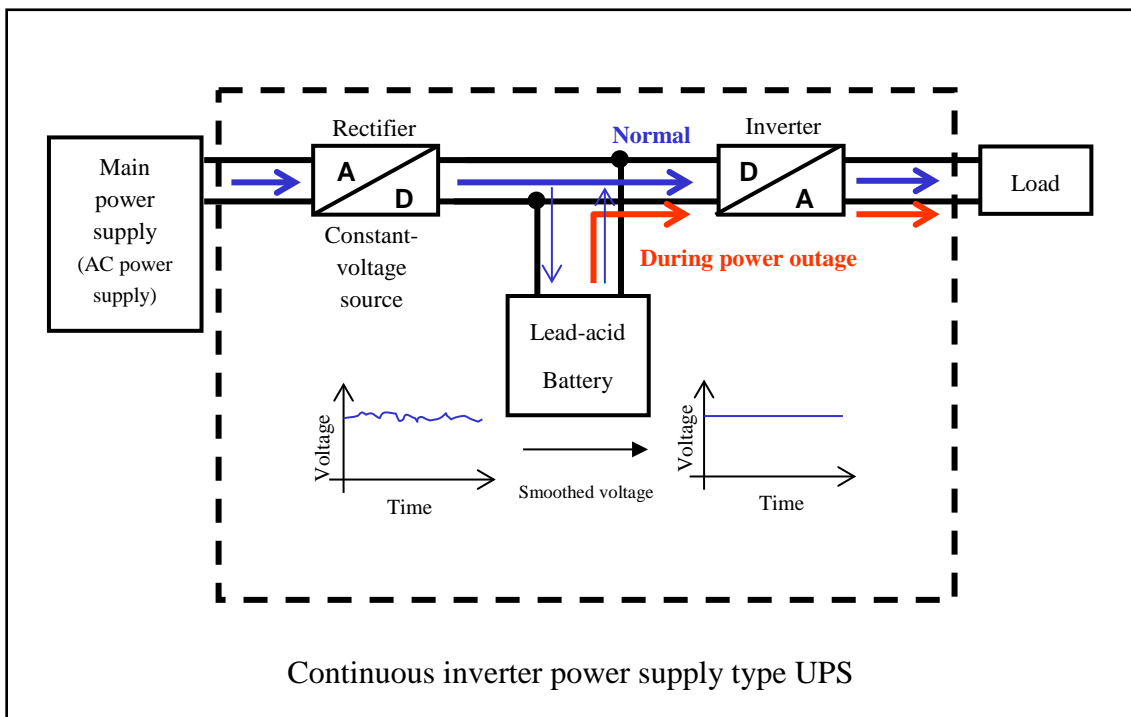

■JIS standards related to lead-acid batteries (as of 2013)

Standard no.	Standard name	Most recent revision
JISC8701	Lead acid batteries for general service	1975
JISC8702-1	Small-sized valve-regulated lead-acid batteries Part 1: General requirements, functional characteristics-Methods of test	2009
JISC8702-2	Small-sized valve-regulated lead-acid batteries Part 2: Dimensions, terminals, and marking	2009
JISC8702-3	Small-sized valve-regulated lead-acid batteries Part 3: Safety recommendations for use in electric appliances	2009
JISC8704-1	Stationary lead-acid batteries General requirements and methods of test-Part 1: Vented types	2006
JISC8704-2-1	Stationary lead-acid batteries Part 2-1: Valve regulated type-Methods of test	2006 (enacted)
JISC8704-2-2	Stationary lead-acid batteries Part 2-2: Valve regulated type-Requirements	2006 (enacted)
JISC8971	Measuring procedure of residual capacity for lead acid battery in photovoltaic system	1993 (enacted)
JISC8972	Testing procedure of long discharge rate of lead-acid batteries for photovoltaic systems	1997 (enacted)
JISD5301	Lead-acid starter batteries	2006
JISD5302	Lead-acid batteries for motorcycles	2004
JISD5303-1	Lead-acid traction batteries Part 1: General requirements and methods of test	2004
JISD5303-2	Lead-acid traction batteries Part 2: Types and labeling	2004
JISF8101	Lead-acid marine batteries	2003

■Lead-acid battery classifications

Lead-acid battery types are classified based on intended applications of use and on the positive electrode's design.

Application		Classification	Remarks
Automotive use	Automobiles	A to H	Categorized based on width and height of enclosure
	Motorcycles	N	Vent type (normal)
		BX	Vent type (high-performance)
		BT	Valve-regulated type
Industrial use	Stationary	CS	Vent type, clad-type positive electrode
		PS	Vent type, paste-type positive electrode
		HS	Vent type, paste-type positive electrode, high charge/discharge
		-E	Vent type, with catalyst plug
		HSE	Valve-regulated type, high charge/discharge
		MSE	Valve-regulated type, high charge/discharge, long service life
	Electric vehicles	Vx	x: B to H depending on height of enclosure
	Marine	SS	Marine use
		PS	Vented, paste-type positive electrode
		HSE	Valve-regulated type, high charge/discharge
		MSE	Valve-regulated type, high charge/discharge, long service life
	Portable	PS	Vent type, paste-type positive electrode

■HIOKI Profile

About HIOKI

HIOKI E.E. CORPORATION is a manufacturer of electrical measuring instruments that was founded in 1935. Products in four categories--data recording equipment, electronic measuring instruments, field measuring instruments, and automatic test equipment--feature proprietary technologies. Our Head Office in Ueda, Nagano Prefecture, brings together R&D, manufacturing, maintenance, and service departments, allowing us to offer high-quality instruments and fine-grained service.

Product calibration and repair

If you encounter an issue or malfunction with a HIOKI product, please submit a repair request through your distributor. Even when products are discontinued, we continue to offer repair service for a minimum of five years from the date of discontinuation. If a malfunction for which HIOKI is responsible occurs while the product is covered by its warranty, which begins on the date of purchase, we will repair or replace it free of charge.

Calibration and adjustment service

We recommend that instruments be calibrated regularly, about once a year, to ensure that customers can use them with peace of mind. When you have us calibrate your instrument (through our general calibration service), our experts will perform the calibration in accordance with ISO 9001 and issue you a report of results. If there is an error between the reference standard's ideal value and the value indicated by your instrument, we can also adjust the instrument to correct that divergence. HIOKI recommends that calibration and adjustment be performed together. In addition to general calibration, we offer JCSS calibration service in accordance with ISO/IEC 17025 for some instruments. Calibration certificates issued at the time of JCSS calibration are international MRA-compliant, so they are valid outside Japan, too.

List of sales offices

Branch offices in Japan

Tohoku Sales Branch, Nagano Sales Branch, Kanazawa Office, Greater Tokyo Sales Branch, Yokohama Sales Branch, Atsugi Office, Shizuoka Sales Branch, Nagoya Sales Branch, Osaka Sales Branch, Hiroshima Office, Fukuoka Sales Branch

Overseas sales subsidiaries

U.S., China, Singapore, South Korea, India, Germany, Taiwan