

# HIOKI

## 3665-20

Instruction Manual

## LAN CABLE HiTESTER



EN

Dec. 2018 Revised edition 4  
3665A981-04 18-12H





# Contents

Introduction .....	1
Verifying Package Contents.....	1
Safety Information.....	2
Operating Precautions .....	3
<b>Chapter 1 Overview</b> .....	<b>7</b>
1.1 Product Overview .....	7
1.2 Features .....	9
1.3 Names and Functions of Parts .....	10
<b>Chapter 2 Testing Preparations</b> .....	<b>13</b>
2.1 Installing the Batteries .....	13
2.2 Turning the Power On and Off .....	15
2.3 Auto Power-Off Function .....	16
<b>Chapter 3 Cable Testing Procedures</b> .....	<b>17</b>
3.1 Basic Procedure .....	17
3.2 Testing Wiremap .....	19
3.2.1 Display Examples.....	20
3.2.2 Help Function .....	26
3.3 Checking Cable Length .....	27
3.4 Locating Open or Shorted Wires .....	28
3.5 Cable Identification Check.....	29

**Chapter 4 Setting Procedure 31**

---

- 4.1 Setting an NVP Value ..... 31
  - 4.1.1 Settings for Standard Cable..... 32
  - 4.1.2 Changing the NVP Value..... 35
- 4.2 Changing Displayed Measurement Units.. 36
- 4.3 Switching the Beeper On and Off..... 37
- 4.4 Initializing Settings ..... 38

**Chapter 5 Specifications 39**

---

- 5.1 Model 3665-20 LAN CABLE HiTESTER... 39
  - 5.1.1 Basic Specifications ..... 39
  - 5.1.2 General Specifications ..... 41
  - 5.1.3 Functions Specifications ..... 42
- 5.2 Model 9690 TERMINATOR..... 43

**Chapter 6 Optional Accessories 45**

---

**Chapter 7 Maintenance and Service 47**

---

- 7.1 Cleaning ..... 47
- 7.2 Troubleshooting ..... 47
- 7.3 Error Display ..... 50
- 7.4 Replacing the Batteries ..... 51

## Introduction

Thank you for purchasing the HIOKI “Model 3665-20 LAN CABLE HiTESTER.” To obtain maximum performance from the instrument, please read this manual first, and keep it handy for future reference.

The Model 9690, 9690-01, 9690-02, 9690-03 will be referred to as the “Model 9690” in this manual

## Verifying Package Contents

- When you receive the instrument, inspect it carefully to ensure that no damage occurred during shipping. In particular, check the accessories, panel keys, and connectors. If damage is evident, or if it fails to operate according to the specifications, contact your dealer or Hioki representative.
- Use the original packing materials when transporting the instrument, if possible.

## Package Contents

- Model 3665-20 LAN CABLE HiTESTER ..... 1



### Accessories

- Model 9690 TERMINATOR (ID number 0)..... 1
- LR6 alkaline batteries ... 2
- Carrying case ..... 1
- Instruction manual ..... 1

## Safety Information

This instrument is designed to conform to IEC 61010 Safety Standards and has been thoroughly tested for safety prior to shipment. However, using the instrument in a way not described in this manual may negate the provided safety features.

Before using the instrument, be certain to carefully read the following safety notes:



Mishandling during use could result in injury or death, as well as damage to the instrument. Be certain that you understand the instructions and precautions in the manual before use.

## Notation

In this document, the risk seriousness and the hazard levels are classified as follows.



Indicates a potentially hazardous situation that may result in death or serious injury to the operator.



Indicates a potentially hazardous situation that may result in minor or moderate injury to the operator or damage to the instrument or malfunction.



Indicates advisory items related to performance or correct operation of the instrument.



Indicates prohibited actions.

( P. )

Indicates the location of reference information.

\*

Indicates that descriptive information is provided below.

## Symbols affixed to the instrument



In the manual, the  symbol indicates particularly important information that the user should read before using the instrument.



Indicates DC (Direct Current).

## Operating Precautions



Follow these precautions to ensure safe operation and to obtain the full benefits of the various functions.

### Preliminary Checks

Before using the instrument the first time, verify that it operates normally to ensure that no damage occurred during storage or shipping. If you find any damage, contact your dealer or Hioki representative.

## Instrument Operating Environment



Installing the instrument in inappropriate locations may cause a malfunction of the instrument or may give rise to an accident. Avoid the following locations:

- Exposed to direct sunlight or high temperature
- Exposed to corrosive or combustible gases
- Exposed to a strong electromagnetic field or electrostatic charge
- Near induction heating systems (such as high-frequency induction heating systems and IH cooking equipment)
- Susceptible to vibration
- Exposed to water, oil, chemicals, or solvents
- Exposed to high humidity or condensation
- Exposed to high quantities of dust particles



## Handling the Instrument

### **CAUTION**

- To avoid damage to the instrument, protect it from physical shock when transporting and handling. Be especially careful to avoid physical shock from dropping.
- To avoid damage to the instrument, do not remove the instrument's case.
- To avoid damage to the instrument due to an application of overvoltage, do not connect to live wires such as telephone lines.

### **NOTE**

- To avoid corrosion from battery leakage and problems with battery operation, remove the batteries from the instrument if it is to be stored for a long time.
- The  indicator flashes when battery voltage becomes low. Replace the batteries as soon as possible.
- After use, always turn OFF the power.



# Overview

# Chapter 1

## 1.1 Product Overview

The Hioki 3665-20 LAN CABLE HiTESTER is a hand-held cable tester that provides easy operations to test wiremap, measure cable length and identify twisted-pair cables. It is useful for verifying connections after installing connectors on cables. Optional terminators are available to facilitate easy identification of multiple cables. The HiTester is especially convenient for testing cables in working networks in the event of faults caused by open- or short-circuited cable wiring.

### Major Features



Testing wiremap

Measuring cable length

Identifying cable connections



### Testing cable connections after installing connectors

Checking wiremaps (p.19).



### Troubleshoot cables in working networks

When an open- or short-circuit fault is present in a cable, the HiTester displays the distance along the cable from it to the fault.

So when a problem occurs in a working network, the HiTester determines whether the problem is caused by an open- or short-circuit in the cable, and its location (p.28).

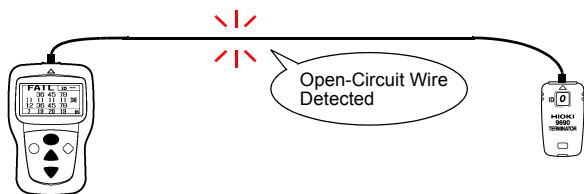

### Identifying cables installed together

When multiple cables are installed together, distinguishing which cable is connected to what device can be difficult. However, the HiTester can easily identify multiple cables by using optional terminators. Up to 21 cables can be identified using multiple terminators (p.29).

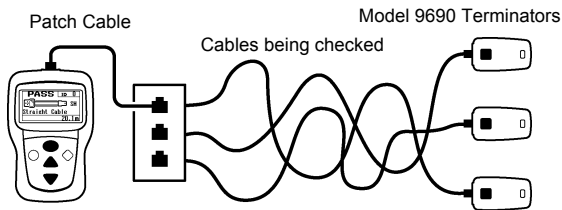

The figure shows an example of detecting cables through wall jacks.

## 1.2 Features

### ◆ **Simple Operation**

Test cable wiremap, measure length and identify connections with a simple procedure: just connect the ends to the HiTester and a terminator, and press the  key.

### ◆ **Compact Size**

The compact HiTester can be carried as a hand tool and operated with one hand.

### ◆ **Easy-to-See Display**

Test results are displayed in large characters and graphic symbols.

### ◆ **Cable Length Measurement Calibration Function**

For the most precise cable length measurements, set the NVP value to calibrate the HiTester (p.31).

## 1.3 Names and Functions of Parts

### Top panel

Cable connection terminal (RJ-45)



### Front panel

(Magnified view)

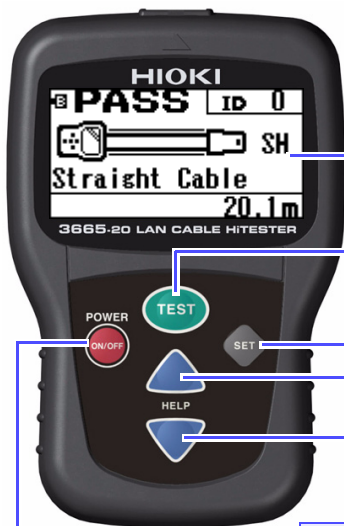

Display (LCD)

**TEST Key**  
Start cable testing

(Hold for one second)

**SET Key**  
Displays the Settings screen

(Hold for one second)

**POWER ON/OFF Key**  
Turns the HiTester on and off.

**HELP ▲/▼ Key**  
Switches between the Test Results and the Help screens. Also, on the Settings screen, selects items and increments and decrements numerical values.

## Display

### Display Example of Correct Wiring

Battery indicator (normally off)

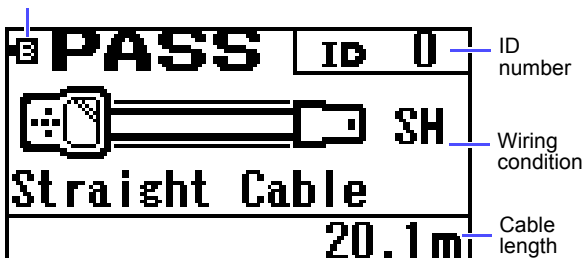

### Display Example of Faulty Wiring

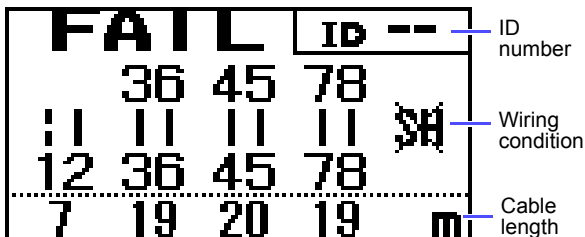

To view wiremap details, or when you want to know the meaning of display items, press the HELP ▲/▼ key to display the Help screen. (p.26)

## Rear panel



## Serial number label

The serial number consists of 9 digits. The first two (from the left) indicate the year of manufacture, and the next two indicate the month of manufacture. Required for production control. Do not peel off the label.

## Battery compartment cover

## Strap mounting hole

## Model 9690 TERMINATOR

## Front panel



## ID number

## Strap mounting hole

## Top panel



## Cable connection terminal (RJ-45 connector)



# Testing Preparations

## Chapter 2

### 2.1 Installing the Batteries

Before using the HiTester, install two AA-size (LR6) alkaline batteries. Also, before each test, verify that the batteries have sufficient remaining capacity, and replace them if they are weak.

#### **⚠ WARNING**

- Do not mix old and new batteries, or different types of batteries. Also, be careful to observe battery polarity during installation. Otherwise, poor performance or damage from battery leakage could result.
- To avoid the possibility of explosion, do not short circuit, disassemble or incinerate batteries.
- Handle and dispose of batteries in accordance with local regulations.

#### **NOTE**

- The **B** indicator flashes when battery voltage becomes low. Replace the new batteries soon.

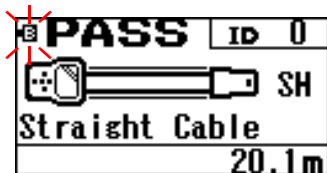

- Do not attempt to use any power source other than the specified AA-size (LR6) alkaline batteries. Operating time with non-alkaline (manganese) batteries is shorter.

1. Remove the test cable, if connected.
2. Turn the HiTester off.
3. Remove the battery compartment cover from the rear of the HiTester.
4. Install the new batteries, with attention to proper polarity.
5. Replace the battery compartment cover.

Rear Panel

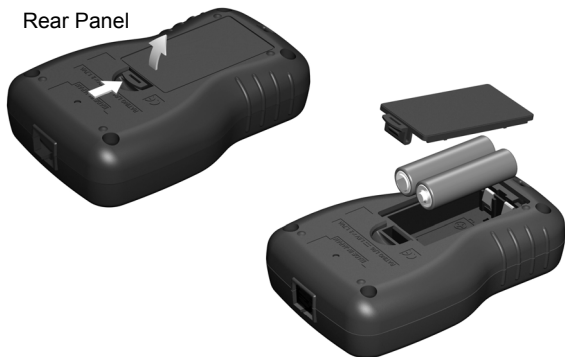
**CAUTION**

To avoid damaging the battery compartment cover, do not attempt to open it by inserting a screwdriver into the latch hole.



## 2.2 Turning the Power On and Off

Press and hold the POWER  key for about one second to turn the power on and off.

### Power On

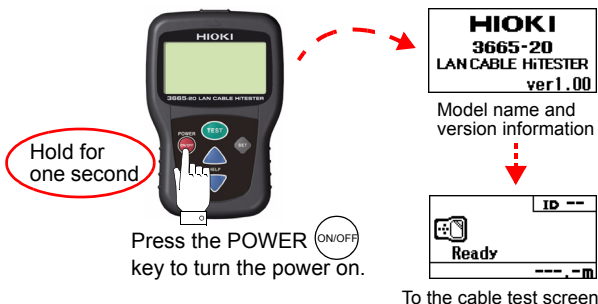

Hold for one second

Press the POWER  key to turn the power on.

**HIOKI**  
**3665-20**  
**LAN CABLE HiTESTER**  
**ver1.00**

Model name and version information

**Ready**

To the cable test screen

**NOTE** The  indicator flashes when battery voltage becomes low. Replace the new batteries soon.

### Power Off

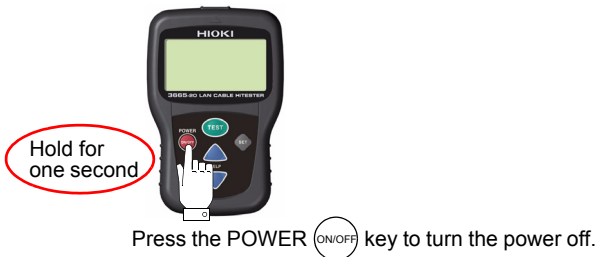

Hold for one second

Press the POWER  key to turn the power off.

## 2.3 Auto Power-Off Function

The HiTester includes an auto power-off function to prevent battery depletion in case you forget to turn it off. It turns off automatically if no key is pressed for about ten minutes.

**NOTE** The auto power-off function cannot be disabled.

# Cable Testing Procedures

## Chapter 3

### 3.1 Basic Procedure

#### **CAUTION**

- To avoid equipment damage, do not attempt to test a cable connected to an operating network. The RJ-45 cable test jacks on the HiTester and terminators are intended for testing only stand-alone cables.
- Do not connect any cable other than the twisted pair cable. For example, a voltage of approximately 48 V is applied to a live telephone wire, and therefore will damage the HiTester if it is connected to the wire.
- Remove a cable to be checked from any device or a network hub before connecting the cable to the instrument. Inserting the cable left connected with a device or hub into the instrument can cause damage to the instrument and device.

#### **NOTE**

The characteristics of twisted-pair cables can vary depending on installation conditions. Avoid unnecessary bending of cables to be tested. When necessary to bend a cable, the radius of curvature should be at least four times the outer diameter of the cable.

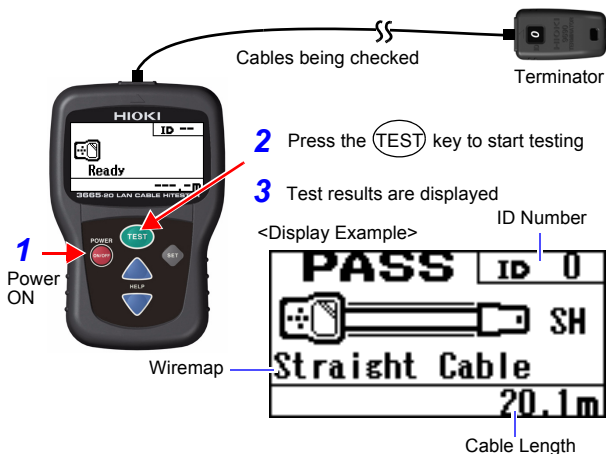

Remove a cable to be checked from any device or a network hub before connecting the cable to the instrument.

## 3.2 Testing Wiremap

For normal wiring, "PASS" is displayed at the top left, and for incorrect wiring, "FAIL" is displayed (blinking).

(Normal Wiring)

Example: Cross-over cable

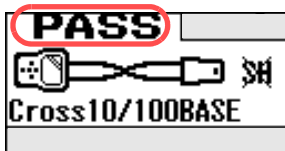

(Incorrect Wiring)

Example: Reversed wires

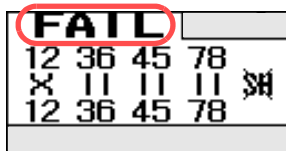

Meaning of displayed wiring status (wiremap) symbols

Display Examples	Meaning	Display Examples	Meaning
12 11 12	Normal wiring	12 X 12	Reversed wiring
45 36 11 11 36 45	Transposed wiring	X X 36 45	Split pairs
11 12	Open wiring	11 12	Short wiring
?? 11 12	Other incorrect wiring	SH / SH	Shielded/ Unshielded*

\* Indicates whether the cable connectors are connected by a shielding conductor.

If an error for incorrect wiring is displayed even when measuring a normal cable, refer to "Section 7.2 Troubleshooting" (p.47)

### 3.2.1 Display Examples

These display examples show how to read wiring status.

#### Straight-Through Cable

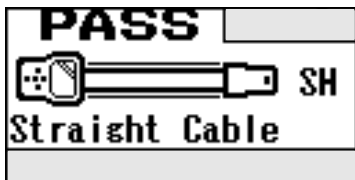

Straight-Through Cable  
Cable shield detected

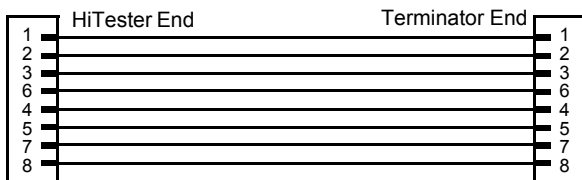

Cable Wiring Diagram

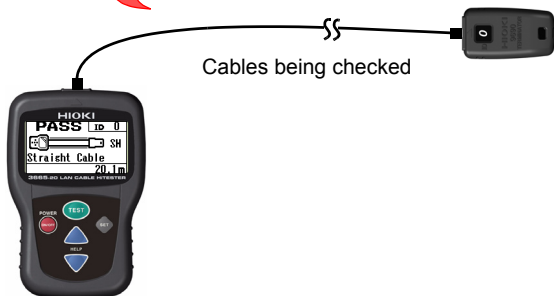

Cables being checked

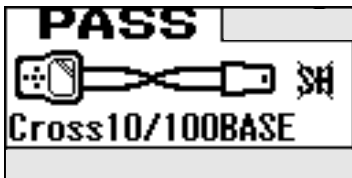

**Cross-Over Cable (10/100BASE)**

Cross-Over Cable  
Detected as 10/100  
BASE, unshielded

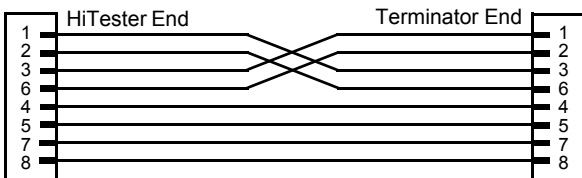
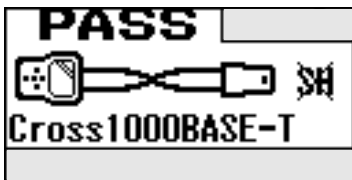
**Cross-Over Cable (1000BASE-T)**

Cross-Over Cable  
Detected as 1000BASE-  
T, unshielded

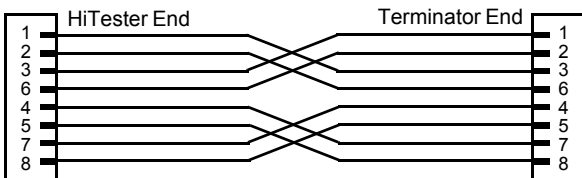

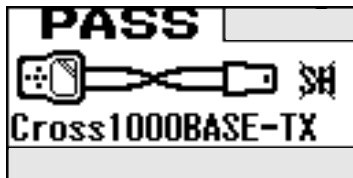
**Cross-Over Cable (1000BASE-TX)**

Cross-Over Cable  
Detected as 1000BASE-  
TX, unshielded

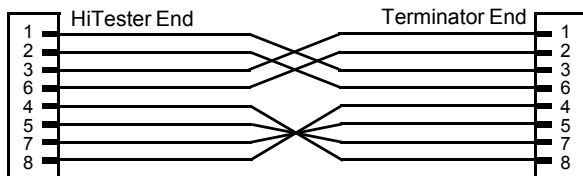

**NOTE** Cross-over connections are judged according to wiring standards.

## Reversed Wiring

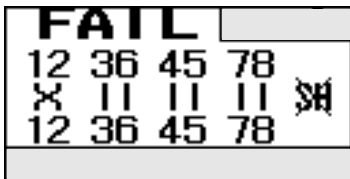

Reversed wiring of pins 1 and 2 is detected.

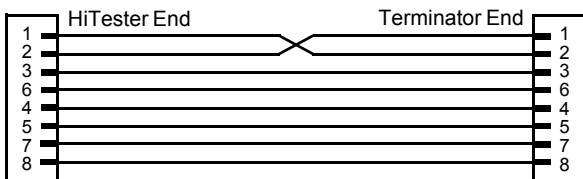

## Transposed Wiring

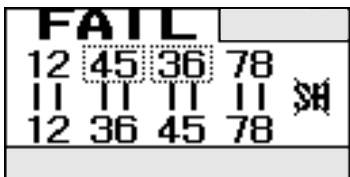

Transposed wiring is detected as pins 3 and 6 being transposed with pins 4 and 5.

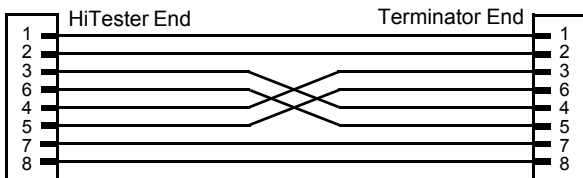

## Open Wiring

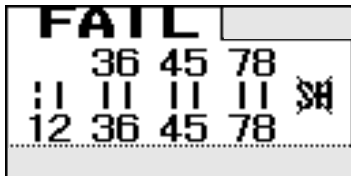

Pin 1 is detected to be open-circuit.  
See "Section 3.4 Locating Open or Shorted Wires" (p.28)

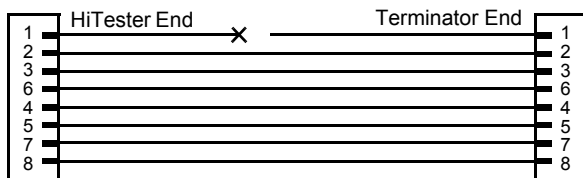

## Short Wiring

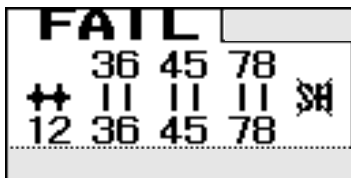

Pins 1 and 2 are detected to be short-circuited.

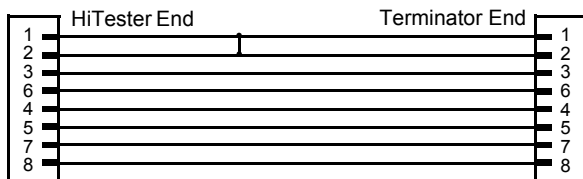

### Split Pairs

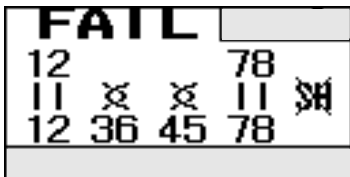

A wiring error is detected with twisted-pair pins 3 and 6, and pins 4 and 5.

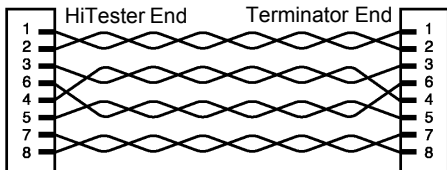

**NOTE** In short cables, split pairs may not be detected.

### Terminator Disconnect

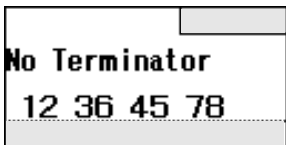

Check that the Terminator is connected correctly.

### Terminator Error

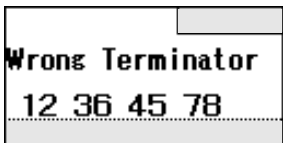

Errors are detected on all pins. The cable may be insecurely connected, or a device other than a terminator may be connected.

Cables in which all pin pairs are different at each end cannot be tested.

### 3.2.2 Help Function

Press the HELP ▲/▼ key when the Test Results screen is displayed to see details of the wiremap and meaning of the screen symbols.

**NOTE** Cable testing is not possible from the Help screen. Return to the Test Results screen before testing again.

(Normal Wiring)

(Incorrect Wiring)

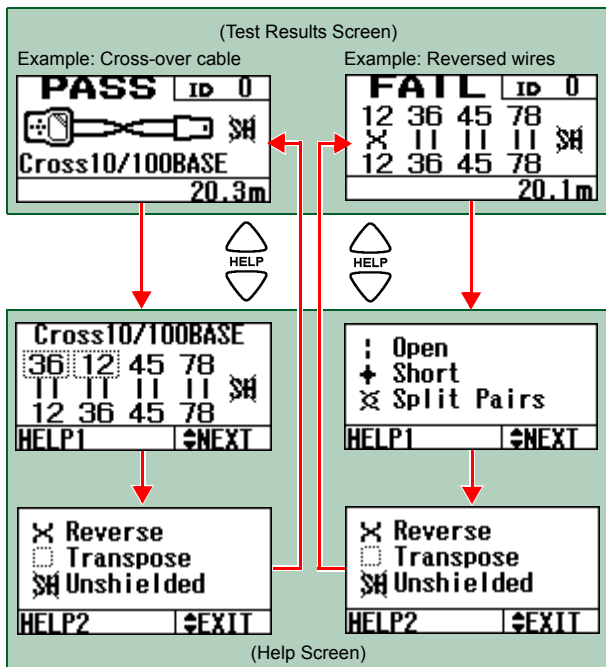

## 3.3 Checking Cable Length

Cable length is displayed at the bottom right.

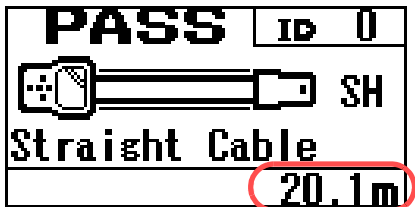

### NOTE

- The wire length of each pair is displayed along the bottom when an open, short or split pair is detected, or when a disconnected terminator or terminator error is detected.

The length of each wire pair may be displayed as a different value depending on the cable type, twisted pair condition or measurement accuracy.

The wire length of a split pair may be displayed as shorter than its actual length (when an impedance mismatch exists).

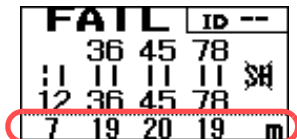

- The HiTester measures cable lengths from 2 to 300 meters (6.6 to 984 feet). Cable lengths outside of this range are not displayed.

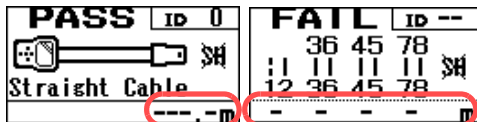

## 3.4 Locating Open or Shorted Wires

When a wire is open (broken) or shorted somewhere along the length of a cable, the distance to the fault is determined.

<Example>

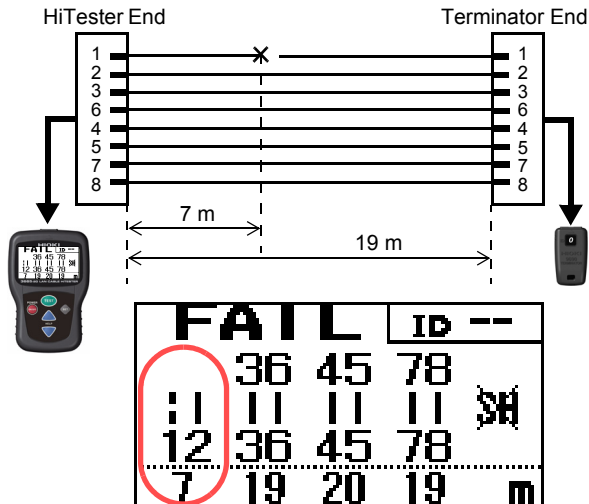

The open-circuit symbol is displayed, and the display length of the 1-2 pair is shorter than the other pairs. This display indicates that the wire at pin 1 is broken about seven meters from the HiTester.



## 3.5 Cable Identification Check

The ID number of the connected terminator is displayed at the top right. In the following example, the HiTester is connected to Terminator ID5.

When no terminator is connected to the test cable, "No Terminator" is displayed.

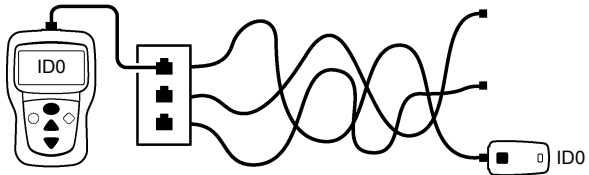
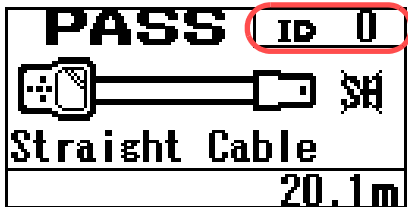

The supplied terminator has ID number 0. Optional terminators are available with ID numbers 1 to 20. Purchase optional terminators when you need to be able to conveniently check multiple cables.

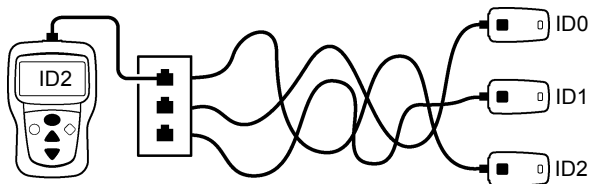

**NOTE**

- The ID number cannot be determined unless pins 1, 2, 3 and 6 are correctly connected through the cable.

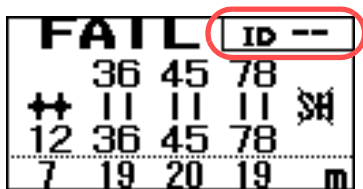

- When Open or No Shield is displayed because a cable is not connected correctly, an incorrect ID number may be displayed (aside from those cases in which Open or No Shield is displayed for terminals with no wiring).

## Setting Procedure Chapter 4

### 4.1 Setting an NVP Value

NVP is the speed of a signal through a cable relative to the speed of light in a vacuum. See "Section Theory of Cable Length Measurement" (p.34) for details.

The optimum NVP value setting depends on the type of cable and twist state of the wire pairs. Cable length measurement accuracy can be optimized by setting the appropriate value for the actual type of cable to be measured. The default HiTester setting is 0.684.

### 4.1.1 Settings for Standard Cable

The most accurate cable length measurements are achieved by setting the NVP value to match the actual type of cable to be tested. Before measuring, prepare a standard reference cable using a known length of exactly the same type as that to be tested. Calibrate the HiTester according to the following procedure.

**NOTE** We recommend that the standard reference cable be at least 100 m (328 feet) long. A shorter length may result in larger measurement errors due to the inaccurate NVP value obtained.

1. Prepare a standard reference cable and measure its actual (physical) length.  
(This example shows a 100 m standard reference cable.)
2. Connect the HiTester to the standard reference cable.

Model 3665-20 LAN CABLE HITESTER

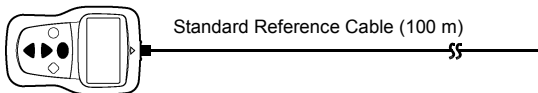

3. Turn the HiTester on, and hold the **SET** key for one second to display the Settings screen.
4. Select "Length Adjust" with the **▲ / ▼** keys, and press the **SET** key.

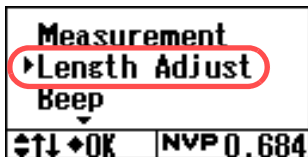

5. Press the **TEST** key to measure the cable length.

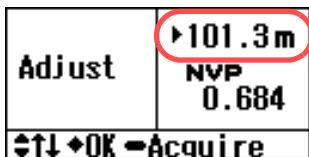
**NOTE**

The cable length measurement range of this instrument is 2 to 300 m (6.6 to 984-ft.).

6. Change the NVP value with the **▲ / ▼** keys so that the displayed length matches the measured physical length of the standard reference cable.

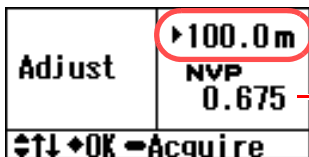

(In this example, "100.0 m" has been selected)

— NVP value

7. Press the **SET** key to display the Confirmation screen, select "OK" with the **▲ / ▼** keys, press the **SET** key again to accept your setting.

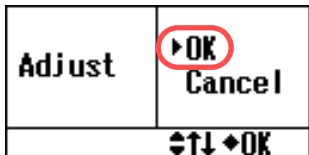

8. Select "Measurement" with the **▲ / ▼** keys, and press the **SET** key to return to the Test screen.

## Theory of Cable Length Measurement

The HiTester employs the TDR (time domain reflectometry) method to measure the amount of time from the input of a pulse to the return of its reflected wave from the far end of the cable.

Model 3665-20 LAN CABLE HITESTER

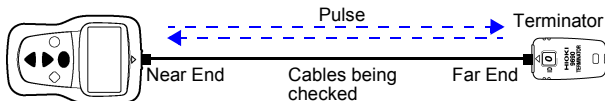

Length is calculated by the following formula:

$$L = \frac{C \times T \times NVP}{2}$$

L : Cable length (m)

C : Speed of light in a vacuum =  $3 \times 10^8$  (m/s)

T : Pulse propagation time from insertion to reflection return (s)

NVP : Nominal Velocity of Propagation (the speed of a signal through a cable relative to the speed of light in a vacuum.)

## Measurement Accuracy

Cable length measurement accuracy is  $\pm 4\% \text{ rdg.} \pm \chi$  m, where  $\chi$  is the quantization error calculated as follows:

$$\chi = \frac{C \times t \times NVP}{2}$$

C : Speed of light in a vacuum =  $3 \times 10^8$  (m/s)

t : Finest time resolution  $10 \times 10^{-9}$  (s)

NVP : Nominal Velocity of Propagation

(Signal propagation speed as a percentage of the speed of light in a vacuum)

In the default case with NVP value of 0.684,  $\chi \cong 1$ .

**NOTE** Refer to "Section Accuracy" (p.39) for details about rdg.

## 4.1.2 Changing the NVP Value

Use the following procedure to change the NVP value.

1. With the HiTester turned on, hold the **SET** key for one second to display the Settings screen.
2. Select "Length Adjust" with the **▲ / ▼** keys, and press the **SET** key.

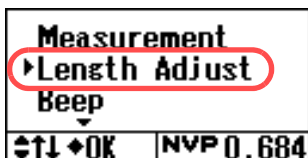

3. Set the NVP value with the **▲ / ▼** keys.

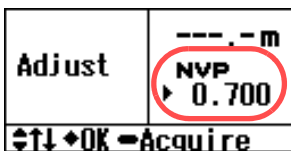

(In this example, "0.700" has been selected)



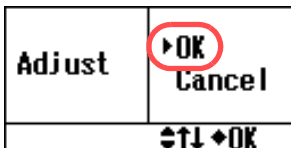

4. Press the **SET** key to display the Confirmation screen, select "OK" with the **▲ / ▼** keys, press the **SET** key again to accept your setting.







5. Select "Measurement" with the **▲ / ▼** keys, and press the **SET** key to return to the Test screen.

## 4.2 Changing Displayed Measurement Units

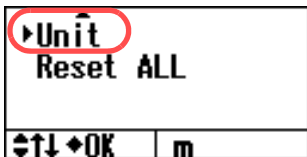
The measurement units in which the cable length is displayed can be switched between "m" and "ft" by the following procedure.



1. With the HiTester turned on, hold the  key for one second to display the Settings screen.
2. Select "Unit" with the  /  keys, and press the  key.

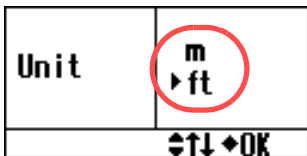

3. Select "m" or "ft" with the  /  keys, and press the  key to accept.



(In this example, "ft" has been selected)

4. Select "Measurement" with the  /  keys, and press the  key to return to the Test screen.



## 4.3 Switching the Beeper On and Off

HiTester operating sounds can be set on and off (silent) by the following procedure.

1. With the HiTester turned on, hold the **SET** key for one second to display the Settings screen.
2. Select "Beep" with the **▲ / ▼** keys, and press the **SET** key.

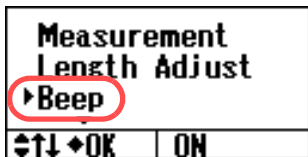

3. Select "ON" or "OFF" with the **▲ / ▼** keys, and press the **SET** key to accept.

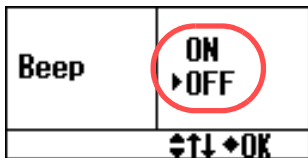

(In this example, "Off" has been selected)

4. Select "Measurement" with the **▲ / ▼** keys, and press the **SET** key to return to the Test screen.

## 4.4 Initializing Settings



To initialize HiTester settings by the following procedure.

Initialized Settings

- NVP value (Initial setting is "0.684")
- Beeper (Initial setting is "On")
- Measurement Units (Initial setting is "m")

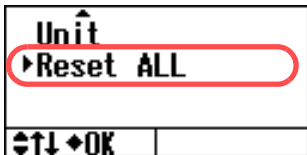
1. With the HiTester turned on, hold the  key for one second to display the Settings screen.
2. Select "Reset ALL" with the ▲ / ▼ keys.



3. Press the  key to display the Confirmation screen, select "OK" with the ▲ / ▼ keys, press the  key again to accept your setting.

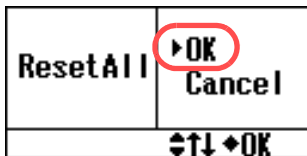

4. Select "Measurement" with the ▲ / ▼ keys, and press the  key to return to the Test screen.

# Specifications

# Chapter 5

## Accuracy

We define measurement tolerances in terms of rdg. (reading), with the following meanings:

### **rdg. (reading or displayed value)**

The value currently being measured and indicated on the measuring instrument.

## 5.1 Model 3665-20 LAN CABLE HiTESTER

### 5.1.1 Basic Specifications

Measurement Function	<ul style="list-style-type: none"> <li>• Wiremap test</li> <li>• Cable length measurement</li> <li>• Cable identification check</li> </ul>
Measurable cable and connector types	Twisted-pair cables: 100 $\Omega$ characteristic impedance shielded or unshielded CAT3, CAT4, CAT5, CAT5e, CAT6 RJ-45 connector
Allowed input	Up to 3.3 V <sub>peak</sub> (between RJ-45 pins)
Accuracy guarantee for temperature and humidity	23 $\pm$ 5 $^{\circ}$ C (73 $\pm$ 9 $^{\circ}$ F), 80% RH or less (non-condensating, when  indicator is not blinking)
Guaranteed accuracy period	1 year
Product warranty period	3 years

## Measurement Function Details

### Wiremap Test

Measurement Items	Wiremaps and shielding can be checked using the Model 9690 TERMINATOR Faults detected Open, short, reversed, transposed, split and other wiring faults
Testing method	Voltage divider (for split pairs: crosstalk detection method)
Output (Reference value)	3.0 V <sub>peak</sub> (Split pairs: $\pm 3.0$ V <sub>peak</sub> , 120-kHz quasi sine wave)

### Cable Length Measurement

Measurement Items	Measurable length: 2 to 300 m (6.6 to 984-ft.) Measurement accuracy: $\pm 4\%$ rdg. $\pm 1$ m ( $\pm 4\%$ rdg. $\pm 3.3$ -ft.) (not including error caused by inaccurate NVP) Displayed measurement resolution: 0.1 m (0.3-ft.)
Testing method	TDR method
Output (Reference value)	Pulse signal, Pulse Width 10 n, 20 n, 80 n, 320 ns(Auto setting), Amplitude 3.3 V <sub>p-p</sub>

### Cable Identification Check

Measurement Items	Identifies up to 21 cables using the supplied Model 9690 and optional Models 9690-01 to 9690-04
Testing method	Voltage divider method
Output (Reference value)	3.0 V <sub>peak</sub>

## 5.1.2 General Specifications

Display	LCD (with backlight)
Operating temperature and humidity	0°C to 40°C (32°F to 104°F), 80% RH or less (non-condensating)
Storage temperature and humidity	-10°C to 50°C (14°F to 122°F), 80% RH or less (non-condensating)
Operating environment	Indoors, altitude up to 2000 m (6562-ft.)
Rated supply voltage	DC1.5 V × 2 (two LR6 alkaline batteries)
Maximum rated power	1.4 VA
Continuous operating time	Approx. 50 hours (1 measurement/minute, reference value)
Dimensions	Approx. 85W × 130H × 33D mm (3.35"W × 5.12"H × 1.30"D, sans protrusions)
Mass	Approx. 160 g (5.6 oz., without batteries)
Applicable Standards	Safety EN61010 Pollution degree 2 EMC EN61326
Accessories	Model 9690 TERMINATOR..... 1 Carrying case..... 1 LR6 alkaline batteries ..... 2 Instruction manual ..... 1

Options	Model 9690-01 TERMINATOR (ID1 to ID5) Model 9690-02 TERMINATOR (ID6 to ID10) Model 9690-03 TERMINATOR (ID11 to ID15) Model 9690-04 TERMINATOR (ID16 to ID20) Model 9249 CARRYING CASE Model 9628 LAN CABLE (for cable testing, 1 m long, with RJ-45 plugs on each end)
---------	---------------------------------------------------------------------------------------------------------------------------------------------------------------------------------------------------------------------------------------------------------------------------------------------

### 5.1.3 Functions Specifications

NVP setting function	<ul style="list-style-type: none"> <li>• NVP auto calculation from length of a standard reference cable</li> <li>• Direct NVP setting (0.684 default value)</li> </ul>
Auto backlight	Backlight is lit by key operation (auto turn-off after approx. 20 seconds)
Beeper	Sounds for key operations and when measurement results are displayed
Power saving mode	Operates after measurement (wakes with the <b>TEST</b> key)
Auto power-off	Power turns off automatically 10 minutes after the last key operation
Low-battery warning	The <b>B</b> indicator blinks when battery voltage falls below 2.4 V
Displayed measurement units	meters (m) or feet (ft)

## 5.2 Model 9690 TERMINATOR

Circuit type	Resistance network
Measurable cable and connector types	Twisted-pair cables: 100 $\Omega$ characteristic impedance shielded or unshielded CAT3, CAT4, CAT5, CAT5e, CAT6 RJ-45 connector
ID number	0
Operating temperature and humidity	0°C to 40°C (32°F to 104°F), 80% RH or less (non-condensating)
Storage temperature and humidity	-10°C to 50°C (14°F to 122°F), 80% RH or less (non-condensating)
Operating environment	Indoors, altitude up to 2000 m (6562-ft.)
Dimensions	Approx. 26W × 46H × 19Dmm (1.02"W × 1.81"H × 0.75"D, sans protrusions)
Mass	Approx. 14 g (0.5 oz.)





## Optional Accessories

## Chapter 6

The following options are available for the 3665-20 LAN CABLE HiTESTER. Ask your dealer or Hioki representative when ordering.

### Terminators

To conveniently identify multiple cables with the HiTester, you can use the optional terminators (sold in 5-piece sets) to eliminate the need to change cable connections at the far end.

- Model 9690-01 TERMINATOR (ID number: 1 to 5)
- Model 9690-02 TERMINATOR (ID number: 6 to 10)
- Model 9690-03 TERMINATOR (ID number: 11 to 15)
- Model 9690-04 TERMINATOR (ID number: 16 to 20)

## Model 9249 CARRYING CASE

The hard case holds the HiTester, terminators and a LAN patch cable. Extra space is provided for other tools. Keep this manual in the flap pocket inside the cover.

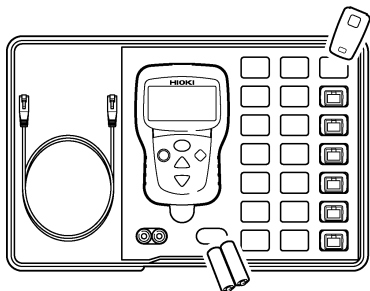

## Model 9628 LAN CABLE

Use this patch cable to connect the HiTester to the cable to be tested through a wall jack (for cable testing, 1 m long, with RJ-45 plugs on each end).

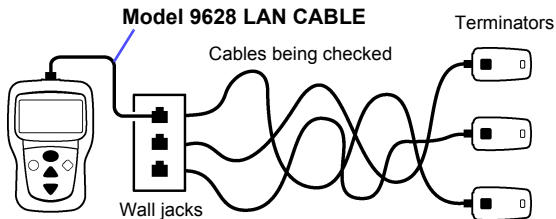

# Maintenance and Service

## Chapter 7

### **CAUTION**

Never modify the instrument. Only Hioki service engineers should disassemble or repair the instrument. Failure to observe these precautions may result in fire, electric shock, or injury.

## 7.1 Cleaning

To clean the instrument, wipe it gently with a soft cloth moistened with water or mild detergent. Never use solvents such as benzene, alcohol, acetone, ether, ketones, thinners or gasoline, as they can deform and discolor the case.

Wipe the LCD gently with a soft, dry cloth.

## 7.2 Troubleshooting





If damage is suspected, check the "Troubleshooting" section before contacting your dealer or Hioki representative.

### **NOTE**

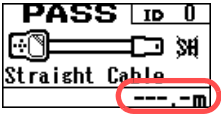
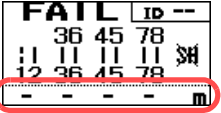
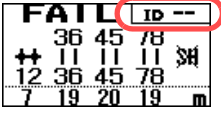
When sending the instrument for repair, remove the batteries and pack carefully to prevent damage in transit. Include cushioning material so the instrument cannot move within the package. Be sure to include details of the problem. Hioki cannot be responsible for damage that occurs during shipment.

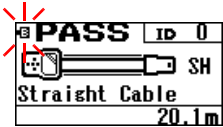

## Troubleshooting

Symptom	Checks and Remedy
<p>Cable length is not displayed</p>  	<p>Is the cable between 2 and 300 m long?</p> <p>→The cable length measurement range of this instrument is 2 to 300 m (6.6 to 984-ft.). However, cable length cannot be measured if the cable's characteristic impedance is far from 100 Ω. The Model 9628 LAN CABLE is 1 m long, so it cannot be measured.</p>
<p>The results of the cable length test is different from the actual cable length.</p>	<p>The amount of error specified for cable length testing is <math>\pm 4\%rdg. \pm 1m</math>. Please check first to see if the test results come within this range.</p> <p>→If the test results are indeed outside of the accuracy range, change the settings for the NVP value. (p.31)</p>
<p>Open or other incorrect wiring (? display) is displayed even when a normal cable is measured.</p>	<p>Have you ever connected to a live telephone wire, etc.? (p.17)</p> <p>→The HiTester may be damaged due to an application of overvoltage. Please send it for repair.</p>
<p>"No Terminator" is displayed</p>	<p>→"Section 7.3 Error Display" (p.50)</p>
<p>No ID number is displayed</p> 	<p>Are pins 1, 2, 3 and 6 connected correctly in the test cable?</p> <p>→Check cable wiring.</p>

Symptom	Checks and Remedy
An incorrect ID number is displayed	<p>Is the test cable connected correctly?</p> <p>→When Open or No Shield is displayed because a cable is not connected correctly, an incorrect ID number may be displayed. (Open or No Shield is displayed when a wire is not connected.)</p>
<p>Cable length is not obtained when cable length calibration has been performed</p> 	<p>Is the cable between 2 and 300 m long?</p> <p>→The cable length measurement range of this instrument is 2 to 300 m (6.6 to 984-ft.). However, cable length cannot be measured if the cable's characteristic impedance is far from 100 Ω.</p>
<p>The  mark is blinking</p> 	<p>→Replace the batteries (p.51).</p>
<p>Nothing is displayed even when pressing the POWER  key</p>	<p>→Replace the batteries (p.51)</p> <p>Are the batteries installed correctly?</p> <p>→Check whether the batteries are installed correctly. If installed incorrectly, reinstall the batteries (p.51).</p>

## 7.3 Error Display

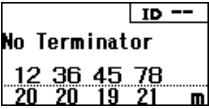
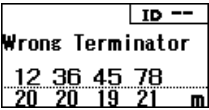
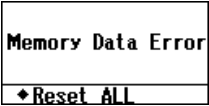
When an error is displayed, confirm the following contents.

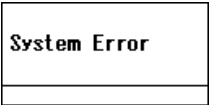
Message	Description and Remedy
<p>No Terminator</p> 	<p>The 9690 TERMINATOR is disconnected. →Connect the 9690 TERMINATOR.</p>
<p>Terminator Error</p> 	<p>A device other than a 9690 TERMINATOR is connected. →Connect a 9690 TERMINATOR.</p>
<p>Memory Error</p> 	<p>Some data could not be stored or read correctly. →Press the  key to initialize HiTester settings. →If the problem is not resolved by initializing, contact your supplier or nearest Hioki representative.</p>
<p>System Error</p> 	<p>The HiTester has internal system damage. →Contact your dealer or Hioki representative.</p>

## 7.4 Replacing the Batteries

Replace batteries if they are weak.

### **! WARNING**

- Do not mix old and new batteries, or different types of batteries. Also, be careful to observe battery polarity during installation. Otherwise, poor performance or damage from battery leakage could result.
- To avoid the possibility of explosion, do not short circuit, disassemble or incinerate batteries.
- Handle and dispose of batteries in accordance with local regulations.

### **! CAUTION**

To avoid electric shock, turn off the power and disconnect the testing cable before replacing the batteries. After replacing the batteries, replace the cover before using the instrument.

### **NOTE**

- The  indicator flashes when battery voltage becomes low. Replace the new batteries soon.

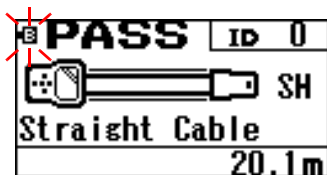

- Do not attempt to use any power source other than the specified AA-size (LR6) alkaline batteries. Operating time with non-alkaline (manganese) batteries is shorter.

1. Remove the test cable, if connected.
2. Turn the HiTester off.
3. Remove the battery compartment cover.
4. Remove both batteries and install new ones with attention to polarity.
5. Replace the battery compartment cover.

Rear Panel

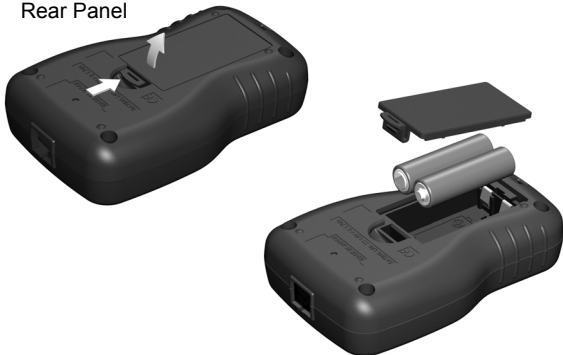
**CAUTION**

To avoid damaging the battery compartment cover, do not attempt to open it by inserting a screwdriver into the latch hole.





# Warranty Certificate

# HIOKI

Model	Serial number	Warranty period Three (3) years from date of purchase ( ___ / ___ )
-------	---------------	------------------------------------------------------------------------

Customer name: \_\_\_\_\_

Customer address: \_\_\_\_\_

## Important

- Please retain this warranty certificate. Duplicates cannot be reissued.
- Complete the certificate with the model number, serial number, and date of purchase, along with your name and address. The personal information you provide on this form will only be used to provide repair service and information about Hioki products and services.

This document certifies that the product has been inspected and verified to conform to Hioki's standards.

Please contact the place of purchase in the event of a malfunction and provide this document, in which case Hioki will repair or replace the product subject to the warranty terms described below.

## Warranty terms

1. The product is guaranteed to operate properly during the warranty period (three [3] years from the date of purchase).  
If the date of purchase is unknown, the warranty period is defined as three (3) years from the date (month and year) of manufacture (as indicated by the first four digits of the serial number in YYMM format).
2. If the product came with an AC adapter, the adapter is warranted for one (1) year from the date of purchase.
3. The accuracy of measured values and other data generated by the product is guaranteed as described in the product specifications.
4. In the event that the product or AC adapter malfunctions during its respective warranty period due to a defect of workmanship or materials, Hioki will repair or replace the product or AC adapter free of charge.
5. The following malfunctions and issues are not covered by the warranty and as such are not subject to free repair or replacement:
  - 1. Malfunctions or damage of consumables, parts with a defined service life, etc.
  - 2. Malfunctions or damage of connectors, cables, etc.
  - 3. Malfunctions or damage caused by shipment, dropping, relocation, etc., after purchase of the product
  - 4. Malfunctions or damage caused by inappropriate handling that violates information found in the instruction manual or on precautionary labeling on the product itself
  - 5. Malfunctions or damage caused by a failure to perform maintenance or inspections as required by law or recommended in the instruction manual
  - 6. Malfunctions or damage caused by fire, storms or flooding, earthquakes, lightning, power anomalies (involving voltage, frequency, etc.), war or unrest, contamination with radiation, or other acts of God
  - 7. Damage that is limited to the product's appearance (cosmetic blemishes, deformation of enclosure shape, fading of color, etc.)
  - 8. Other malfunctions or damage for which Hioki is not responsible
6. The warranty will be considered invalidated in the following circumstances, in which case Hioki will be unable to perform service such as repair or calibration:
  - 1. If the product has been repaired or modified by a company, entity, or individual other than Hioki
  - 2. If the product has been embedded in another piece of equipment for use in a special application (aerospace, nuclear power, medical use, vehicle control, etc.) without Hioki's having received prior notice
7. If you experience a loss caused by use of the product and Hioki determines that it is responsible for the underlying issue, Hioki will provide compensation in an amount not to exceed the purchase price, with the following exceptions:
  - 1. Secondary damage arising from damage to a measured device or component that was caused by use of the product
  - 2. Damage arising from measurement results provided by the product
  - 3. Damage to a device other than the product that was sustained when connecting the device to the product (including via network connections)
8. Hioki reserves the right to decline to perform repair, calibration, or other service for products for which a certain amount of time has passed since their manufacture, products whose parts have been discontinued, and products that cannot be repaired due to unforeseen circumstances.

HIOKI E.E. CORPORATION

<http://www.hioki.com>

18-07 EN-3





# HIOKI

<http://www.hioki.com>



**Our regional  
contact  
information**

## **HEADQUARTERS**

81 Koizumi  
Ueda, Nagano 386-1192 Japan

## **HIOKI EUROPE GmbH**

Rudolf-Diesel-Strasse 5  
65760 Eschborn, Germany  
[hioki@hioki.eu](mailto:hioki@hioki.eu)

1808EN

---

Edited and published by HIOKI E.E. CORPORATION

Printed in Japan

- CE declarations of conformity can be downloaded from our website.
- Contents subject to change without notice.
- This document contains copyrighted content.
- It is prohibited to copy, reproduce, or modify the content of this document without permission.
- Company names, product names, etc. mentioned in this document are trademarks or registered trademarks of their respective companies.