



# **THERMAL WIRE STRIPPER**

## **FT-802**

### **Instruction Manual**



Thank you for purchasing  
the HAKKO FT-802 Thermal Wire Stripper.

Be sure to read this manual before  
operating the HAKKO FT-802.

Keep this manual readily accessible  
for reference.



# Table of Contents

<b>1. PACKING LIST AND PART NAMES</b> .....	<b>1</b>
<b>2. SPECIFICATIONS</b> .....	<b>1</b>
<b>3. WARNINGS, CAUTIONS AND NOTES</b> .....	<b>2</b>
<b>4. INITIAL SETUP</b> .....	<b>3</b>
4-1 Blades .....	3
4-1-1 Attaching blades .....	3
4-1-2 Removing blades .....	3
4-1-3 Blade holder.....	3
4-2 Station .....	4
<b>5. HOW TO USE</b> .....	<b>4</b>
5-1 Operation and display (switch and operation buttons) .....	4
5-2 Setting/changing output.....	4
5-3 Handle .....	5
5-3-1 Attaching the lead adjuster .....	5
5-3-2 How to use the lead adjuster .....	6
5-3-3 Stripping a wire .....	6
<b>6. SETTING PARAMETERS</b> .....	<b>7</b>
6-1 Parameter setting table .....	7
6-2 Parameter setting procedure.....	8
<b>7. MAINTENANCE</b> .....	<b>12</b>
<b>8. INSPECTION</b> .....	<b>12</b>
<b>9. TROUBLESHOOTING</b> .....	<b>13</b>
<b>10. PART NUMBER</b> .....	<b>13</b>

# 1. PACKING LIST AND PART NAMES

Please make sure that all items listed below are included in the package.

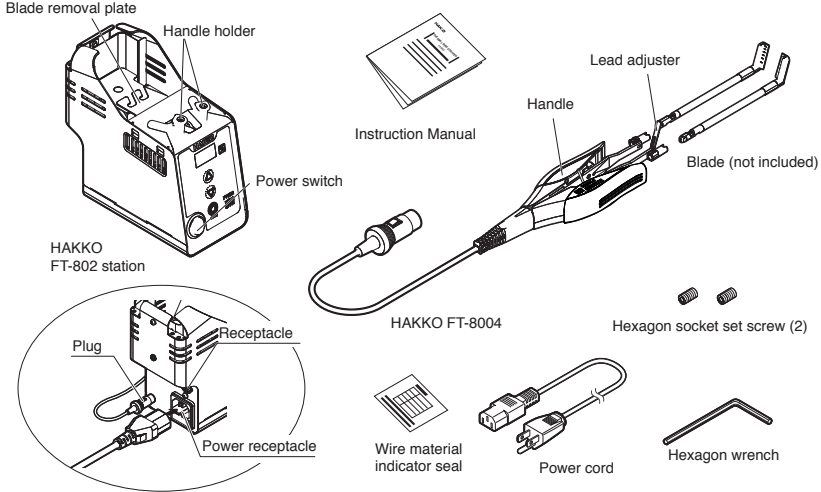

## PACKING LIST

HAKKO FT-802 station .....	1
HAKKO FT-8004 .....	1
Power cord .....	1
Wire material indicator seal .....	1

Hexagon wrench (1.27mm) .....	1
Instruction Manual .....	1
Hexagon socket set screw (M2.5x2.5) .....	2

## 2. SPECIFICATIONS

### • HAKKO FT-802

Power Consumption	76W
-------------------	-----

### • Station

Output	AC 20V
Outside dimensions	76 (W)×159 (H)×161 (D)mm (3.0×6.3×6.3in.)
Weight	1.6kg (3.5lb.)

### • HAKKO FT-8004 (Handle)

Power Consumption	72W (20V)
Length of Cord	1.6m (5.3ft.)
Length (w/o cord, blade)	153mm (6.0in.)
Weight (w/o cord, blade)	47g (0.10lb.)

### NOTE:

\*Specifications and design are subject to change without notice.

\*This product is protected against electrostatic discharge.

## ⚠ CAUTION

This product includes features such as electrically conductive plastic parts and grounding of the handle and station as measures to protect the device to be soldered from the effects of static electricity.

Be sure to observe the following instructions:

- The handle and other plastic parts are not insulators, they are conductors. When replacing parts or repairing, take sufficient care not to expose live electrical parts or damage insulation materials.
- Be sure to ground the unit during use.

### 3. WARNINGS, CAUTIONS AND NOTES

---

Warnings and cautions are placed at critical points in this manual to direct the operator's attention to significant items. They are deemed as follows:

**⚠ WARNING :** Failure to comply with a WARNING may result in serious injury or death

**⚠ CAUTION :** Failure to comply with a CAUTION may result in injury to the operator, or damage to the items involved.

A NOTE indicates a procedure or point that is important to the process being described

#### **⚠ WARNING**

**After the power is turned on, the blade temperature can reach as high as 800°C (1472°F). Improper handling may cause burns or fire. Be sure to observe the following precautions.**

- Do not touch the blade or metal parts near the blade.
- Do not allow the blade to come close to, or touch, flammable materials.
- Inform others in the area that the unit is hot and should not be touched.
- Turn the power off when not in use, or left unattended.
- Turn the power off when changing parts or storing the HAKKO FT-802.
- Place the handle on the handle holder when not using the HAKKO FT-802.
- The unit is for a counter or workbench use only.
- This appliance can be used by children aged from 8 years and above and persons with reduced physical, sensory or mental capabilities or lack of experience and knowledge if they have been given supervision or instruction concerning use of the appliance in safe way and understand the hazards involved.
- Children shall not play with the appliance.
- Cleaning and user maintenance shall not be made by children without supervision.

**Observe the following precautions to prevent accidents or damage to the unit.**

#### **⚠ CAUTION**

- Do not use the HAKKO FT-802 for applications other than wire stripping.
- Do not strike the blade against workbench to remove stripped insulation debris. This will damage the blade.
- Do not modify the HAKKO FT-802.
- Do not allow the HAKKO FT-802 to become wet, or use it when hands are wet.
- Since smoke is produced when using the wire stripper, be sure the work area is well ventilated.
- Use only genuine Hakko replacement parts.
- Remove power and iron cords by holding the plug, not the wires.
- While using HAKKO FT-802, do not do anything which may cause bodily harm or physical damage.

## 4. INITIAL SETUP

### 4-1 Blades

#### 4-1-1 Attaching blades

- ① Stop provisionally in the tapped hole of the handle, and do a set the hexagon socket set screw.
- ② Insert the blade so that the blade mounting flange locks into the FT-8004.Merge type V and the V-groove of the back of the blade.

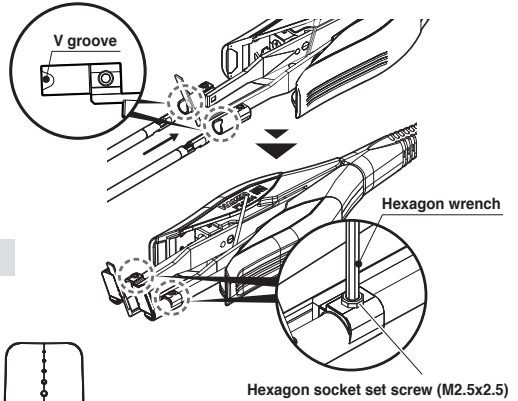

#### NOTE:

Blades are not heated unless both blades are inserted fully. Be sure to use the blades as a set.

- ③ Fix it with a finger so that the point of a sword does not work, tighten the hexagon socket set screw with the hexagonal wrench to secure the blades.

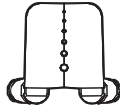

#### 4-1-2 Removing blades

- ① Switch off the power and wait until the blades have cooled down.
- ② Remove the screws with the hexagonal wrench and remove the blades using the main body blade removal plate.

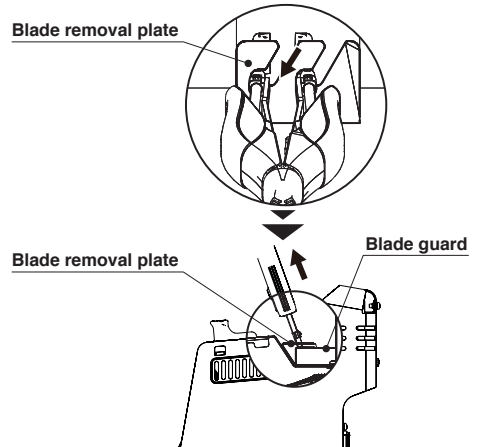

#### CAUTION

- \* When pulling out or inserting blades, be sure that the power is switched off.
- \* Before pulling out the blades, check that the blades have cooled down sufficiently.

#### 4-1-3 Blade holder

The removed blades can be placed in the holder as shown at right.

Hex wrench can be placed in the position of the arrow.

#### NOTE:

Place the removed blade in the blade holder.

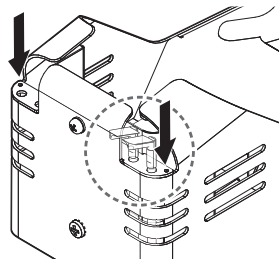

## 4. INITIAL SETUP (continued)

### 4-2 Station

- 1 Connect the power cord to the inlet on the rear side of the station.
- 2 Place the HAKKO FT-8004 on the handle holder with the blades facing up.
- 3 Plug the handle plug into the receptacle.
- 4 Plug the power cord plug into an electrical outlet.

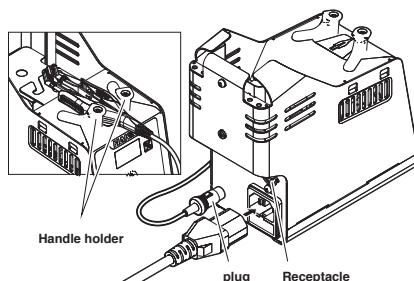

## 5. HOW TO USE

### 5-1 Operation and display (switch and operation buttons)

- 1 Switch on the power.
- 2 **888** will be lit for 2 sec.
- 3 The displayed output value will blink. After the temperature has increased and stabilized, the displayed value will change from blinking to lit. The unit is ready for use when the displayed value is lit.

\* For the output value, set it according to the following wire material indication table.

Material	Output value (%)
PVC	10
PE	10
PA	20
PVDF	30
ETFE	40
SI	45
PTFE	55

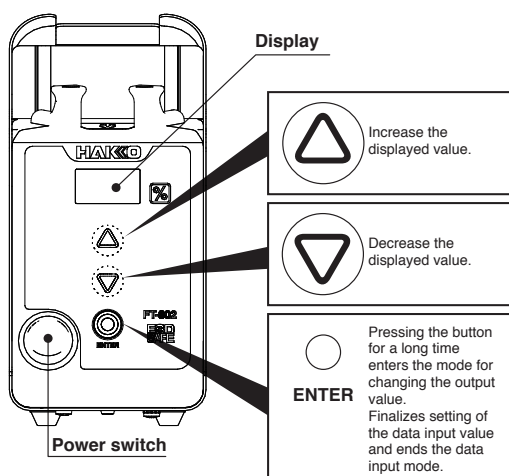

#### NOTE:

Output values will vary from the values in the table above depending on the wire composition and wire diameter. In addition, it may be necessary to set higher values depending on blade oxidation and maintenance conditions.

#### CAUTION

- \* The factory default value is set to 50%.
- \* Since the blades will become hot, place the handle on the handle holder when it is not being used.

### 5-2 Setting/changing output

Ex: When changing the output from 50% to 65%:

- 1 Press the  $\Delta$ ,  $\nabla$  or [ENTER] button for 2 sec or longer.  
The unit will enter the output change mode and the displayed value will change to blinking.
- 2 Press the  $\Delta$  or  $\nabla$  button to finalize setting of value.  
After your desired value is displayed, press the [ENTER] button. When the displayed value will change from blinking to lit, the unit is ready for use.

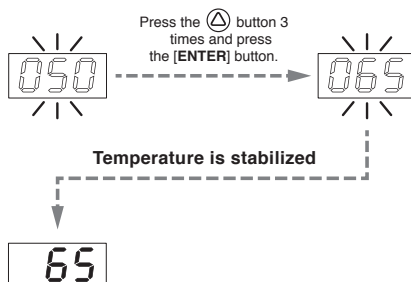

## NOTE:

The output value range is 5% to 100%. The output values can be set in increments of 5%. If the output is 80% or less, **rdy** will be displayed when the handpiece is placed on the station indicating the timer start for the auto sleep setting set by parameter 02. If **△**, **▽** or "Enter" are pressed while **rdy** is displayed, the current output value will then be displayed. If the output is more than 80%, **SLP** will be displayed when the handpiece is placed on the station, for more information see page 10.

Relation of display and blade temperature when handle is placed on the station

Output	Sleep function	Display	Blade temperature
80% or less	ON	rdy --> SLP	rdy : same as the output value --> SLP : 50% of the output value
	OFF	rdy	Same as the output value
85% or more	ON	SLP	50% of the output value
	OFF	SLP	50% of the output value

For setting parameters of the auto sleep function, see page 10.

## 5-3 Handle

### 5-3-1 Attaching the lead adjuster

- ① Remove the insulating cover from the tip on the handle cover L-side (the side with the HAKKO logo and FT-8004) and remove the screw from the handle cover L-side.
- ② Remove the handle cover L.
- ③ Align the lead adjuster mounting hole with the handle cover L mounting hole, replace the screw, and tighten it lightly.
- ④ Firmly fit the nail of the root side of the insulation cover in the handle cover.
- ⑤ Attach the handle cover L to the handle. Adjust the length of the lead adjuster and firmly tighten the screw.

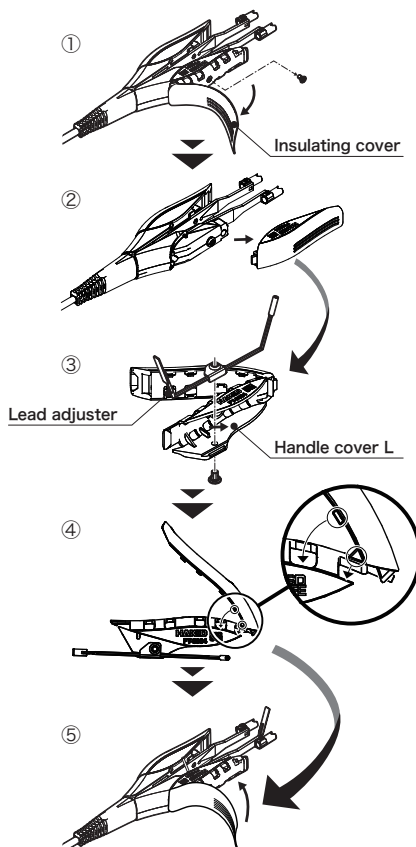

## NOTE:

Pay attention to the direction of the blades when attaching the lead adjuster. (See the following figure.) Attach the lead adjuster so that the adjuster plate end is in parallel with the blade surface.

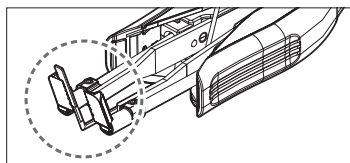

The lead adjuster can be removed with the handle cover attached to the handle.

## 5. HOW TO USE (continued)

### 5-3-2 How to use the lead adjuster

The lead adjuster is a tool for setting the wire stripping length.

Adjust the distance between the blade end and the adjuster plate to the desired wire stripping length and slide it.

(Settable stripping length is 1 to 35mm.)

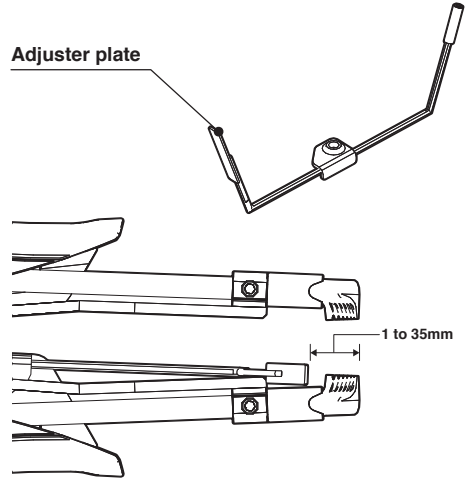

### 5-3-3 Stripping a wire

- ① Align the wire end with the lead adjuster.
- ② Pinch the wire with the blades according to the diameter of the wire to be stripped. The pinched area will be melted by heat.
- ③ Spread the heat evenly over the pinched area by rotating the wire and the blades.
- ④ Pull the blades toward the wire end to be stripped.

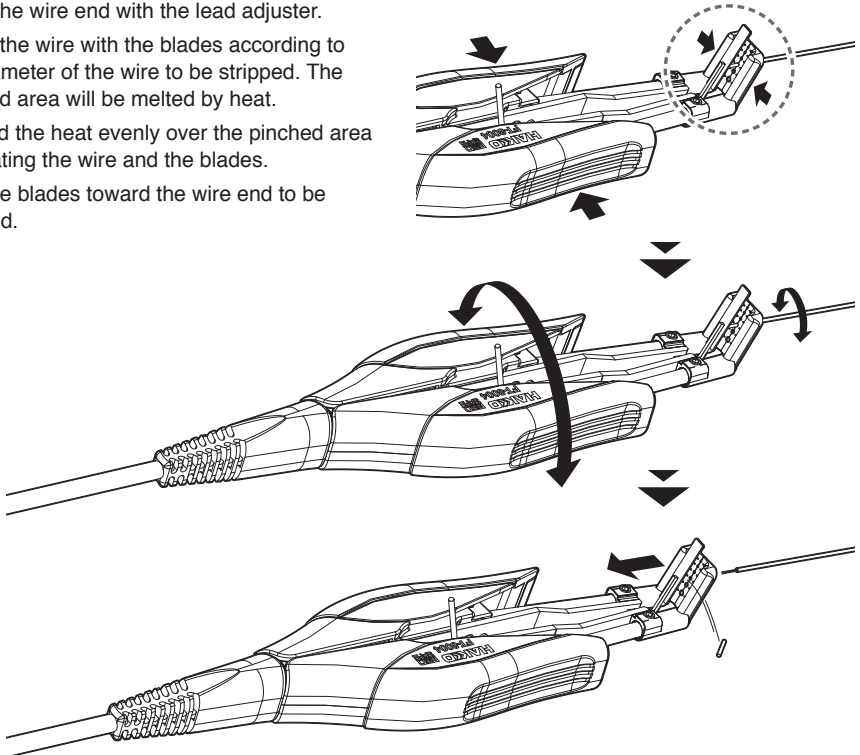



## 6. SETTING PARAMETERS

To make this product more convenient to use, the HAKKO FT-802 has the following parameters which can be set. The parameter settings can be changed to suit your use environment.

- **Password setting**  
Setting a password allows you to lock the settings for the output values and parameter values.
- **High output setting\***  
The high output function for the blade output can be enabled or disabled.
- **Output upper limit setting\***  
An upper limit for the blade output can be set to prevent the output from being set above the limit value.
- \* When stripping is difficult by wire diameter and composition, use a high output mode.
- **Auto sleep enable/disable setting**  
The auto sleep function can be enabled or disabled.
- **Auto sleep time setting**  
Auto sleep saves the set output by approx. 50% and reduces the blade temperature to conserve power consumption.
- **Auto shutoff enable/disable setting**  
The auto shut-off function can be enabled or disabled.
- **Auto shutoff time setting**  
After the set time has elapsed, the output will be switched off and the unit will enter standby mode.

### 6-1 Parameter setting table

	Parameter number	LED display	Set details	Initial value
Password setting	14	0 or 1 or 2	0 : Disabled 1 : Partially enabled 2 : Enabled	0 : Disabled
		AbCdEf (3 digit)	1 or 2	---
High output setting*1	12	0 or 1	0 : Disabled 1 : Enabled	
Output upper limit setting*1	19		Settable in 5% intervals	100
Auto sleep enable/disable setting	07	0 or 1	0 : Disabled 1 : Enabled	1 : Enabled
Auto sleep time setting*2	02	0 ~ 30	0 ~ 30 : Time until effective	15 (min)
Auto shutoff enable/disable setting	08	0 or 1	0 : Disabled 1 : Enabled	1 : Enabled
Auto shutoff time setting*3	18	1 ~ 30	1 ~ 30 : Time until effective	15 (min)

\*1. "High output setting" and "Output upper limit setting" are displayed when "1" or "2" is selected in "Password setting".

\*2. "Auto sleep time setting" is displayed when "1" is selected in "Auto sleep enable/disable setting".

\*3. "Auto shutoff time setting" is displayed when "1" is selected in "Auto shutoff enable/disable setting".

## 6. SETTING PARAMETERS (continued)

### 6-2 Parameter setting procedure

#### Parameter input mode flowchart

Follow the steps below to input parameter values.

- ① Hold the  $\Delta$  and  $\nabla$  buttons pressed while switching on the power to enter parameter input mode.

- ② Select the parameter number.

Initially, the parameter number  $\boxed{14}$  will be blinking. Change the parameter number to the parameter to be set by pressing the  $\Delta$  or  $\nabla$  button.

Pressing the  $\Delta$  button causes the number to be displayed in the following order:

(  $\boxed{12}$   $\rightarrow$   $\boxed{19}$  )  $\rightarrow$  (  $\boxed{07}$  )  $\rightarrow$  (  $\boxed{02}$  )  $\rightarrow$   $\boxed{08}$   $\rightarrow$  (  $\boxed{18}$  )

Pressing the  $\nabla$  button displays the number in reverse order.

Selecting the parameter number and pressing the [ENTER] button changes the display to the parameter value.

- ③ Select the parameter value.

The currently-set value is displayed initially. Change to the desired parameter value by pressing the  $\Delta$  or  $\nabla$  button. Pressing the [ENTER] button returns to the parameter number selection mode.

After setting the required parameter values, press and hold the [ENTER] button while performing operations in Step 2 to 3.

- ④ The display will change to  $\boxed{y}$  and the unit will ask you whether to exit the parameter input mode. Selecting  $\boxed{y}$  and pressing the [ENTER] button will exit the parameter input mode.

#### NOTE:

You can switch the display between  $\boxed{y}$  and  $\boxed{n}$  by pressing the  $\Delta$  or  $\nabla$  button. When selecting  $\boxed{n}$ , the current screen will be jumped to the parameter number selection screen ② again.

## 14 Password setting

Setting a password enables the set output value or parameter values to be locked.

The password is set by selecting a combination of 3 characters from among the 6 characters of *AbCdEf*.

The password setting has 3 levels.

: Disabled (no lock)

: Partially enabled. (The parameter settings are locked by the password. Although the output value is not locked and can be changed, the output value cannot be set higher than the output upper limit setting.)

: Enabled (Output value and parameter setting details are completely locked by the password.)

### 1. Setting method (when the password is enabled)

Ex) To set the password to , follow the steps below.

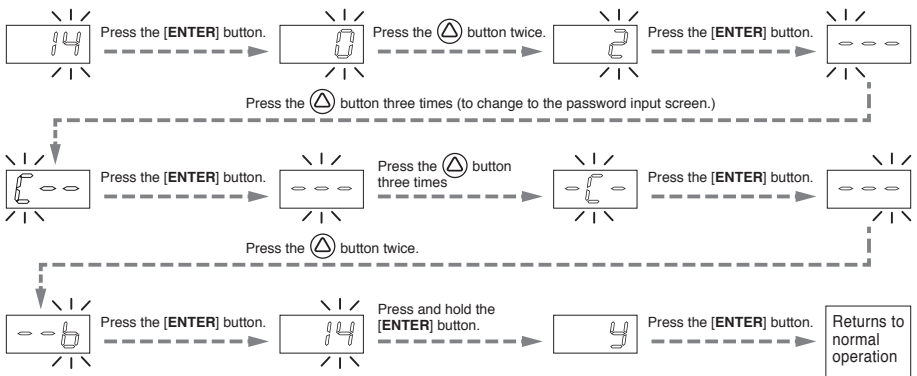

### 2. Inputting method (When the password is enabled, input the previously set password: in the example.)

**NOTE:** If the password is enabled, it is necessary to input the password to enter the output value setting mode or parameter setting mode.

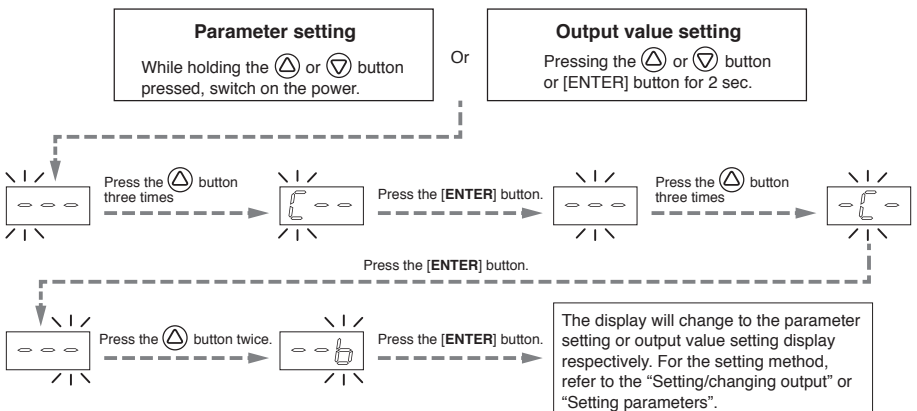

## 6. SETTING PARAMETERS (continued)

### WARNING

The high temperature at 105% - 120% could shorten blade life or that the blade will glow red. Place the handle on the handle holder when not using the HAKKO FT-802.

#### **12** High output setting

Enable or disable the high-output function.

This function operates when the password setting mode is set to  **!** (partially enabled) or  **2** (enabled).

When the high output function is enabled, it is possible to set higher values than usual in  **19** Output upper limit setting.

When the high output function is enabled, the maximum settable upper limit value and the maximum parameter  **19** Output upper limit setting will be **120**. (When the function is disabled, the maximum value for both is **100**.)

**0** : High output function is disabled.

**!** : High output function is enabled.

**NOTE:** In order to achieve high values above 100 for the settable value, parameter  **12** High output setting should be changed to  **!**, then parameter  **19** Output upper limit setting must also be changed before changing the settable value.

#### **19** Output upper limit setting

An upper limit for the blade output value can be set, making it impossible to set the value to higher than the upper limit.

This function operates when the password setting mode is set to  **!** (partially enabled) or  **2** (enabled).

If the set parameter value is  **80**, the maximum settable output value will be **80**. It is possible to set the values in increments of 5%.

(The initially set value is 100%.)

#### **07** Auto sleep enable/disable setting

Enable or disable the auto sleep function.

The auto sleep function saves the set output by approx. 50%, reducing the blade temperature and power consumption. This function extends the service life of blades.

When the auto sleep function is enabled, the auto sleep function will operate when the specified time has elapsed after placing the handle on the handle holder.

The time until the auto sleep function operates can be set in k " **02** : Auto sleep time setting".

**0** : Auto-sleep is disabled.

**!** : Auto-sleep is enabled.

**NOTE:** When setting the output setting to 85 or more, regardless of the ON / OFF setting of the auto sleep function, placing the soldering iron on the soldering iron will activate the auto sleep function.

**02****Auto sleep time setting**

This function operates when the Auto sleep enable/disable setting is set to **!** (enabled). Set the time until the auto sleep function operates after placing the handle on the handle holder. When the time is set to **0**, the auto sleep function starts immediately after placing the handle on the handle holder.

Display: **SLP** is lit.

**0** ~ **30** The auto sleep time can be set in increments of 1 min.  
(The initial default set time is 15 min. and the maximum time is 30 min.)

**NOTE:** The auto sleep function does not work when the handle is not placed on the handle holder. When the auto sleep function is operating, the unit will become active again when the handle is lifted off of the handle holder.

**08****Auto shutoff enable/disable setting**

Enable or disable the auto shutoff function.

When the auto shutoff function is enabled, the auto shutoff function will operate when the specified time has elapsed after the unit entered auto sleep after placing the handle on the handle holder.

The time until the auto shutoff function operates can be set in **!8** : Auto shutoff time setting".

**0** : Auto shutoff is disabled.

**!** : Auto shutoff is enabled.

**18****Auto shutoff time setting**

This function operates when the Auto shutoff enable/disable setting is set to **!** (enabled).

When the set time has elapsed without action after placing the handle on the handle holder, the auto shutoff function will operate. The output will become zero and the unit will enter standby mode.

Display: **---** is lit.

**!** ~ **30** : Auto shutoff is enabled. (The set time shows the time when the auto shutoff function will operate after sleeping.)

The auto shutoff time can be set in increments of 1 min. (The initial default set time is 15 min. and the maximum time is 30 min.)

Ex) Auto sleep is set to 10 min. and auto shutoff is 20 min.

When the handle is placed on the handle holder

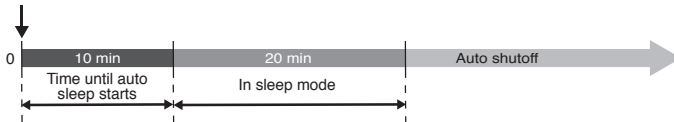
**CAUTION**

\* Do not leave the unit in the auto shutoff mode for a long time. If the unit will not be used for a long time, be sure to switch off the power.

**NOTE:**

The auto shutoff function does not work when the handle is not placed on the handle holder. If the auto shutoff function operates, switch the power off once and then switch it back on to start using the unit again.

## 7. MAINTENANCE

The unit should be maintained periodically to be able to use it in proper condition for a long time. Since the degree of consumption of the unit varies depending on the use temperature, etc., perform maintenance of the unit according to use conditions.

### ⚠ WARNING

Since the soldering iron can reach a very high temperature, please work carefully. Except for special cases, always turn the power switch OFF and disconnect the power plug before performing any maintenance procedure.

#### About blades

##### ① Maintenance

Although blades are designed to resist oxidation, if oxidation of the blades occurs and prevents you to do wire-stripping work smoothly, use a wire brush lightly on the blade to remove the oxide. Applying a wire brush strongly may damage the blades, resulting in reduced service life. Therefore, do not brush blades excessively.

##### ② Suspension during use

Leaving the unit in a no-load condition for a long time with the blade heated highly may cause the surface to be oxidized, resulting in reduced service life of blades due to overload applied to the heating element.

Be sure to enable auto sleep and place the handle on the handle holder when not using it.

Be sure to switch off the power switch if the unit will not be used for a long time.

## 8. INSPECTION

### ⚠ WARNING

Unless otherwise specified, be sure to switch off the power and unplug the power plug when performing the following procedures.

##### ① Blown heating element

Measure the resistance of this section of the heating element.

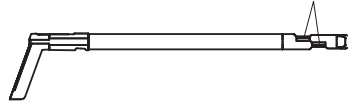

Check that no electrical abnormality occurs in the heating element.

Measure the resistance at normal temperature (15 to 25°C).

The normal value is  $3.5\Omega \pm 10\%$ . If the measured resistance value is abnormal, replace the blade with a new one.

##### ② How to check whether the connection cord is connected or disconnected

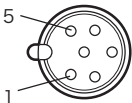

Attach normal blades (whose resistance value of heating elements is normal) to both handles and measure the resistance value between the connector pins.

#### Resistance between Pin 1 and Pin 5: $6.2\Omega$ to $8.0\Omega$

If the resistance value is outside the above value range, replace the HAKKO FT-8004 with a new one.

##### ③ How to replace the fuse

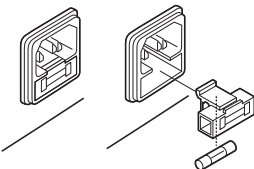

1. Unplug the power cord from the inlet.

2. Pull out the fuse holder.



3. Replace the current fuse with a new one.

4. Reassemble the fuse holder to its original condition.

## 9. TROUBLESHOOTING

### WARNING

- Be sure to unplug the power cord before repairing. Failure to do so may cause an electric shock.

Phenomenon	Check	Actions
The unit does not work even when the power is switched on.	Is the power cord or the connection plug disconnected?	Connect the power cord and connection cord.
	Is the fuse blown?	Check for factors causing the fuse to be blown and replace the fuse with a new one. If the replaced fuse blows again, please request repair.
 blinks.	Are the blades inserted fully?	Insert the blade fully to the end.
	Is the connection cord disconnected? Is the heating element blown?	Refer to the items in disconnection of connection cord and blowing of heating element.
 is displayed.		Switch the power off and on again. If the same phenomenon occurs even after switching the power off and on again, please request repair.

## 10. PART NUMBER

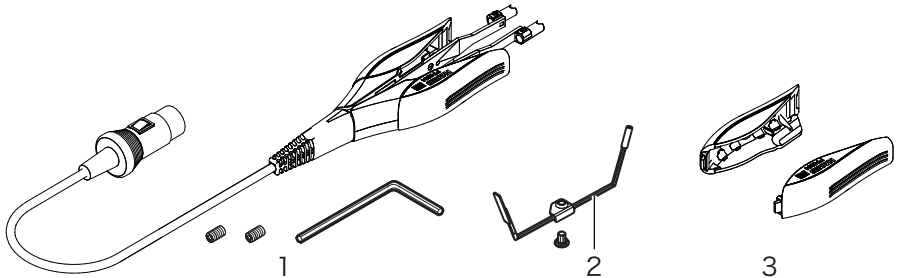

### ● Handle

Item No.	Part No.	Part name	Specifications
1	FT8004-81	HAKKO FT-8004	with Hexagon socket set screws and Hexagon wrench
2	B5242	Lead adjuster w/o-ring,screw,stopper	
3	B5243	Sleeve assembly	

## 10. PART NUMBER (continued)

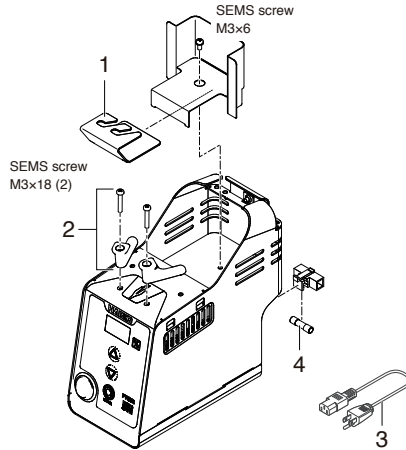

### ● Station

Item No.	Part No.	Part name	Specifications
1	B5244	Blade removal plate w/screw	
2	B5245	Handle holder w/SEMS screw M3x18 Qty 2	for HAKKO FT-802
3	B2387	Power cord/3 core & American plug	
	B2419	Power cord/3 core & American plug	
	B2421	Power cord/3 cored wire with no plug	
	B2422	Power cord/3 core & BS plug	
	B2424	Power cord/3 core & European plug	
	B2436	Power cord/3 core & Chinese plug	
4	B3550	Power cord/3 core & SI plug	
	B3011	Fuse/250V-2A	100-127V
	B2987	Fuse/250V-1A	220-240V

1

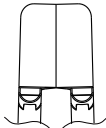

2

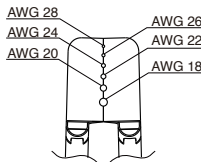

3

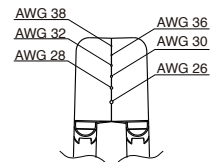

### ● Blade

Item No.	Part No.	Part name	Specifications
1	G4-1601	Wire stripper blade/Straight	
2	G4-1602	Wire stripper blade/18-28AWG	
3	G4-1603	Wire stripper blade/26-38AWG	



**HAKKO CORPORATION**

**HEAD OFFICE**

4-5, Shiokusa 2-chome, Naniwa-ku, Osaka 556-0024 JAPAN  
 TEL: +81-6-6561-3225 FAX: +81-6-6561-8466  
<http://www.hakko.com> E-mail: sales@hakko.com

**OVERSEAS AFFILIATES**

**U.S.A.: AMERICAN HAKKO PRODUCTS, INC.**  
 TEL: (661) 294-0090 FAX: (661) 294-0096  
 Toll Free (800)98-HAKKO  
<http://www.hakko.com>

**HONG KONG: HAKKO DEVELOPMENT CO., LTD.**  
 TEL: 2811-5588 FAX: 2590-0217  
<http://www.hakko.com.hk>

E-mail: info@hakko.com.hk

**SINGAPORE: HAKKO PRODUCTS PTE., LTD.**  
 TEL: 6748-2277 FAX: 6744-0033  
<http://www.hakko.com.sg>

E-mail: sales@hakko.com.sg

Please access to the following address for the other Sales affiliates.

<http://www.hakko.com>