

DESOLDERING TOOL

FR-410

Instruction Manual

(HAKKO FR-4104)



Thank you for purchasing the HAKKO FR-410 Desoldering Tool.
This product is a desoldering tool that uses the quick-change mechanism.
Please read this manual before operating the HAKKO FR-410.
Keep this manual readily accessible for reference.



Table of Contents

- 1. PACKING LIST AND PART NAMES 1
- 2. SPECIFICATIONS 1
- 3. WARNINGS, CAUTIONS AND NOTES 2
- 4. INITIAL SETUP 3
- 5. OPERATION 4
- 6. PARAMETER SETTING 13
- 7. MAINTENANCE 22
- 8. CHECKING PROCEDURE 27
- 9. ERROR MESSAGE 29
- 10. TROUBLE SHOOTING GUIDE 30
- 11. PARTS LIST 31
- 12. WIRING DIAGRAM 34

1. PACKING LIST AND PART NAMES

Please check to make sure that all items listed below are included in the package.

HAKKO FR-410 station	1	HAKKO FH-410 iron holder	
HAKKO FR-4104 handpiece		(with cleaning sponge)	1
(with N61-05 (ø1.0 mm [0.04 in] type S) nozzle).....	1	Tool box	1
Power cord	1	Instruction Manual	1

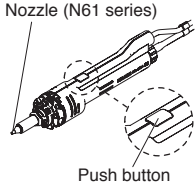

HAKKO FR-4104

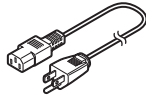

Power cord



HAKKO
FR-410

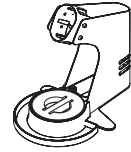

HAKKO FH-410

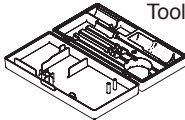

Tool box



x4

Ceramic paper Filter
(for handpiece)



x2

Filter
(for station)



x1

Cleaning Pin (for ø1.0 mm
[0.04 in] nozzle)



x1

Cleaning Drill (for ø1.0 mm
[0.04 in] nozzle)



x1

Cleaning Pin
(for heating element)



x1

Nozzle wrench

2. SPECIFICATIONS

● HAKKO FR-410

Power consumption	190 W
Temperature range	330 - 450°C (620 - 850°F)
Temperature stability	±5°C (±9°F) at idle temperature

● Station

Output	AC 24 V
Vacuum generator	Vacuum pump, double cylinder type
Vacuum pressure (max.)	80 kPa (600 mmHg)
Suction flow	15 L/min.
Dimensions	165 (W) × 137 (H) × 244 (D) mm (6.5 × 5.4 × 9.6 in.)
Weight	4.8 kg (10.6 lb.)

● Handpiece (HAKKO FR-4104)

Part name	HAKKO FR-4104
Power consumption	140 W (24 V)
Nozzle to ground resistance	<2 Ω
Nozzle to ground potential	<2 mV
Cord	1.2 m (4 ft.)
Length (w/o cord)	206 mm (8.1 in.) with N61-05 nozzle
Weight (w/o cord)	180 g (0.4 lb.) with N61-05 nozzle

- * The temperature was measured using the HAKKO FG-101 Soldering Tester.
- * This product is protected against electrostatic discharge.
- * Specifications and design are subject to change without notice.

⚠ CAUTION

■ Electrostatic Protection

This product includes such features as electrically conductive plastic parts and grounding of the handpiece and station as measures to protect the device to be soldered from the effects of static electricity. Be sure to observe the following instructions:

1. The handle and other plastic parts are not insulators, they are conductors. When replacing parts or repairing, take sufficient care not to expose live electrical parts or damage insulation materials.
2. Be sure to ground the unit during use.

3. WARNINGS, CAUTIONS AND NOTES

Warnings, cautions and notes are placed at critical points in this manual to direct the operator's attention to significant items. They are defined as follows:

⚠ WARNING : Failure to comply with a WARNING may result in serious injury or death.

⚠ CAUTION : Failure to comply with a CAUTION may result in injury to the operator, or damage to the items involved.

NOTE : A NOTE indicates a procedure or point that is important to the process being described.

⚠ WARNING

When power is ON, the nozzle will be hot. To avoid injury or damage to personnel and items in the work area, observe the following:

- Do not touch the nozzle or the metal parts near the nozzle.
- Do not allow the nozzle to come close to, or touch, flammable materials.
- Inform others in the area that the unit is hot and should not be touched.
- Turn the power off when not in use, or left unattended.
- Turn the power off when changing parts or storing the HAKKO FR-410.
- This unit is for counter or workbench use only.
- This appliance can be used by children aged from 8 years and above and persons with reduced physical, sensory or mental capabilities or lack of experience and knowledge if they have been given supervision or instruction concerning use of the appliance in safe way and understand the hazards involved.
- Children shall not play with the appliance.
- Cleaning and user maintenance shall not be made by children without supervision.

To prevent accidents or damage to the HAKKO FR-410, be sure to observe the following:

⚠ CAUTION

- Do not use the unit for applications other than desoldering.
- Do not strike the handpiece against hard objects to remove excess solder. This will damage the handpiece.
- Do not modify the HAKKO FR-410.
- Use only genuine HAKKO replacement parts.
- Do not allow the HAKKO FR-410 to become wet, or use it when hands are wet.
- Be sure to hold the plug when inserting or removing the handpiece and power cords.
- Be sure the work area is well ventilated. Desoldering produces smoke.
- While using the HAKKO FR-410, don't do anything which may cause bodily harm or physical damage.

4. INITIAL SETUP

A. Iron holder

Loosen the adjusting screws to change the angle of the handpiece receptacle as you like, then tighten the screws.

⚠ CAUTION

Increasing the angle of the handpiece receptacle will cause an increase in the handpiece temperature.

● Setup the iron holder

Following the instructions given in the illustration on the right, assemble the iron holder.

NOTE :

You can put nozzles that are not in use on the radial tray of the cleaner base.

● How to use the cleaning sponge

The sponge is compressed. It will swell when moistened with water. Before using the unit, dampen the sponge with water and squeeze it to remove excess water.

1. Fit the small sponge pieces into the hollows in the cleaner base.
2. Add an appropriate amount of water into the cleaner base. The small sponge pieces will absorb water and help keep the larger sponge damp at all times.
3. Dampen the large sponge, squeeze it to remove excess water and put it on the cleaner base.

⚠ CAUTION

Be sure the sponge is moistened with water before use to avoid damaging the nozzle.

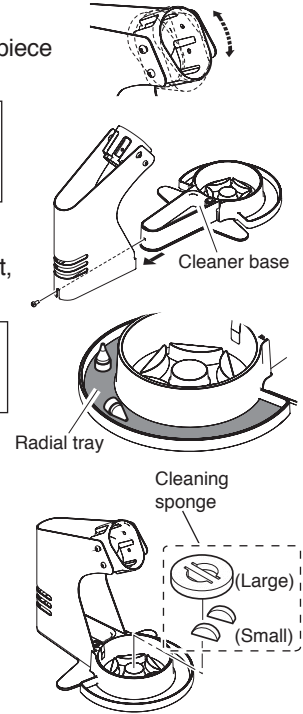

B. HAKKO FR-4104

● Attach the filter pipe

Insert the filter pipe (with a filter holder, spring filter and ceramic paper filter) into the housing. Push and turn the back holder clockwise.

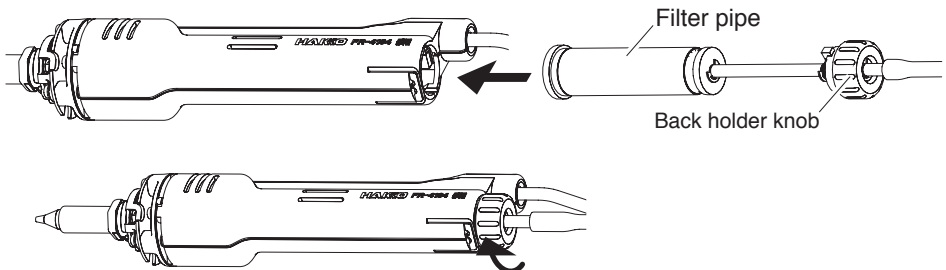

C. Station

⚠ CAUTION

Be sure to hold the plug when inserting or removing the handpiece cord.

● Connection

1. Connect the power cord to the receptacle on the rear of the station.
2. Connect the plug from the HAKKO FR-4104 to the receptacle on the HAKKO FR-410.

⚠ CAUTION

Connect the plug to the receptacle, aligning the tab on the plug with the opening on the receptacle.

Insert the plug into the receptacle until it seats.

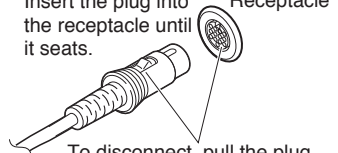

To disconnect, pull the plug from the receptacle while pressing down the tab on the plug.

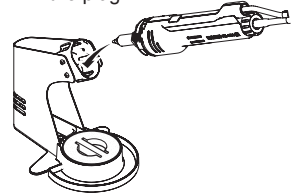

3. Set the HAKKO FR-4104 in the iron holder.
4. Connect the hose from the HAKKO FR-4104 to the vacuum outlet cap on the HAKKO FR-410 station.
5. Plug the power cord into a grounded power outlet. Ensure that the power switch is OFF before plugging in the power cord.

⚠ CAUTION

Be sure to ground this product as it is ESD safe by design.

Connect the hose.

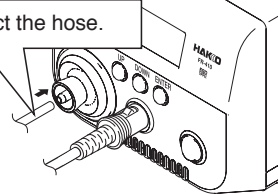

6. Turn the power switch ON.

⚠ CAUTION

When not in use, place the handpiece in the iron holder.

Turn the power switch ON.

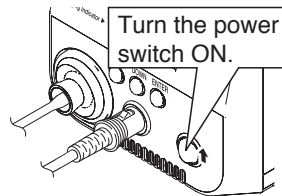

5. OPERATION

PART NAMES

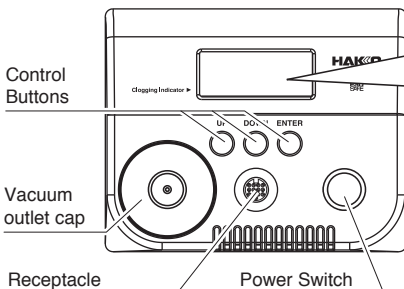

Normal display screen

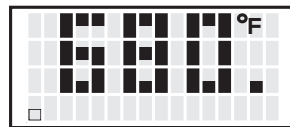

The HAKKO FR-410 has three controls

- UP - Moving the cursor UP. Increases the value.
- DOWN - Moving the cursor DOWN. Decreases the value.
- ENTER - End of sequence (terminates a phase of a data entry mode).

5. OPERATION (continued)

A. Desoldering

⚠ CAUTION

If the pump does not operate, immediately clean the nozzle & heating element and replace the filter if necessary.

1. Place the nozzle over the lead wire of the part to be desoldered and begin heating.

Be careful to heat the lead wire and the solder, not the land. Placing the nozzle directly in contact with the land may cause the land to peel off. You may apply a small amount of solder to form a heat bridge to help the heating process.

2. Check to make sure all of the solder on the joint has melted.

With the nozzle still in place over the lead wire, slowly move the lead wire, being careful not to apply too much force. If the lead wire moves easily, all of the solder has melted.

3. Pull the trigger to remove the melted solder.

⚠ CAUTION

Make sure that a filter has been inserted in the desoldering tool. Desoldering without a filter may damage the pump.

4. If the solder was not removed, re-solder the part using new solder and then repeat the desoldering process.

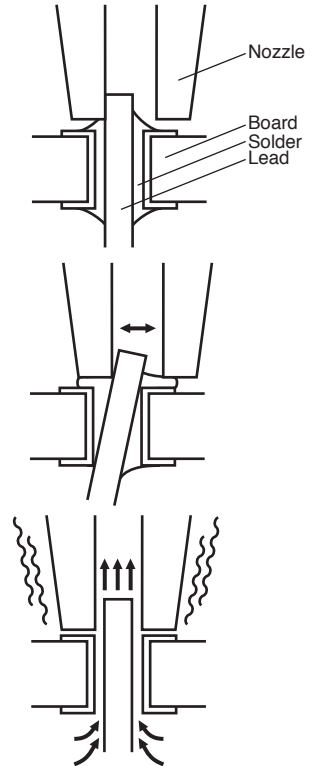

● When triggering before the heater reaches set temperature

When triggering before the heater reaches set temperature, the display screen shows "HEATING. . . PLEASE WAIT" and the vacuum does not work. Please wait for the heater to reach the set temperature.

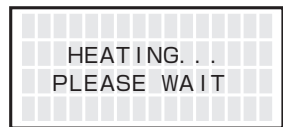

B. Making Changes to Settings

● Selecting the preset number

When changing the temperature, there is a preset function to manually set the temperature.

1. Press any of the three control buttons.

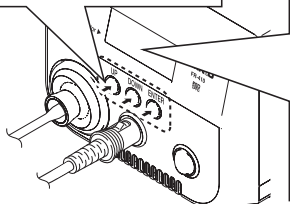

2. The preset selection screen appears.

▶PRESET1	660°F	
PRESET2	750°F	
PRESET3	840°F	
<↑>	<↓>	<ENT>

3. Move the cursor UP or DOWN by pressing the corresponding buttons.

▶PRESET1	660°F
PRESET2	750°F
PRESET3	840°F
<↑>	<↓>
<ENT>	

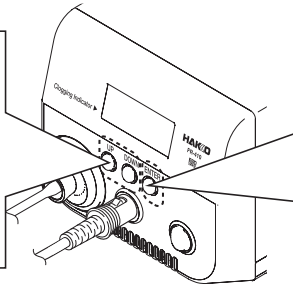

4. Press the <ENT> button to finalize your selection.

▶PRESET1	660°F
PRESET2	750°F
PRESET3	840°F
<↑>	<↓>
<ENT>	

If you wish to exit the PRESET SELECTION screen...

Scroll the cursor to the bottom, select <EXIT>, and press the <ENT> button. You will return to the normal display without making any changes.

Or if the device is left alone without making any operation for 10 seconds, you will return to the normal display.

When changing the current set temperature or the preset temperature, follow the operation of “● Changing various setting (other than preset selections)”.

● Changing various settings (other than preset selections)

1. Press and hold any one of the three control buttons for at least 2 seconds.

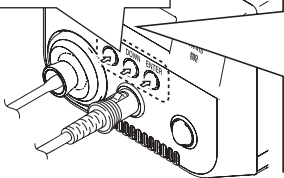

2. The setting selection screen appears.

▶Set Temp	680° F
OffsetTemp	00° F
Vacuum Check	
<↑>	<↓>
<ENT>	

The following settings can be changed from this screen:

- **Set Temp** (Nozzle temperature setting)
- **Offset Temp** (Nozzle temperature offset setting)
- **Vacuum Check** (Check of nozzle clogging and suction force)
- **Preset Temp** (Setting of each preset temperature)
- **Preset ID** (Setting of each preset name)
- **LCD Contrast** (Contrast adjustment of display screen)
- **<EXIT>** (Return to the normal display)

3. Move the cursor UP or DOWN by pressing the corresponding buttons.

▶Set Temp	680° F
OffsetTemp	00° F
Vacuum Check	
<↑>	<↓>
<ENT>	

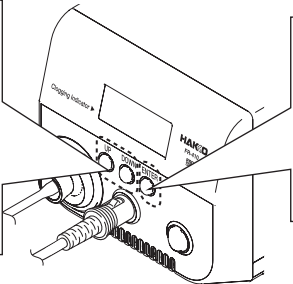

4. Press the <ENT> button to finalize your selection.

▶Set Temp	680° F
OffsetTemp	00° F
Vacuum Check	
<↑>	<↓>
<ENT>	

5. OPERATION (continued)

● Set Temp (Nozzle temperature setting)

⚠ CAUTION

The temperature range is from 620 to 850°F. (330 to 450°C)
If you enter a value outside the temperature setting range, the display returns to the hundreds digit, and you have to enter a correct value.

1. Move the cursor to select "Set Temp". After selecting, press <ENT>.

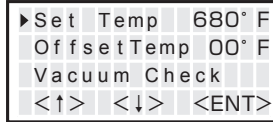

2. Entering from hundreds to units digit

Press the <↑> or <↓> to set the desired figure.

Press the <ENT> button to advance to the next digit.

Only values from 6 to 8 can be selected when entering the hundreds digit.

(In °C mode, values from 3 to 4 can be selected.)

Values from 0 to 9 can be selected when entering the tens or units digits.

(The same values can be selected in °C mode.)

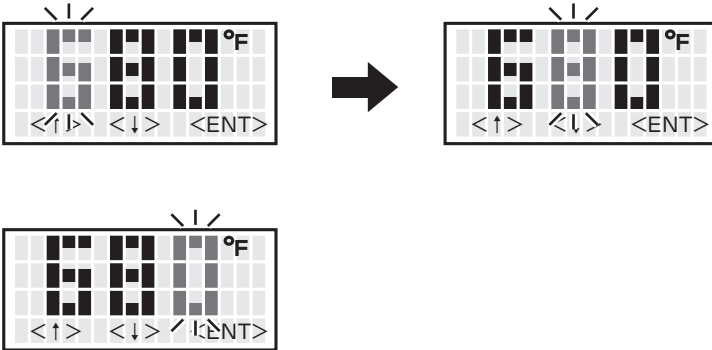

3. When desired figure is displayed, press the button to enter.

The next digit will begin to flash. After entering the units digit, press the button to save the figure to the system memory and begin heater control with new setting temperature.

⚠ CAUTION

If power is switched off or lost during the execution of this procedure, no data will be entered. The entire procedure must be repeated from step 1.

● **Offset Temp** (Nozzle temperature offset setting)

Example : If the measured temperature is 705°F and set temperature is 700°F, the difference is -5°F. (need to decrease by 5°F) So, enter the figure which 5 is deducted from present offset value.

CAUTION

The allowable ranges for offset values are from -90 to +90°F. (In °C mode, from -50 to +50°C) If you enter a value outside the offset value range, the display returns to the hundreds digit, and you have to enter a correct value.

1. Move the cursor to select "OffsetTemp". After selecting, press <ENT>.

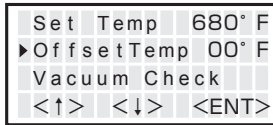

2. Enter the offset value (-05) which is the difference between tip temperature and set temperature.
Press the <↑> or <↓> to set the desired figure.
Press the <ENT> button to advance to the next digit.

The hundreds digit can display 0 (for positive value) or minus sign. (for negative value)
(Same values can be selected in °C mode.)
Values from 0 to 9 can be selected when entering the ten digit.
(In °C mode, values from 0 to 5 can be selected.)
Values from 0 to 9 can be selected when entering the units digit.
(Same values can be selected in °C mode.)

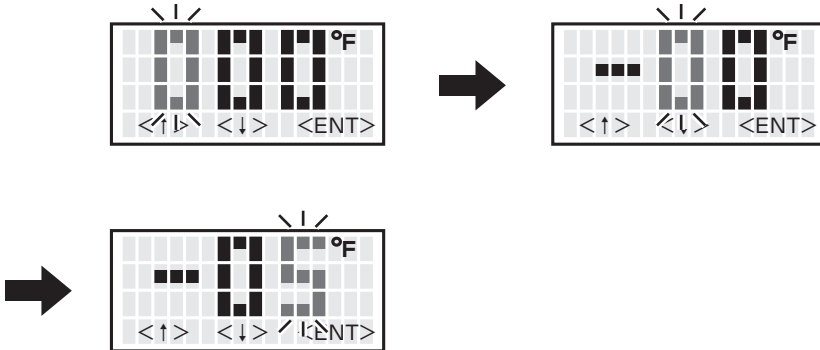

3. After entering the units digit, press the button to save the figure to the system memory and begin heater control with the new offset value.

CAUTION

During the offset setting, please be careful tip temperature does not exceed 850°F.

5. OPERATION (continued)

● Vacuum Check (Check of nozzle clogging and suction force)

During suction, the gauge indicating sucking status is shown at the lower side of the screen.

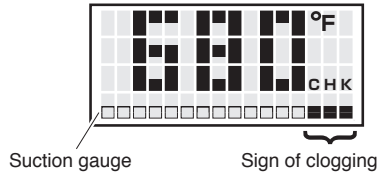

When “CHK” appears and you notice that the sucking force is weakening, perform “Vacuum Check”.

1. Move the cursor to select “Vacuum Check”. After selecting, press <ENT>.

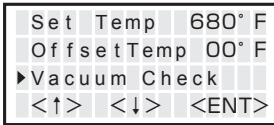

2. Pull the trigger.

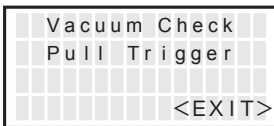

3. When “Clogging” appears, perform cleaning and replace filters.

No degradation in sucking force

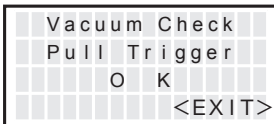

Degradation in sucking force

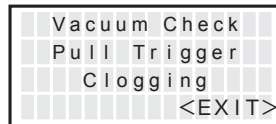

4. Select <EXIT>, and press the <ENT> button to return to the selection screen.

● **Preset Temp** (Setting of each preset temperature)

CAUTION

The temperature range is from 620 to 850°F. (330 to 450°C)
 If you enter a value outside the temperature setting range, the display returns to the hundreds digit, and you have to enter a correct value.

1. Move the cursor to select "Preset Temp". After selecting, press <ENT>. Select the preset No. whose temperature setting you wish to change.

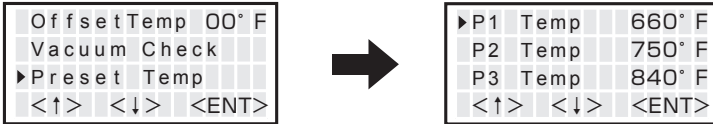

2. Entering from hundreds to units digit
 Press the <↑> or <↓> to set the desired figure.
 Press the <ENT> button to advance to the next digit.

Only values from 6 to 8 can be selected when entering the hundreds digit.
 (In °C mode, values from 3 to 4 can be selected.)
 Values from 0 to 9 can be selected when entering the tens or units digits.
 (The same values can be selected in °C mode.)

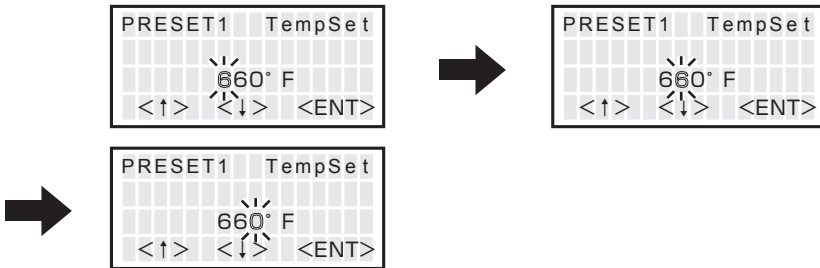

3. After entering the units digit, press the button to save the figure to the system memory and begin heater control with new setting temperature.

CAUTION

If power is switched off or lost during the execution of this procedure, no data will be entered. The entire procedure must be repeated from step 1.

4. To exit from each setting screen, scroll the screen, select <EXIT>, and press the <ENT> button.

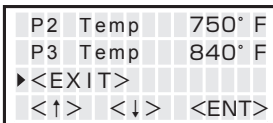

5. OPERATION (continued)

● Preset ID (Setting of each preset name)

CAUTION

As a preset ID, 1 to 8 characters can be used.

Usable characters are "A - Z", "0 - 9", and space (" "). Entering a space makes your entry terminated. Any character(s) that follows the space is deleted.

1. Move the cursor to select "Preset ID". After selecting, press <ENT>.

V	a	c	u	u		C	h	e	c	k		
P	r	e	s	e	t		T	e	m	p		
▶	P	r	e	s	e	t		I	D			
<	↑	>	<	↓	>	<	E	N	T	>		

2. Move up and down the cursor with the control buttons.
After selecting, press <ENT>.

▶	P	1		I	D		P	R	E	S	E	T	1
	P	2		I	D		P	R	E	S	E	T	2
	P	3		I	D		P	R	E	S	E	T	3
<	↑	>	<	↓	>	<	E	N	T	>			

3. Press the <↑> or <↓> to set the desired figure.
Press the <ENT> button to advance to the next digit.

P	1		I	D					S	E	T	
<	↑	>	<	↓	>	<	E	N	T	>		

4. To exit from setting screen, scroll the screen, select <EXIT>, and press the <ENT> button.

	P	2		I	D		P	R	E	S	E	T	2
	P	3		I	D		P	R	E	S	E	T	3
▶	<	E	X	I	T	>							
<	↑	>	<	↓	>	<	E	N	T	>			

● **LCD Contrast** (Contrast adjustment of display screen)

To make the screen display easy to see, adjust contrast.

1. Move the cursor to select "LCD Contrast". After selecting, press <ENT>.

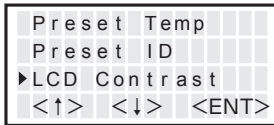

2. Press the <↑> or <↓> to set the adjust contrast.
(Selection range is 1 to 25.)

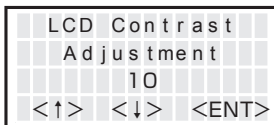

3. After selecting the value, press <ENT> to return to the selection screen.

To exit from each setting screen, scroll the screen, select <EXIT>, and press the <ENT> button.

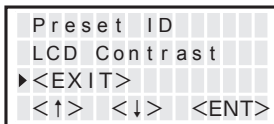

6. PARAMETER SETTING

● PARAMETER SETTINGS

Press and hold any one of the three control buttons, and turn on the power switch to display the parameter setting screen. The following parameters can be set:

Parameter name	Value	Initial value
Temp Mode	°C / °F	°F*
ShutOff Set	OFF / ON	OFF
Timer**	30 to 60 min.	30 min.
Vacuum Mode	Normal / Timer	Normal
Vacuum Time***	1 to 5 sec.	1 sec.
Auto Sleep	OFF / ON	ON
Timer**	1 to 29 min.	6 min.
Sleep Temp	390 to 570°F (200 to 300°C)	390°F (200°C)
Low Temp	54 to 270°F (30 to 150°C)	270°F (150°C)
Error Alarm	ON / OFF	ON
Ready Alarm	ON / OFF	ON
Pass. Lock	ON (Lock / Partial) / OFF (Unlock)	OFF
Password****	“ABCDEF” Select three letters	-
Initial Reset	°C / °F / Cancel	

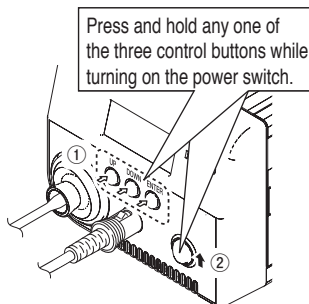

* For USA.

** Timer can be set when ShutOff / Auto Sleep is set to “ON”.

*** Vacuum Time is displayed when Vacuum Mode is set to “Timer”.

**** Password is displayed when Password Lock is set to “Lock” or “Partial”.

※ 各言語（日本語、英語、中国語、フランス語、ドイツ語、韓国語）の取扱説明書は以下のURL、HAKKO Document Portalからダウンロードしてご覧いただけます。

（商品によっては設定の無い言語がありますが、ご了承ください）

* 各國語言(日語,英語,中文,法語,德語,韓語)的使用說明書可以通過以下網站的HAKKO Document Portal 下載參閱。
（有一部分的產品沒有設定外語對應,請見諒）

* Instruction manual in the language of Japanese, English, Chinese, French, German, and Korean can be downloaded from the HAKKO Document Portal.
(Please note that some languages may not be available depending on the product.)



<https://doc.hakko.com>

● Temp Mode

Select the temperature mode from Celsius or Fahrenheit.

1. Move the cursor to select "Temp Mode".

After selecting, press <ENT>.

2. °C and °F will be switched alternately if you press the <↑> or <↓> button.

3. Return to parameter setting display if you press the <ENT> button after setting.

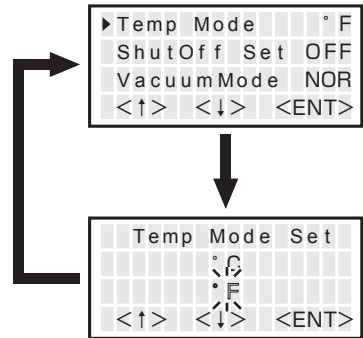

● ShutOff Set

Select whether you will activate the auto shutoff function. When the auto shutoff function is set to on and no operation is performed for constant time after the handpiece is set in the iron holder, the buzzer sounds three times and the auto shutoff function will be enabled.

1. Move the cursor to select "ShutOff Set".

After selecting, press <ENT>.

2. ON and OFF will be switched alternately if you press the <↑> or <↓> button.

3. Selecting "ON" allows you to make the setting for "Timer".

(Default is 30 minutes.)

4. When setting "Shut Off" to "ON", the area for "Timer" flashes.

5. Press the <↑> or <↓> to set the desired figure.

6. Pressing the <ENT> button after this change makes the set time stored in the internal memory.

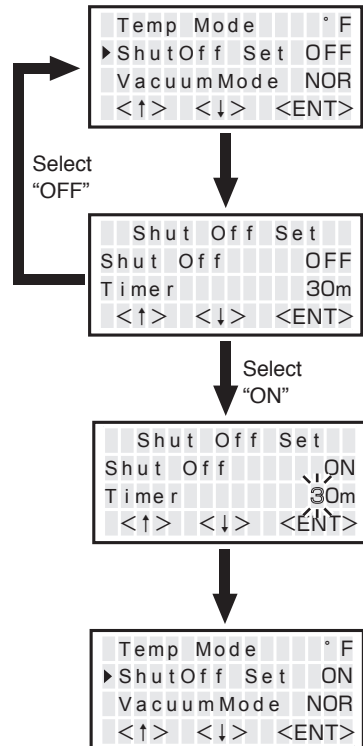

6. PARAMETER SETTING (continued)

● Vacuum Mode

Select whether you manually operate the desoldering pump or use the timer function.

Normal : Solder is sucked only when you are pulling the trigger.

Timer : Even after you release the trigger, sucking continues for the specified period of time.

* Set time in "Vacuum Time".

1. Move the cursor to select "VacuumMode".
After selecting, press <ENT>.

2. Normal and Timer will be switched alternately if you press the <↑> or <↓> button.

3. Return to parameter setting display if you press the <ENT> button after setting.

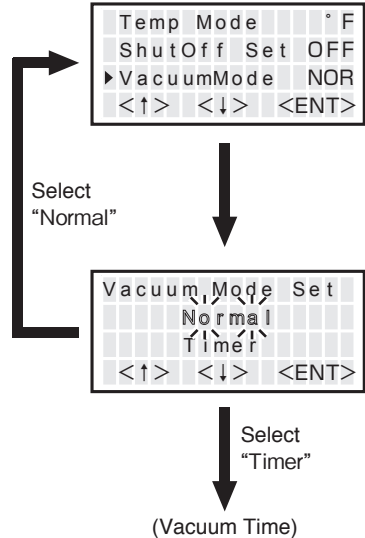

* When selecting "Timer"

"Vacuum Time" appears under "VacuumMode" in the parameter select screen.

● Vacuum Time

1. Move the cursor to select "Vacuum Time".
After selecting, press <ENT>.

2. Press the <↑> or <↓> button, you can change to the desired value.

3. Return to parameter setting display if you press the <ENT> button after setting.

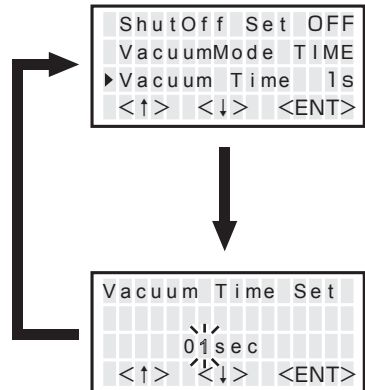

● Auto Sleep

Select whether you will activate the auto sleep function. When the auto sleep function is set to on and no operation is performed for constant time after the handpiece is set in the iron holder, the auto sleep function will be enabled and the temperature of the handpiece declines to the controlled degree.

* The auto sleep temperature can be set in "Sleep Temp".

1. Move the cursor to select "Auto Sleep".
After selecting, press <ENT>.

ShutOff	Set	OFF
VacuumMode		NOR
▶Auto	Sleep	OFF
<↑>	<↓>	<ENT>

2. ON and OFF will be switched alternately if you press the <↑> or <↓> button.



Auto	Sleep	Set
Auto	Sleep	OFF
Timer		06m
<↑>	<↓>	<ENT>

3. Selecting "ON" allows you to make the setting for "Timer".
(Default is 6 minutes.)

Select
"ON"

* When selecting "ON"

4. When setting "Auto Sleep" to "ON",
the area for Timer flashes.

Auto	Sleep	Set
Auto	Sleep	ON
Timer		06m
<↑>	<↓>	<ENT>

5. Press the <↑> or <↓> button, you can
change to the desired value.

6. Pressing the <ENT> button after this change
makes the set time stored in the internal
memory.

ShutOff	Set	OFF
VacuumMode		NOR
▶Auto	Sleep	06m
<↑>	<↓>	<ENT>

6. PARAMETER SETTING (continued)

● Sleep Temp

Set the auto sleep temperature.

1. Move the cursor to select "SleepTemp".
After selecting, press <ENT>.
2. Entering from hundreds to units digit.
Press the <↑> or <↓> to set the desired figure.
Press the <ENT> button to advance to the next digit.

Only values from 3 to 5 can be selected when entering the hundreds digit.

(In °C mode, values from 2 to 3 can be selected.)

Values from 0 to 9 can be selected when entering the tens or units digits.

(The same values can be selected in °C mode.)

3. After entering the units digit, press the button to save the figure to the system memory.

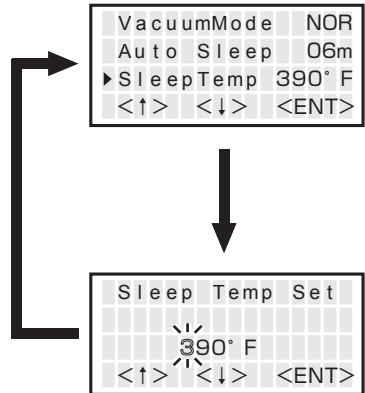

● Low Temp

When the temperature drops below a set limit, an error is displayed and the buzzer sounds.

1. Move the cursor to select "Low Temp".
After selecting, press <ENT>.
2. Entering from hundreds to units digit.
Press the <↑> or <↓> to set the desired figure.
Press the <ENT> button to advance to the next digit.

Only values from 0 to 2 can be selected when entering the hundreds digit.

(In °C mode, values from 0 to 1 can be selected.)

Values from 0 to 9 can be selected when entering the tens or units digits.

(The same values can be selected in °C mode.)

3. After entering the units digit, press the button to save the figure to the system memory.

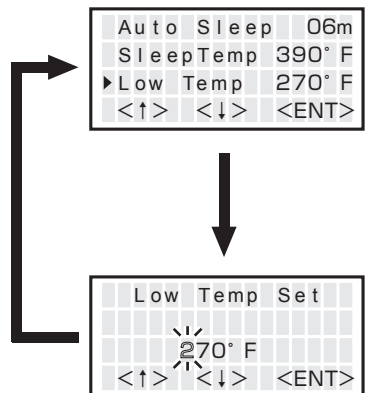

● Error Alarm

In the buzzer sound setting mode, which sets whether to sound the buzzer when a error occurs.

1. Move the cursor to select "Error Alarm".
After selecting, press <ENT>.
2. ON and OFF will be switched alternately if you press the <↑> or <↓> button.
3. Return to parameter setting display if you press the <ENT> button after setting.

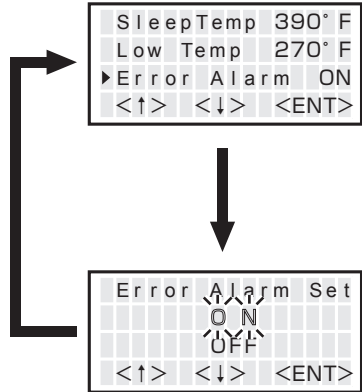

● Ready Alarm

When the set temperature alert setting mode is on, the buzzer sounds if you reached the usable temperature.

1. Move the cursor to select "Ready Alarm".
After selecting, press <ENT>.
2. ON and OFF will be switched alternately if you press the <↑> or <↓> button.
3. Return to parameter setting display if you press the <ENT> button after setting.

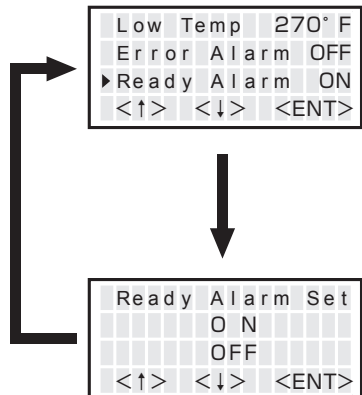

6. PARAMETER SETTING (continued)

● Pass. Lock

Set a password and use this function to restrict the following changes.

⚠ CAUTION

The correct password must be entered to make the change.

Lock : All setting changes require a password entry.

Partial : Select whether or not to enter your password for set temperature/preset selection/offset temperature change. Other procedures require password entry.

Unlock : Any setting change does not require a password entry.

1. Move the cursor to select "Pass. Lock".
After selecting, press <ENT>.

2. Using the <↑> or <↓> button, select an option from "Lock", "Partial", and "Unlock".

* When selecting "Partial" or "Lock"

3. Select Lock ON/OFF for set temperature/preset selection/offset temperature change.
(Only when selecting "Partial")

4. After making all selections, using the <↑> or <↓> button, select an option from "OK" or "Cancel". (Only when selecting "Partial")

5. Press the <ENT> button.
(Only when selecting "Partial")

6. Using the <↑> or <↓> button, enter a password. (Selection of three characters from ABCDEF)

7. After entering, press the <ENT> button.
Select "OK" or "Cancel" using the <↑> or <↓> button.

8. After setting the password, press the <ENT> button to return to the parameter setting screen.

* When selecting "OK"

The password is shown under "Pass. Lock" on the parameter selection screen.

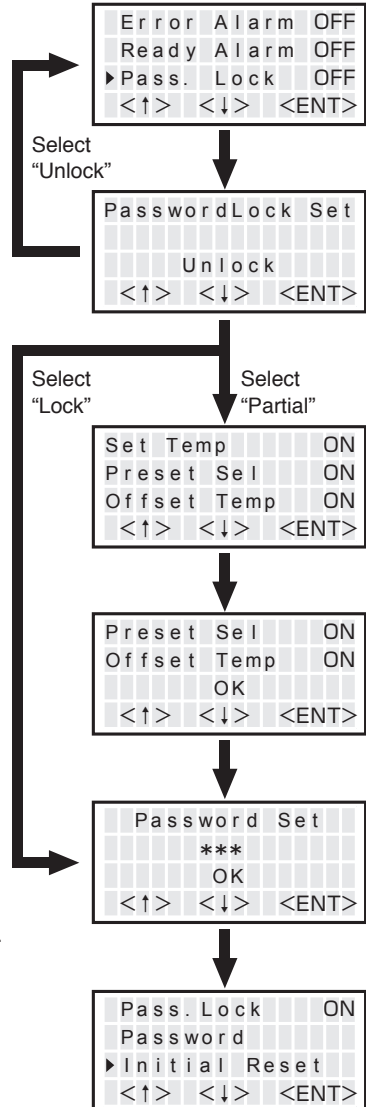

● Password

The password can be changed.

1. Match ► to “Password” and press the <ENT> button.

Pass. Lock	ON	
Pass word		
► Initial Reset		
<↑>	<↓>	<ENT>

2. Use the <↑> or <↓> button to enter the current password, and press the <ENT> button.

Input Password		
A**		
<↑>	<↓>	<ENT>

3. Enter a new password.
(For a password, select 3 letters from among ABCDEF.)

Password Set		

OK		
<↑>	<↓>	<ENT>

4. After setting the password, press the <ENT> button.
Using the <↑> or <↓> button, select either “OK” or “Cancel”.

Password Set		

OK		
<↑>	<↓>	<ENT>

5. Press the <ENT> button to return to the parameter selection screen.

Ready Alarm	ON	
Pass. Lock	ON	
► Password		
<↑>	<↓>	<ENT>

6. PARAMETER SETTING (continued)

● Initial Reset

Initial Reset allows the factory default settings to be restored.

1. Move the cursor to select "Initial Reset".

After selecting, press <ENT>.

Ready	Alarm	OFF
Pass.	Lock	OFF
▶ Initial	Reset	
<↑>	<↓>	<ENT>

2. Using the <↑> or <↓> button, select either "°C" or "°F". To stop "Initial Reset", scroll the screen to select <EXIT>.

Initial	Reset	
	°C	
<↑>	<↓>	<ENT>

3. After selecting it, using the <↑> or <↓> button, select "OK" or "Cancel".

Initial	Reset	
	°F	
	OK	
<↑>	<↓>	<ENT>

⚠ CAUTION

Even when Initial Reset is finished, "Pass. Lock" and password settings remain.

⚠ CAUTION

To exit from the parameter setting display, scroll the screen, select <EXIT>, and press the <ENT> button.

Pass.	Lock	OFF
Initial	Reset	
▶ <EXIT>		
<↑>	<↓>	<ENT>

7. MAINTENANCE

Properly maintained, the HAKKO FR-410 desoldering tool should provide years of good service. Efficient desoldering depends upon the temperature, solder/flux selection, and proper routine maintenance. Perform the following service procedures as dictated by the conditions of the station's usage.

⚠ WARNING

Since the desoldering tool can reach a very high temperature, please work carefully. Except when cleaning the nozzle and heating element, ALWAYS turn the power switch OFF and disconnect the power plug before performing any maintenance procedure.

During suction, the gauge indicating suction force is shown at the bottom of the screen.

If "CHK" appears on the display, check the nozzle and heater for restrictions.

If the nozzle or heater are clogged, clean or replace them.

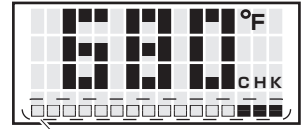

Suction gauge Sign of clogging

Replacing the filter pipe

Replace the filter pipe as shown following steps A to C. During operation, the filter pipe is very hot. Wait until the filter pipe is cool before replacing the filter or cleaning. We recommend keeping a second filter pipe containing new filters handy, and replacing the installed filter pipe with this secondary filter pipe.

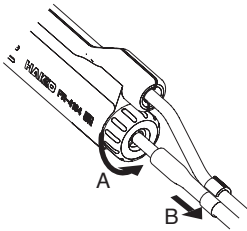

C. Replace the entire filter pipe with a secondary filter pipe.

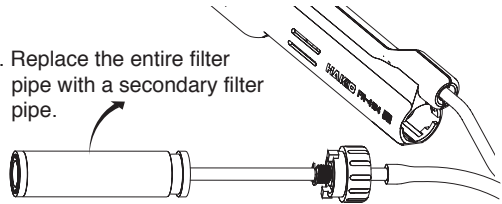

⚠ CAUTION

The section from the heating element to the filter pipe is provided with pipes through which melted solder passes, so it may become very hot. Be very careful when handling this section.

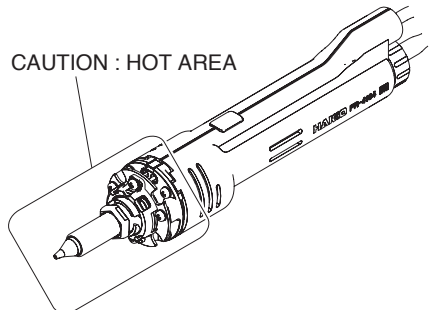

7. MAINTENANCE (continued)

Nozzle Maintenance

⚠ CAUTION

The handpiece may be extremely hot. During maintenance, please work carefully.

1. Inspect and clean the nozzle

Turn the power switch ON and let the nozzle heat up.

⚠ CAUTION

The cleaning pin will not pass through the nozzle until the solder inside the nozzle is completely melted.

- Clean out the hole of the nozzle with the nozzle cleaning pin.
- If the cleaning pin does not pass through the hole in the nozzle, clean with the cleaning drill.
- Check the condition of the solder plating on the nozzle tip.

⚠ CAUTION

- If the cleaning drill is forced into the nozzle, the drill bit could break or be damaged.
- Please use the proper size cleaning pin or cleaning drill for the nozzle diameter.

- Check visually if the nozzle was eroded.

Solder plating part



The solder plating is coming off.
The nozzle hole is eroded.



The caliber has expanded due to erosion.

Cleaning with the nozzle cleaning pin

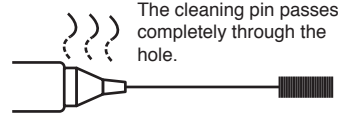

The cleaning pin passes completely through the hole.

Cleaning with the cleaning drill

- Before cleaning



Insert the bit while turning it clockwise.

- After cleaning



Pull the drill bit out straight without turning it.

Use the proper size cleaning pin or cleaning drill for the nozzle diameter.



⚠ CAUTION

- Erosion may not be able to be confirmed visually, so replace it when it starts to work inefficiently.
- Special plating is applied to the inside and surface of the nozzle hole, but if it is exposed to high-temperature soldering for a long time, it may be eroded and temperature stability may not be maintained.

* If the nozzle is still in a good condition, put some fresh solder on the nozzle tip to protect solder plated area from oxidation.

2. Disassemble the heating element.

Remove the enclosure pipe and the nozzle with the provided wrench.



⚠ CAUTION

The heating element is very hot during operation.

Heating Element



Nozzle



Enclosure pipe



The enclosure pipe is held to the nozzle changing tool by pressing this part from both sides. (The nozzle is not held to the nozzle changing tool. Be careful when removing them.)

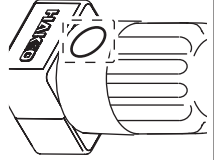

3. Clean out the tube in the heating element with the provided cleaning pin.

Scrape away all oxidation from the tube in the heating element until the cleaning pin passes cleanly through the tube.

- Turn the power off after cleaning.



⚠ CAUTION

- Be sure the solder in the tube in the heating element is completely heated, before cleaning the tube.
- If the cleaning pin does not pass through the tube in the heating element, replace the heating element.

Replacing the filters

● Handpiece filter

1. Turn the power switch OFF.
2. When the filter pipe is cool to the touch, turn the back holder knob counterclockwise and pull out the filter pipe.
3. Examine the seal of filter holder at the end of the filter pipe.
Replace : Stiff and/or cracked.
4. Examine the spring filter.
Replace : Solder is collected in two-thirds of the spring filter.
5. Examine the ceramic paper filter.
Replace : Ceramic paper filter is showing signs of stains from flux, is stiff, or contains any solder.

⚠ CAUTION

The filter pipe is very hot.

Filter holder



Spring Filter

Filter pipe



Ceramic paper filter

● Station filter

If the filter is showing signs of stains from flux or is stiff, replace it. Attach the filter as shown in the right diagram.

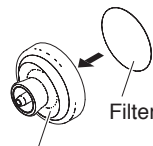

Vacuum outlet cap

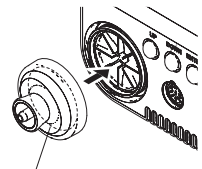

Vacuum outlet cap (with Filter)

7. MAINTENANCE (continued)

Replacing the heating element (heating core)

⚠ CAUTION

Except the case especially indicated, always turn the power switch OFF and disconnect the power plug before performing any maintenance procedure.

● Disassemble the heating element.

1. Remove the nozzle and enclosure pipe.

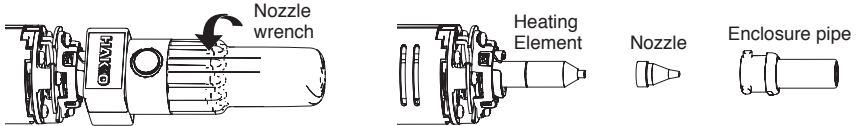

Remove the enclosure pipe and the nozzle with the attached wrench.

2. Remove the 2 screws fixing the joint cover and remove the joint cover.
3. Remove the screw from the handpiece and disconnect the heating element.

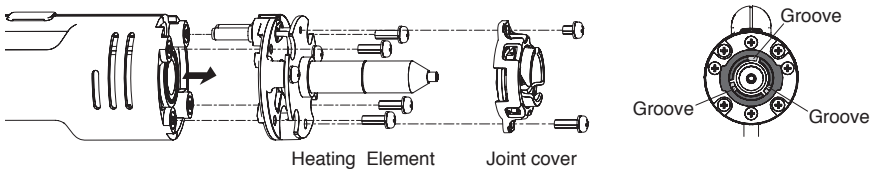

4. Remove the ground line.



5. Secure the ground line to the flange with the screw.

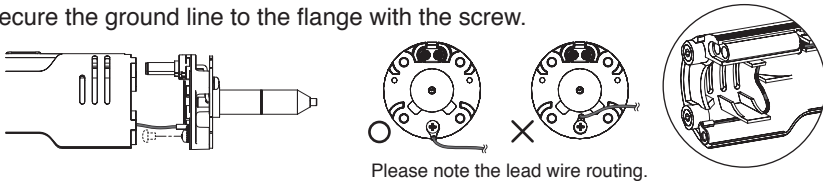

Please note the lead wire routing.

6. Replace the heating element. Assemble using the same procedure in reverse.

* Caution of the heating element installation

The installation / disassembly with the quick changer smoothens. Please attach it to have the groove of the movable joint and the guide hole of the joint cover coming at the same position (see figure above).

⚠ CAUTION

Be sure to change the offset value (temperature adjustment) of the nozzle temperature after replacing the heating element. Failure to do this may result in a heater temperature that is much higher or lower than the previous one.

Maintenance of the pump head

● Remove the cover

When performing maintenance on the pump head, remove the screws holding the cover and take the cover off.

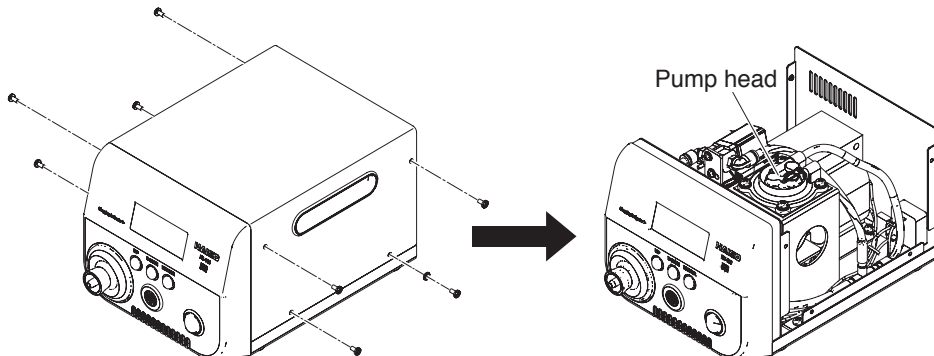

● Cleaning the pump head

1. Remove the valve and valve guard and remove any attached flux.

⚠ CAUTION

- When the valve guard is difficult to remove, please warm it with hot air. Please do not try to forcibly remove it with a screwdriver, etc. If the valve guard becomes deformed, it will no longer be airtight.
- Please clean with either alcohol or thinner.

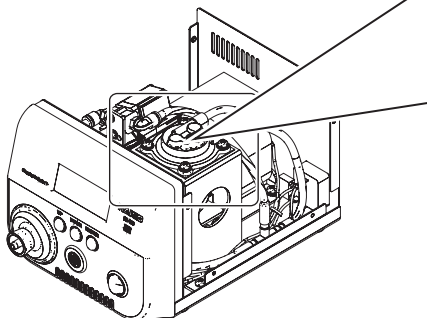

2. Install the valve and valve guard.

⚠ CAUTION

When assembling the pump, please make sure to keep it airtight so that there are no air leaks.

Pump head disassembly

*It is resting on its side.
Clean the pump head, valve and valve guard.

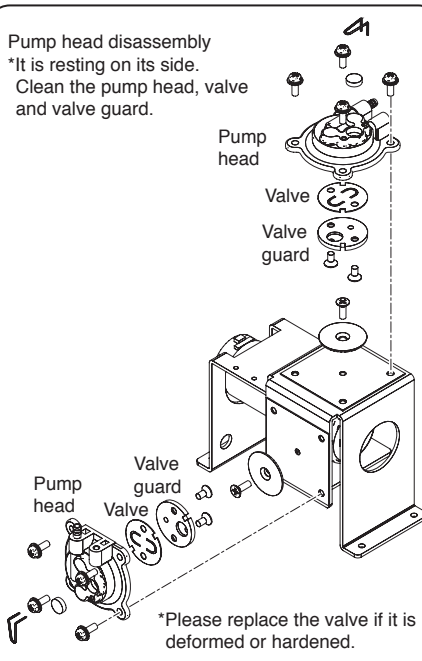

8. CHECKING PROCEDURE

WARNING

Unless otherwise directed, carry out these procedures with the power switch OFF and the power UNPLUGGED.

■ Check for a broken heater or sensor

1. Check for a broken heater or sensor

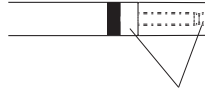

Measure the resistance across this position.

Verify the electrical integrity of the heater and sensor.

Measure the resistance of the heater and sensor while at room temperature (15 to 25°C ; 59 to 77°F). It should be $3.9 \Omega \pm 10\%$. If the resistance exceeds these limits, replace the tip.

■ Replacing the fuse

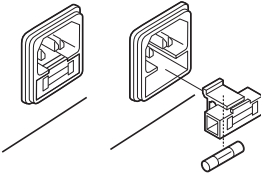

1. Unplug the power cord from the power receptacle.
2. Remove the fuse holder.
3. Replace the fuse.
4. Put the fuse holder back in place.

■ Checking the connection cord for breakage

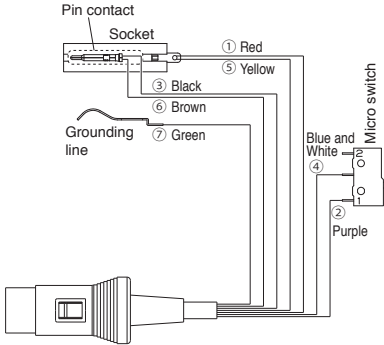
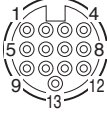

■ Checking the grounding line

Checking the connection cord for breakage

1. Unplug the connection cord from the station.
2. Disassemble the heating element. (Please refer to “Replacing the heating element (heating core)”)
3. Measure the resistance values between the connector and the lead wires at the socket as follows. (Please refer to the wiring diagram on the left.)

- Pin1 ······ Red {Heating element1 (+)} ①
 Pin2 ······ Purple {Trigger (+)} ②
 Pin4 ······ Black {Heating element1 (-)} ③
 Pin8 ······ Blue and White {Trigger (-)} ④
 Pin9 ······ Yellow {Heating element2 (+)} ⑤
 Pin12 ······ Brown {Heating element2 (-)} ⑥
 Pin13 ······ Green (Grounding line) ⑦*

If any value exceeds 0Ω or is ∞ , replace the connection cord.

* For information on the plug 13, refer to “■ Checking the grounding line”.

1. Measure the resistance value between Pin 13 and the nozzle.
2. If the value exceeds 2Ω (at room temperature), perform the nozzle maintenance. If the value still does not decrease, check the connection cord for breakage.

10. TROUBLE SHOOTING GUIDE

WARNING

Before checking the inside of the HAKKO FR-410 or replacing parts, be sure to disconnect the power plug. Failure to do so may result in electric shock.

● **Display does not turn on.**

CHECK : Is the power supply cable or connection plug disconnected?

ACTION : Connect it tightly.

CHECK : Is the fuse blown?

ACTION : Replace the fuse. If the fuse blows again, please send the entire product back to us for repair.

● **Pump does not operate.**

CHECK : Is the power supply cable or connection plug disconnected?

ACTION : Connect it tightly.

CHECK : Is the nozzle or hole in the heating element clogged?

ACTION : Clean it.

● **Solder is not being absorbed.**

CHECK : Is the filter pipe full of solder?

ACTION : Clean it.

CHECK : Is the ceramic paper Filter hardened?

ACTION : Replace it with a new one.

CHECK : Is there a vacuum leak?

ACTION : Check the connections and filter pipe seals and replace any worn parts.

CHECK : Is the heater tube or nozzle clogged?

ACTION : Clean it.

● **The nozzle does not heat up.**

CHECK : Is the desoldering gun cord assembly properly connected?

ACTION : Connect it tightly.

CHECK : Is the heating element damaged?

ACTION : Replace it with a new one.

NOTE :

When repairs are needed, please send both the handpiece and the station to your sales agent.



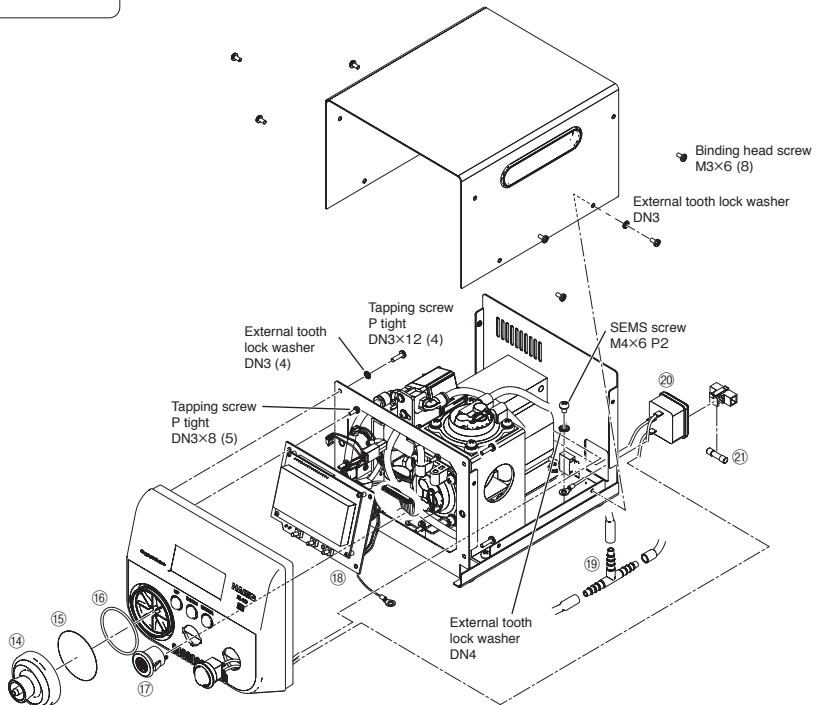
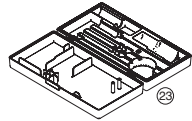
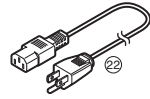
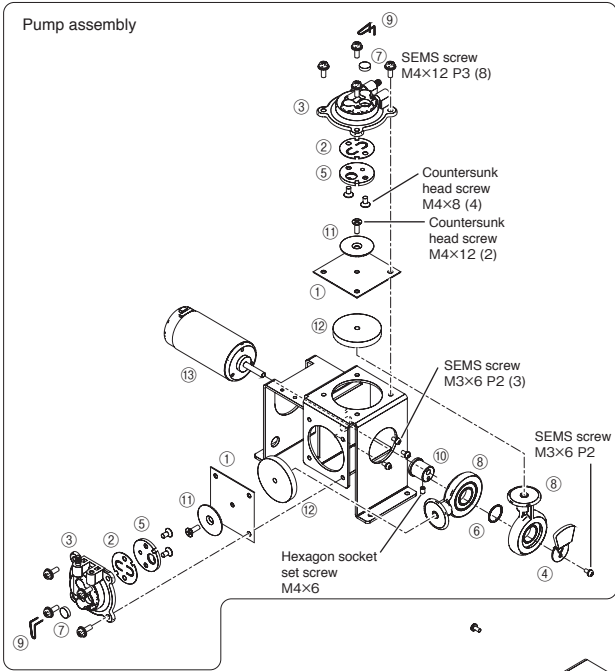

11. PARTS LIST



● HAKKO FR-410

Item No.	Part No.	Part Name	Specifications
①	A1013	Diaphragm	qty 2
②	A1014	Valve plate	qty 2
③	B1050	Pump head	
④	B1053	Balance weight	
⑤	B1056	Fixing plate	
⑥	B1057	Ring for bearing	
⑦	B1059	Exhaust filter	qty 2
⑧	B1312	Crank	
⑨	B1313	Filter retaining pin	
⑩	B2060	Crank shaft	
⑪	B2085	Diaphragm setting plate	
⑫	B2506	Damper	qty 2
⑬	B3428	Motor	
⑭	B5076	Vacuum outlet cap	
⑮	A5020	Filter	qty 10
⑯	B5077	O-ring	
⑰	B5100	Receptacle assembly	
⑱	B5099	P.W.B. / for control	
⑲	B3414	Inner hose joint	
⑳	B2384	Inlet	
㉑	B3674	Fuse/250 V-7 A	100 - 120 V
	B3675	Fuse/250 V-4 A	220 - 240 V
㉒	B2419	Power cord, 3 wired cord & American plug	USA
㉓	C5030	Tool box	

● Cleaning pin / Drill

	Part No.	Part Name	Specifications
	B1215	Cleaning pin	For heating element
	B2874	Cleaning pin	For ø0.6 mm (0.02 in.) nozzle
	B1086	Cleaning pin	For ø0.8 mm (0.03 in.) nozzle
	B1087	Cleaning pin	For ø1.0 mm (0.04 in.) nozzle
	B1088	Cleaning pin	For ø1.3 mm (0.05 in.) nozzle
	B1089	Cleaning pin	For ø1.6 mm (0.06 in.) nozzle
	B5141	Cleaning drill	For ø0.6 mm (0.02 in.) nozzle
	B1302	Cleaning drill	For ø0.8 mm (0.03 in.) nozzle
	B1303	Cleaning drill	For ø1.0 mm (0.04 in.) nozzle
	B1304	Cleaning drill	For ø1.3 mm (0.05 in.) nozzle
	B1305	Cleaning drill	For ø1.6 mm (0.06 in.) nozzle
	B5142	Drill holder	For ø0.6 mm (0.02 in.) nozzle
	B1306	Drill holder	For ø0.8 mm (0.03 in.)/1.0 mm (0.04 in.) nozzle
	B1307	Drill holder	For ø1.3 mm (0.05 in.)/1.6 mm (0.06 in.) nozzle
	B5143	Drill bit	For ø0.6 mm (0.02 in.) nozzle (qty 10)
	B1308	Drill bit	For ø0.8 mm (0.03 in.) nozzle (qty 10)
	B1309	Drill bit	For ø1.0 mm (0.04 in.) nozzle (qty 10)
	B1310	Drill bit	For ø1.3 mm (0.05 in.) nozzle (qty 10)
	B1311	Drill bit	For ø1.6 mm (0.06 in.) nozzle (qty 10)

11. PARTS LIST (continued)

● HAKKO FR-4104

Part No.	Part Name	Specifications
FR4104-81	HAKKO FR-4104	Straight type

● HAKKO FR-4104 parts

Item No.	Part No.	Part Name	Specifications
①	B1915	Filter holder	
②	A1030	Spring filter	qty 10
③	B1916	Filter pipe	
④	A5044	Ceramic paper filter	L, qty 10
①-④	B2517	Filter pipe assembly	
⑤	B1917	Back holder assembly	
⑥	B5222	Enclosure pipe	FR-4104
⑦	B5062	Joint cover	FR-4104
⑧	B5064	Wave spring	FR-4104
⑨	B5063	Movable joint	FR-4104
⑩	A5056	Heating element	FR-4104
⑪	B5101	Hose	FR-4104
⑫	B2953	Cord holder	qty 4
⑬	B1660	Housing fastener	
⑭	B5203	Push button	FR-4104
⑮	B5106	Nozzel wrench	

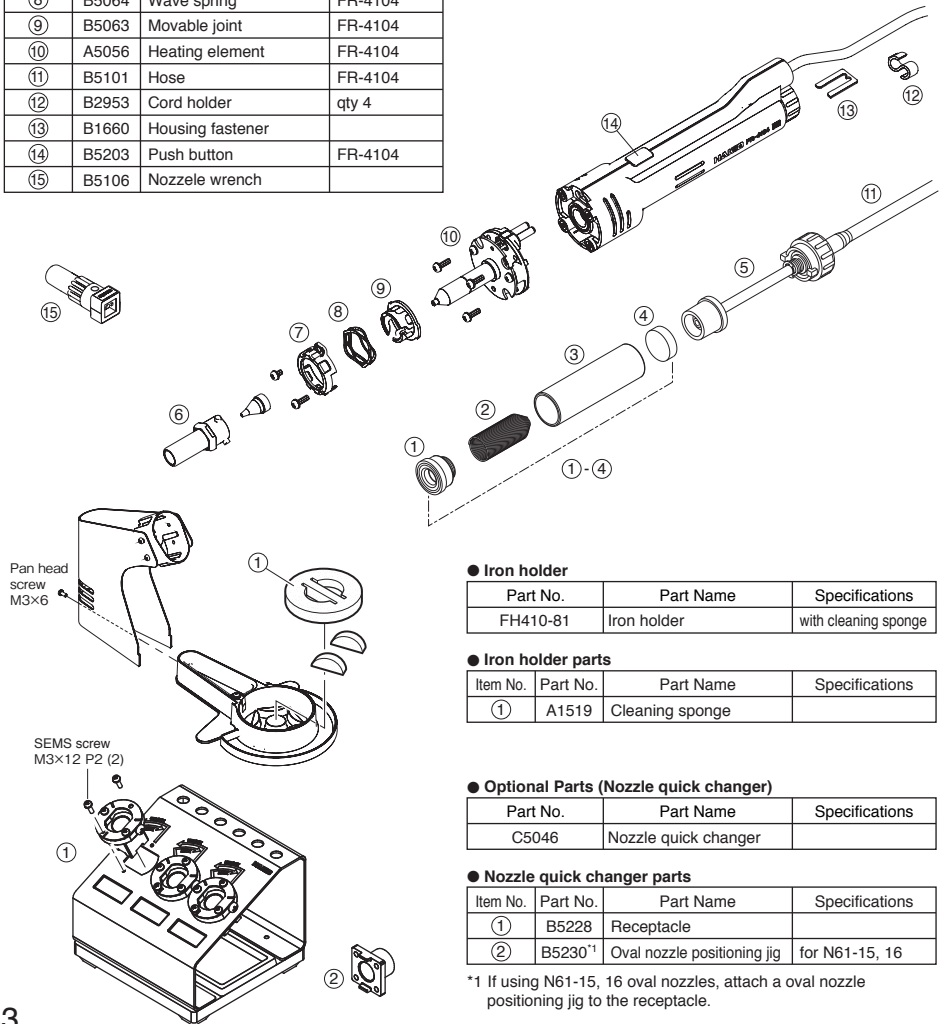

● Iron holder

Part No.	Part Name	Specifications
FH410-81	Iron holder	with cleaning sponge

● Iron holder parts

Item No.	Part No.	Part Name	Specifications
①	A1519	Cleaning sponge	

● Optional Parts (Nozzle quick changer)

Part No.	Part Name	Specifications
C5046	Nozzle quick changer	

● Nozzle quick changer parts

Item No.	Part No.	Part Name	Specifications
①	B5228	Receptacle	
②	B5230*1	Oval nozzle positioning jig	for N61-15, 16

*1 If using N61-15, 16 oval nozzles, attach a oval nozzle positioning jig to the receptacle.

12. WIRING DIAGRAM

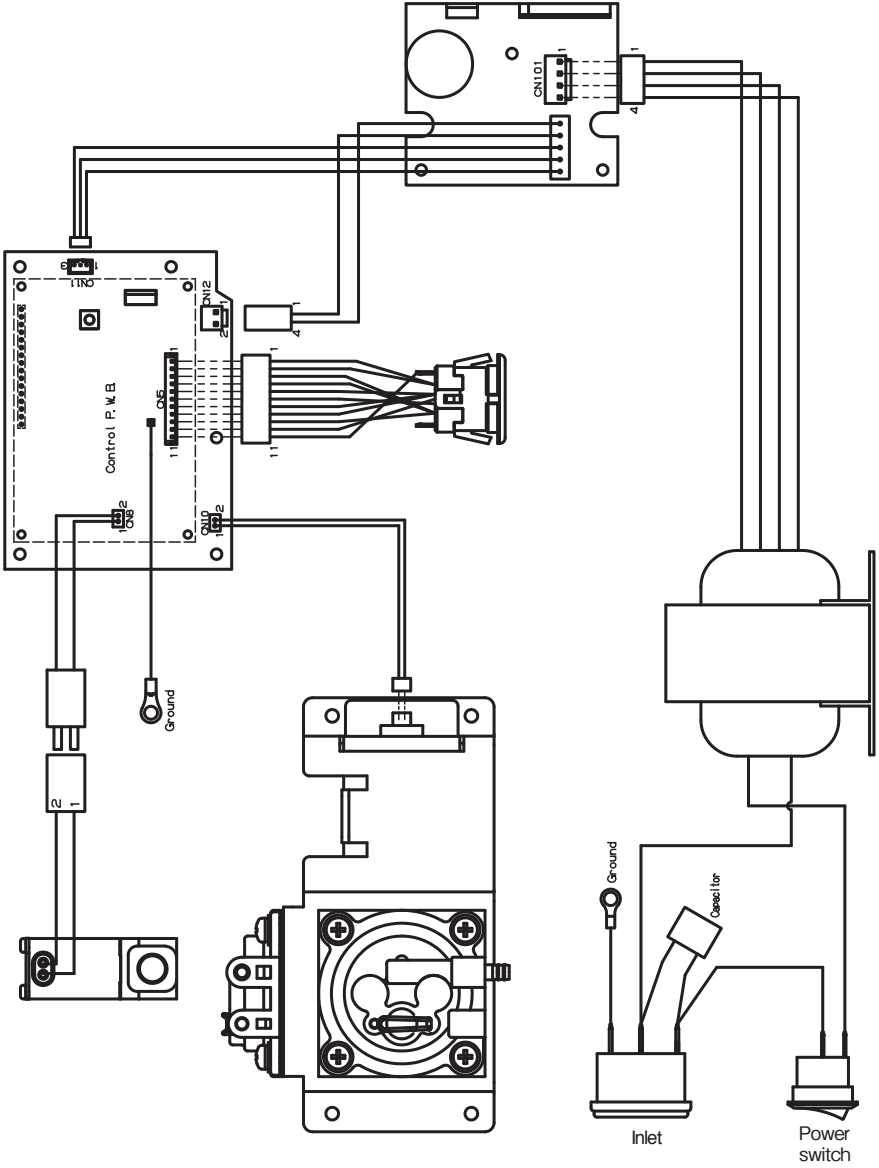

NOZZLE STYLES

Unit: mm (inch)

N61-01

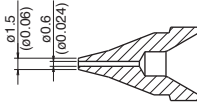

N61-02

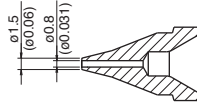

N61-03

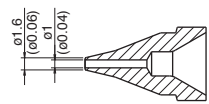

N61-04

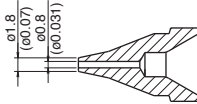

N61-05

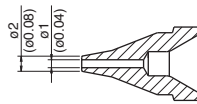

N61-06

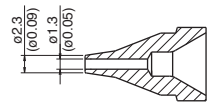

N61-07

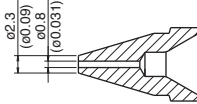

N61-08

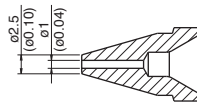

N61-09

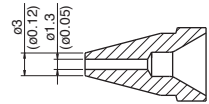

N61-10

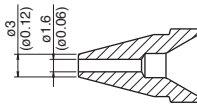

N61-11

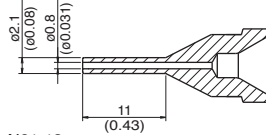

N61-12

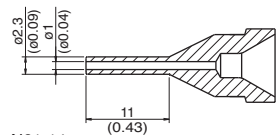

N61-13

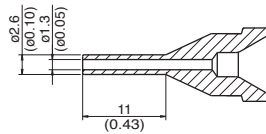

N61-14

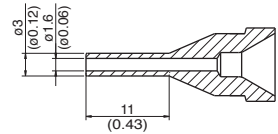

N61-15

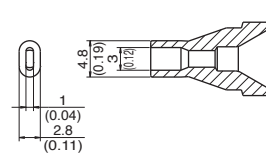

N61-16

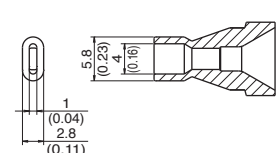

HAKKO CORPORATION

HEAD OFFICE

4-5, Shiokusa 2-chome, Naniwa-ku, Osaka 556-0024 JAPAN
 TEL: +81-6-6561-3225 FAX: +81-6-6561-8466
<https://www.hakko.com> E-mail: sales@hakko.com

OVERSEAS AFFILIATES

U.S.A.: AMERICAN HAKKO PRODUCTS, INC.

TEL: (661) 294-0090 FAX: (661) 294-0096
 Toll Free (800) 88-HAKKO
<https://www.HakkoUSA.com> E-mail: Support@HakkoUSA.com

HONG KONG: HAKKO DEVELOPMENT CO., LTD.

TEL: 2811-5588 FAX: 2590-0217
<https://www.hakko.com.cn> E-mail: info@hakko.com.hk

SINGAPORE: HAKKO PRODUCTS PTE., LTD.

TEL: 6748-2277 FAX: 6744-0033
<https://www.hakko.com.sg> E-mail: sales@hakko.com.sg

Please access the web address below for other distributors.

<https://www.hakko.com>