

⚠ WARNING

If output setting is over 70%, the handpiece and holder can be very hot. Please be sure to turn on the auto-sleep function before use.
(On HAKKO FT-801, please be sure to connect the station and holder with included connecting cable in order for auto-sleep to function properly.)

⚠ WARNING

Operating above 80% output setting can cause stress to the heating element and shorten the life of the blades. Use 80% and above power only when necessary.
When not using the handle, be sure to place it in the holder.

⚠ CAUTION

Since the blades will become hot, place the handle on the handle holder when it is not being used.

HAKKO

HAKKO CORPORATION
HEAD OFFICE

4-5, Shiokusa 2-chome, Naniwa-ku, Osaka 556-0024 JAPAN
TEL:+81-6-6561-3225 FAX:+81-6-6561-8466
<http://www.hakko.com> E-mail:sales@hakko.com

OVERSEAS AFFILIATES

U.S.A.: AMERICAN HAKKO PRODUCTS, INC.
TEL: (661) 294-0090 FAX: (661) 294-0096
Toll Free (800)88-HAKKO

<http://www.hakko.usa.com>
HONG KONG: HAKKO DEVELOPMENT CO., LTD.
TEL: 2811-5588 FAX: 2590-0217
<http://www.hakko.com.cn>
E-mail:info@hakko.com.hk

SINGAPORE: HAKKO PRODUCTS PTE., LTD.
TEL: 6748-2277 FAX: 6744-0033
<http://www.hakko.com.sg>
E-mail:sales@hakko.com.sg

Please access to the following address for the other Sales affiliates.

<http://www.hakko.com>

© 2018-2019 HAKKO Corporation. All Rights Reserved.
Company and product names are trademarks or registered trademarks of their respective companies.

HAKKO

THERMAL WIRE STRIPPER

FT-8004 (with holder part)

Thank you for purchasing HAKKO products.
When using the product, please read this manual and follow the instruction to change the parts.

● PACKING LIST AND PART NAMES

Please make sure that all items listed below are included in the package.

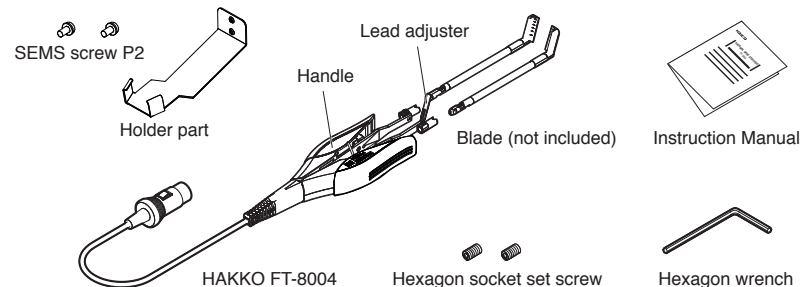

PACKING LIST

HAKKO FT-8004	1	Hexagon wrench (1.27 mm)	1
Holder part (for use with C5012)	1	Instruction Manual	1
SEMS screw P2 (M3x6 for holder part) ...	2	Hexagon socket set screw (M2.5x2.5)	2

Precautions Regarding Electrostatic Protection

⚠ CAUTION

This product includes features such as electrically conductive plastic parts and grounding of the handle and station as measures to protect the device to be soldered from the effects of static electricity.

Be sure to observe the following instructions:

- The handle and other plastic parts are not insulators, they are conductors. When replacing parts or repairing, take sufficient care not to expose live electrical parts or damage insulation materials.
- Be sure to ground the unit during use.

2019.6
MA03051XZ190607

● How to attach the holder part (using C5012 handpiece holder)

⚠ CAUTION

Please be sure to use the included holder part.

Remove the holder part from the C5012 handpiece holder (included with the HAKKO FT-801). Attach the B5247 holder part (included with the HAKKO FT-8004). Please use included SEMS screws for assembly.

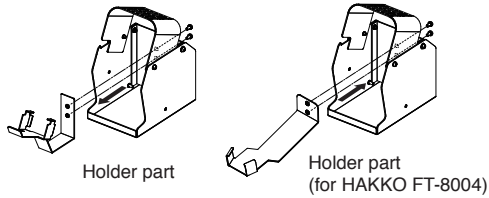

● Installing the blades

1. Insert the blades fully and match the V-groove on the blades to the V-groove on the mounting flange. Push until blades are flush with mounting flange.

2. Insert the hexagon socket set screws but do not tighten.

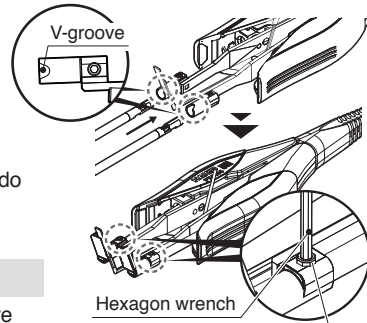

— NOTE —

Blades will not heat up unless both blades are fully inserted. Be sure to use the blades as a set.

3. Adjust and align the blades manually then tighten the hexagon socket set screws with the hexagon wrench to secure the blades.

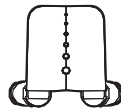

Hexagon socket set screw (M2.5×2.5)

● Removing the blades

⚠ CAUTION

- When pulling out or inserting blades, be sure that the power is switched off.
- Before pulling out the blades, check that the blades have cooled down sufficiently.

Loosen and remove the hexagon socket set screw fixing the blades. As illustrated below, pull the blade straight out.

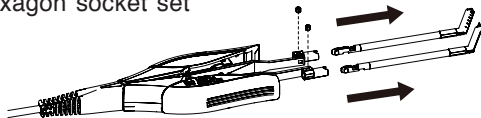

● Attaching the lead adjuster

1. Remove the insulating cover from the handle cover L-side as shown in figure 1 (side with HAKKO FT-8004 logo) and remove the screw from the handle cover L-side.

2. Remove the handle cover L.

3. Align the lead adjuster as shown in figure 3 in the designated channel in the handle cover L. Tighten lightly in place using mounting bracket and screw.

4. Firmly fit the bottom side of the insulation cover to the handle cover as shown in figure 4.

5. Attach handle cover L to the handpiece at the bottom and tighten the screw for handle cover L. Reattach insulating cover to the top side of the handle cover L. Adjust the length of the lead adjuster and firmly tighten the screw.

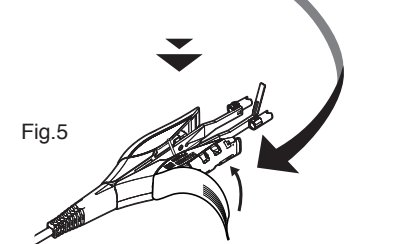
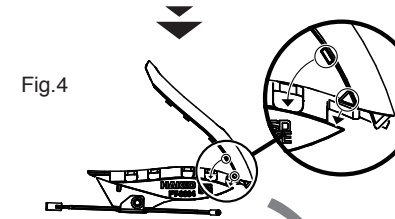
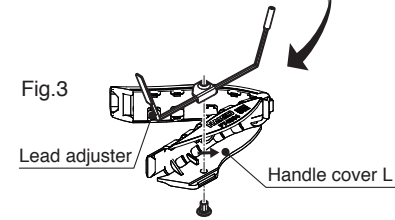
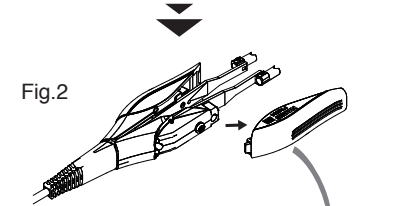
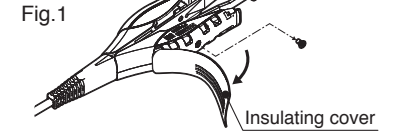

— NOTE —

Pay attention to the direction of the blades when attaching the lead adjuster. (See the following figure.)

Attach the lead adjuster so that the adjuster plate end is in parallel with the blade surface.

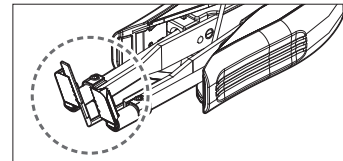

The lead adjuster can be removed with the handle cover attached to the handle.