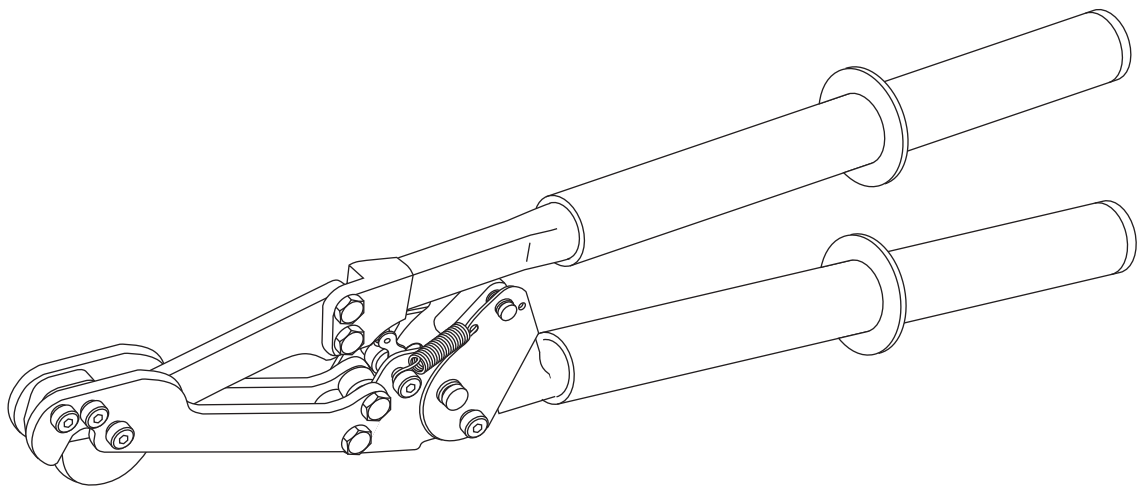


# INSTRUCTION MANUAL



## 758 Heavy-duty Ratchet Guy Wire Cutter



**Read and understand** all of the instructions and safety information in this manual before operating or servicing this tool.

Register this product at [www.greenlee.com](http://www.greenlee.com)

## Table of Contents

|                                    |     |
|------------------------------------|-----|
| Description .....                  | 2   |
| Safety .....                       | 2   |
| Purpose of this Manual .....       | 2   |
| Important Safety Information ..... | 3   |
| Specifications .....               | 4   |
| Operation.....                     | 4   |
| Maintenance.....                   | 5-7 |
| Illustration and Parts Lists ..... | 8-9 |

## Description

The Greenlee 758 Heavy-duty Ratchet Guy Wire Cutter is a non-insulated tool intended for use on 3/8" and 1/2" EHS and standard guy wire, as well as 1/2" mild steel rods and bolts.

## Safety

Safety is essential in the use and maintenance of Greenlee tools and equipment. This instruction manual and any markings on the tool provide information for avoiding hazards and unsafe practices related to the use of this tool. Observe all of the safety information provided.

## Purpose of this Manual

This manual is intended to familiarize all personnel with the safe operation and maintenance procedures for the Greenlee 758 Heavy-duty Ratchet Guy Wire Cutter.

Keep this manual available to all personnel.

Replacement manuals are available upon request at no charge at [www.greenlee.com](http://www.greenlee.com).

All specifications are nominal and may change as design improvements occur. Greenlee Tools, Inc. shall not be liable for damages resulting from misapplication or misuse of its products. Mobilgrease is a registered trademark of Mobil Oil Corp.

## ***KEEP THIS MANUAL***

**IMPORTANT SAFETY INFORMATION**



**SAFETY ALERT SYMBOL**

This symbol is used to call your attention to hazards or unsafe practices which could result in an injury or property damage. The signal word, defined below, indicates the severity of the hazard. The message after the signal word provides information for preventing or avoiding the hazard.

**⚠ DANGER**

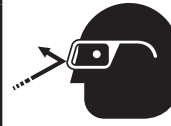
Immediate hazards which, if not avoided, **WILL** result in severe injury or death.

**⚠ WARNING**

Hazards which, if not avoided, **COULD** result in severe injury or death.

**⚠ CAUTION**

Hazards or unsafe practices which, if not avoided, **MAY** result in injury or property damage.



**⚠ WARNING**

Wear eye protection when using this tool.

Failure to wear eye protection could result in serious eye injury from flying debris.

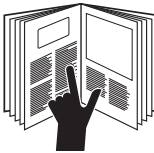


**⚠ WARNING**

Keep hands away from the blades and sprocket.

The spring-loaded mechanism may close unexpectedly. Disengage the spring before servicing this tool.

Failure to observe this warning could result in severe injury or death.



**⚠ WARNING**

Read and understand all of the instructions and safety information in this manual before operating or servicing this tool.

Failure to observe this warning could result in severe injury or death.



**⚠ WARNING**

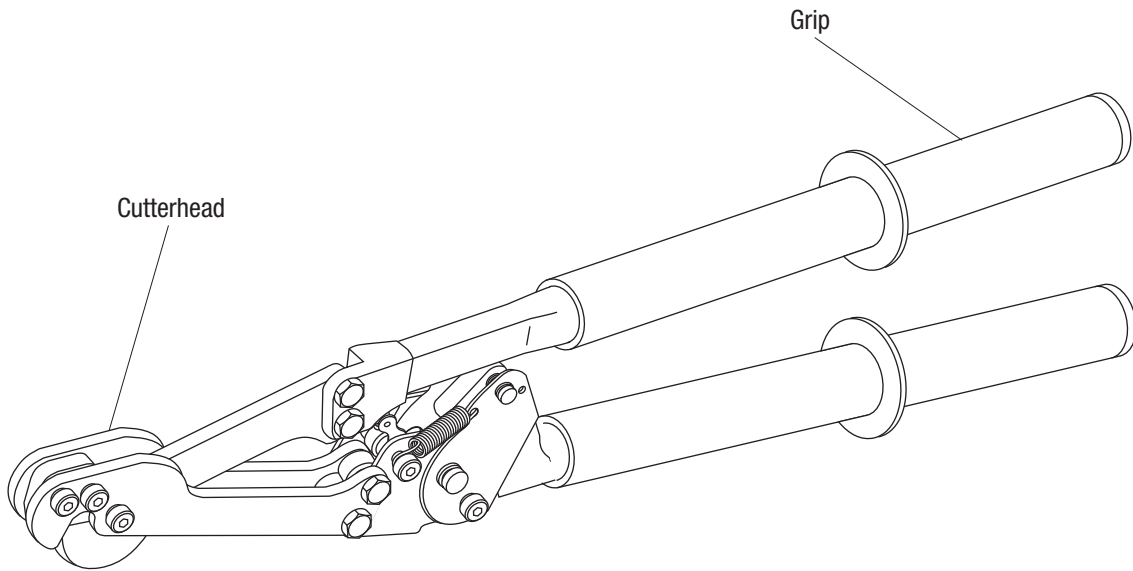
Electric shock hazard:

This is not an insulated tool. Contact with live circuits could result in severe injury or death.

**⚠ CAUTION**

- This tool is intended for two-handed operation. Maintain a firm grip on both handles when using this tool. Using this tool in any other manner can result in injury or property damage.
- Inspect before use. Replace any worn or damaged parts. A damaged or improperly assembled tool can break and strike nearby personnel.
- Do not perform any service or maintenance other than as described in this manual. Injury or damage to the tool may result.
- Do not exceed the rated cutting capacity of this tool. The tool may break and cause injury or property damage.

## Specifications




|   |   |
|---|---|
| Weight.....   | 4.88 kg (10 lb 12 oz)                                 |
| Length.....   | 70.48 cm (27-3/4")                                    |
| Width .....   | 21.59 cm (8-1/2")                                     |
| Thickness .....   | 6.5 cm (2-9/16")                                      |
| Capacity .....  | 1/2" EHS guy wire<br>1/2" mild steel, rods, and bolts |
| Handle force when cutting<br>1/2" EHS guy wire (7 strand) ..... | 338 N (85 lb)   |

## Operation

1. Grip both handles firmly.
2. Pull the handles apart to open the blades.
3. Place the wire between the blades.
4. Allow the chain spring to close the blades while keeping a firm grip on the handles.
  - Standard cutting: To cut smaller wire, press the handles together.
  - Ratchet cutting: To cut larger wire, use the ratchet by opening the shorter handle until it clicks once. Close the handle until it clicks once. Repeat this ratcheting process until the cut is complete.
5. Open the handles completely to release.

## Maintenance

|   |   |
|---|---|
|  | <b>⚠ WARNING</b>  |
|   | Keep hands away from the blades and sprocket.   |
|   | The spring-loaded mechanism may close unexpectedly. Disengage the spring before servicing this tool.<br>Failure to observe this warning could result in severe injury or death. |

### General

- Keep grips clean and dry.
- Keep the blades sharp. If the cutting surfaces are chipped or nicked, sharpen or replace the blades.
- Make sure ratchet assembly is tight. Check shoulder bolts (4 and 32) and lock nuts (8). Check connecting bolts (12) and lock nuts (26).
- Check the tension on the blade assembly. Shoulder bolt should be snug.

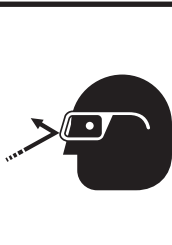
### Lubricate the blades

1. Clamp the long handle into a vise.
2. Grip the short handle and open the cutter.
3. Apply a light film of B-2 Moly grease or an equivalent over the blades with a small brush.
4. Close and open the cutter several times to spread the lubricant.

### Clean and lubricate the internal parts

1. Disassemble the cutter (refer to the disassembly instructions in this manual).
2. Clean the parts with solvent.
3. Apply Mobilgrease® Special 53030-3 or an equivalent to each moving part.
4. Reassemble the tool.

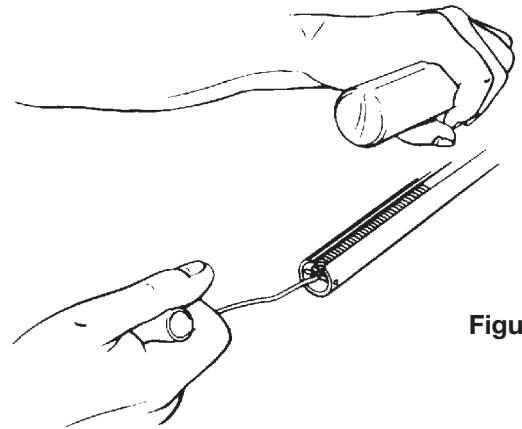
### Clean the cutter mechanism

|   |   |
|---|---|
|  | <b>⚠ WARNING</b>  |
|   | Wear eye protection when using this tool.   |
|   | Failure to wear eye protection could result in serious eye injury from flying debris. |

Use compressed air to blow dirt and foreign particles out of the ratchet mechanism.

### Disengage the Spring

1. Clamp the long handle (31) into a vise with a short handle (53) parallel to the floor and with the head pointing away from you.
2. Remove the rubber grip (43).
3. Unhook the spring (39) from the pin (40) in the short handle (53) (see Figure 1).



**Figure 1**

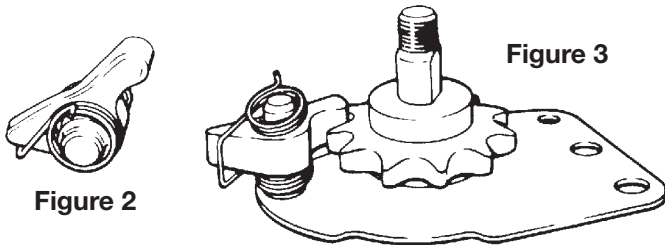
### Disassembly

1. Clamp the long handle (31) into a vise with the short handle (53) parallel to the floor and with the head pointing away from you.
2. Remove the rubber grip (43).
3. Unhook the spring (39) from the pin (40) in the short handle (53) (see Figure 1).
4. Loosen nut (20) from bolt (19) using 7/16" wrenches.
5. Remove bolt and snubber (16).
6. Remove tool from vise.
7. Unhook two closing springs (15).
8. Remove bolt (19) and nut (20) and snubber (16).
9. Remove cutterhead from handles using 9/16" wrenches.
10. Remove right handle assembly, with the chain and spring still attached, from the left handle.
11. Remove retaining ring (54) from sprocket pin (51).
12. Remove sprocket pin (51).
13. Remove 2 side plates (55), sprocket (56), washer (57), pin (23), detent pawl (28), and spring (36).
14. Clean all parts thoroughly with solvent.

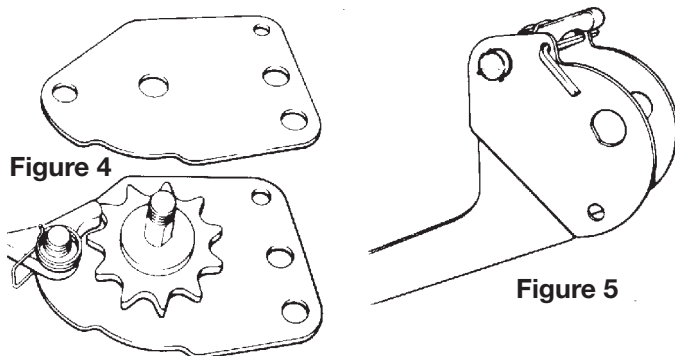
## Maintenance (cont'd)

### Assembly

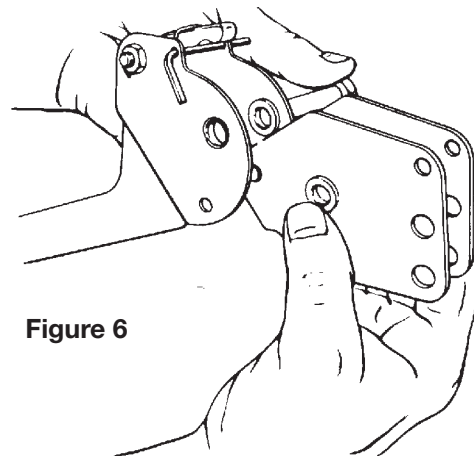
1. Assemble sprocket pin (51) to one side plate (55). Lay this assembly on the bench with the notched edge of the plate nearest you (see Figure 3).



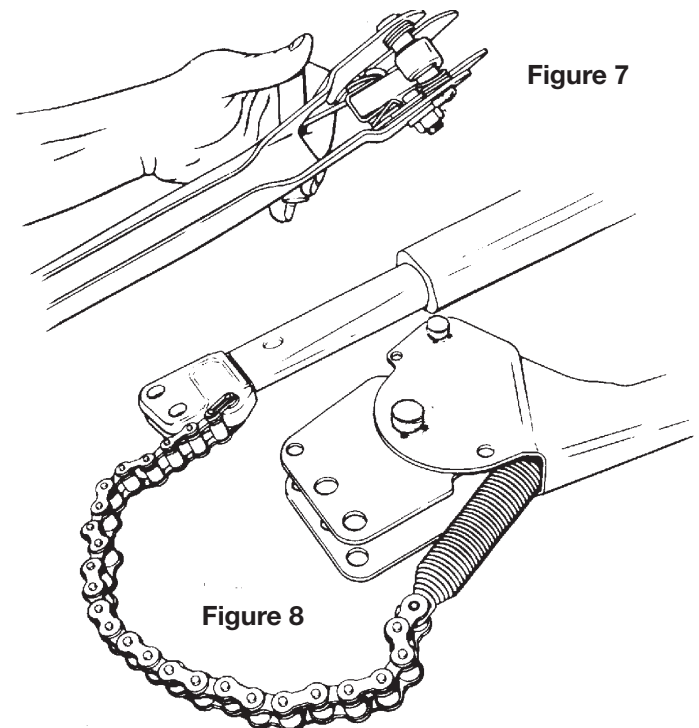
2. Apply a light film of grease to the shank of the pin.
3. Slide sprocket (56) onto pin.
4. Apply grease to the detent pin (23) and slide into the detent pawl. Place the detent spring (36) onto the pin making sure the spring ends have not been bent out of shape. The cross arm of the spring goes under the flat side of the arrow shaped point of the detent pawl (see Figure 2).
5. Assemble one end of detent pin (23) into the hole on side plate (55) and engage the rounded end of the sprocket (56) (see Figure 3).



6. Match up the second plate (55) with the first, and place over the detent pin and pivot bolt. Do not insert spring ends into plates at this point (see Figure 4).
7. Hold the left handle (53) in vise with the drive pawl facing up and the handle pointing to your left (see Figure 5). Pull the drive pawl up, moving counter-clockwise, and insert a 1/8" pin (rod or nail) through the small holes in the plates near the drive pawl to hold it in a horizontal position (see Figure 5).
8. Grasp the side plate assembly firmly with the notched edges of the plate facing down. While holding tightly between fingers, remove the sprocket pin (see Figure 6).
9. Carefully insert the plate assembly into the left handle between the washers (57). Align the holes and slide the sprocket pin into position.

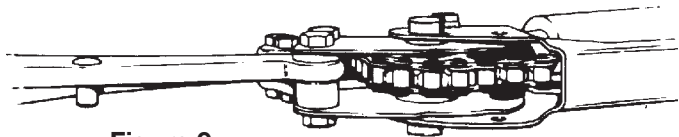


10. Secure sprocket pin with retaining rings (54). (This assembly must be free to pivot freely.)
11. With a small hook tool, reach up from the bottom of the assembly, between the plates and hook the ends of the detent spring into their respective holes (see Figure 7). Check to be sure spring loops are not caught between the pin and the side plate.
12. Remove the 18" pin from under the pawl and engage the drive pawl with sprocket (56).
13. Remove the handle from the vise.
14. Hook the longer loop on the chain spring (39) onto the free end of the chain (38). Lay the left and right handles on the bench. The drive pawl is located in the left handle. The chain is attached to the right handle. Feed the spring on the chain over the sprocket and into the left handle (see Figure 8).



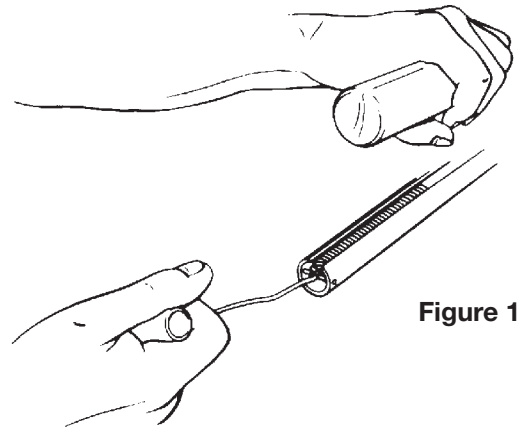
## Maintenance (cont'd)

15. With handles remaining in this position, assemble the cutting head to the left handle. The thick spacer (25) goes between the blade holders (see Figure 9). Use the longer bolt (12) and nut (26) and tighten securely.

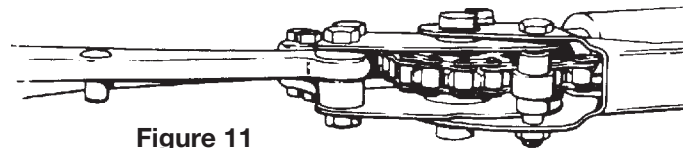


**Figure 9**

16. Assemble the other side of the head to the right handle using bolts (32), nuts (8) and washer (7). Tighten securely.
17. Hook open end of closing spring (15) into holes in handle (53) so that closed loops will be against side plates (55).
18. Insert bolt (19) through closed loop on one of the springs (15) and insert through 1/4 inch hole in side plate (55). At the same time assemble snubber (16) and slide bolt through snubber.
19. Assemble other spring (15) onto bolt and assemble nut onto bolt.
20. Tighten nut approximately one thread beyond end of bolt.
21. Hook the chain spring (39) over pin at end of the left handle (see Figure 10).
22. Assemble snubber (16) and bolt (19) to handle. Assemble nut and tighten so as not to bind assembly (see Figure 11).



**Figure 10**



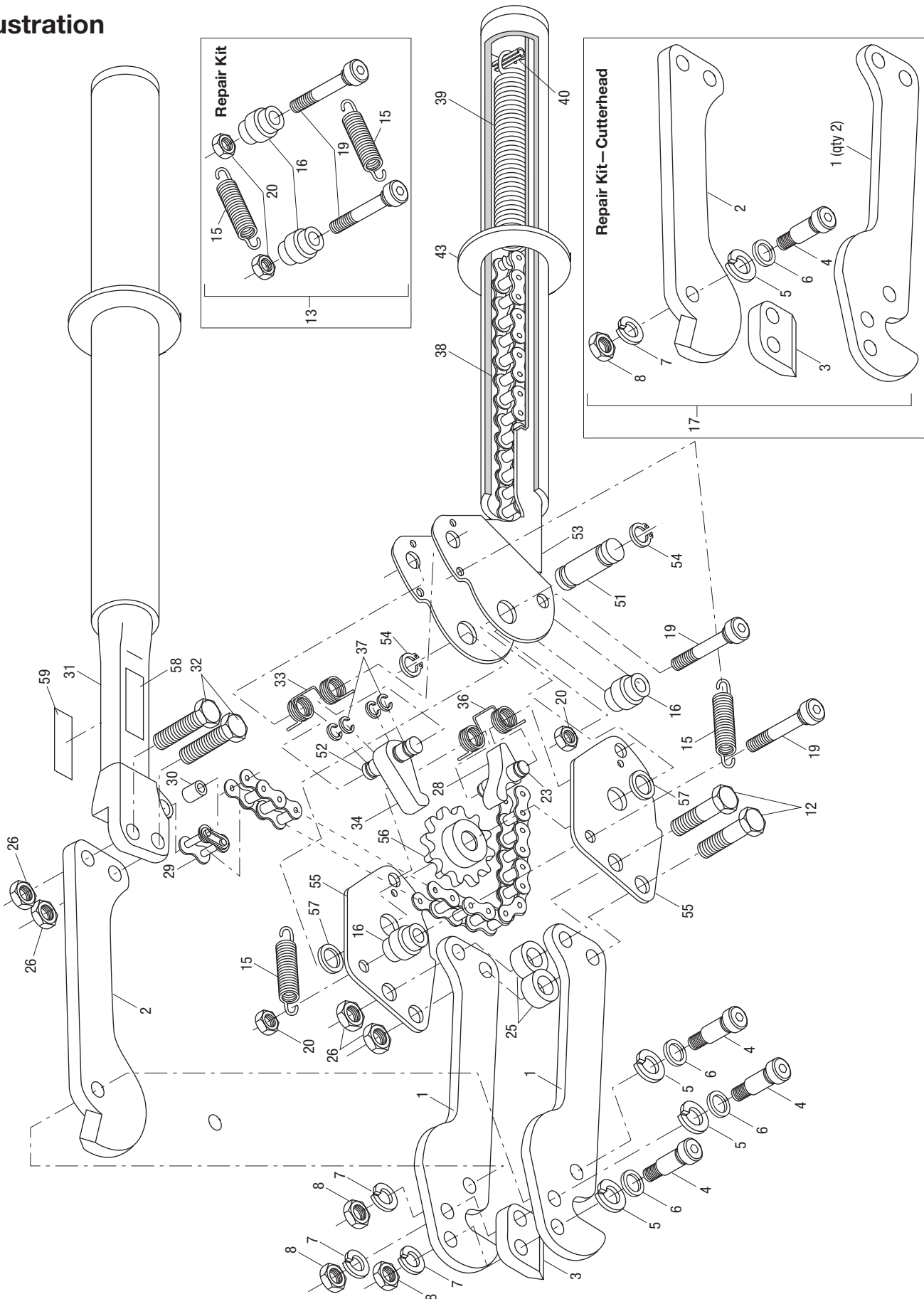
**Figure 11**

23. Check operation of the tool by opening and closing. If operation is satisfactory, proceed to next step.
24. Assemble grip to left handle (53). There is a "key" in the interior of the grip. Align this key with the slot in the left (or ratcheting) handle, and push the grip over the handle. No lubrication or adhesive is needed. Assemble clamp to grip and tighten.

If sliding a replacement grip over a replacement right handle (31), spread a small amount of soapy water over the handle to ease assembly. It will eventually dry out and allow a solid adhesion to the handle. The grip requires pounding to fit over the handle.



**Illustration**





## Parts List

| Key | Part No. | Description  | Qty |
|-----|----------|--|-----|
| 1   |          | Holder, blade.....   | 2   |
| 2   |          | Blade.....   | 1   |
| 3   |          | Blade, insert.....   | 1   |
| 4   |          | Screw, $\phi$ 3/8 x 1 x 5/16-18 shoulder.....                | 3   |
| 5   |          | Washer, 3/8 heavy lock.....                                  | 3   |
| 6   |          | Washer, 3/8 flat.....  | 3   |
| 7   |          | Washer, 5/16 lock.....                                       | 3   |
| 8   |          | Nut, 5/16-18 lock.....                                       | 3   |
| 12  |          | Screw, 3/8-24 x 1-1/2 hex head cap.....                      | 2   |
| 15  | 50074768 | Spring, extension.....                                       | 2   |
| 16  | 50341731 | Snubber, chain.....  | 2   |
| 19  |          | Screw, 1/4-20 x 1-3/4 socket head cap.....                   | 2   |
| 20  |          | Nut, 1/4-20 hex lock.....                                    | 2   |
| 23  | 50341677 | Pin, detent.....   | 1   |
| 25  | 50355325 | Spacer.....  | 2   |
| 26  |          | Nut, 3/8-24 hex lock.....                                    | 4   |
| 28  | 50341650 | Pawl, detent.....  | 1   |
| 29  | 90527879 | Link, chain connector (included with item 38).....           | 1   |
| 30  | 50341596 | Bushing.....   | 1   |
| 31  | 52046302 | Right handle unit (includes two each of items 8 and 32)..... | 1   |
| 32  |          | Screw, 3/8-24 x 1-1/4 hex head cap.....                      | 2   |
| 33  | 50341758 | Spring, drive pawl.....                                      | 1   |
| 34  | 50341642 | Pawl, drive.....   | 1   |
| 36  | 50341766 | Spring, detent.....  | 1   |
| 37  | 90538951 | Ring, retainer.....  | 4   |
| 38  | 50341723 | Chain (includes item 29).....                                | 1   |
| 39  | 50341774 | Spring, chain.....   | 1   |
| 40  |          | Rollpin, $\phi$ 1/8 x 1-1/8 long.....                        | 1   |
| 43  | 50340832 | Grip, handle.....  | 2   |
| 51  | 50371398 | Pin, sprocket.....   | 1   |
| 52  | 50371401 | Pin, pawl drive.....   | 1   |
| 53  | 50371428 | Handle left.....   | 1   |
| 54  | 90515277 | Ring, retaining.....   | 2   |
| 55  | 50371436 | Side plate.....  | 2   |
| 56  | 50371410 | Sprocket.....  | 1   |
| 57  |          | Washer, 5/8 flat.....  | 2   |
| 58  | 50351907 | Decal, safety.....   | 1   |
| 59  | 52081519 | Decal, warning.....  | 1   |

## Repair Parts List

| Key | Part No. | Description   | Qty |
|-----|----------|---|-----|
| 17  | 50035487 | 758 cutterhead.....<br>(includes two of item 1 and one each of items 2-8) | 1   |
| 13  | 50341898 | 758 repair kit.....<br>(includes two of items 15, 16, 19, and 20)         | 1   |



4455 Boeing Drive • Rockford, IL 61109-2988 • USA • 815-397-7070  
©2019 Greenlee Tools, Inc. • An ISO 9001 Company

[www.greenlee.com](http://www.greenlee.com)

**USA** Tel: 800-435-0786  
Fax: 800-451-2632

**Canada** Tel: 800-435-0786  
Fax: 800-524-2853

**International** Tel: +1-815-397-7070  
Fax: +1-815-397-9247