

FEV150/FEV350

EV Charging Station Analyzer

Users Manual

4/2024 Rev. 1, 5/2024 (English)

©2024 Fluke Corporation. All rights reserved.

Specifications are subject to change without notice.

All Product names are trademarks of their respective companies.

LIMITED WARRANTY AND LIMITATION OF LIABILITY

Each Fluke product is warranted to be free from defects in material and workmanship under normal use and service. The warranty period is 2 years and begins on the date of shipment. Parts, product repairs, and services are warranted for 90 days. This warranty extends only to the original buyer or end-user customer of a Fluke authorized reseller, and does not apply to fuses, disposable batteries, or to any product which, in Fluke's opinion, has been misused, altered, neglected, contaminated, or damaged by accident or abnormal conditions of operation or handling. Fluke warrants that software will operate substantially in accordance with its functional specifications for 90 days and that it has been properly recorded on non-defective media. Fluke does not warrant that software will be error free or operate without interruption.

Fluke authorized resellers shall extend this warranty on new and unused products to end-user customers only but have no authority to extend a greater or different warranty on behalf of Fluke. Warranty support is available only if product is purchased through a Fluke authorized sales outlet or Buyer has paid the applicable international price. Fluke reserves the right to invoice Buyer for importation costs of repair/replacement parts when product purchased in one country is submitted for repair in another country.

Fluke's warranty obligation is limited, at Fluke's option, to refund of the purchase price, free of charge repair, or replacement of a defective product which is returned to a Fluke authorized service center within the warranty period.

To obtain warranty service, contact your nearest Fluke authorized service center to obtain return authorization information, then send the product to that service center, with a description of the difficulty, postage and insurance prepaid (FOB Destination). Fluke assumes no risk for damage in transit. Following warranty repair, the product will be returned to Buyer, transportation prepaid (FOB Destination). If Fluke determines that failure was caused by neglect, misuse, contamination, alteration, accident, or abnormal condition of operation or handling, including overvoltage failures caused by use outside the product's specified rating, or normal wear and tear of mechanical components, Fluke will provide an estimate of repair costs and obtain authorization before commencing the work. Following repair, the product will be returned to the Buyer transportation prepaid and the Buyer will be billed for the repair and return transportation charges (FOB Shipping Point).

THIS WARRANTY IS BUYER'S SOLE AND EXCLUSIVE REMEDY AND IS IN LIEU OF ALL OTHER WARRANTIES, EXPRESS OR IMPLIED, INCLUDING BUT NOT LIMITED TO ANY IMPLIED WARRANTY OF MERCHANTABILITY OR FITNESS FOR A PARTICULAR PURPOSE. FLUKE SHALL NOT BE LIABLE FOR ANY SPECIAL, INDIRECT, INCIDENTAL OR CONSEQUENTIAL DAMAGES OR LOSSES, INCLUDING LOSS OF DATA, ARISING FROM ANY CAUSE OR THEORY.

Since some countries or states do not allow limitation of the term of an implied warranty, or exclusion or limitation of incidental or consequential damages, the limitations and exclusions of this warranty may not apply to every buyer. If any provision of this Warranty is held invalid or unenforceable by a court or other decision-maker of competent jurisdiction, such holding will not affect the validity or enforceability of any other provision.

Fluke Corporation
6920 Seaway Blvd
Everett, WA 98203
U.S.A.

Fluke Europe B.V.
P.O. Box 1186
5602 BD Eindhoven
The Netherlands

Table of Contents

Title	Page
Introduction.....	1
Contact Fluke	1
Safety Information	2
The Product	2
Features.....	4
Display.....	5
Main Menu	7
Menu Controls.....	8
Test Menu.....	9
Set up a Test.....	9
Project List Menu	9
Create a Project	10
Add a Project.....	10
Delete a Project.....	10
Enter Project Client and Site Codes.....	10
Project Menu.....	11
Add a Station.....	11
Copy a Station	11
Edit a Station	12
Delete a Station.....	12
Configure a Station.....	13
Earth Bond Configuration (FEV350)	18
Connect the Plug.....	20
Connect the TPAK Strap	21
Station and Connection Point Tests.....	22
Function Buttons in Tests.....	23
Symbols on Test Screens.....	24
Do a Test	27
PE Pre-Test.....	27
Visual Inspection Test.....	28
How to do Tests.....	29
Earth Bond Tests.....	30
Insulation Input or Output Tests.....	30
Loop/Line Impedance Test	30
30 mA RCD Trip Test	31

6 mA RDC-DD Trip Test	31
Mains Voltage/Phase Sequence Test	31
Nominal Voltage Test.....	31
GFCI Trip Test.....	31
Control Pilot Test.....	32
Proximity Pilot Test.....	32
Error Test.....	32
Settings Menu	33
Manual CP Menu.....	34
Troubleshoot GFCI Menu	35
TruTest™ Software Menu	36
Maintenance.....	36
Clean the Product	36
Battery Replacement	37
Product Disposal	37

Introduction

The Fluke FEV150/FEV350 Electric Vehicle (EV) Charging Station Analyzer (the Product or Analyzer) is a handheld test instrument to test ac electric vehicle (EV) charging stations (the Station or EVSE).

The Product verifies the safety and functionality of the Station through a preset test sequence, including Control Pilot (CP) charge state analysis. The product is designed to test ac electric vehicle charging stations in accordance with industry standards.

Use the FEV150 with a:

- Type 1 plug to test a station with a fixed cable connector.
- Tesla type plug to test a station with a Tesla type connector.

Use the FEV350 with a:

- Type 2 plug to test a station with a fixed cable or socket-outlet connector.
- Type 1 plug to test a station with a fixed cable connector.

The FEV350 allows for full installation certification in combination with a compatible multi-function tester (MFT) such as the Fluke 1664 FC. See the users manual for the MFT for instructions on how to set up, zero, and use the MFT.

The Product shows images on a high-visibility, industrial-quality LCD screen. The Product saves data to the internal memory. Use TruTest™ desktop software to transfer the saved results from the Product to the TruTest software through a Bluetooth connection.

Use TruTest software to generate professional reports and update the firmware of the Product. To download TruTest software, go to: <https://www.fluke.com/en-us/support/software-downloads/trutest-software-downloads>.

This Users Manual shows English screens in examples and images of the FEV350 model.

Contact Fluke

Fluke Corporation operates worldwide. For local contact information, go to our website: www.fluke.com. +1-425-446-5500 fluke-info@fluke.com

To register your product, or to view, print, or download the latest manual or manual supplement, go to our website.

Safety Information

General Safety Information is in the printed Safety Information document that ships with the Product and at www.fluke.com. More specific safety information is listed where applicable.

A **Warning** identifies hazardous conditions and procedures that are dangerous to the user. A **Caution** identifies conditions and procedures that can cause damage to the Product or the equipment under test.

The Product

Table 1 shows the items included with the Product as part of a kit or purchased separately.

Table 1. Product

Item	Description	Function
1	FEV150/FEV350	The Product
2	TY1 Type 1 plug (FEV150)	Use with a station with a fixed cable connector.
3	Tesla type plug (FEV150)	Use with a station with a Tesla type connector.
4	TY1 Type 1 plug (FEV350)	Use with a station with a fixed cable connector.
5	Type 1 zero adapter (FEV350)	Attach to a Type 1 plug to zero the connector or the test leads.
6	Tesla type plug (FEV350)	Use with a station with a Tesla type connector.
7	Type 1 zero adapter (FEV150)	Attach to a Type 1 plug to zero the connector or the test leads.
8	Protective case	Protect the meter and accessories.
9	Carrying strap	Attach to the meter for carrying.

Table 1. Product (cont.)

Item	Description	Function
6	TY2 Type 2 plug (FEV350)	Use with a station with a socket-outlet or a fixed cable connector.
7	Type 2 zero adapter (FEV350)	Attach to a Type 2 plug to zero the connector or the test leads.
8	Fluke 1664 FC Multi-function tester (MFT)	Use with the FEV350 for specific tests. See Table 8 .
9	TPAK Magnetic strap	Use to attach the Product to a station with metal housing. See Figure 2 .
--	Carrying case	Not shown.

Features

Table 2 shows the features of the Product.

Table 2. Features

Item	Description	Function
1	Plug connection port	Use to connect a Type 1, Type 2, or Tesla type plug to the Product.
2	Display	See Display .
3	Function buttons F1 (F1), F2 (F2), F3 (F3), F4 (F4)	Do the action that shows on the display above the function button.
4	PE PRE-TEST sensor	Use to verify the station is properly grounded. See PE Pre-Test .
5	Power button	Turns on and off the Product.



Table 2. Features (cont.)

Item	Description	Function
6	Arrow buttons 	Use to navigate the menu to highlight a selection or change a numerical value.
7	Measurement terminals	Use to connect test leads to the Product. FEV150: <ul style="list-style-type: none"> ● L1: Live wire ● L2/N: Neutral/second live wire for use with a split phase system ● PE: Protective earth or ground FEV350: <ul style="list-style-type: none"> ● L1, L2, L3: Three line voltage phases ● N: Neutral ● PE: Protective earth or ground

Display

When you turn on the Product for the first time, the language selection screen shows on the display.

To select a language:

1. Push  /  to highlight a language.
2. Push  (**Select**) to select the language for the user interface (UI).

[Table 3](#) shows the items on the display.

Table 3. Display

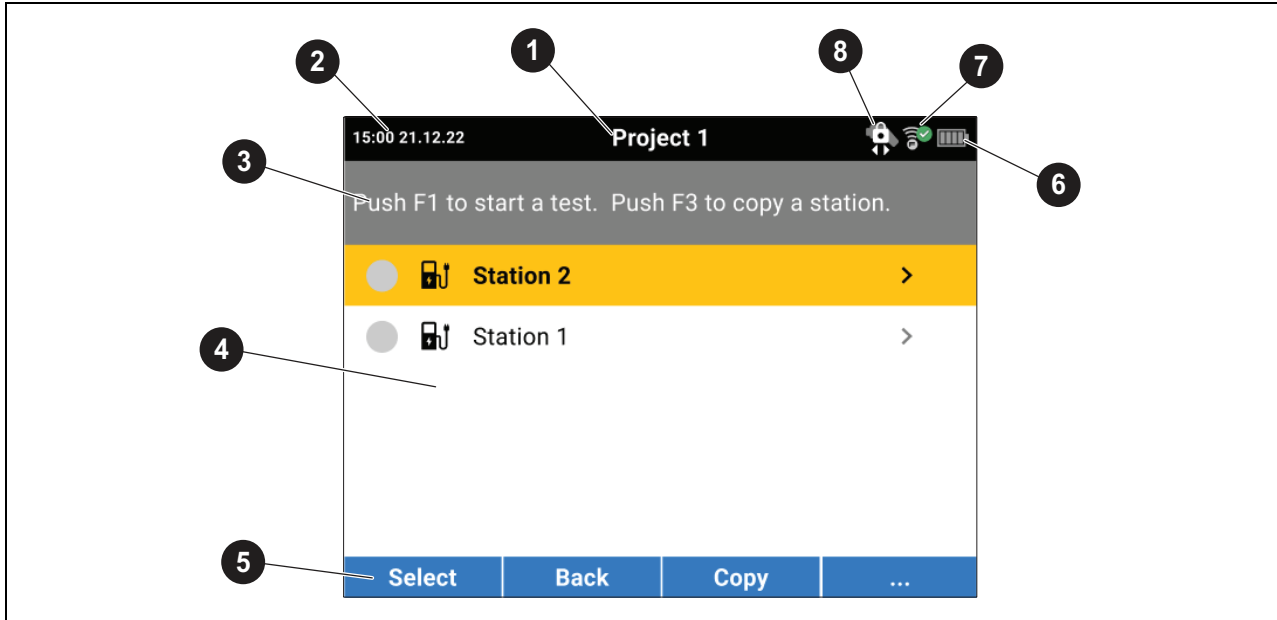





Item	Description	Function
1	Name of the screen	Name of the screen you are in.
2	Time and date	The time and date.
3	Instruction subheader	Shows the instructions for the screen.
4	Screen content	Main body of the screen.
5	Soft keys	Use with the function buttons to interact with the UI.
6	Battery status icon	Shows the status of battery power.  : Batteries have full power.  : Replace batteries.





Table 3. Display (cont.)

Item	Description	Function
7	Bluetooth connection indicator. (FEV350)	<p>Indicates the status of a Bluetooth connection between the Product and a compatible MFT.</p> <p> : The connection is in progress.</p> <p> : The Product is connected.</p> <p> : The Product is not connected.</p>
8	Control pilot status indicator	Indicates when it is safe to disconnect the Plug from the Station. See Table 10 .

Main Menu



[Table 4](#) lists the submenus available on the Main menu.

Table 4. Main Menu

Submenu	Function
 Test	Select to add, view, or set up a project to do a test. See Test Menu .
 Settings	Select to set user preferences and view information about the Product. See Settings Menu .
 Manual CP	Use to manually select states and values to troubleshoot a Station. See Manual CP Menu .
 Troubleshoot GFCI (FEV150)	Use to troubleshoot GFCI circuits. See Troubleshoot GFCI Menu .
 TruTest™ Software	Use Bluetooth to connect the Product to TruTest software on a PC. See TruTest™ Software Menu

Menu Controls





Use the menu controls to navigate the menus, change settings, set up a project, and do a test. [Table 5](#) lists the functions of the menu controls.

Some menus contain a scroll bar on the right side to indicate there are additional options or rows. To view additional options, push  / . The scroll bar indicates the location in the menu. The scroll bar is not a control.

Note

The arrow and function buttons, especially the F1 button, do different things based on where you are in the UI. Follow the directions carefully, or you might not configure the station as you intended. For example, some tests are not available or the results are adversely affected.

To change settings:

1. Push  /  to highlight a menu.
2. Push  (**Select**) to open an option menu.
3. Push  /  to highlight a selection.

To change a setting that uses a toggle button, follow the directions carefully based on where you are in the UI.













4. Push  (**Select**) to set the selection and go back to the previous screen, or push  (**Back**) to cancel the changes and go back to the previous screen.

Table 5. Menu Controls

Item	Control	Function
Additional menu, test, or step indicator		Indicates there is another menu or test. With a submenu or option menu highlighted, push  (Select) to open the menu to adjust a setting, start a test, or to follow the on-screen instructions to connect the Product to an MFT or to TruTest software.
Bold text	--	With a row highlighted, the selected option shows in bold text. For example: Connection Points 1 2 indicates there are two connection points selected. Push  /  to bold and select an option.
Toggle switch	 	Turns a feature on or off. Push  /  to toggle a feature. Indicates a feature is on or enabled. Indicates a feature is off or disabled.
Radio button selection indicator	 	Indicates an option is selected. Indicates an option is not selected.

Test Menu

Use the Test menu to set up and do tests.

Set up a Test



To set up a test, use the project list menu to create a project, the project menu to add a station to a project, and the station configuration menu to configure a station.

Project List Menu

Use the Project List menu to manage projects.



Create a Project

To create a project:

1. Highlight the Test menu, and push  (**Select**).
The Project List menu shows with **Add Project** highlighted.
2. Push  (**Select**) to create a new project.





Add a Project

To add a project:

1. Highlight the Test menu, and push  (**Select**).
The Project List menu shows.
2. With at least one project created, push  (**Add**) to add another project with the next sequential project number. The Project List can contain a maximum of 10 projects.



Delete a Project







To delete a project:

1. Go to **Test > Project List**.
The Project List menu shows.
2. Push  /  to highlight a project to delete.
3. Push  (...) and highlight **Delete**.
4. Push  (**Select**) to delete the project.
5. Follow the on-screen instructions to confirm you want to delete the project.

Enter Project Client and Site Codes

To enter project client and site codes for a project:

1. Go to **Test > Project List**.
The Project List menu shows.
2. Push  /  to highlight a project.



3. Push  (...) and highlight **Enter Code**.
4. Push  (**Select**).
The Project List Enter Client and Site Code option menu shows.
5. Push  /  to highlight a numerical field.
6. Push  /  to increase or decrease a numerical value.
7. With all fields complete, push  (**Select**) to save the codes and go back to the Project List menu.

Project Menu

Use the project menu to configure and manage stations.

Add a Station

To add the first station to a project:

1. Go to **Test > Project List**.
The Project List menu shows.
2. Highlight a project, and push  (**Select**) to open the project.
The Project menu shows with **Add Station** highlighted.
3. Push  (**Select**) to create a new station.
The Station Configuration menu shows.
4. Configure the station. See [Configure a Station](#).

Copy a Station

To copy a station:

1. Go to **Test > Project List**.
The Project List menu shows.
2. Highlight a project, and push  (**Select**) to open the project.
The Project menu shows.

3. Push  /  to highlight a station to copy.

Note

Fully configure the original station before you copy the station.

4. Push  (**Copy**) to create a new station with the next sequential station number and the same configuration settings as the original station. A project may contain a maximum of 20 stations.

Edit a Station

To edit the configuration of a station:

1. Go to **Test > Project List**.

The Project List menu shows.

2. Highlight a project, and push  (**Select**) to open the project.

The Project menu shows.

3. Push  /  to highlight a station to edit.

4. Push  (...) and highlight **Edit**.

5. Push  (**Select**) to edit the station.

The Station Configuration menu shows.

6. Configure the station as needed for the test. See [Configure a Station](#).

Delete a Station





To delete a station:

1. Go to **Test > Project List**.

The Project List menu shows.

2. Highlight a project, and push  (**Select**) to open the project.

The Project menu shows.

3. Push  /  to highlight a station to delete.
4. Push  (...) and highlight **Delete**.
5. Push  (**Select**) to delete the station.
6. Follow the on-screen instructions to confirm you want to delete the station.

Configure a Station

To configure a station:

1. Add a new station or select a station to edit.
The Station Configuration menu shows.
2. Configure the Station as needed for the test.
 - a. On an FEV350, set the Station Type first.
 - b. Then, set the other settings in order from the top to the bottom of the list.

[Table 7](#) is a list of the settings in the station configuration menu on the FEV350. [Table 6](#) is a list of the settings in the station configuration menu on the FEV150.

Caution

A setting that is incompatible with a previously selected setting causes a change to the previous setting. Some settings can reduce the options available in other settings and the availability of some tests. Before you save the configuration, review all the settings.

3. With the station configured, push  (**Save**) to save the station configuration settings and return to the project menu.

Table 6. Station Configuration Menu (FEV150)

Setting	Description
Connection Points	<p>Set the number of fixed cable or Tesla type connection points (the Connection Points) on the station. The maximum connection points on a station is two.</p> <p>The default setting is Connection Point 1.</p> <p style="text-align: center;"><i>Note</i></p> <p><i>You cannot change the number of connection points in another menu. If only one connection point is selected on a station with two connection points, you need to configure the station again and do all the tests again.</i></p>
Voltage Supply	<p>Set the voltage value of the voltage supply of the station. The default setting is 240 V.</p> <p>The Product uses the voltage value to determine the results of Nominal Voltage and Control Pilot tests See Nominal Voltage Test and Control Pilot Test.</p>
Max Charge Current	<p>Set the maximum charge current of the station. The default setting is 32 A.</p> <p style="text-align: center;"><i>Note</i></p> <p><i>If the max charge current of the station does not show in the list, select the most appropriate max charge current to use for tests.</i></p> <p>Use the max charge current setting to determine:</p> <ul style="list-style-type: none"> ● The test measurements and results in a Proximity Pilot test. See Proximity Pilot Test. ● The reported station amperage in a Control Pilot test. See Control Pilot Test.
Ventilation required	<p>When disabled, the Product uses Control Pilot states A, B, and C as the active charge state. Control Pilot state D shows as an error. The default setting is disabled.</p> <p>When enabled, the Product uses Control Pilot states A, B, and D as the active charge states.</p>

Table 7. Station Configuration Menu (FEV350)

Setting	Description
Station Type	<p>Set the station type. The default setting is Type 2 with cable.</p> <p>Type 1 with cable:</p> <ul style="list-style-type: none"> • L2 and L3 measurements are not available on tests. • 3 Φ is not available as a Voltage Supply option. • Uses 32 A Max Charge Current for Proximity Pilot tests. • Max Cable Ampacity is not available on tests. <p>Type 2 with cable:</p> <ul style="list-style-type: none"> • Uses Max Cable Ampacity for Proximity Pilot tests. <p>Type 2 with socket:</p> <ul style="list-style-type: none"> • Max Cable Ampacity is not available on tests.
Connection Points	<p>Set the number of socket outlet or fixed cable connection points (the Connection Points) on the Station. The maximum connection points on a station is two.</p> <p>The default setting is Connection Point 1.</p> <p style="text-align: center;"><i>Note</i></p> <p style="text-align: center;"><i>You cannot change the number of connection points in another menu. If only one connection point is selected on a station with two connection points, you need to configure the station again and do all the tests again.</i></p>
Protection Class	<p>Set the protection class of the housing of the station. The default setting is Protection Class I.</p> <p>With Protection Class II selected:</p> <ul style="list-style-type: none"> • In the Earth Bond Limits menu, Test Point does not show as an option. • In a station test menu, Earth Bond Housing test does not show, and the Product does not do a Earth Bond Housing test.



Table 7. Station Configuration Menu (FEV350) (cont.)

Setting	Description
Earth Bond Limit	<p>Set the limit in ohms to use on an earth bond test. See Earth Bond Configuration (FEV350). The default setting is 0.3 Ω.</p> <ul style="list-style-type: none"> ● Test Point: Use with an MFT to do an Earth Bond Housing test on the station. With Protection Class II selected, Test Point does not show. ● Connection Point: Use with an MFT to do an Earth Bond Connection Point test. Shows the number of connection points set.
Mains System	<p>Set the mains type of the station. The default setting is TN.</p> <p>The mains type of the station works together with the voltage set in Voltage Supply to define the current limits used in a Loop/Line Impedance and time limits used in a 30 mA RCD Trip tests. See Loop/Line Impedance Test and 30 mA RCD Trip Test.</p>
Voltage Supply	<p>Set the voltage value and number of phases of the voltage supply of the station. The default setting is 230 / 400 V 3 Φ.</p> <p>With 1 Φ selected, L2 and L3 measurements are not available on tests. See Insulation Input or Output Tests, Loop/Line Impedance Test. and Mains Voltage/Phase Sequence Test.</p> <p>The Product uses the voltage value to determine the results of:</p> <ul style="list-style-type: none"> ● Mains Voltage/Phase Sequence tests. See Mains Voltage/Phase Sequence Test. ● 30 mA RCD Trip tests. 30 mA RCD Trip Test.

Table 7. Station Configuration Menu (FEV350) (cont.)

Setting	Description
Fuse Type and Rating	<p>Set the fuse type of the station. Then set the fuse rating of the fuse type. The default fuse type is LS C. The default fuse rating is 20 A.</p> <p style="text-align: center;"><i>Note</i></p> <p style="text-align: center;"><i>If the fuse type or rating of the station does not show in the list, select the most appropriate fuse type or rating to use for tests.</i></p> <p>Use with an MFT to do a Loop/Line Impedance test on a connection point. The fuse type and rating uses standards to determine the limit for Loop/Line Impedance tests. See Loop/Line Impedance Test.</p>
Max Charge Current	<p>Set the maximum charge current of the station. The default setting is 16 A.</p> <p style="text-align: center;"><i>Note</i></p> <p style="text-align: center;"><i>If the max charge current of the station does not show in the list, select the most appropriate max charge current to use for tests.</i></p> <p>Use the max charge current setting to determine:</p> <ul style="list-style-type: none"> ● The test measurements and results in a Proximity Pilot test. See Proximity Pilot Test. ● The reported station amperage in a Control Pilot test. See Control Pilot Test.
Max Cable Ampacity	<p>With the station type set as Type 2 fixed cable, set the maximum amperage or current capacity of the cable. The default setting is 32 A.</p> <p>The Product uses the maximum cable ampacity to determine the test measurements and results of a Proximity Pilot test. See Proximity Pilot Test.</p>

Table 7. Station Configuration Menu (FEV350) (cont.)













Setting	Description
RCD Type	<p>Set the RCD type to enable the subtests in a 30 mA RCD Trip test. The default setting is Type A/F 30 mA.</p> <p>With the RCD type set to None, the 30 mA RCD Trip test does not show.</p> <p>The RCD type can affect RCD test steps and the shape of the RCD test current.</p>
RDC-DD	<p>Disable () the feature if the station does not have a 6 mA RDC-DD. With the feature disabled, the 6 mA RDC-DD test does not show in the test menu.</p> <p>Enable () the feature if the station has a 6 mA RDC-DD. With the feature enabled, the 6 mA RDC-DD test shows in the test menu. The default setting is enabled.</p> <p>With RDC-DD enabled:</p> <ul style="list-style-type: none"> • The RCD type affects RCD test steps and the shape of the RCD test current. • Loop measurements between L1, L2, or L3 and PE are not available.
Ventilation required	<p>When disabled, the Product uses Control Pilot states A, B, and C as the active charge state. Control Pilot state D shows as an error. The default setting is disabled.</p> <p>When enabled, the Product uses Control Pilot states A, B, and D as the active charge states.</p>

Earth Bond Configuration (FEV350)

Set the limit to use on Earth Bond Housing tests. Copy a test point to assign each metal piece on the station housing an individual test point. The maximum number of earth bond housing test points is 10. The default number of test points is one. If needed, delete a test point. Use the first Earth Bond Housing test point to measure the earth bond connection between the Station and the distribution panel.

Set the limit to use on Earth Bond Connection Point tests. To change the number of socket-outlet or vehicle connection points on the station, see **Connection Points** in [Table 7](#).

To configure a station to do an Earth Bond test:

1. Go to **Test > Project List**.
2. Select a project, select a station, and highlight **Earth Bond Limits**.
3. Push  (**Select**).
The Earth Bond Limits menu shows.
4. Push  /  to highlight a test point or a connection point.
5. Push  (**Select**).
The Earth Bond Limit menu shows.
6. Manually set the limit:
 - a. Push  /  to highlight a field.
 - b. Push  /  to increase or decrease the numeric value.
 - c. Push  (**Select**) to set the limit.
7. If necessary, add another Earth Bond Housing test point:
 - a. Push  /  to highlight a test point to copy.
 - b. Push  (**Copy**) to create another test point with the same limit setting as the original test point.
8. To delete an Earth Bond Housing test point, highlight a test point, and push  (**Delete**).

Connect the Plug

Figure 1 shows how to connect a plug to the Product.

Figure 1. Connect the Plug

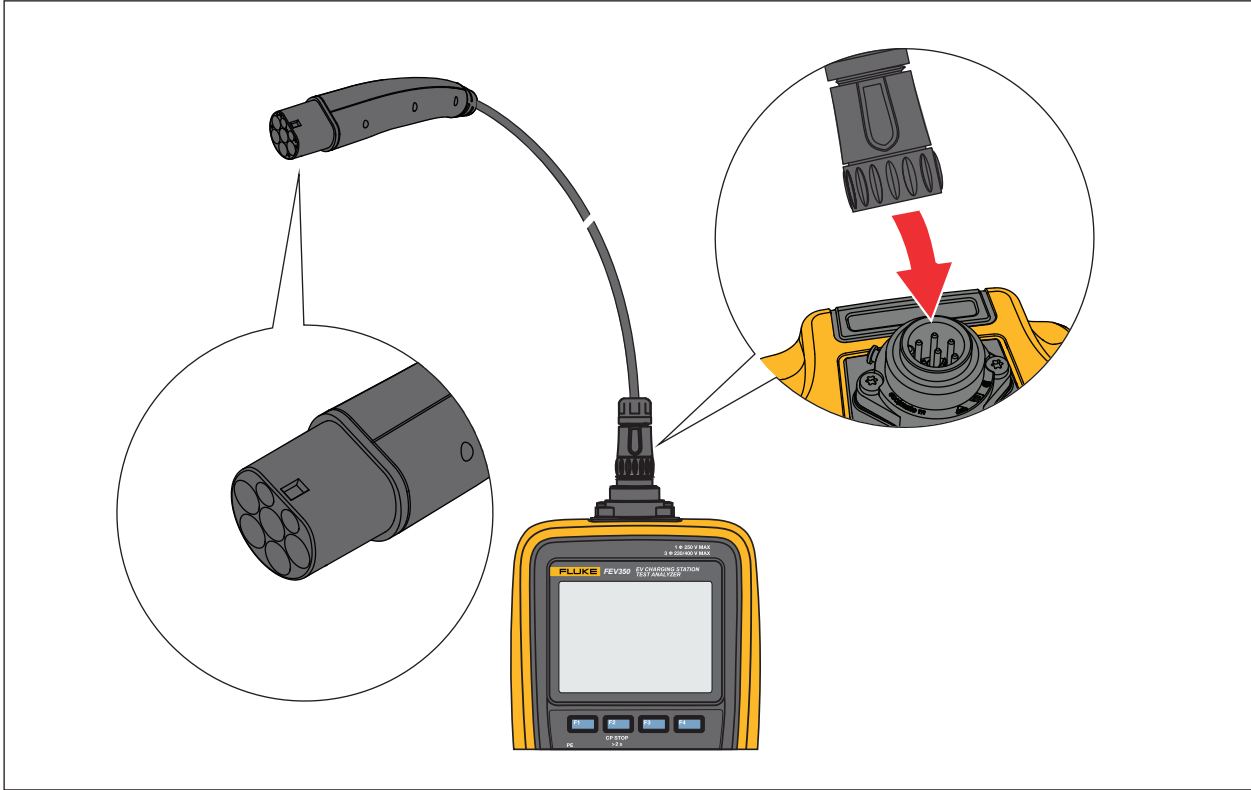

Connect the TPAK Strap

⚠️⚠️ Warning

Configure a station and do a PE Pre-Test and visual inspection test before you attach the TPAK strap to the station housing. See [Do a Test](#).

Figure 2 shows how to connect the TPAK magnetic strap to the Product.

Figure 2. Connect the TPAK Strap

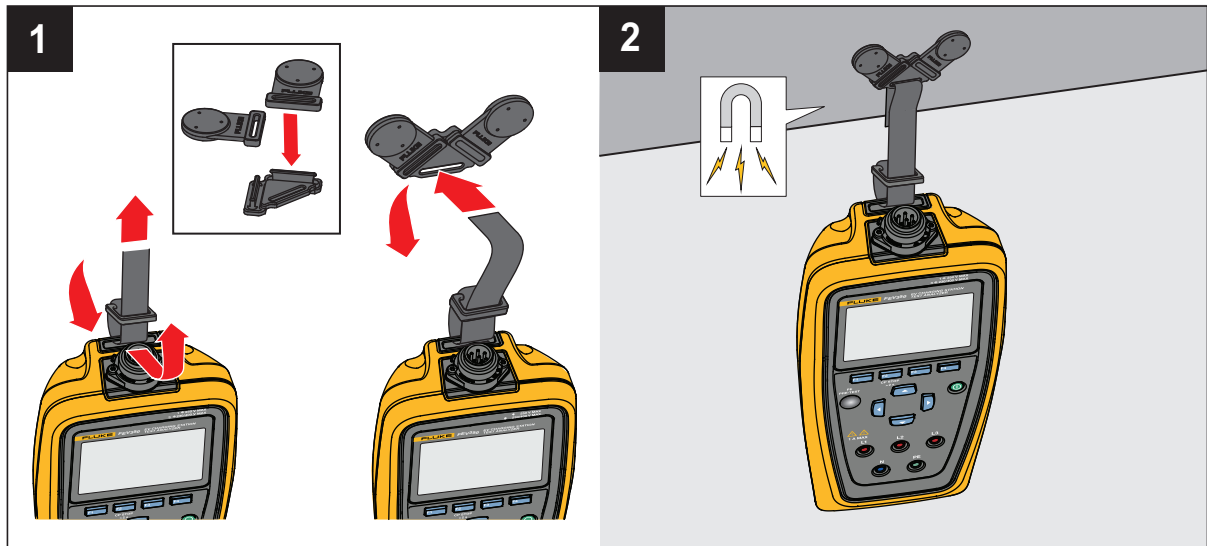

Station and Connection Point Tests

⚠⚠ Warning

Configure a station and do a PE Pre-Test and visual inspection test before you touch the station housing or do any other station or connection point tests.

Table 8 lists the Station and Connection Point tests the Product can do and notes which test requires an MFT to do the test. To connect the Product to an MFT, see Table 12.

Table 8. Tests

Test	FEV150	FEV350	Requires an MFT
Station Test			
PE Pre-Test	●	●	
Visual Inspection	●	●	
Earth Bond Housing		●	●
Insulation Input		●	●
Connection Point Test			
Earth Bond Connection Point		●	●
Insulation Output		●	●
Loop / Line Impedance		●	●
30 mA RCD Trip		●	
6 mA RDC-DD Trip		●	
Mains Voltage / Phase Sequence		●	
Nominal Voltage	●		
GFCI Trip Test	●		
Control Pilot	●	●	
Proximity Pilot	●	●	
Error Test	●	●	

Function Buttons in Tests

Table 9 shows some of the actions the function buttons may do. Not all functions are available in all tests.

Table 9. Function Buttons in Tests





Button	Function
 (F1)	<ul style="list-style-type: none"> ● Select: With a test highlighted, push to open the main menu of the test. ● Start: Push to start a test. ● Next: Push to do the next step of a test.
 (F2)	<ul style="list-style-type: none"> ● Back: Push to go back to the previous screen and not save changes or test results. ● Stop: Push to stop the test, go back to the main menu of the test to do the test again, and not save the results. ● Exit: Push to stop the test, go back to the station test menu., and not save the results. ● CP Stop >2 s: Push and hold for >2 s to turn off the control pilot, turn off the Station, and not save the results. See Figure 3.
 (F3)	<ul style="list-style-type: none"> ● Results: Push to view the results of a test.
 (F4)	<ul style="list-style-type: none"> ● ...: Push to show additional options. ● : Push to indicate a test is not applicable.

Figure 3. CP Stop



Symbols on Test Screens

Table 10 describes the symbols that can be on a test screen.

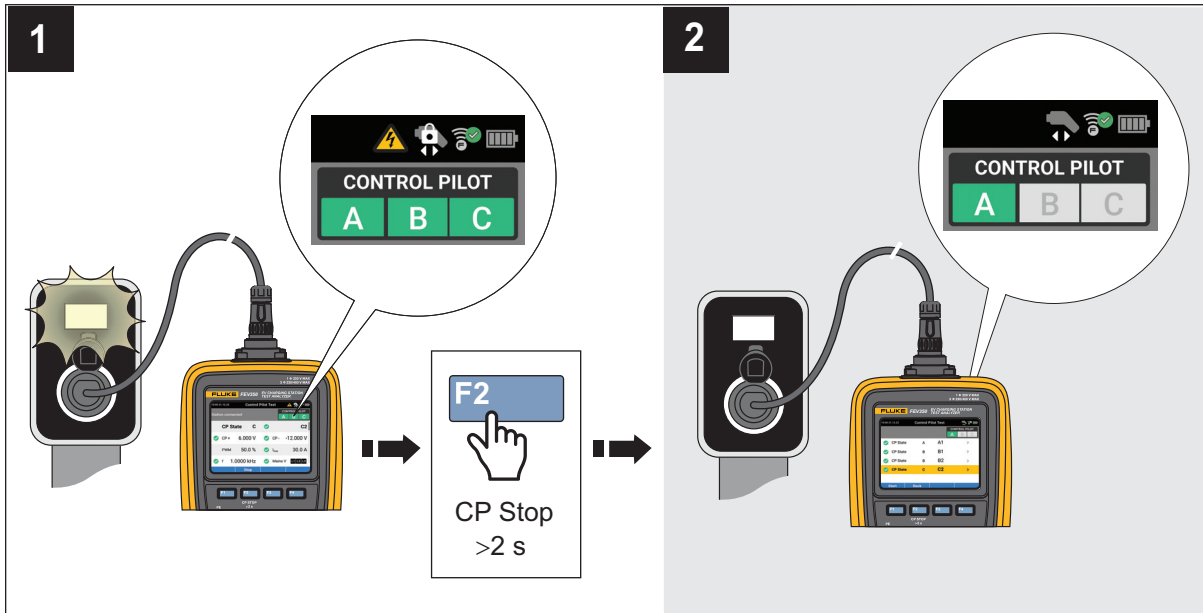
Table 10. Symbols on Test Screens

Symbol	Description	FEV150	FEV350
Test visibility			
^	Indicates a Station or Connection Point test menu is not open. Push F1 to open the menu to view the tests.	•	•
∨	Indicates a Station or Connection Point test menu is open. Not all tests may show on the display. Push F1 to hide the tests and see more items on the display.	•	•

Table 10. Symbols on Test Screens (cont.)























Symbol	Description	FEV150	FEV350
MFT required			
	Indicates a test requires a compatible MFT. To connect the Product to an MFT, see Table 12 .		●
Test status			
	A test is not started, or a test is in process and not completed.	●	●
	A test passed.	●	●
	A test failed.	●	●
	A test is not applicable.	●	●
Waveform indicator			
	An ac test that starts at 0°.		●
	An ac test that starts at 180°.		●
	A halfwave test that starts at 0°.		●
	A halfwave test that starts at 180°.		●
	A dc test that starts at 0°.		●
	A dc test starts at 180°.		●
	An RCD or RDC-DD ramp current test that may start at 0° or 180°.		●
RCD/RDC-DD or GFCI circuit status			
	Indicates an RCD or RDC-DD device has not been tripped.		●
	Indicates a GFCI device has not been tripped.	●	
Phase direction indicators			
	Indicates clockwise rotation.		●
	Indicates counter-clockwise rotation.		●

Table 10. Symbols on Test Screens (cont.)

Symbol	Description	FEV150	FEV350
Earth bond test current indicator			
	Indicates an earth bond test was taken with positive and negative test current. The Product shows the result of the one with the greatest resistance value.		●
Voltage detection indicator			
	Indicates the Product detects phase L1.	●	●
	Indicates the Product detects phase L2.	●	●
	Indicates the Product detects phase L3.		●
Control Pilot state indicator			
	Shows the state of the control pilot. <ul style="list-style-type: none"> ● Gray indicates the control pilot signal is off for the CP state. ● Yellow indicates the control pilot signal is in the process to determine if the signal is within the limits of the CP state. ● Green indicates the control pilot signal is within the limits for the CP state. ● Red indicates the control pilot signal is not within the limits for the CP state. 	●	●
CP activity status			
	Control Pilot is in state B, C, or D. Do not disconnect the plug from the Station.	●	●
	Control Pilot is in state A. You may disconnect the plug from the station.	●	●
High voltage indicator			
	WARNING. HAZARDOUS VOLTAGE. Risk of electric shock.	●	●

Do a Test

Warning

Configure a station and do a PE Pre-Test and visual inspection test before you touch the station housing or do any other station or connection point tests.

PE Pre-Test

Warning



Do not touch the housing of the charging station until the results show ≤ 50 V.

The PE Pre-Test is a safety feature of the Product. Do a PE Pre-Test to verify the protective earth (PE) conductor connects to the station and ground correctly before you do any other test.

The PE Pre-Test detects the presence of hazardous voltage on the Station housing and PE, but the test may not detect an open PE. An open PE is a PE connection that is not connected to ground and may be hazardous. An open PE can happen when the PE conductor is connected to phase or when PE is disconnected.

With incorrect connection to ground (for example, isolated placement of your body), the test result might not be accurate. Do not wear gloves.

To do a PE Pre-Test:

1. Set up and select a station.
2. Connect the Product to the charging station.
3. Highlight **PE Pre-Test**.
4. Push  (**Select**) to open the test menu.
5. Push  (**Start**) to start the test.

6. Touch and hold a bare finger to the **PE PRE-TEST** sensor (●) for 3 s.
7. Push  (**Next**) to view the result.

⚠⚠ Warning

If the result shows >50 V, stop the test immediately. There may be hazardous voltage present at the PE terminal and metal parts of the charging station.

Note

It might be important to do this test again after the mains voltage to the Station turns on.

Visual Inspection Test

Make sure a PE Pre-Test passes, before you do a Visual Inspection test. Use a checklist to visually inspect a station for signs of damage or hazardous conditions that might need repair before you do other tests. The visual inspection list on the Product is an example of items you can inspect. See the documentation provided by the manufacturer of the Station for specific visual inspection requirements.

⚠⚠ Warning

If a checklist item fails, make sure there are no hazardous conditions and that repairs are complete before you do any other station or connection point tests.

To do a visual inspection test:









1. Push  /  to highlight **Visual Inspection Test**.
2. Push  (**Select**) to open the test menu.
3. Push  /  to highlight an item.
4. Push the appropriate button to set an item on the checklist to pass, fail, or not applicable for a station. See [Table 11](#).

Table 11. Checklist Item Functionality

Button	Description
	Push to set a single item on the checklist to pass. Push and hold >2 s to set all items on the checklist to pass.
	Push to set a single item on the checklist to fail. Push and hold >2 s to set all items on the checklist to fail.
	Push to set a single item on the checklist to not applicable. Push and hold >2 s to set all items on the checklist to not applicable.

How to do Tests

To do a test:



1. If not done previously:
 - a. Set up and select a station.
 - b. Do a PE Pre-Test and a visual inspection test. See [PE Pre-Test](#) and [Visual Inspection Test](#).
2. If needed for the test, pair the Product with an MFT. See [Table 12](#).

Warning



For tests that use an MFT, connect the test leads to the MFT and then to the Product.



Note

For tests that use an MFT, the Product shows the settings to use on the MFT in red. The settings on the Product change to green when the settings are set correctly on the MFT.

3. Push  /  to highlight a Station or Connection Point test.
4. Push  (**Select**) to open a test menu to do a test.

A test screen shows on the display.

5. If necessary, highlight a test.
6. Push  (**Start**) to start the test and overwrite existing results if  or .
7. Follow the instructions on the display to do the test.

If necessary while in a test, push  (**Back**) to go back to the previous screen, or push  (**Stop**) to stop the test and go back to the project and station test menu.

Earth Bond Tests

The tests require a compatible MFT and uses the limit set in the station configuration menu. See [Configure a Station](#).

An earth bond housing test measures the resistance of the earth from the ground pin of the mains supply of the Station to the housing of the Station.

An earth bond connection point test measures the resistance of the PE connection from the mains supply of the Station to the Connection Points of the Station.

Insulation Input or Output Tests

An insulation input test measures the integrity of the insulation of the wires from the mains into the Station. An insulation output test measures the integrity of the insulation of the wires from the Station to the Product. The tests require a compatible MFT.

The tests use a fixed limit of 1 M Ω to determine the results.

Loop/Line Impedance Test

Loop and line impedance tests measure the impedance of the electrical system. The test measures the impedance and calculates the prospective fault current and earth fault current in the system to make sure sufficient current flows to open a breaker or fuse.

The test uses the limit set in the station configuration menu based on the fuse type and rating. See [Configure a Station](#).

With RDC-DD set to , the Product may run a loop and line impedance test.

With RDC-DD set to , the Product runs a line test only.

With RDC-DD set to , a loop impedance test causes the circuit of the RDC-DD to open.

30 mA RCD Trip Test

Trip Time: The test applies a ground fault or current imbalance to make sure a 30 mA RCD opens the circuit in the time listed in the standard based on the Mains System, Voltage Supply, and RCD Type set in the Station Configuration menu. See [Configure a Station](#).

Trip Current: The test applies ground faults or current imbalance of different current levels to make sure a 30 mA RCD opens the circuit at the sufficient current listed in the standard based on the settings in the station configuration menu. See [Configure a Station](#).

6 mA RDC-DD Trip Test

Trip Time: The test applies a ground fault or current imbalance to make sure a 6 mA RDC-DD opens the circuit in the time listed in the standard.

Trip Current: The test applies ground faults or current imbalance of different current levels to make sure a 6 mA RDC-DD opens the circuit at the sufficient current listed in the standard.

Mains Voltage/Phase Sequence Test

The mains voltage test measures the voltage and frequency the Station outputs to the Connection Points. In a test of a three phase system, the test also determines if the phase rotation is in the correct sequence.

Nominal Voltage Test

The nominal voltage test measures the voltage and frequency the Station outputs to the Connection Points.

GFCI Trip Test

In North America, a station is required to use a GFCI device to protect the user. On many stations, after the GFCI device trips, the GFCI device automatically resets to protect the user. When you push the GFCI button on the Station, the Station should terminate the charging cycle.

Control Pilot Test



The Control Pilot test makes sure the Control Pilot signal from the Station has the correct voltage, frequency, and duty cycle for the Station Type set in the station configuration menu. See [Configure a Station](#).

The test measures the CP signal of the Station while the Station changes from CP state A to CP state C and makes sure the signal meets the limit in the standard.

The test converts the duty cycle to I_{max} . The Product saves up to 10 changes in CP state and output voltage L1/L2/L3 on the FEV350 and L1/L2 on the FEV150.

With a test complete, the display shows a summary list of the events.

To see more information about the results:

1. To see the details of each event, push  (**Results**).
2. To view the results in a table or as a curve diagram, push  / .

Proximity Pilot Test

For a Station with a charge cable that is attached to the Station, a Proximity Pilot (PP) test makes sure the current coding resistors or auxiliary switch with resistors are the correct values and the resistors work properly in the charge cable of the Station.

For a Station with a socket-outlet connection, the FEV350 simulates the current capability of different cable assemblies. The test makes sure the indicated charge current on the Control Pilot signal does not exceed the maximum allowable current of the simulated charge cable or the max charge current of the Station set in the station configuration menu. See [Configure a Station](#).

A proximity pilot test shows the max output current of the Station and makes sure the output current and power are in the allowable range required by the electrical energy provider.

Error Test

The test applies various error states to the Control Pilot signal to make sure the Station recognizes the errors and disconnects voltage and power until the error is resolved.

After an error is applied, you might need to turn off the Station and then turn on the Station again. Refer to the documentation of the Station.

Settings Menu

Table 12 is a list of the options available in the Settings menu. When the Product is turned off and back on, the Product uses the last saved settings.

To change settings:









1. Push  /  to highlight the Settings menu.
2. Push  (**Select**) to open an option menu.
3. Push  /  to highlight a selection.
4. For options with toggles, push  /  to toggle the feature.
5. Push  (**Select**) to set the selection and go back to the previous screen, or push  (**Back**) to cancel the changes and return to the previous screen.

Table 12. Settings Menu

Option	Description
Pair with MFT (FEV350)	Follow the instructions on the display to pair the Product with a Fluke MFT. With more than one MFT on and in FC mode, the Product pairs with the MFT with the strongest signal. To pair with a specific MFT, turn off all MFTs except for the MFT you want to pair to.
Firmware Version	Shows the firmware version of the Product.
Hardware Version	Shows the hardware version of the Product.
Serial Number	Shows the serial number of the Product.
Display Settings	Use to set the brightness level of the display.
Auto Power Off	Use to set the time until the Product turns off automatically.



Table 12. Settings Menu (cont.)

Option	Description
Sounds	Use to turn on or off: <ul style="list-style-type: none"> • Basic sound settings such as sounds that indicate button pushes. • Pass and Fail condition sounds such as when a test fails based on the requirements for the test.
Factory Reset	Deletes all settings and test results, and resets the Product to the factory default settings.
Product Registration	Shows a QR code to scan to register the Product.
Product Information	View some of the product specifications (FEV350), all the radio approved certificates, and the last calibration date of the Product. For the complete product specifications, see the FEV150/FEV350 Product Specifications document on fluke.com .
Language	Use to select a language.

Manual CP Menu

Use the Manual CP screen to troubleshoot a station. The test uses the Voltage Supply value set in the Station Configuration menu. See [Configure a Station](#). The results cannot be saved to TruTest software.

To manually troubleshoot a station:

1. Push  /  to highlight **Manual CP**.
2. Push  (**Select**) to open the test menu.

The Manual CP screen opens. The Product uses default settings to do a test automatically, and the results show on the display.

The FEV150 default settings are:







- CP State: **A**
- Value: -
- Error: **None**

With CP State A selected, Value cannot be set. To set the Value to Low, Nominal, or High, select CP State B, C, or D.

The FEV350 default settings are:

- CP State: **A**
- Value: -
- PP: **32 A**
- Error: **None**





To change settings and do a test:



- a. Push  (**Edit**) to open the Manual CP settings menu.
- b. Push  (**Select**) to open a submenu.
- c. Push  /  to highlight a selection.
- d. Push  (**Select**) to set the selection.
- e. With the selections set, push  (**Apply**) to use the selections to do a test.

Troubleshoot GFCI Menu

Use to troubleshoot the GFCI circuit of the Station. The results cannot be saved to TruTest software.

To troubleshoot the GFCI circuit of the Station:



1. Push  /  to highlight **Troubleshoot GFCI**.
2. Push  (**Select**) to open the test menu.
3. Push  /  to highlight a selection.

4. Push  (**Select**) to set the selection.
5. Push  (**Start**) to start the test.
6. If the GFCI trips, the seconds show on the display to indicate the length of time the GFCI took to trip. If the GFCI does not trip,  shows on the display.

TruTest™ Software Menu

Use Bluetooth to connect the Product to TruTest software on a PC. To download TruTest software, go to: <https://www.fluke.com/en-us/support/software-downloads/trutest-software-downloads>.

To connect the Product to TruTest software:

1. Push  /  to highlight the TruTest menu.
2. Push  (**Select**) to open the menu.
3. Follow the on-screen instructions to connect the Product to TruTest software.

Maintenance

Periodically wipe the case with a damp cloth and mild detergent. Do not use abrasives or solvents. Dirt or moisture in the terminals can affect readings.

Warning

To prevent possible electrical shock, fire, or personal injury:

- **Do not open the case. You cannot repair or replace parts in the case.**
- **Remove the input signals before you clean the Product.**
- **Have an approved technician repair the Product.**

Clean the Product

Clean the case and display with a soft cloth dampened with water and a mild soap solution. Do not use solvents, isopropyl alcohol, or abrasive cleansers.

To clean the ports, use a pressurized can of air or a dry nitrogen-ion gun, if available, to blow the particulates from the ports.

Battery Replacement

Figure 4 shows how to replace the batteries.

Figure 4. Battery Replacement

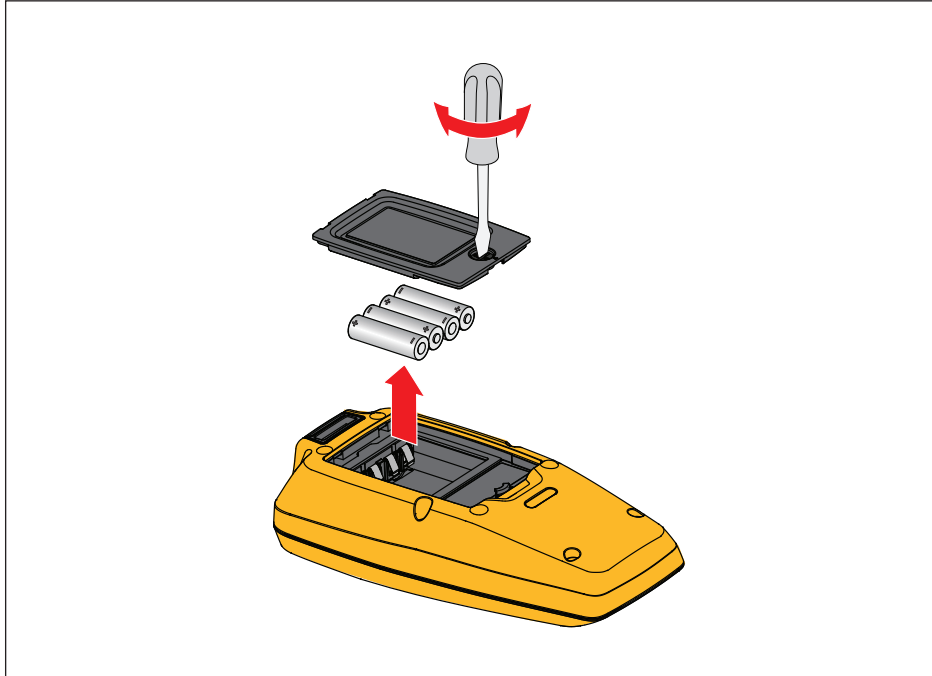

Product Disposal

Dispose of the Product in a professional and environmentally sound manner:

- Delete personal data on the Product before disposal.
- Remove batteries that are not integrated into the electrical system before disposal and dispose of batteries separately.
- If this Product has an integral battery, put the entire Product in the electrical waste.

All Product names are trademarks of their respective companies. Specifications are subject to change without notice. Fluke Corporation. All rights reserved.

