

Safety IEC 60950-1 Overvoltage Category II

Electromagnetic

Compatibility (EMC) IEC 61326-1: Industrial Electromagnetic Environment

CISPR 11: Group 1, Class A

Group 1: Equipment has intentionally generated and/or use conductively coupled radio-frequency energy which is necessary for the internal functioning of the equipment itself.





Class A: Equipment is suitable for use in all establishments other than domestic and those directly connected to a low voltage power supply network which supplies buildings used for domestic purposes. There may be potential difficulties in ensuring electromagnetic compatibility in other environments, due to conducted and radiated disturbances.

Korea (KCC) Class A Equipment (Industrial Broadcasting & Communication Equipment)

Class A: Equipment meets requirements for industrial electromagnetic wave equipment and the seller or user should take notice of it. This equipment is intended for use in business environments and not to be used in homes.

Symbols

Symbols used on the Product and in this document are explained below.

Symbol	Description
	Consult user documentation.
	WARNING - RISK OF DANGER. Consult user documentation.
	WARNING. HAZARDOUS VOLTAGE. Risk of electric shock.
	Conforms to European Union directives.
	This product complies with the WEEE Directive marking requirements. The affixed label indicates that you must not discard this electrical/electronic product in domestic household waste. Product Category: With reference to the equipment types in the WEEE Directive Annex I, this product is classed as category 9 "Monitoring and Control Instrumentation" product. Do not dispose of this product as unsorted municipal waste.

LIMITED WARRANTY AND LIMITATION OF LIABILITY

This Fluke product will be free from defects in material and workmanship for one year from the date of purchase. This warranty does not cover fuses, disposable batteries, or damage from accident, neglect, misuse, alteration, contamination, or abnormal conditions of operation or handling. Resellers are not authorized to extend any other warranty on Fluke's behalf. To obtain service during the warranty period, contact your nearest Fluke authorized service center to obtain return authorization information, then send the product to that Service Center with a description of the problem.

THIS WARRANTY IS YOUR ONLY REMEDY. NO OTHER WARRANTIES, SUCH AS FITNESS FOR A PARTICULAR PURPOSE, ARE EXPRESSED OR IMPLIED. FLUKE IS NOT LIABLE FOR ANY SPECIAL, INDIRECT, INCIDENTAL OR CONSEQUENTIAL DAMAGES OR LOSSES, ARISING FROM ANY CAUSE OR THEORY. Since some states or countries do not allow the exclusion or limitation of an implied warranty or of incidental or consequential damages, this limitation of liability may not apply to you.

Fluke Corporation
P.O. Box 9090
Everett, WA 98206-9090
U.S.A.

Fluke Europe B.V
P.O. Box 1186
5602 BD Eindhoven
The Netherlands

ООО «Флюк СИАЙЭС»
125167, г. Москва,
Ленинградский проспект
дом 37,
корпус 9, подъезд 4, 1 этаж

EDBC290

External Dual-Bay Battery Charger

Instructions

Introduction

EDBC290 (the Product or Charger) is an external battery charger for compatible Li-ion batteries used in Fluke test tools. A separate mains-power adapter is included to provide 19 V dc at 3.16 A maximum.

The EDBC290 is an SMBus master mode smart charger with a microprocessor-controlled charging circuit for Li-ion batteries. The dual-bay holds one or two batteries and automatically controls the charging process. LED indicators, one for each battery bay, show the charge status.

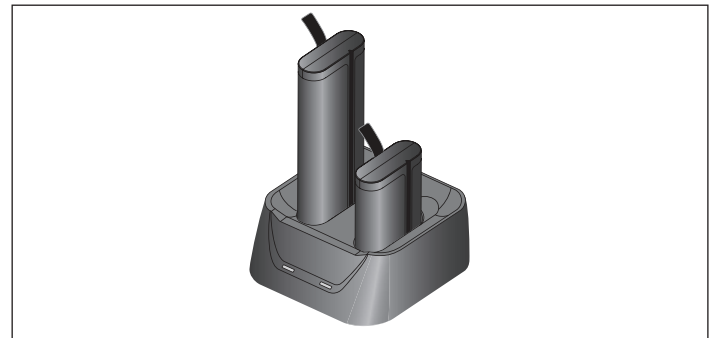

How to Contact Fluke

To contact Fluke, call one of the following telephone numbers:

- Technical Support USA: 1-800-44-FLUKE (1-800-443-5853)
- Calibration/Repair USA: 1-888-99-FLUKE (1-888-993-5853)
- Canada: 1-800-36-FLUKE (1-800-363-5853)
- Europe: +31 402-675-200
- Japan: +81-3-6714-3114
- Singapore: +65-6799-5566
- China: +86-400-921-0835
- Brazil: +55-11-3530-8901
- Anywhere in the world: +1-425-446-5500

Or, visit Fluke's website at www.fluke.com.

To register your product, visit <http://register.fluke.com>.

To view, print, or download the latest manual supplement, visit <http://us.fluke.com/usen/support/manuals>.

PN 5099121
May 2019

© 2019 Fluke Corporation. All rights reserved.
Product specifications are subject to change without notice.



FLU0040_247_01061

Safety Information

A **Warning** identifies conditions and procedures that are dangerous to the user.

⚠ ⚠ Warning

To prevent possible electrical shock, fire, or personal injury:

- Read these instructions carefully before using the Product.
- Do not alter the Product and use only as specified, or the protection supplied by the Product can be compromised.
- Do not use the Product if it is altered or damaged.
- Before each use, inspect the Dual-bay Charger, the Battery Pack, the Power Adapter and mains cord for any damage. Do not use parts that are cracked or damaged. Use only the mains power cord and connector approved for the voltage and plug configuration in your country and rated for the Product.
- Do not open the Product, it has no user-serviceable parts inside.
- Replace the mains power cord if the insulation is damaged or if the insulation shows signs of wear.
- Use the Product only for charging Li-ion batteries as specified for use with Fluke test tools.
- Use the provided power adapter only or the Product safety features may become inoperative or the Charger may become defective.
- Read the instructions for safe use and handling of Li-ion batteries, see the instruction sheet for the battery.
- Adhere to local and national safety codes concerning the use and disposal of Charger and Li-ion Batteries.

Unpack

Check the contents of the shipping box for completeness. If a part is missing or damaged, contact the Fluke distributor or the nearest sales or service office.

The EDBC290 includes:

- Dual-Bay Battery Charger (Totex U85104)
- Universal Mains Power Adapter, 19 Vdc at 3.16 A maximum (Channel Well Technology KPL-060K-VI)
- Universal Power Cord (male to female, according IEC 60320 style C13 and C14).
- Set of Power Plug Adapters supporting different types of wall outlets
- Instructions (this document).
- Slot Insert Caps (x2), inserted in charging bays. Keep installed for charging the Fluke supported batteries.

Operation

To set up and charge a battery:

1. Connect the mains power adapter to a mains outlet.
2. Insert the DC plug of the power adapter into the Charger.

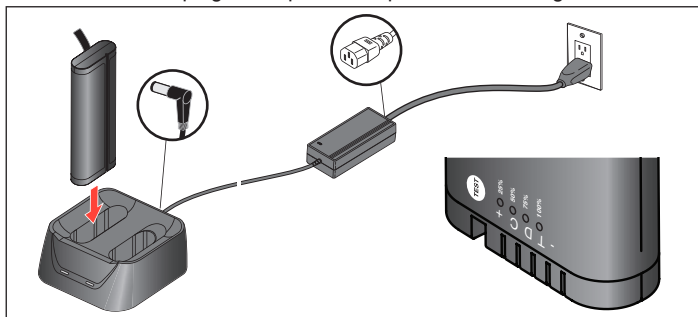

3. Insert one or two batteries into the external Charger. Be careful to correctly align the battery contacts.
4. Observe the LED indicators on the Charger:

LED state	Charger status
Off	Power on or standby
Green, blinking	Charge in progress
Green, steady on	Charge complete
Red, steady on	Battery or charger error

After charging, press the TEST button on the battery to check the battery charge. The four built-in LEDs show the current status.

Cleaning

Before cleaning, separate the Charger from the power adapter and battery. Disconnect the power adapter from the mains and mains cord.

Use a damp cloth and a mild detergent to clean the Charger and power adapter. Do not use abrasives, solvents, or alcohol.

Troubleshooting

In case of an error, the LEDs in the Charger flash at a high rate to indicate a possible battery problem. Insert a known good battery to determine if the error is caused by the battery or by a defective Charger.

Specifications

Charger Bay

DC input voltage	19 V dc input, center contact positive	
Adapter requirement	19 Vdc / 3.16 A	
Input voltage range	15 V dc to 23 V dc	

Supported Batteries: BP291, BP290

Voltage	10.8 V nominal (3S)
Charging current	3.16 A, dynamically controlled
Capacity	
BP291	5000 mAh
BP290	2500 mAh

Mains Power Adapter

AC input voltage	100 V ac to 240 Vac (± 10 %), 47 Hz to 63 Hz	
AC input current	1.7 A	
AC inlet	IEC 60320, style C14	
Power rating	60 W	
Maximum output current	3.16 A	
DC output voltage	19 V dc ± 5 %	
Output polarity	center contact positive	
DC output cable length	1.5 m	

Environmental

Operating temperature	0 °C to 40 °C (determined by battery)
Storage temperature	-20 °C to 60 °C
Maximum relative humidity	10 % to 90 %, non-condensing recovery time: 2 hours
Maximum altitude	2000 m

Dimensions

Charger bay	125 mm x 122 mm x 54 mm
Mains power adapter	115 mm x 52 mm x 32 mm

Weight

Charger bay	0.265 kg
Mains power adapter	0.250 kg
Mains cable and plug set	0.475 kg