

FLUKE®

Calibration

9141

Dry-well Calibrator

User's Guide

PN 3729494
January 2013

© 2013 Fluke Corporation. All rights reserved. Specifications are subject to change without notice.
All product names are trademarks of their respective companies.

Table of Contents

1	Before You Start	1
1.1	Symbols Used	1
1.2	Safety Information	2
1.2.1	WARNINGS	2
1.2.2	CAUTIONS	4
1.3	Authorized Service Centers.	6
2	Introduction	9
3	Specifications and Environmental Conditions	11
3.1	Specifications	11
3.2	Environmental Conditions.	11
3.3	Warranty.	12
4	Quick Start	13
4.1	Unpacking	13
4.2	Set-Up	13
4.3	Power	14
4.4	Setting the Temperature	14
5	Parts and Controls	15
5.1	Bottom Panel	15
5.2	Front Panel	16
5.3	Constant Temperature Block Assembly	17
5.3.1	Constant Temperature Block	17
5.3.2	Probe Sleeves and Tongs	18
6	General Operation	19
6.1	Changing Display Units	19
6.2	Switching to 230V Operation	19
7	Controller Operation.	21
7.1	Well Temperature	21
7.2	Temperature Set-point.	21
7.2.1	Programmable Set-points	21
7.2.2	Set-point Value	23
7.2.3	Temperature Scale Units	23

7.3	Scan	24
7.3.1	Scan Control	24
7.3.2	Scan Rate	24
7.4	Temperature Display Hold	25
7.4.1	Hold Temperature Display	25
7.4.2	Mode Setting	25
7.4.3	Switch Wiring	25
7.4.4	Switch Test Example	26
7.5	Secondary Menu.	26
7.6	Heater Power	26
7.7	Proportional Band	27
7.8	Controller Configuration	28
7.9	Calibration Parameters	28
7.9.1	R.	29
7.9.2	ALPHA	29
7.9.3	DELTA	29
7.10	Operating Parameters	29
7.11	Serial Interface Parameters	30
7.11.1	Baud Rate	30
7.11.2	Sample Period.	31
7.11.3	Duplex Mode	31
7.11.4	Linefeed.	31
8	Digital Communication Interface	33
8.1	Serial Communications	33
8.1.1	Wiring	33
8.1.2	Setup	33
8.1.2.1	Baud Rate	34
8.1.2.2	Sample Period.	34
8.1.2.3	Duplex Mode	34
8.1.2.4	Linefeed.	34
8.1.3	Serial Operation.	34
8.2	Interface Commands	35
9	Test Probe Calibration	39
9.1	Calibrating a Single Probe.	39
9.2	Dry-well Characteristics.	39
9.2.1	Heating and Cooling Rates	39
9.2.2	Stabilization and Accuracy	39
10	Calibration Procedure	43
10.1	Calibration Points	43
10.2	Calibration Procedure	43
10.2.1	Compute DELTA:	43
10.2.2	Compute R & ALPHA:	44

10.2.3	Accuracy & Repeatability.	45
11	Maintenance	47
12	Troubleshooting.	49
12.1	Troubleshooting Problems, Possible Causes, and Solutions	49
12.2	CE Comments	50
12.2.1	EMC Directive	50
12.2.2	Low Voltage Directive (Safety).	51

Figures and Tables













Table 1 International Electrical Symbols 1
Figure 1 Heat shield installed on 9141calibrator 5
Figure 2 9141 Back Panel and Bottom 15
Figure 3 9141 Front Panel 16
Figure 4 Inserts available for the 9141 block assembly 17
Figure 5 Controller Operation Flowchart 22
Figure 6 Serial Cable Wiring 33
Table 2 9141 controller communications commands. 36
Table 2 9141 communication commands continued 37
Figure 7 Typical Heating Rate. 41
Figure 8 Typical Cooling Rate. 41



1 Before You Start

1.1 Symbols Used

Table 1 lists the International Electrical Symbols. Some or all of these symbols may be used on the instrument or in this manual.

Table 1 International Electrical Symbols

Symbol	Description
	AC (Alternating Current)
	AC-DC
	Battery
	CE Complies with European Union Directives
	DC
	Double Insulated
	Electric Shock
	Fuse
	PE Ground
	Hot Surface (Burn Hazard)
	Read the User's Manual (Important Information)
	Off
	On

Symbol	Description
	Canadian Standards Association
CAT II	OVERVOLTAGE (Installation) CATEGORY II, Pollution Degree 2 per IEC1010-1 refers to the level of Impulse Withstand Voltage protection provided. Equipment of OVERVOLTAGE CATEGORY II is energy-consuming equipment to be supplied from the fixed installation. Examples include household, office, and laboratory appliances.
	C-TIC Australian EMC Mark
	The European Waste Electrical and Electronic Equipment (WEEE) Directive (2002/96/EC) mark.

1.2 Safety Information

Use this instrument only as specified in this manual. Otherwise, the protection provided by the instrument may be impaired.

The following definitions apply to the terms “Warning” and “Caution”.

- “Warning” identifies conditions and actions that may pose hazards to the user.
- “Caution” identifies conditions and actions that may damage the instrument being used.

1.2.1 WARNINGS

To avoid personal injury, follow these guidelines.

GENERAL

- **DO NOT** use this instrument in environments other than those listed in the User’s Guide.
- Inspect the instrument for damage before each use. **DO NOT** use the instrument if it appears damaged or operates abnormally.
- Follow all safety guidelines listed in the user’s manual.
- Calibration Equipment should only be used by Trained Personnel.
- If this equipment is used in a manner not specified by the manufacturer, the protection provided by the equipment may be impaired.
- Before initial use, or after transport, or after storage in humid or semi-humid environments, or anytime the dry-well has not been energized for more than 10 days, the instrument needs to be energized for a "dry-out" period of 2 hours before it can be assumed to meet all of the safety requirements of the IEC 1010-1. If the product is wet or has been in a wet environment, take necessary measures to remove moisture prior to apply-

ing power such as storage in a low humidity temperature chamber operating at 50°C for 4 hours or more.

- **DO NOT** use this instrument for any application other than calibration work. The instrument was designed for temperature calibration. Any other use of the instrument may cause unknown hazards to the user.
- Completely **unattended operation is not recommended**.
- Overhead clearance is required. **DO NOT** place the instrument under a cabinet or other structure. Always leave enough clearance to allow for safe and easy insertion and removal of probes.
- If the instrument is used in a manner not in accordance with the equipment design, the operation of the dry-well may be impaired or safety hazards may arise.
- This instrument is intended for indoor use only.

BURN HAZARDS

- **DO NOT** turn the instrument upside down with the inserts in place; the inserts will fall out.
- **DO NOT** operate near flammable materials.
- Use of this instrument at **HIGH TEMPERATURES** for extended periods of time requires caution.
- **DO NOT** touch the well access surface of the instrument.
- The block vent may be very hot due to the fan blowing across the heater block of the dry-well.
- The temperature of the well access is the same as the actual display temperature, e.g. if the instrument is set to 375°C and the display reads 375°C, the well is at 375°C.
- For top loading dry-wells, the top sheet metal of the dry-well may exhibit extreme temperatures for areas close to the well access.
- The air over the well can reach temperatures greater than 200°C for high temperature (400°C and higher) dry-wells. **Note:** Probes and inserts may be hot and should only be inserted and removed from the instrument when the instrument is set at temperatures less than 50°C. Use extreme care when removing hot inserts.
- **DO NOT** turn off the instrument at temperatures higher than 100°C. This could create a hazardous situation. Select a set-point less than 100°C and allow the instrument to cool before turning it off.
- The high temperatures present in dry-wells designed for operation at 300°C and higher may result in fires and severe burns if safety precautions are not observed.

ELECTRICAL SHOCK

- These guidelines must be followed to ensure that the safety mechanisms in this instrument will operate properly. This instrument must be plugged

into a 115 VAC, 60Hz (230 VAC, 50Hz optional), AC only electric outlet. The power cord of the instrument is equipped with a three-pronged grounding plug for your protection against electrical shock hazards. It must be plugged directly into a properly grounded three-prong receptacle. The receptacle must be installed in accordance with local codes and ordinances. Consult a qualified electrician. **DO NOT** use an extension cord or adapter plug.

- If supplied with user accessible fuses, always replace the fuse with one of the same rating, voltage, and type.
- Always replace the power cord with an approved cord of the correct rating and type.
- **HIGH VOLTAGE** is used in the operation of this equipment. **SEVERE INJURY** or **DEATH** may result if personnel fail to observe safety precautions. Before working inside the equipment, turn power off and disconnect power cord.

1.2.2 CAUTIONS

To avoid possible damage to the instrument, follow these guidelines.

- Always operate this instrument at room temperature between 41°F and 122°F (5°C to 50°C). Allow sufficient air circulation by leaving at least 6 inches (15 cm) of clearance around the instrument.
- Component lifetime can be shortened by continuous high temperature operation.
- Hart Scientific strongly recommends using the heat shield (Figure 1) provided while operating the calibrator at temperatures above 200°C. The heat shield protects the hub on the probes from heat and reduces the risk of the user being burned by the hub. The heat shield gets very hot and

does not prevent all heat from reaching the hub. Be careful when removing the heat shield or the probe from the well.



Figure 1 Heat shield installed on 9141 calibrator

- **DO NOT** apply any type of voltage to the display hold terminals. Applying a voltage to the terminals may cause damage to the controller.
- **DO NOT** use fluids to clean out the well. Fluids could leak into electronics and damage the instrument.
- **Never introduce any foreign material** into the probe hole of the insert. Fluids, etc. can leak into the instrument causing damage.
- **DO NOT** change the values of the calibration constants from the factory set values. The correct setting of these parameters is important to the safety and proper operation of the calibrator.
- **DO NOT** slam the probe sheath in to the well. This type of action can cause a shock to the sensor and affect the calibration.
- The instrument and any thermometer probes used with it are sensitive instruments that can be easily damaged. Always handle these devices with care. **DO NOT** allow them to be dropped, struck, stressed, or overheated.
- The Factory Reset Sequence (see Section 12, Troubleshooting) should be performed only by authorized personnel if no other action is successful in correcting a malfunction. You must have a copy of the most recent Report of Calibration to restore the calibration parameters.

- **DO NOT** operate this instrument in an excessively wet, oily, dusty, or dirty environment. Always keep the well and inserts clean and clear of foreign material.
- The dry-well is a precision instrument. Although it has been designed for optimum durability and trouble free operation, it must be handled with care. Always carry the instrument in an upright position to prevent the probe sleeves from dropping out. The convenient handle allows for hand carrying the instrument.
- If a mains supply power fluctuation occurs, immediately turn off the instrument. Power bumps from brown-outs could damage the instrument. Wait until the power has stabilized before re-energizing the instrument.
- Allow for probe expansion inside the well as the block heats.
- Most probes have handle temperature limits. Be sure that the probe handle temperature limit is not exceeded in the air above the instrument.

1.3 Authorized Service Centers

Please contact one of the following authorized Service Centers to coordinate service on your Hart product:

Fluke Corporation, Hart Scientific Division

799 E. Utah Valley Drive
American Fork, UT 84003-9775
USA

Phone: +1.801.763.1600
Telefax: +1.801.763.1010
E-mail: support@hartscientific.com

Fluke Nederland B.V.

Customer Support Services
Science Park Eindhoven 5108
5692 EC Son
NETHERLANDS

Phone: +31-402-675300
Telefax: +31-402-675321
E-mail: ServiceDesk@fluke.nl

Fluke Int'l Corporation

Service Center - Instrimpex

Room 2301 Sciteck Tower
22 Jianguomenwai Dajie
Chao Yang District
Beijing 100004, PRC
CHINA

Phone: +86-10-6-512-3436
Telefax: +86-10-6-512-3437
E-mail: xingye.han@fluke.com.cn

Fluke South East Asia Pte Ltd.

Fluke ASEAN Regional Office
Service Center
60 Alexandra Terrace #03-16
The Comtech (Lobby D)
118502
SINGAPORE

Phone: +65 6799-5588
Telefax: +65 6799-5588
E-mail: antng@singa.fluke.com

When contacting these Service Centers for support, please have the following information available:

- Model Number
- Serial Number
- Voltage
- Complete description of the problem

2 Introduction

The Hart Scientific 9141 High-Temp Field Calibrator may be used as a portable instrument or bench top temperature calibrator for calibrating thermocouple and RTD temperature probes. The 9141 is small enough to use in the field, and accurate enough to use in the lab. Calibrations may be done over a range of 50°C to 650°C (122°F to 1202°F). Temperature display of the 9141 is 0.1 degrees.

The dry-well calibrator features:

- Rapid heating and cooling
- Interchangeable multiple hole probe sleeves
- Convenient handle
- RS-232 interface
- Switchable AC Input (115 VAC or 230 VAC)

Built in programmable features include:

- Temperature scan rate control
- Temperature switch hold
- Eight Setpoint memory
- Adjustable readout in °C or °F

The temperature is accurately controlled by Hart's hybrid analog/digital controller. The controller uses a precision platinum RTD as a sensor and controls the well temperature with a solid state relay (triac) driven heater.

The LED front panel continuously shows the current well temperature. The temperature may be easily set with the control buttons to any desired temperature within the specified range. The calibrator's multiple fault protection devices insure user and instrument safety and protection.

The 9141 dry-well calibrator was designed for portability, low cost, and ease of operation. Through proper use, the instrument will provide continued accurate calibration of temperature sensors and devices. The user should be familiar with the safety guidelines and operating procedures of the calibrator as described in the instruction manual.

3 Specifications and Environmental Conditions

3.1 Specifications

Power	115 VAC ($\pm 10\%$), 50–60 Hz, 1000 Watts and 230 VAC ($\pm 10\%$), 50–60 Hz, switchable
Ambient Temperature	5–50°C (41–121°F)
Operating Range	50–650°C (122–1202°F)
Resolution	0.1°C or °F resolution
Readout	Switchable °C or °F
Accuracy	$\pm 0.5^\circ\text{C}$ up to 400°C, $\pm 1^\circ\text{C}$ 400°C to 650°C, $\pm 2^\circ\text{C}$ for holes greater than 6.5 mm (0.25")
Stability	$\pm 0.05^\circ\text{C}$ at 100°C, $\pm 0.12^\circ\text{C}$ at 500°C, $\pm 0.12^\circ\text{C}$ at 650°C
Uniformity	$\pm 0.1^\circ\text{C}$ below 400°C $\pm 0.5^\circ\text{C}$ with similar sized wells above 400°C
Controller	Hybrid analog/digital controller with data retention
Heater	1000 W
Heating Times	12 minutes from ambient to 650°C
Cooling Times	25 minutes from 650°C to 100°C
Stabilization Time	7 minutes
Immersion Depth	124 mm (4.875")
Cooling	2 speed internal fan
Fault Protection	Sensor burnout and short protection, over temperature thermal cutout
Test Wells	1.125" dia. x 4.87" deep. Multi-hole inserts are available.
Size	236 mm H x 109 mm W x 185 mm D (9.3" x 4.3" x 7.3")
Weight	3.6 kg (8 lbs.)

3.2 Environmental Conditions

Although the instrument has been designed for optimum durability and trouble-free operation, it must be handled with care. The instrument should not be operated in an excessively dusty or dirty environment. Maintenance and cleaning recommendations can be found in the Maintenance Section of this manual.

The instrument operates safely under the following conditions:

- temperature range: 5 - 50°C (41 - 122°F)
- ambient relative humidity: maximum 80% for temperature <31°C, decreasing linearly to 50% at 40°C
- pressure: 75kPa - 106kPa
- mains voltage within $\pm 10\%$ of nominal
- vibrations in the calibration environment should be minimized

- altitude does not effect the performance or safety of the unit

3.3 Warranty

LIMITED WARRANTY AND LIMITATION OF LIABILITY

Each Fluke product is warranted to be free from defects in material and workmanship under normal use and service. The warranty period is one year and begins on the date of shipment. Parts, product repairs, and services are warranted for 90 days. This warranty extends only to the original buyer or end-user customer of a Fluke authorized reseller, and does not apply to fuses, disposable batteries, or to any product which, in Fluke's opinion, has been misused, altered, neglected, contaminated, or damaged by accident or abnormal conditions of operation or handling. Fluke warrants that software will operate substantially in accordance with its functional specifications for 90 days and that it has been properly recorded on non-defective media. Fluke does not warrant that software will be error free or operate without interruption.

Fluke authorized resellers shall extend this warranty on new and unused products to end-user customers only but have no authority to extend a greater or different warranty on behalf of Fluke. Warranty support is available only if product is purchased through a Fluke authorized sales outlet or Buyer has paid the applicable international price. Fluke reserves the right to invoice Buyer for importation costs of repair/replacement parts when product purchased in one country is submitted for repair in another country.

Fluke's warranty obligation is limited, at Fluke's option, to refund of the purchase price, free of charge repair, or replacement of a defective product which is returned to a Fluke authorized service center within the warranty period.

To obtain warranty service, contact your nearest Fluke authorized service center to obtain return authorization information, then send the product to that service center, with a description of the difficulty, postage and insurance prepaid (FOB Destination). Fluke assumes no risk for damage in transit. Following warranty repair, the product will be returned to Buyer, transportation prepaid (FOB Destination). If Fluke determines that failure was caused by neglect, misuse, contamination, alteration, accident, or abnormal condition of operation or handling, including overvoltage failures caused by use outside the product's specified rating, or normal wear and tear of mechanical components, Fluke will provide an estimate of repair costs and obtain authorization before commencing the work. Following repair, the product will be returned to the Buyer transportation prepaid and the Buyer will be billed for the repair and return transportation charges (FOB Shipping Point).

THIS WARRANTY IS BUYER'S SOLE AND EXCLUSIVE REMEDY AND IS IN LIEU OF ALL OTHER WARRANTIES, EXPRESS OR IMPLIED, INCLUDING BUT NOT LIMITED TO ANY IMPLIED WARRANTY OF MERCHANTABILITY OR FITNESS FOR A PARTICULAR PURPOSE. FLUKE SHALL NOT BE LIABLE FOR ANY SPECIAL, INDIRECT, INCIDENTAL, OR CONSEQUENTIAL DAMAGES OR LOSSES, INCLUDING LOSS OF DATA, ARISING FROM ANY CAUSE OR THEORY.

Since some countries or states do not allow limitation of the term of an implied warranty, or exclusion or limitation of incidental or consequential damages, the limitations and exclusions of this warranty may not apply to every buyer. If any provision of this Warranty is held invalid or unenforceable by a court or other decision-maker of competent jurisdiction, such holding will not affect the validity or enforceability of any other provision.

Fluke Corporation
P.O. Box 9090
Everett, WA 98206-9090
U.S.A.

Fluke Europe B.V.
P.O. Box 1186
5602 BD Eindhoven
The Netherlands

4 Quick Start

4.1 Unpacking

Unpack the dry-well carefully and inspect it for any damage that may have occurred during shipment. If there is shipping damage, notify the carrier immediately.

Verify that the following components are present:

- 9141 Dry-well
- 3141-2, Insert A
- Power Cord
- Manual
- Report of Calibration
- Calibration Label
- Heat Shield
- 9930
- RS-232 Cable
- Insert Removal Tool

4.2 Set-Up

Place the calibrator on a flat surface with at least 6 inches of free space around and 18 inches above the instrument. Plug the power cord into a grounded mains outlet. Observe that the nominal voltage corresponds to that indicated on the back of the calibrator. Place the heat shield on the unit to deflect high temperatures from the probe hubs (see Figure 1 on page 5).



CAUTION: *The heat shield may become very hot. Use extreme caution.*

Carefully insert the probe sleeve into the well. (DO NOT drop the sleeve in the well.) Probe sleeve holes should be of the smallest diameter possible while still allowing the probe to slide in and out easily. Sleeves with various hole sizes are available from Hart Scientific. The well must be clear of any foreign objects, dirt and grit before the sleeve is inserted. The sleeve is inserted with the two small tong holes positioned upward.

Turn on the power to the calibrator by toggling the switch on the power entry module. The fan should begin quietly blowing air through the instrument and the controller display should illuminate after 3 seconds. After a brief self test the controller should begin normal operation. If the unit fails to operate please check the power connection.

The display will begin to show the well temperature and the well heater will start operating to bring the temperature of the well to the set-point temperature.

4.3 Power

Plug the dry-well power cord into a mains outlet of the proper voltage, frequency, and current capability. Typically this will be 115 VAC ($\pm 10\%$), 50/60 Hz (230 VAC ($\pm 10\%$), 50/60 Hz). Turn the dry-well on using the rear panel "POWER" switch. The dry-well will turn on and begin to heat to the previously programmed temperature set-point. The front panel LED display will indicate the actual dry-well temperature.

4.4 Setting the Temperature

Section 7.2 explains in detail how to set the temperature set-point on the calibrator using the front panel keys. The procedure is summarized here.

- (1) Press "SET" twice to access the set-point value.
- (2) Press "UP" or "DOWN" to change the set-point value.
- (3) Press "SET" to store the new set-point.
- (4) Press "EXIT" to return to the temperature display.

When the set-point temperature is changed the controller will switch the well heater on or off to raise or lower the temperature. The displayed well temperature will gradually change until it reaches the set-point temperature. The well may require 5 to 10 minutes to reach the set-point depending on the span. Another 5 to 10 minutes is required to stabilize within $\pm 0.1^\circ\text{C}$ of the set-point. Ultimate stability may take 15 to 20 minutes more of stabilization time.

5 Parts and Controls

The user should become familiar with the dry-well calibrator and its parts.

5.1 Bottom Panel

Figure 2 on page 15.

Power Cord - Underneath the calibrator is the removable power cord inlet that plugs into an IEC grounded socket.

Power Switch - The power switch is located on the power entry module (PEM). The PEM also houses the fuses and the dual voltage selector. The PEM and Heater Voltage Switch (see below) allow the unit to be field switchable for 115 VAC ($\pm 10\%$) or 230 VAC ($\pm 10\%$) operation.



Back View

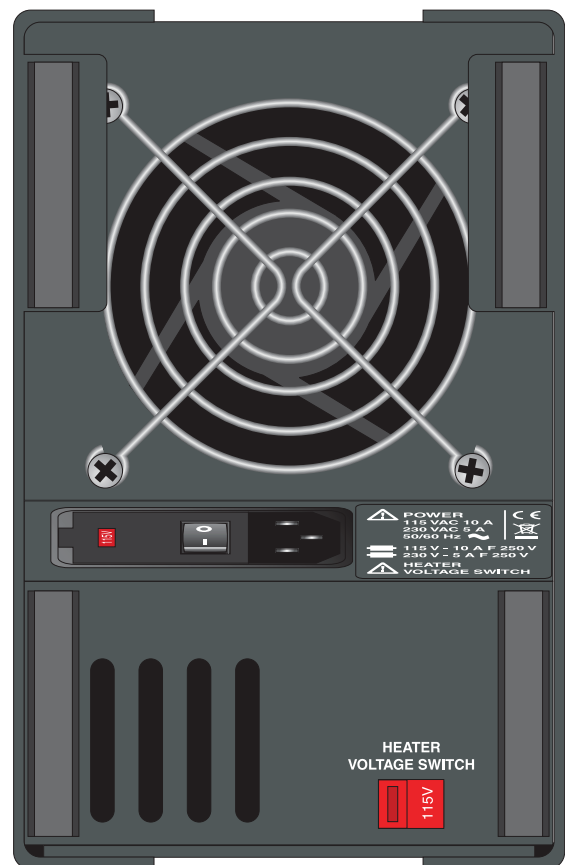

Bottom View

Figure 2 9141 Back Panel and Bottom

Heater Voltage Switch - To be used only when changing the input voltage. (See Section 6.2 for instructions on changing the input voltage.)



NOTE: The input voltage and heater voltage switch settings should always be the same value.

Serial Port - A DB-9 male connector is present for interfacing the calibrator to a computer or terminal with serial RS-232 communications.

Fan - The fan inside the calibrator runs continuously when the unit is being operated to provide cooling for the instrument. It has two speeds, a slow speed for control operation and a faster speed for rapid cooling. Slots at the top and around the two corners of the calibrator are provided for airflow. The area around the calibrator must be kept clear to allow adequate ventilation. The airflow is directed upward and **can be extremely hot**.

5.2

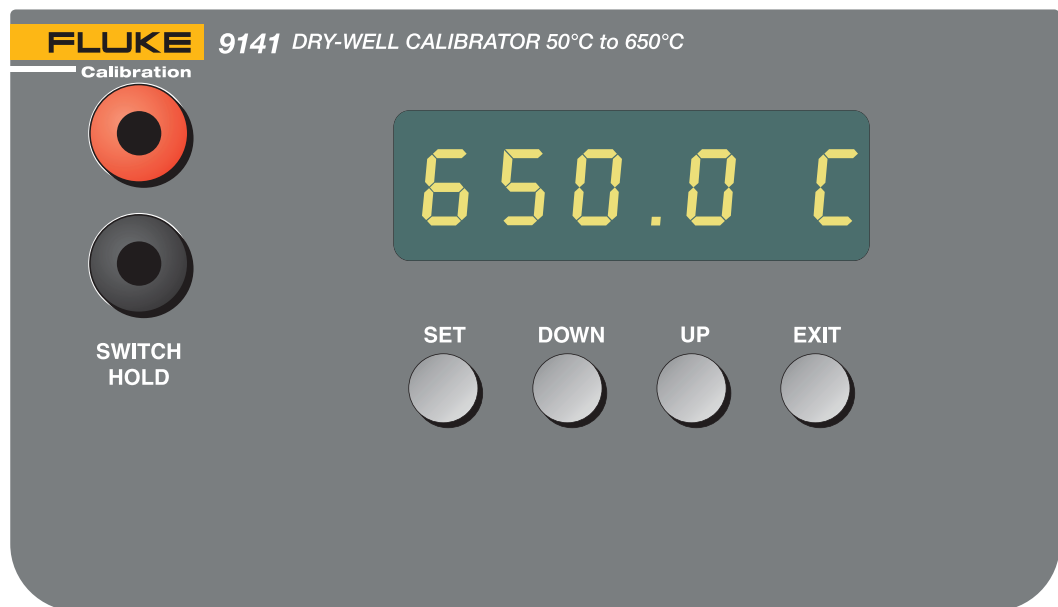

Figure 3 9141 Front Panel

Front Panel

Figure 3 on page 16.

Controller Display - The digital display is an important part of the temperature controller because it not only displays set and actual temperatures but also various calibrator functions, settings, and constants. The display shows temperatures in units according to the selected scale °C or °F.

Controller Keypad - The four button keypad allows easy setting of the set-point temperature. The control buttons (SET, DOWN, UP, and EXIT) are used to set the calibrator temperature set-point, access and set other operating parameters, and access and set calibration parameters.

Setting the control temperature is done directly in degrees of the current scale. It can be set to one-tenth of a degree Celsius or Fahrenheit.

The functions of the buttons are as follows:

SET – Used to display the next parameter in the menu and to store parameters to the displayed value.

DOWN – Used to decrement the displayed value of parameters.

UP – Used to increment the displayed value.

EXIT – Used to exit a function and skip to the next function. Any changes made to the displayed value are ignored.

5.3 Constant Temperature Block Assembly

Figure 4 on page 17.

5.3.1 Constant Temperature Block

The “Block” is made of aluminum-bronze and provides a relatively constant and accurate temperature environment for the sensor that is to be calibrated. A 28.6 mm (1.125-inch) diameter well is provided that may be used for sensors of that size or may be sleeved down with various sized multi-hole probe sleeves. Heaters surround the block assembly and provide even heat to the sensor. A high-temperature platinum RTD is imbedded at the base of the block assembly to sense and control the temperature of the block. The entire assembly is suspended in an air cooled chamber thermally isolated from the chassis and electronics.

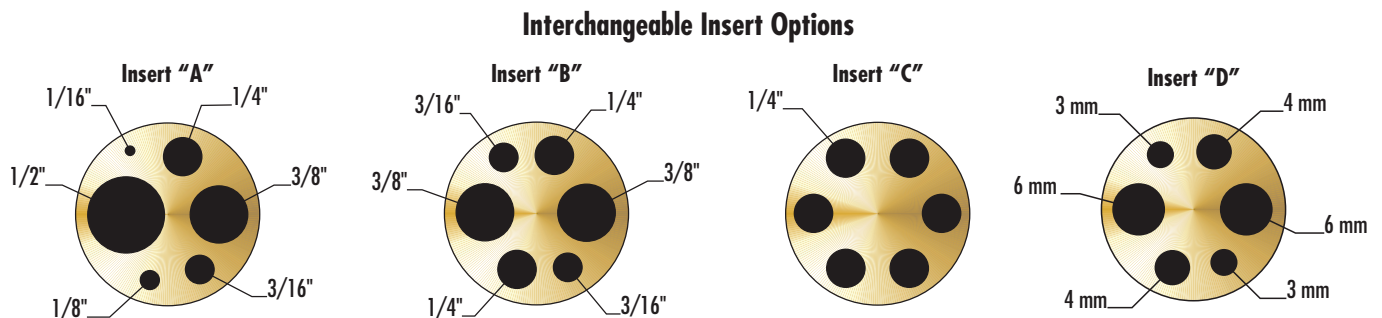

Figure 4 Inserts available for the 9141 block assembly



CAUTION: *The block vent cover may be very hot due to the fan blowing upward. Please use caution.*

5.3.2 Probe Sleeves and Tongs

The calibrator is supplied with a multi-hole aluminum-bronze probe sleeve for insertion into the calibrator well and tongs for removing sleeves. Probe sleeves of various hole sizes are available to allow the user's probe to fit snugly into the well whatever the diameter of the probe.

One insert, whichever is ordered, is shipped with the unit:

- Insert A (variety block): 1/2", 3/8", 3/16", 1/8", and 1/16" holes
- Insert B (comparison block): two 3/8", two 1/4", and two 3/16" holes
- Insert C (1/4" comparison block): six 1/4" holes

or

- Insert D (metric block): two 3 mm, two 4 mm, and two 6 mm holes

6 General Operation

6.1 Changing Display Units

The 9141 can display temperature in Celsius or Fahrenheit. The temperature units are shipped from the factory set to Celsius. To change to Fahrenheit or back to Celsius there are two ways:

- 1 - Press the “SET” and “UP” simultaneously. This will change display units.
- 2 - Press the “SET” key three times from the temperature display to show

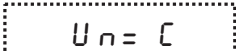

Press the “UP” or “Down” key to change units.

Press “SET” to store changes.

6.2 Switching to 230V Operation

The 9141 is switchable from 115 VAC to 230 VAC 50/60 Hz. Switching the voltage can change the calibration, so ***the unit should be calibrated after changing the input voltage.***

To change from 115 VAC to 230 VAC:

- Unplug the unit.
- Lay the unit down on its side.
- With a small straight slot screwdriver remove the fuse holder located on the rear panel. Replace the two fuses (10 amp 250 V) with 5 amp 250V fuses.
- Replace the fuse holder with the “230V” in the display window.
- Using the same straight slot screwdriver, move the heater switch to display “230V”. See the rear panel drawing in Figure 2 on page 15.



NOTE: *If the heater switch and the fuse holder do not both read 230V when complete, the unit will either not heat or only heat at a fraction of its capacity. If not done properly, the unit could become damaged and void the calibration and warranty. Use 10 amp fuses for 115V and 5 amp for 230V only. DO NOT PLUG THE UNIT INTO 230 V IF THE HEATER SWITCH AND FUSE HOLDER READ 115. THIS WILL CAUSE THE FUSES TO BLOW AND MAY DAMAGE THE INSTRUMENT.*

7 Controller Operation

This chapter discusses in detail how to operate the dry-well temperature controller using the front control panel. Using the front panel key-switches and LED display the user may monitor the well temperature, set the temperature set-point in degrees C or F, monitor the heater output power, adjust the controller proportional band, and program the calibration parameters, operating parameters, and serial interface configuration. Operation of the functions and parameters are shown in the flowchart in Figure 5 on page 22. This chart may be copied for reference.

In the following discussion a button with the word SET, UP, EXIT or DOWN inside indicates the panel button while the dotted box indicates the display reading. Explanation of the button or display reading are to the right of each button or display value.

7.1 Well Temperature

The digital LED display on the front panel allows direct viewing of the actual well temperature. This temperature value is what is normally shown on the display. The units, C or F, of the temperature value are displayed at the right. For example,

 *Well temperature in degrees Celsius*

The temperature display function may be accessed from any other function by pressing the “EXIT” button.

7.2 Temperature Set-point

The temperature set-point can be set to any value within the range and resolution as given in the specifications. Be careful not to exceed the safe upper temperature limit of any device inserted into the well.

Setting the temperature involves two steps: (1) select the set-point memory and (2) adjust the set-point value.

7.2.1 Programmable Set-points

The controller stores 8 set-point temperatures in memory. The set-points can be quickly recalled to conveniently set the calibrator to a previously programmed temperature set-point.

To set the temperature one must first select the set-point memory. This function is accessed from the temperature display function by pressing “SET”. The number of the set-point memory currently being used is shown at the left on the display followed by the current set-point value.

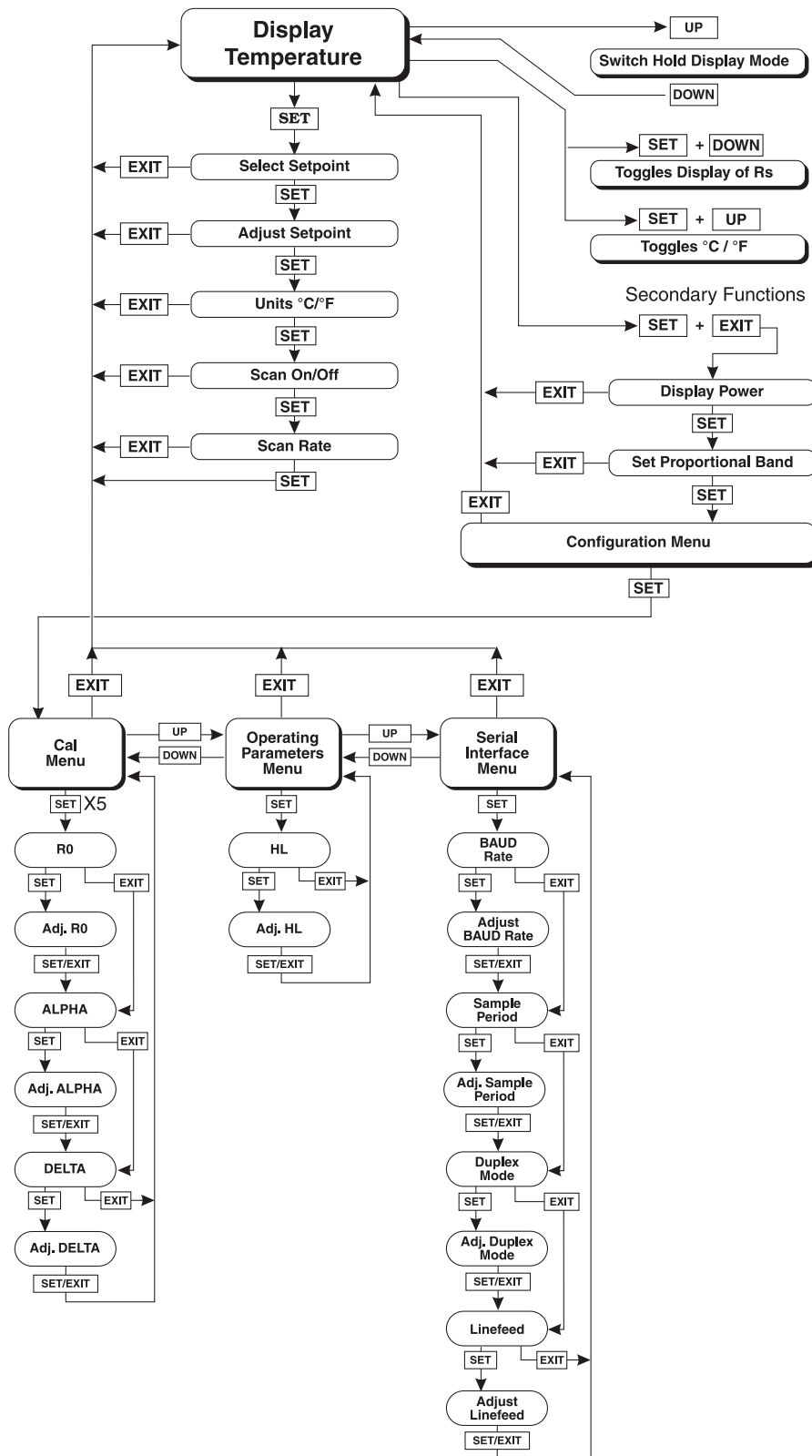



Figure 5 Controller Operation Flowchart

 Well temperature in degrees Celsius

 Access set-point memory

 Set-point memory 1, 100°C currently used

To change to another set-point memory press “UP” or “DOWN”.

 New set-point memory 4, 300°C

Press “SET” to accept the new selection and access the set-point value.

 Accept selected set-point memory

7.2.2 Set-point Value

The set-point value may be adjusted after selecting the set-point memory and pressing “SET”.

 Set-point 4 value in°C

If the set-point value is correct then press “EXIT” to resume displaying the well temperature. To change the set-point values, press “SET” and then press “UP” or “DOWN” to adjust the set-point value.

 New set-point value

When the desired set-point value is reached press “SET” to accept the new value and access the temperature scale units selection. If “EXIT” is pressed instead then any changes made to the set-point will be ignored.

 Accept new set-point value

7.2.3 Temperature Scale Units

The temperature scale units of the controller maybe set by the user to degrees Celsius (°C) or Fahrenheit (°F). The units are used in displaying the well temperature, set-point, and proportional band.

Press “SET” after adjusting the set-point value to change display units.

 Scale units currently selected

Press “UP” or “DOWN” to change the units.

 *New units selected*

7.3 Scan

The scan rate can be set and enabled so that when the set-point is changed the dry-well heats or cools at a specified rate (degrees per minute) until it reaches the new set-point. With the scan disabled the dry-well heats or cools at the maximum possible rate.

7.3.1 Scan Control

The scan is controlled with the scan on/off function that appears in the main menu after the temperature scale units.

 *Scan function off*

Press “UP” or “DOWN” to toggle the scan on or off.

 *Scan function on*

Press “SET” to accept the present setting and continue.

 *Accept scan setting*

7.3.2 Scan Rate

The next function in the main menu is the scan rate. The scan rate can be set from .1 to 99.9°C/min. The maximum scan rate however is actually limited by the natural heating or cooling rate of the instrument. This is often less than 100°C/min, especially when cooling.

The scan rate function appears in the main menu after the scan control function. The scan rate units are in degrees per minute, degrees C or F depending on the selected units.

 *Scan rate in°C/min*

Press “UP” or “DOWN” to change the scan rate.

 *New scan rate*

Press “SET” to accept the new scan rate and continue.

 *Accept scan rate*

7.4 Temperature Display Hold

The 9141 has a display hold function which allows action of an external switch to freeze the displayed temperature and stop the set-point from scanning. This is useful for testing thermal switches and cutouts. This section explains the functions available for operating the temperature hold feature. An example follows showing how to set up and use the hold feature to test a switch.

7.4.1 Hold Temperature Display

The hold feature is enabled by simply pressing the “UP” button. The hold temperature display shows the hold temperature on the right and the switch status on the left. For the status “c” means the switch is closed and “o” means the switch is open. The status flashes when the switch is in its active position (opposite the normal position). The hold temperature shows what the temperature of the well was when the switch changed from its normal position to its active position. While the switch is in the normal position the hold temperature will follow the well temperature. Operation of the hold temperature display is outlined below.

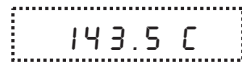

Well temperature display



Access hold display

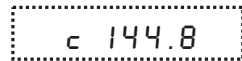

Switch status and hold temperature

To return to the normal well temperature display press “DOWN”.

7.4.2 Mode Setting

The Hold Function is always in the automatic mode. In this mode the normal position is set to whatever the switch position is when the set-point is changed. For example, if the switch is currently open when the set-point is changed, the closed position then becomes the new active position. The normal position is set automatically under any of the following conditions, (1) a new set-point number is selected, (2) the set-point value is changed, (3) a new set-point is set through the communications channels.

The operating mode of the temperature hold is set in the primary menu after the scan rate setting.

7.4.3 Switch Wiring

The thermal switch or cutout is wired to the calibrator at the two terminals in the front of the dry-well calibrator labeled “SWITCH HOLD”. The switch wires may be connected to the terminals either way. Internally the black terminal connects to ground. The red terminal connects to +5V through a 100 kΩ re-

sistor. The calibrator measures the voltage at the red terminal and interprets +5V as open and 0V as closed.

7.4.4 Switch Test Example

This section describes a possible application for the temperature hold feature and how the instrument is set up and operated.

Suppose you have a thermal switch which is supposed to open at about 75°C and close at about 50°C and you want to test the switch to see how accurate and repeatable it is. You can use the temperature hold feature and the scan function to test the switch. Measurements can be made by observing the display or, preferably, by collecting data using a computer connected to the RS-232 port. To set up the test do the following steps.

1. Connect the switch wires to the terminals on the front of the dry-well and place the switch in the well.
2. Enable set-point scanning by setting the scan to “ON” in the primary menu (see Section 7.3.1).
3. Set the scan rate to a low value, say 1.0°C/min. (see Section 7.3.2). If the scan rate is too high you may lose accuracy because of transient temperature gradients. If the scan rate is too low the duration of the test may be longer than is necessary. You may need to experiment to find the best scan rate.
4. Set the first program set-point to a value below the expected lower switch temperature, say 40°C, in the program menu.
5. Set the second program set-point to a value above the expected upper switch temperature, say 90°C.
6. Set the program soak time to allow enough time to collect a number of data points, say 2 minutes.
7. Collect data on a computer connected to the RS-232 port. Refer to Section 8 for instructions on configuring the RS-232 communications interface.

7.5 Secondary Menu

Functions which are used less often are accessed within the secondary menu. The secondary menu is accessed by pressing “SET” and “EXIT” simultaneously and then releasing. The first function in the secondary menu is the heater power display. (See Figure 5 on page 22.)

7.6 Heater Power

The temperature controller controls the temperature of the well by pulsing the heater on and off. The total power being applied to the heater is determined by the duty cycle or the ratio of heater on time to the pulse cycle time. By knowing the amount of heating the user can tell if the calibrator is heating up to the set-point, cooling down, or controlling at a constant temperature. Monitoring

the percent heater power will let the user know how stable the well temperature is. With good control stability the percent heating power should not fluctuate more than $\pm 1\%$ within one minute.

The heater power display is accessed in the secondary menu. Press “SET” and “EXIT” simultaneously and release. The heater power will be displayed as a percentage of full power.

 Well temperature

 Access heater power in secondary menu

 Flashes 5 E C for secondary menu and then displays the heater power

 Heater power in percent

To exit out of the secondary menu press “EXIT”. To continue on to the proportional band setting function press “SET”.

7.7 Proportional Band

In a proportional controller such as this the heater output power is proportional to the well temperature over a limited range of temperatures around the set-point. This range of temperature is called the proportional band. At the bottom of the proportional band the heater output is 100%. At the top of the proportional band the heater output is 0. Thus as the temperature rises the heater power is reduced, which consequently tends to lower the temperature back down. In this way the temperature is maintained at a fairly constant temperature.

The temperature stability of the well and response time depend on the width of the proportional band. If the band is too wide the well temperature will deviate excessively from the set-point due to varying external conditions. This is because the power output changes very little with temperature and the controller cannot respond very well to changing conditions or noise in the system. If the proportional band is too narrow the temperature may swing back and forth because the controller overreacts to temperature variations. For best control stability the proportional band must be set for the optimum width.

The proportional band width is set at the factory to about 15.0°C. The proportional band width may be altered by the user if he desires to optimize the control characteristics for a particular application.

The proportional band width is easily adjusted from the front panel. The width may be set to discrete values in degrees C or F depending on the selected units. The proportional band adjustment is accessed within the secondary menu.

Press “SET” and “EXIT” to enter the secondary menu and show the heater power. Then press “SET” to access the proportional band.

 *Access heater power in secondary menu*

 *Flashes 5 E C for secondary menu and then displays the heater power*

 *Heater power in percent*

 *Access proportional band*

 *Proportional band setting*

 *Flashes P r o P and then displays the value*

To change the proportional band press “UP” or “DOWN”.

 *New proportional band setting*

To accept the new setting press “SET”. Press “EXIT” to continue without storing the new value.

 *Accept the new proportional band setting*

7.8 Controller Configuration

The controller has a number of configuration and operating options and calibration parameters which are programmable via the front panel. These are accessed from the secondary menu after the proportional band function by pressing “SET”. Pressing “SET” again enters the first of three sets of configuration parameters — calibration parameters, operating parameters and serial interface parameters. The sets are selected using the “UP” and “DOWN” keys and then pressing “SET”. (See [Figure 5](#) on page 22.)

7.9 Calibration Parameters

The operator of the instrument controller has access to a number of the calibration constants namely R0, ALPHA, and DELTA. These values are set at the factory and must not be altered. The correct values are important to the accuracy and proper and safe operation of the instrument. Access to these parameters is available to the user so that in the event that the controller memory fails

the user may restore these values to the factory settings. The user should have a list of these constants and their settings with the instrument manual.



WARNING: DO NOT change the values of the instrument calibration constants from the factory set values. The correct setting of these parameters is important to the safety and proper operation of the instrument.

The calibration parameters menu is indicated by,

 Calibration parameters menu

Press “SET” five times to enter the menu. The calibration parameters menu contains the parameters, R_0 , ALPHA, and DELTA, which characterize the resistance-temperature relationship of the platinum control sensor. These parameters may be adjusted to improve the accuracy of the calibrator.

The calibration parameters are accessed by pressing “SET” after the name of the parameter is displayed. The value of the parameter may be changed using the “UP” and “DOWN” buttons. After the desired value is reached press “SET” to set the parameter to the new value. Pressing “EXIT” causes the parameter to be skipped ignoring any changes that may have been made.

7.9.1

R_0

This probe parameter refers to the resistance of the control probe at 0°C. The value of this parameter is set at the factory for best instrument accuracy.

7.9.2

ALPHA

This probe parameter refers to the average sensitivity of the probe between 0 and 100°C. The value of this parameter is set at the factory for best instrument accuracy.

7.9.3

DELTA

This probe parameter characterizes the curvature of the resistance-temperature relationship of the sensor. The value of this parameter is set at the factory for best instrument accuracy.

7.10

Operating Parameters

The operating parameters menu is indicated by,

 Operating parameters menu

Press “UP” to enter the menu. The operating parameters menu contains the HL (High Limit) parameter. The HL parameter adjusts the upper set-point tempera-

ture. The factory default and maximum are set to 650°C. For safety, a user can adjust the HL down so the maximum temperature set-point is restricted.

`HL` *High Limit parameter*

Press “SET” to enable adjustment of HL

`H=650` *Current HL setting*

Adjust the HL parameter using “UP” or “DOWN”.

`H=400` *New HL setting*

Press “SET” to accept the new temperature limit.

7.11 Serial Interface Parameters

The serial RS-232 interface parameters menu is indicated by,

`SERIAL` *Serial RS-232 interface parameters menu*

The serial interface parameters menu contains parameters which determine the operation of the serial interface. These controls only apply to instruments fitted with the serial interface. The parameters in the menu are — BAUD rate, sample period, duplex mode, and linefeed.

7.11.1 Baud Rate

The baud rate is the first parameter in the menu. The baud rate setting determines the serial communications transmission rate.

The baud rate parameter is indicated by,

`BAUD` *Serial BAUD rate parameter*

Press “SET” to choose to set the baud rate. The current baud rate value will then be displayed.

`2400 b` *Current baud rate*

The baud rate of the serial communications may be programmed to 300, 600, 1200, **2400**, 4800, or 9600 baud. Use “UP” or “DOWN” to change the baud rate value.

`4800 b` *New baud rate*

Press “SET” to set the baud rate to the new value or “EXIT” to abort the operation and skip to the next parameter in the menu.

7.11.2 Sample Period

The sample period is the next parameter in the serial interface parameter menu. The sample period is the time period in seconds between temperature measurements transmitted from the serial interface. If the sample rate is set to 5, the instrument transmits the current measurement over the serial interface approximately every five seconds. The automatic sampling is disabled with a sample period of 0. The sample period is indicated by,

`S P E R` *Serial sample period parameter*

Press “SET” to choose to set the sample period. The current sample period value will be displayed. Press “EXIT” to exit without saving the changes.

`S P = 1` *Current sample period (seconds)*

Adjust the value with “UP” or “DOWN” and then use “SET” to set the sample rate to the displayed value.

`S P = 60` *New sample period*

7.11.3 Duplex Mode

The next parameter is the duplex mode. The duplex mode may be set to full duplex or half duplex. With full duplex any commands received by the calibrator via the serial interface are immediately echoed or transmitted back to the device of origin. With half duplex the commands are executed but not echoed. The duplex mode parameter is indicated by,

`d U P L` *Serial duplex mode parameter*

Press “SET” to access the mode setting.

`d = F U L L` *Current duplex mode setting*

The mode may be changed using “UP” or “DOWN” and pressing “SET”.

`d = H A L F` *New duplex mode setting*

7.11.4 Linefeed

The final parameter in the serial interface menu is the linefeed mode. This parameter enables (on) or disables (off) transmission of a linefeed character (LF,

ASCII 10) after transmission of any carriage-return. The linefeed parameter is indicated by,

LF *Serial linefeed parameter*

Press "SET" to access the linefeed parameter.

LF = 0 n *Current linefeed setting*

The mode may be changed using "UP" or "DOWN" and pressing "SET".

LF = OFF *New linefeed setting*

8 Digital Communication Interface

The dry-well calibrator is capable of communicating with and being controlled by other equipment through the digital serial interface.

With a digital interface the instrument may be connected to a computer or other equipment. This allows the user to set the set-point temperature, monitor the temperature, and access any of the other controller functions, all using remote communications equipment. Communications commands are summarized in Table 2 on page 36.

8.1 Serial Communications

The calibrator is installed with an RS-232 serial interface that allows serial digital communications over fairly long distances. With the serial interface the user may access any of the functions, parameters and settings discussed in Section 7 with the exception of the BAUD rate setting.

8.1.1 Wiring

The serial communications cable attaches to the calibrator through the D-9 connector at the back of the instrument. Figure 6 shows the pin-out of this connector and suggested cable wiring. The serial cable should be shielded. If the unit is used in a heavy industrial setting, the serial cable must be limited to **ONE** meter.

8.1.2 Setup

Before operation the serial interface must first be set up by programming the BAUD rate and other configuration parameters. These parameters are programmed within the serial interface menu. The serial interface parameters menu is outlined in Figure 5 on page 22.

To enter the serial parameter programming mode first press “EXIT” while pressing “SET” and release to enter the second-

RS-232 Cable Wiring for IBM PC and Compatibles

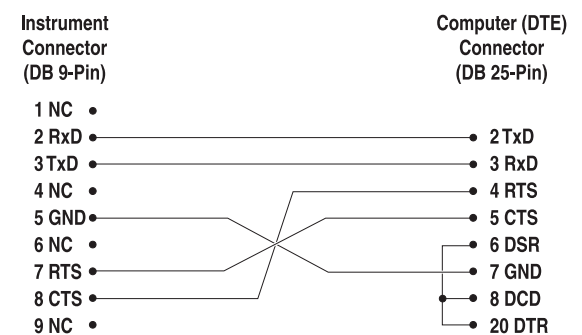
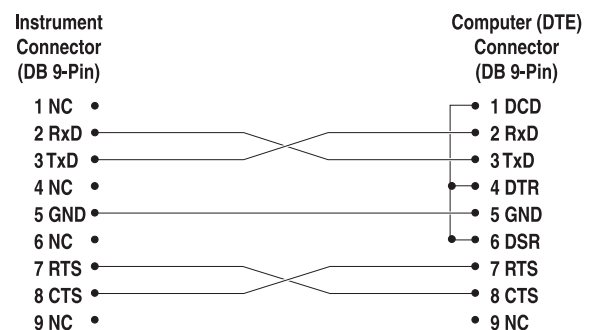

Figure 6 Serial Cable Wiring

ary menu. Press “SET” repeatedly until the display reads “*CTL*”. Press “UP” until the serial interface menu is indicated with “*SERIAL*”. Finally press “SET” to enter the serial parameter menu. In the serial interface parameters menu are the BAUD rate, the sample rate, the duplex mode, and the linefeed parameter.

8.1.2.1 Baud Rate

The baud rate is the first parameter in the menu. The display will prompt with the baud rate parameter by showing “*BAUD*”. Press “SET” to choose to set the baud rate. The current baud rate value will then be displayed. The BAUD rate of the 9141 serial communications may be programmed to 300, 600, 1200, 2400, 4800, or 9600 baud. The baud rate is pre-programmed to 2400 BAUD. Use “UP” or “DOWN” to change the baud rate value. Press “SET” to set the baud rate to the new value or “EXIT” to abort the operation and skip to the next parameter in the menu.

8.1.2.2 Sample Period

The sample period is the next parameter in the menu and prompted with “*SPEr*”. The sample period is the time period in seconds between temperature measurements transmitted from the serial interface. If the sample rate is set to 5 for instance then the instrument will transmit the current measurement over the serial interface approximately every five seconds. The automatic sampling is disabled with a sample period of 0. Press “SET” to choose to set the sample period. Adjust the period with “UP” or “DOWN” and then use “SET” to set the sample rate to the displayed value.

8.1.2.3 Duplex Mode

The next parameter is the duplex mode indicated with “*DUPr*”. The duplex mode may be set to half duplex (“HALF”) or full duplex (“FULL”). With full duplex any commands received by the thermometer via the serial interface are immediately echoed or transmitted back to the device of origin. With half duplex the commands are executed but not echoed. The default setting is full duplex. The mode may be changed using “UP” or “DOWN” and pressing “SET”.

8.1.2.4 Linefeed

The final parameter in the serial interface menu is the linefeed mode. This parameter enables (“On”) or disables (“OFF”) transmission of a linefeed character (LF, ASCII 10) after transmission of any carriage-return. The default setting is with linefeed on. The mode may be changed using “UP” or “DOWN” and pressing “SET”.

8.1.3 Serial Operation

Once the cable has been attached and the interface set up properly the controller immediately begins transmitting temperature readings at the programmed rate. The serial communications uses 8 data bits, one stop bit, and no parity. The set-point and other commands may be sent via the serial interface to set the

temperature set-point and view or program the various parameters. The interface commands are discussed in [Section](#) . All commands are ASCII character strings terminated with a carriage-return character (CR, ASCII 13).

8.2 Interface Commands

The various commands for accessing the calibrator functions via the digital interfaces are listed in this section (see [Table 2](#)). These commands are used with the RS-232 serial interface. The commands are terminated with a carriage-return character. The interface makes no distinction between upper and lower case letters, hence either may be used. Commands may be abbreviated to the minimum number of letters which determines a unique command. A command may be used to either set a parameter or display a parameter depending on whether or not a value is sent with the command following a “=” character. For example “s”<CR> returns the current set-point and “s=150.0”<CR> sets the set-point to 150.0 degrees.

In the following list of commands, characters or data within brackets, “[” and “]”, are optional for the command. A slash, “/”, denotes alternate characters or data. Numeric data, denoted by “n”, may be entered in decimal or exponential notation. Characters are shown in lower case although upper case may be used. Spaces may be added within command strings and will simply be ignored. Backspace (BS, ASCII 8) may be used to erase the previous character. A terminating CR is implied with all commands.

Table 2 9141 controller communications commands

Command Description	Command Format	Command Example	Returned	Returned Example	Acceptable Values
Display Temperature					
Read current set-point	s[etpoint]	s	set: 9999.99 {C or F}	set: 150.00 C	
Set current set-point to <i>n</i>	s[etpoint]= <i>n</i>	s=350			Instrument Range
Read temperature	t[emperature]	t	t: 9999.9 {C or F}	t: 55.6 C	
Read temperature units	u[nits]	u	u: x	u: C	
Set temperature units:	u[nits]=c/f				C or F
Set temperature units to Celsius	u[nits]=c	u=c			
Set temperature units to Fahrenheit	u[nits]=f	u=f			
Read scan mode	sc[an]	sc	sc: {ON or OFF}	sc: ON	
Set scan mode	sc[an]=on/off	sc=on			ON or OFF
Read scan rate	sr[ate]	sr	srat: 99.9 {C or F}/min	srat:12.4 C/min	
Set scan rate	sr[ate]= <i>n</i>	sr=1.1			.1 to 99.9
Read hold	ho[ld]	ho	ho: open/closed, 99.9 {C or F}	ho: open, 30.5C	
Secondary Menu					
Read proportional band setting	pr[opband]	pr	pb: 999.9	pb: 15.9	
Set proportional band to <i>n</i>	pr[opband]= <i>n</i>	pr=8.83			Depends on Configuration
Read heater power (duty cycle)	po[wer]	po	po: 999.9	po: 1.3	
Configuration Menu					
Calibration Parameters Menu					
Read R0 calibration parameter	r[0]	r	r0: 999.999	r0: 100.578	
Set R0 calibration parameter to <i>n</i>	r[0]= <i>n</i>	r=100.324			98.0 to 104.9
Read ALPHA calibration parameter	al[pha]	al	al: 9.9999999	al: 0.0038573	
Set ALPHA calibration parameter to <i>n</i>	al[pha]= <i>n</i>	al=0.0038433			.002 to .006
Read DELTA calibration parameter	de[lta]	de	de: 9.9999	de: 1.507	
Set DELTA calibration parameter	de[lta]= <i>n</i>	de=1.3742			0–3.0
Operating Parameters Menu					
Read High Limit	hl	hl	hl: 999	hl: 600	
Set High Limit	hl= <i>n</i>	hl=600			100–650

9141 communication commands continued

Command Description	Command Format	Command Example	Returned	Returned Example	Acceptable Values
Serial Interface Menu					
Read serial sample setting	sa[mple]	sa	sa: 9	sa: 1	
Set serial sampling setting to <i>n</i> seconds	sa[mple]=n	sa=0			0 to 999
Set serial duplex mode:	du[plex]=f[ull]/h[alf]				FULL or HALF
Set serial duplex mode to full	du[plex]=f[ull]	du=f			
Set serial duplex mode to half	du[plex]=h[alf]	du=h			
Set serial linefeed mode:	lf[eed]=on/of[f]				ON or OFF
Set serial linefeed mode to on	lf[eed]=on	lf=on			
Set serial linefeed mode to off	lf[eed]=of[f]	lf=of			
Miscellaneous					
Read firmware version number	*ver[sion]	*ver	ver.9999,9.99	ver.9141,1.21	
Read structure of all commands	h[elp]	h	list of commands		
Read ALL operating parameters	all	all	list of parameters		
Legend:	[] Optional Command data				
	{ } Returns either information				
	n Numeric data supplied by user				
	9 Numeric data returned to user				
	x Character data returned to user				
Note:	When DUPLEX is set to FULL and a command is sent to READ, the command is returned followed by a carriage return and linefeed. Then the value is returned as indicated in the RETURNED column.				

9 Test Probe Calibration

For optimum accuracy and stability, allow the calibrator to warm up for 10 minutes after power-up and then allow adequate stabilization time after reaching the set-point temperature. After completing operation of the calibrator, allow the well to cool by setting the temperature to 100°C for one-half hour before switching the power off.

9.1 Calibrating a Single Probe

Insert the probe to be calibrated into the well of the dry-well calibrator. The probe should fit snugly into the calibrator probe sleeve yet should not be so tight that it cannot be easily removed. Avoid any dirt or grit that may cause the probe to jam into the sleeve. Best results are obtained with the probe inserted to the full depth of the well. Once the probe is inserted into the well, allow adequate stabilization time to allow the test probe temperature to settle as described above. Once the probe has settled to the temperature of the well, it may be compared to the calibrator display temperature. The display temperature should be stable to within 0.1°C degree for best results.



CAUTION: *Never introduce any foreign material into the probe hole of the insert. Fluids etc. can leak into the calibrator causing damage to the calibrator or binding and damage to your probe.*

9.2 Dry-well Characteristics

There is a temperature gradient vertically in the test well. The heater has been applied to the block in such a way as to compensate for nominal heat losses out of the top of the dry-well. However, actual heat losses will vary with design of the thermometer probes inserted into the calibrator and the temperature. For best results, insert probe to full depth of well.

9.2.1 Heating and Cooling Rates

Figures 7 and 8 show typical heating cooling rates of the 9141 dry-well calibrator.

DO NOT remove inserts when heating or when the unit is hot.

9.2.2 Stabilization and Accuracy

The stabilization time of the dry-well calibrator will depend on the conditions and temperatures involved. Typically the test well will be stable to 0.1°C within 5 minutes of reaching the set-point temperature as indicated by the display. Ultimate stability will be achieved 10 to 20 minutes after reaching the set temperature.

Inserting a cold probe into a well will require another period of stabilizing depending on the magnitude of the disturbance and the required accuracy. For example, inserting a .25 inch diameter room temperature probe into a sleeve at 300°C will take 5 minutes to be within 0.1°C of its settled point and will take 10 minutes to achieve maximum stability.

Speeding up the calibration process can be accomplished by knowing how soon to make the measurement. It is recommended that typical measurements be made at the desired temperatures with the desired test probes to establish these times.

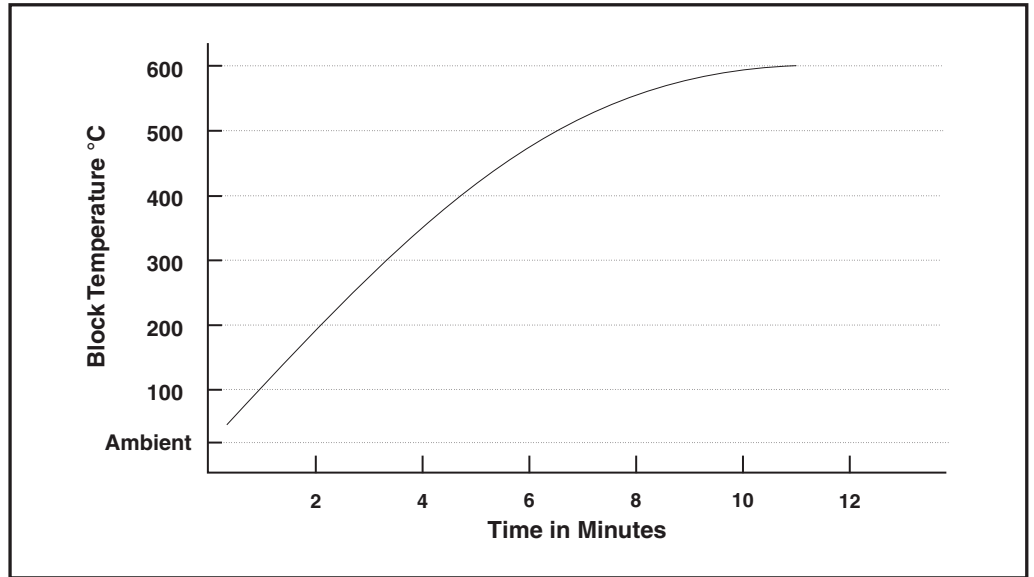

Figure 7 Typical Heating Rate

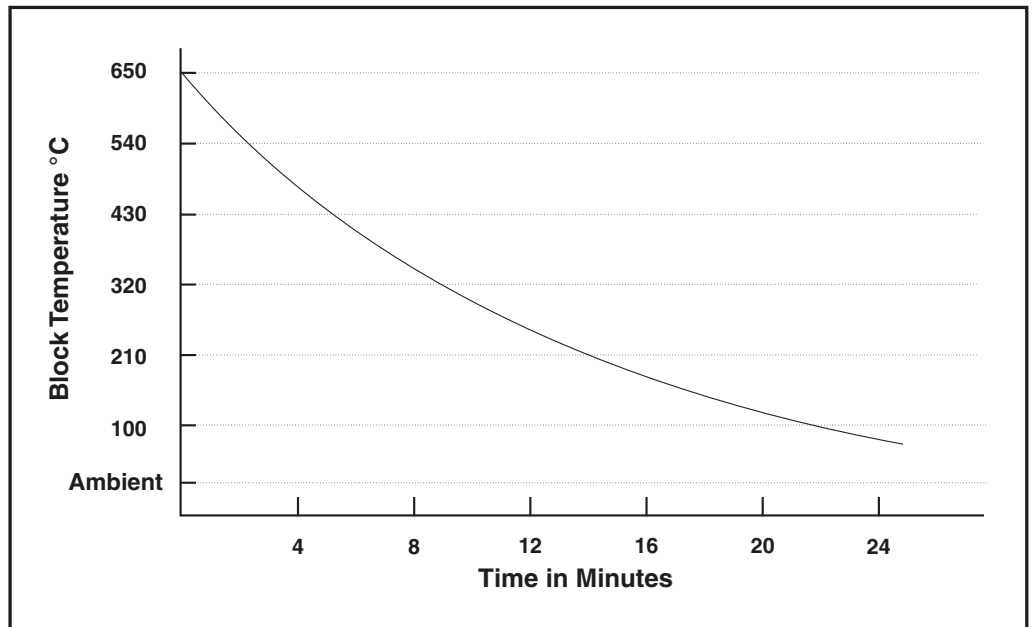

Figure 8 Typical Cooling Rate

10 Calibration Procedure

Sometimes the user may want to calibrate the dry-well to improve the temperature set-point accuracy. Calibration is done by adjusting the controller probe calibration constants **R₀**, **ALPHA**, and **DELTA** so that the temperature of the dry-well as measured with a standard thermometer agrees more closely with the set-point. The thermometer used must be able to measure the well temperature with higher accuracy than the desired accuracy of the dry-well. By using a good thermometer and following this procedure the dry-well can be calibrated to an accuracy of better than 0.5°C up to 450°C and 1.5°C above 450°C.

10.1 Calibration Points

In calibrating the dry-well, **R₀**, **ALPHA**, and **DELTA** are adjusted to minimize the set-point error at each of three different dry-well temperatures. Any three reasonably separated temperatures may be used for the calibration. Improved results can be obtained for shorter ranges when using temperatures that are just within the most useful operating range of the dry-well. The farther apart the calibration temperatures, the larger will be the calibrated temperature range but the calibration error will also be greater over the range. If for instance 150°C to 350°C is chosen as the calibration range then the calibrator may achieve an accuracy of say ±0.3°C over the range 150 to 350°C. Choosing a range of 200°C to 300°C may allow the calibrator to have a better accuracy of maybe ±0.2°C over the range 175 to 325°C but outside that range the accuracy may be only ±0.5°C.

10.2 Calibration Procedure

1. Choose three set-points to use in the calibration of the **R₀**, **ALPHA**, and **DELTA** parameters. These set-points are generally 50°C, 250°C, and 450°C but other set-points may be used if desired or necessary.
2. Set the dry-well to the low set-point. When the dry-well reaches the set-point and the display is stable, wait 15 minutes or so and then take a reading from the thermometer. Sample the set-point resistance by holding down the SET key and pressing the DOWN key. Write these values down as **T₁** and **R₁** respectively.
3. Repeat step 2 for the other two set-points recording them as **T₂**, **R₂**, **T₃**, and **R₃** respectively.
4. Using the recorded data, calculate new values for **R₀**, **ALPHA**, and **DELTA** parameters using the equations given below:

10.2.1 Compute DELTA:

$$A = T_3 - T_2$$

$$B = T_2 - T_1$$

$$C = \left[\frac{T_3}{100} \right] \left[1 - \frac{T_3}{100} \right] - \left[\frac{T_2}{100} \right] \left[1 - \frac{T_2}{100} \right]$$

$$D = \left[\frac{T_2}{100} \right] \left[1 - \frac{T_2}{100} \right] - \left[\frac{T_1}{100} \right] \left[1 - \frac{T_1}{100} \right]$$

$$E = R_3 - R_2$$

$$F = R_2 - R_1$$

$$\text{delta} = \frac{AF - BE}{DE - CF}$$

T₁₋₃ - Measured temperature using thermometer.

R₁₋₃ - Value of R from display of 9141 (Press SET and DOWN at the same time.)

where

T₁ and **R₁** are the measured temperature and resistance at 50.0 °C

T₂ and **R₂** are the measured temperature and resistance at 250.0 °C

T₃ and **R₃** are the measured temperature and resistance at 450.0 °C

10.2.2 Compute **R₀** & **ALPHA**:

$$a_1 = T_1 + \text{delta} \left[\frac{T_1}{100} \right] \left[1 - \frac{T_1}{100} \right]$$

$$a_3 = T_3 + \text{delta} \left[\frac{T_3}{100} \right] \left[1 - \frac{T_3}{100} \right]$$

$$rzero = \frac{R_3 a_1 - R_1 a_3}{a_1 - a_3}$$

$$\text{alpha} = \frac{R_1 - R_3}{R_3 a_1 - R_1 a_3}$$

delta is the new value of DELTA computed above

5. Program the new values for DELTA (delta), **R₀** (rzero) and ALPHA (alpha) into the dry-well with the following steps.

- a. Press SET and EXIT keys at the same time and then press SET until **R₀** is displayed.

b. Press SET then use the UP or DOWN keys until the correct numerical setting is displayed. Press SET to accept the new value.

c. Repeat step b for ALPHA and DELTA.

10.2.3 Accuracy & Repeatability

1. Check the accuracy of the dry-well at various points over the calibrated range.
2. If dry-well does not pass specification at all set-points, repeat the **Calibration Procedure**.

11 Maintenance

- The calibration instrument has been designed with the utmost care. Ease of operation and simplicity of maintenance have been a central theme in the product development. Therefore, with proper care the instrument should require very little maintenance. Avoid operating the instrument in an oily, wet, dirty, or dusty environment.
- If the outside of the instrument becomes soiled, it may be wiped clean with a damp cloth and mild detergent. Do not use harsh chemicals on the surface which may damage the paint.
- It is important to keep the well of the calibrator clean and clear of any foreign matter. Do not use fluid to clean out the well.
- The dry-well calibrator should be handled with care. Avoid knocking or dropping the calibrator.
- For dry-wells with removable probe sleeves, the sleeves can become covered with dust and carbon material. If the buildup becomes too thick, it could cause the sleeves to become jammed in the wells. Avoid this buildup by periodically buffing the sleeves clean.
- If a sleeve should be dropped, examine the sleeve for deformities before inserting it in the well. If there is any chance of jamming the sleeve in the well, file or grind off the protuberance.
- Do not slam the probe stems into the well. This type of action can cause a shock to the sensor.
- If a hazardous material is spilt on or inside the equipment, the user is responsible for taking the appropriate decontamination steps as outlined by the national safety council with respect to the material.
- If the mains supply cord becomes damaged, replace it with a cord with the appropriate gauge wire for the current of the instrument. If there are any questions, call a Hart Scientific Authorized Service Center for more information.
- Before using any cleaning or decontamination method except those recommended by Hart, users should check with a Hart Scientific Authorized Service Center to be sure that the proposed method will not damage the equipment.
- If the instrument is used in a manner not in accordance with the equipment design, the operation of the dry-well may be impaired or safety hazards may arise.

12 Troubleshooting

This section contains information on troubleshooting, CE Comments, and a wiring diagram.

12.1 Troubleshooting Problems, Possible Causes, and Solutions

In the event that the instrument appears to function abnormally, this section may help to find and solve the problem. Several possible problem conditions are described along with likely causes and solutions. If a problem arises, please read this section carefully and attempt to understand and solve the problem. If the problem cannot otherwise be solved, contact a Hart Scientific Authorized Service Center (see Section 1.3) for assistance. Be sure to have the instrument's model number, serial number, voltage, and problem description available.

Problem	Possible Causes and Solutions
Incorrect temperature reading	<p>Incorrect R0, ALPHA, DELTA, or BETA parameters. Find the value for R0, ALPHA, DELTA, and BETA on the Report of Calibration. Reprogram the parameters into the instrument (see Section 7.9, Calibration Parameters). Allow the instrument to stabilize and verify the accuracy of the temperature reading.</p> <p>Controller locked up. The controller may have locked up due to a power surge or other aberration. Initialize the system by performing the Factory Reset Sequence.</p> <p>Factory Reset Sequence. Hold "SET" and "EXIT" down at the same time while turning on the instrument. The instrument display shows '-init-', the model number, and the firmware version (release "SET" and "EXIT"). Each of the controller parameters and calibration constants must be reprogrammed. The values can be found on the Report of Calibration.</p>
The instrument heats or cools too quickly or too slowly	<p>Incorrect scan and scan rate settings. The scan and scan rate settings may be set to unwanted values. Check the Scan and Scan Rate settings. The scan may be off (if the unit seems to be responding too quickly). The scan may be on with the Scan Rate set low (if unit seems to be responding too slowly).</p> <p>Improper line voltage. Verify that the voltage reading in the bottom of the unit matches the source voltage.</p> <p>Improper switch setting. Check the 115 VAC/230 VAC switch on the PEM (power entry module). Make sure this switch is set to the correct type of input voltage. Check the 115 VAC/230 VAC heater switch. Make sure this switch is set to the correct type of input voltage.</p>
An "o" is displayed at the left of the display	<p>External Switch open. The external switch is open causing the displayed temperature to be frozen and keeping the set-point from scanning. Turn the Switch Test off by pressing the "DOWN" button on the front panel.</p>

Unstable display	<p>Wait. Allow the instrument to stabilize for a few minutes.</p> <p>Proportional band may be incorrect. Refer to the proportional band on the Report of Calibration.</p> <p>Electrical Noise. If the unit is being used in the field, take it to a different location (calibration lab) to see if the display becomes stable. If the display is stable in the new location, there may be electrical noise generated by equipment in the field interfering with the control.</p>
The display shows an error	<p>Controller problem. The error messages signify the following problems with the controller.</p> <p><i>E r r 1</i> - a RAM error</p> <p><i>E r r 2</i> - a NVRAM error</p> <p><i>E r r 3</i> - a Structure error</p> <p><i>E r r 4</i> - an ADC setup error</p> <p><i>E r r 5</i> - an ADC ready error</p> <p><i>E r r 6</i> - a defective control sensor, sensor is disconnected or shorted. Insure that the sensor is connected.</p> <p><i>E r r 7</i> - a heater error, the fan will go on high speed.</p> <p>Initialize the system by performing the Factory Reset Sequence described above. If the unit repeats the error code, contact a Hart Scientific Authorized Service Center for assistance.</p>
Temperature cannot be set above a certain point	<p>Incorrect High Limit parameter. The High Limit parameter may be set below 125°C. Check this value as described in Section 7.10, Operating Parameters.</p>
AC voltage is present on the insert or block	<p>Improper Wiring. Use a wall plug tester to check the main power plug at the wall.</p> <p>Power Cord. Check the cord for continuity on the ground prongs. If the resistance is greater than one ohm, replace it.</p> <p>Dielectric Test. Use an ohmmeter to check the continuity between the ground prong on the PEM and the insert. If the resistance reading is greater then three ohms, contact a Hart Scientific Authorized Service Center for assistance.</p>
Power up	<p>Fuse. The unit is equipped with external operator accessible fuses. If a fuse blows, it may be due to a power surge or failure of a component. Replace the fuse once. DO NOT replace the fuse with one of a higher current rating. Always replace the fuse with one of the same rating, voltage, and type. If the fuse blows a second time, it is likely caused by failure of a component part. Contact a Hart Scientific Authorized Service Center (Section 1.3) for assistance.</p>

12.2 CE Comments

12.2.1 EMC Directive

Hart Scientific's equipment has been tested to meet the European Electromagnetic Compatibility Directive (EMC Directive, 89/336/EEC). The Declaration of Conformity for your instrument lists the specific standards to which the unit was tested.

12.2.2 Low Voltage Directive (Safety)

In order to comply with the European Low Voltage Directive (73/23/EEC), Hart Scientific equipment has been designed to meet the IEC 1010-1 (EN 61010-1) and the IEC 1010-2-010 (EN 61010-2-010) standards.