

302+/303/305

Clamp Meter

Calibration Manual

LIMITED WARRANTY AND LIMITATION OF LIABILITY

Each Fluke product is warranted to be free from defects in material and workmanship under normal use and service. The warranty period is two years and begins on the date of shipment. Parts, product repairs, and services are warranted for 90 days. This warranty extends only to the original buyer or end-user customer of a Fluke authorized reseller, and does not apply to fuses, disposable batteries, or to any product which, in Fluke's opinion, has been misused, altered, neglected, contaminated, or damaged by accident or abnormal conditions of operation or handling. Fluke warrants that software will operate substantially in accordance with its functional specifications for 90 days and that it has been properly recorded on non-defective media. Fluke does not warrant that software will be error free or operate without interruption.

Fluke authorized resellers shall extend this warranty on new and unused products to end-user customers only but have no authority to extend a greater or different warranty on behalf of Fluke. Warranty support is available only if product is purchased through a Fluke authorized sales outlet or Buyer has paid the applicable international price. Fluke reserves the right to invoice Buyer for importation costs of repair/replacement parts when product purchased in one country is submitted for repair in another country.

Fluke's warranty obligation is limited, at Fluke's option, to refund of the purchase price, free of charge repair, or replacement of a defective product which is returned to a Fluke authorized service center within the warranty period.

To obtain warranty service, contact your nearest Fluke authorized service center to obtain return authorization information, then send the product to that service center, with a description of the difficulty, postage and insurance prepaid (FOB Destination). Fluke assumes no risk for damage in transit. Following warranty repair, the product will be returned to Buyer, transportation prepaid (FOB Destination). If Fluke determines that failure was caused by neglect, misuse, contamination, alteration, accident, or abnormal condition of operation or handling, including overvoltage failures caused by use outside the product's specified rating, or normal wear and tear of mechanical components, Fluke will provide an estimate of repair costs and obtain authorization before commencing the work. Following repair, the product will be returned to the Buyer transportation prepaid and the Buyer will be billed for the repair and return transportation charges (FOB Shipping Point).

THIS WARRANTY IS BUYER'S SOLE AND EXCLUSIVE REMEDY AND IS IN LIEU OF ALL OTHER WARRANTIES, EXPRESS OR IMPLIED, INCLUDING BUT NOT LIMITED TO ANY IMPLIED WARRANTY OF MERCHANTABILITY OR FITNESS FOR A PARTICULAR PURPOSE. FLUKE SHALL NOT BE LIABLE FOR ANY SPECIAL, INDIRECT, INCIDENTAL OR CONSEQUENTIAL DAMAGES OR LOSSES, INCLUDING LOSS OF DATA, ARISING FROM ANY CAUSE OR THEORY.

Since some countries or states do not allow limitation of the term of an implied warranty, or exclusion or limitation of incidental or consequential damages, the limitations and exclusions of this warranty may not apply to every buyer. If any provision of this Warranty is held invalid or unenforceable by a court or other decision-maker of competent jurisdiction, such holding will not affect the validity or enforceability of any other provision.

Fluke Corporation
P.O. Box 9090
Everett, WA 98206-9090
U.S.A.

Fluke Europe B.V.
P.O. Box 1186
5602 BD Eindhoven
The Netherlands

Table of Contents

Title	Page
Introduction.....	1
Contact Fluke.....	1
Safety Information.....	2
Specifications.....	6
Electrical Specifications.....	6
Mechanical Specifications.....	6
Environmental Specifications.....	6
Maintenance.....	7
Clean the Product.....	7
Battery Replacement.....	7
Jaw Maintenance.....	8
User-Replaceable Parts.....	8
Required Equipment.....	8
Performance Tests.....	9
Test the Display and Firmware Version.....	9
Backlight.....	10
Button Test.....	10
Current.....	10
Volts and Ohms.....	12
Calibration Adjustment.....	13

List of Tables

Table	Title	Page
1.	Symbols.....	5
2.	User-Replaceable Parts	8
3.	Required Equipment.....	8
4.	AC Current Performance Tests	10
5.	Volts and Ohms Performance Tests	12
6.	Calibration Adjustment	15

List of Figures

Figure	Title	Page
1.	Clamp Jaw (303 is Shown).....	4
2.	Battery Replacement	7
3.	Display Segments.....	9
4.	AC Current Test Connections	11
5.	Volts and Ohms Performance Test Connections.....	12
6.	Short the CAL Keypad.....	14

Introduction

The Fluke 302+, 303, and 305 Clamp Meters (the Product) measures ac and dc voltage, ac current, resistance, and continuity.

Warning

Read "Safety Information" before you use the Product.

Contact Fluke

To contact Fluke, call one of the following telephone numbers:

- Technical Support USA: 1-800-44-FLUKE (1-800-443-5853)
- Calibration/Repair USA: 1-888-99-FLUKE (1-888-993-5853)
- Canada: 1-800-36-FLUKE (1-800-363-5853)
- Europe: +31 402-675-200
- Japan: +81-3-6714-3114
- Singapore: +65-738-5655
- Anywhere in the world: +1-425-446-5500

Or, visit Fluke's website at www.fluke.com.

To register your product, visit <http://register.fluke.com>.

To see, print, or download the latest manual supplement, visit <http://us.fluke.com/usen/support/manuals>.

Safety Information

A **Warning** identifies conditions and procedures that are dangerous to the user. A **Caution** identifies conditions and procedures that could cause Product damage, equipment under test damage, or permanent loss of data.

Table 1 shows the symbols used on the Product and in this manual.

Warning

To prevent possible electrical shock, fire, or personal injury:

- Use the Product only as specified, or the protection supplied by the Product can be compromised.
- Read all safety Information before you use the Product.
- Carefully read all instructions.
- Use only correct measurement category (CAT), voltage, and amperage rated probes, test leads, and adapters for the measurement.
- Do not touch voltages > 30 V ac rms, 42 V ac peak, or 60 V dc.
- Hold the Product behind the tactile barrier. See The Clamp Meter. See Figure 1, item ①.
- Do not exceed the Measurement Category (CAT) rating of the lowest rated individual component of a Product, probe, or accessory.
- Do not measure current while the test leads are in the input jacks.
- Do not use the Product around explosive gas, vapor, or in damp or wet environments.
- Limit operation to the specified measurement category, voltage, or amperage ratings.
- Do not work alone.
- Do not apply more than the rated voltage, between the terminals or between each terminal and earth ground.
- Comply with local and national safety codes. Use personal protective equipment (approved rubber gloves, face protection, and flame-resistant clothes) to prevent shock and arc blast injury where hazardous live conductors are exposed.
- Replace the batteries when the low battery indicator shows to prevent incorrect measurements.
- The battery door must be closed and locked before you operate the Product.
- Measure a known voltage first to make sure that the Product operates correctly.



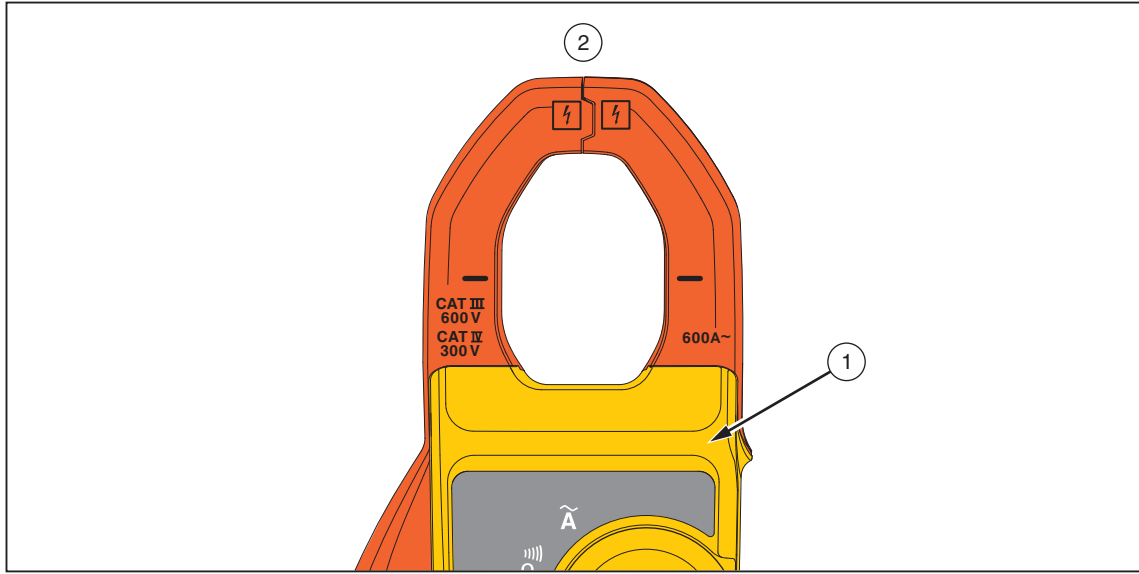





- Remove all probes, test leads, and accessories that are not necessary for the measurement.
- Only use probes, test leads, and accessories that have the same measurement category and voltage rating as the Product.
- Keep fingers behind the finger guards on the probes.
- Connect the common test lead before the live test lead and remove the live test lead before the common test lead.
- Remove all probes, test leads, and accessories before the battery door is opened.
- Do not use and disable the Product if it is damaged.
- Do not use the Product if it operates incorrectly.
- Do not use test leads if they are damaged. Examine the test leads for damaged insulation, exposed metal. Check test lead continuity.
- Before each use, examine the Product. Look for cracks or missing pieces of the clamp housing. Also look for loose or weakened components. Carefully examine the insulation around the jaws. See Figure 1, item ②.
- Examine the case before you use the Product. Look for cracks or missing plastic. Carefully look at the insulation around the terminals.
- Remove batteries to prevent battery leakage and damage to the Product if it is not used for an extended period.
- Remove the batteries if the Product is not used for an extended period of time, or if stored in temperatures above 50 °C. If the batteries are not removed, battery leakage can damage the Product.
- Do not use the Product with pulse width modulated motor controllers.
- Do not use a current measurement as an indication that a circuit is safe to touch. A voltage measurement is necessary to know if a circuit is hazardous.



hfj002.eps

Figure 1. Clamp Jaw (303 is Shown)

Table 1. Symbols

Symbol	Meaning	Symbol	Meaning
~	AC (Alternating Current)		Earth ground
	DC (Direct Current)		<p>This product complies with the WEEE Directive (2002/96/EC) marking requirements. The affixed label indicates that you must not discard this electrical/electronic product in domestic household waste. Product Category: With reference to the equipment types in the WEEE Directive Annex I, this product is classed as category 9 "Monitoring and Control Instrumentation" product. Do not dispose of this product as unsorted municipal waste. Go to Fluke's website for recycling information.</p> <p><i>Note</i></p> <p><i>This product complies with the Regulation for the Administration of the Recovery and Disposal of Waste Electrical and Electronic Products (China).</i></p>
	Hazardous voltage. Risk of electric shock.	CE	Conforms to European Union directives.
	Risk of Danger. Important information. See Manual.		Double insulated
	Battery		Application to or removal from hazardous, live conductors is permitted.
CAT II	Measurement category II is applicable to test and measuring circuits connected directly to utilization points of low voltage mains installation.	CAT III	Measurement Category III is applicable to test and measuring circuits connected to the distribution part of the building's low-voltage MAINS installation.
CAT IV	Measurement Category IV is applicable to test and measuring circuits connected at the source of the building's low-voltage MAINS installation.		This product has been tested to the requirements of CAN/CSA-C22.2 No. 61010-1, second edition, including Amendment 1, or a later version of the same standard incorporating the same level of testing requirements.

Note

The Measurement Category (CAT) and voltage rating of combinations of test probes, test probe accessories, current clamp accessories, and the Product is the LOWEST rating of individual components.

Specifications

Electrical Specifications

AC Current (Jaw)

Range	
302+	400.0 A
303.....	600.0 A
305.....	999.9 A
Resolution	0.1 A
Accuracy	
302+/303.....	1.8 % ± 5 digits (45 Hz to 65 Hz)
	2.5 % ± 5 digits (65 Hz to 400 Hz)
305.....	1.5 % ± 5 digits (45 Hz to 400 Hz)
	<i>Note: Add 2 % for position sensitivity.</i>

AC Voltage

Range	600.0 V
Resolution	0.1 V
Accuracy	1.5 % ± 5 digits (45 Hz to 400 Hz)

DC Voltage

Range	600.0 V
Resolution	0.1 V
Accuracy	1 % ± 5 digits

Resistance

Range	400.0 Ω /4000 Ω
Resolution	0.1 Ω /1 Ω
Accuracy	1 % ± 5 digits
Continuity Beeper	$\leq 70 \Omega$

Mechanical Specifications

302+/303	
Size (L x W x H)	(207 x 75 x 34) mm
Weight.....	265 g
305	
Size (L x W x H)	(207 x 75 x 34) mm
Weight.....	205 g

Environmental Specifications

Operating Temperature.....	0 °C to +40 °C
Storage Temp	-30 °C to +60 °C
Operating Humidity	Non condensing (<10 °C)
	≤ 90 % RH (at 10 °C to 30 °C)
	≤ 75 % RH (at 30 °C to 40 °C)
	(Without Condensation)
Operating Altitude	2000 meters
Storage Altitude	12,000 meters
EMI, EMC.....	Meets all applicable requirements in EN/IEC 61326-1
Temperature Coefficients.....	Add 0.1 x specified accuracy for each °C above 28 °C or below 18 °C
Measurement Category	CAT IV 300 V, CAT III 600 V
Safety Compliance.....	EN/IEC 61010-1, Pollution Degree 2
	EN/IEC 61010-2-032
	EN/IEC 61010-031/A1
	CE
IP Rating	IP 30 Per IEC 60529; Non-operating
Batteries.....	2 AAA, NEDA 24A, IEC LR03

Maintenance

Clean the Product

⚠ Caution

To prevent possible damage to the Product or to equipment under test, do not use abrasive cleaners. They will damage the case.

To clean the Product, use a cloth with a mild cleaning solution.

Battery Replacement

⚠⚠ Warning

To prevent possible explosion, fire, or personal injury, replace the batteries when the low battery indicator (🔋) shows to prevent incorrect measurements.

⚠ Caution

To prevent possible damage to the Product or to equipment under test:

- Remove batteries to prevent battery leakage and damage to the Product if it is not used for an extended period.
- Be sure that the battery polarity is correct to prevent battery leakage.

To change the batteries, see Figure 2:

1. Make sure the Product is off.
2. Turn over the Product to access the battery compartment door screw.
3. Use a flat-head screwdriver to loosen the battery compartment door screw and lift off the battery compartment door.
4. Replace the two AAA batteries. Make sure to use the correct polarity when you put the batteries into the battery compartment door.
5. Reattach the battery compartment door.
6. Tighten the battery compartment door screw.

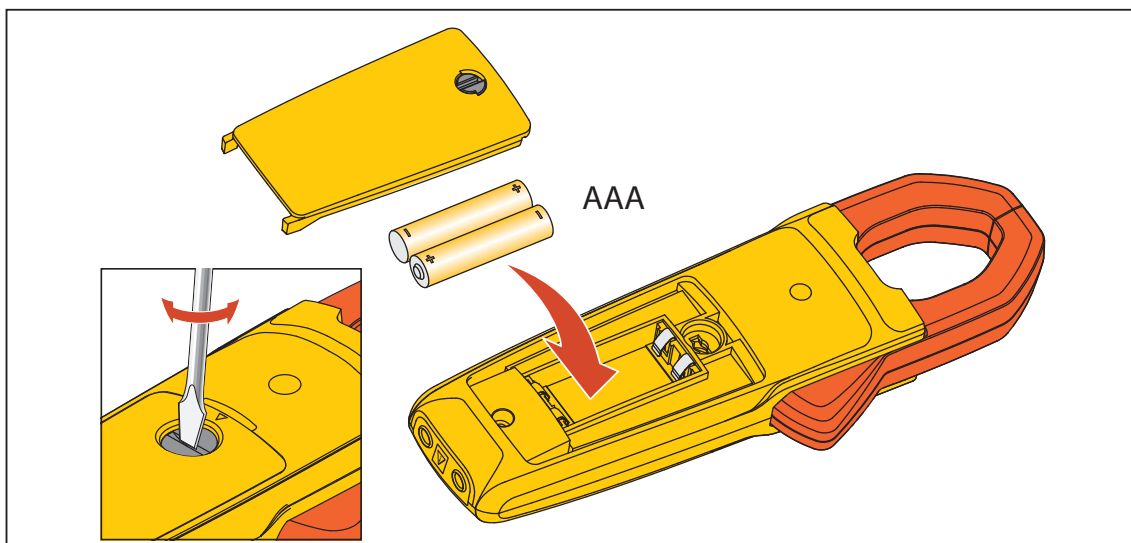

Figure 2. Battery Replacement

hjf007.eps

Jaw Maintenance

If the Product does not work properly:

1. Inspect the jaw mating surface for cleanliness. If any foreign material (including rust) is present, the jaw will not close properly and measurement errors will result.
2. Open the jaws and wipe the clamp metal ends with a non-flammable oil and cloth.

User-Replaceable Parts

User-replaceable parts are shown in Table 2. To order parts, see “Contact Fluke”.

Table 2. User-Replaceable Parts

Fluke Part Number	Description	Quantity
3986568	FLUKE-CAP-2001, TL7X PROBE CAP, BLACK	1
3986579	FLUKE-CAP-2001-01, TL7X PROBE CAP, FLUKE RED	1
2444986	BATTERY 1.5V MICRO ALKALINE IEC LR03 AAA	2
4087581	BATTERY DOOR (China only)	1
4198591	BATTERY DOOR (Brazil only)	1
3765741	FOAM BAG	1
4045130	302+/303 USERS MANUAL	1
4045148	305 USERS MANUAL	1

Required Equipment

The equipment in Table 3 is necessary for the performance tests and calibration adjustment.

Table 3. Required Equipment

Equipment	Required Characteristics	Recommended Model
Calibrator	4.5-digit resolution	FLUKE 5522A or equivalent
Wired coil	50 turns	FLUKE 5500A/Coil or equivalent

Performance Tests

⚠⚠ Warning

To prevent possible electrical shock, fire, or personal injury, do not go through the performance test procedures unless the Product is fully assembled.

The performance tests verify the full operation of the Product and measure the accuracy of each function against the Product specifications. If the Product fails a part of the test, calibration adjustment and/or repair is necessary. See “Calibration Adjustment”.

Before you do the performance tests:

1. Make sure that you have the necessary equipment. See Table 3.
2. Make sure the Product batteries are good and replace them if necessary. See “Battery Replacement”.
3. Warm up the Calibrator as necessary. Refer to its specifications.
4. Let the temperature of the UUT (unit under test) become stable to room temperature.

Test the Display and Firmware Version

To verify that all segments of the display function:

1. With the Product off, push and hold .
2. Turn the Product on.
3. All display segments are shown. See Figure 3.

If segments of the display are missing, repair is necessary. See “Contact Fluke”.

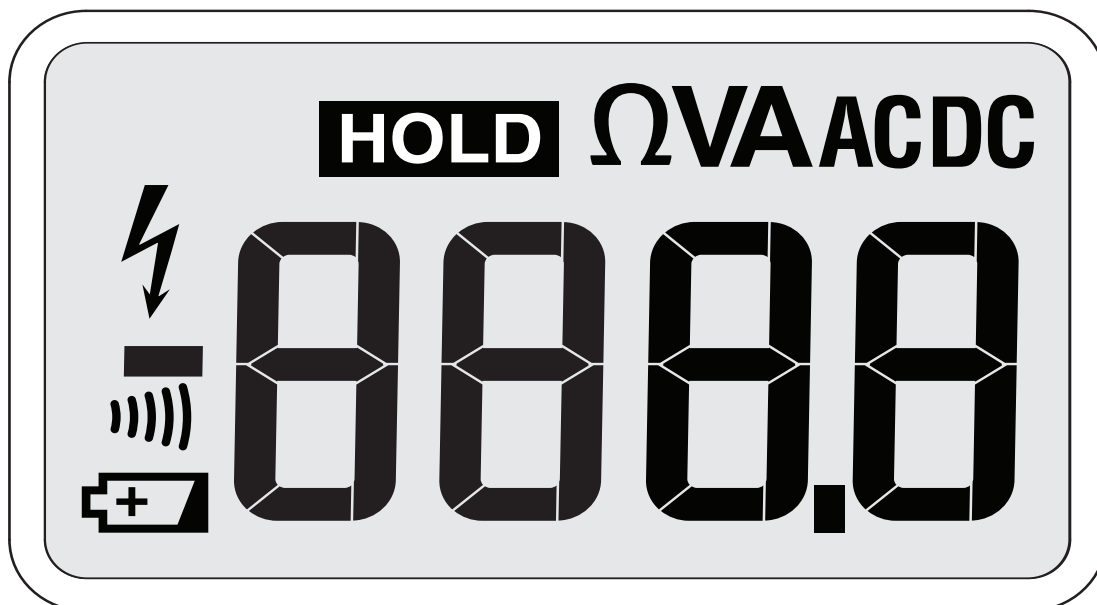



Figure 3. Display Segments

hjf001.eps



When  is released, the firmware current version is shown:

- “r007” is shown for 302+/303.
- “r004” is shown for 305.

“F30x” designates model number 302+, 303 or 305.

Backlight

To verify that the backlight functions:

1. With the Product on, push . The backlight comes on.
2. Push  again to turn off the backlight.
3. If the backlight does not function correctly, repair is necessary. See “Contact Fluke”.

Button Test

To verify that the buttons function, turn on the Product and push each button separately. Each button push causes the Product to beep. When you push the HOLD button, **HOLD** shows on the display. If the buttons do nothing, repair is necessary. See “Contact Fluke”.

Current

To do the ac current test:

1. Connect the Calibrator A ac output and ground to the 50-Turn Coil. See Figure 4 for test connections.
2. Turn the Product to \tilde{A} .
3. Apply the input level for each step shown in Table 4.
4. Compare the indication on the Product display with the UUT reading limits in Table 4.
5. If the display indication is outside of the range shown in Table 4, calibration adjustment or repair of the Product is necessary. See “Calibration Adjustment”.

Table 4. AC Current Performance Tests

Test (Switch Position)	Calibrator Output	302+	303	UUT Meter Reading Limit	
				Low	High
\tilde{A} A ac (with 50- turn coil)	0.24 A, 50 Hz	x	x	11.3 A	12.7 A
	0.24 A, 400 Hz	x	x	11.2 A	12.8 A
	2.4 A, 50 Hz	x	x	117.3 A	122.7 A
	5.4 A, 50 Hz	x	x	264.6 A	275.4 A
	7.8 A, 50 Hz	x	N/A	382.5 A	397.5 A
	10.8 A, 50 Hz	N/A	x	529.8 A	550.2 A
	7.8 A, 150 Hz	x	N/A	379.8 A	400.3 A
	10.8 A, 150 Hz	N/A	x	526.0 A	554.0 A
	6 A, 400 Hz	x	x	292.0 A	308.0 A
305					
\tilde{A} A ac (with 50- turn coil)	0.2 A, 50 Hz			9.4 A	10.7 A
	0.2 A, 400 Hz			9.4 A	10.7 A
	4 A, 50 Hz			196.5 A	203.5 A
	12 A, 50 Hz			590.5 A	609.5 A
	19.5 A, 50 Hz			959.9 A	990.1 A
	19.5 A, 150 Hz			959.9 A	990.1 A
	12 A, 400 Hz			590.5 A	609.5 A

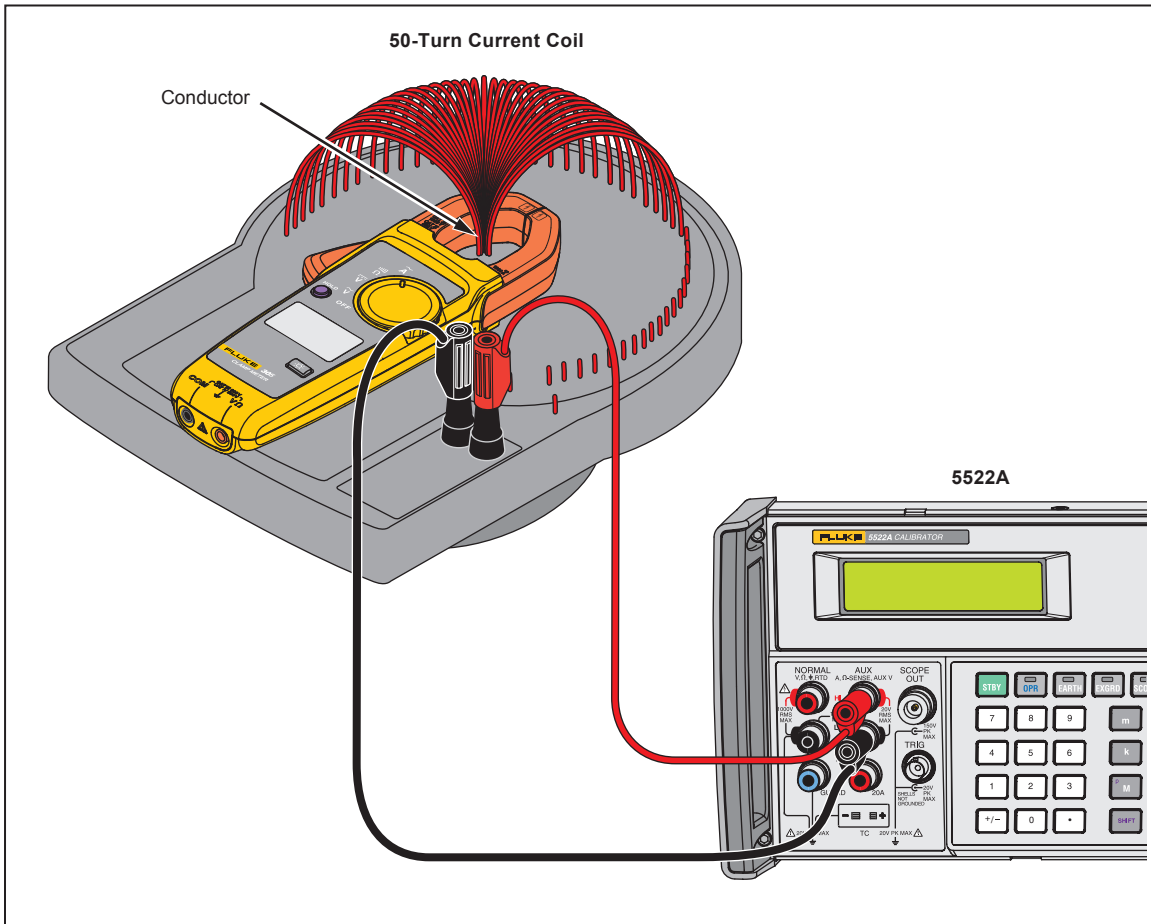

Figure 4. AC Current Test Connections

hfj025.eps

Volts and Ohms

To do the Volts and Ohms performance tests, turn the rotary switch to the necessary function and apply the values shown in Table 5. See Figure 5 for the test connections.

Table 5. Volts and Ohms Performance Tests

Test (Switch Position)	Calibrator Output	UUT Meter Reading Limit	
		Low	High
\tilde{V} V ac	10 V @ 50 Hz	9.4 V	10.7 V
	600 V @ 50 Hz	590.5 V	609.5 V
	600 V @ 400 Hz	590.5 V	609.5 V
\bar{V} V dc	-600 V	-606.5 V	-593.5 V
	-10 V	-10.6 V	-9.4 V
	10 V	9.4 V	10.6 V
	600 V	593.5 V	606.5 V
Ω Ohms	0 Ω	0.0 Ω	0.5 Ω
	10 Ω	9.4 Ω	10.6 Ω
	350 Ω	346.0 Ω	354.0 Ω
	3500 Ω	3460 Ω	3540 Ω

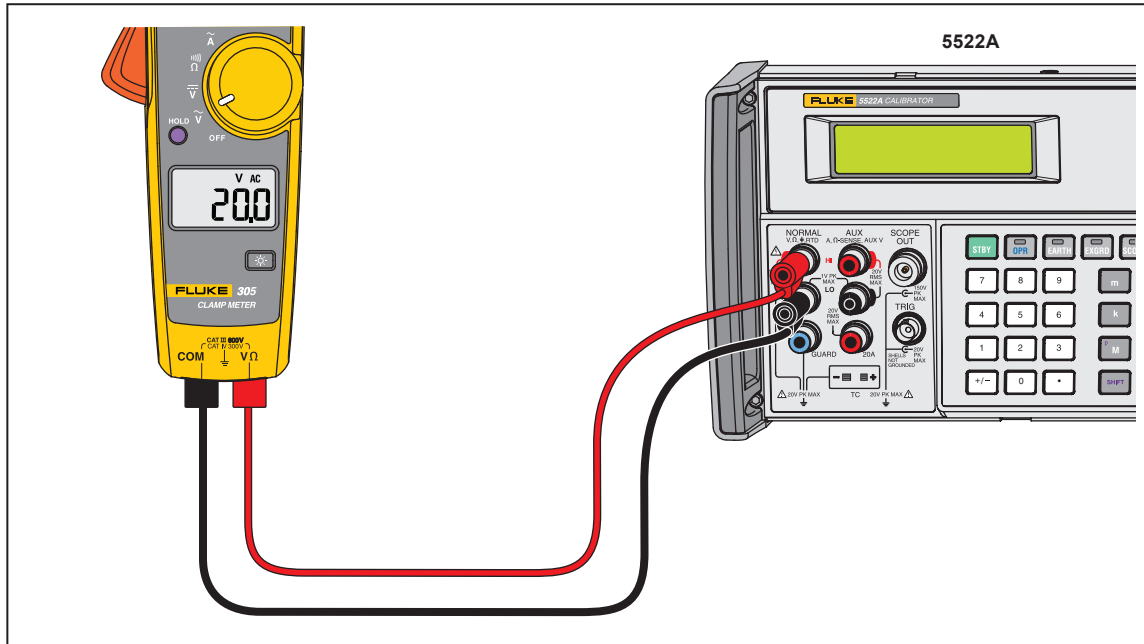

Figure 5. Volts and Ohms Performance Test Connections

hby07.eps

Calibration Adjustment

The Product features closed-case calibration adjustment and uses known reference sources. The Product measures the applied reference source, calculates correction factors, and stores the correction factors in nonvolatile memory.

Should the Product fail any of the performance tests, do the calibration adjustment procedure.

To do the calibration adjustment:

1. Remove the Product battery door. See “Battery Replacement”.
2. Apply 3.0 V across the battery contacts on the pca. Note the polarity that is shown in Figure 6.
3. Turn the rotary switch to the function to be adjusted.
4. Remove the calibration seal.
5. Short across the CAL keypad on the pca and then remove the short. See Figure 6. This puts the Product into calibration mode.
6. When “C-1.2” is shown on the display, apply the correct input signals shown in Table 6 to the Product. For each function, the calibration step shown on the display will advance.
7. After each step, push the HOLD button to confirm the calibration step, store the value, and go to the next step.
8. Set the Calibrator to Standby after you complete adjustment of each function.

Notes

If any calibration point is missing, “Err” is shown on the display.

After you push the HOLD button, wait until the calibration step number advances before you change the calibrator source. Some adjustment steps can take several seconds to execute before the Product goes to the subsequent step.

9. When calibration adjustment is complete, remove the 3.0 V supply. The Product will exit the calibration mode automatically.
10. Replace the batteries and battery door.

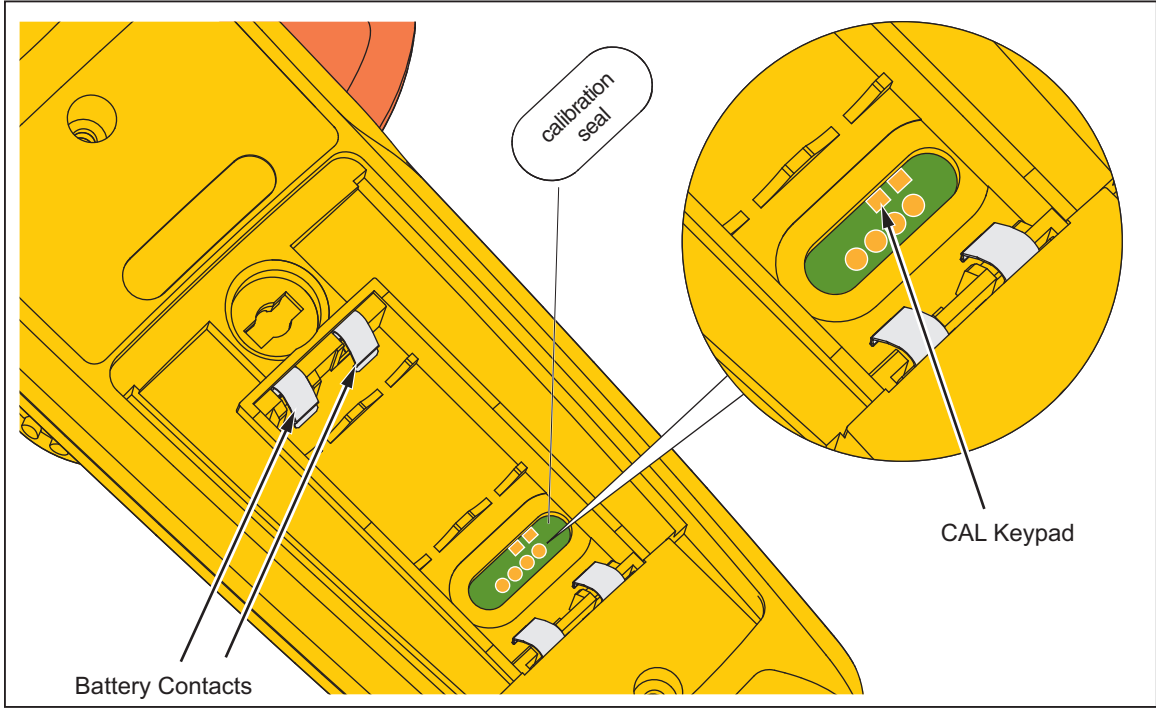

Figure 6. Short the CAL Keypad

hfj03.eps

Table 6. Calibration Adjustment

Test (Switch Position)	Step	LCD Display	Calibrator Output
302+/303			
\tilde{V} V ac	1	C-1.2	600 V, 50 Hz
\bar{V} V dc	1	C-2.2	400 V, 0 Hz
Ω Ohms	1	C-3.1	0 Ω
	2	C-3.2	400 Ω
	3	C-3.3	0 Ω
	4	C-3.4	4000 Ω
\tilde{A} A ac	1	C-4.1	8.1 A, 50 Hz
305			
\tilde{V} V ac	1	C-1.1	1.05 V, 50 Hz
	2	C-1.2	40 V, 50 Hz
	3	C-1.3	10 V, 50 Hz
	4	C-1.4	300.12 V, 50 Hz
\bar{V} V dc	1	C-2.2	400 V, 0 Hz
Ω Ohms	1	C-3.1	400 Ω
	2	C-3.2	4000 Ω
\tilde{A} A ac With 50-turn coil	1	C-4.1	0.0192 A, 50 Hz
	2	C-4.2	0.42 A, 50 Hz
	3	C-4.3	1.02 A, 50 Hz
	4	C-4.4	12 A, 50 Hz

