

# **1773/1775/1777**

## 3 Phase Power Quality Analyzer

### Users Manual



September 2021

© 2021 Fluke Corporation. All rights reserved.

Specifications are subject to change without notice.

All product names are trademarks of their respective companies.

## **LIMITED WARRANTY AND LIMITATION OF LIABILITY**

Each Fluke product is warranted to be free from defects in material and workmanship under normal use and service. The warranty period is 2 years and begins on the date of shipment. Parts, product repairs, and services are warranted for 90 days. This warranty extends only to the original buyer or end-user customer of a Fluke authorized reseller, and does not apply to fuses, disposable batteries, or to any product which, in Fluke's opinion, has been misused, altered, neglected, contaminated, or damaged by accident or abnormal conditions of operation or handling. Fluke warrants that software will operate substantially in accordance with its functional specifications for 90 days and that it has been properly recorded on non-defective media. Fluke does not warrant that software will be error free or operate without interruption.

Fluke authorized resellers shall extend this warranty on new and unused products to end-user customers only but have no authority to extend a greater or different warranty on behalf of Fluke. Warranty support is available only if product is purchased through a Fluke authorized sales outlet or Buyer has paid the applicable international price. Fluke reserves the right to invoice Buyer for importation costs of repair/replacement parts when product purchased in one country is submitted for repair in another country.

Fluke's warranty obligation is limited, at Fluke's option, to refund of the purchase price, free of charge repair, or replacement of a defective product which is returned to a Fluke authorized service center within the warranty period.

To obtain warranty service, contact your nearest Fluke authorized service center to obtain return authorization information, then send the product to that service center, with a description of the difficulty, postage and insurance prepaid (FOB Destination). Fluke assumes no risk for damage in transit. Following warranty repair, the product will be returned to Buyer, transportation prepaid (FOB Destination). If Fluke determines that failure was caused by neglect, misuse, contamination, alteration, accident, or abnormal condition of operation or handling, including overvoltage failures caused by use outside the product's specified rating, or normal wear and tear of mechanical components, Fluke will provide an estimate of repair costs and obtain authorization before commencing the work. Following repair, the product will be returned to the Buyer transportation prepaid and the Buyer will be billed for the repair and return transportation charges (FOB Shipping Point).

**THIS WARRANTY IS BUYER'S SOLE AND EXCLUSIVE REMEDY AND IS IN LIEU OF ALL OTHER WARRANTIES, EXPRESS OR IMPLIED, INCLUDING BUT NOT LIMITED TO ANY IMPLIED WARRANTY OF MERCHANTABILITY OR FITNESS FOR A PARTICULAR PURPOSE. FLUKE SHALL NOT BE LIABLE FOR ANY SPECIAL, INDIRECT, INCIDENTAL OR CONSEQUENTIAL DAMAGES OR LOSSES, INCLUDING LOSS OF DATA, ARISING FROM ANY CAUSE OR THEORY.**

Since some countries or states do not allow limitation of the term of an implied warranty, or exclusion or limitation of incidental or consequential damages, the limitations and exclusions of this warranty may not apply to every buyer. If any provision of this Warranty is held invalid or unenforceable by a court or other decision-maker of competent jurisdiction, such holding will not affect the validity or enforceability of any other provision.

Fluke Corporation  
P.O. Box 9090  
Everett, WA 98206-9090  
U.S.A.

11/99

# Table of Contents

Title	Page
Introduction .....	1
How to Contact Fluke .....	2
Safety Information .....	2
Specifications .....	2
Before You Start.....	3
WiFi/BLE Module .....	4
GPS Time Synchronization.....	6
Magnet Hanger Kit.....	8
Voltage Test Leads.....	8
iFlexi Current Probe.....	9
Tilt Stand .....	10
Storage.....	10
Accessories.....	11
User Interface.....	11
Power .....	13
Mains Power Source.....	13
Measurement Line Power Source .....	14
Battery Power Source.....	15
USB-C Power .....	16
Touchscreen/Basic Navigation.....	16
Home Screen.....	16
Info Overview.....	17
Memory.....	18
Memory Used.....	18
Logging Sessions.....	18
Screen Captures .....	18

---

Energy Analyze Plus Software .....	20
System Requirements.....	20
How to Connect to Energy Analyze Plus .....	21
USB Cable.....	21
Ethernet.....	22
WiFi Direct Connect.....	23
WiFi to Infrastructure .....	23
Auto-Copy Data to USB.....	24
First-time Use/Setup Wizard.....	24
First Measurements.....	25
Measurement Configuration .....	26
PQ Meter Mode.....	26
Setup .....	27
Topology.....	27
Nominal Voltage and Frequency .....	27
Voltage and Current Ratio .....	28
Flicker .....	28
K Factor.....	28
Event Trigger Settings.....	29
PQ Logger Mode.....	31
PQ Logger Measurement Settings .....	31
Power Quality Standard.....	31
Harmonics Grouping.....	32
Mains Signaling .....	32
AUX .....	32
PQ Logger Event Trigger Settings.....	33
Session Settings.....	33
Measurement Data Review .....	35
PQ Health .....	35
Overview .....	35
V/A/Hz.....	35
Power.....	36
Dips and Swells.....	36
Harmonics.....	36
Transients .....	36
Events .....	37
Flicker .....	37
Unbalance.....	37
Scope.....	37
Phasor.....	37
Basic Setup .....	37
Instrument Settings .....	37
Communication Settings .....	39
Tools .....	41

Maintenance.....	42
How to Clean .....	42
Battery Replacement .....	42
Calibration.....	43
Glossary .....	44



## Introduction

The 1773/1775/1777 3 Phase Power Quality Analyzer (the Analyzer or Product) is a rugged, portable device for troubleshooting power quality. The compact size and power supply from the measurement line makes it a versatile tool for live measurements and long-term logging.

Features:

- 3-Phase voltage measurement inputs with reference to N and N-to-PE measurement
- 4 current measurement inputs for 3-phases and Neutral
- 2 auxiliary measurement inputs for measurements of non-electrical units: temperature, humidity, light intensity
- Power supply 100 V ac to 600 V ac and 100 V dc to 660 V dc with safety sockets for powering from measurement line
- 7-inch display with capacitive touch
- GPS time synchronization
- USB interfaces: Type A for Flash drives and USB-C for wired connection to PC and power supply
- Slot for Wi-Fi/BLE module
- Slot for LTE-4G module
- Ethernet 1000Base-T
- User-accessible micro SD slot for flash memory expansion

## How to Contact Fluke

Fluke Corporation operates worldwide. For local contact information, go to our website:

[www.fluke.com](http://www.fluke.com)

To register your product, view, print, or download the latest manual or manual supplement, go to our website.

Fluke Corporation

P.O. Box 9090

Everett, WA 98206-9090

+1-425-446-5500

[fluke-info@fluke.com](mailto:fluke-info@fluke.com)

## Safety Information

General Safety Information is in the printed Safety Information document that ships with the Product and at [www.fluke.com](http://www.fluke.com). More specific safety information is listed where applicable.

## Specifications

Complete specifications are at [www.fluke.com](http://www.fluke.com). See the *1773/1775/1777 Product Specifications*.



## Before You Start

Table 1 is a list of items included with your purchase.

**Table 1. Accessories**

Item	Model		
	1773	1775	1777
3 Phase Power Quality Analyzer	•	•	•
Voltage Test Lead, 3-phase + N	•	•	•
Test Lead, Green	•	•	•
Set of Wire Clips	•	•	•
4x Dolphin Clips, Black	•	•	•
1x Dolphin Clip, Green	•	•	•
Set of 2 test leads, Blue 18 cm (7 in)	•	•	•
Thin-Flexi Current Probe 4x i17xx-flex1500, 61 cm (24 in) <sup>[1]</sup>	•	•	•
Mains Power Cable (see Table 2)	•	•	•
Mains Adapter MA-C8	•	•	•
USB Cable type A to USB C	•	•	•
Magnet Hanger Kit	•	•	•
Documentation Info Pack (Quick Reference Card, Safety Information, iFlex Probe Safety Information)	•	•	•
Hard Case			•
Wi-Fi/BLE Module (pre-installed) <sup>[2]</sup>		•	•
Soft Case		•	
4x Magnet Probes		•	•
<p>[1] The basic models (1773/B, 1775/B, and 1777/B) do not include the current probes.                      [2] The basic models (1775/B and 1777/B) do not include the WiFi/BLE Module.</p>			

*Note*

*The power cord is country specific and varies according to the order destination.*

**Table 2. Country-Specific Mains Power Cable**

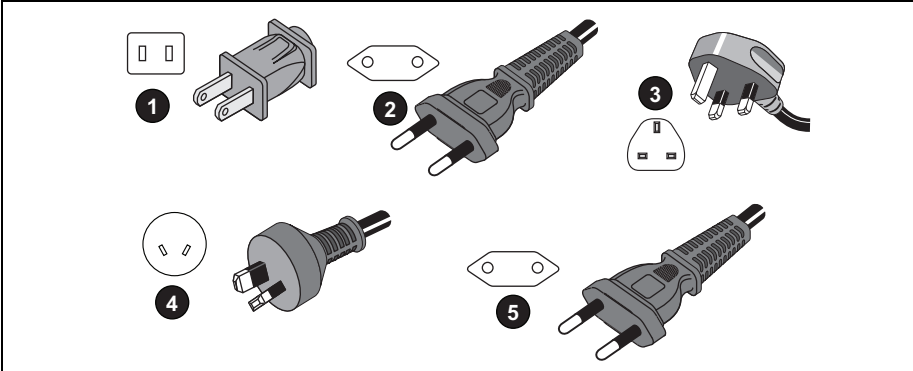

Item	Location	Part Number
1	North America	1552374
	Japan	2437458
	China	4894155
2	Universal Euro	1552388
3	United Kingdom	1552342
4	Australia	1552339
5	Brazil	4322049

## WiFi/BLE Module

The WiFi/BLE module enables the wireless connectivity. Wireless connectivity is the preferred data transfer method when the Product is installed in hazardous environments, such as, cabinets.

The WiFi/BLE module enables these features:

- Wireless data transfer to *Energy Analyze Plus* PC software.
- Time synchronization with NTP
- Remote control via Virtual Network Computing (VNC). See [Remote Display](#) for more information about VNC.

A WiFi/BLE Module is included and pre-installed. If necessary, the module is removable or you can install a module to upgrade a basic model.

To remove the adapter:

1. Open the protection cap of the WiFi/BLE module. See [Figure 1](#).

2. Remove the two screws.
3. Remove the WiFi/BLE module with a gentle pull on the tether.

**Figure 1. WiFi/BLE Module Installation**

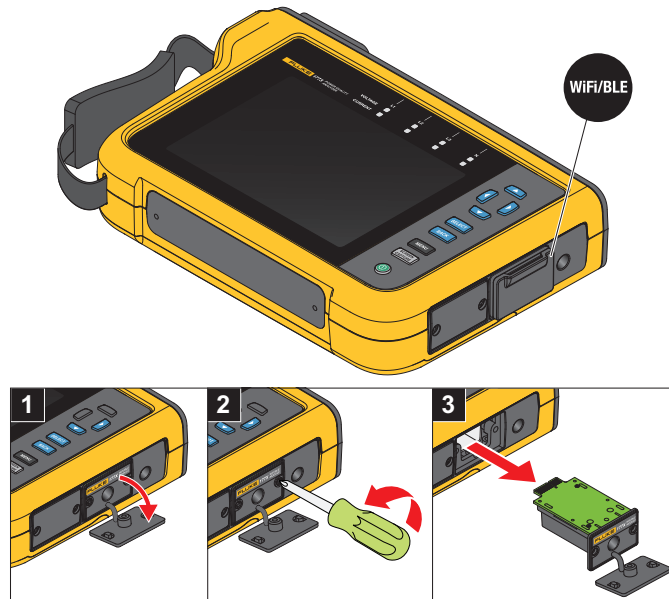

4. Close the protection cap.

To upgrade:

1. Unscrew the two screws and dispose of the blind plate.
2. Insert the WiFi/BLE module into the correct slot.
3. Fasten the two screws.
4. Make sure the sealing area is clean and close the protection cap.

The WiFi/BLE module supports the connection to a WiFi infrastructure and direct connection from a PC to the Analyzer. The module includes an internal antenna.

A router signal is sometimes weak due to factors such as obstacles, power, output, and distance. The WiFi/BLE module supports an external 2.4 GHz/5 GHz WiFi antenna that can boost the WiFi range of your signal for a more reliable WiFi signal.

An adapter cable (available from Fluke) connects the antenna to the installed WiFi/BLE module. See [Figure 2](#).

**Figure 2. WiFi Antenna Connection**

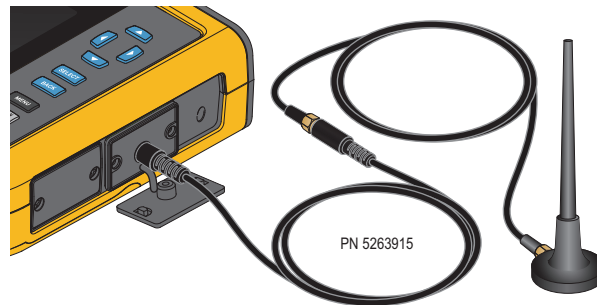

*Note*

*The antenna cable connects to the antenna with a SMA connector that has an outside thread and a center receptacle (SMA female/jack). Former FCC regulations required that WiFi equipment must use reverse polarity connectors. You must use an SMA male plug to RP-SMA female adapter if the antenna uses a RP-SMA male connector with an internal thread and center receptacle.*

**⚠️⚠️ Warning**

**To prevent possible electrical shock, fire, or personal injury, use Product-approved measurement category (CAT) antenna cables when the Product is installed in environment where wires or exposed metal parts provide access to hazardous live voltage, such as, in cabinets.**

## GPS Time Synchronization

With a GPS antenna, the Analyzer has the best possible real-time accuracy of typically 1 ms and complies to the time synchronization requirements of IEC61000-4-30 Class A.

To use GPS time synchronization:

1. Go to **Instrument Setup > Time Synchronization Source** and configure as **GPS**.

The GPS status on the Analyzer indicates an invalid time synchronization status and no connection to the GPS receiver.

2. Attach the antenna cable to the GPS Input Connector. See [Figure 3](#).

**Figure 3. GPS Connection**

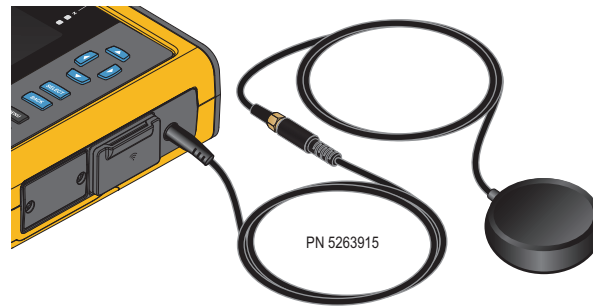

3. Connect the GPS antenna to the antenna cable.

A GPS antenna is available from third-party sources and must have these requirements:

- Satellite system: GPS, GLONASS. Support of both systems allows faster, more reliable tracking.
- Antenna type: active (3.3 V) or passive

4. Position the antenna at a location with clear view to the sky.

Due to the extreme low signal strength of satellites, consider an outdoor location for a reliable time synchronization. The acquisition takes approximately 1 minute until the GPS receiver identifies enough satellites to use for the time synchronization. The GPS icon in the status bar turns green when the GPS receiver provides reliable time synchronization.

If required, you can extend the connection to the GPS antenna with an additional antenna cable that has an SMA plug and SMA socket. The total length should be <20 m.

## Magnet Hanger Kit

Use the Magnet Hanger Kit to hang the Product. See [Figure 4](#).

Figure 4. Magnet Hanger Kit

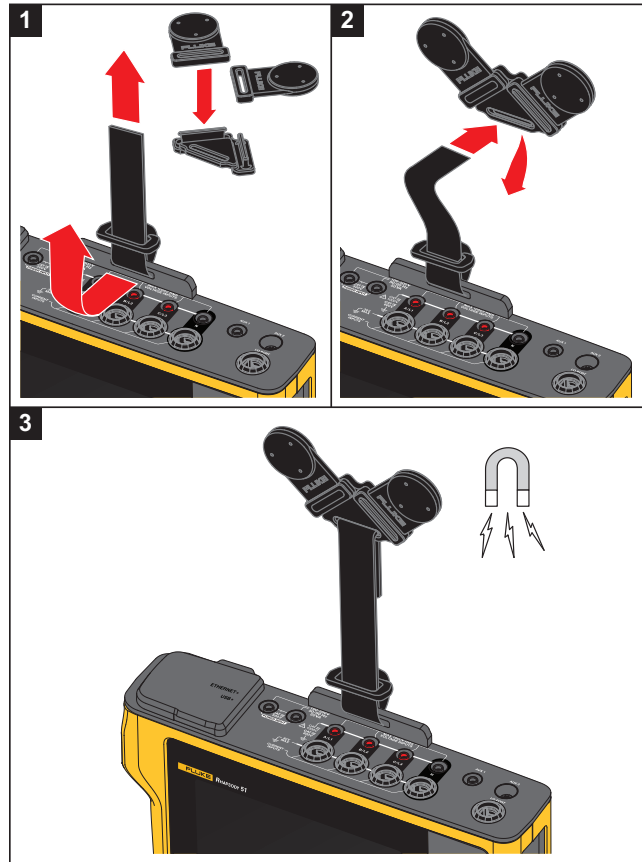

### ⚠ Caution

**Always use two magnets to hang the Product.**

## Voltage Test Leads

Four-core, flat, voltage test leads connect up to three phases and neutral. These leads do not tangle and can be installed in tight spaces.

For neutral-to-ground and high-speed transient measurements, use the test lead with green plugs for the Earth/Ground connection. Be sure that you attach the dolphin clips to a good ground source, such as bare, uncoated parts of the cabinet.

## iFlexi Current Probe

The iFlexi Current Probe works on the Rogowski coil (R-coil) principle that is a toroid of wire used to measure an alternating current through a wire encircled by the toroid. See [Figure 5](#).

**Figure 5. R-Coil Operation Principle**

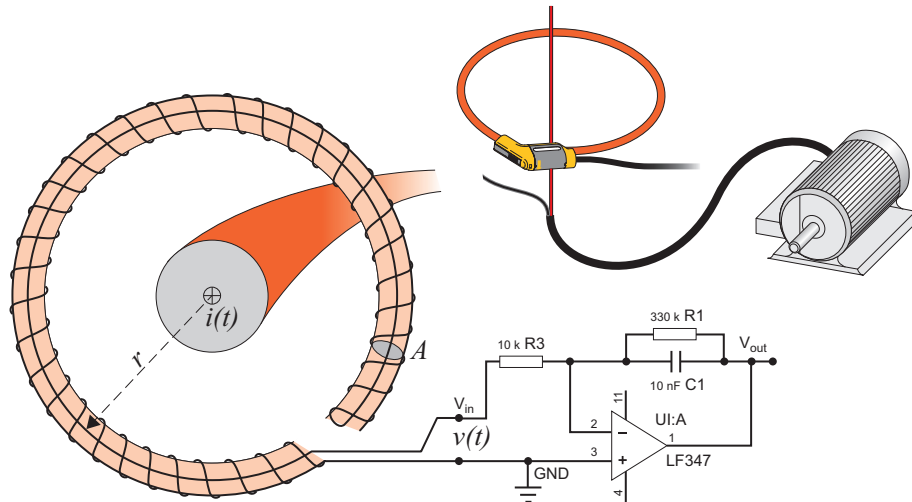

The R-coil has advantages over other types of current transformers:

- It is not a closed loop. The second terminal is passed back through the center of the toroid core (commonly a plastic or rubber tube) and connected along the first terminal. This allows the coil to be open-ended, flexible, and able to be wrapped around a live conductor without disturbing it.
- It has an air core rather than an iron core. It has a low inductance and can respond to fast-changing currents.
- Because it has no iron core to saturate, it is highly linear even when subjected to large currents, such as those used in electric power transmission or pulsed-power applications.

A correctly formed R-coil, with equally spaced windings, is largely immune to electromagnetic interference.

Use the wire clips for easy identification of the four current probes. Apply the clips that are appropriate for your local wiring codes on both ends of the current probe cable. See [Figure 6](#).

**Figure 6. Wire Clips**

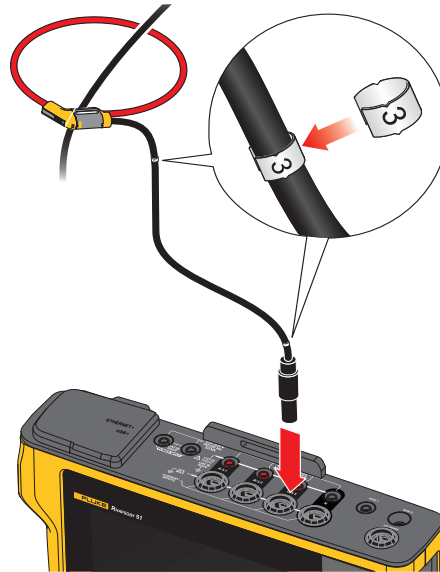

## Tilt Stand

The Product includes a tilt stand that positions the display at a good angle for use on a tabletop surface. See [Figure 7](#).

**Figure 7. Tilt Stand**

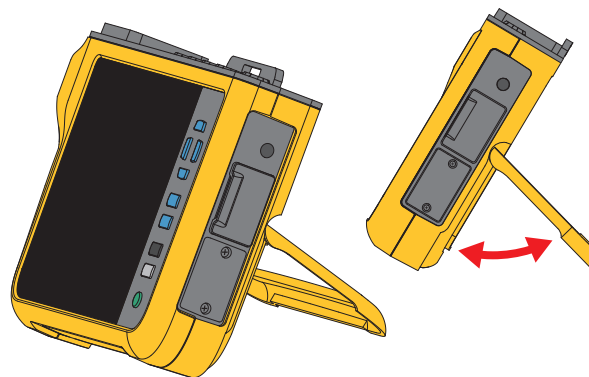

## Storage

When not in use, keep the Analyzer in the protective storage bag/case. The bag/case has sufficient space for the Analyzer and all the accessories.

If the Analyzer is stored for an extended period of time or is not in use for a long time, you should charge the battery at least once every six months. For more information, see [Maintenance](#).



## Accessories

For the most up-to-date information on accessories, go to [www.fluke.com](http://www.fluke.com).

## User Interface

Table 3 is a list of the front panel controls and functions.

**Table 3. Front Panel**

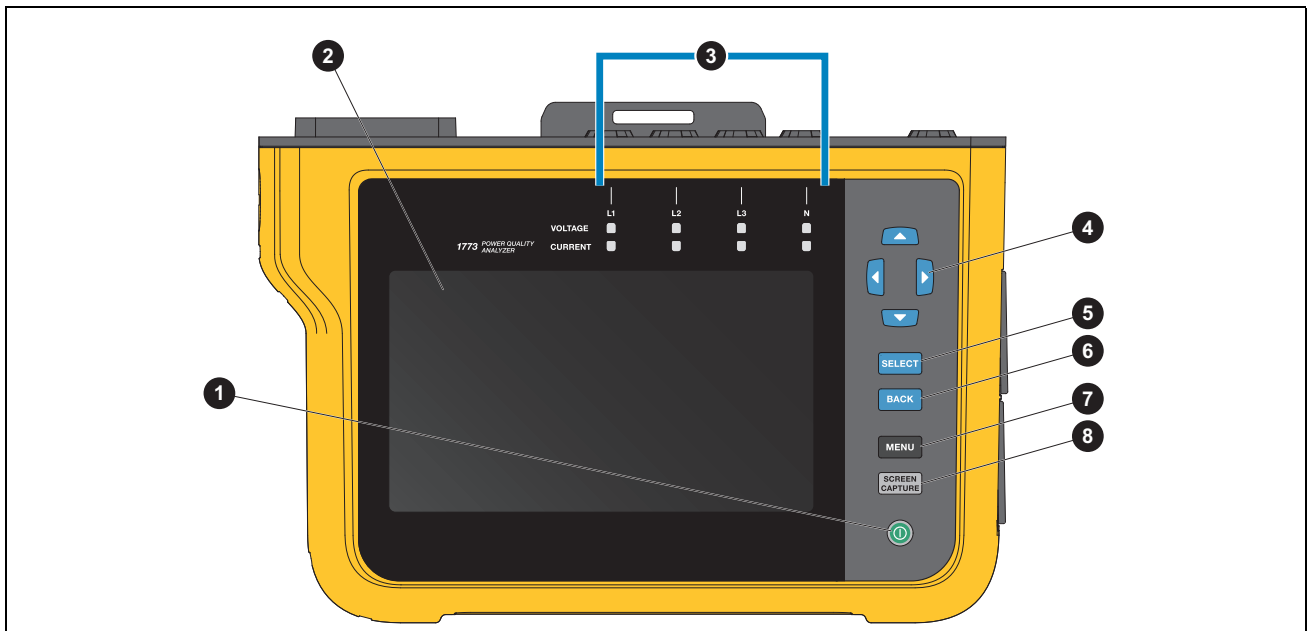

Item	Description
1	Power ON/OFF
2	Touch screen
3	Status LEDs Current and Voltage
4	Cursor controls
5	Select
6	Back
7	Menu
8	Screen Capture

Table 4 is a list of the connectors and functions.

**Table 4. Connector Panel**

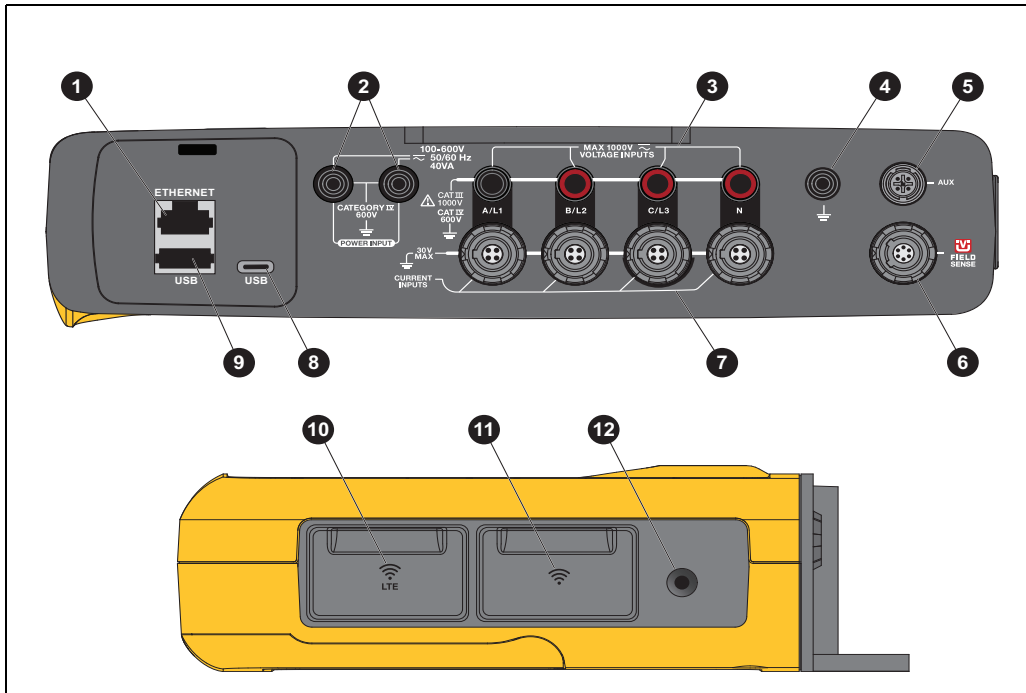

Item	Description
1	Ethernet
2	Power Supply Input 600 V 50/60 Hz 40 VA
3	Voltage measurement inputs (3 phases + N)
4	Earth/Ground measurement input
5	Auxiliary 1/2 Input
6	FieldSense™ input
7	Current measurement inputs (3 phases + N)
8	USB-C connector
9	USB 2.0 Type-A connector
10	LTE Communications expansion port
11	WiFi/BLE
12	GPS antenna

## Power

The Analyzer has options for the power source:

- mains
- measurement line
- battery
- USB-C

### Mains Power Source

Setup:

1. Attach the mains adapter MA-C8 to both power supply inputs of the Analyzer. See [Figure 8](#).
2. Connect the power cord into the adapter.
3. Plug the power cord into a wall outlet.
4. The Analyzer automatically turns on and is ready to use in <30 seconds.
5. Push  to turn off/turn on the Analyzer.

**Figure 8. Power Supply**

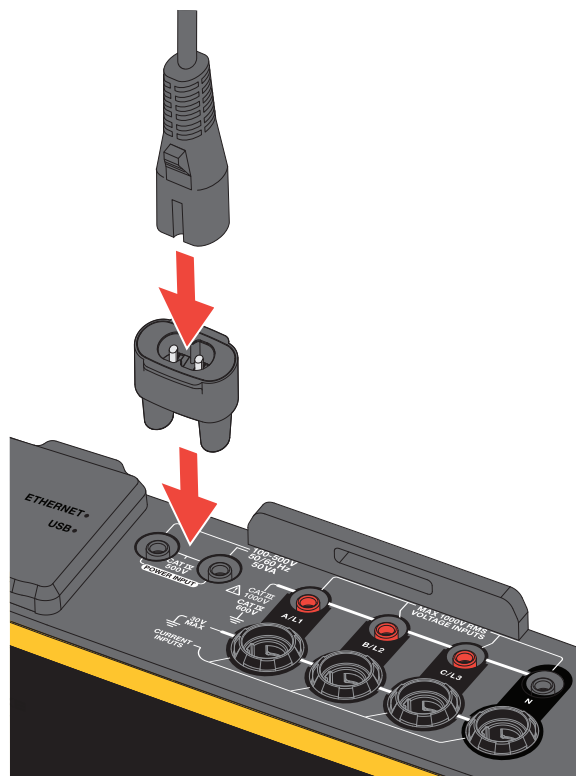

## Measurement Line Power Source

### ⚠ Caution

To prevent damage to the product, make sure the measured voltage does not exceed the input rating of the power supply.

### ⚠⚠ Warning

To prevent injury, do not touch the metal parts of one test lead when the other is still connected to hazardous voltage.

Setup:

1. Connect the short test leads with the power supply inputs. Make sure to use the non-stackable plugs.
2. Connect the test leads with the voltage measurement inputs:
  - Connect A/L1 with one input of the power supply.
  - Connect N with the second input of the power supply. See [Figure 9](#).

OR

- Connect A/L1 with one input of the power supply.
- Connect B/L2 with the second input of the power supply. See [Figure 10](#).

**Figure 9. Measurement with Neutral Voltage and Instrument Power Supply**

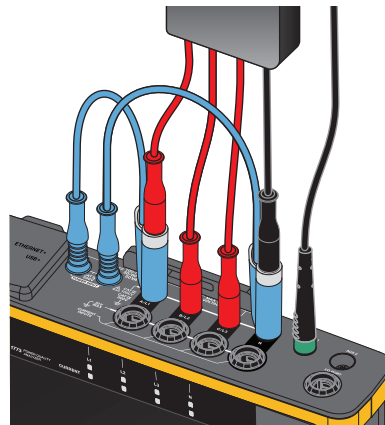

3. Use the short fan out of the Voltage Test Lead, 3-phase + N. Plug the connector A/L1 into the socket A/L1 of the voltage measurement inputs of the Logger.
4. Repeat this with B/L2, C/L3 and N.

Figure 10. Measurement without Neutral Voltage and Instrument Power Supply

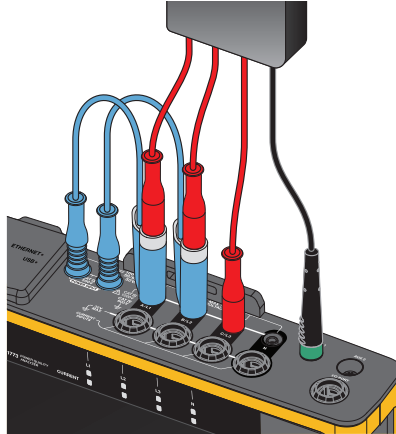

*Note*

*You must locate and connect an alternate power source to the instrument if the voltage to measure is <100 V or >600 V. Use rated test leads or the supplied power cord.*

5. Connect the voltage inputs to the test points.

## Battery Power Source

The Analyzer operates on battery power.

- Battery life up to 1.25 hr
- Operating temperature range -10 °C to 50 °C
- Charging temperature range -10 °C to 50 °C

Push **ⓘ** to turn on. The Analyzer is ready to use in <30 seconds. The battery symbol in the status bar indicates the battery status. See [Table 5](#).

### **⚠ Caution**

#### **To prevent damage to the Product:**

- **Do not leave batteries unused for extended periods of time, either in the product or in storage.**
- **When a battery has not been used for six months, check the charge status and charge the battery as appropriate.**
- **Clean battery packs with a clean, dry cloth.**
- **Battery packs must be charged before use.**
- **After extended storage, it can be necessary to charge and discharge a battery pack to obtain maximum performance.**
- **Dispose of the batteries properly.**

## USB-C Power

You can power the Analyzer with the USB-C connection to a wall outlet adapter when power from measurement line is not available.

Setup:

1. Connect the USB-C cable to the Analyzer.
2. Connect the USB-C cable to the wall outlet adapter.

The Analyzer automatically turns on and is ready to use in <30 seconds.

### Note

*Power from the USB-C requires a minimum 18 W wall outlet adapter. The supported voltage/current ratings are 9 V/2 A or 12 V/1.5 A.*

## Touchscreen/Basic Navigation

The touchscreen lets you interact directly with what is on the display. To change parameters, touch a target on the display. Touch targets are easy to recognize, such as large buttons, icons, menus, or keys on a virtual keyboard.

The touchscreen works when you must wear gloves for operation, including a combination of 1 mm rubber gloves and leather gloves with ARC 4 protection rating. For best practice, make sure you keep the distance between your finger and the screen to a minimum. For example, avoid pressing on the screen with a glove seam between finger and screen.

As backup, use the pushbuttons to the right of the display to operate the Analyzer.

## Home Screen

The Home screen is your primary access to all functions of the Analyzer. The Analyzer functions are divided into two modes of operation: PQ Meter or PQ Logger. Tap  in the upper left corner of the display to return to the Home screen or the previous submenu.

Icons at the top of the Home screen are quick access for:

 Info Overview

 Instrument Settings

 Recording

 Memory

## Info Overview

Touch  to open the Info Overview menu.

The Info Overview is a list of useful information about the Analyzer:

- Serial Number
- Instrument Name
- Calibration Date
- Operating Temperature
- Harmonics
- Waveshape Deviation
- Transients
- WiFi/BLE Availability
- Cellular Modem Availability
- SD Card Installation
- Battery Status

The menu on the left side opens submenus for:

- Licenses

This shows the installed licenses. The Analyzer has these licenses installed:

- GOST Reporting: Creation of power quality reports according to Russian GOST standards.
- IEEE 519: Power quality assessment according to IEEE 519
- VNC Server: VNC server for remote access of the user interface. See [Remote Display](#) for more information.

- Communication

This screen provides connection details, such as IP address, gateway, and SSID for the WiFi access point and WiFi Client client, Ethernet, and LTE.

- Sensors

This screen provides an overview of the connected current sensors.

- Open Source Licenses

This shows the Open Source obligations and license text of the Open Source code used in the Analyzer firmware.

- Radio Certification

This screen shows the electronic radio certification labels for the WiFi/BLE and LTE module.

## Memory

Touch  to open the Memory submenu.

The menu on the left side opens submenus for:

- Memory Used
- Logging Sessions
- Screen Captures

### Memory Used

The Memory Used screen indicates how much memory has been used and how much is available. The amount of memory available is expressed as a percentage. If a micro SD card is installed, the memory available is the amount of GB of the memory card. When a micro SD card is installed, the internal memory of 8 GB is not used.

The Memory Used screen includes the **Copy All to USB** option. Be sure that the USB flash drive matches the total capacity of the micro SD card.

#### *Note*

*When files are copied the name is automatically created so older files are not overwritten. You may need to archive the files from the USB flash drive to make sure you have enough space for the data download.*

### Logging Sessions

The Logging Sessions screen is a list of all the saved measurements in the Analyzer. Files from PQ Meter sessions use the naming convention Meter.xxx and Logger sessions use Logger.xxx. Use the up/down cursor keys or drag on the touch screen to scroll through the saved files. As a file selection changes, the information about the file updates on the screen. This information includes date and time of the start and end of the session and the length of the session. You can delete, chose a single file, or all files on the Analyzer in this screen. You can copy a single file to the USB flash drive and use a file as a template to set up the next session. Tap **View** to analyze the selected session.

#### *Note*

*Live data is not available when the session is complete.*

### Screen Captures

The Screen Captures screen is a list of screen captures saved in memory. Screen shots can be very helpful in reports to show a visual of what occurred during the Meter or Logging session. For example, a screen capture of the complete PQ Health table helps to explain an overview of the session. Each of the screenshots includes a date and time stamp for management. From this screen you can delete a single capture or all captures. You can also copy the screen captures to a USB flash drive. These are saved to a folder:

Fluke 177x\



**Tip.** Screenshots are a valuable source of data for reports that are used for confirmation of the state of the measurements at the time of the capture. Best items for including are the verification screen to prove the setup is correct, the scope picture, the phasor picture, and the PQ Health screen for a completed logging session.

*Note*

*When on site, photographs of the location that show the connections and rating plates of electrical panels, transformers, or motors are useful. These can be integrated in to the final Fluke Energy Analyze report. Also consider including thermographic or acoustic images.*

Table 5 is a list of the symbols that show in the status bar with an explanation for each.

**Table 5. Status Bar Indicators**

①	Date and time
②	Time synchronization status: GPS: on               GPS: Error               NTP: Chosen               GPS to NTP: Default condition
③	Topology
④	Memory gauge (linear or circular)
⑤	WiFi hotspot
⑥	WiFi client
⑦	Battery icon and status: Line power icon:

## Energy Analyze Plus Software

Purchase of the Product includes Fluke Energy Analyze Plus software. Use the software to do many tasks from a computer:

- Update the Analyzer firmware.
- Download campaign results for further processing and archiving.
- Analyze energy or load profiles, including zoom-in and zoom-out on details.
- Analyze voltage and current harmonics.
- Review the voltage and current events that occur during the campaign.
- Add comments, annotations, pictures, and other supplementary information to campaign data.
- Overlay data from different campaigns to identify and document changes.
- Create a report from the analysis.
- Export measurement results for further processing using a third party tool.

## System Requirements

The computer hardware requirements for the software are:

- Free Hard Disk space minimum 300 MB, >100 GB (for measurement data) recommended. Additionally, Energy Analyze can use up to 3 % of the disk size for internal logs. Internal log data is not shared with Fluke or any third party unless allowed by the user.
- Installed Memory:
  - 2 GB minimum, >2 GB recommended for 32-bit systems
  - ≥8 GB recommended for 64-bit systems
- Monitor, 1280 x 1024 (@4:3) or 1440 x 900 (@16:10), wide-screen (16:10) or higher resolution recommended
- Ethernet, WiFi, or USB ports
- Windows 8.1 32/64-bit, Windows 10 32/64-bit

Energy Analyze Plus software performance improves on systems with SSD data storage. For future updates, Fluke recommends systems based on CPUs that support the SSE4/BMI2 instruction set.

### *Note*

*Windows 7 Starter edition and Windows 8 RT are not supported. Energy Analyze Plus also works on Windows Vista and Windows 7 systems but is not specifically tested because manufacturer support has been discontinued.*

## How to Connect to Energy Analyze Plus

The Analyzer supports these interfaces to connect to the PC:

- USB cable
- Ethernet
- WiFi - direct connection
- WiFi - connection to infrastructure

### Note

*After the connection is established, Energy Analyze Plus software shows the Analyzer in the list of found devices. Choose the Analyzer to setup and/or download measurement data from.*

### USB Cable

To connect the PC to the Analyzer:

1. Turn on the computer and the Analyzer.
2. Make sure Energy Analyze Plus Software is installed. The software installation also installs the required drivers.
3. Connect the USB cable to the USB ports of the computer and the Analyzer. See [Figure 11](#).

**Figure 11. PQ Analyzer to PC Connections**

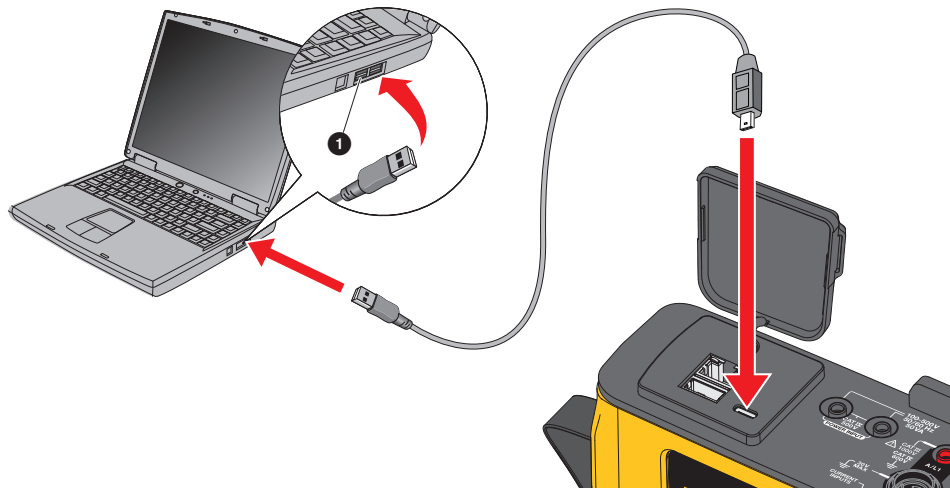

4. The USB cable connection uses a network communication over USB (Remote NDIS network) with Internet Protocol IPv6. When you connect the Analyzer with the RNDIS network interface, a serial port "USB Serial Port (COMx)" appears in Windows device manager. This serial port is for production and service/calibration purposes only.

*Note*

*Make sure IPv6 is enabled on your Windows system.*

## Ethernet

Use a commercially available Cat 5 or higher Ethernet patch cable to connect the Analyzer to your LAN (local area network). A communication over Ethernet requires that each device has a unique IP address. Two options exist: Either a device obtains an address from a DHCP server or the device uses a static, user-configured address.

The default setting of the Analyzer is to obtain an IP address from a DHCP server automatically. The Analyzer allows a Ethernet point-to-point connection between the Analyzer and a PC. The Analyzer has Auto-MDI-X support to switch automatically between 1:1 for a device-to-LAN connection and cross-over mode required for a device-to-device connection. A cross-over cable is not required. The Analyzer and PC self-assign IP addresses in the range of 169.254.x.x automatically after the timeout to receive an IP address from a DHCP server expires.

*Note*

*During the typical timeout of 1 minute, Windows shows the status "Identifying" in the network status. Windows may show an exclamation mark in the network status icon indicating that the connection does not provide Internet access. This is normal.*

The Analyzer communicates with the Fluke Energy Analyze Plus software on these ports:

<b>Type</b>	<b>Port Number</b>
TCP	80 (HTTP)
TCP	443 (HTTPS)
TCP	18571
UDP	18572

The software installer for Energy Analyze Plus automatically adds exceptions to the Windows firewall. If a third party firewall is used, add the ports and the application fea.exe to the exception list.

## WiFi Direct Connect

With the built in WiFi/BLE Adapter you can wirelessly control the Analyzer and download measurement data to the Energy Analyze Plus software. The WiFi direct connection uses WPA2-PSK (pre-shared key) with AES encryption.

To make a WiFi connection:

1. If not already, enable the WiFi Access Point on the Analyzer.

For more information, see [Basic Setup - Communication Settings](#). Stay in this screen to get the WiFi passphrase that is required to connect from a device to the Analyzer.

The status bar indicates the enabled WiFi Access Point with . When one or more devices are connected, this icon turns orange.

2. On the client, go to the list of available WiFi networks and look for a network with the name: "Fluke177x<serial-no>" for example: "Fluke1777<12345678>".
3. At the prompt for WiFi passphrase, enter the passphrase from the WiFi Access Point configuration screen.

Depending on the operating system of the client, the passphrase is also called Security Key, Password, or similar. After a few seconds, the connection is established.

A blue WiFi Hotspot LED indicates an established connection with a client.

### Note

*Windows checks if the WiFi connection enables an Internet connection. This may take up to one minute until the Analyzer is accessible. A missing Internet connection is indicated by the "No Internet" (an exclamation mark or a globe) icon in the Windows task bar if this is the only network connection. This is normal since the Analyzer is not a gateway to the Internet.*

## WiFi to Infrastructure

The WiFi/BLE Adapter also supports a simultaneous connection to a WiFi access point. This connection requires a DHCP service running in the access point to assign IP addresses automatically.

To connect to an access point:

1. Select the access point from the list of found SSID (Service Set Identifier - name of the access point).
2. Enter the passphrase (8 to 63 characters) of the access point.

## Auto-Copy Data to USB

The Analyzer supports automatic actions on insertion of the USB flash drive. This is helpful to gather data from the Analyzer without the need to establish a connection to the Analyzer to download the data to the PC.

To enable the auto-copy mode:

1. On a USB flash drive, create the folder **Fluke177x** (no spaces in file name).
2. Create a file **AutoCopyData.txt** in the \Fluke177x folder.
3. Make sure the Analyzer is powered from mains.
4. Plug the USB flash drive into the Logger.

All recorded measurement data is copied to the USB flash drive. During the file transfer the Start/Stop LED flashes white. This can take a few minutes depending on the amount of stored data. You can remove the USB flash drive when the Start/Stop LED changes color to green. If the LED is amber, an important warning or information is available. See the remote control software, such as Energy Analyze Plus, for more information.

To disable the auto-copy mode:

1. Go to the folder **Fluke177x** on the USB flash drive.
2. Remove or change the name of the **AutoCopyData.txt** file.

## First-time Use/Setup Wizard

Before you start:

1. Attach the wire clips to both sides of the current probe cables. Depending on the region, use clips labeled A, B, C, N or 1, 2, 3, N.
2. Assemble the magnet hanger if you plan to use.
3. Connect the Analyzer to mains power and follow the first-time use/setup wizard to configure the date, time, time zone, phase color scheme and label, as well as nominal voltage and frequency.
4. Keep the Analyzer turned on until the battery is fully charged.

## First Measurements

At the measurement site, look at the information in the panel and the rating plates on the machines. Based on knowledge of the electrical supply in the facility, determine the configuration. The example below performs a measurement on a three-phase wye system.

To set up the Analyzer:

1. Connect the Analyzer to mains power. The Analyzer starts and shows the Main Menu.

### Note

See Measurement Line Power Source *if you want to power the Analyzer from the measurement line.*

2. In the Main Menu, select the measurement mode as **PQ Meter**.  
The connection verification display shows the voltage, current and frequency readings.
3. Push **Topology** to configure the three-phase wye and the nominal voltage.
4. Use the cable end with the short fan-out of the 3-phase + N voltage test lead and connect A/L1, B/L2, C/L3, and N into the Analyzer.
5. Connect the voltage test leads to phase A/L1, B/L2, C/L3, and Neutral.
6. Connect the green test lead into the Analyzer.
7. Connect the green test lead to a good ground source, such as a bare, uncoated part of the cabinet. Ideally, a grounding lug in the panel.
8. With all of the connections done, check that the voltages for phases A/L1, B/L2, C/L3, and Neutral to Ground are as expected.
9. Connect the Thin-Flexi current probes to the Analyzer:
  - Phase A/L1 current probe into the phase A/L1 input jack
  - Phase B/L2 current probe into the phase B/L2 input jack
  - Phase C/L3 current probe into the phase C/L3 input jack
  - N (neutral current) probe into the N input jack

To measure the system:

1. Apply the iFlex Probes to the wires in the electrical panel. Make sure the arrow on the probe points to the load.

2. Read the current measurements for phases A/L1, B/L2, C/L3, and N.

A yellow **START** button indicates errors found in the connection. Watch for undervoltage or overvoltage indications, polarity of current probes, and the phase rotation for voltage and current. Most installations use a clockwise rotation.

- a. Make sure to check also phasor and scope in the **Verify Phasor** and **Verify Scope** menus.
- b. Push **Correct Digitally** to make changes on the connection or push **Auto Correct** to apply corrections automatically.

If no errors are found, the **START** button turns green.

3. Push **START** to activate all measurement parameters. The measurement parameters are also stored to the internal flash drive.
4. Navigate through the available measurement screens with the left touch buttons. Swipe up and down to see them all.
5. Push  to take a screen shot.
6. Download the measurement during and after the logging session with *Energy Analyze Plus*.
  - a. In the software, click **Download Data** and copy the logging session from the Analyzer to the PC.
  - b. Open the session and view the measurement data. For more information about how to use the software, see *Energy Analyze Plus Online Help*.

## Measurement Configuration

The Home screen has two configuration options for measurement: PQ Meter and PQ Logger.

### PQ Meter Mode

The PQ Meter mode offers instant measurements to troubleshoot power quality. During the PQ Meter session, the Analyzer captures and shows the measurements on the display. These measurements are automatically stored in memory every second for up to 24 hours. A flashing green power button on the Analyzer indicates an active session. See [User Interface](#).

A red recording icon  shows on the display above the measurements and indicates an active logging session.



To stop a logging session:

1. Tap .

A confirmation message shows on the display.

2. To continue, confirm that you want to stop the logging session.

The Analyzer stores the measurements in memory with this file name convention:  
Meter.xxx (xxx = three digits).

Each time a session is stored, the digits increment and save a new file.

To proceed in PQ Meter mode:

1. Select **Verify Meter**.

The Verify Meter screen shows that the voltage and current probes are correctly connected (correct phasing and correct probe orientation).

2. If an error has been made, select **Correct Digitally** at the foot of the screen or push **Auto Correct** to apply corrections automatically.
3. If the readings on screen are as expected, push **START** or go back to **Setup**.

## Setup

In Measurement Settings, the basic setup from the Start Up Wizard shows on the display. Select any item on screen to adjust these settings.

## Topology

To select a topology, go through the list by dragging the scroll bar at the left side of the list or tap on the cursor buttons at the top and bottom of the list.

The display updates to show the wiring diagram for each topology.

## Nominal Voltage and Frequency

The nominal voltage is the expected voltage of the system. If this is set incorrectly, the voltage continues to be shown but the resulting power quality reports will be incorrect as they require the nominal voltage to compare with the allowable deviation. Similarly, the nominal voltage and nominal frequency may be changed using the same method.

## Voltage and Current Ratio

If a voltage and current transformer is included in the measured circuit, you can choose a multiplier so that the results appear in the correct engineering units, for example, kV or MW.

To set the ratio for phase voltage and neutral:

1. Select the primary ratio (which is then compared to 1).

The touchscreen number pad opens. When the ratio is expressed as 1000:25, the setting is 40:1. Most often the ratio is expressed with reference to 1.

2. To clear the default 1 in the display, tap  .

3. Input the new number using the touchscreen number pad.

In the current ratio screen the default setting is Auto. In this mode the Analyzer adjusts automatically to get the best measurement resolution. You can change the current range to a fixed range that is dependent on the connected current flex or probe device. The Analyzer automatically detects a connected device. Detection includes specific information about the device such as the serial number and the calibration constant for the best results.

## Flicker

The Flicker setting is adjustable to a selected nominal voltage value. This value enables the correct evaluation of any recurrent small changes on the electrical system caused by other loads connected to the power system in the local electrical system or on the power utilities network.

The preferred setting is **Match Nominal Voltage**, which is the nominal voltage selected for the Analyzer. Flicker is measured in accordance with the IEC 61000-4-15 standard.

## K Factor

K Factor is a ratio that expresses potential energy losses experienced in transformers due to harmonics and eddy current losses at the fundamental frequency. There are two methods to make the K Factor: IEEE C57:110 and EN 50464-3/EN 50541-2. Selection of the method is usually dependent on the selected type of K rated transformer specification. K rated transformers are designed and built to alleviate the effects of harmonics that may increase the temperature of the transformer. Other values selected in this screen include harmonics and constants e and q. You can select the 40<sup>th</sup> or 50<sup>th</sup> harmonics for inclusion in the calculation. The constants e and q refer to eddy current loss at the fundamental frequency divided by the loss due to a dc current equal to the RMS value of the sinusoidal current. This is an exponential constant that is dependent on the type of transformer winding and frequency.

## Event Trigger Settings

The capture of events requires trigger settings. A set of standard settings are enabled by default. These triggers are to specify when a detailed RMS capture occurs in the Analyzer. The 1775 and 1777 models also include a waveform and transient capture as well as the detailed RMS voltage capture.

The available settings are:

- Dip
- Swell
- Interruption
- Waveshape Deviation
- Transients
- Rapid Voltage Change
- Inrush Current

For more details about each of these event settings, see [Glossary](#).

**Dips and Swells.** For dips and swells the capture is based on the RMS voltage expressed as a percentage of the nominal voltage.

The defaults for these settings are 90 % and 110 %. This means that for a 230 V nominal the voltage must drop by 23 V to capture, and a swell capture is triggered at 253 V. Hysteresis of 2 % is automatically assumed, this means that the event is considered to have ended if the 2 % recovery within 90 % or 110 % of voltage is made. This setting ensures that multiple events are not captured for a single event. The setting of this voltage is considered from a standard averages period of 200 ms or a sliding reference is applied. This reference considers the last 10 cycles for 50 Hz or 12 cycles for 60 Hz.

Use a sliding reference where the nominal voltage can vary more freely. This is usually the case in high voltage systems. When you apply the sliding reference, the Analyzer detects dips and swells based on a voltage change relative to the actual rms voltage, rather than, the absolute nominal voltage.

**Interruptions.** Interruptions are events when a total power loss is made at the load across all measured phases. This could be a blown fuses, a breaker tripping, or utility power loss. In the case of power loss, the default value is 5 % of the nominal voltage. You can increase this voltage if the registration of the interruption is not correctly represented or if the electrical system is supported for several cycles by inductive or capacitance effects in the system. An automatic hysteresis of 2 % is applied.

**Waveshape Deviation.** The deviation of the waveform considers the consecutive waveform based on sample-to-sample comparison of the waveform. The trigger starts when the magnitude of each cycle is compared with the sample magnitude on the next cycle. This is expressed as a percentage of the nominal voltage. The default setting is 10 % of voltage. To activate this trigger, check the **Trigger On** box.

**Transients.** If the model in use includes the transient feature, the trigger settings consist of High, Medium, and Low. These settings are on values that are equivalent of 200 %, 100 % and 50 % of the nominal voltage superimposed on the voltage waveform at any point during the cycle. In addition, there is a user selectable custom setting expressed as an absolute voltage.

With the 1777 Analyzer, select the sample rate of the transient capture as either 1 MHz or 20 MHz. The 1775 Analyzer defaults to the maximum sample rate of 1 MHz.

To activate this trigger, check the **Trigger On** box.

The Analyzer safely captures transients up to  $\pm 8$  kV.

**Rapid Voltage Changes.** Quick transitions of voltage between two steady state voltages are known as rapid voltage changes (RVCs). The capture trigger for RCVs is based on a percentage of the nominal voltage. The event is captured when the arithmetic mean of 100/120 (50/50Hz) half cycle RMS value is below the set trigger limit.

**Inrush Current.** Inrush occurs when large loads or low impedance loads are connected to the power systems. Examples are motors, transformers, and capacitive loads. During the connection, the current draw can increase to 10x or more of the normal level. The threshold for capture is set as an absolute level of the measurement of a half cycle RMS value.

The trigger must be turned on to be operable. The Analyzer adds a default hysteresis.

*Note*

*See the [Glossary](#) for more information about these configuration effects and details of the triggering mechanisms.*

## PQ Logger Mode

PQ Logger mode provides the ability to log measurements over an extended period of time to find intermittent issues or trend data to discover the overall performance of the electrical system. PQ Logger mode includes all the PQ Meter Mode functions as well as additional measurements to customize the average period for each of the stored measurements and the collection period.

In PQ Logger mode, the Analyzer guides you through the steps to collect measurements that describe the health of the electrical system during the measurement period. The first screen shown is the Measurement Settings screen that includes extra items compared to the PQ Meter setup.

The extra items are:

- Power Quality Standard
- Mains signaling voltage
- AUX (analog inputs)

See [PQ Meter Mode](#) for descriptions of other settings.

### PQ Logger Measurement Settings

The Measurement Settings screen enables the evaluation method for the captured measurements.

#### Power Quality Standard

During the logging session, the measured values are captured and evaluated according to the selected standard as the measurements are in progress. The ongoing results show on the PQ Health screen as an overview of all measurements. See [Measurement Data Review](#) for more information.

To select the standard:

1. Tap on **Power Quality Standard**.
2. Choose the standard in the list.
3. Tap **ENTER** to make the selection.

If no selection is made, the Analyzer applies a default so that the PQ Health screen shows some useful data.

## Harmonics Grouping

The Harmonic Grouping selection at the bottom of the screen allows for a different method of harmonics representation. The listed standards most frequently recommend Subgrouped harmonic.

### Note

*Fluke recommends the Subgrouped setting unless there are special circumstances why the other methods are applicable for the required test. A change to this grouping method could lead to inconsistent results when making comparisons of other measurements made at the same or other locations.*

Select **Done** to exit the Harmonics Grouping screen.

## Mains Signaling

Mains signaling, or ripple control, is a technique used by utilities to instruct revenue meters to switch tariffs, turn on street lighting, or turn on other loads. The mains signaling selection enables capture of two signal frequencies other than the system frequency. The frequencies must be specified in the setup and between 110 Hz and 1600 Hz.

To set the Mains Signaling voltage:

1. Enter the value in the Frequency 1 and Frequency 2 fields.

After you enter the frequency, the Enable radio button is automatically checked as active.

2. Tap **Done**.

This measurement is increasingly rare. If you do not need this information, ignore the setup. The selection is switched off as a default.

### Note

*See the [Glossary](#) for more information about these configuration effects and details of the triggering mechanisms.*

## AUX

The auxiliary, or analog, inputs are dc inputs that have a physical socket on top of the Analyzer reserved for  $\pm 10$  V dc signals. These signals may be from transducers that output voltage or current. Each analog input signal can be labeled to describe the signal along with the applicable engineering units, such as V dc, V ac, I ac, °C, or Nm. Select a gain and an offset to scale the 0 V to 10 V signal so that the display shows the correct values.

This example considers an output of a temperature transmitter with 4 mA to 20 mA current that represents 0 °C to 250 °C:

1. Feed the current through a 50 Ω resistor to convert the signal to a voltage of 0.2 V dc to 1 V dc.
2. Use the on-screen keyboard to input the name, **Pressure**, the units, and the mathematical constants that change the 4 mA to 20 mA to pressure readings.

At 4 mA the voltage will be 0.2 V dc representing °C. At 20 mA the voltage will be 1 V dc representing 250 °C. The span of the signal from 0 to 250 °C will be 0.8 V. To create a value of 250 °C at full scale the signal is multiplied by 312.5 (250/0.8). As the 0 °C is 0.2 V dc, an offset is applied, this offset is the difference between 250 and 312.5 which is 62.5.

3. Check the **AUX** box to enable the display and logging of the AUX input.

Before logging can start, review the Event Trigger Setting. This setting ensures a check is made before the logging session starts and results in a session that delivers valid data every time.

*Note*

*To use this feature you will need to purchase the optional Models: Fluke 17XX AUX Input Adapter Box that allows inputs of ±1000 V dc with 4 mm sockets or ±10 V dc with push-in terminals.*

### **PQ Logger Event Trigger Settings**

The Event Trigger Settings are supplementary to the PQ Meter Trigger Settings and are used for mains signaling only.

The trigger is based on a small percentage of the Nominal Voltage but only appear for triggering at the frequencies selected in the mains signaling setup. The typical setting is 5 % of nominal. The trigger must be enabled with the **Trigger On** radio button. (Most applications will not need this trigger turned on.)

Other event trigger settings should also be reviewed. See [Event Trigger Settings](#).

### **Session Settings**

The Session Settings specify the duration of the logging session from an absolute date of some unknown date in the future, the average period of each of the logged measurements, and the details required for harmonics measurements. In addition, you can create a unique name for the session and a description of the session that is included in all reports generated from the data.

**Name.** Type in a name for the logging session with the on-screen keyboard.

**Description.** Type in useful information about the measurement session for the report. Include information about the measurement location, who performed the installation, and the type of equipment being monitored.

**Duration, Start Time.** 10 minutes, 1 hour, 1 day, 1 week, and 30 days are the preset durations available for logging sessions.

There are also special settings:

- **No End:** a session that never ends, when the memory is full, the memory is overwritten. The length of the session depends on the selected average period and the detail of the harmonics logging.
- **Maximum:** a session that fills the memory and then stops.
- **Custom:** provides the flexibility to select the length of the session in terms of a chosen number of days or hours.

For each of the duration selections (except No End) select a Start Time. This can be immediately when the session starts or a future date (day, month, and year), hours, and minutes.

After setting the Start Time, select **Done**. Select **Done** once more to exit the Duration, Start Time screen.

An overview of the Session Settings shows on the display. The next step is a final check to ensure the wiring to the Analyzer is correctly connected. When everything is correct, start the session. The Analyzer now shows the measurements in process. For a future start time, a count down timer shows when the first readings will be available.

**Trend Interval.** The trend interval selection provides for the resolution of the trend plots recorded by the Analyzer. This selection impacts the amount of memory used like duration. Select **Done** to exit Trend Interval.

**Harmonics.** The Harmonics selection allows the addition of interharmonics to the recording. For IEEE 519 purposes, 3-second harmonics can be selected. When evaluating the impacts of higher-order harmonics introduced into the power system from energy conversion systems like inverters, check the **Supra-harmonics** box to measure harmonics up to 30 kHz. Select **Done** when finished to return to the main Session Settings screen.



## Measurement Data Review

The Analyzer has features for measurement data review in both the PQ Meter mode and the PQ Logger mode. The PQ Logger mode also includes the PQ Health feature.

### PQ Health

The PQ Health feature is available only in PQ Logger Mode.

When the PQ Logger Mode session starts, the Analyzer shows the overall PQ Health of the electrical system as a summary of these parameters:

- Frequency
- Voltage
- Harmonics
- Unbalance
- Flicker
- Mains Signaling
- Events (dips, swells and interruptions)
- Rapid Voltage Changes
- Waveform Deviations

The frequency, unbalance, and events have a single bar.

Voltage variations and voltage harmonics show as three bars that depend on the configured topology. The length of a bar increases if the related parameter is further away from its nominal value. The bar turns from green to red if a maximum allowed tolerance requirement is surpassed. When the standard defines two limits for a parameter (for example, voltage variations have a limit for 95 % of the time and a limit for 100 % of the time) the bar changes from green to orange when the parameter surpasses the 95 % limit but does not exceed the 100 % limit.

The exact representation shown on this screen depends up on the Power Quality standard chosen in the setup. See [Power Quality Standard](#). As the measurement proceeds, the green bars typically grow as they get to the allowable limit indicated with a dotted bar. If the values start to exceed the 95 % or 100 % limits, the bars turn to yellow or red. This is an immediate insight that there is a problem.

### Overview

The Overview screen is a summary of the voltage current and power variables and THD (Total Harmonic Distortion).

### V/A/Hz

The V/A/Hz screen is a more detailed view of voltage, current, and frequency. Voltage values include phase-to-neutral, peak-to-peak, peak, and crest factor. Current values includes peak current and crest factor. Any analog variables show at the bottom of the screen.

## Power

The Power screen shows the details of phase by phase active power, apparent power, non-active power, power factor, and harmonics power. These values are derived in accordance with standard IEEE1459.

## Dips and Swells

The Dips and Swells screen shows voltage and trend graph with phase voltage in the upper half and neutral voltage in the lower half. Tap on **Voltage** or **Current** at the bottom of the screen to toggle the trend between voltage and current. This provides information for each phase or all phases.

The data on screen is either **Live** or **Session** data. Tap on the button to select the view. The Session data screen shows any events in a list with the date and time of the event, the duration, the event type, the value, severity, and the applicable phase. Tap an item on the list to see more details. The waveshape shows several cycles of the waveform and the trigger point. Often, the waveshape data does not show a strong indication of the event as the trigger is based on an RMS value that occurs over many cycles. The RMS profile is chosen in the same screen to show the limits for dips and swells. The profile indicates where the voltage was outside of the limit. Colored markers indicate the minimum and maximum voltages from the list that shows on the right of the screen. The display can be customized to show different combinations of voltage and current by individual phase or multiple phases.

## Harmonics

Voltage, current, and power harmonics show as either a percentage of the fundamental or RMS values by phase. Harmonics are available as three types Integer harmonic from 0 to 50, Inter-harmonics, and harmonics from 2 kHz to 30 kHz. Harmonics show as either bargraphs with the % or RMS scale or in a live trend. This option shows the available bargraph form in the top half of the screen. The lower half of the screen shows a graph of the chosen harmonic. Tap on the corresponding harmonic or use the cursor keys to select each harmonic.

## Transients

The Transients screen shows the displayed values and access to data is identical to dips and swells with one exception when in the Session screen, transients are listed in the same way as dips and swells with description by the date and time of the vent, the duration, the event type, the value, severity, and the applicable phase. Select any item from the list to see the waveform on the screen.

Any data that is considered to be a transient will have a frequency  $> 1.5$  kHz as the measurements to the transient recording session are filtered to reject signal frequencies below the filter pass frequency. All 1 MHz sampled transients have a time resolution of  $1 \mu\text{s}$  and 20 MHz sampled transients have a 50 ns resolution.

## Events

The Events list shows every type of event that might have occurred. These can be filtered into event types such as dip, swell and interruption, waveshape deviation, transients, rapid voltage changes, mains signaling, and inrush current. Each type of event can be selected for a closer view by waveshape and RMS profile.

## Flicker

The flicker values of  $P_{inst}$ ,  $P_{st}$ , and  $P_{lt}$  show for each phase:

- $P_{inst}$  is instantaneous flicker that is calculated over a 200 ms period
- $P_{st}$  is short term flicker calculated over a 10 minute period
- $P_{lt}$  is calculated over a 2 hour period.

## Unbalance

The Unbalance screen shows the complete range on unbalance variables for voltage and current. These include positive, negative, and zero sequence values that are calculated in accordance with IEC61000-4-30.

## Scope

The Scope screen is a quick check of each voltage and current waveform for each phase that resembles an eight-channel oscilloscope display.

## Phasor

The Phasor screen shows the voltage and current phasors to indicate the relationship between the phasors with relative or absolute angles.

## Basic Setup

The basic settings are accessed with the settings button on the Home screen. This accesses three group of setting, Instrument Settings, Communication Settings, and Tools.

### Instrument Settings

Touch  to open the Instrument Settings menu.

The Instrument Settings menu is where you set:

- Instrument Name
- Language
- Time Zone
- Date and Time
- Phase Colors

The menu on the left side opens submenus for Communication and Tools Settings:

- IP Address
- WiFi Client
- WiFi Access Point
- Remote Display
- Reset to Factory Defaults
- Copy Service Data to USB
- Firmware Update

**Instrument Name.** Identify the Analyzer with a unique name. The name is typed in with the on-screen keyboard.

**Language.** Select the preferred language from a list of available languages. Scroll up and down in the list to see all available languages.

**Time Zone.** Set the time where the Analyzer is in use. Touch the screen and choose the continent and country. Scroll the list up and down to see all the available countries.

**Date and Time.** Set the format first from the available options. Choose the option for day, month, year. Choose the clock type as 12 or 24 hour format with the radio button.

The date and time settings have manual or automatic options:

- The automatic sources of time are Internet time if the Analyzer has an active Ethernet connection or WiFi signal. For more precise time (for IEC 61000-4-30 Class accuracy) an internal GPS clock is used. The GPS clock requires a GPS antenna that can pick up the GPS signal from at least two satellites.
- For a manual setting, input the date and time with the on-screen keyboard.

**Phase colors.** These are assigned by the start-up wizard when the Analyzer is used for the first time or has been reset. However, you can adjust these colors on the menu when you select a global region. Use this same screen to label the phase with letters.

## Communication Settings

These settings relate to communications with the Analyzer.

**Ethernet.** The instrument address can be set automatically or manually. The default setting is Automatic when you select Ethernet from the settings list. For Manual setting, deselect Ethernet and set the inputs for IP Address, Netmask, Gateway, and DNS.

### *Note*

*Only change these settings if you have the required networking knowledge.*

A check box allows you to turn off the option for all wireless interfaces when required in sensitive locations.

**WiFi client.** This setting directly connects the Analyzer to the local WiFi network and allows access to the Analyzer from any location within the WiFi network. When the WiFi client is off, the available network access points appear in a list in screen. The network password is required to connect to the local network. Select the network and enter the password with the on-screen keyboard. It is not possible to enter a username and password.

**WiFi Access Point.** The Analyzer can be set as a WiFi Access point and creates its own WiFi network that a device can connect to. This can be used to download data from the Analyzer with Fluke Energy Analyze software or for control with a Virtual Network Computer. See [Remote Display](#).

The WiFi direct connection uses WPA2-PSK (pre-shared key) with AES encryption. The passphrase shown on the screen is required to establish a connection from a client to the device.

To setup:

1. On the client, go to the list of available WiFi networks and look for the network name:

Fluke177x<serial-no>

For example: Fluke1777<123456789>

2. At the prompt, enter the passphrase provided on the WiFi Configuration screen.

Depending on the operating system of the client, the passphrase is also called Security Key, Password, or similar.

After a few seconds the connection is established.

### *Note*

*On the PC, the WiFi icon in the notification area of the task bar shows (the icon varies for the Windows version). The icon indicates that this WiFi interface does not provide an Internet access. This is normal since the Analyzer is not a gateway to the Internet.*

**Remote Display.** You can remotely connect to the 177x models with a free third-party Virtual Network Computing (VNC) client available for Windows, Android, Apple iOS, and Windows Phone after the WiFi connection is set up. VNC allows you to see the screen content, push the buttons, and touch the targets. [Table 6](#) is a list of tested VNC clients that work with the Analyzer.

**Table 6. VNC Clients**







Operating System	Program	Source
Windows 7/8.x/10	TightVNC	www.tightvnc.org
Android	bVNC	Google Play Store
iOS (iPhone, iPad)	Mocha VNC	Apple App Store

Complete all the fields in the Configuration screen:

- IP Address (for direct connection): 10.237.186.1
- When connected to a WiFi Infrastructure: use IP address (see [Basic Setup - Communication Settings](#))
- Port: 5900 (default)
- VPN user name and password: are not configured and can be blank.

The remote display mimics the Analyzer screen so you can set up the instrument and view all the measurements. See [Table 7](#). It is not possible to download the data using this connection.

**Table 7. Control Keys from VNC Client**

Analyzer Key	VNC Client Key
	<cursor right>
	<cursor left>
	<cursor up>
	<cursor down>
	<Enter>
	<Esc>
	<F12>
Screen Capture	<F11>

Press any key or tap the display on the Analyzer to disable the remote display and resume access the Analyzer UI.

## Tools

**Reset to Factory Defaults.** On selecting this option consider downloading all data as once the reset occurs all settings and data is lost. A warning to this effect is shown on screen.

**Copy Service Data to USB.** For problems with your Analyzer that our support team can not resolve, we might ask you to copy the service data. You will need a removable USB flash drive with at least 2 GB of free memory. The data will take several minutes to copy. Our support team will give you specific instructions on what to do with this data so our engineers can evaluate the data and get to the root of the problem.

**Update Firmware.** Firmware updates are available to add new measurement functions or fix bugs. The up-to-date firmware version is available at [www.fluke.com](http://www.fluke.com). If you register your Analyzer, we will inform you about any new versions.

To update firmware:

1. On a USB flash drive with at least 100 MB of free space available, create a folder:  
Fluke177x (no spaces in file name).

### Note

*Make sure the USB flash drive is formatted with FAT32 or exFAT file system.*

2. Copy the firmware file (\*.bin) into this folder.
3. Make sure the Analyzer is powered from mains and turned on.
4. Connect the USB flash drive to the Analyzer.

Initially, the Analyzer recognizes that a USB flash drive is connected and prompts you to copy all the files on the instrument to the USB flash drive. If you have unsaved data, this is the last time you will be able to back up the data.

5. Back up the files or close the dialog and return to Update firmware.
6. Follow the instructions.

The Analyzer restarts automatically when the firmware update is complete.

### Note

*A firmware update deletes all user data such as measurement data and screen captures. This firmware update works only when the firmware version on the USB flash drive is newer than the installed version.*

To install the same version or an older version:

1. Select **Tools > Update firmware**.
2. Follow the instructions.

### Note

*The newest firmware version is used for the update if more than one firmware file (\*.bin) is located in the \Fluke177x folder.*

## Maintenance

The Analyzer does not require special maintenance if used appropriately. Maintenance should only be done at a company-related service center by trained and qualified personnel within the guarantee period. See [www.fluke.com](http://www.fluke.com) for locations and contact information of Fluke Service Centers worldwide.

### Warning

**To prevent possible electrical shock, fire, or personal injury:**

- **Do not operate the Product with covers removed or the case open. Hazardous voltage exposure is possible.**
- **Remove the input signals before you clean the Product.**
- **Use only specified replacement parts.**
- **Have an approved technician repair the Product.**

### Caution

**Do not damage the vent behind the battery door or the IP65 ingress protection may be compromised.**

## How to Clean

### Caution

**To avoid damage, do not use abrasives or solvents on this Product.**

If dirty, carefully clean the Analyzer with a damp cloth and a mild detergent.

## Battery Replacement

### Warning

**To prevent possible electrical shock, fire, or personal injury:**

- **Do not short the battery terminals together.**
- **Do not disassemble or crush battery cells and battery packs.**
- **Do not put battery cells and battery packs near heat or fire. Do not put in sunlight.**

### Caution

**Replace the rechargeable battery after 5 years.**

The Product has an internal rechargeable Lithium-ion battery.



To replace the battery:

1. Unfasten the screws and remove the battery door. See [Figure 12](#).

**Figure 12. Battery**

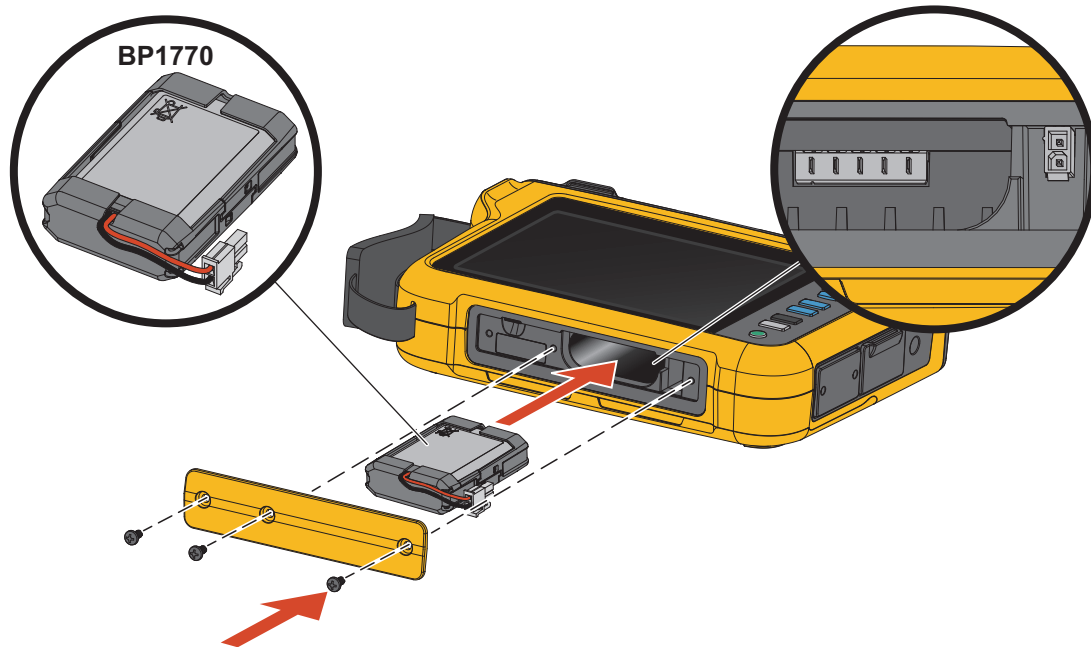

2. Replace the battery.
3. Replace and fasten the battery door with the screws.

**⚠ Caution**

**To prevent damage to the Product, use only Fluke battery pack.**

## Calibration

As an additional service Fluke offers the regular examination and calibration of your Logger. The recommended calibration cycle is 2 years. For more information see [How to Contact Fluke](#).

## Glossary

**Nominal Voltage.** Select a nominal voltage from the list. If a voltage is not shown in the list, enter a custom voltage. The nominal voltage is required to determine the limits for dips, swells, and interruptions. When a voltage transducer is used, enter the nominal voltage on the primary side of the transducer

**Nominal Frequency.** Set the nominal frequency to be the same as the power line frequency, 50 Hz or 60 Hz.

**Voltage Ratio.** Configure a ratio factor for the voltage inputs when a potential transformer (PT) is in series with the voltage connections such as when you want to monitor a medium-voltage network. The default value is 1:1.

**Current Range.** Configure the current range of the attached sensor:

- High Range  
High Range is the nominal range of the attached current sensor. For example, 1500 A is the nominal range on an iFlex1500-24.
- Low Range  
Low Range is 1/10 of the nominal range of the attached current sensor. For example, the low range of an iFlex1500-24 is 150 A.
- Auto  
When set to Auto, the current range is set automatically and depends on the measured current.

### *Note*

*Set the current range to Auto when you are not sure about the maximum current during the logging session. A specific application can require you to set the current range to a fixed range rather than Auto. This can occur because the Auto range is not gapless and may lose too much information in the case of a highly fluctuating current.*

**Current Ratio.** Configure a ratio factor for the current sensors when a current transducer (CT) is used to measure the much higher level on the primary side at a substation or step-down transformer that has a built-in metering current transformer.

Use the current ratio to increase the sensitivity of the iFlex sensor. Wrap the iFlex sensor around the primary conductor, for example 2X, and enter a ratio factor of 0.5:1 to get correct readings. The default value is 1:1.

**Harmonics Calculation Method.** Select the harmonic calculation method to apply according to IEC 61000-4-7. The Analyzer applies a FFT (Fast Fourier Transformation) every 10/12 cycles (typical 200 ms), that delivers spectral components (bins) every 5 Hz from dc up to  $\frac{1}{2}$  fs. The 'fs' is the sample frequency of the A/D converter, for example, 10.24 kHz. The standard allows three different ways to calculate the harmonics from these 5 Hz components: Harmonic Components, Harmonic Sub-Groups, and Harmonic Groups. See [Table 8](#).

**Table 8. Overview**

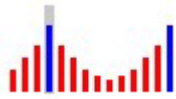
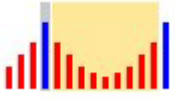
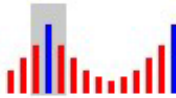
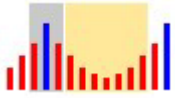
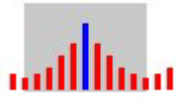
	Harmonics	Interharmonics
<p><b>Harmonic Components</b> (required for measurements according to certain standards, such as IEEE519 or IEC 61000-3-12)</p>	 <p>RMS value of a single 5 Hz component</p>	 <p>RMS value of all bins between two harmonics</p>
<p><b>Sub-Grouped Harmonics (default)</b> (for IEC 61000-4-30 compliant measurements, such as EN50160)</p>	 <p>RMS value of the harmonic frequency and adjacent bins</p>	 <p>RMS value of all bins between two harmonics</p>
<p><b>Grouped Harmonics</b></p>	 <p>RMS value of the harmonic frequency and <math>\frac{1}{2}</math> of the interharmonic spectrum to both sides</p>	<p>not available</p>

*Note*

*Most power quality standards, such as EN 50160, GOST 33073 refer to IEC 61000-4-30 Class A measurement methods that require Harmonic Sub-Groups.*

**Harmonic Components.** The fundamental h01 and harmonics h02 ... h50 are represented by the bin of the harmonic frequency.

The interharmonics ih01 ... ih50 are calculated from all spectral components between two consecutive harmonic frequencies.

Examples:

- On a 60 Hz system, the h02 at 120 Hz is represented by the bin no. 24 ( $120 \text{ Hz} / 5 \text{ Hz} = 24$ ).
- The harmonic h03 at 180 Hz is represented by the bin no. 36 ( $180 \text{ Hz} / 5 \text{ Hz} = 36$ ).
- The interharmonic ih02 is represented by the bins no. 25 to 35 (125 Hz to 175 Hz).

Select Harmonic Components for measurements according to standards, such as IEEE 519, that require the harmonics components measurement according to IEC 61000-4-7 or IEC 61000-3-12.

**Sub-Grouped Harmonics.** The fundamental h01 and harmonics h02 ... h50 are the RMS average of the bin of the harmonic frequency and one adjacent bin to each side.

The interharmonics ih01 ... ih50 are composed of the remaining seven bins for 50 Hz systems or nine bins for 60 Hz systems between two adjacent harmonics.

Examples:

- On a 60 Hz system, the h02 at 120 Hz is represented by the bin no. 23, 24, and 25 ( $120 \text{ Hz} / 5 \text{ Hz} = 24$ ).
- The harmonic h03 at 180 Hz is represented by the bin no. 35, 36, and 37 ( $180 \text{ Hz} / 5 \text{ Hz} = 36$ ).
- The interharmonic ih02 is represented by the bins no. 26 – 34 (130 Hz...175 Hz).

**Grouped Harmonics.** The fundamental h01 and harmonics h02...h50 are the RMS average of the bin of the harmonic frequency and half of the bins between two adjacent harmonic frequencies to both sides. The center bin between two harmonic frequencies is included in both harmonics with 50 %. Bins between h01 and h02 are not included.

Interharmonics are not available when the selection is grouped harmonics.

Examples:

- On a 60 Hz system, the harmonic h03 at 180 Hz is represented by the bins 31-35, 36, 37-41, 50 % of bin no. 30 and 50 % of bin no. 42
- The harmonic h04 at 240 Hz is represented by the bin no. 43-47, 48, 49-53, 50 % of bin no. 42 and 50 % of bin no. 54

The advantage of the measurements using grouped harmonics is to cover the entire spectrum without the need to store memory-consuming interharmonics. Make sure to apply this measurement only if the applicable standard requires this measurement method.

**Flicker.** Flicker is a cyclic variation of light intensity of lamps caused by fluctuation of the supply voltage and is typically a symptom of voltage disturbance caused by using large fluctuating loads.

Measurement Modes:

- PQ Meter
- PQ Logger

Configuration:

- Select the lamp-model voltage applied within the Flicker measurement algorithm. Make sure the lamp model selection matches the Nominal Voltage setting unless the measurement includes the use of voltage transducers. In this case make sure to select a lamp-model voltage that matches the Nominal Voltage definition of the associated low voltage grid.
- Use Match Nominal Voltage to automatically select the lamp model voltage and frequency based on the configured nominal voltage and frequency.

Measurement:

- Pinst  
Interim value of the flicker meter useful for troubleshooting
- Pst short-term flicker  
evaluation based on an observation period of 10 min
- Plt long-term flicker  
a rolling sequence of 12 Pst values. After two hours measuring, the first Plt will be calculated. As from two hours Plt is calculated every 10 minutes.  
Pst, Plt  $\leq 1$ , is an acceptable level, no annoyances  
Pst, Plt  $> 1$ , 50 % of humans find this annoying

**Main signaling voltages.** Mains signaling voltage also known as ripple control signal for various control applications, such as tariff changeover, street lighting, storage heaters, and alarming. It is a data telegram applied at a frequency between 110 Hz and 1600 Hz with an amplitude of 1 % ... 4 % of Vnom. Depending on the electrical utility, the telegram is from 6.6 s up to 2 minutes long.

Measurement Modes:

- PQ Logger

Configuration:

- Frequency of up to two mains signaling voltages.

Measurement:

- The Analyzer stores the RMS value of the mains signaling frequency and aggregates to 3 s values. In accordance with IEC61000-4-30 the RMS values is either taken from the 5 Hz frequency bin when the mains frequency is a multiple of the spectral frequency bin or adjacent 4 bins are used. See [Figure 13](#).

**Figure 13. RMS Value**

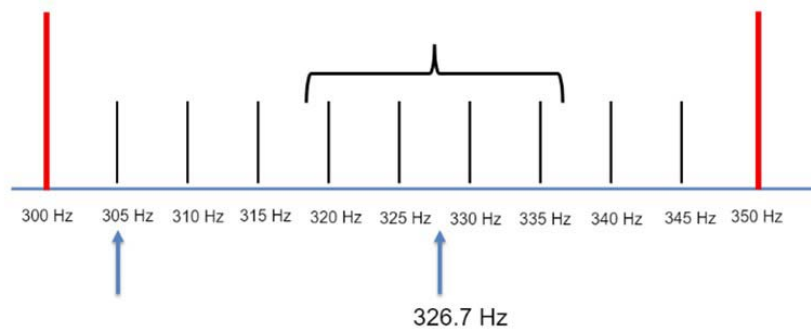

Power Quality Events

**Voltage Dips.** On single-phase systems, a voltage dip begins when the voltage falls below the dip threshold and ends when the voltage is equal to or above the dip threshold plus the hysteresis voltage. See [Table 9](#).

**Table 9. Characteristics of a Voltage Dip**

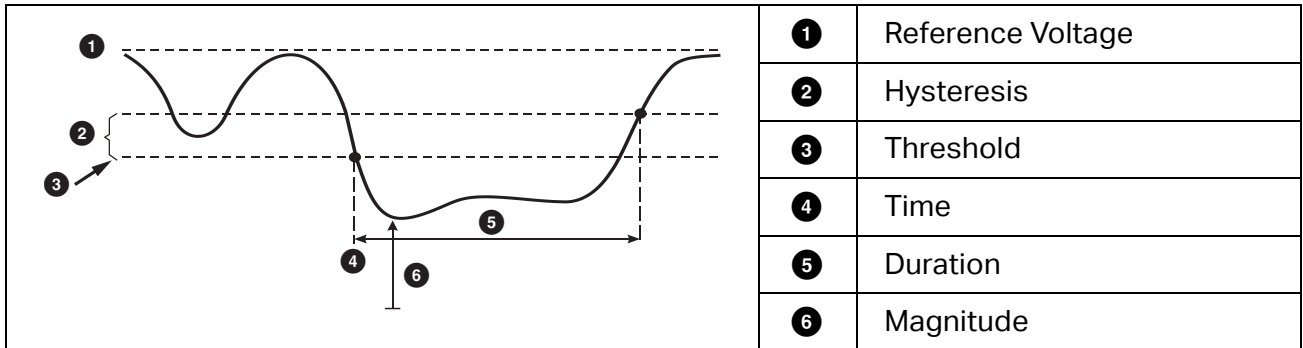

On polyphase systems, a dip begins when the voltage of one or more channels is below the dip threshold and ends when the voltage on all measured channels is equal to or above the dip threshold plus the hysteresis voltage.

Choose nominal or sliding reference voltage. A sliding reference voltage uses measured values filtered with a 1-minute time constant and applies usually only for medium and high voltage systems.

Measurement Modes:

- PQ Meter
- PQ Logger

Configuration:

- The threshold limit value is defined as % of nominal voltage or sliding reference. The default value is 90 % and the hysteresis is 2 %.

**Voltage Swells.** On single-phase systems, a swell begins when the voltage rises above the swell threshold, and ends when the voltage is equal to or below the swell threshold minus the hysteresis voltage. See [Table 10](#).

**Table 10. Characteristics of a Voltage Swell**

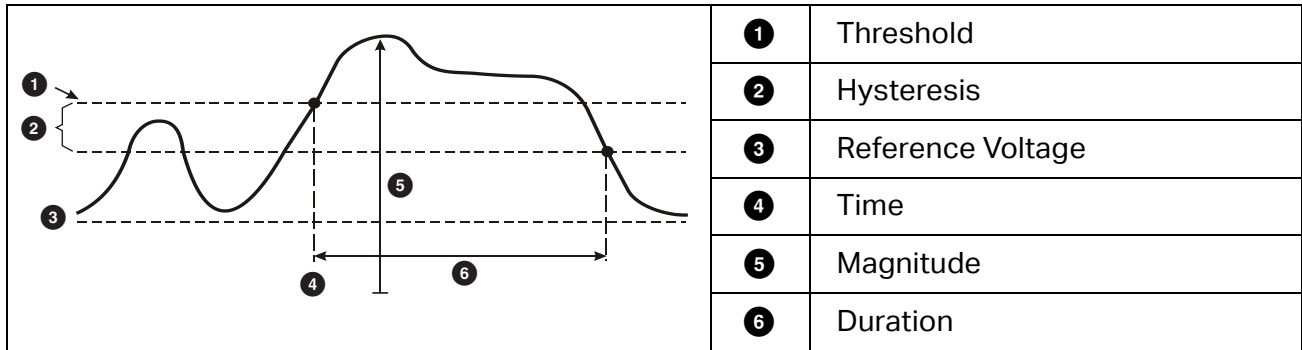

On polyphase systems, a swell begins when the voltage of one or more channels is above the swell threshold and ends when the voltage on all measured channels is equal to or below the swell threshold minus the hysteresis voltage.

Choose nominal or sliding reference voltage. A sliding reference voltage uses measured values filtered with a 1-minute time constant and applies usually only for medium and high voltage systems.

Parameters to configure:

- Limit

The threshold limit value is defined as % of nominal voltage or sliding reference. The default value is 110 % and the hysteresis is 2 %.

**Voltage Interruptions.** On single-phase systems, a voltage interruption begins when the voltage falls below the voltage interruption threshold and ends when the value is equal to or greater than the voltage interruption threshold plus the hysteresis. See [Table 11](#).

**Table 11. Characteristics of a Voltage Interruption**

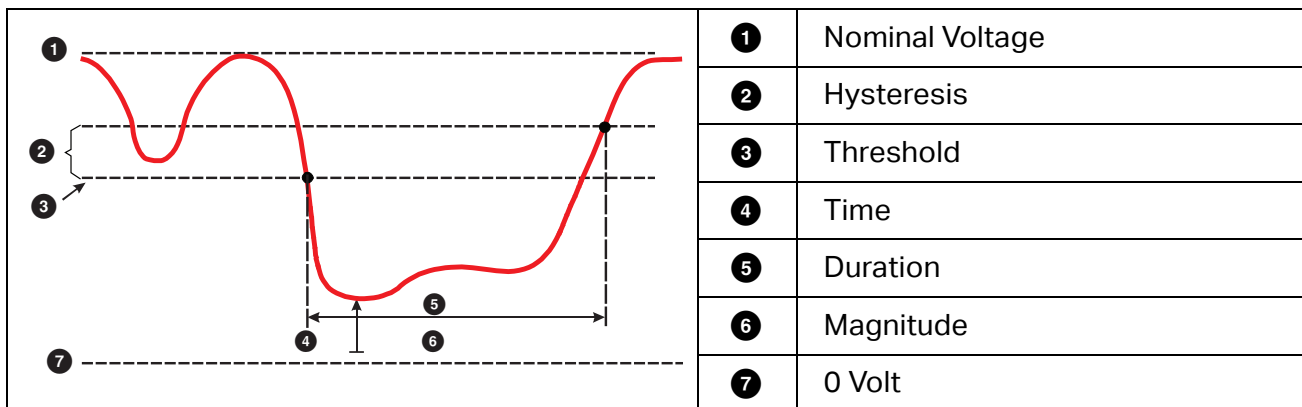



On polyphase systems, a voltage interruption begins when the voltages of all channels fall below the voltage interruption threshold and ends when the voltage on any one channel is equal to, or greater than, the voltage interruption threshold plus the hysteresis.

*Note*

*On polyphase systems, the event is still classified as a dip when the voltage of only one or two phases falls below the interruption limit.*

Parameters to configure:

- Limit

The threshold limit value is defined as % of nominal voltage. The default value is 5 % and the hysteresis is 2 %.

**Rapid Voltage Changes.** Rapid voltage changes (RVC) are quick transitions of the RMS voltage between two steady states. Rapid voltage changes are captured based on RVC threshold. RVC threshold are set as percentage of the nominal voltage and the threshold level is calculated over the preceding 100/120  $U_{RMS}(1/2)$  values. 100/120 is defined as 100 values for 50 Hz nominal or 120 values for 60 Hz nominal.

An RVC Event is detected when the arithmetic mean of 100/120  $U_{RMS}(1/2)$  values falls outside the an RVC threshold. When a voltage change crosses the dip or swell thresholds, it is considered a dip or swell and not a rapid voltage change. The event list shows the voltage step, transition time, and Vmax. See [Table 12](#).

**Table 12. Rapid Voltage Change Characteristics**

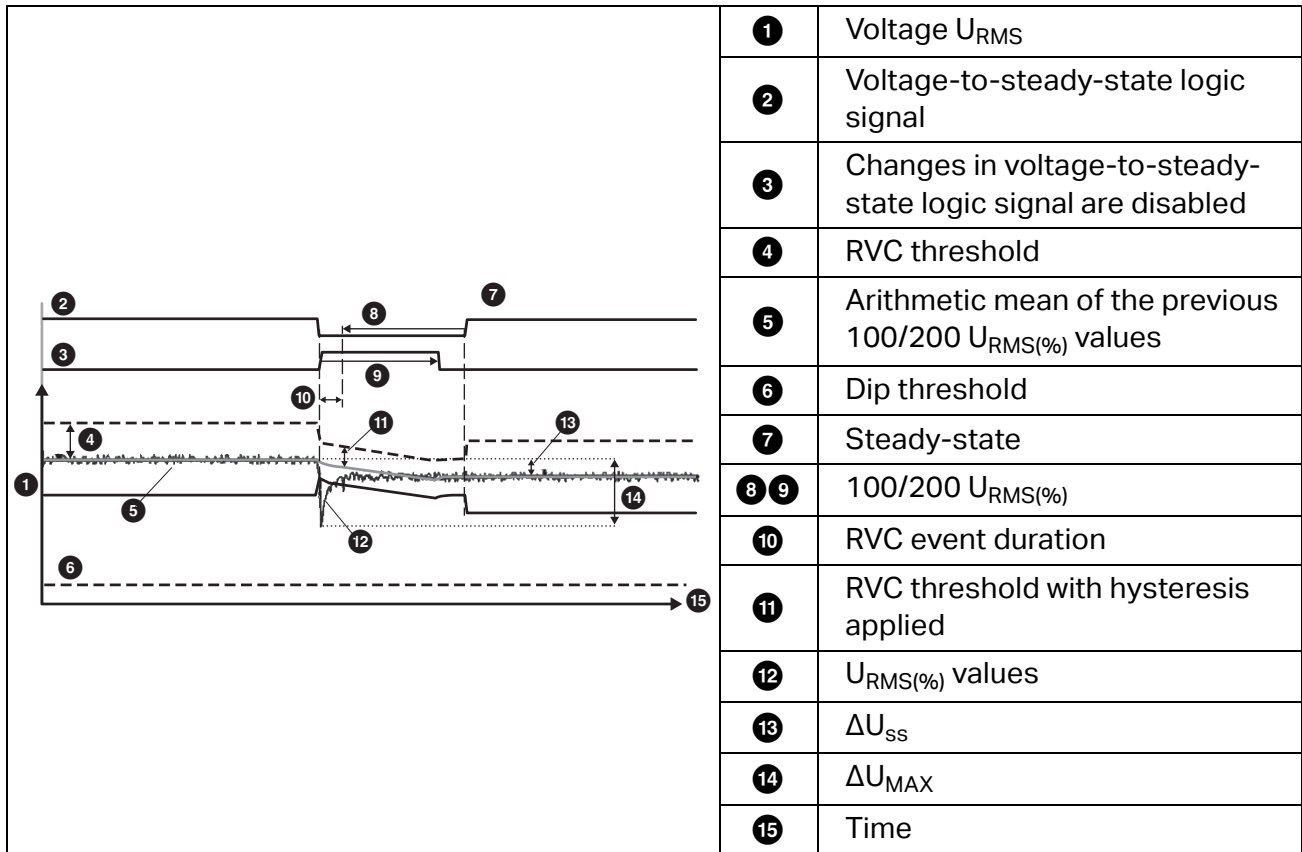

Parameters to configure:

- Trigger on/off
- Limit

The voltage Threshold limit value is defined as % of nominal voltage. The values is typically in the range of 1 % to 6 %. The RVC hysteresis shall be less than the RVC threshold and is typically 50 % of the RVC.

**Waveform Deviation.** The Waveform Deviation trigger monitors the differences in the waveforms of consecutive voltage cycles. Each sample magnitude of the last cycle is compared with the sample magnitude of the actual cycle. The trigger starts when the difference exceeds the configured limit and ends when the difference is lower than the threshold minus the hysteresis. If a waveform deviation triggers starts within one second after the previous waveform deviation trigger ended, it is combined to one event.

This trigger is a general-purpose trigger that detects non-stationary phenomena and is perfectly suitable for all kinds of disturbance analysis and troubleshooting, because most of the power quality problems result in a sudden change of the waveform. From the recorded waveforms, in most cases the root-cause of distortions can be identified: Switching of capacitor banks, commutation distortions, and oscillations on the mains supply. In addition, ground shorts in the medium voltage systems with their typical significant waveforms can be identified. See [Table 13](#).

**Table 13. Waveform Deviation**

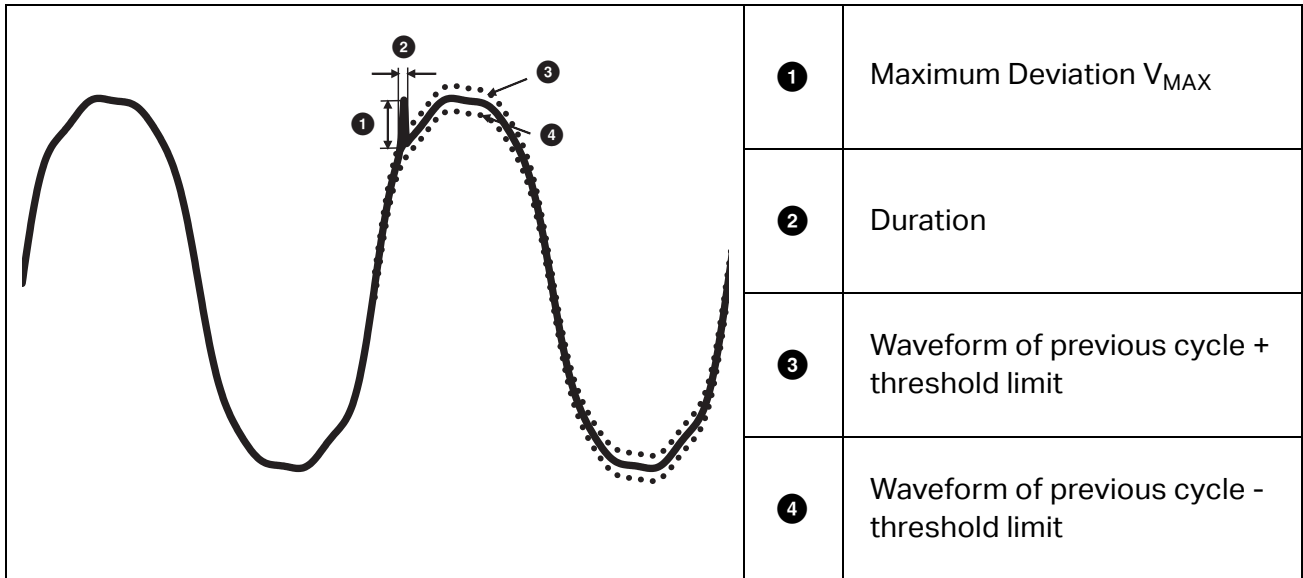

Parameters to configure:

- Trigger on/off
- Limit

The voltage threshold limit is the maximum deviation of the sample magnitude of the actual cycle to the magnitude of the previous cycle in % of nominal voltage.

Recommendation of values depending on the required trigger sensitivity:

Trigger	120V-System	230V-System
High	50 %	25 %
Medium	20 %	10 %
Low	10 %	5 %

**Transients.** Transient overvoltages are either non-oscillatory (impulsive) or oscillatory signals on mains caused by lightning strikes, switching of heavy loads, such as motors, welders, power factor correction banks, or switching of overcurrent protection devices.

Transient overvoltage can cause damage to the insulation of motors, transformers, and electronic equipment. Depending on the overvoltage category, peak values can occur, see [Table 14](#).

**Table 14. Transient Voltages**

Voltage Line-to-Neutral and Line-to-Ground			>100 ≤150V	>150V ≤300V	>300V ≤600V	>600V ≤1000V
<b>CAT II</b>	Single-phase receptacle connected loads	<ul style="list-style-type: none"> <li>Appliance, portable tools, and other household and similar loads</li> <li>Outlet and long branch circuits</li> <li>Outlets at more than 10 meters (30 feet) from CAT III source</li> <li>Outlets at more than 20 meters (60 feet) from CAT IV source</li> </ul>	1500 V	2500 V	4000 V	6000 V
<b>CAT III</b>	Three-phase distribution, including single-phase commercial lighting	<ul style="list-style-type: none"> <li>Equipment in fixed installations, such as switchgear and polyphase motors</li> <li>Bus and feeder in industrial plants</li> <li>Feeders and short branch circuits, distribution panel devices</li> <li>Lighting systems in larger buildings</li> <li>Appliance outlets with short connections to service entrance</li> </ul>	2500 V	4000 V	6000 V	8000 V
<b>CAT IV</b>	Three-phase at utility connection, any outdoor conductors	<ul style="list-style-type: none"> <li>Refers to the "origin of installation," for example, where low-voltage connection is made to utility power</li> <li>Electricity meters, primary overcurrent protection equipment</li> <li>Outside and service entrance, service drop from pole to building, run between meter and panel</li> <li>Overhead line to detached building, underground line to well pump</li> </ul>	4000 V	6000 V	8000 V	12 000 V (not supported)

Measurement modes:

- PQ Meter
- PQ Logger

Parameters to configure:

- Trigger on/off
- Sample rate 1 MS/s or 20 MS/s

On the Fluke 1777, use 1 MS/s if the subsequent waveform after the event up to 0.5 s is of interest.

*Note*

*The use of 1 MS/s impacts the accuracy of the peak measurement.*

- Trigger sensitivity

This sets the voltage level of the spectral component of the input signal above 1.5 kHz. Predefined settings of low-medium-high for the trigger level allow an easy configuration based on the required trigger sensitivity, where low is the most sensitive setting. You can configure a custom setting when the session should, for example, store only events >500V.

**Mains Signaling.** Power distribution systems can carry control signals to remotely switch on and off appliances (also known as ripple control). The control signals are present only at the moments that a remote appliance has to be controlled. The Mains Signaling trigger can capture the occurrence (signal level) of control signals with 2 different frequencies.

Parameters to configure:

- Trigger on/off
- Mains Signaling Voltage (MSV) frequency 1 and MSV frequency 2 in Hz
- Frequency range is 100 Hz up to 3000 Hz
- Limit

The voltage threshold limit value is defined as % of nominal voltage. The value is typically in the range of 1 % to 5 %.

- Recording time

The event triggers a 10/12 cycle recording of up to 120 s.

**Inrush Current.** Inrush currents are surge currents that occur when a large or low-impedance load comes on line. Normally the current will stabilize after some time when the load has reached normal working condition. For example, the start-up current in induction motors can be 10x the normal working current. See Table 15. The inrush current begins when the 1/2-cycle RMS current rises above the inrush threshold, and ends when the 1/2-cycle RMS current is equal to or below the inrush threshold minus the hysteresis value. In the event table, the extreme value is the highest 1/2-cycle RMS value of the event.

**Table 15. Inrush Characteristics**

	<p>1</p>	<p>Threshold (=Trigger)</p>
	<p>2</p>	<p>Hysteresis</p>
	<p>3</p>	<p>Duration</p>

Parameters to configure:

- Trigger on/off
- Limit

The current threshold limit is the 1/2 cycle RMS value in A. A signal exceeding this limit triggers the event.