

FLIR MODEL DM91

True RMS Industrial Multimeter with Bluetooth®

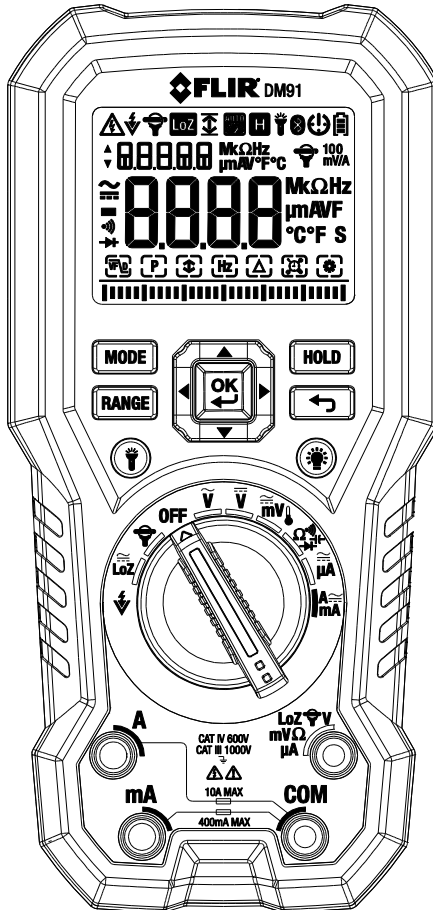

Table of Contents

1. ADVISORIES	4
1.1 Copyright	4
1.2 Quality Assurance	4
1.3 Documentation	4
1.4 Disposal of Electronic Waste	4
2. SAFETY	5
3. INTRODUCTION	7
3.1 Key Features	7
4. METER DESCRIPTION	8
4.1 Front and Back Descriptions	8
4.2 Function Switch Positions	9
4.3 Function Buttons and Selector/Navigation Pad	10
4.3.1 MODE Button Operation	10
4.3.2 Selector/Navigation Pad Operation	11
4.4 Display Description	11
4.5 Display Icons and Indicators	12
4.5.1 Probe Detection Alert	13
4.5.2 Out-of-range warning	13
4.6 Mode Menu Bar Basics	14
5. OPERATION	15
5.1 Powering the Meter	15
5.1.1 Auto Power Off (APO)	15
5.2 Auto/Manual Range Mode	15
5.3 Voltage and Frequency Measurements	16
5.4 Resistance Measurements	17
5.5 Continuity Test	17
5.6 Classic Diode Test	18
5.7 Smart Diode Test	19
5.8 Capacitance Measurements	20
5.9 Type K Temperature Measurements	21
5.10 Current and Frequency Measurements	22

5.10.1 Test Lead Current Measurements (A, mA, and μ A)	22
5.10.2 FLEX Clamp Adaptor Current Measurements	25
5.11 Non-Contact Voltage Detector	26
6. MENU BAR FOR EXTENDED FUNCTIONALITY	27
6.1 Selecting Modes using the Menu Bar	27
6.2 VFD Mode (ACV and ACA only)	27
6.3 Peak Mode (ACV and ACA only)	27
6.4 Min/Max/Avg Mode	27
6.5 Frequency mode (ACV and ACA only)	28
6.6 Relative mode	28
6.7 Datalogger	28
6.8 Settings Menu	29
6.9 Data Hold and Auto Hold	30
6.9.1 Data Hold Mode	30
6.9.2 Auto Hold Mode	30
7. BLUETOOTH® COMMUNICATION AND FLIR TOOLS™	31
8. MAINTENANCE	32
8.1 Cleaning and Storage	32
8.2 Battery Replacement	32
8.3 Fuse Replacement	32
8.4 Disposal of Electronic Waste	32
9. SPECIFICATIONS	33
9.1 General specifications	33
9.2 Electrical Range Specifications	34
10. TECHNICAL SUPPORT	39
11. WARRANTY	40

1. Advisories

1.1 Copyright

© 2019, FLIR Systems, Inc. All rights reserved worldwide. No parts of the software including source code may be reproduced, transmitted, transcribed or translated into any language or computer language in any form or by any means, electronic, magnetic, optical, manual or otherwise, without the prior written permission of FLIR Systems. The documentation must not, in whole or part, be copied, photocopied, reproduced, translated or transmitted to any electronic medium or machine readable form without prior consent, in writing, from FLIR Systems.

Names and marks appearing on the products herein are either registered trademarks or trademarks of FLIR Systems and/or its subsidiaries. All other trademarks, trade names or company names referenced herein are used for identification only and are the property of their respective owners.

1.2 Quality Assurance

The Quality Management System under which these products are developed and manufactured has been certified in accordance with the ISO 9001 standard.

FLIR Systems is committed to a policy of continuous development; therefore, we reserve the right to make changes and improvements on any of the products without prior notice.

1.3 Documentation

To access the latest manuals and notifications, go to the Download tab at:

<http://support.flir.com>. It only takes a few minutes to register online. In the download area you will also find the latest releases of manuals for our other products, as well as manuals for our historical and obsolete products.

1.4 Disposal of Electronic Waste



As with most electronic products, this equipment must be disposed of in an environmentally friendly way, and in accordance with existing regulations for electronic waste.

Please contact your FLIR Systems representative for more details.

2. Safety

Safety Notes

- Before operating the device, you must read, understand, and follow all instructions, dangers, warnings, cautions, and notes.
- FLIR Systems reserves the right to discontinue models, parts or accessories, and other items, or to change specifications at any time without prior notice.
- Remove the batteries if the device is to be idle for an extended period.





Warning Statements

- Do not operate the device if you do not have the correct knowledge. Incorrect operation of the device can cause damage, shock, injury or death to persons.
- Do not start a measuring procedure before you have set the function switch to the correct position. Failure to do so can cause damage to the instrument and can cause injury to persons.
- Do not change to the resistance mode when measuring voltage. This can cause damage to the instrument and can cause injury to persons.
- Do not measure the current on a circuit when the voltage increases to more than 1000 V. This can cause damage to the instrument and can cause injury to persons.
- You must disconnect the test leads from the circuit under test before you change the range. Failure to observe this warning can damage the instrument and cause bodily injury.
- Do not replace the batteries before you remove the test leads. This can cause damage to the instrument and can cause injury to persons.
- Do not use the device if the test leads and/or the device show signs of damage. Injury to persons can occur.
- Be careful performing measurements if the voltages are > 25 VAC rms or 35 VDC. There is a risk of shock from these voltages. Injury to persons can occur.
- Do not do diode, resistance or continuity tests before you have removed the power from capacitors and other devices under test. Injury to persons can occur.
- Be careful when performing voltage checks on electrical outlets. These checks are difficult because of the uncertainty of the connection to the recessed electrical contacts. You must not rely solely on this device when determining if the terminals are not “live”. There is a risk of electrical shock. Injury to person can occur.
- Do not touch expired/damaged batteries without gloves. Injury to persons can occur.
- Do not cause a short circuit of the batteries. This can cause damage to the instrument and can cause injury to persons.
- Do not put the batteries into a fire. Injury to persons can occur.

Cautions

Do not use the device in a manner not specified by the manufacturer. This can cause damage to the protection provided.

	This symbol, adjacent to another symbol or terminal, indicates that the user must refer to the user manual for further information.
	This symbol, adjacent to a terminal, indicates that, under normal use, hazardous voltages may be present.
	Double insulation.



UL listing is not an indication or a verification of the accuracy of the meter

3. Introduction

Thank you for selecting the FLIR DM91 True RMS Digital MultiMeter with Bluetooth®, Type-K thermocouple, automatic datalogging, and work light features. The DM91 can measure voltage up to 1000V AC/DC and includes Low-Z (low impedance), VFD (low pass filter), Non-Contact Voltage Detector, and Smart/Classic Diode modes. This device is shipped fully tested and calibrated and, with proper use, will provide years of reliable service.

3.1 Key Features

- 6000 count 2.8" digital LCD display with bargraph
- Measures Voltage, Current (A, mA, μ A), Frequency, Resistance/Continuity, Diode, Capacitance, Non-Contact Voltage, and Temperature
- Bluetooth® communication allows readings to be viewed on remote devices
- Customizable via easy-to-use Settings menu with on-screen menu navigation
- Automatic and Manual ranging
- Input over-voltage warning
- Automatic datalogging for up to 40,000 readings
- MIN-MAX-AVG memory
- PEAK MIN and PEAK MAX
- Flex Clamp direct input
- CLASSIC and SMART Diode modes
- Variable-frequency drive VFD mode (low-pass filter)
- Low-Z (low impedance) mode
- Relative mode
- Data Hold and Auto Hold
- Auto Power OFF
- Real-time calendar clock
- Safety Category Rating: CAT IV-600V, CAT III-1000V
- Equipped with batteries, test leads, alligator clips, test lead storage attachment, Type-K thermocouple, and Quick Start Guide.

4. Meter Description

4.1 Front and Back Descriptions

Fig. 4-1 Front View

1. Work Light and NCV Detector
2. LCD Display
3. Navigation/OK buttons
4. MODE Button
5. RANGE Button
6. Work light Button
7. Rotary Function Switch
8. Positive (+) Probe Input Jack for **A** (Current).
9. Positive (+) Probe Input Jack for **mA** (Current).
10. COM (-) Probe Input Jack
11. Positive (+) Probe Input Jack for all inputs except **A** and **mA**
12. Display Backlight Button
13. Cancel/Return Button
14. Display HOLD Button

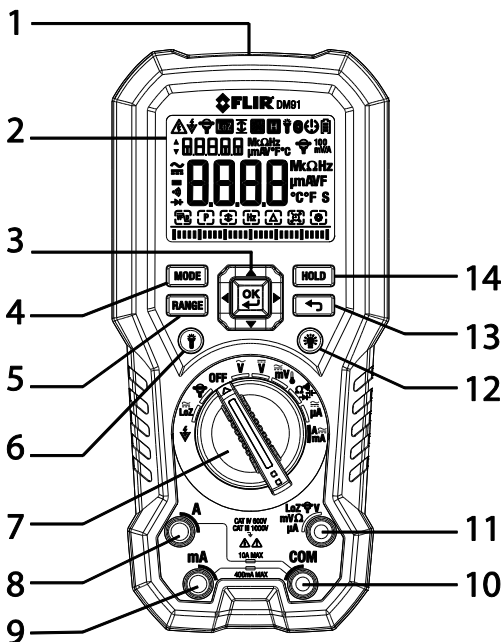

1. Test Lead holder attachment mounts
2. Tripod mount (test lead holder attaches here also)
3. Tilt Stand (Battery Compartment located beneath the stand)

Fig. 4-2 Rear View

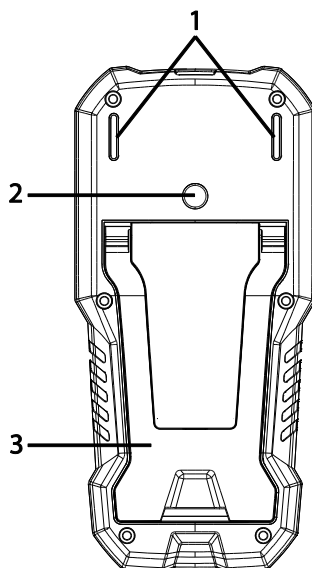

4.2 Function Switch Positions



















	Detect AC voltage through the non-contact sensor at the top of the meter.
	Measure voltage through the probe inputs with a low-impedance load positioned across the inputs that stabilizes the measurement.
	FLEX Direct: Auxiliary channel for use with optional Flexible Current clamp or standard clamp adaptors when > 600A measurements are required. In this mode, the meter will display true rms ACA measurements from the connected device. Frequency (Hz) appears when the MODE button is pressed.
OFF	Meter is OFF and in full power-saving mode.
	Measure AC voltage (V) through the probe inputs.
	Measure DC voltage (V) through the probe inputs.
	Measure low voltage (mV) through the probe inputs. Use the MODE button to select AC/DC voltage.
	Measure temperature through the probe inputs using a thermocouple adaptor. Use the MODE button to select Temperature (see Section 6.8, Settings Menu , to select °C or °F as the default unit).
	Measure resistance, continuity, capacitance, or diode through the probe inputs. Use the MODE button to select the desired function.
	Measure µA current through the probe inputs. Use the MODE button to select AC or DC.
	Measure current through the probe inputs (A or mA). Use the MODE button to select AC or DC.

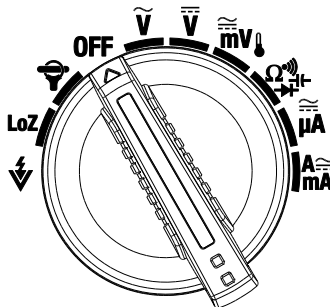



Fig. 4-3 Function Switch



4.3 Function Buttons and Selector/Navigation Pad

	Use to select a sub-function of the primary function. See Section 4.3.1, MODE Button Operation , for details.
	From Auto range mode, press to select Manual range mode. From Manual range mode, press < 1 second to change the range (scale). Press > 1 second to activate Auto range mode
	Press to toggle between Hold mode and normal display mode. Use the Settings menu (see Section 6.8, Settings Menu) to select Data hold or Auto hold.
	Use the selector/navigation pad to enable extended functionality modes and to navigate mode menu options.
	Press to cancel/exit a screen in the Settings menu (no function in the normal mode).
	Press to enable/disable the display backlight. The backlight's default state is ON.
	Press to switch the work light ON or OFF.

4.3.1 MODE Button Operation

Switch Position	MODE button sequence of operation
	AC → DC → °F or °C
	Resistance → Continuity → Capacitance → Diode
	AC → DC
	AC → DC

4.3.2 Selector/Navigation Pad Operation

There are five (5) 'soft' Function buttons arranged in a square, as shown in Figure 4-4. The function of these buttons changes, depending on the menu-driven sub-function selected.



Fig. 4-4 Selector Navigation Pad

Pressing the OK button (center) selects a menu-driven option. The OK button also accesses further into the sub-menus of selection screens.

The LEFT/RIGHT buttons:

In normal mode, the left/right buttons move the menu cursor
 In Settings mode, the left/right buttons change the value of an option

The UP/DOWN buttons:







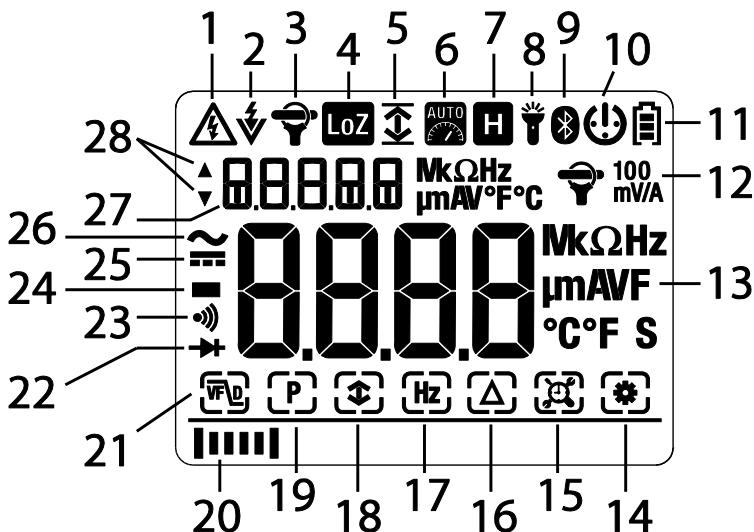







In normal mode, the up/down buttons have no function
 In Settings mode, the up/down buttons change an option.















4.4 Display Description

Fig. 4-5 Display Icons (see Section 4-5 for descriptions)



4.5 Display Icons and Indicators

1		Measured voltage is > 30 V (AC or DC)
2		Non-Contact Voltage detector
3		FLEX Clamp adaptor input
4		Low Impedance mode
5		MAX (Maximum), MIN (minimum), and AVG (Average) readings
		PEAK MAX and PEAK MIN readings
6		Auto range mode
7		Data Hold mode
8		Work light active
9		Bluetooth® active icon (see Section 7, Bluetooth® Communication)
10		Auto power off function enabled
11		Battery voltage status
12		Flex Clamp Direct Input
13		Primary display (large digits) with units of measure
14		MENU BAR ICON: Settings mode

15		MENU BAR ICON: Automatic Datalogging mode
16		MENU BAR ICON: Relative mode
17		MENU BAR ICON: Frequency mode
18		MENU BAR ICON: MAX-MIN-AVG mode
19		MENU BAR ICON: Peak MAX / Peak MIN mode
20		Bar Graph Measurement Indicator
21		MENU BAR ICON: VFD mode (see Section 4.6, Menu Icon Bar)
22		Diode test function
23		Continuity function
24		Minus sign (positive assumed)
25		DC Voltage or Current
26		AC Voltage or Current
27		Secondary display (smaller digits) with units of measure
28		Menu display prompt informing user to use the up/down buttons

4.5.1 Probe Detection Alert

For current measurements (A and mA), when the test leads are not plugged into the correct jacks for the measurement selected by the function switch, the probe display alert '**Prob**' is shown.

4.5.2 Out-of-range warning

If the input is over/under the full-scale range in Manual range mode, or if the signal has exceeded the maximum/minimum input in Auto range mode, '**OL**' is displayed.

4.6 Mode Menu Bar Basics

There are seven (7) Menu Bar functions represented by the following icons. Refer to [Section 6, Mode Menu Bar for Extended Functionality](#) for further explanation on these functions.



VFD (low pass filtering)



Peak Max and Peak Min (Auto Hold)



MAX-MIN-AVG memories



Frequency measurements



Relative mode



Automatic Datalogging mode



Settings mode

1. Only one icon flashes at a time to indicate the cursor position.
2. Use the Left / Right buttons to move the cursor.
3. Press the **OK** button to activate / deactivate the selected function. The LCD will show a frame around activated functions (even when the cursor is steered away from the icon).
4. In the AC Voltage/AC mV/AC Current/Flex/Lo Z modes all icons shown above are available (the exception is that the Hz function is not available in the μA mode).
5. For DC Current/Voltage, Resistance, Continuity, Capacitance, Temperature, and Diode only the MAX-MIN-AVG, Relative, Datalogger, and Settings icons are available.

5. Operation

Caution: Before operating the device, you must read, understand, and follow all instructions, dangers, warnings, cautions, and notes.

Caution: When the meter is not in use, the function switch should be set to the OFF position.

Caution: When connecting the probe leads to the device under test, connect the COM (negative) lead before connecting the positive lead. When removing the probe leads, remove the positive lead before removing the COM (negative) lead.

5.1 Powering the Meter

1. Set the function switch to any position to switch on the meter.
2. If the battery indicator  shows that the battery voltage is low or if the meter does not power on, replace the batteries. See [Section 8.2, Battery Replacement](#).





5.1.1 Auto Power Off (APO)

The meter enters sleep mode after a programmable period of inactivity, see [Section 6.8, Settings Menu](#). The default time-out is 20 minutes. The time can be set from 1 ~ 30 minutes (select OFF to disable the APO). 20 seconds prior to entering APO mode, the meter beeps three times; at this point, press any button or turn the Rotary Switch to reset the APO timer.

5.2 Auto/Manual Range Mode

In Auto range mode, the meter automatically selects the most appropriate measurement scale. In Manual range mode, the user selects the desired range (scale).

Auto range mode is the default mode of operation. When you select a new function with the function switch, the starting mode is Auto range and the  indicator appears.

1. To enter Manual range mode, short press the  button. To change the range, press the  button repeatedly until the desired range appears.
2. To return to the Auto range mode, long press the  button until the Auto Range  indicator again appears.

5.3 Voltage and Frequency Measurements

1. Refer to the Fig. 5-1 below.
2. Set the function switch to one of the following positions:
 - $\overline{\text{V}}$ (VDC) or $\widetilde{\text{V}}$ (VAC) for high voltage measurements.
 - $\overline{\text{mV}}$ (milli-volts) for low voltage measurements (use MODE to select AC or DC).
 - **LoZ** for voltage measurements using the meter's low input impedance mode. The **LoZ** indicator will be displayed (use **MODE** to select AC or DC).
3. Insert the black probe lead into the negative COM terminal and the red probe lead into the positive terminal.
4. For **mV** and **LoZ** measurements use the **MODE** button to select AC or DC measurement:
 - The \sim indicator shows for AC measurements.
 - The —|—|—| indicator shows for DC measurements.
5. Connect the probe leads in parallel to the part under test.
6. Read the voltage value on the display.
7. For AC Voltage Measurements, the Frequency (Hz) of the measured voltage appears on the smaller, secondary display digits above the primary voltage reading. To display only the Frequency, navigate to the **Hz** menu icon using the arrow buttons and enable (or disable) the mode by pressing **OK**.

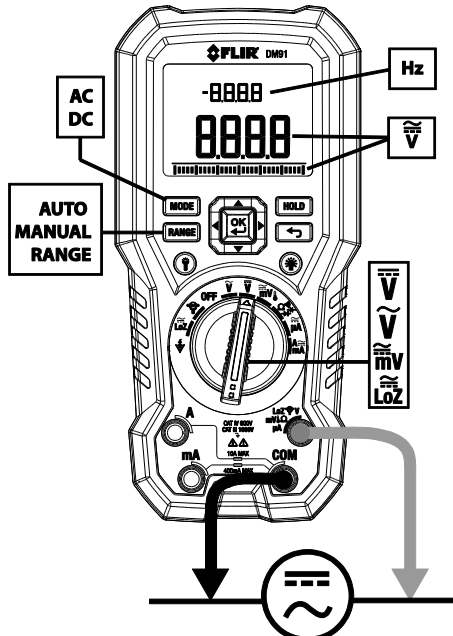

Fig. 5-1 Voltage and Frequency Measurements

5.4 Resistance Measurements

Warning: Do not perform diode, resistance or continuity tests before removing power from capacitors and other devices under test during a measurement. Injury to persons can occur.

1. Refer to Fig. 5-2. Set the function switch to the Ω position.
2. Use **MODE** to step to the Ω display if necessary.
3. Insert the black probe lead into the negative COM terminal and the red probe lead into the positive Ω terminal.
4. Touch the tips of the probe across the circuit or component under test.
5. Read the resistance value on the display.

5.5 Continuity Test

Warning: Do not perform diode, resistance or continuity tests before removing the power from capacitors and other devices under test during a measurement. Injury to persons can occur.

1. Refer to Fig. 5-2. Set the function switch to the Ω position.
2. Use the **MODE** button to select continuity. The Ω indicator will appear.
3. Insert the black probe lead into the negative COM terminal and the red probe lead into the positive terminal.
4. Touch the tips of the probe across the circuit or component under test.
5. If the resistance is $< 20\Omega$ the meter beeps. If the resistance is $> 200\Omega$ the meter will not beep. If the resistance is $> 20\Omega$ but $< 200\Omega$ the beeping will stop at an unspecified point.

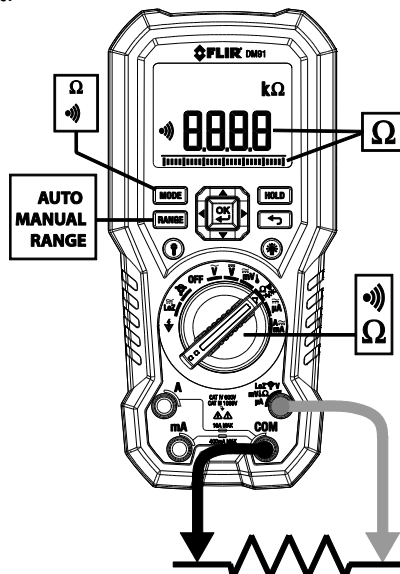



Fig. 5-2 Resistance and Continuity Measurements

5.6 Classic Diode Test

Warning: Do not perform diode tests before removing the power to the diode or other devices under test during a measurement. Injury to persons can occur.

1. If not already selected, choose CLASSIC Diode test mode in the Settings menu (see [Section 6.8, Settings Menu](#)).
2. Set the function switch to the diode  position. Use the **MODE** button to select the diode test function. The diode indicator  appears.
3. Insert the black probe lead into the negative COM terminal and the red probe lead into the positive terminal.
4. Touch the tips of the probe across the diode or semiconductor junction under test in one polarity (direction) and then in the opposite polarity as shown in Fig. 5-3.
5. If the reading is between 0.400 and 0.800V in one direction and OL (overload) in the opposite direction, the component is good. If the measurement is 0V in both directions (shorted) or OL in both directions (open), the component is bad.

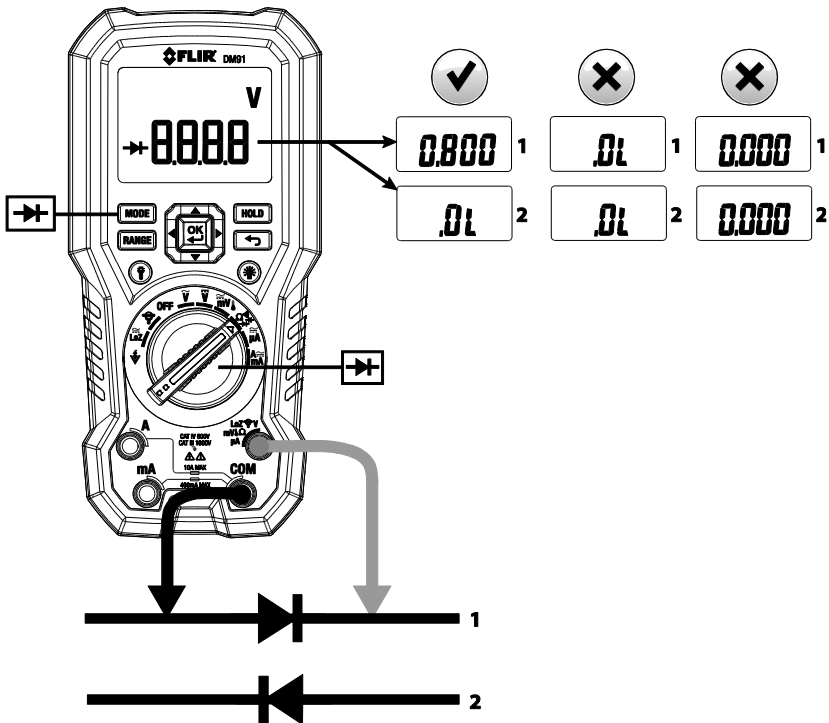



Fig. 5-3 Classic Diode Measurements

5.7 Smart Diode Test

Warning: Do not perform diode tests before removing the power from capacitors and other devices under test during a measurement. Injury to persons can occur.

1. If not already selected, choose SMART Diode test mode in the Settings menu (see [Section 6.8, Settings Menu](#)).
2. Set the function switch to the diode  position. Use the **MODE** button to select the diode test function. The diode indicator  appears.
3. Insert the black probe lead into the negative COM terminal and the red probe lead into the positive terminal.
4. Touch the tips of the probe across the diode or semiconductor junction under test.
5. If the reading is between $\pm 0.400 \sim 0.800V$, the component is good; BAD or O.L displays indicate a defective component.

NOTES: In SMART Diode mode the meter checks diodes using an alternating test signal sent through the diode in both directions. This allows the user to check the diode without having to reverse polarity manually. The meter display will show $\pm 0.400 \sim 0.800V$ for a good diode, 'bAd' for a shorted diode, and 'O.L' for an opened diode. See Fig. 5.4 below:

Fig. 5-4 SMART Diode Test

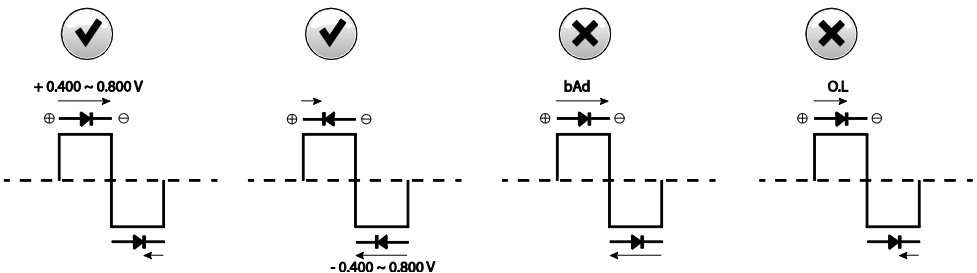

5.8 Capacitance Measurements

Warning: Do not perform capacitance tests before removing the power to the capacitor or other devices under test during a measurement. Injury to persons can occur.

1. Set the function switch to the  position.
2. Use the **MODE** button to select the capacitance measurement. The F (Farad) unit of measure appears.
3. Insert the black probe lead into the negative **COM** terminal and the red probe lead into the positive terminal.
4. Touch the tips of the probe across the part under test.
5. Read the capacitance value on the display.

Note: For very large capacitance values, it may take several minutes for the measurement to settle and the final reading to stabilize.

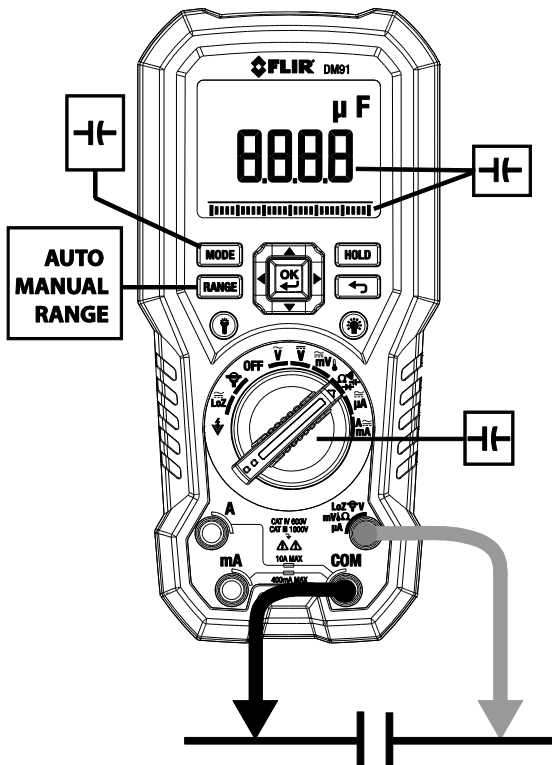

Fig. 5-5 Capacitance Measurements

5.9 Type K Temperature Measurements

1. Set the function to the Temperature t position.
2. Use the **MODE** button to select temperature measurement. The $^{\circ}\text{F}$ or $^{\circ}\text{C}$ unit will be displayed. To change from F to C or from C to F, please use the Settings menu (see [Section 6.8, Settings Menu](#)).
3. While observing the polarity, insert the thermocouple adapter into the negative terminal and the positive terminal.
4. Touch the tip of the thermocouple to the part under test. Keep the thermocouple tip on the part until the reading stabilizes.
5. Read the temperature value on the display.
6. To avoid electrical shock, disconnect the thermocouple adapter before turning the function switch to another position.

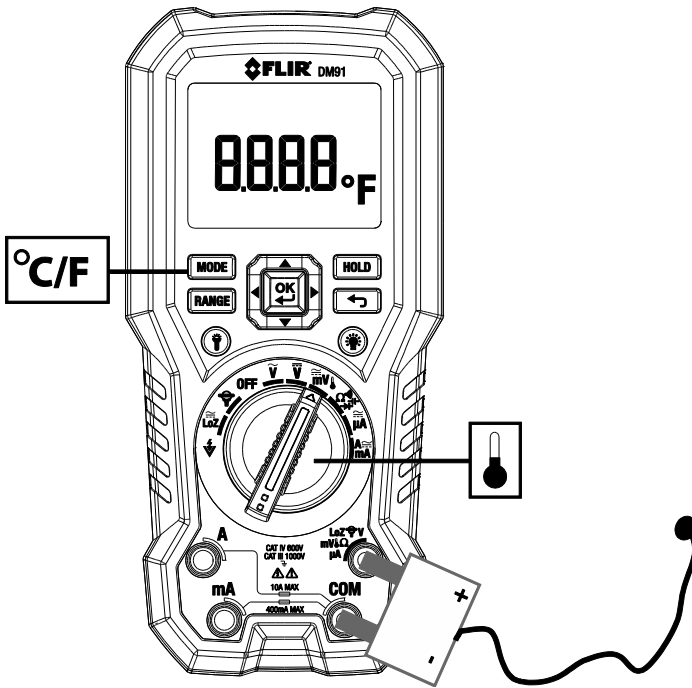

Fig. 5-6 Temperature Measurements

5.10 Current and Frequency Measurements

For test lead current measurements, disconnect the part under test and connect the test leads in series with the part, see Figure 5.7.

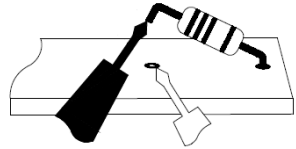





Fig. 5-7 Disconnected component

5.10.1 Test Lead Current Measurements (A, mA, and μ A)

1. For test lead measurements (A, mA, and μ A), set the function switch to the **A**  or **μ A** position.
2. Insert the black probe lead into the negative COM terminal and the red probe lead into one of the following positive terminals:
 - **A** for high current measurements.
 - **mA** for lower current measurements.
 - **μ A** for micro-amp measurements.
3. Use the **MODE** button to select AC or DC measurement.
 - The  indicator shows for AC measurements.
 - The  indicator shows for DC measurements.
4. Connect the probe leads in series with the part in accordance with Figure 5.7 and Fig. 5-8 for 'A' measurements, Fig. 5-9 for mA measurements, or Fig. 5-10 for μ A measurements.
5. Read the current and frequency values on the display (note that the frequency function is not available for the μ A function). To display only the Frequency, navigate to the **Hz** icon and enable (or disable) the mode by pressing **OK**.

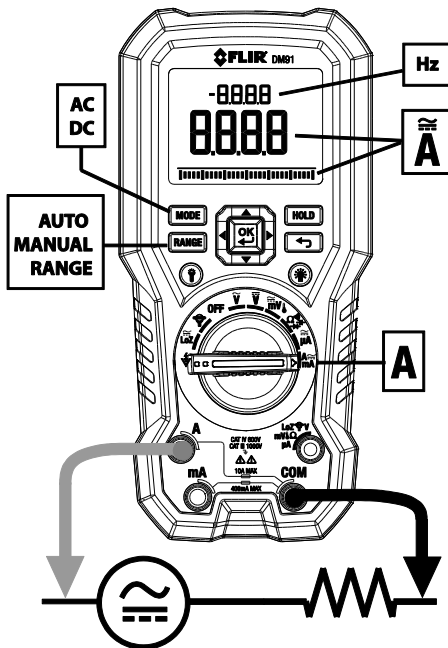

Fig. 5-8 High Current 'A' and Frequency Measurements

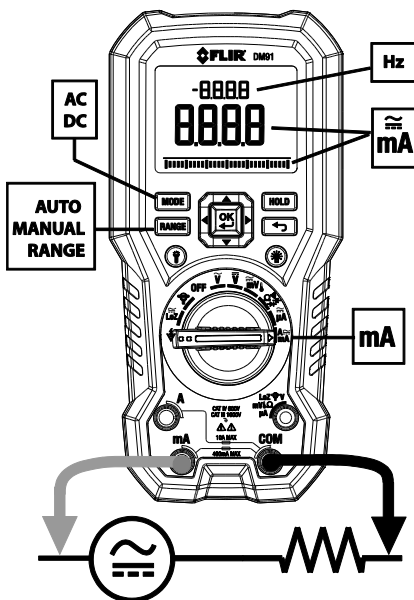

Fig. 5-9 mA Current and Frequency Measurements

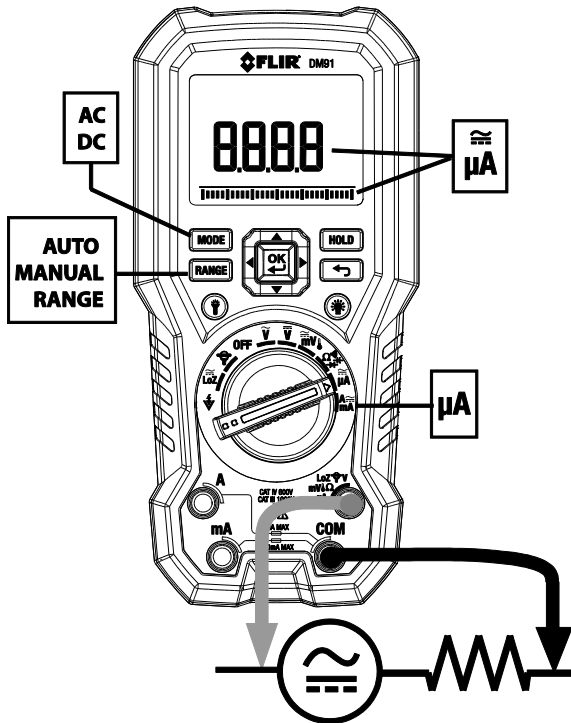



Fig. 5-10 μA Current Measurements

5.10.2 FLEX Clamp Adaptor Current Measurements

Connect FLIR Flex Clamp Adaptors (FLIR TA72 and TA74, for example) or other clamp adaptors to the DM91 to display current measurements made by the clamp adaptor.

1. Turn the function dial to the  position.
2. Connect a Clamp adaptor as shown in Fig. 5-11.
3. Set the Range of the Flex Clamp Adaptor to match the range of the DM91.
4. Use the **RANGE** button to select the range of the DM91 (1, 10, 100 mV/A). The selected range appears on the right side of the DM91 display.
5. Operate the Flex Clamp per instructions provided with the Flex Clamp meter.
6. Read the current measured by the Flex Clamp on the DM91 LCD. The frequency appears on the DM91's secondary display.

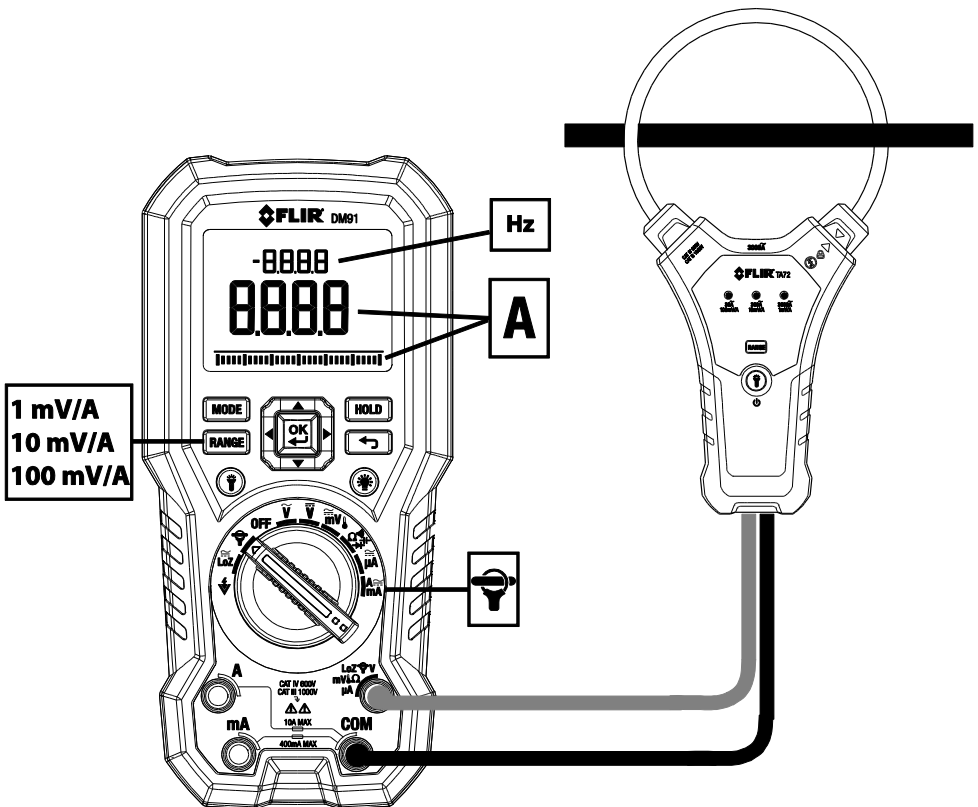



Fig. 5-11 FLEX Clamp Application

5.11 Non-Contact Voltage Detector

1. Set the function switch to the NCV  position.
2. Be sure to remove the test leads from the meter when doing NCV tests.
3. Use the **RANGE** button to choose High (Hi) 80~1000V or Low (Lo) 160~1000V Sensitivity mode.
4. Position the top of the meter close to a source of voltage or electromagnetic field.
5. When the meter detects a voltage or electromagnetic field, it will emit a continuous tone.

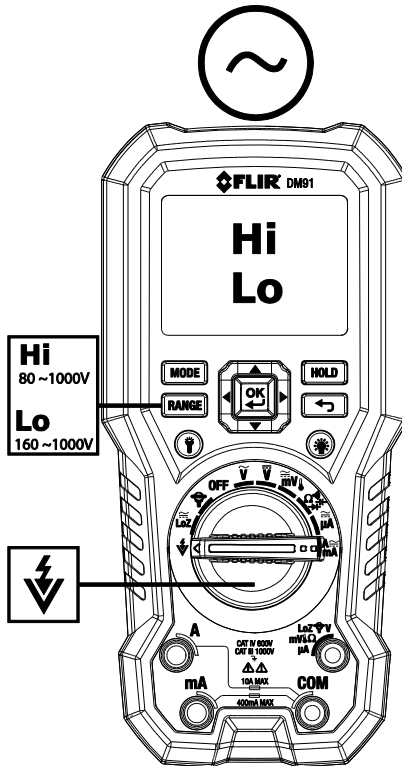

Fig. 5-12 Non-Contact Voltage Detector

6. Menu Bar for Extended Functionality

In addition to the basic measurement functions, the DM91 offers extended functionality as detailed below.

6.1 Selecting Modes using the Menu Bar

The menu icons appear in the lower part of the display. When you enable a mode, a frame appears around the icon.



Fig. 6-1 Menu Bar icons

1. Use the left/right navigation buttons to step to the desired mode icon. The currently selected icon will flash.
2. Press the **OK** button to enable the selected mode (the icon will frame).
3. Use the up/down navigation buttons to step through the options for the selected mode.
4. Press the **OK** button to disable the selected icon.



6.2 VFD Mode (ACV and ACA only)

In VFD (variable-frequency drive) mode, the meter removes high-frequency noise from the voltage measurement with a low-pass filter. VFD mode is available when measuring AC voltage or AC current.

Navigate to  with the left/right arrows and enable/disable VFD mode by pressing the **OK** button. The VFD mode is active when a frame appears around the icon.

6.3 Peak Mode (ACV and ACA only)



In Peak mode, the meter captures and displays the positive and negative peak values, and updates only when a higher/lower value is registered.

1. Navigate to the **P** icon and enable Peak mode by pressing **OK**.
2. Use the up/down navigation buttons to toggle Peak Max and Peak Min.
3. In Peak Max mode, the  indicator appears.
4. In Peak Min mode, the  indicator appears.
5. Press the **HOLD** button to pause the Peak mode. Press again to continue.

6.4 Min/Max/Avg Mode

In Min/Max/Avg mode, the meter captures and displays the minimum, maximum, and average readings, updating only when a higher/lower value is registered. The meter also averages the total sum of all recorded values.

1. Navigate to MIN-MAX AVG icon  using the left/right arrow buttons and enable the mode by pressing **OK**.

2. Use the up/down buttons to cycle through the minimum, maximum, and average reading displays. The corresponding icons are displayed: , , or .
3. Press **HOLD** to pause. Press again to continue.

6.5 Frequency mode (ACV and ACA only)

In Frequency mode, frequency appears in the main display. Frequency mode is available when measuring AC voltage or current. Navigate to **Hz** using the arrow buttons and enable (or disable) the mode by pressing **OK**.

6.6 Relative mode

In Relative mode, the difference between the real-time reading and a stored reference value appears in the main display. The reference value appears in the secondary display (smaller digits).

Navigate to  using the arrow buttons and store the reference by pressing **OK**.

6.7 Datalogger

In datalogging mode, the meter automatically records measurements at the user-programmed sampling rate. Up to 40,000 records can be stored in the meter's internal memory. The sampling rate setting range is 1 to 600 seconds.

Navigate to the datalogger icon  using the arrow buttons and enable the mode by pressing **OK**. Use the up/down arrows to scroll through the options detailed below:

RATE: Use the left and right arrow buttons to adjust the sampling rate (from 1 to 600 seconds).

START: Press **OK** at this option to begin logging data at the programmed sampling rate. You can now use the **OK** button as a pause/resume button. To stop datalogging, short press the RETURN button. To stop datalogging and return to the normal operating mode, long press the RETURN button.

VIEW: In the view mode, the secondary display (smaller digits) shows the current memory location. The main display shows the data stored in the current memory location. Use the up and down arrow buttons to scroll through the memory locations. Use the left and right arrow buttons to jump to the beginning (right) or end (left) of the data log. Press the RETURN button to exit the VIEW mode.

SEND: Pair the DM91 to a remote device running FLIR Tools via Bluetooth® (BLE). Set FLIR Tools to Measurements mode. On the DM91, at SEND, press the **OK** button. FLIR Tools will request a filename: enter a filename and tap SAVE. The data will start downloading to the FLIR Tools application and a message will appear in FLIR Tools: "Waiting for log file to be received from FLIR DM91...". The meter will indicate the download progress via the bar graph, and show "End" when complete. The data will be visible in FLIR Tools under *LIBRARY* when complete.

Note: For fast sampling rate settings (1 or 2 seconds), it is possible for data points to drop while the meter is in the process of auto-ranging. Dashes appear in place of data in these cases. To minimize this likelihood, use a slower sampling rate setting.

6.8 Settings Menu

In the Settings menu, you can customize the meter:

1. Navigate to the Settings icon  using the arrow buttons and open the menu by pressing the **OK** button.
2. Use the up/down buttons to step through the modes, use the left/right arrows to change a setting.
3. Exit this menu by pressing the Return button. Refer to the list below:

APO	Auto power OFF: Use the left/right arrows to set the time after which the meter enters sleep mode (1 ~ 30 minutes, or set to OFF to disable APO). The factory default is 20 mins.
b.Lit	Auto backlight OFF: Use the left/right arrows to set the time after which the backlight automatically turns off (1 ~ 30 minutes or set to OFF). The factory default is 5 mins.
Hold	Auto hold / Data hold (A.H. or d.H.): Use the left/right arrows to select hold mode. For more information, see Section 6.9, Data Hold and Auto Hold .
dEF	Use the left/right arrows to select the default temperature unit of measure °C or °F.
dio	Diode mode: See Section 5.6, Classic Diode , and Section 5.7, Smart Diode . Use the left/right buttons to select Classic (C.d.) or Smart diode mode (S.d.)
C.r.	Coarse Resolution. Use the arrow buttons to select ON (to limit the least significant display digits) or OFF (to display with maximum resolution).
b.t.	Use the LEFT/RIGHT arrow buttons to switch Bluetooth® wireless communications ON/OFF. See Section 7, Bluetooth® Communication , for details
YEAr	Use left/right arrows to set current year
month	Use left/right arrows to set current month
dAY	Use left/right arrows to set current day
hour	Use left/right arrows to set current hour
min	Use left/right arrows to set current minute
rSt	Press OK at the (yES) prompt to revert to factory default settings

6.9 Data Hold and Auto Hold

The meter has two HOLD modes: classic Data Hold and Auto Hold. To select Data Hold or Auto Hold as the default, please use the Settings menu (see [Section 6.8, Settings Menu](#)). After selecting the default mode, refer to the paragraphs below.

6.9.1 Data Hold Mode

In Data Hold mode, the primary meter display freezes the last reading. To enter/exit Data Hold mode, press the **HOLD** button. In Hold mode, the **H** indicator appears.

6.9.2 Auto Hold Mode

In Auto hold mode, the secondary display freezes the last reading and the **H** icon flashes. The real-time reading appears on the primary display.

The held reading will not change unless the difference between the held reading and any new reading is > 50 digits.

The Auto hold function will capture a reading if the reading is > than the trigger level (see table below):

Function	Auto Hold Trigger Level
Voltage	> 1% full scale
Current	> 1% full scale
Capacitance	> 1% full scale
Resistance	With 'OL' not displayed
Diode	With 'OL' not displayed
Temperature	With 'OL' not displayed

To enter/exit Auto hold mode, press the **HOLD** button.

7. Bluetooth® Communication and FLIR Tools™

When connected to a mobile device running the **FLIR Tools** app, the DM91 (using the **METERLINK®** protocol) can:

- Send readings for live display on the mobile device
- Send saved data log files to the mobile device

When connected to a FLIR camera that supports Bluetooth BLE (Bluetooth Low Energy), the DM91 can:

- Send meter readings for live display on the camera screen

Download the **FLIR Tools** app at the link below:

<https://www.flir.com/products/flir-tools-app/>

1. Any Bluetooth BLE mobile device running the app can find and connect to the meter.
2. When successful communication between the meter and a mobile device or FLIR camera (that supports BLE) is established, the Bluetooth icon appears on the meter display.
3. View readings taken on the DM91 directly on the connected mobile device in real time.
4. Refer to the FLIR Tools help utility from within the app for detailed information and tutorials.

Note: The Bluetooth® utility defaults to ON but can be disabled in the Settings menu (see [Section 6.8, Settings Menu](#)).

8. Maintenance

8.1 Cleaning and Storage

Clean the meter with a damp cloth and mild detergent. Do not use abrasives or solvents. If the meter is stored for an extended period, remove the batteries and store them separately.

8.2 Battery Replacement

The Battery symbol flashes with no 'bars' when the batteries have reached a critical level. The meter displays readings within specifications while the low battery indicator is on. The meter powers off before it can display an out of tolerance reading.

WARNING: To avoid electrical shock, disconnect the meter from any connected circuits, remove the test leads from the meter terminals, and set the function switch to the OFF position before attempting to replace the batteries.

1. The DM91 is equipped with an easy-open battery compartment
2. Turn the compartment fastener to the unlocked position using a flat-head screwdriver.
3. Open the battery compartment.
4. Replace the 3x1.5V 'AA' alkaline batteries, observing correct polarity.
5. Turn the compartment fastener to the locked position with the screwdriver.
6. Secure the battery compartment before using the meter.

8.3 Fuse Replacement

The two fuses are accessed via the battery compartment cover. The fuses are rated:

- mA: 440 mA, 1000 V IR 10 kA fuse (Bussmann DMM-B-44/100).
- A: 11 A, 1000 V IR 20 kA fuse (Bussmann DMM-B-11A).

8.4 Disposal of Electronic Waste

As with most electronic products, this equipment must be disposed of in an environmentally friendly way, and in accordance with existing regulations for electronic waste. Please contact your FLIR Systems representative for more details.

9. Specifications

9.1 General specifications

Maximum voltage:	1000 V DC or 1000 V AC RMS
Display Counts:	6000
Polarity Indication:	Automatic, positive implied, negative indicated
Over-range Indication:	OL
Measuring Rate:	3 samples per second
Power Requirements:	3 x 1.5 V 'AA' alkaline batteries
Battery Life:	Approx. 180 hours with backlight and work light off
Battery consumption:	< 6 mA in DCV mode with backlight, work light, and beeper off
Low Battery Voltage:	Approx. 3.4V \pm 0.2V
Auto Power Off:	Default 20 minutes
Operating Temp/RH:	14°F to 86°F (-10°C to 30°C), < 80% RH 86°F to 104°F (30°C to 40°C), < 75% RH 104°F to 122°F (40°C to 50°C), <45% RH
Storage Temperature/RH:	-4°F to 140°F (-20°C to -60°C), 0-80% RH (without batteries)
Temperature Coefficient:	0.1 x (specified accuracy)/°C, < 64.4°F (18°C), >82.4°F (28°C)
Operating Altitude:	6560'(2000m)
Calibration Cycle:	One year
Weight:	19.8 oz (535g)
Dimensions:	(L x W x H) 7.9 x 3.7 x 1.9 in (200 x 95 x 49 mm)
Safety:	Complies with IEC 61010-1 CAT IV-600 V, CAT III-1000V

CAT	Application Field
I	Circuits not connected to mains.
II	Circuits directly connected to a low-voltage installation.
III	Building installation.
IV	Source of the low-voltage installation.

EMC: EN 61326-1

Pollution degree: 2

Drop protection: 9.8' (3m)

Max. Operating Altitude: 6562 ft (2000m)

9.2 Electrical Range Specifications

Accuracy is given as \pm (% of reading + counts of least significant digit) at $23^{\circ}\text{C} \pm 5^{\circ}\text{C}$, with relative humidity < 80%

Temperature coefficient: $0.1 * (\text{Specified accuracy}) / ^{\circ}\text{C}$, < 18°C , > 28°C

AC Function notes:

- ACV and ACA specifications are ac coupled, true RMS.
- For all AC functions, LCD displays 0 counts when the reading < 10 counts.
- For square waves, accuracy is unspecified.
- For non-sinusoidal waveforms, additional accuracy for Crest Factor (C.F.):
 - Add 1.0% for C.F. 1.0 to 2.0
 - Add 2.5% for C.F. 2.0 to 2.5
 - Add 4.0% for C.F. 2.5 to 3.0
- Max. Crest Factor of Input Signal:
 - 3.0 @ 3000 counts
 - 2.0 @ 4500 counts
 - 1.5 @ 6000 counts
- Frequency Response is specified for sine waveform.

DC Voltage

Range	OL Reading	Resolution	Accuracy
6.000V	6.600V	0.001V	$\pm(0.09\% + 2D)$
60.00V	66.00V	0.01V	
600.0V	660.0V	0.1V	
1000V	1100V	1V	

Input Impedance: $10\text{M}\Omega$

Overload Protection: AC/DC 1000V

AC Voltage

Range	OL Reading	Resolution	Accuracy	Freq. Response
6.000V	6.600V	0.001V	$\pm(1.0\% + 3D)$	45Hz ~ 500Hz
60.00V	66.00V	0.01V	$\pm(1.0\% + 3D)$	45Hz ~ 1kHz
600.0V	660.0V	0.1V		
1000V	1100V	1V		

Input Impedance: $10\text{M}\Omega$ (< 100pF)

Overload Protection: AC/DC 1000V

Lo-Z Voltage (Auto AC & DC Detection)

Range	OL Reading	Resolution	Accuracy
600.0V DC & AC	660.0V	0.1V	±(2.0% + 3D)
1000V DC & AC	1100V	1V	

Input Impedance: about 3kΩ

Frequency Response: 45 ~ 1kHz (Sine Wave)

Overload Protection: AC/DC 1000V

DC mV

Range	OL Reading	Resolution	Accuracy
600.0mV	660.0mV	0.1mV	±(0.5% + 2D)

Input Impedance: 10MΩ

Overload Protection: AC/DC 1000V

AC mV

Range	OL Reading	Resolution	Accuracy
600.0mV	660.0mV	0.1mV	±(1.0% + 3D)

Frequency Response: 45 ~ 1kHz (Sine Wave)

Input Impedance: 10MΩ

Overload Protection: AC/DC 1000V

DC Current

Range	OL Reading	Resolution	Accuracy
60.00mA	66.00mA	0.01mA	±(1.0% + 3D)
400.0mA	660.0mA	0.1mA	
6.000A	6.600A	0.001A	±(1.0% + 3D)
10.00A	20.00A	0.01A	

The accuracy of measurements > 10A is unspecified.

Maximum measurement time: > 5A for max. 3 minutes with at least 20-minute rest time.

> 10A for max.30 seconds with at least 10-minute rest time.

Overload Protection: AC/DC 11A for A terminal. AC/DC 660mA for mA terminal.

AC Current

Range	OL Reading	Resolution	Accuracy
60.00mA	66.00mA	0.01mA	±(1.5% + 3D)
400.0mA	660.0mA	0.1mA	
6.000A	6.600A	0.001A	±(1.5% + 3D)
10.00A	20.00A	0.01A	

Accuracy of readings > 10A is unspecified.

Maximum measurement time: > 5A for max. 3 minutes with at least 20-minute rest time.

> 10A for max. 30 seconds with at least 10-minute rest time.

Frequency Response: 45 ~ 1kHz (Sine Wave)

Overload Protection: AC/DC 11A for A terminal. AC/DC 660mA for mA terminal.

DC μ A

Range	OL Reading	Resolution	Accuracy
400.0 μ A	440.0 μ A	0.1 μ A	±(1.0% + 3D)
4000 μ A	4400 μ A	1 μ A	

Input Impedance: approx. 2k Ω

Overload Protection: AC/DC 1000V

AC μ A

Range	OL Reading	Resolution	Accuracy
400.0 μ A	440.0 μ A	0.1 μ A	±(1.0% + 3D)
4000 μ A	4400 μ A	1 μ A	

Input Impedance: approx. 2k Ω ; Frequency Response: 45 ~ 1kHz (Sine Wave)

Overload Protection: AC/DC 1000V

Resistance

Range	OL Reading	Resolution	Accuracy
600.0 Ω	660.0 Ω	0.1 Ω	±(0.9% + 5D)
6.000k Ω	6.600k Ω	0.001k Ω	±(0.9% + 2D)
60.00k Ω	66.00k Ω	0.01k Ω	±(0.9% + 2D)
600.0k Ω	660.0k Ω	0.1k Ω	±(0.9% + 2D)
6.000M Ω	6.600M Ω	0.001M Ω	±(0.9% + 2D)
50.00M Ω	55.00M Ω	0.01M Ω	±(3.0% + 5D)

Overload Protection: AC/DC 1000V

Continuity

Range	OL Reading	Resolution	Accuracy
600.0Ω	660.0Ω	0.1Ω	±(0.9% + 5D)

Continuity: Built-in beeper sounds when measured resistance is less than 20Ω and is off when measured resistance is more than 200Ω. Between 20Ω and 200Ω the beeper will stop at an unspecified point.

Continuity Indicator: 2KHz Tone Buzzer; Response Time of Buzzer: < 500μsec.

Overload Protection: AC/DC 1000V

Diode

Range	OL Reading	Resolution	Typical Reading
1.500V	1.550V	0.001V	0.400 ~ 0.800V

Open Circuit Voltage: Approx. 1.8V; Overload Protection: AC/DC 1000V

Frequency

Range	OL Reading	Resolution	Accuracy
100.00Hz	100.00Hz	0.01Hz	±(0.1% + 2D)
1000.0Hz	1000.0Hz	0.1Hz	
10.000kHz	10.000kHz	0.001kHz	
100.00kHz	100.00kHz	0.01kHz	

ACV - Minimum Sensitivity (including LoZ ACV):

Range	5Hz ~ 1kHz	1kHz ~ 10kHz	>10kHz
600.0mV	60mV	100mV	Unspecified
6.000V	0.6V	6V	Unspecified
60.00V	6V	10V	Unspecified
600.0V	60V	100V	Unspecified
1000V	600V	Unspecified	Unspecified

ACA - Minimum Sensitivity:

Range	5Hz ~ 10kHz	>10kHz
60.00mA	10mA	Unspecified
600.0mA	60mA	Unspecified
6.000A	2A	Unspecified
10.00A	2A	Unspecified

FLEX Current - Minimum Sensitivity:

Range	5Hz ~ 10kHz	>10kHz
30.00A	3.00A (0.300V)	Unspecified
300.0A	30.0A (0.300V)	Unspecified
3000A	300A (0.300V)	Unspecified

Minimum Frequency: 5Hz

Overload Protection: AC/DC 1000V or 600A

Capacitance

Range	OL Reading	Resolution	Accuracy
1000nF	1100nF	1nF	$\pm(1.9\% + 5D)$
10.00 μ F	11.00 μ F	0.01 μ F	$\pm(1.9\% + 2D)$
100.0 μ F	110.0 μ F	0.1 μ F	
1.000mF	1.100mF	0.001mF	
10.00mF	11.00mF	0.01mF	

Overload Protection: AC/DC 1000V

Flex Current

Range	OL Reading	Resolution	Accuracy
30.00A	33.00A	0.01A	$\pm(1.0\% + 3D)$
300.0A	330.0A	0.1A	
3000A	3300A	1A	

Accuracy does not include the accuracy of the Flexible Clamp Meter.

Frequency Response: 45 ~ 1kHz (Sine Wave)

Overload Protection: AC/DC 1000V

Type-K Temperature

Range	OL Reading	Resolution	Accuracy
-40.0°C to 400.0°C	440.0°C, -44.0°C	0.1°C	$\pm(1\% + 3^\circ\text{C})$
-40.0°F to 752.0°F	824.0°F, -44.0°F	0.1°F	$\pm(1\% + 5.4^\circ\text{F})$

Accuracy does not include the accuracy of the thermocouple probe.

Accuracy specification assumes surrounding temperature stable to $\pm 1^\circ\text{C}$. For surrounding temperature changes of $\pm 2^\circ\text{C}$, rated accuracy applies after 2 hours.

Accuracy specified for use with work light and backlight off only.

Overload Protection: AC/DC 1000V.

NCV (Non-Contact Voltage Detector)

Voltage Range (High Sensitivity): 80V to 1000V

Voltage Range (Low Sensitivity): 160V to 1000V

Peak Max and Peak Min Hold

For ACV, AC mV, ACA, ACmA, AC μ A, and Flex Current modes (unavailable for LoZ mode)

Specified accuracy \pm 150 digits for < 6000 counts

Specified accuracy \pm 250 digits for \geq 6000 counts

VFD (Low Pass Filter)

For ACV, AC mV, ACA, ACmA, AC μ A, and Flex Current modes (unavailable for LoZ mode)

Specified accuracy is for 45Hz ~ 65Hz

Specified accuracy \pm 4% for 65Hz ~ 400Hz

Accuracy is unspecified for > 400Hz

Cut-off Frequency: 800Hz

10. Technical Support

Technical Support Website	https://support.flir.com
---------------------------	---

11. Warranty

11.1 FLIR Global Limited Lifetime Warranty

This product is protected by FLIR's Limited Lifetime Warranty. Visit <https://support.flir.com/prodreg> to read the Limited Lifetime Warranty document.



Corporate Headquarters
FLIR Systems, Inc.
27700 SW Parkway Avenue
Wilsonville, OR 97070
www.flir.com

Technical Support Website: <https://support.flir.com>

Publication Identification No.:	DM91-en-US
Release Version:	AB
Release Date:	December 2019
Language:	en-US