

True RMS Mini Clamp Meters

MA61 60A AC Clamp Meter

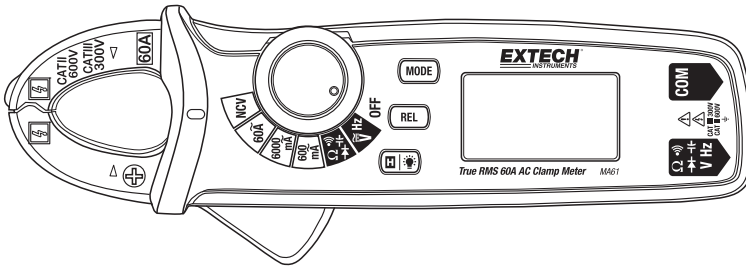

MA63 60A AC/DC Clamp Meter

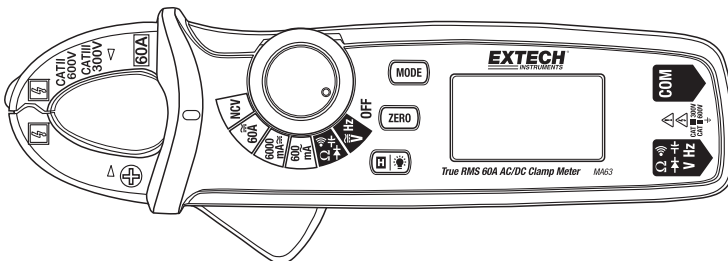

Introduction

Thank you for selecting the Extech Instruments True RMS Mini Clamp Meter. The MA61 measures AC Current while the MA63 measures AC and DC Current. Both meters also measure AC/DC Voltage, Frequency, Resistance, Capacitance, Diode, and Continuity.

The Mini Clamp Meters measure current in three AC ranges 600mA, 6000mA, and 60A. The MA63 only measures DC current in two ranges 6000mADC and 60ADC.

The clamp meters offer advanced features that includes NCV (non-contact voltage) detection and VFC (variable frequency control) that inserts a low pass filter in the measurement circuit.

This device is shipped fully tested and calibrated and, with proper use, will provide years of reliable service. Please visit our website (www.extech.com) to check for the latest version of this User Guide, Product Updates, Product Registration, and Customer Support.

Features

- True RMS for accurate readings of noisy, distorted, or non-sinusoidal waveforms
- Model MA61 for AC Current, AC/DC Voltage Measurements, and Relative function
- Model MA63 for AC/DC Current/Voltage Measurements, and Zero function
- Frequency, Resistance, and Capacitance Measurements
- Compact 0.7" (17mm) jaw size accommodates conductors up to 300MCM
- Variable Frequency Control (VFC): Low pass filter for accurate measurement of variable frequency drive signals by filtering high-frequency interference.
- Built-in Non-Contact Voltage (NCV) detector
- Full range overload protection
- 6000 count backlit LCD display
- Data Hold freezes reading on display
- Low battery indicator and Auto Power Off feature with disable
- CAT II-600V CAT III-300V safety rating
- Complete with test leads, carrying case, and two AAA batteries

Safety







The product design meets IEC/EN61010-1 and EN61010-2-033. Please read the User Guide before use and comply with all safety instructions.

This product conforms to UL Standards 61010-1, 61010-2-030, 61010-2-032, 61010-2-033 and is Certified to CSA standards C22.2 no. 61010-1, 61010-2-030 and IEC standards 61010-2-032 and 61010-2-033.

Safety Notices

1. Please use the clamp meter according to this User Guide otherwise the built-in protections may be compromised.
2. Please comply with with national safety regulations with regard to wearing personal protective attire and gear to avoid injury and damage caused by arc discharging in cases where the live conductor is exposed.
3. Do not allow the fingers or the hand above the protective finger guard while testing.
4. Please check the clamp meter housing, buttons, switches, and insulated wires for cracks or other damage before each use. Service or replace if necessary.
5. Please remove the clamp meter from all live circuits and disconnect the test leads before removing the rear battery compartment cover.
6. Please do not use the clamp meter to measures signals greater than 600V or frequencies higher than 400Hz.
7. Over-voltage level: CAT II 600V; CAT III 300V, pollution class 2.
8. Working near exposed conductors must be done so using the highest caution. Such conductors present a lethal electric shock hazard.
9. Use caution measuring voltage equal to or greater than 60VDC, 30VAC or 42V AC (peak) as these present the risk of electric shock.
10. This device has a maximum measurement voltage limit of 600V and the safety standard complies with CE/ETL certification (EN61010-1, EN61010-2-033, and EN61010-2-032).

International Safety Symbols

	DC Voltage DC Current		Refer to explanation in owners manual
	AC Voltage AC Current		Dangerous voltage risk of electrical shock
	Ground		Double Insulation

Meter Description

1. Clamp Jaws
2. Measured Conductor
3. NCV Non-Contact Voltage Detector lamp
4. Function Select Switch
5. MODE Button
6. LCD Display
7. COM Input Test Lead Terminal
8. Positive Input Test Lead Terminal
9. REL (Relative) button on MA61; ZERO button on MA63
10. Display Hold / backlight button
11. Jaw trigger open/close control

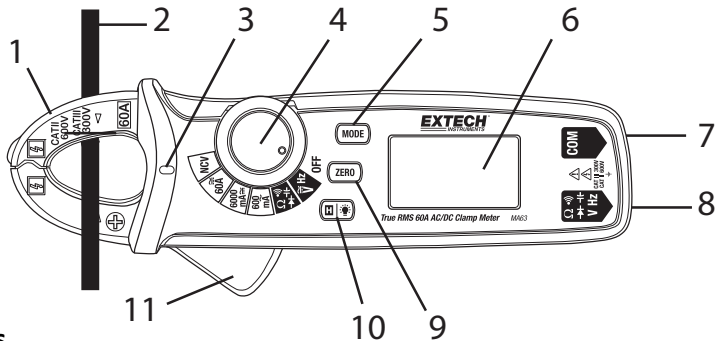

Fig-1 Meter Parts

Control Buttons Description

Button	Description
MODE	Press and hold to select VFC (variable frequency control, low pass filter) MA63 only: Short press to select DC, AC or Frequency (Hz)
ZERO	MA63 only; Press to access the ZERO mode
REL	MA61 only; Press to access the Relative mode
	Short press to freeze/unfreeze the displayed reading Press and hold to toggle the backlight ON-OFF

Function Switch Description

MODEL MA61

1. NCV: Non-Contact Voltage Detector
2. 60A AC Measurements
3. 600mA AC Measurements
4. 6000mA AC Measurements
5. Resistance, Diode, Continuity, and Capacitance Measurements
6. AC or DC Voltage and Frequency Measurement
7. POWER OFF selection
8. Function Selector Dial

MODEL MA63

9. NCV: Non-Contact Voltage Detector
10. 60A AC with Frequency or DC Measurements
11. 600mA AC with Frequency or DC Measurements
12. 6000mA AC with Frequency or DC Measurements
13. Resistance, Diode, Continuity, and Capacitance Measurements
14. AC or DC Voltage and Frequency Measurements
15. POWER OFF selection
16. Function Selector Dial

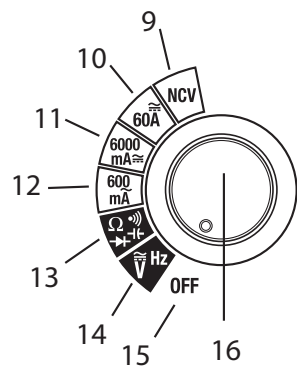
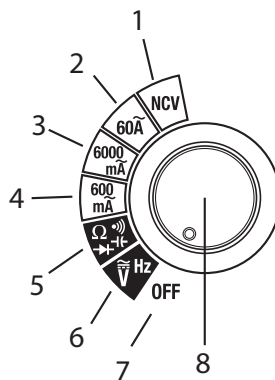





Fig-2 Function Switch

Model MA61

Model MA63

Display Icon Descriptions

	Low Battery
Trms	True RMS measurement
DC	Direct current
AC	Alternating current
AUTO	Automatic range
-	Minus sign; negative reading
•)))	Audible Continuity mode
	Diode test
	Display hold
	Auto Power OFF (APO) icon (switches off when APO is disabled)
ZERO/REL	Zero (MA63) and Relative (MA61) functions
VFC	Variable Frequency Control (low pass filter) for AC Voltage/Current
EF	NCV (Non-Contact Voltage) Detector (EF: Electromotive Force)
mA, A	Ampere: Unit of current
mV, V	Volt: Unit of voltage
Ω, kΩ, MΩ	Ohm: Unit of resistance
F, μF, nF	Farad: Unit of capacitance
O.L	Over-range measurement
Measurement unit prefixes	
m	(milli-) 10^{-3}
μ	(micro-) 10^{-6}
n	(nano-) 10^{-9}
k	(kilo-) 10^3
M	(mega-) 10^6

Operation

Meter Power

Caution: Do not use the meter with battery compartment open or unsecured.

The clamp meter is powered by two (2) AAA batteries. The battery compartment is located on the back of the meter. The battery compartment is secured by one Phillips head screw. Refer to the Battery Replacement section later in this guide for more information.

Automatic Power OFF (APO)

The meter automatically switches off after 15 minutes of inactivity. Before switching off, the meter beeps several times to alert the user. To disable APO, hold down the MODE button while powering up the meter. The meter will beep five (5) times indicating that APO is disabled; release the button. Note that the APO icon  is not visible on the display when APO is disabled. APO is re-enabled on the next cycling of meter power.

Current Measurements - Clamping Technique

Clamp around only one conductor. Refer to Fig-3 below. The diagram at left is correct and the diagram at right is incorrect.

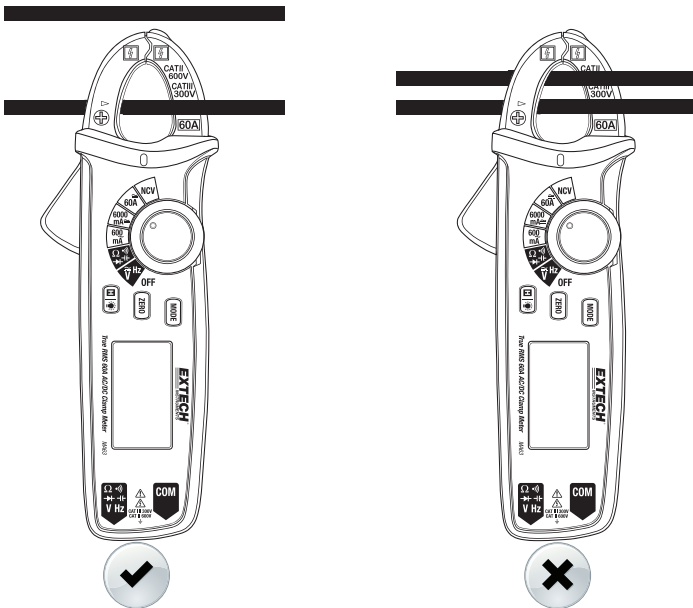

Fig-3 Correct and Incorrect Clamping Techniques

AC Current Measurements

WARNING: To avoid electric shock, disconnect the test leads from the meter before making current measurements.



CAUTION: Observe CAT II 600V, CAT III 300V with respect to Earth Ground for the Jaw.

1. Set the Function switch to the 600mA, 6000mA, or 60A range.
2. For the MA63, short press the MODE button to Select AC, Frequency (or DC)
3. Press the Trigger to open the clamp jaw.
4. Clamp onto a single conductor (fully enclosing it). Do not allow a gap between the two halves of the jaw. Refer to Fig-3 earlier in the Operation section.
5. When measuring variable frequency devices, press and hold the VFC button to start/stop measuring with the low pass filter.
6. Read the ACA value on the LCD.

DC Current Measurements (MA63 only)

WARNING: To avoid electric shock, disconnect the test leads from the meter before making current measurements.



CAUTION: Observe CAT II 600V, CAT III 300V with respect to Earth Ground for the Jaw.

1. Set the Function switch to the 600mA, 6000mA, or 60A range.
2. Use the MODE button to select DC.
3. Press the ZERO button several times to null the meter display without a conductor in the clamp jaw. Zero the meter with the clamp held in the same orientation as the actual measurement (see Fig-4).
4. Press the Trigger to open the current sense Jaw.
7. Fully enclose a single conductor. Do not allow a gap between the two halves of the jaw. Refer to Fig-3 earlier in this guide.
5. Read the DCA value on the LCD.

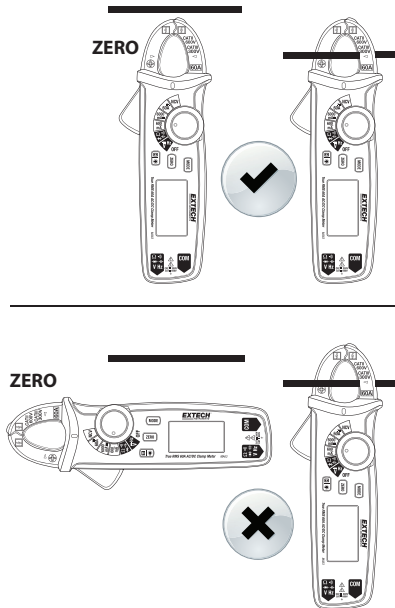

Fig-4 Correct and Incorrect ZERO techniques

Frequency Measurements

WARNING: To avoid electric shock, disconnect the test leads from the meter before making current measurements.



CAUTION: Observe CAT II 600V, CAT III 300V with respect to Earth Ground for the Jaw.

1. Set the Function switch to the Hz position.
2. Press the Trigger to open the jaw and fully enclose one conductor. Refer to the Fig-3 in the Current Clamp technique section above.
3. Read the Frequency measurement on the LCD in Hz.

Voltage Measurements



WARNING: Do not apply > 600VAC/DC between the meter's terminals and earth ground



CAUTION: When connecting the test leads to the circuit or device under test, connect the black lead before the red; when removing the test leads, remove the red before the black lead.

AC Voltage Measurements

1. Insert the black test lead banana plug into the negative (COM) jack and the red test lead banana plug into the positive (V/ Ω) jack.
2. Turn the function switch to the V position.
3. Use the MODE button to select AC if necessary. Use the MODE button to also select the frequency of the measured voltage.
4. Touch the test probe tips to the circuit under test.
5. Read the value in the display. The display will indicate the proper decimal point.

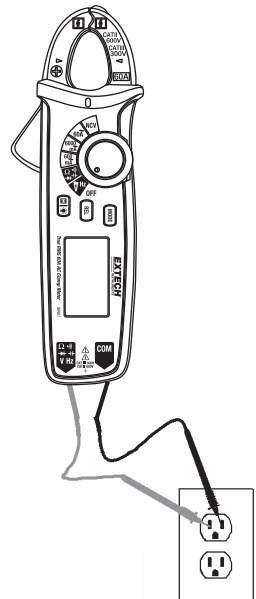

Fig-5 AC VOLTAGE MEASUREMENT

DC Voltage Measurements

1. Insert the black test lead banana plug into the negative (COM) jack and the red test lead banana plug into the positive (V/ Ω) jack.
2. Move the Function Switch to the V position.
3. Press the MODE button to select DC if necessary.
4. Touch the test probe tips to the circuit under test. Be sure to observe the correct polarity (red lead to positive, black lead to negative).
5. Read the voltage in the display. The display will indicate the proper decimal point and value. If the polarity is reversed, the display will show (-) minus before the value.
6. The meter is capable of detecting DC voltages to 600V.
7. When voltage is measured, the NCV voltage detect LED will be lit.

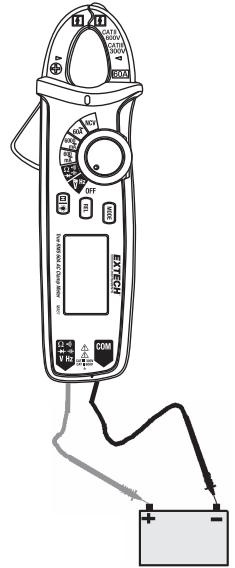

Fig-6 DC VOLTAGE MEASUREMENT

Resistance Measurements

Cautions: Switch OFF power to the device under test before measuring. Do not test on circuits or devices where 60VDC or 30VAC is present.

1. Insert the black test lead banana plug into the negative (COM) jack. Insert the red test lead banana plug into the positive (V/ Ω) jack.
2. Turn the Function Switch to the Ω position.
3. Use the MODE button to select the Ω icon on the display indicating resistance only (without the audible continuity icon showing).
4. Touch the test probe tips across the circuit or part under test. It is best to disconnect one side of the part under test so the rest of the circuit will not interfere with the resistance reading.
5. Read the resistance in the display. The display will indicate the proper decimal point and value.

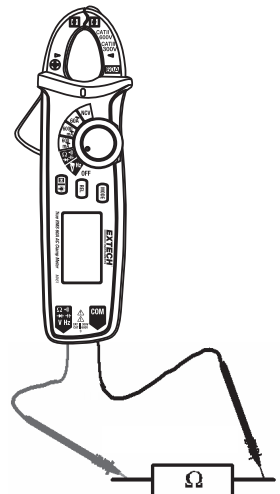

Fig-7 RESISTANCE MEASUREMENT

Continuity Measurements

1. Insert the black test lead into the negative **COM** terminal and the red test lead into the positive terminal.
2. Set the function switch to the $\bullet)))$ position.
3. Use the **MODE** button to select the Continuity mode. Look for the Continuity icon $\bullet)))$ on the display.
4. Touch the test probe tips across the circuit or component under test. Refer to Fig-7 in the Resistance measurement section.
5. If the resistance is $< 10 \Omega$, the beeper will sound.

Capacitance Measurements

WARNING: To avoid electric shock, remove power to the circuit under test and discharge the capacitor under test before measuring. Do not test on circuits or devices where 60VDC or 30VAC is present.

1. Set the function switch to the F capacitance position.
2. Insert the black test lead banana plug into the negative **COM** jack and the red test lead banana plug into the positive F jack.
3. Press MODE to select the unit of measure symbol **F**.
4. Touch the test probe tips across the part under test.
5. Use the REL button (MA61) or the ZERO button (MA63) especially for low capacitance measurements $< 1\mu\text{F}$ for Relative measurements.
6. Read the capacitance value in the display.
7. The display will indicate the proper decimal point and value.

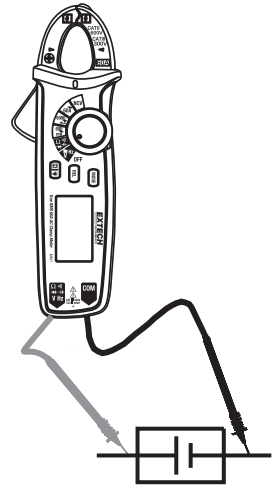

Note: For large values of capacitance several minutes may be required before the final reading stabilizes.

Fig-8 CAPACITANCE MEASUREMENT

Diode Test

1. Insert the black test lead banana plug into the negative **COM** jack and the red test lead banana plug into the **→** positive jack.
2. Turn the function switch to **→** position. Use the **MODE** button to select the diode function if necessary (the diode and voltage symbols will appear on the LCD when in Diode test mode).
3. Touch the test probe tips to the diode or semiconductor junction under test. Note the meter reading.
4. Reverse the test lead polarity by reversing the red and black leads. Note this reading.
5. The diode or junction can be evaluated as follows:
 - If one reading displays a value (typically 0.400V to 0.900V) and the other reading displays **OL**, the diode is good.
 - If both readings display **OL** the device is open.
4. If both readings are very small or '0', the device is shorted.

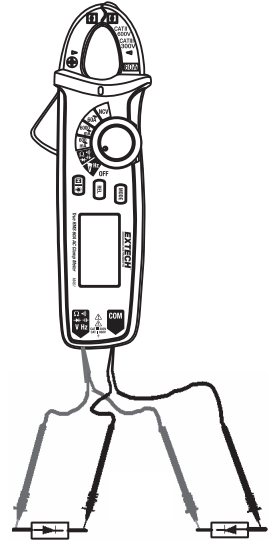

Fig-9 DIODE TEST

NCV Non-Contact AC Voltage Detector



CAUTION: Remove test leads from meter before attempting NCV tests. Always verify the NCV function on a known live circuit before performing tests. Do not use the NCV function if the display does not show **EF** when the function switch is turned to the NCV position. If the meter does not switch on when the NCV mode is initiated, please check the batteries.

With the meter on and switched to the NCV mode, holding the front tip of the clamp jaw near a live electrical, electromagnetic, or electrostatic field causes the beeper to sound, the display to show dashes, and the red LED lamp to flash. The threshold is 100V. The greater the field strength the greater the number of dashes and the faster the rate of the audible beeps and the flashing LED lamp.

If the meter does not emit a tone or display dashes in this mode, there is still the possibility that voltage is present. Please use caution.

1. Turn the Function switch to the NCV position to access the Non-Contact Voltage Detect mode.
2. Note the voltage detection display icon **NCV** and the larger **EF** display. If these displays are not seen when the NCV mode is accessed do **NOT** attempt to use the meter. Check the batteries and try again. If the meter still does not switch on when the NCV mode is accessed please have the meter serviced or replaced.
3. Place the meter near a source of electrical energy. The front tip of the clamp offers the highest sensitivity.
4. Note the audible beeping, the dash displays, and the flashing LED lamp when an electrical or electromagnetic field of at least 100V is sensed. Note that electrostatic energy will trigger the NCV detector, this is normal.

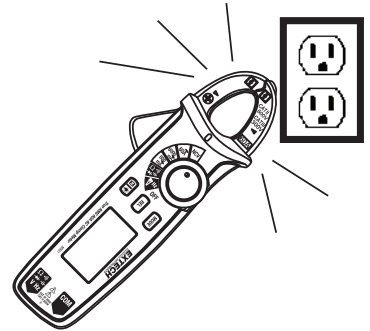

Fig-10 NON-CONTACT AC VOLTAGE DETECTOR

Data Hold

To freeze the displayed reading on the LCD, press the Data Hold (**H**) button (the **H** icon will appear on the display). To release the Data Hold function and return the meter to normal operation, press the Data Hold (**H**) button again (the **H** icon will switch off).

Zero/Relative Measurements

1. Press **ZERO** (MA63) or **REL** (MA61) to enter the mode. The display will show the ZERO icon.
2. Now each time the ZERO/REL button is pressed the present measurement will zero and the beeper will sound. This mode is especially useful for DCA measurement zeroing.
3. In this mode, all subsequent measurements are displayed with respect to the reference measurement. For example, if a 20V reading is zeroed and a 30V reading is subsequently measured, the LCD will display 10V.
4. Use the REL button (MA61) or the ZERO button (MA63) especially for low capacitance measurements < 1 μ F for Relative measurements and DCA measurements.
5. To return to normal operation, press and hold the ZERO or REL button until the ZERO display icon switches OFF.

Battery Replacement

CAUTION: Please disconnect the test leads from the meter, turn the meter off, and unclamp the meter from any conductors before attempting to change the batteries.

1. When the low battery symbol  appears on the LCD, the batteries must be replaced.
2. Turn the meter off and remove the rear battery compartment screw.
3. Lift off the battery compartment cover and replace the two 1.5V AAA cells observing correct polarity.
4. Replace the compartment cover and secure the screw before using the meter.



You, as the end user, are legally bound (**EU Battery ordinance**) to return all used batteries, **disposal in the household garbage is prohibited!** You can hand over your used batteries / accumulators at collection points in your community or wherever batteries / accumulators are sold!

Disposal: Follow the valid legal stipulations in respect of the disposal of the device at the end of its lifecycle

Cleaning

With the meter OFF, use only a dry cloth to wipe clean the meter housing. Do not use harsh soaps, abrasives, or solvents to clean the meter housing.

Specifications

General Specifications

Display	6000 count LCD with multifunction indicators Full scale 6200 counts for Capacitance function Full scale 9999 counts for Frequency function
LED lamp	For Non-Contact Voltage Detector
Functions	Current (ACA, DCA), Voltage (VAC, VDC), Resistance, Capacitance, Frequency, Non-Contact Voltage detector, Continuity, and Diode test
Polarity	"-" indicates negative polarity (positive polarity assumed)
Current sensor	Hall effect
Overload indication	O.L
DCA zero adjust	MA63: One-touch ZERO button (also used as a Relative function); MA61: REL button (Relative)
Display rate	2~3 readings/second
Battery	Two 1.5V AAA batteries
Operating temperature	0°C to 40°C (32°F to 104°F)
Operating Humidity	< 75% RH 0~30C (32°F to 86°F) < 50% RH 30~40C (86°F to 104°F)
Storage temperature	-10°C to 50°C (14°F to 122°F)
Altitude	2000m (6562')
Power consumption	20mA DC approx.
Weight	170g (6.0 oz.) including battery
Dimensions	175 x 60 x 33.5mm (6.9 x 2.4 x 1.3") (H x W x D)
Jaw opening	17mm (0.7") 3000MCM
Standards	IEC/EN 61010-1, EN61010-2-033, EN61010-2-032; Category III 300V, Category II 600V; pollution class 2
Electromagnetic compatibility	< 1V/m RF field: Overall accuracy = specified accuracy +5% of the range. Unspecified indication for 1V/m RF field.
Test Leads	Use only test probes rated CAT II 600V, CAT III 300V or better that meet the requirements of IEC 61010-031

Range Specifications

Accuracy stated for ambient conditions $23^{\circ}\text{C} \pm 5^{\circ}\text{C}$ ($73.4^{\circ}\text{F} \pm 9^{\circ}\text{F}$)

DC Current (MA63)	Resolution	Accuracy (of rdg + digits)		Overload
6000mA	1mA	$\pm(2.0\% + 5d)$		100A DC
60A	0.01A	$\pm(2.0\% + 3d)$		100A DC
AC Current	Resolution	50/60Hz	$\geq 100\text{Hz} \leq 400\text{Hz}$	Overload
600.0mA	0.1mA	$\pm(1.5\% + 10d)$	$\pm(2.0\% + 10d)$	100A / 600VAC
6000mA	1mA	$\pm(2.5\% + 5d)$	$\pm(3.0\% + 5d)$	100A / 600VAC
60A	0.01A	$\pm(2.0\% + 5d)$	$\pm(2.5\% + 5d)$	100A / 600VAC
VFC 600.0mA~60A	0.1mA~0.01A	$\pm(4.0\% + 10d)$		100A / 600VAC

Notes: Accuracy stated for 5~100% of range; <20 digit residual reading for 600mA open circuit.

AC Crest Factor may reach 3.0 at 4000 counts; for non-sinusoidal waveforms the Crest Factor error increases per the following: Add 3% when the crest factor is 1~2; Add 5% when the crest factor is 2~2.5; Add 7% when the crest factor is 2.5~3

DC Voltage	Resolution	Accuracy	Overload Protect
600.0mV	0.1mV	$\pm(0.7\% + 5d)$	600V
6.000V	1mV	$\pm(0.7\% + 3d)$	600V
60.00V	10mV		600V
600.0V	0.1V		600V
600V	1V		600V

Notes: For 600mV range the Input Impedance is $\geq 1\text{G ohm}$; for other ranges the average impedance is 10M ohm.

AC Voltage	Resolution	Accuracy	Overload
6.000V	1mV	$\pm(0.8\% + 3d)$	600V
60.00V	10mV		600V
600.0V	0.1V		600V
600V	1V	$\pm(1.0\% + 3d)$	600V
VFC 200V~600V	0.1V	$\pm(4.0\% + 3d)$	600V

Notes: Input impedance approximately 10Mohm

Display True RMS; Frequency Response 45~400Hz

Accuracy stated for 5~100% of range; <20 digit residual reading for 600mA open circuit.

AC Crest Factor may reach 3.0 at 4000 counts; for non-sinusoidal waveforms the Crest Factor error increases per the following: Add 3% when the crest factor is 1~2; Add 5% when the crest factor is 2~2.5 Add 7% when the crest factor is 2.5~3

Frequency (Hz)	Resolution	Accuracy	Overload Protect
10Hz to 60kHz	0.001~0.01kHz	±(0.1% + 4d)	600V

Notes: Input amplitude ≥10V (DC level: 0); Frequency of 65kHz or higher for reference only

Resistance	Resolution	Accuracy	Overload
600.0 Ω	0.1 Ω	±(1.0% + 2d)	600V
6.000k Ω	1 Ω	±(0.8% + 2d)	600V
60.00k Ω	10 Ω		600V
600.0k Ω	100 Ω		600V
6.000M Ω	1k Ω	±(1.2% + 3d)	600V
60.00M Ω	10k Ω	±(1.5% + 5d)	600V
Capacitance	Resolution	Accuracy	Overload
6.200nF	1pF	In REL/ZERO mode: ±(4.0% + 10d)	600V
62.00nF~620.0μF	10pF~0.1μF	±(4.0% + 5d)	600V
6.200mF~62.00mF	1μF~10μF	± (10%)	600V

Note: For best accuracy, use REL (MA61) or ZERO function (MA63) when measuring ≤ 1 μF

Continuity	Resolution	Notes	Overload
•))	0.1 Ω	Beeper sounds ≤10 Ω	600V
Diode	Resolution	Notes	Overload
→ ←	1mV	Open circuit voltage is 3.2V approx. Normal voltage range: 0.5V~0.8V	600V

Copyright © 2015 FLIR Systems, Inc.

All rights reserved including the right of reproduction in whole or in part in any form

www.extech.com