

## Operating Guide

# PSI 9000 DT

## DC Laboratory Power Supply



Attention! This document is only valid for devices with firmware "KE: 3.09" and "HMI: 2.20 and "DR: 1.0.6" or higher. For availability of updates for your device check our website or contact us.



Doc ID: PSI9DTEN  
Revision: 06  
Date: 03/2021





# TABLE OF CONTENTS

## 1 GENERAL

1.1	About this document	5
1.1.1	Retention and use	5
1.1.2	Copyright	5
1.1.3	Validity	5
1.1.4	Symbols and warnings	5
1.2	Warranty	5
1.3	Limitation of liability	5
1.4	Disposal of equipment	6
1.5	Product key	6
1.6	Intended usage	6
1.7	Safety	7
1.7.1	Safety notices	7
1.7.2	Responsibility of the user	8
1.7.3	Responsibility of the operator	8
1.7.4	User requirements	8
1.7.5	Alarm signals	9
1.8	Technical Data	9
1.8.1	Approved operating conditions	9
1.8.2	General technical data	9
1.8.3	Specific technical data	10
1.8.4	Views	22
1.8.5	Control elements	25
1.9	Construction and function	26
1.9.1	General description	26
1.9.2	Block diagram	26
1.9.3	Scope of delivery	26
1.9.4	Optional accessories	26
1.9.5	The control panel (HMI)	27
1.9.6	USB port (rear side)	30
1.9.7	Ethernet port	30
1.9.8	Analog interface	30
1.9.9	Sense connector (remote sensing)	30

## 2 INSTALLATION & COMMISSIONING

2.1	Storage	31
2.1.1	Packaging	31
2.1.2	Storage	31
2.2	Unpacking and visual check	31
2.3	Installation	31
2.3.1	Safety procedures before installation and use	31
2.3.2	Preparation	31
2.3.3	Installing the device	31
2.3.4	Connection to AC supply	36
2.3.5	Connection to DC loads	36
2.3.6	Grounding of the DC output	37
2.3.7	Connection of remote sensing	37
2.3.8	Connecting the analog interface	37
2.3.9	Connecting the USB port (rear side)	38
2.3.10	Initial commission	38
2.3.11	Commission after a firmware update or a long period of non-use	38

## 3 OPERATION AND APPLICATION

3.1	Personal safety	39
3.2	Operating modes	39
3.2.1	Voltage regulation / Constant voltage	39
3.2.2	Current regulation / constant current / current limiting	40
3.2.3	Power regulation / constant power / power limiting	40
3.2.4	Internal resistance regulation	40
3.3	Alarm conditions	42
3.3.1	Power Fail	42
3.3.2	Overtemperature	42
3.3.3	Overvoltage protection	42
3.3.4	Overcurrent protection	42
3.3.5	Overpower protection	42
3.4	Manual operation	43
3.4.1	Switching the device on	43
3.4.2	Switching the device off	43
3.4.3	Configuration via MENU	43
3.4.4	Adjustment limits (Limits)	48
3.4.5	Changing the operating mode	48
3.4.6	Manual adjustment of set values	49
3.4.7	Switching the main screen view	50
3.4.8	The meter bars	50
3.4.9	Switching the DC output on or off	51
3.4.10	Recording to USB stick (logging)	51
3.5	Remote control	53
3.5.1	General	53
3.5.2	Control locations	53
3.5.3	Remote control via a digital interface	53
3.5.4	Remote control via the analog interface (AI)	55
3.6	Alarms and monitoring	59
3.6.1	Definition of terms	59
3.6.2	Device alarm and event handling	59
3.7	Control panel (HMI) lock	61
3.8	Limits lock	62
3.9	Loading and saving an user profile	62
3.10	The function generator	63
3.10.1	Introduction	63
3.10.2	General	63
3.10.3	Method of operation	64
3.10.4	Manual operation	64
3.10.5	Sine wave function	65
3.10.6	Triangular function	66
3.10.7	Rectangular function	66
3.10.8	Trapezoidal function	67
3.10.9	DIN 40839 function	67
3.10.10	Arbitrary function	68
3.10.11	Ramp Function	72
3.10.12	Remote control of the function generator	72
3.11	Other applications	73
3.11.1	Series connection	73
3.11.2	Parallel operation	73
3.11.3	Operation as battery charger	73

## 4 SERVICE AND MAINTENANCE

4.1	Maintenance / cleaning.....	74
4.2	Fault finding / diagnosis / repair.....	74
4.2.1	Replacing a defect mains fuse .....	74
4.2.2	Firmware updates .....	74
4.3	Calibration .....	75
4.3.1	Preface .....	75
4.3.2	Preparation.....	75
4.3.3	Calibration procedure .....	75

## 5 CONTACT AND SUPPORT

5.1	General.....	77
5.2	Contact options .....	77

## 1. General

### 1.1 About this document

#### 1.1.1 Retention and use

This document is to be kept in the vicinity of the equipment for future reference and explanation of the operation of the device. This document is to be delivered and kept with the equipment in case of change of location and/or user.

#### 1.1.2 Copyright

Reprinting, copying, also partially, usage for other purposes as foreseen of this manual are forbidden and breach may lead to legal process.



#### 1.1.3 Validity

This manual is valid for the following equipment:

Model	Article number	Model	Article number
PSI 9040-20 DT	06200500	PSI 9500-06 DT	06200509
PSI 9080-10 DT	06200501	PSI 9750-04 DT	06200510
PSI 9200-04 DT	06200502	PSI 9080-60 DT	06200511
PSI 9040-40 DT	06200503	PSI 9200-25 DT	06200512
PSI 9080-20 DT	06200504	PSI 9360-15 DT	06200513
PSI 9200-10 DT	06200505	PSI 9500-10 DT	06200514
PSI 9080-40 DT	06200506	PSI 9750-06 DT	06200515
PSI 9200-15 DT	06200507	PSI 9040-60 DT	06200516
PSI 9360-10 DT	06200508	PSI 9040-40 DT	06200517

#### 1.1.4 Symbols and warnings

Warning and safety notices as well as general notices in this document are shown in a box with a symbol as follows:

	<b>Symbol for a life threatening danger</b>
	Symbol for general safety notices (instructions and damage protection bans) or important information for operation
	<i>Symbol for general notices</i>

## 1.2 Warranty

EA Elektro-Automatik guarantees the functional competence of the applied technology and the stated performance parameters. The warranty period begins with the delivery of free from defects equipment.

Terms of guarantee are included in the general terms and conditions (TOS) of EA Elektro-Automatik.

## 1.3 Limitation of liability

All statements and instructions in this manual are based on current norms and regulations, up-to-date technology and our long term knowledge and experience. The manufacturer accepts no liability for losses due to:

- Usage for purposes other than designed
- Use by untrained personnel
- Rebuilding by the customer
- Technical changes
- Use of not authorized spare parts

The actual delivered device(s) may differ from the explanations and diagrams given here due to latest technical changes or due to customized models with the inclusion of additionally ordered options.

## 1.4 Disposal of equipment

A piece of equipment which is intended for disposal must, according to European laws and regulations (ElektroG, WEEE) be returned to the manufacturer for scrapping, unless the person operating the piece of equipment or another, delegated person is conducting the disposal. Our equipment falls under these regulations and is accordingly marked with the following symbol:



## 1.5 Product key

Decoding of the product description on the label, using an example:

**PSI 9 080 - 40 DT**

	Construction (not printed everywhere) <b>DT</b> = Desktop model
	Maximum current of the device in Ampere
	Maximum voltage of the device in Volt
	Series : <b>8</b> = Series 8000 or 800, <b>9</b> = Series 9000
	Type identification: <b>PSI</b> = Power Supply Intelligent, always programmable

## 1.6 Intended usage

The equipment is intended to be used, if a power supply or battery charger, only as a variable voltage and current source, or, if an electronic load, only as a variable current sink.

Typical application for a power supply is DC supply to any relevant user, for a battery charger the charging of various battery types and for electronic loads the replacement of an ohmic resistor by an adjustable DC current sink in order to load relevant voltage and current sources of any type.



- Claims of any sort due to damage caused by non-intended usage will not be accepted.
- All damage caused by non-intended usage is solely the responsibility of the operator.

**1.7 Safety****1.7.1 Safety notices****Mortal danger - Hazardous voltage**

- **Electrical equipment operation means that some parts can be under dangerous voltage. Therefore all parts under voltage must be covered! This basically applies to all models, though 40 V models according to SELV can not generate hazardous DC voltage.**
- **All work on connections must be carried out under zero voltage (output not connected to load) and may only be performed by qualified and informed persons. Improper actions can cause fatal injury as well as serious material damage.**
- **Never touch cables or connectors directly after unplugging from mains supply as the danger of electric shock remains.**
- **Never touch the contacts on DC output terminal directly after switching off the DC output, because there still can dangerous voltage present, sinking more or less slowly depending on the load! There also can be dangerous potential between negative DC output to PE or positive DC output to PE due to charged X capacitors.**



- The equipment must only be used as intended
- The equipment is only approved for use within the connection limits stated on the product label.
- Do not insert any object, particularly metallic, through the ventilator slots
- Avoid any use of liquids near the equipment. Protect the device from wet, damp and condensation.
- For power supplies and battery chargers: do not connect loads, particularly such with low resistance, to devices under power; sparking may occur which can cause burns as well as damage to the equipment and to the load.
- For electronic loads: do not connect power sources to equipment under power, sparking may occur which can cause burns as well as damage to the equipment and to the source.
- ESD regulations must be applied when plugging interface cards or modules into the relative slot
- Interface cards or modules may only be attached or removed after the device is switched off. It isn't necessary to open the device.
- Do not connect external power sources with reversed polarity to DC input or outputs! The equipment will be damaged.
- For power supply devices: avoid where possible connecting external power sources to the DC output, and never those that can generate a higher voltage than the nominal voltage of the device.
- For electronic loads: do not connect a power source to the DC input which can generate a voltage more than 120% of the nominal input voltage of the load. The equipment isn't protected against over voltage and may be irreparably damaged.
- Never insert a network cable which is connected to Ethernet or its components into the master-slave socket on the back side of the device!
- Always configure the various protecting features against overvoltage overpower etc. for sensitive loads to what the currently used application requires

### 1.7.2 Responsibility of the user

The equipment is in industrial operation. Therefore the operators are governed by the legal safety regulations. Alongside the warning and safety notices in this manual the relevant safety, accident prevention and environmental regulations must also be applied. In particular the users of the equipment:

- must be informed of the relevant job safety requirements
- must work to the defined responsibilities for operation, maintenance and cleaning of the equipment
- before starting work must have read and understood the operating manual
- must use the designated and recommended safety equipment.

Furthermore, anyone working with the equipment is responsible for ensuring that the device is at all times technically fit for use.

### 1.7.3 Responsibility of the operator

Operator is any natural or legal person who uses the equipment or delegates the usage to a third party, and is responsible during its usage for the safety of the user, other personnel or third parties.

The equipment is in industrial operation. Therefore the operators are governed by the legal safety regulations. Alongside the warning and safety notices in this manual the relevant safety, accident prevention and environmental regulations must also be applied. In particular the operator has to

- be acquainted with the relevant job safety requirements
- identify other possible dangers arising from the specific usage conditions at the work station via a risk assessment
- introduce the necessary steps in the operating procedures for the local conditions
- regularly control that the operating procedures are current
- update the operating procedures where necessary to reflect changes in regulation, standards or operating conditions.
- define clearly and unambiguously the responsibilities for operation, maintenance and cleaning of the equipment.
- ensure that all employees who use the equipment have read and understood the manual. Furthermore the users are to be regularly schooled in working with the equipment and the possible dangers.
- provide all personnel who work with the equipment with the designated and recommended safety equipment

Furthermore, the operator is responsible for ensuring that the device is at all times technically fit for use.

### 1.7.4 User requirements

Any activity with equipment of this type may only be performed by persons who are able to work correctly and reliably and satisfy the requirements of the job.

- Persons whose reaction capability is negatively influenced by e. g. drugs, alcohol or medication may not operate the equipment.
- Age or job related regulations valid at the operating site must always be applied.



#### **Danger for unqualified users**

Improper operation can cause person or object damage. Only persons who have the necessary training, knowledge and experience may use the equipment.

**Delegated persons** are those who have been properly and demonstrably instructed in their tasks and the attendant dangers.

**Qualified persons** are those who are able through training, knowledge and experience as well as knowledge of the specific details to carry out all the required tasks, identify dangers and avoid personal and other risks.



## 1.7.5 Alarm signals

The equipment offers various possibilities for signalling alarm conditions, however, not for danger situations. The signals may be optical (on the display as text), acoustic (piezo buzzer) or electronic (pin/status output of an analog interface). All alarms will cause the device to switch off the DC output.

The meaning of the signals is as follows:

Signal <b>OT</b> (OverTemperature)	<ul style="list-style-type: none"> <li>• Overheating of the device</li> <li>• DC output will be switched off</li> <li>• Non-critical</li> </ul>
Signal <b>OVP</b> (OverVoltage)	<ul style="list-style-type: none"> <li>• Overvoltage shutdown of the DC output due to high voltage entering the device or generated by the device itself due to a defect</li> <li>• Critical! The device and/or the load could be damaged</li> </ul>
Signal <b>OCP</b> (OverCurrent)	<ul style="list-style-type: none"> <li>• Shutdown of the DC output due to excess of the preset limit</li> <li>• Non-critical, protects the load from excessive current consumption</li> </ul>
Signal <b>OPP</b> (OverPower)	<ul style="list-style-type: none"> <li>• Shutdown of the DC output due to excess of the preset limit</li> <li>• Non-critical, protects the load from excessive power consumption</li> </ul>
Signal <b>PF</b> (Power Fail)	<ul style="list-style-type: none"> <li>• DC output shutdown due to AC undervoltage or defect in the AC input</li> <li>• Critical on overvoltage! AC input circuit could be damaged</li> </ul>

## 1.8 Technical Data

### 1.8.1 Approved operating conditions

- Use only inside dry buildings
- Ambient temperature 0-50°C
- Operational altitude: max. 2000 m above sea level
- Max. 80% relative humidity, non-condensing

### 1.8.2 General technical data

Display: Colour TFT touch screen with gorilla glass, 4.3", 480pt x 272pt, capacitive

Controls: 2 rotary knobs with pushbutton functions, 2 pushbutton

The nominal values for the device determine the maximum adjustable ranges.

## 1.8.3 Specific technical data

320 W	Model		
	PSI 9040-20 DT	PSI 9080-10 DT	PSI 9200-04 DT
<b>AC supply</b>			
Voltage range	90...264 V AC		
Connection	1ph,N,PE		
Frequency	45-65 Hz		
Fusing	MT 8 A		
Leak current	< 3.5 mA		
Inrush current @ 230 V	≈ 23 A		
Power factor	≈ 0.99		
<b>DC output</b>			
Max. output voltage $U_{Max}$	40.8 V	81.6 V	204 V
Max. output current $I_{Max}$	20 A	10 A	4 A
Max. output power $P_{Max}$	320 W	320 W	320 W
Overvoltage protection range	0...44 V	0...88 V	0...220 V
Overcurrent protection range	0...22 A	0...11 A	0...4.4 A
Overpower protection range	0...352 W	0...352 W	0...352 W
Output capacitance	4760 $\mu$ F	3400 $\mu$ F	720 $\mu$ F
Temperature coefficient for set values $\Delta/K$	Voltage / current: 100 ppm		
<b>Voltage regulation</b>			
Adjustment range	0...40.8 V	0...81.6 V	0...204 V
Accuracy <sup>(1)</sup> (at 23 $\pm$ 5°C)	< 0.1% $U_{Max}$	< 0.1% $U_{Max}$	< 0.1% $U_{Max}$
Line regulation at $\pm 10\%$ $\Delta U_{AC}$	< 0.02% $U_{Max}$	< 0.02% $U_{Max}$	< 0.02% $U_{Max}$
Load regulation at 0... 100% load	< 0.05% $U_{Max}$	< 0.05% $U_{Max}$	< 0.05% $U_{Max}$
Rise time 0... 100% (@full load)	Max. 30 ms	Max. 60 ms	Max. 65 ms
Settling time after load step	< 1.5 ms	< 1.5 ms	< 1.5 ms
Display: Resolution	See section „1.9.5.4. Resolution of the displayed values“		
Display: Accuracy <sup>(3)</sup>	$\leq 0.2\%$ $U_{Max}$	$\leq 0.2\%$ $U_{Max}$	$\leq 0.2\%$ $U_{Max}$
Ripple <sup>(2)</sup>	< 8 mV <sub>PP</sub> < 0.8 mV <sub>RMS</sub>	< 8 mV <sub>PP</sub> < 0.8 mV <sub>RMS</sub>	< 20 mV <sub>PP</sub> < 2.5 mV <sub>RMS</sub>
Remote sensing compensation	Max. 5% $U_{Max}$	Max. 5% $U_{Max}$	Max. 5% $U_{Max}$
Output voltage fall time (at no load) after switching DC output off	-	Down from 100% to <60 V: less than 10 s	
<b>Current regulation</b>			
Adjustment range	0...20,4 A	0...10,2 A	0...4,08 A
Accuracy <sup>(1)</sup> (at 23 $\pm$ 5°C)	< 0.2% $I_{Max}$	< 0.2% $I_{Max}$	< 0.2% $I_{Max}$
Line regulation at $\pm 10\%$ $\Delta U_{AC}$	< 0.05% $I_{Max}$	< 0.05% $I_{Max}$	< 0.05% $I_{Max}$
Load regulation at 0... 100% $\Delta U_{OUT}$	< 0.15% $I_{Max}$	< 0.15% $I_{Max}$	< 0.15% $I_{Max}$
Ripple <sup>(2)</sup>	< 1 mA <sub>RMS</sub>	< 1 mA <sub>RMS</sub>	< 1,5 mA <sub>RMS</sub>
Display: Resolution	See section „1.9.5.4. Resolution of the displayed values“		
Display: Accuracy <sup>(3)</sup>	$\leq 0.2\%$ $I_{Max}$	$\leq 0.2\%$ $I_{Max}$	$\leq 0.2\%$ $I_{Max}$
<b>Power regulation</b>			
Adjustment range	0...326.4 W	0...326.4 W	0...326.4 W
Accuracy <sup>(1)</sup> (at 23 $\pm$ 5°C)	< 1% $P_{Max}$	< 1% $P_{Max}$	< 1% $P_{Max}$
Line regulation at $\pm 10\%$ $\Delta U_{AC}$	< 0.05% $P_{Max}$	< 0.05% $P_{Max}$	< 0.05% $P_{Max}$
Load reg. at 10-90% $\Delta U_{OUT}$ * $\Delta I_{OUT}$	< 0.75% $P_{Max}$	< 0.75% $P_{Max}$	< 0.75% $P_{Max}$

(1) Related to the nominal values, the accuracy defines the maximum deviation between an adjusted values and the true (actual) value.

(2) RMS value: LF 0...300 kHz, PP value: HF 0...20 MHz

(3) The display error adds to the error of the related actual value on the DC output

<b>320 W</b>	<i>Model</i>		
	<i>PSI 9040-20 DT</i>	<i>PSI 9080-10 DT</i>	<i>PSI 9200-04 DT</i>
<b>Power regulation</b>			
Display: Resolution	See section „1.9.5.4. Resolution of the displayed values“		
Display: Accuracy <sup>(2)</sup>	≤ 0.8% P <sub>Max</sub>	≤ 0.8% P <sub>Max</sub>	≤ 0.8% P <sub>Max</sub>
Efficiency <sup>(4)</sup>	≤ 92%	≤ 92%	≤ 93%
<b>Internal resistance regulation</b>			
Adjustment range	0...81.6 Ω	0...163.2 Ω	0...979.2 Ω
Accuracy <sup>(1)</sup>	≤ 1% of max. resistance ± 0.3% of maximum current		
Display: Resolution	See section „1.9.5.4. Resolution of the displayed values“		
<b>Analog interface <sup>(3)</sup></b>			
Set value inputs	U, I, P, R		
Actual value output	U, I		
Control signals	DC on/off, remote control on/off, resistance mode on/off		
Status signals	CV, OVP, OCP, OPP, OT, PF, DC on/off		
Galvanic isolation to the device	Max. 400 V <sub>DC</sub>		
<b>Insulation</b>			
Output (DC) to enclosure (PE)	DC minus: permanent max. ±400 V DC plus: permanent max. ±400 V + output voltage		
Input (AC) to output (DC)	Max. 2500 V, short-term		
<b>Miscellaneous</b>			
Cooling	Temperature controlled fan, side inlet, rear exhaust		
Ambient temperature	0..50°C		
Storage temperature	-20...70°C		
Humidity	< 80%, not condensing		
Standards	EN 61000-6-2:2016-05, EN 61000-6-3:2011-09 Class B		
Overvoltage category	2		
Protection class	1		
Pollution degree	2		
Operational altitude	< 2000 m		
<b>Digital interfaces</b>			
Featured	1x USB-B for communication, 1x USB-A for functions, 1x LAN for communication		
Galvanic isolation from device	Max. 400 V <sub>DC</sub>		
<b>Terminals</b>			
Rear side	AC input, analog interface, USB-B, Ethernet		
Front side	DC output, USB-A, remote sensing		
<b>Dimensions</b>			
Enclosure (WxHxD)	276 x 103 x 355 mm		
Total (WxHxD)	308 x max. 195 x min. 391 mm		
<b>Weight</b>	≈ 7.5 kg	≈ 7.5 kg	≈ 7.5 kg
<b>Article number</b>	06200500	06200501	06200502

(1) Related to the nominal values, the accuracy defines the maximum deviation between an adjusted values and the true (actual) value.

(2) The display error adds to the error of the related actual value on the DC output

(3) For technical specifications of the analog interface see „3.5.4.4 Analog interface specification“ on page 56

(4) Typical value at 100% output voltage and 100% power

640 W	Model		
	PSI 9040-40 DT	PSI 9080-20 DT	PSI 9200-10 DT
<b>AC supply</b>			
Voltage range	90...264 V AC		
Connection	1ph,N,PE		
Frequency	45-65 Hz		
Fusing	MT 8 A		
Leak current	< 3.5 mA		
Inrush current @ 230 V	≈ 23 A		
Power factor	≈ 0.99		
<b>DC output</b>			
Max. output voltage $U_{Max}$	40 V	80 V	200 V
Max. output current $I_{Max}$	40 A	20 A	10 A
Max. output power $P_{Max}$	640 W	640 W	640 W
Overvoltage protection range	0...44 V	0...88 V	0...220 V
Overcurrent protection range	0...44 A	0...22 A	0...11 A
Overpower protection range	0...704 W	0...704 W	0...704 W
Output capacitance	4760 $\mu$ F	3400 $\mu$ F	720 $\mu$ F
Temperature coefficient for set values $\Delta/K$	Voltage / current: 100 ppm		
<b>Voltage regulation</b>			
Adjustment range	0...40.8 V	0...81.6 V	0...204 V
Accuracy <sup>(1)</sup> (at 23 $\pm$ 5°C)	< 0.1% $U_{Max}$	< 0.1% $U_{Max}$	< 0.1% $U_{Max}$
Line regulation at $\pm 10\%$ $\Delta U_{AC}$	< 0.02% $U_{Max}$	< 0.02% $U_{Max}$	< 0.02% $U_{Max}$
Load regulation at 0...100% load	< 0.05% $U_{Max}$	< 0.05% $U_{Max}$	< 0.05% $U_{Max}$
Rise time 0...100% (@full load)	Max. 30 ms	Max. 60 ms	Max. 65 ms
Settling time after load step	< 1.5 ms	< 1.5 ms	< 1.5 ms
Display: Resolution	See section „1.9.5.4. Resolution of the displayed values“		
Display: Accuracy <sup>(3)</sup>	$\leq$ 0.2% $U_{Max}$	$\leq$ 0.2% $U_{Max}$	$\leq$ 0.2% $U_{Max}$
Ripple <sup>(2)</sup>	< 8 mV <sub>PP</sub> < 0.8 mV <sub>RMS</sub>	< 8 mV <sub>PP</sub> < 0.8 mV <sub>RMS</sub>	< 20 mV <sub>PP</sub> < 2.5 mV <sub>RMS</sub>
Remote sensing compensation	Max. 5% $U_{Max}$	Max. 5% $U_{Max}$	Max. 5% $U_{Max}$
Output voltage fall time (at no load) after switching DC output off	-	Down from 100% to <60 V: less than 10 s	
<b>Current regulation</b>			
Adjustment range	0...40.8 A	0...20.4 A	0...10.2 A
Accuracy <sup>(1)</sup> (at 23 $\pm$ 5°C)	< 0.2% $I_{Max}$	< 0.2% $I_{Max}$	< 0.2% $I_{Max}$
Line regulation at $\pm 10\%$ $\Delta U_{AC}$	< 0.05% $I_{Max}$	< 0.05% $I_{Max}$	< 0.05% $I_{Max}$
Load regulation at 0...100% $\Delta U_{OUT}$	< 0.15% $I_{Max}$	< 0.15% $I_{Max}$	< 0.15% $I_{Max}$
Ripple <sup>(2)</sup>	< 1 mA <sub>RMS</sub>	< 1 mA <sub>RMS</sub>	< 1.5 mA <sub>RMS</sub>
Display: Resolution	See section „1.9.5.4. Resolution of the displayed values“		
Display: Accuracy <sup>(3)</sup>	$\leq$ 0.2% $I_{Max}$	$\leq$ 0.2% $I_{Max}$	$\leq$ 0.2% $I_{Max}$
<b>Power regulation</b>			
Adjustment range	0...652.8 W	0...652.8 W	0...652.8 W
Accuracy <sup>(1)</sup> (at 23 $\pm$ 5°C)	< 1% $P_{Max}$	< 1% $P_{Max}$	< 1% $P_{Max}$
Line regulation at $\pm 10\%$ $\Delta U_{AC}$	< 0.05% $P_{Max}$	< 0.05% $P_{Max}$	< 0.05% $P_{Max}$
Load reg. at 10-90% $\Delta U_{OUT}$ * $\Delta I_{OUT}$	< 0.75% $P_{Max}$	< 0.75% $P_{Max}$	< 0.75% $P_{Max}$

(1) Related to the nominal values, the accuracy defines the maximum deviation between an adjusted values and the true (actual) value.

(2) RMS value: LF 0...300 kHz, PP value: HF 0...20 MHz

(3) The display error adds to the error of the related actual value on the DC output

<b>640 W</b>	<i>Model</i>		
	<i>PSI 9040-40 DT</i>	<i>PSI 9080-20 DT</i>	<i>PSI 9200-10 DT</i>
<b>Power regulation</b>			
Display: Resolution	See section „1.9.5.4. Resolution of the displayed values“		
Display: Accuracy <sup>(2)</sup>	≤ 0.8% P <sub>Max</sub>	≤ 0.8% P <sub>Max</sub>	≤ 0.8% P <sub>Max</sub>
Efficiency <sup>(4)</sup>	≤ 92%	≤ 92%	≤ 93%
<b>Internal resistance regulation</b>			
Adjustment range	0...40.8 Ω	0...81.6 Ω	0...489.6 Ω
Accuracy <sup>(1)</sup>	≤ 1% of max. resistance ± 0.3% of maximum current		
Display: Resolution	See section „1.9.5.4. Resolution of the displayed values“		
<b>Analog interface <sup>(3)</sup></b>			
Set value inputs	U, I, P, R		
Actual value output	U, I		
Control signals	DC on/off, remote control on/off, resistance mode on/off		
Status signals	CV, OVP, OCP, OPP, OT, PF, DC on/off		
Galvanic isolation to the device	Max. 400 V <sub>DC</sub>		
<b>Insulation</b>			
Output (DC) to enclosure (PE)	DC minus: permanent max. ±400 V DC plus: permanent max. ±400 V + output voltage		
Input (AC) to output (DC)	Max. 2500 V, short-term		
<b>Miscellaneous</b>			
Cooling	Temperature controlled fan, side inlet, rear exhaust		
Ambient temperature	0..50°C		
Storage temperature	-20...70°C		
Humidity	< 80%, not condensing		
Standards	EN 61000-6-2:2016-05, EN 61000-6-3:2011-09 Class B		
Overvoltage category	2		
Protection class	1		
Pollution degree	2		
Operational altitude	< 2000 m		
<b>Digital interfaces</b>			
Featured	1x USB-B for communication, 1x USB-A for functions, 1x LAN for communication		
Galvanic isolation from device	Max. 400 V <sub>DC</sub>		
<b>Terminals</b>			
Rear side	AC input, analog interface, USB-B, Ethernet		
Front side	DC output, USB-A, remote sensing		
<b>Dimensions</b>			
Enclosure (WxHxD)	276 x 103 x 355 mm		
Total (WxHxD)	308 x max. 195 x min. 391 mm		
<b>Weight</b>	≈ 7.5 kg	≈ 7.5 kg	≈ 7.5 kg
<b>Article number</b>	06200503	06200504	06200505

(1) Related to the nominal values, the accuracy defines the maximum deviation between an adjusted values and the true (actual) value.

(2) The display error adds to the error of the related actual value on the DC output

(3) For technical specifications of the analog interface see „3.5.4.4 Analog interface specification“ on page 56

(4) Typical value at 100% output voltage and 100% power

1000 W	Model		
	PSI 9040-40 DT	PSI 9080-40 DT	PSI 9200-15 DT
<b>AC supply</b>			
Voltage range	90...264 V AC		
Connection	1ph,N,PE		
Frequency	45-65 Hz		
Fusing	T 16 A		
Leak current	< 3.5 mA		
Inrush current @ 230 V	≈ 23 A		
Power factor	≈ 0.99		
<b>DC output</b>			
Max. output voltage $U_{Max}$	40 V	80 V	200 V
Max. output current $I_{Max}$	40 A	40 A	15 A
Max. output power $P_{Max}$	1000 W	1000 W	1000 W
Overvoltage protection range	0...44 V	0...88 V	0...220 V
Overcurrent protection range	0...44 A	0...44 A	0...16.5 A
Overpower protection range	0...1100 W	0...1100 W	0...1100 W
Output capacitance	6120 $\mu$ F	6120 $\mu$ F	1020 $\mu$ F
Temperature coefficient for set values $\Delta/K$	Voltage / current: 100 ppm		
<b>Voltage regulation</b>			
Adjustment range	0...40.8 V	0...81.6 V	0...204 V
Accuracy <sup>(1)</sup> (at 23 $\pm$ 5°C)	< 0.1% $U_{Max}$	< 0.1% $U_{Max}$	< 0.1% $U_{Max}$
Line regulation at $\pm 10\%$ $\Delta U_{AC}$	< 0.02% $U_{Max}$	< 0.02% $U_{Max}$	< 0.02% $U_{Max}$
Load regulation at 0...100% load	< 0.05% $U_{Max}$	< 0.05% $U_{Max}$	< 0.05% $U_{Max}$
Rise time 0...100% (@full load)	Max. 40 ms	Max. 40 ms	Max. 40 ms
Settling time after load step	< 1.5 ms	< 1.5 ms	< 1.5 ms
Display: Resolution	See section „1.9.5.4. Resolution of the displayed values“		
Display: Accuracy <sup>(3)</sup>	$\leq 0.2\%$ $U_{Max}$	$\leq 0.2\%$ $U_{Max}$	$\leq 0.2\%$ $U_{Max}$
Ripple <sup>(2)</sup>	< 10 mV <sub>PP</sub> < 1.5 mV <sub>RMS</sub>	< 10 mV <sub>PP</sub> < 1.5 mV <sub>RMS</sub>	< 60 mV <sub>PP</sub> < 9 mV <sub>RMS</sub>
Remote sensing compensation	Max. 5% $U_{Max}$	Max. 5% $U_{Max}$	Max. 5% $U_{Max}$
Output voltage fall time (at no load) after switching DC output off	-	Down from 100% to <60 V: less than 10 s	
<b>Current regulation</b>			
Adjustment range	0...40.8 A	0...40.8 A	0...15.3 A
Accuracy <sup>(1)</sup> (at 23 $\pm$ 5°C)	< 0.2% $I_{Max}$	< 0.2% $I_{Max}$	< 0.2% $I_{Max}$
Line regulation at $\pm 10\%$ $\Delta U_{AC}$	< 0.05% $I_{Max}$	< 0.05% $I_{Max}$	< 0.05% $I_{Max}$
Load regulation at 0...100% $\Delta U_{OUT}$	< 0.15% $I_{Max}$	< 0.15% $I_{Max}$	< 0.15% $I_{Max}$
Ripple <sup>(2)</sup>	< 6 mA <sub>RMS</sub>	< 6 mA <sub>RMS</sub>	< 1.8 mA <sub>RMS</sub>
Display: Resolution	See section „1.9.5.4. Resolution of the displayed values“		
Display: Accuracy <sup>(3)</sup>	$\leq 0.2\%$ $I_{Max}$	$\leq 0.2\%$ $I_{Max}$	$\leq 0.2\%$ $I_{Max}$
<b>Power regulation</b>			
Adjustment range	0...1020 W	0...1020 W	0...1020 W
Accuracy <sup>(1)</sup> (at 23 $\pm$ 5°C)	< 1% $P_{Max}$	< 1% $P_{Max}$	< 1% $P_{Max}$
Line regulation at $\pm 10\%$ $\Delta U_{AC}$	< 0.05% $P_{Max}$	< 0.05% $P_{Max}$	< 0.05% $P_{Max}$
Load reg. at 10-90% $\Delta U_{OUT}$ * $\Delta I_{OUT}$	< 0.75% $P_{Max}$	< 0.75% $P_{Max}$	< 0.75% $P_{Max}$

(1) Related to the nominal values, the accuracy defines the maximum deviation between an adjusted values and the true (actual) value.

(2) RMS value: LF 0...300 kHz, PP value: HF 0...20 MHz

(3) The display error adds to the error of the related actual value on the DC output

<b>1000 W</b>	<i>Model</i>		
	<i>PSI 9040-40 DT</i>	<i>PSI 9080-40 DT</i>	<i>PSI 9200-15 DT</i>
<b>Power regulation</b>			
Display: Resolution	See section „1.9.5.4. Resolution of the displayed values“		
Display: Accuracy <sup>(2)</sup>	≤ 0.8% P <sub>Max</sub>	≤ 0.8% P <sub>Max</sub>	≤ 0.8% P <sub>Max</sub>
Efficiency <sup>(4)</sup>	≤ 92%	≤ 92%	≤ 92%
<b>Internal resistance regulation</b>			
Adjustment range	0...30.6 Ω	0...61.2 Ω	0...367.2 Ω
Accuracy <sup>(1)</sup>	≤ 1% of max. resistance ± 0.3% of maximum current		
Display: Resolution	See section „1.9.5.4. Resolution of the displayed values“		
<b>Analog interface <sup>(3)</sup></b>			
Set value inputs	U, I, P, R		
Actual value output	U, I		
Control signals	DC on/off, remote control on/off, resistance mode on/off		
Status signals	CV, OVP, OCP, OPP, OT, PF, DC on/off		
Galvanic isolation to the device	Max. 400 V <sub>DC</sub>		
<b>Insulation</b>			
Output (DC) to enclosure (PE)	DC minus: permanent max. ±400 V DC plus: permanent max. ±400 V + output voltage		
Input (AC) to output (DC)	Max. 2500 V, short-term		
<b>Miscellaneous</b>			
Cooling	Temperature controlled fan, side inlet, rear exhaust		
Ambient temperature	0..50°C		
Storage temperature	-20...70°C		
Humidity	< 80%, not condensing		
Standards	EN 61000-6-2:2016-05, EN 61000-6-3:2011-09 Class B		
Overvoltage category	2		
Protection class	1		
Pollution degree	2		
Operational altitude	< 2000 m		
<b>Digital interfaces</b>			
Featured	1x USB-B for communication, 1x USB-A for functions, 1x LAN for communication		
Galvanic isolation from device	Max. 400 V <sub>DC</sub>		
<b>Terminals</b>			
Rear side	AC input, analog interface, USB-B, Ethernet		
Front side	DC output, USB-A, remote sensing		
<b>Dimensions</b>			
Enclosure (WxHxD)	276 x 103 x 415 mm		
Total (WxHxD)	308 x max. 195 x min. 451 mm		
<b>Weight</b>	8.15 kg	8.15 kg	8.15 kg
<b>Article number</b>	06200517	06200506	06200507

(1) Related to the nominal values, the accuracy defines the maximum deviation between an adjusted values and the true (actual) value.

(2) The display error adds to the error of the related actual value on the DC output

(3) For technical specifications of the analog interface see „3.5.4.4 Analog interface specification“ on page 56

(4) Typical value at 100% output voltage and 100% power

<b>1000 W</b>	<i>Model</i>		
	<i>PSI 9360-10 DT</i>	<i>PSI 9500-06 DT</i>	<i>PSI 9750-04 DT</i>
<b>AC supply</b>			
Voltage range	90...264 V AC		
Connection	1ph,N,PE		
Frequency	45-65 Hz		
Fusing	T 16 A		
Leak current	< 3.5 mA		
Inrush current @ 230 V	≈ 23 A		
Power factor	≈ 0.99		
<b>DC output</b>			
Max. output voltage $U_{Max}$	360 V	500 V	750 V
Max. output current $I_{Max}$	10 A	6 A	4 A
Max. output power $P_{Max}$	1000 W	1000 W	1000 W
Overvoltage protection range	0...396 V	0...550 V	0...825 V
Overcurrent protection range	0...11 A	0...6.6 A	0...4.4 A
Overpower protection range	0...1100 W	0...1100 W	0...1100 W
Output capacitance	430 $\mu$ F	130 $\mu$ F	50 $\mu$ F
Temperature coefficient for set values $\Delta/K$	Voltage / current: 100 ppm		
<b>Voltage regulation</b>			
Adjustment range	0...367.2 V	0...510 V	0...765 V
Accuracy <sup>(1)</sup> (at 23 $\pm$ 5°C)	< 0.1% $U_{Max}$	< 0.1% $U_{Max}$	< 0.1% $U_{Max}$
Line regulation at $\pm 10\%$ $\Delta U_{AC}$	< 0.02% $U_{Max}$	< 0.02% $U_{Max}$	< 0.02% $U_{Max}$
Load regulation at 0...100% load	< 0.05% $U_{Max}$	< 0.05% $U_{Max}$	< 0.05% $U_{Max}$
Rise time 0...100% (@full load)	Max. 75 ms	Max. 30 ms	Max. 30 ms
Settling time after load step	< 1.5 ms	< 1.5 ms	< 1.5 ms
Display: Resolution	See section „1.9.5.4. Resolution of the displayed values“		
Display: Accuracy <sup>(3)</sup>	$\leq 0.2\%$ $U_{Max}$	$\leq 0.2\%$ $U_{Max}$	$\leq 0.2\%$ $U_{Max}$
Ripple <sup>(2)</sup>	< 58 mV <sub>PP</sub> < 11 mV <sub>RMS</sub>	< 62 mV <sub>PP</sub> < 13 mV <sub>RMS</sub>	< 94 mV <sub>PP</sub> < 16 mV <sub>RMS</sub>
Remote sensing compensation	Max. 5% $U_{Max}$	Max. 5% $U_{Max}$	Max. 5% $U_{Max}$
Output voltage fall time (at no load)after switching DC output off	Down from 100% to <60 V: less than 10 s		
<b>Current regulation</b>			
Adjustment range	0...10.2 A	0...6.12 A	0...4.08 A
Accuracy <sup>(1)</sup> (at 23 $\pm$ 5°C)	< 0.2% $I_{Max}$	< 0.2% $I_{Max}$	< 0.2% $I_{Max}$
Line regulation at $\pm 10\%$ $\Delta U_{AC}$	< 0.05% $I_{Max}$	< 0.05% $I_{Max}$	< 0.05% $I_{Max}$
Load regulation at 0...100% $\Delta U_{OUT}$	< 0.15% $I_{Max}$	< 0.15% $I_{Max}$	< 0.15% $I_{Max}$
Ripple <sup>(2)</sup>	< 2 mA <sub>RMS</sub>	< 8 mA <sub>RMS</sub>	< 10 mA <sub>RMS</sub>
Display: Resolution	See section „1.9.5.4. Resolution of the displayed values“		
Display: Accuracy <sup>(3)</sup>	$\leq 0.2\%$ $I_{Max}$	$\leq 0.2\%$ $I_{Max}$	$\leq 0.2\%$ $I_{Max}$
<b>Power regulation</b>			
Adjustment range	0...1020 W	0...1020 W	0...1020 W
Accuracy <sup>(1)</sup> (at 23 $\pm$ 5°C)	< 1% $P_{Max}$	< 1% $P_{Max}$	< 1% $P_{Max}$
Line regulation at $\pm 10\%$ $\Delta U_{AC}$	< 0.05% $P_{Max}$	< 0.05% $P_{Max}$	< 0.05% $P_{Max}$
Load reg. at 10-90% $\Delta U_{OUT}$ * $\Delta I_{OUT}$	< 0.75% $P_{Max}$	< 0.75% $P_{Max}$	< 0.75% $P_{Max}$

(1) Related to the nominal values, the accuracy defines the maximum deviation between an adjusted values and the true (actual) value.

(2) RMS value: LF 0...300 kHz, PP value: HF 0...20 MHz

(3) The display error adds to the error of the related actual value on the DC output



1000 W	Model		
	PSI 9360-10 DT	PSI 9500-06 DT	PSI 9750-04 DT
<b>Power regulation</b>			
Display: Resolution	See section „1.9.5.4. Resolution of the displayed values“		
Display: Accuracy <sup>(2)</sup>	≤ 0.8% P <sub>Max</sub>	≤ 0.8% P <sub>Max</sub>	≤ 0.8% P <sub>Max</sub>
Efficiency <sup>(4)</sup>	≤ 92%	≤ 92%	≤ 92%
<b>Internal resistance regulation</b>			
Adjustment range	0...1100.6 Ω	0...2295 Ω	0...5317.5 Ω
Accuracy <sup>(1)</sup>	≤ 1% of max. resistance ± 0.3% of maximum current		
Display: Resolution	See section „1.9.5.4. Resolution of the displayed values“		
<b>Analog interface <sup>(3)</sup></b>			
Set value inputs	U, I, P, R		
Actual value output	U, I		
Control signals	DC on/off, remote control on/off, resistance mode on/off		
Status signals	CV, OVP, OCP, OPP, OT, PF, DC on/off		
Galvanic isolation to the device	Max. 400 V <sub>DC</sub>		
<b>Insulation</b>			
Output (DC) to enclosure (PE)	DC minus: permanent max. ±400 V DC plus: permanent max. ±400 V + output voltage		
Input (AC) to output (DC)	Max. 2500 V, short-term		
<b>Miscellaneous</b>			
Cooling	Temperature controlled fan, side inlet, rear exhaust		
Ambient temperature	0..50°C		
Storage temperature	-20...70°C		
Humidity	< 80%, not condensing		
Standards	EN 61000-6-2:2016-05, EN 61000-6-3:2011-09 Class B		
Overvoltage category	2		
Protection class	1		
Pollution degree	2		
Operational altitude	< 2000 m		
<b>Digital interfaces</b>			
Featured	1x USB-B for communication, 1x USB-A for functions, 1x LAN for communication		
Galvanic isolation from device	Max. 400 V <sub>DC</sub>		
<b>Terminals</b>			
Rear side	AC input, analog interface, USB-B, Ethernet		
Front side	DC output, USB-A, remote sensing		
<b>Dimensions</b>			
Enclosure (WxHxD)	276 x 103 x 415 mm		
Total (WxHxD)	308 x max. 195 x min. 451 mm		
<b>Weight</b>	8.15 kg	8.15 kg	8.15 kg
<b>Article number</b>	06200508	06200509	06200510

(1) Related to the nominal values, the accuracy defines the maximum deviation between an adjusted values and the true (actual) value.

(2) The display error adds to the error of the related actual value on the DC output

(3) For technical specifications of the analog interface see „3.5.4.4 Analog interface specification“ on page 56

(4) Typical value at 100% output voltage and 100% power

<b>1500 W</b>	<i>Model</i>		
	<i>PSI 9040-60 DT</i>	<i>PSI 9080-60 DT</i>	<i>PSI 9200-25 DT</i>
<b>AC supply</b>			
Voltage range without derating	150...264 V AC		
Voltage range with derating	90...150 V AC		
Connection	1ph,N,PE		
Frequency	45-65 Hz		
Fusing	T 16 A		
Leak current	< 3.5 mA		
Inrush current @ 230 V	≈ 23 A		
Power factor	≈ 0.99		
<b>DC output</b>			
Max. output voltage $U_{Max}$	40 V	80 V	200 V
Max. output current $I_{Max}$	60 A	60 A	25 A
Max. output power $P_{Max}$	1500 W	1500 W	1500 W
Max. output power $P_{Max}$ with derating	1000 W	1000 W	1000 W
Overvoltage protection range	0...44 V	0...88 V	0...220 V
Overcurrent protection range	0...66 A	0...66 A	0...27,5 A
Overpower protection range	0...1650 W	0...1650 W	0...1650 W
Output capacitance	6120 $\mu$ F	6120 $\mu$ F	1020 $\mu$ F
Temperature coefficient for set values $\Delta/K$	Voltage / current: 100 ppm		
<b>Voltage regulation</b>			
Adjustment range	0...40.8 V	0...81.6 V	0...204 V
Accuracy <sup>(1)</sup> (at 23 $\pm$ 5°C)	< 0.1% $U_{Max}$	< 0.1% $U_{Max}$	< 0.1% $U_{Max}$
Line regulation at $\pm 10\%$ $\Delta U_{AC}$	< 0.02% $U_{Max}$	< 0.02% $U_{Max}$	< 0.02% $U_{Max}$
Load regulation at 0...100% load	< 0.05% $U_{Max}$	< 0.05% $U_{Max}$	< 0.05% $U_{Max}$
Rise time 0...100% (@full load)	Max. 40 ms	Max. 40 ms	Max. 40 ms
Settling time after load step	< 1.5 ms	< 1.5 ms	< 1.5 ms
Display: Resolution	See section „1.9.5.4. Resolution of the displayed values“		
Display: Accuracy <sup>(3)</sup>	$\leq 0.2\%$ $U_{Max}$	$\leq 0.2\%$ $U_{Max}$	$\leq 0.2\%$ $U_{Max}$
Ripple <sup>(2)</sup>	< 10 mV <sub>PP</sub> < 1,5 mV <sub>RMS</sub>	< 10 mV <sub>PP</sub> < 1,5 mV <sub>RMS</sub>	< 60 mV <sub>PP</sub> < 9 mV <sub>RMS</sub>
Remote sensing compensation	Max. 5% $U_{Max}$	Max. 5% $U_{Max}$	Max. 5% $U_{Max}$
Output voltage fall time (at no load)after switching DC output off	-	Down from 100% to <60 V: less than 10 s	
<b>Current regulation</b>			
Adjustment range	0...61.2 A	0...61.2 A	0...25.5 A
Accuracy <sup>(1)</sup> (at 23 $\pm$ 5°C)	< 0.2% $I_{Max}$	< 0.2% $I_{Max}$	< 0.2% $I_{Max}$
Line regulation at $\pm 10\%$ $\Delta U_{AC}$	< 0.05% $I_{Max}$	< 0.05% $I_{Max}$	< 0.05% $I_{Max}$
Load regulation at 0...100% $\Delta U_{OUT}$	< 0.15% $I_{Max}$	< 0.15% $I_{Max}$	< 0.15% $I_{Max}$
Ripple <sup>(2)</sup>	< 6 mA <sub>RMS</sub>	< 6 mA <sub>RMS</sub>	< 1.8 mA <sub>RMS</sub>
Display: Resolution	See section „1.9.5.4. Resolution of the displayed values“		
Display: Accuracy <sup>(3)</sup>	$\leq 0.2\%$ $I_{Max}$	$\leq 0.2\%$ $I_{Max}$	$\leq 0.2\%$ $I_{Max}$
<b>Power regulation</b>			
Adjustment range	0...1530 W	0...1530 W	0...1530 W
Accuracy <sup>(1)</sup> (at 23 $\pm$ 5°C)	< 1% $P_{Max}$	< 1% $P_{Max}$	< 1% $P_{Max}$
Line regulation at $\pm 10\%$ $\Delta U_{AC}$	< 0.05% $P_{Max}$	< 0.05% $P_{Max}$	< 0.05% $P_{Max}$
Load reg. at 10-90% $\Delta U_{OUT}$ * $\Delta I_{OUT}$	< 0.75% $P_{Max}$	< 0.75% $P_{Max}$	< 0.75% $P_{Max}$

(1) Related to the nominal values, the accuracy defines the maximum deviation between an adjusted values and the true (actual) value.

(2) RMS value: LF 0...300 kHz, PP value: HF 0...20 MHz

(3) The display error adds to the error of the related actual value on the DC output

1500 W	Model		
	PSI 9040-60 DT	PSI 9080-60 DT	PSI 9200-25 DT
<b>Power regulation</b>			
Display: Resolution	See section „1.9.5.4. Resolution of the displayed values“		
Display: Accuracy <sup>(2)</sup>	≤ 0.8% P <sub>Max</sub>	≤ 0.8% P <sub>Max</sub>	≤ 0.8% P <sub>Max</sub>
Efficiency <sup>(4)</sup>	≤ 92%	≤ 92%	≤ 92%
<b>Internal resistance regulation</b>			
Adjustment range	0...20.4 Ω	0...40.8 Ω	0...244,8 Ω
Accuracy <sup>(1)</sup>	≤ 1% of max. resistance ± 0.3% of maximum current		
Display: Resolution	See section „1.9.5.4. Resolution of the displayed values“		
<b>Analog interface <sup>(3)</sup></b>			
Set value inputs	U, I, P, R		
Actual value output	U, I		
Control signals	DC on/off, remote control on/off, resistance mode on/off		
Status signals	CV, OVP, OCP, OPP, OT, PF, DC on/off		
Galvanic isolation to the device	Max. 400 V <sub>DC</sub>		
<b>Insulation</b>			
Output (DC) to enclosure (PE)	DC minus: permanent max. ±400 V DC plus: permanent max. ±400 V + output voltage		
Input (AC) to output (DC)	Max. 2500 V, short-term		
<b>Miscellaneous</b>			
Cooling	Temperature controlled fan, side inlet, rear exhaust		
Ambient temperature	0..50°C		
Storage temperature	-20...70°C		
Humidity	< 80%, not condensing		
Standards	EN 61000-6-2:2016-05, EN 61000-6-3:2011-09 Class B		
Overvoltage category	2		
Protection class	1		
Pollution degree	2		
Operational altitude	< 2000 m		
<b>Digital interfaces</b>			
Featured	1x USB-B for communication, 1x USB-A for functions, 1x LAN for communication		
Galvanic isolation from device	Max. 400 V <sub>DC</sub>		
<b>Terminals</b>			
Rear side	AC input, analog interface, USB-B, Ethernet		
Front side	DC output, USB-A, remote sensing		
<b>Dimensions</b>			
Enclosure (WxHxD)	276 x 103 x 415 mm		
Total (WxHxD)	308 x max. 195 x min. 451 mm		
<b>Weight</b>	8.15 kg	8.15 kg	8.15 kg
<b>Article number</b>	06200516	06200511	06200512

(1) Related to the nominal values, the accuracy defines the maximum deviation between an adjusted values and the true (actual) value.

(2) The display error adds to the error of the related actual value on the DC output

(3) For technical specifications of the analog interface see „3.5.4.4 Analog interface specification“ on page 56

(4) Typical value at 100% output voltage and 100% power

1500 W	Model		
	PSI 9360-15 DT	PSI 9500-10 DT	PSI 9750-06 DT
<b>AC supply</b>			
Voltage range without derating	150...264 V AC		
Voltage range with derating	90...150 V AC		
Connection	1ph,N,PE		
Frequency	45-65 Hz		
Fusing	T 16 A		
Leak current	< 3.5 mA		
Inrush current @ 230 V	≈ 23 A		
Power factor	≈ 0.99		
<b>DC output</b>			
Max. output voltage $U_{Max}$	360 V	500 V	750 V
Max. output current $I_{Max}$	15 A	10 A	6 A
Max. output power $P_{Max}$	1500 W	1500 W	1500 W
Max. output power $P_{Max}$ with derating	1000 W	1000 W	1000 W
Overvoltage protection range	0...396 V	0...550 V	0...825 V
Overcurrent protection range	0...16.5 A	0...11 A	0...6.6 A
Overpower protection range	0...1650 W	0...1650 W	0...1650 W
Output capacitance	430 $\mu$ F	130 $\mu$ F	50 $\mu$ F
Temperature coefficient for set values $\Delta/K$	Voltage / current: 100 ppm		
<b>Voltage regulation</b>			
Adjustment range	0...367.2 V	0...510 V	0...765 V
Accuracy <sup>(1)</sup> (at 23 $\pm$ 5°C)	< 0.1% $U_{Max}$	< 0.1% $U_{Max}$	< 0.1% $U_{Max}$
Line regulation at $\pm 10\%$ $\Delta U_{AC}$	< 0.02% $U_{Max}$	< 0.02% $U_{Max}$	< 0.02% $U_{Max}$
Load regulation at 0...100% load	< 0.05% $U_{Max}$	< 0.05% $U_{Max}$	< 0.05% $U_{Max}$
Rise time 0...100% (@full load)	Max. 75 ms	Max. 30 ms	Max. 30 ms
Settling time after load step	< 1.5 ms	< 1.5 ms	< 1.5 ms
Display: Resolution	See section „1.9.5.4. Resolution of the displayed values“		
Display: Accuracy <sup>(3)</sup>	$\leq$ 0.2% $U_{Max}$	$\leq$ 0.2% $U_{Max}$	$\leq$ 0.2% $U_{Max}$
Ripple <sup>(2)</sup>	< 58 mV <sub>PP</sub> < 11 mV <sub>RMS</sub>	< 62 mV <sub>PP</sub> < 13 mV <sub>RMS</sub>	< 94 mV <sub>PP</sub> < 16 mV <sub>RMS</sub>
Remote sensing compensation	Max. 5% $U_{Max}$	Max. 5% $U_{Max}$	Max. 5% $U_{Max}$
Output voltage fall time (at no load) after switching DC output off	Down from 100% to <60 V: less than 10 s		
<b>Current regulation</b>			
Adjustment range	0...15.3 A	0...10.2 A	0...6.12 A
Accuracy <sup>(1)</sup> (at 23 $\pm$ 5°C)	< 0.2% $I_{Max}$	< 0.2% $I_{Max}$	< 0.2% $I_{Max}$
Line regulation at $\pm 10\%$ $\Delta U_{AC}$	< 0.05% $I_{Max}$	< 0.05% $I_{Max}$	< 0.05% $I_{Max}$
Load regulation at 0...100% $\Delta U_{OUT}$	< 0.15% $I_{Max}$	< 0.15% $I_{Max}$	< 0.15% $I_{Max}$
Ripple <sup>(2)</sup>	< 2 mA <sub>RMS</sub>	< 8 mA <sub>RMS</sub>	< 10 mA <sub>RMS</sub>
Display: Resolution	See section „1.9.5.4. Resolution of the displayed values“		
Display: Accuracy <sup>(3)</sup>	$\leq$ 0.2% $I_{Max}$	$\leq$ 0.2% $I_{Max}$	$\leq$ 0.2% $I_{Max}$
<b>Power regulation</b>			
Adjustment range	0...1530 W	0...1530 W	0...1530 W
Accuracy <sup>(1)</sup> (at 23 $\pm$ 5°C)	< 1% $P_{Max}$	< 1% $P_{Max}$	< 1% $P_{Max}$
Line regulation at $\pm 10\%$ $\Delta U_{AC}$	< 0.05% $P_{Max}$	< 0.05% $P_{Max}$	< 0.05% $P_{Max}$
Load reg. at 10-90% $\Delta U_{OUT}$ * $\Delta I_{OUT}$	< 0.75% $P_{Max}$	< 0.75% $P_{Max}$	< 0.75% $P_{Max}$

(1) Related to the nominal values, the accuracy defines the maximum deviation between an adjusted values and the true (actual) value.

(2) RMS value: LF 0...300 kHz, PP value: HF 0...20 MHz

(3) The display error adds to the error of the related actual value on the DC output

1500 W	Model		
	PSI 9360-15 DT	PSI 9500-10 DT	PSI 9750-06 DT
<b>Power regulation</b>			
Display: Resolution	See section „1.9.5.4. Resolution of the displayed values“		
Display: Accuracy <sup>(2)</sup>	≤ 0.8% P <sub>Max</sub>	≤ 0.8% P <sub>Max</sub>	≤ 0.8% P <sub>Max</sub>
Efficiency <sup>(4)</sup>	≤ 93%	≤ 93%	≤ 93%
<b>Internal resistance regulation</b>			
Adjustment range	0...734.4 Ω	0...1530 Ω	0...3825 Ω
Accuracy <sup>(1)</sup>	≤ 1% of max. resistance ± 0.3% of maximum current		
Display: Resolution	See section „1.9.5.4. Resolution of the displayed values“		
<b>Analog interface <sup>(3)</sup></b>			
Set value inputs	U, I, P, R		
Actual value output	U, I		
Control signals	DC on/off, remote control on/off, resistance mode on/off		
Status signals	CV, OVP, OCP, OPP, OT, PF, DC on/off		
Galvanic isolation to the device	Max. 400 V <sub>DC</sub>		
<b>Insulation</b>			
Output (DC) to enclosure (PE)	DC minus: permanent max. ±400 V DC plus: permanent max. ±400 V + output voltage		
Input (AC) to output (DC)	Max. 2500 V, short-term		
<b>Miscellaneous</b>			
Cooling	Temperature controlled fan, side inlet, rear exhaust		
Ambient temperature	0..50°C		
Storage temperature	-20...70°C		
Humidity	< 80%, not condensing		
Standards	EN 61000-6-2:2016-05, EN 61000-6-3:2011-09 Class B		
Overvoltage category	2		
Protection class	1		
Pollution degree	2		
Operational altitude	< 2000 m		
<b>Digital interfaces</b>			
Featured	1x USB-B for communication, 1x USB-A for functions, 1x LAN for communication		
Galvanic isolation from device	Max. 400 V <sub>DC</sub>		
<b>Terminals</b>			
Rear side	AC input, analog interface, USB-B, Ethernet		
Front side	DC output, USB-A, remote sensing		
<b>Dimensions</b>			
Enclosure (WxHxD)	276 x 103 x 415 mm		
Total (WxHxD)	308 x max. 195 x min. 451 mm		
<b>Weight</b>	8.15 kg	8.15 kg	8.15 kg
<b>Article number</b>	06200513	06200514	06200515

(1) Related to the nominal values, the accuracy defines the maximum deviation between an adjusted values and the true (actual) value.

(2) The display error adds to the error of the related actual value on the DC output

(3) For technical specifications of the analog interface see „3.5.4.4 Analog interface specification“ on page 56

(4) Typical value at 100% output voltage and 100% power

## 1.8.4 Views

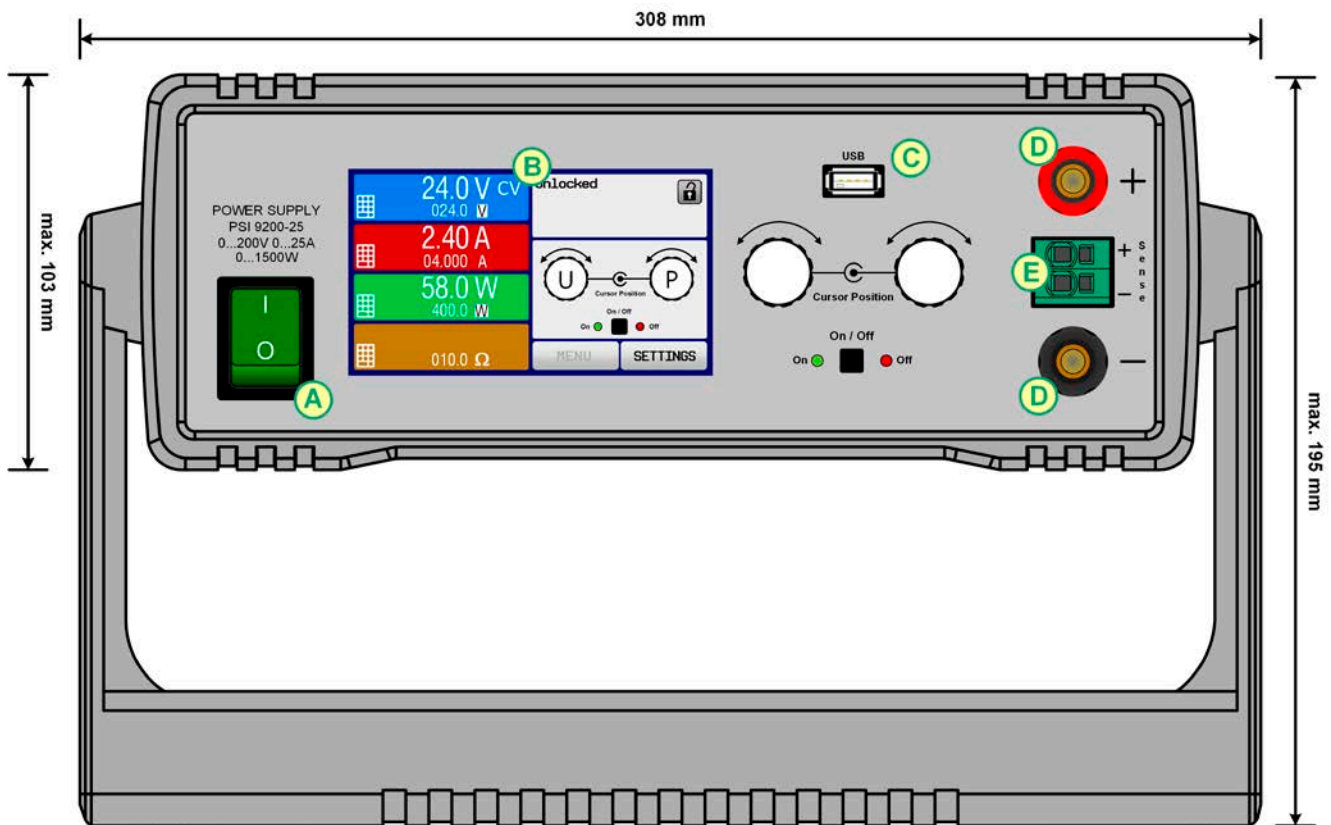

Figure 1 - Front (carrying handle vertical position)

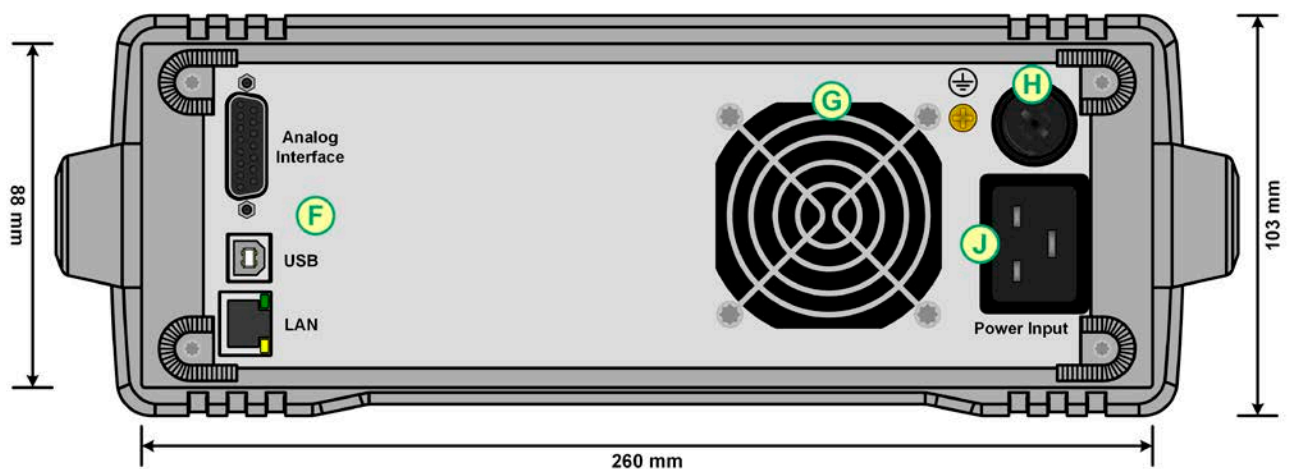

Figure 2 - Rear side (view of 1000 W / 1500 W models shown)



Do not loosen the grounding point (brass screw next to fuse holder H) in order to connect PE cables! The device is supposed to be grounded via the AC cord, while the grounding point is used to connect the enclosure to PE.

- A - Power switch
- B - Control panel
- C - USB port
- D - DC output
- E - Remote sensing connector

- F - Control interfaces (digital, analog)
- G - Exhaust
- H - AC input fuse
- J - AC input connection

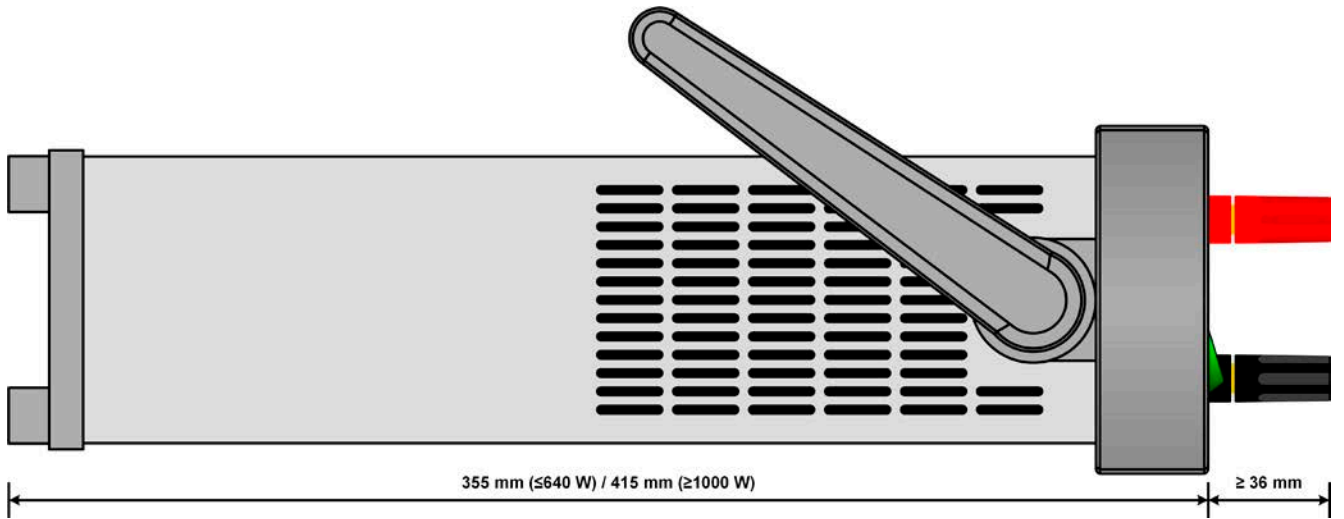

Figure 3 - Side view (with air inlets)

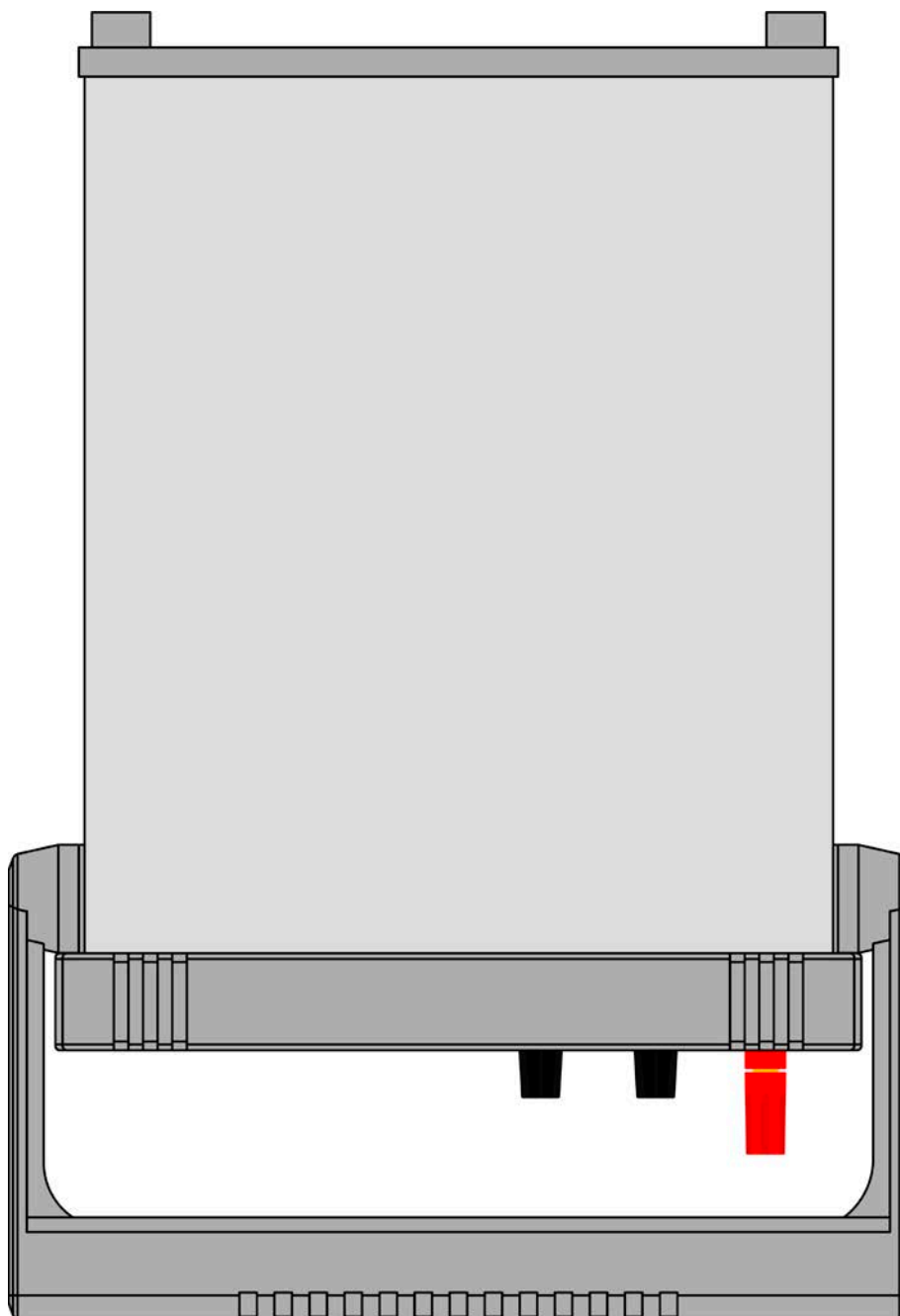

Figure 4 - View from above (320 W & 640 W models)

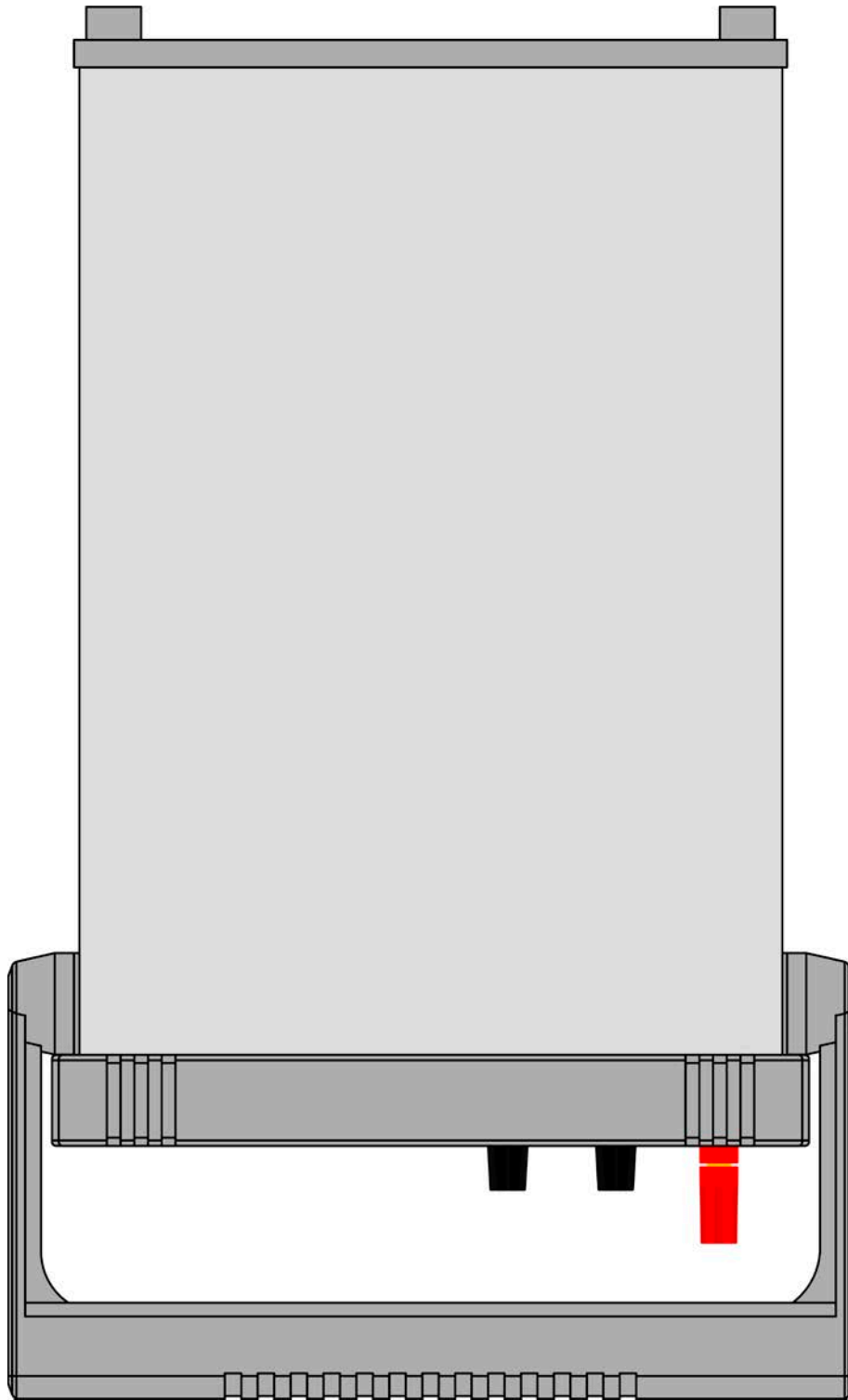

Figure 5 - View from above (1000 W & 1500 W models)



1.8.5 Control elements

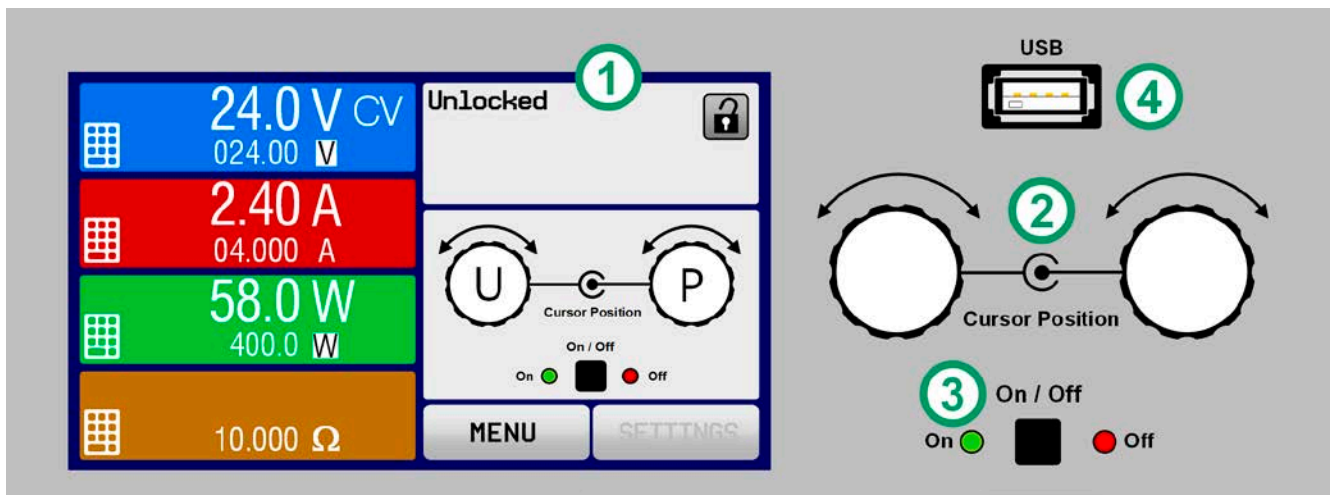

Figure 6 - Control Panel

Overview of the elements on the control panel

For a detailed description see section „1.9.5. The control panel (HMI)“.

(1)	<p><b>Touchscreen display</b></p> <p>Used for selection of set values, menus, status and display of actual values and status. The touchscreen can be operated with the fingers or with a stylus.</p>
(2)	<p><b>Rotary knob with push button function</b></p> <p>Left knob (turn): adjusting the voltage set value, or setting the parameter values in the menu.</p> <p>Left knob (push): selection of the decimal position to be changed (cursor) for the assigned value.</p> <p>Right knob (turn): adjusting the current, power or resistance set value, or setting parameter values in the menu.</p> <p>Right knob (push): selection of the decimal position to be changed (cursor) for the assigned value.</p>
(3)	<p><b>On/Off Button for DC output</b></p> <p>Used to toggle the DC output between on and off, also used to start a function run. The LEDs “On” and “Off” indicate the state of the DC output, no matter if the device is manually controlled or remotely</p>
(4)	<p><b>USB-A port</b></p> <p>For the connection of standard USB sticks. See section „1.9.5.5. USB port (front side)“ for more details.</p>

**1.9 Construction and function**

**1.9.1 General description**

The DC laboratory power supplies of the PSI 9000 DT series are especially suitable for the use in test and development applications, in laboratories, research and industry. The robust enclosure with its carrying handle, which also serves as tilt stand, adapts in shape and look to measuring devices of established manufacturers.

Apart from basic functions of power supplies, set point curves can be generated in the integrated function generator (sine, rectangular, triangular and other curve types). Arbitrary curves, consisting of up to 99 points, can be stored on or loaded from an USB stick.

For remote control using a PC or PLC the devices are provided as standard with an USB port and Ethernet (LAN) port on the rear side, as well as a galvanically isolated analog interface. The configuration of the interfaces, if necessary at all, is simple. All models are controlled by microprocessors.

**1.9.2 Block diagram**

The block diagram illustrates the main components inside the device and their relationships.

There are digital, microprocessor controlled components (KE, DR, HMI), which can be target of firmware updates.

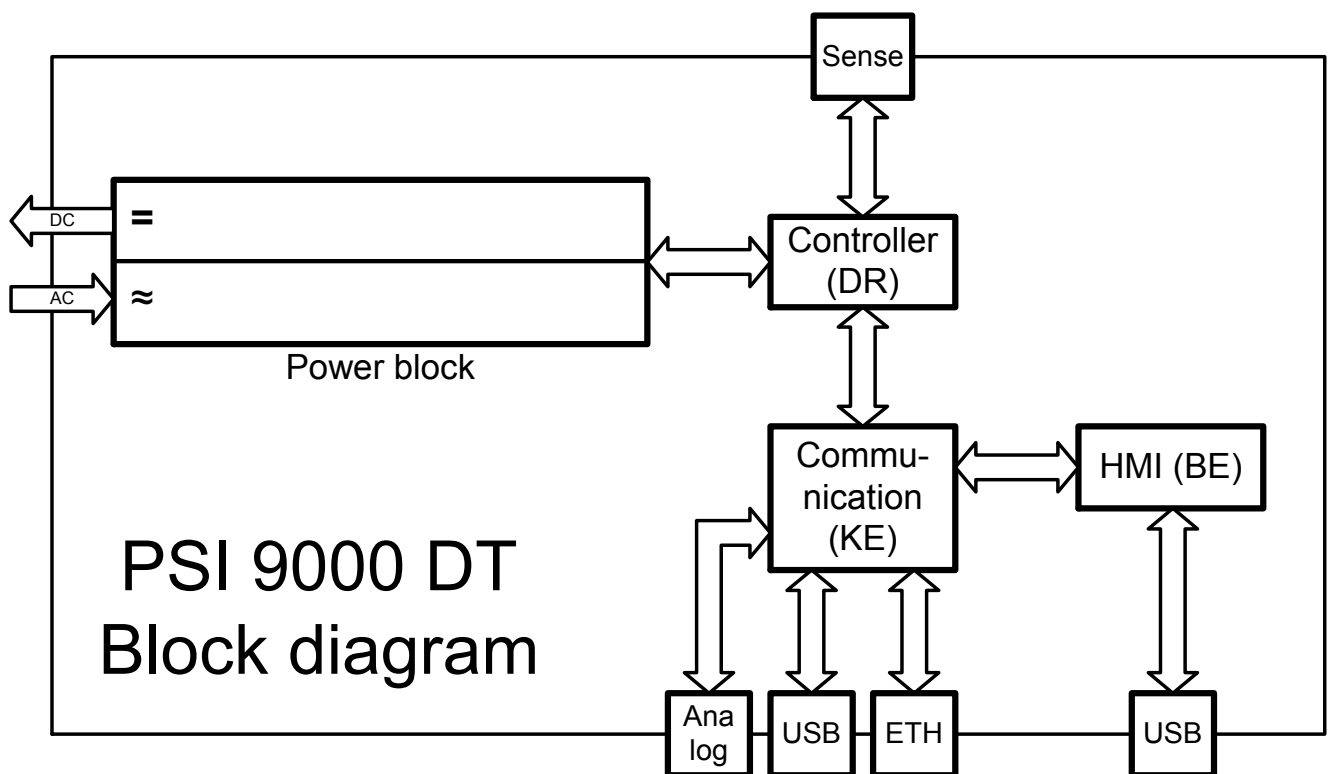

**1.9.3 Scope of delivery**

- 1 x Power supply device PSI 9000 DT
- 1 x 2 meter mains cord (with Schuko or UK or US plug, depending on shipping destination)
- 1 x USB cable, 1.8 m
- 1 x USB stick with software and documentation

**1.9.4 Optional accessories**

The below listed optional accessories can be purchased separately from the device and can be installed by the user:

<p><b>19" rack mount</b> Ordering nr. 10 400 111</p>	<p>Metal frame kit for the mount of one PSI 9000 DT device in a 19" system (cabinet, rack). Height: 2U.</p>
--	---

## 1.9.5 The control panel (HMI)

The HMI (Human Machine Interface) consists of a display with touchscreen, two rotary knobs, a pushbutton and an USB port.

### 1.9.5.1 Touchscreen display

The graphic touchscreen display is divided into a number of areas. The complete display is touch sensitive and can be operated by finger or stylus to control the equipment.

In normal operation the left hand side is used to show actual values and set values and the right hand side to display status information:

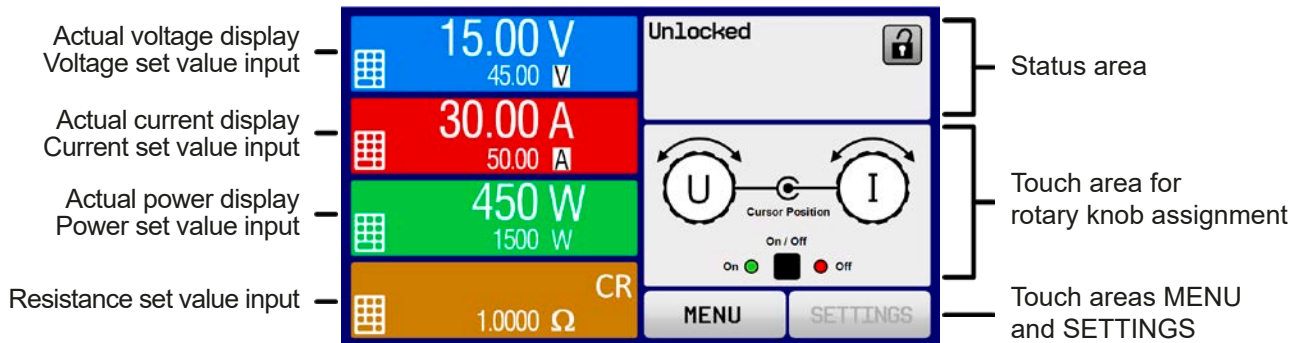

Touch areas may be enabled or disabled:



**MENU**

Black text or symbol = Enabled

**SETTINGS**

Grey text or symbol = Disabled

This applies to all touch areas on the main screen and all menu pages..

#### • Actual / set values area (left hand side)

In normal operation the DC output values (large numbers) and set values (small numbers) for voltage, current and power are displayed. Resistance set value of the variable internal resistance is only displayed by active resistance mode.

When the DC output is switched on, the actual regulation mode, **CV**, **CC**, **CP** or **CR** is displayed next to the corresponding actual values, as shown in the figure above

The set values can be adjusted with the rotary knobs next to the display screen or can be entered directly via the touchscreen. When adjusting with the knobs, pushing the knob will select the digit to be changed. Logically, the values are increased by clockwise turning and decreased by anti-clockwise turning.



General display and settings ranges:

Display	Unit	Range	Description
Actual voltage	V	0.2-125% $U_{Nom}$	Actual values of DC output voltage
Set value of voltage <sup>(1)</sup>	V	0-102% $U_{Nom}$	Set value for limiting the DC output voltage
Actual current	A	0.2-125% $I_{Nom}$	Actual value of DC output current
Set value of current <sup>(1)</sup>	A	0-102% $I_{Nom}$	Set value for limiting the DC output current
Actual power	W	0.2-125% $P_{Nom}$	Actual value of output power, $P = U * I$
Set value of power <sup>(1)</sup>	W	0-102% $P_{Nom}$	Set value for limiting DC output power
Set value of internal resistance	Ω	0-100% $R_{Max}$	Set value for the simulated internal resistance
Adjustment limits	A, V, W	0-102% nom	U-max, I-min etc., related to the physical values
Protection settings	A, V, W	0-110% nom	OVP, OCP etc., related to the physical values

<sup>(1)</sup> Valid also for values related to these physical quantities, such as OVD for voltage and UCD for current

## • Status display (upper right)

This area displays various status texts and symbols:

Display	Description
<b>Locked</b>	The HMI is locked
<b>Unlocked</b>	The HMI is unlocked
<b>Remote:</b>	The device is under remote control from....
<b>Analog</b>	....the built-in analog interface
<b>USB</b>	....the built-in USB port
<b>Ethernet</b>	....the built-in Ethernet port
<b>Local</b>	The device has been locked by the user explicitly against remote control
<b>Alarm:</b>	Alarm condition which has not been acknowledged or still exists.
<b>Event:</b>	A user defined event has occurred which isn't yet acknowledged.
<b>Function:</b>	Function generator activated, function loaded
 / 	Data logging to USB stick active or failed

## • Area for assigning the rotary knobs

The two rotary knobs next to the display screen can be assigned to various functions. This area shows the actual assignments. These can be changed by tapping this area, as long as it's not locked. The display changes to:

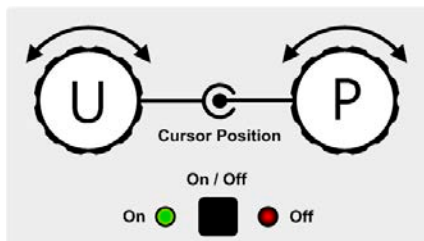

The physical quantities on the depiction of the knobs shows the momentary assignment. With a power supply, the left knob is always assigned to the voltage U, while the right knob can be switched by tapping the depiction.

The area can show one of these assignments:

**U I**

Left rotary knob: voltage  
Right rotary knob: current

**U P**

Left rotary knob: voltage  
Right rotary knob: power

**U R**

Left rotary knob: voltage  
Right rotary knob: resistance

The other set values can't be adjusted via the rotary knobs, unless the assignment is changed. However, values can be entered directly with a ten-key pad by tapping on the small icon . Alternatively to the knob depiction, the assignment can also be changed by tapping the coloured set value areas.

### 1.9.5.2 Rotary knobs

 As long as the device is in manual operation, the two rotary knobs are used to adjust set values, as well as setting the parameters in SETTINGS and MENU. For a detailed description of the individual functions see section „3.4 Manual operation“ on page 43.

### 1.9.5.3 Pushbutton function of the knobs

The rotary knobs also have a pushbutton function which is used in all value adjustment to move the cursor by rotation as shown:



## 1.9.5.4 Resolution of the displayed values

In the display, set values can be adjusted in fixed increments. The number of decimal places depends on the device model. The values have 4 or 5 digits. Actual and set values always have the same number of digits.

Adjustable resolution and display formats for the touch panel display:

Voltage, OVP, UVD, OVD, U-min, U-max			Current, OCP, UCD, OCD, I-min, I-max			Power, OPP, OPD, P-max			Resistance, R-max		
Nominal value	Digits	Min. step width	Nominal value	Digits	Min. step width	Nominal value	Digits	Min. step width	Nominal value	Digits	Min. step width
40 V / 80 V	4	0.01 V	4 A / 6 A	4	0.001 A	320 W	4	0.1 W	20 Ω - 80 Ω	5	0.001 Ω
200 V	5	0.01 V	10 A / 15 A	5	0.001 A	640 W	4	0.1 W	160 Ω - 960 Ω	5	0.01 Ω
360 V	4	0.1 V	20 A / 25 A	5	0.001 A	1000 W	4	1 W	1080 Ω - 5625 Ω	5	0.1 Ω
500 V	4	0.1 V	40 A / 60 A	4	0.01 A	1500 W	4	1 W			
750 V	4	0.1 V									



*In manual operation every set value can be set in the increments given above. In this case the actual output values set by the device will lie within percentage tolerances as shown in the technical data sheets. These will influence the actual values.*

## 1.9.5.5 USB port (front side)

The frontal USB port, located to the right of the rotary knobs, is intended to host standard USB sticks and can be used for loading or saving sequences for the arbitrary generator, as well as for data recording.

USB 2.0 sticks are accepted and must be **FAT32** formatted and have a **maximum capacity of 32GB**. USB 3.0 sticks also work, but not from all manufacturers.

All supported files must be held in a designated folder in the root path of the USB drive in order to be found. This folder must be named **HMI\_FILES**, such that a PC would recognise the path G:\HMI\_FILES if the drive were to be assigned the letter G.

The control panel of the device can read the following file types and names from an USB stick:

profile_<nr>.csv	Previously saved user profile. The number in the file name is a counter and not related to the actual user profile number in the HMI. A max. of 10 files to select from is shown when loading an user profile.
wave_u<arbitrary>.csv wave_i<arbitrary>.csv	Function generator arbitrary function for voltage (U) or current (I) The name must begin with <i>wave_u</i> / <i>wave_i</i> , the rest is user defined.

The control panel of the device can save the following file types and names to an USB stick:

profile_<nr>.csv	Saved user profile. The number in the file name is a counter and not related to the actual user profile number in the HMI. A max. of 10 files to select from is shown when loading an user profile.
usb_log_<nr>.csv	File with log data recorded during normal operation in all modes. The file layout is identical to the those generated from the Logging feature in EA Power Control. The <nr> field in the file name is automatically counted up if equally named files already exist in the folder.
wave_u<nr>.csv wave_i<nr>.csv	Function generator for an arbitrary function, 99 sequence points of either voltage (U) or current (I)

## 1.9.6 USB port (rear side)

The USB-B port on the back side of the device is provided for communication with the device and for firmware updates. The included USB cable can be used to connect the device to a PC (USB 2.0 or 3.0). The driver is delivered on the included USB stick and installs a virtual COM port. Details for remote control can be found on the included USB stick or on the web site of Elektro-Automatik.

The device can be addressed via this port either using the international standard ModBus protocol or by SCPI language. The device recognises the message protocol automatically.

If remote control is in operation the USB port has no priority over either the interface module (see below) or the analog interface and can, therefore, only be used alternatively to these. However, monitoring is always available.

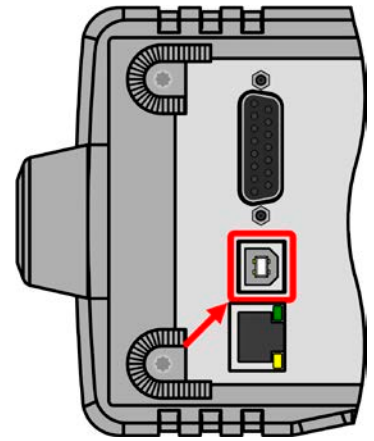

## 1.9.7 Ethernet port

The Ethernet port on the back side of the device is provided for communication with the device in terms of remote control or monitoring. The user has basically two options of access:

1. A website (HTTP, port 80) which is accessible in a standard browser under the IP or the host name given for the device. This website offers to configuration page for network parameters, as well as a input box for SCPI commands.
2. TCP/IP access via a freely selectable port (except 80 and other reserved ports). The standard port for this device is 5025. Via TCP/IP and this port, communication to the device can be established in most of the common programming languages.

Using the Ethernet port, the device can either be controlled by commands from SCPI or ModBus protocol, while automatically detecting the type of message.

The network setup can be done manually or by DHCP. The transmission speed is set to "Auto negotiation" and means it can use 10 MBit/s or 100 MBit/s. 1GB/s isn't supported. Duplex mode is always full duplex.

If remote control is in operation the Ethernet port has no priority over either the analog interface or the USB interface and can, therefore, only be used alternatively to these. However, monitoring is always available.

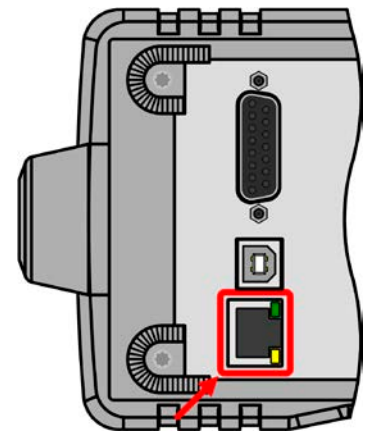

## 1.9.8 Analog interface

This 15 pole D-sub socket on the back side of the device is provided for remote control of the device via analog or digital signals.

If remote control is in operation this analog interface can only be used alternately to the digital interface. However, monitoring is always available.

The input voltage range of the set values and the output voltage range of the monitor values, as well as reference voltage level can be switched in the settings menu of the device between 0-5 V and 0-10 V, in each case for 0-100%.

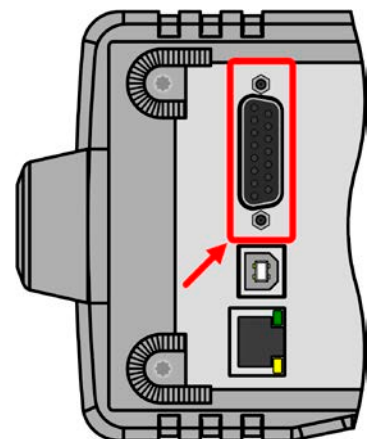

## 1.9.9 Sense connector (remote sensing)

In order to compensate for voltage drops along the DC cables to the load, the **Sense** input (between the DC output terminals) can be connected to the load. The device will automatically detect when the sense input is wired (Sense+) and compensate the output voltage accordingly.

The maximum possible compensation is given in the technical specifications.

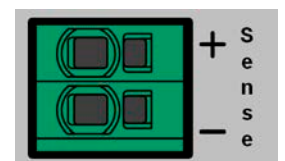

## 2. Installation & commissioning

### 2.1 Storage

#### 2.1.1 Packaging

It's recommended to keep the complete transport packaging for the lifetime of the device for relocation or return to the manufacturer for repair. Otherwise the packaging should be disposed of in an environmentally friendly way.

#### 2.1.2 Storage

In case of long term storage of the equipment it's recommended to use the original packaging or similar. Storage must be in dry rooms, if possible in sealed packaging, to avoid corrosion, especially internal, through humidity.

### 2.2 Unpacking and visual check

After every transport, with or without packaging, or before commissioning, the equipment should be visually inspected for damage and completeness using the delivery note and/or parts list (see section „1.9.3. Scope of delivery“). An obviously damaged device (e. g. loose parts inside, damage outside) must under no circumstances be put in operation.

### 2.3 Installation

#### 2.3.1 Safety procedures before installation and use



Before connecting to the mains ensure that the supply voltage is as shown on the product label. Overvoltage on the AC supply can cause equipment damage.

#### 2.3.2 Preparation

Mains connection for a PSI 9000 DT series device is done via the included 2 meters long 3 pole mains cord. In case a different AC wiring is required, make sure that the other cable has at least a cross section of 1.5 mm<sup>2</sup> (AWG 16) or better 2.5 mm<sup>2</sup> (AWG12) is used.

Dimensioning of the DC wiring to the load/consumer has to reflect the following:



- The cable cross section should always be selected for at least the maximum current of the device.
- Continuous operation at the approved limit generates heat which must be removed, as well as voltage loss which depends on cable length and heating. To compensate for these the cable cross section should be increased and/or the cable length reduced.

#### 2.3.3 Installing the device



- Select the location for the device so that the connection to the load is as short as possible.
- Leave sufficient space behind the equipment, minimum 30 cm, for ventilation.
- Never obstruct the air inlets on the sides!
- In case the handle is used to bring the device into an uplifted position, never place any objects onto the top of the unit!

## 2.3.3.1 The handle

The included handle isn't only used to carry the device, it can also uplift the device's front for easier access to knobs and buttons or better display readability.

The handle can be rotated into various positions in an angle of 300°, such as a variable position (60...150°), 0°, -45°, -90° and -150°.

It's rotated by pulling on both sides of the handle first in order to loosen the detent and then moving the handle around its axis.

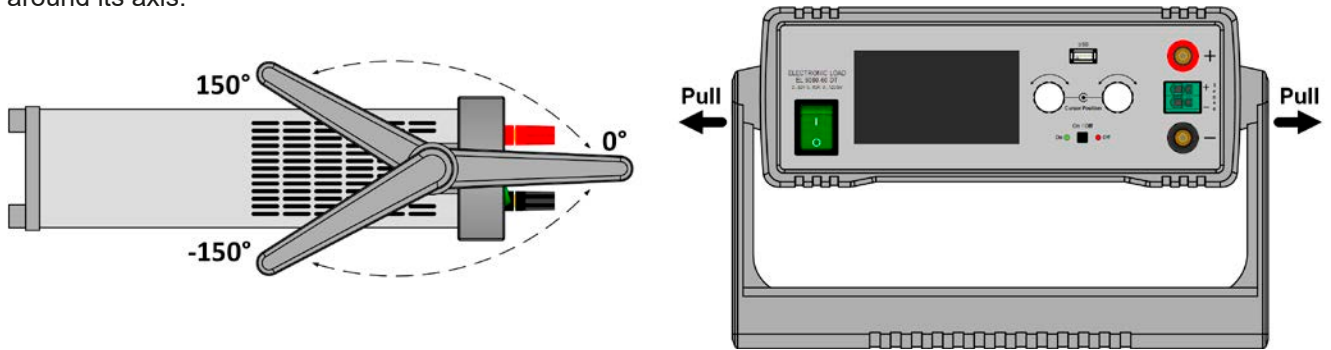

## 2.3.3.2 Placement on horizontal standing surfaces

The device is designed as a desktop unit and should only be operated in horizontal position on horizontal surfaces, which are capable of securely carrying the weight of the device.

Acceptable and unacceptable operating positions:

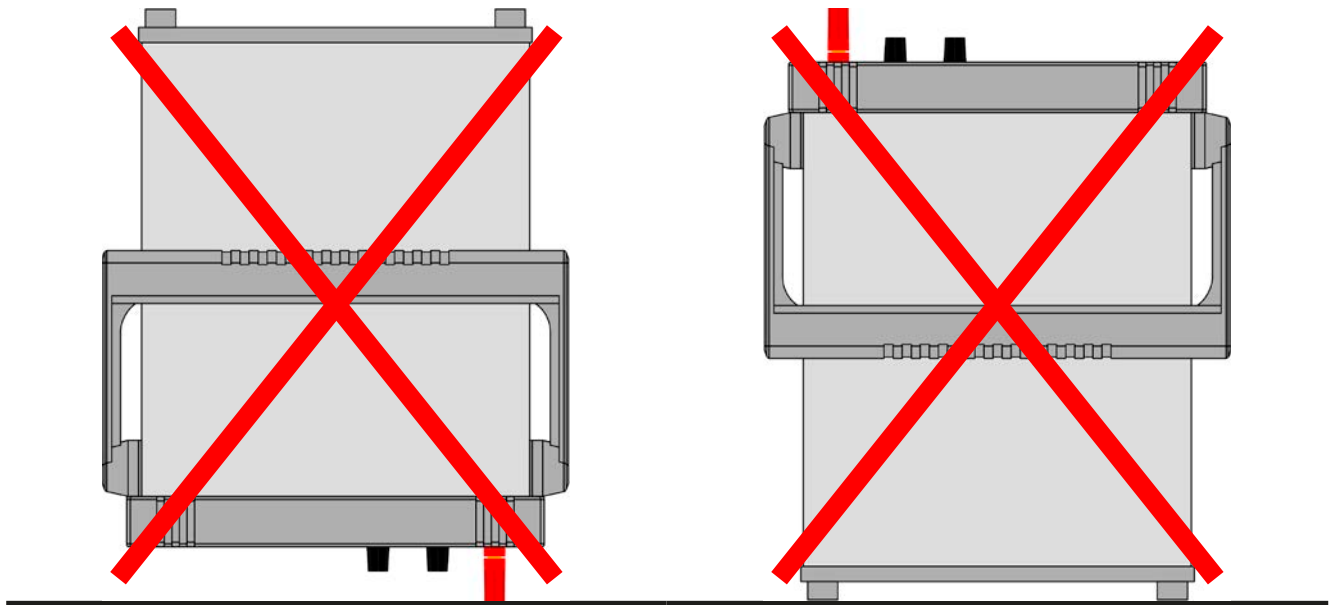

Standing surface

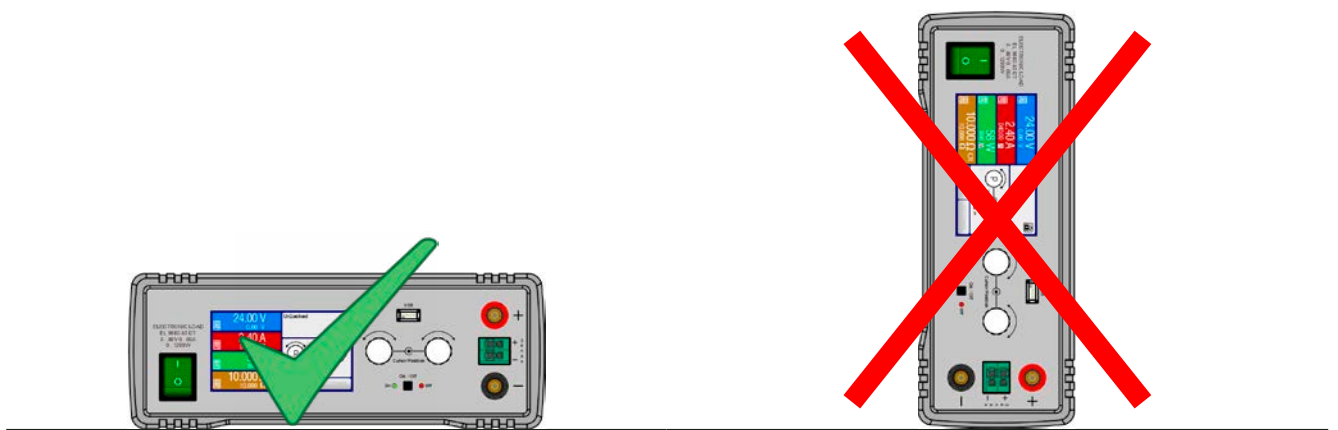

Standing surface



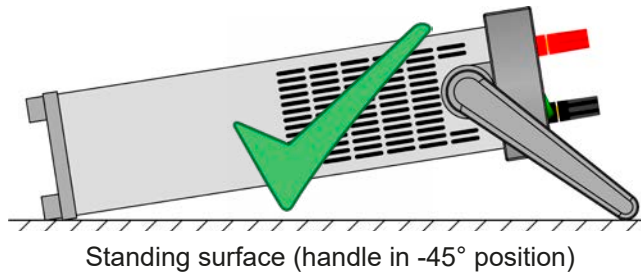

### 2.3.3.3 Installation in a 19" system

The optionally available 2U mounting frame (see 1.9.4) can be used to install the power supply in a 19" cabinet or other 19" related system with at least 2U of space. The frame will center the device horizontally on the front plate of the frame. The entire front of the device remains accessible.

Due to the relatively short depth of the DT housing, the rear side is probably or only hardly accessible once the frame is installed and tied. It's thus recommended to make all necessary connections before actually inserting the frame into the cabinet.



*The mounting frame requires to install and use support rails in the 19" system. The rear part of the frame is 449 mm wide and can rest on small rails capable of supporting the weight of the device.*

Recommended procedure (also see *Figure 7* to *Figure 10* below):

1. Remove the carrying handle from the power supply device:
  - a. Rotate the handle into -90° position. See *Figure 7* below.
  - b. Simultaneously pull on both sides of the handle until the axis can slip out of the housing (also see section 2.3.3.1).
2. Remove the front frame (1). Also remove the rear frame (1) by loosening the 4 screws.
3. Place the mounting brackets (2) and fix them with 2x screw M4x10 and 2x contact disc M4 each. Here it's recommended to use a 90° Torx screw driver (ratchet etc.).
4. Screw the 4 hex spacers (3) M3x10 into the threaded holes which were used to hold the rear frame (*Figure 10*).
5. Place the rear part of the mounting frame (4) on the hex spacers and fix it with 4 screws M3x6 and 4 lock washers M3 (5). Select the window which fits a PSI 9000 DT rear side layout (*Figure 11*).
6. If long enough, connect all rear side cables before inserting the frame. If the cables are not long enough, it's best to insert the frame into the 19" system first.
7. Fully insert the frame and tighten the front with typical 19" system front tightening screws (not included).
8. Connect the front side DC output to your load.

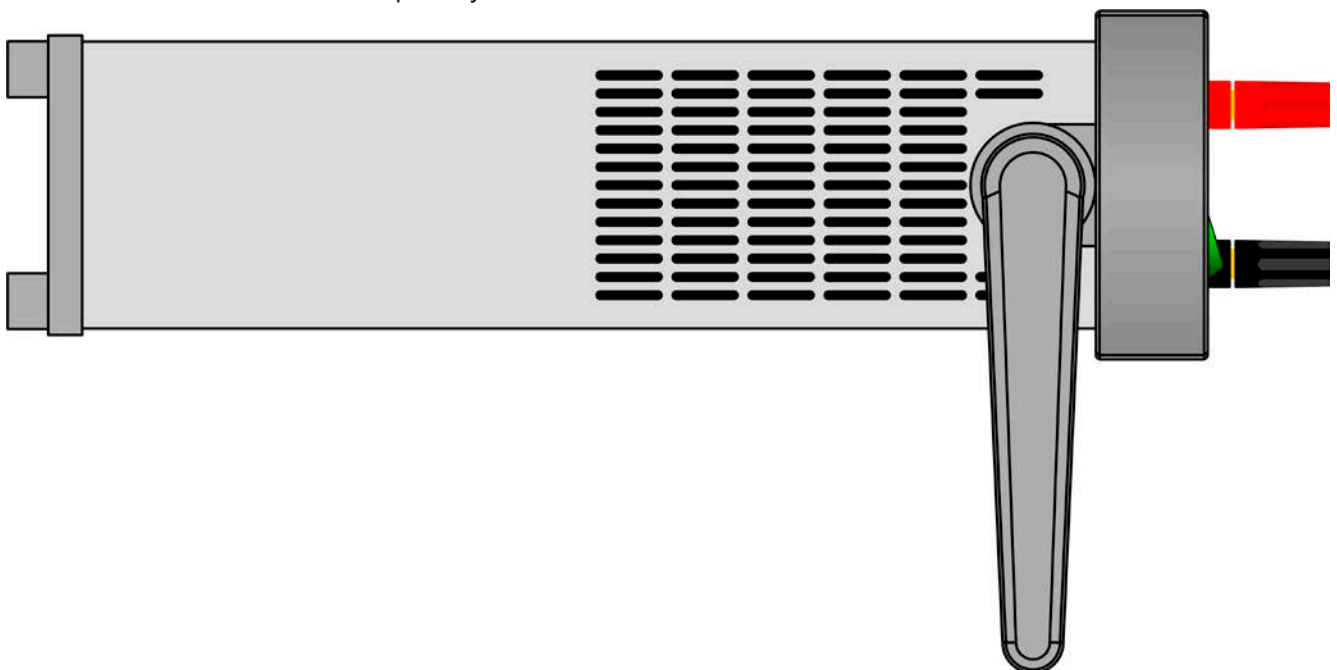

Figure 7 - Position (-90°) of the carrying handle for removal



Figure 8 - Removal of the front and rear frame

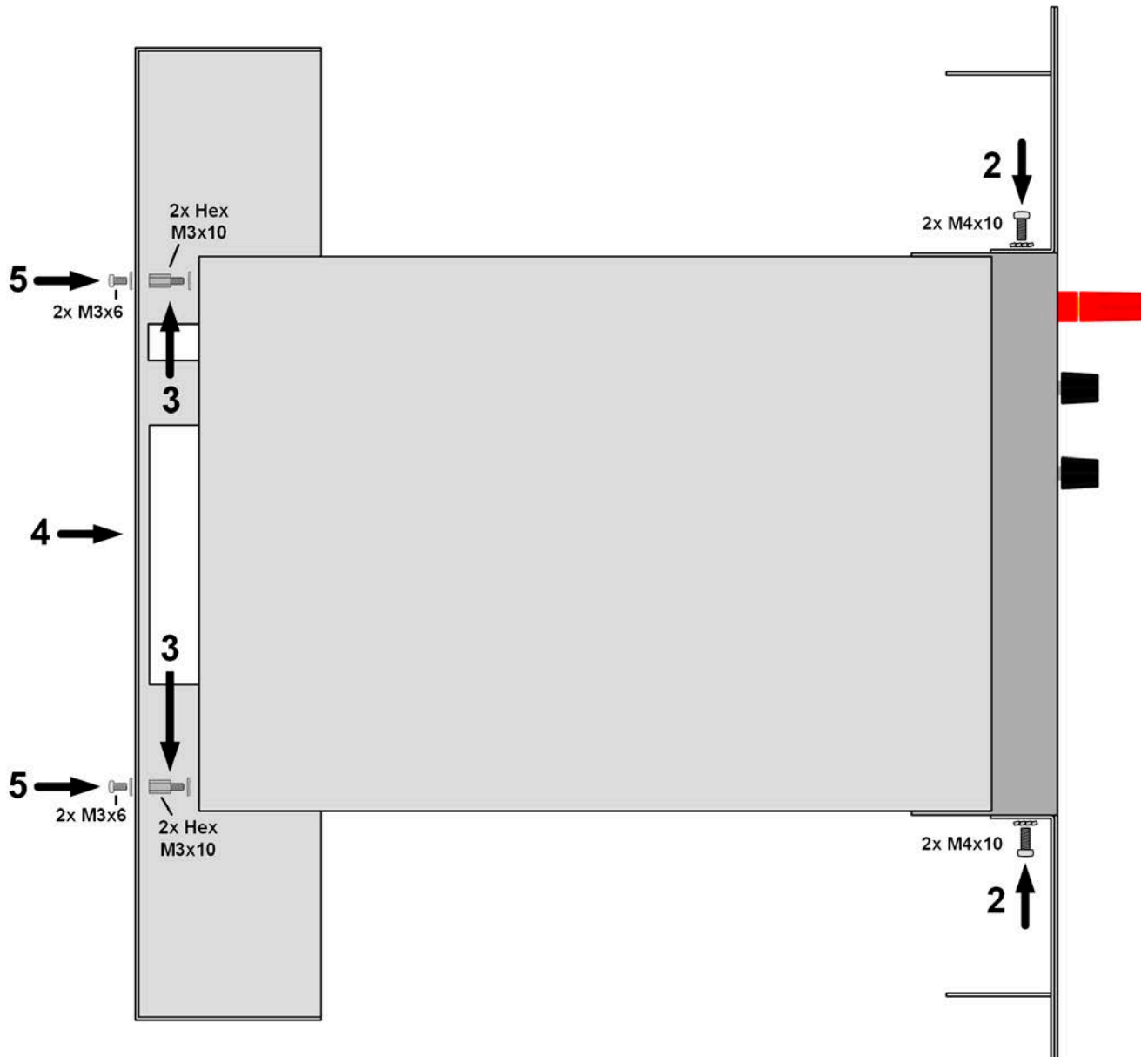

Figure 9 - Assembly steps for the mounting frame

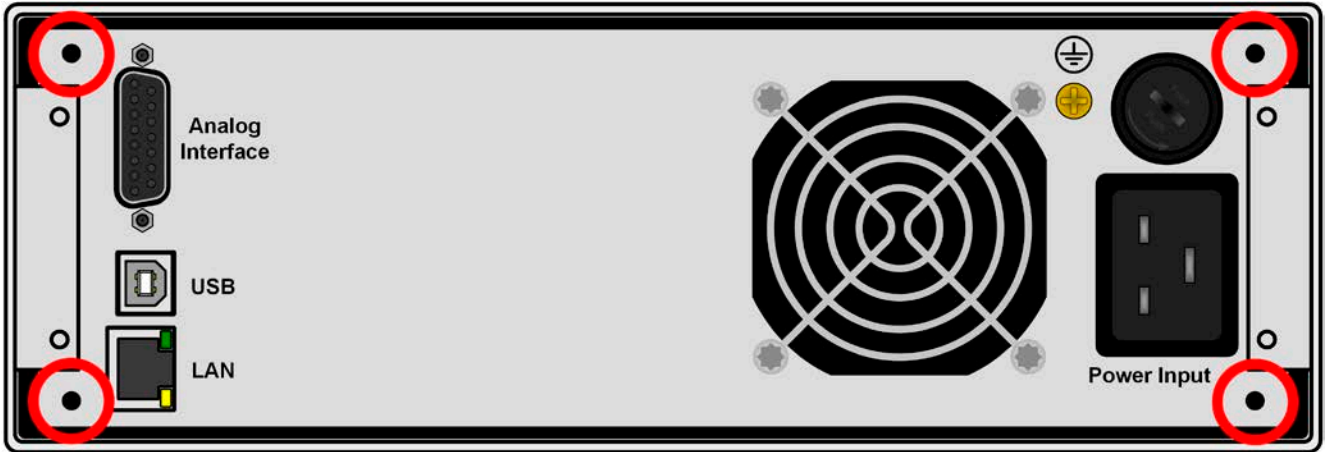

Figure 10 - Positions for the hex spacers (3) (1000 W / 1500 W models shown)

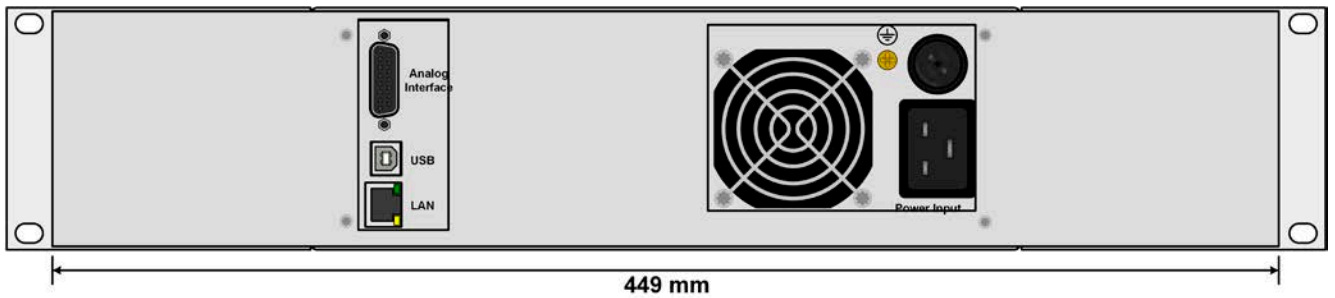

Figure 11 - Rear view after complete assembly of the mounting frame (1000 W / 1500 W models shown)

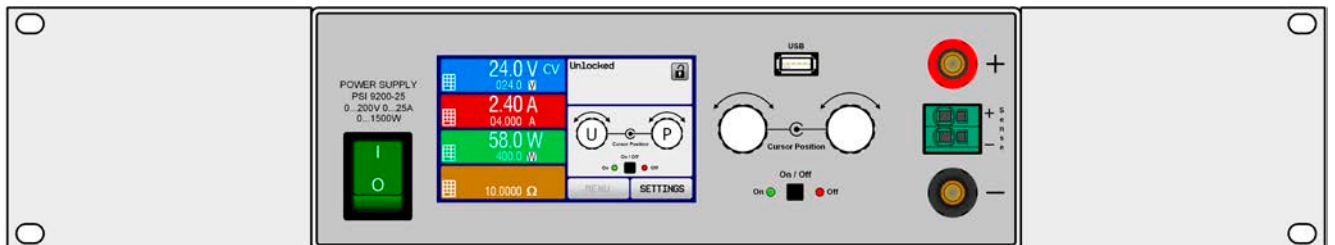

Figure 12 - Front view after complete assembly of the mounting frame

## 2.3.4 Connection to AC supply



- The device can be connected to any wall socket or multi-socket outlet, as long as those feature a grounding contact (PE) and are rated for at least 16 A.
- When connecting the device to a multi-socket outlet, along with other electric devices, it's important to consider the total power consumption of all devices on the outlet, so that the maximum current (power ÷ minimum voltage) does not exceed the definition for the wall socket, the multi-socket outlet and/or main distribution.
- Before plugging in the input plug ensure that the device is switched off by its mains switch!

The device is delivered with a 3 pole mains cord. If the device is going to be connected to a 2-phase or 3-phase supply, following phases are required:

Nominal power	Phases	Supply type
0.32 kW - 1.5 kW	L1 or L2 or L3, N, PE	Wall socket 16 A (UK: 13 A)

The default input values of all models in this series are: 230 V, 50 Hz. Depending on the model it's fused up to 16 A (for particular value see technical specifications). The maximum input current depends on the higher current intake at low AC voltage (for minimum input voltage see technical specifications). Custom made cables thus require to have a cross section of at least 1.5 mm<sup>2</sup> (AWG16) per lead, recommended are 2.5 mm<sup>2</sup> (AWG12).

## 2.3.5 Connection to DC loads



- Connection to and operation with transformerless DC-AC inverters (for example solar inverters) is restricted, because the inverter can shift the potential of negative output (DC-) against PE (ground), which is limited to max. ±400 V DC.
- When using any model which is rated for 40 A or higher current, attention has to be paid to where the load is connected on the DC output terminals. The front-side 4 mm connection point is only rated for **max. 32 A!**
- Connection of voltage sources which can generate a voltage higher than 110% nominal of the device model isn't allowed!
- Connection of voltage sources with reversed polarity isn't allowed!

The DC load output is on the front side of the device and isn't protected by a fuse. The cross section of the connection cable is determined by the current consumption, cable length and ambient temperature.

For cables **up to 5 m** and average ambient temperature up to 50°C, we recommend:

up to <b>10 A</b> :	0.75 mm <sup>2</sup> (AWG18)	up to <b>15 A</b> :	1.5 mm <sup>2</sup> (AWG14)
up to <b>20 A</b> :	2.5 mm <sup>2</sup> (AWG12)	up to <b>40 A</b> :	6 mm <sup>2</sup> (AWG8)
up to <b>60 A</b> :	16 mm <sup>2</sup> (AWG4)		

**per lead** (multi-conductor, insulated, openly suspended). Single cables of, for example, 16 mm<sup>2</sup> may be replaced by e. g. 2x 6 mm<sup>2</sup> etc. If the cables are long then the cross section must be increased to avoid voltage loss and overheating.

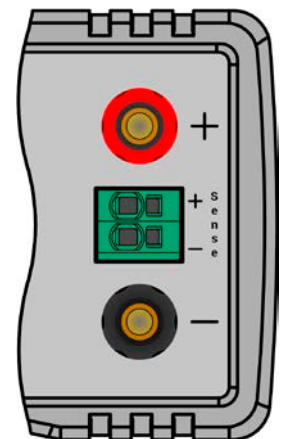

### 2.3.5.1 Possible connections on the DC output

The DC output on the front is of type clamp & plug and can be used with:

- 4 mm system plugs (Büschel, banana, safety) for **max. 32 A**
- Spade lugs (6 mm or bigger)
- Soldered cable ends (only recommended for small currents up to 10 A)

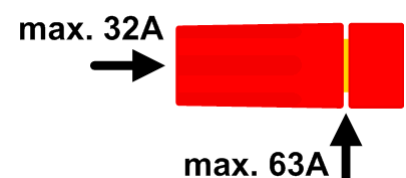

**When using any type of lugs or cable end sleeves, only use insulated ones in order to ensure electric shock protection when working with models rated 80 V or higher!**

### 2.3.6 Grounding of the DC output

Grounding one of the DC output poles is permissible, but causes potential shift against PE on the opposite pole. Because of insulation, there is a max. allowed potential shift defined for the DC output poles, which depends on the device model. Refer to „1.8.3. Specific technical data“

### 2.3.7 Connection of remote sensing



- Remote sensing is only effective during constant voltage operation (CV) and for other regulation modes the sense input should be disconnected, if possible, because connecting it generally increases the oscillation tendency.
- The cross section of the sense cables is noncritical. However, it should be increased with increasing cable length. Clamp terminal **Sense** is suitable for cross section of 0.2 mm<sup>2</sup> (AWG24) to 10 mm<sup>2</sup> (AWG8)
- Sense cables should be twisted and laid close to the DC cables to damp oscillation. If necessary, an additional capacitor can be installed at the load/consumer to eliminate oscillation
- The sense cables must be connected + to + and - to - at the load, otherwise both systems may be damaged

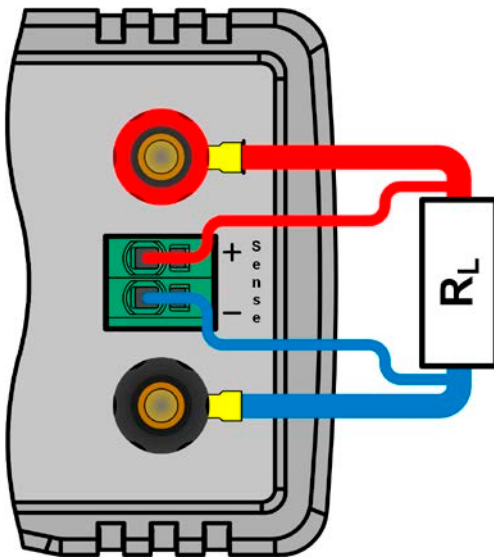

Figure 13 - Principle example for remote sensing wiring

The connector Sense is a clamp terminal. It means for the remote sensing cables:

- Insert cables: crimp sleeves onto the cable ends and simply push them into the bigger square hole
- Remove cables: use a small flat screwdriver and push into the smaller square hole next to the bigger one to loosen the cable clamp, then remove cable end

### 2.3.8 Connecting the analog interface

The 15 pole connector (type: D-sub) on the rear side is an analog interface. To connect this to a controlling hardware (PC, electronic circuit), a standard plug is necessary (not included in the scope of delivery). It's generally advisable to switch the device completely off before connecting or disconnecting this connector, but at least the DC output.

## 2.3.9 Connecting the USB port (rear side)

In order to remotely control the device via this port, connect the device to a PC using the included USB cable and switch the device on.

### 2.3.9.1 Driver installation (Windows)

On the initial connection with a PC the operating system will identify the device as new hardware and will start to install a driver. The required driver is for a Communication Device Class (CDC) device and is usually integrated in current operating systems such as Windows 7 or 10. However, it's strongly recommended to use and install the included driver (on USB stick) to gain full compatibility of the device to our softwares.

### 2.3.9.2 Driver installation (Linux, MacOS)

We can't provide drivers or installation instructions for these operating systems. Whether a suitable driver is available is best found out by searching the Internet. With newer versions of Linux or MacOS, a generic CDC driver should be "on board".

### 2.3.9.3 Alternative drivers

In case the CDC drivers described above are not available on your system, or for some reason do not function correctly, commercial suppliers can help. Search the Internet for suppliers using the keywords "cdc driver windows" or "cdc driver linux" or "cdc driver macos".

## 2.3.10 Initial commission

For the first start-up after installation of the device, the following procedures have to be executed:

- Confirm that the connection cables to be used are of a satisfactory cross section!
- Check if the factory settings of set values, safety and monitoring functions and communication are suitable for your intended application of the device and adjust them if required, as described in the manual!
- In case of remote control via PC, read the additional documentation for interfaces and software!
- In case of remote control via the analog interface, read the section in this manual concerning analog interfaces!

## 2.3.11 Commission after a firmware update or a long period of non-use

In case of a firmware update, return of the equipment following repair or a location or configuration change, similar measures should be taken to those of initial start up. Refer to „2.3.10. Initial commission“.

Only after successful checking of the device as listed may it be operated as usual.

### 3. Operation and application

#### 3.1 Personal safety



- In order to guarantee safety when using the device, it's essential that only persons operate the device who are fully acquainted and trained in the required safety measures to be taken when working with dangerous electrical voltages
- For models which can generate a hazardous voltages or are connected to such, all cables with lugs must use insulated ones. If necessary, install additional measures to protect against physical contact, such as a cover
- Whenever the load and DC output are being re-configured, the device should be switched off completely, not only the DC output!

#### 3.2 Operating modes

A power supply is internally controlled by different control circuits, which shall regulate voltage, current and power to the adjusted values and hold them constant, if possible. These circuits follow typical laws of control systems engineering, resulting in different operating modes. Each operating mode has its own characteristics which are explained below in short form.



- *Unloaded operation is not a normal operation mode of a power supply and can thus lead to false measurements, for example when calibrating the device*
- *The optimal working point of the device is between 50% and 100% voltage and current*
- *It's recommended to not run the device below 10% voltage and current in order to meet technical specification values like ripple or transient times*

##### 3.2.1 Voltage regulation / Constant voltage

Voltage regulation is also called constant voltage operation (short: CV).

The DC output voltage of a power supply is held constant at the adjusted value, unless the output current or the output power according to  $P = U_{OUT} \cdot I_{OUT}$  reaches the adjusted current or power limit. In both cases the device will automatically switch to constant current or constant power operation, whatever occurs first. Then the output voltage can't be held constant anymore and will sink to a value resulting from Ohm's law.

While the DC output is switched on and constant voltage mode is active, the condition "CV mode active" will be indicated on the graphic display by the abbreviation **CV** and also passed as a signal to the analog interface, as well stored as status which can be read via digital interface.

##### 3.2.1.1 Transient time after load step

For constant voltage mode (CV), the technical date "Settling time after load step" (see 1.8.3) defines a time that is required by the internal voltage regulator of the device to settle the output voltage after a load step. Negative load steps, i. e. high load to lower load, will cause the output voltage to overshoot for a short time until compensated by the voltage regulator. The same occurs with a positive load step, i. e. low load to high load. There the output collapses for a moment. The amplitude of the overshoot resp. collapse depends on the device model, the currently adjusted output voltage and the capacity on the DC output and can isn't stated as a specific technical value.

Depictions:

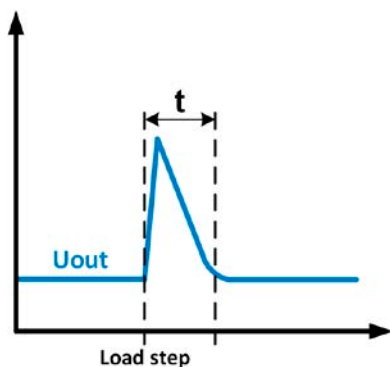

Example for neg. load step: the DC output will rise above the adjusted value for a short time.  $t$  = transient time to settle the output voltage.

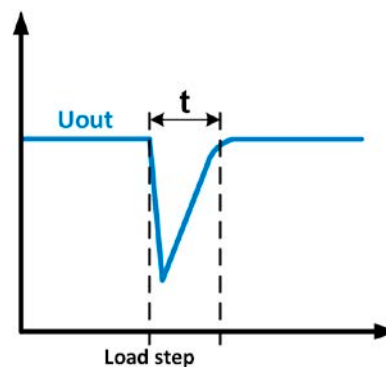

Example for pos. load step: the DC output will collapse below the adjusted value for a short time.  $t$  = transient time to settle the output voltage.

### 3.2.2 Current regulation / constant current / current limiting

Current regulation is also known as current limiting or constant current mode (short: CC).

The DC output current is held constant by the power supply as soon as the output current to the load reaches the adjusted limit. The power supply will then automatically switch to CC. The actual output current of the power supply is determined by the actual output voltage and the load's resistance. As long as the output current is lower than the adjusted current limit, the device will either be in constant voltage or constant power mode. If, however, the power consumption reaches the adjusted power value, the device will switch automatically to power limiting and set the output current according to  $I_{MAX} = P_{SET} / U_{IN}$ , unless the adjusted current set value value is lower. This set value is determined by the user and is always an upper limit only.

While the DC output is switched on and constant current mode is active, the condition "CC mode active" will be indicated on the graphic display by the abbreviation **CC** and also passed as signal "no CV" to the analog interface, as well stored as status which can be read via digital interface.

#### 3.2.2.1 Voltage overshootings

In certain situations it's possible that the device generates a voltage overshooting. Such situations are when the device is in CC, with the actual voltage being unregulated, and either a jump in the current set value is initiated which would bring the device out of CC or when the load is suddenly cut from the power supply by an external means. Peak and duration of the overshooting aren't exactly defined, but as rule of thumb it shouldn't exceed a peak of 1-2% of the rated voltage (on top of the voltage setting) while the duration mainly depends charging state of the capacities on the DC output and the capacity value together.

### 3.2.3 Power regulation / constant power / power limiting

Power regulation, also known as power limiting or constant power (short: CP), keeps the DC output power of a power supply constant if the current flowing to the load in relation to the output voltage reaches the adjusted value according to  $P = U * I$  resp.  $P = U^2 / R$ . The power limiting then regulates the output current according to  $I = \text{sqr}(P / R)$ , where R is the load's resistance.

Power limiting operates according to the auto-range principle such that at lower output voltages higher current can flow and vice versa, in order to maintain constant power within the range  $P_N$  (see diagram to the right).

While the DC output is switched on and constant power mode is active, the condition "CP mode active" will be shown on the graphic display by the abbreviation **CP**, as well stored as status which can be read via digital interface.

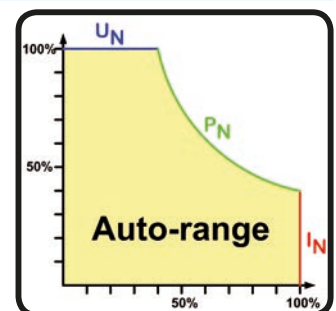

#### 3.2.3.1 Power derating

Due to fusing and cross sections of conductors and the extended input voltage range, power supply models with 1500 W rated output power have a fixed derating, which becomes active below a certain AC supply voltage (for value see „1.8.3. Specific technical data“). The device would then derate the maximum available output power down to approx. 1000 W. The derating only affects the power stage, so the full range for power set value adjustment remains, though the device won't provide full output power anymore. In this situation, constant power operation can not be indicated by status **CP**. Once derating is active it can only be detected by comparing the actual power to the set values of voltage, current and power.



*There is no status "CP" available if the power set value is bigger than the derated actual output power of the device. It means, power derating isn't indicated.*

### 3.2.4 Internal resistance regulation

Internal resistance control (short: CR) of power supplies is the simulation of a virtual internal resistor which is in series to the load. According to Ohm's law, this resistance causes a voltage drop, which will result in a difference between the adjusted output voltage and the actual output voltage. This will also work in CC or CP mode whereas the actual output voltage will differ even more from the adjusted voltage, because both modes limit the output voltage additionally. CR mode is actually running in CV, but will be indicated as **CR** on display once the adjusted resistance value is reached.

The adjustable resistance range of a particular model is given in the technical specifications. The voltage regulation in dependency of the resistance set value and the output current is done by calculation in a fast ARM controller, being only a little slower than other controllers inside the control circuit.



Clarification:

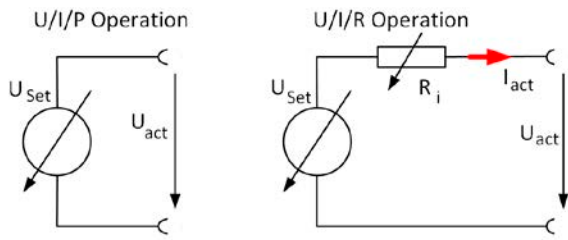

$$U_{Act} = U_{Set} - I_{Act} * R_{Set} \quad \left| \begin{matrix} P_{Set}, I_{Set} \end{matrix} \right.$$

$$P_{Ri} = (U_{Set} - U_{Act}) * I_{Act}$$



*With resistance mode being activated the function generator will be unavailable and the actual power value provided by the device does not include the simulated power dissipation of Ri.*

### 3.3 Alarm conditions



*This section only gives an overview about device alarms. What to do in case your device indicates an alarm condition is described in section „3.6. Alarms and monitoring“.*

As a basic principle, all alarm conditions are signalled optically (text + message in the display), acoustically (if activated) and as a readable status via the analog and digital interfaces. For later acquisition of the number of occurred alarms, an alarm counter can be read from the display or via digital interface.

#### 3.3.1 Power Fail

Power Fail (PF) indicates an alarm condition which may have various causes:

- AC input voltage too low
- Defect in the input circuit (PFC) or internal auxiliary supply

In case the PF alarm has been caused by AC supply undervoltage, the device will only temporarily stop supplying power and can continue automatically once the undervoltage has gone, depending on the setting of parameter **DC output after PF alarm** (see „3.4.3. Configuration via MENU“).



*Switching the device off by the power switch can't be distinguished from a supply blackout and thus the device will signalise a PF alarm every time. In this situation the alarm must be ignored.*

#### 3.3.2 Overtemperature

An overtemperature alarm (OT) will cause the device to switch off the power stages and can occur if

- the internal temperature of the device exceeds a specific level (overheating).

This would be the case if the ambient temperature also exceeds the rated operation temperature limit or when the device fan has failed. After cooling down, the device can automatically switch the power stage back on, depending on the setting of parameter **DC output after OT alarm**. See section „3.4.3.1. Menu “General Settings““.

#### 3.3.3 Overvoltage protection

An overvoltage alarm (OVP) will cause the device to switch off the DC output and can occur if

- the power supply itself, as a voltage source, generates an output voltage higher than set for the overvoltage alarm threshold (OVP, 0...110%  $U_{Nom}$ ) or the connected load somehow returns voltage higher than set for the overvoltage alarm limit.
- the OV threshold has been adjusted too close to the output voltage. If the device is in CC mode and if it then does a negative load step, it will cause the voltage to rise very quick, possibly resulting in a short voltage overshoot which could already trigger the OVP.

This function serves to warn the power supply user acoustically or optically that the device has probably generated an excessive voltage which could damage the connected load.



- The device isn't fitted with protection from external overvoltage
- The changeover from operation mode CC -> CV can generate voltage overshoots

#### 3.3.4 Overcurrent protection

An overcurrent alarm (OCP) will cause the device to switch off the DC output and can occur if

- the output current in the DC output exceeds the adjusted OCP limit.

This function serves to protect the connected load application so that this isn't overloaded and possibly damaged due to an excessive current.

#### 3.3.5 Overpower protection

An overpower alarm (OPP) will cause the device to switch off the DC output and can occur if

- the product of the output voltage and output current in the DC output exceeds the adjusted OPP limit.

This function serves to protect the connected load application so that this isn't overloaded and possibly damaged due to an excessive power consumption.

## 3.4 Manual operation

### 3.4.1 Switching the device on

The device should always be switched on using the toggle switch on the front of the device. After powering it, the display will first show the company logo, followed by a 3 seconds lasting language selection and later manufacturer's name and address, device type, firmware version(s), serial number and article number.

In setup (see section „3.4.3. Configuration via MENU“), in the second level menu **General settings** is an option **DC output after Power ON** in which the user can determine the condition of the DC output after power-up. Factory setting here is **OFF**, meaning that the device would start with the DC output being switched off. **Restore** means that the last condition of the DC output will be restored, either on or off. The set values, however, are always saved and restored.



*After powering the device and during the start phase the AI signals undefined statuses on the digital output pins such as ALARMS 1. Those must be ignored until it's ready to work.*

### 3.4.2 Switching the device off

On switch-off the last output condition and set values, as well as all settings are saved. Furthermore, a PF alarm (power failure) will be signalled, but must be ignored here.

When acting the power button, the DC output will immediately switch off, but the device will keep running for a few seconds longer until it completely stops.

### 3.4.3 Configuration via MENU

The MENU serves to configure all operating parameters which are not constantly required. These can be set by finger touch on the MENU touch area, but only if the DC output is switched OFF. See figure to the right.

If the DC output is switched on the settings menu will not be shown, only status information.

Menu navigation is by finger touch. Values are set using the rotary knobs. The assignments of the rotary knobs, if multiple values can be set in a particular menu, isn't always depicted. Following rule for such situations: upper value -> left knob, lower value -> right knob.

Some setting parameters are self-explanatory, others are not. The latter will be explained on the pages following.

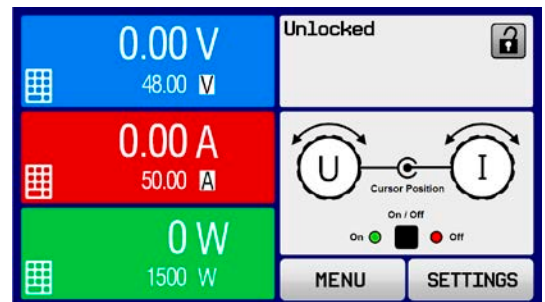

## 3.4.3.1 Menu "General Settings"

Setting	Description
<b>Allow remote control</b>	Selection <b>No</b> means that the device can't be remotely controlled over either the digital or analog interfaces. If remote control isn't allowed, the status will be shown as <b>Local</b> in the status area on the main display. See also section 1.9.5.1
<b>Analog interface range</b>	Selects the voltage range for the analog set values, actual output values and reference voltage output. <ul style="list-style-type: none"> <li>• <b>0...5 V</b> = Range is 0...100% set /actual values, reference voltage 5 V</li> <li>• <b>0...10 V</b> = Range is 0...100% set /actual values, reference voltage 10 V</li> </ul> Also see „3.5.4. Remote control via the analog interface (AI)“
<b>Analog interface Rem-SB</b>	Selects how the input pin REM-SB of the analog interface shall be working regarding levels (see „3.5.4.4. Analog interface specification“) and logic: <ul style="list-style-type: none"> <li>• <b>Normal</b> = Levels and function as described in the table in 3.5.4.4</li> <li>• <b>Inverted</b> = Levels and function will be inverted</li> </ul> Also see „3.5.4.7. Application examples“
<b>Analog Rem-SB action</b>	Selects the action on the DC output that is initiated when changing the level of analog input REM-SB: <ul style="list-style-type: none"> <li>• <b>DC OFF</b> = the pin can only be used to switch the DC output off</li> <li>• <b>DC ON/OFF</b> = the pin can be used to switch the DC output off and on again, if it has been switched on before at least from a different control location</li> </ul>
<b>Analog interface pin 6</b>	Pin 6 of the analog interface (see section 3.5.4.4) is by default assigned to only signal the device alarms OT and PF. This parameter allows to also enable signalling only one of both (3 possible combinations): <ul style="list-style-type: none"> <li>• <b>Alarm OT</b> = Enable/disable signalling of alarm OT on pin 6</li> <li>• <b>Alarm PF</b> = Enable/disable signalling of alarm PF on pin 6</li> </ul>
<b>Analog interface pin 14</b>	Pin 14 of the analog interface (see section 3.5.4.4) is by default assigned to only signal the device alarm OVP. This parameter allows to also enable signalling further device alarms (7 possible combinations): <ul style="list-style-type: none"> <li>• <b>Alarm OVP</b> = Enable/disable signalling of alarm OVP on pin 14</li> <li>• <b>Alarm OCP</b> = Enable/disable signalling of alarm OCP on pin 14</li> <li>• <b>Alarm OPP</b> = Enable/disable signalling of alarm OPP on pin 14</li> </ul>
<b>Analog interface pin 15</b>	Pin 15 of the analog interface (see section 3.5.4.4) is by default assigned to only signal the regulation mode CV. This parameter allows to enable signalling a different device status (2 options): <ul style="list-style-type: none"> <li>• <b>Regulation mode</b> = Enable/disable signalling of CV reg mode on pin 15</li> <li>• <b>DC status</b> = Enable/disable signalling of DC output status on pin 15</li> </ul>
<b>DC output after OT alarm</b>	Determines how the DC power stages shall react after an overtemperature (OT) alarm has occurred and the power stages have cooled down again: <ul style="list-style-type: none"> <li>• <b>OFF</b> = DC power stage(s) will be off</li> <li>• <b>AUTO</b> = The device will automatically restore the situation before the OT alarm, which usually means the DC power stage(s) to be on</li> </ul>
<b>DC output after Power ON</b>	Determines the condition of the DC output after power-up. <ul style="list-style-type: none"> <li>• <b>OFF</b> = DC output is always off after switching on the device.</li> <li>• <b>Restore</b> = DC output condition will be restored to the condition prior to switch off.</li> </ul>
<b>DC output after PF alarm</b>	Determines how the DC output shall react after a power fail (PF) alarm has occurred: <ul style="list-style-type: none"> <li>• <b>OFF</b> = DC output will be switched off and remain until user action</li> <li>• <b>AUTO</b> = DC output will switch on again after the PF alarm cause is gone and if it was switched on before the alarm occurred</li> </ul>

Setting	Description
<b>DC output after remote</b>	Determines the condition of the DC output after leaving remote control either manually or by command. <ul style="list-style-type: none"> <li>• <b>OFF</b> = DC output will be always off when switching from remote to manual</li> <li>• <b>AUTO</b> = DC output will keep the last condition</li> </ul>
<b>Enable R mode</b>	Activates the internal resistance control with <b>Yes</b> or deactivates it with <b>No</b> . If activated, the resistance set value of the simulated internal resistor can be adjusted additionally to the other set values. For more refer to „3.2.4. <i>Internal resistance regulation</i> “ and „3.4.6. <i>Manual adjustment of set values</i> “
<b>USB file separator format</b>	Switches the decimal point format of values and also the CSV file separator for USB logging (see 1.9.5.5 and 3.4.10) and for other features where CSV files are used. <ul style="list-style-type: none"> <li>• <b>US</b> = Comma separator (US standard for CSV files)</li> <li>• <b>Default</b> = Semicolon separator (german/european standard for CSV files)</li> </ul>
<b>USB logging with units (V,A,W)</b>	CSV files generated from USB logging by default add physical units to values. This can be deactivated by setting this option to <b>No</b>
<b>Calibrate device</b>	Touch area <b>Start</b> starts a calibration routine (see „4.3. <i>Calibration</i> “), but only if the device is in U//P mode, i.e. R mode not activated.
<b>Reset device to defaults</b>	Touch area <b>Start</b> will initiate a reset of all settings (HMI, profile etc.) to default values and all set values to 0
<b>Restart device</b>	Will initiate a warm start of the device

#### 3.4.3.2 Menu “User Events”

See „3.6.2.1 *User defined events*“ on page 60.

#### 3.4.3.3 Menu “Profiles”

See „3.9 *Loading and saving an user profile*“ on page 62.

#### 3.4.3.4 Menu “Overview”

This menu page displays an overview of the set values (U, I, P or U, I, P, R) and alarm settings as well as settings limits. These can only be displayed, not changed.

#### 3.4.3.5 Menu “About HW, SW...”

This menu page displays an overview of device relevant data such as serial number, article number etc., as well as an alarm history which lists the number of device alarms that probably occurred since the device has been powered.

#### 3.4.3.6 Menu “Function Generator”

See „3.10 *The function generator*“ on page 63.

#### 3.4.3.7 Menu “Communication”

Here settings for the Ethernet port are configured. The USB port there doesn't require any settings.

After delivery or a complete reset, the Ethernet port has following **default settings** assigned:

- DHCP: off
- IP: 192.168.0.2
- Subnet mask: 255.255.255.0
- Gateway: 192.168.0.1
- Port: 5025
- DNS: 0.0.0.0
- Host name: Client (configurable via HMI)
- Domain: Workgroup (configurable via HMI)

Those settings can be changed anytime and configured to meet local requirements. Furthermore, there are global communication settings available regarding timing and protocols.

## Sub menu "Ethernet -> IP Settings"

Element	Description
<b>DHCP</b>	With setting DHCP the device will instantly try to get network parameters (IP, subnet mask, gateway, DNS) assigned from a DHCP server after power-on or when changing from <b>Manual</b> to <b>DHCP</b> and submitting the change with button ENTER. If the DHCP configuration attempt fails, the device will use the settings from <b>Manual</b> . In this case, the overview in screen <b>View settings</b> will indicate the DHCP status as <b>DHCP (failed)</b> , otherwise as <b>DHCP (active)</b> .
<b>Manual</b>	<b>Manual</b> (default setting): uses either the default network parameters (factory setting after device reset) or the last user-defined setting. Those parameters are not overwritten when selecting mode <b>DHCP</b> and are thus available again when switching to <b>Manual</b> .
<b>IP address</b>	Only available with setting <b>Manual</b> . Default value: <b>192.168.0.2</b> User-defined IP address in standard IP format
<b>Subnet mask</b>	Only available with setting <b>Manual</b> . Default value: <b>255.255.255.0</b> User-defined subnet mask in standard IP format
<b>Gateway</b>	Only available with setting <b>Manual</b> . Default value: <b>192.168.0.1</b> User-defined gateway address in standard IP format
<b>Port</b>	Default value: <b>5025</b> Adjust the socket port here which belongs to the IP address and serves for TCP/P access when controlling the device remotely via Ethernet
<b>DNS address</b>	Default value: <b>0.0.0.0</b> User-defined network address of a domain name server (short: DNS) which has to be present in order to translate the host name to the device's IP, so the device could alternatively accessed by its assigned host name (see below)

## Sub menu "Ethernet"

Element	Description
<b>Host name</b>	Configures the host name for the device for the use with a local DNS
<b>Domain name</b>	Configures the domain name for the device for the use with a local DNS
<b>TCP Keep-Alive</b>	Default setting: disabled Enables/disables the "keep-alive" functionality of TCP.

## Sub menu "Com Protocols" (communication protocols)

Element	Description
<b>SCPI / ModBus</b>	Default setting: both enabled Enables/disables SCPI or ModBus communication protocols for the device. The change is immediately effective after submitting it with ENTER button. Only one of both can be disabled. When later accessing the device with the disabled protocol, it would either not react (SCPI active) or return an error message (ModBus active)
<b>Limited / Full</b>	Default setting: <b>Limited</b> Related to the device's communication via ModBus RTU or TCP, which in earlier firmware versions wasn't fully compliant to the ModBus specification, this switch is used to keep custom software applications which respected the non-compliance (setting <b>Limited</b> ) running after a firmware update. For new projects it's suggested to set this switch permanently to <b>Full</b> .

## Sub menu "Com Timeout" (communication time-out)

Element	Description
<b>Timeout USB (ms)</b>	Default value: <b>5 ms</b> , Range: <b>5...65535 ms</b> USB communication time-out in milliseconds. Defines the maximum time between two subsequent bytes or blocks of a transferred message. For more information about the time-out refer to the external programming documentation "Programming Guide ModBus & SCPI".
<b>Timeout ETH (s)</b>	Default value: <b>5 s</b> , Range: <b>5...65535 s</b> If there was no communication between the controlling unit (PC, PLC etc.) and the device for the adjusted time, it will close the socket connection. This time-out will be ineffective as long as the option <b>TCP Keep-Alive</b> (see above, table for Ethernet module) is activated and "keep-alive" is working as expected within the network. Setting "0" deactivates the time-out permanently.

Element	Description
<b>Enable interface monitoring</b>	Default setting: deactivated Interface monitoring is a safety feature which, when activated, supervises the communication via any digital interface and also the physical connection line. For details refer to „3.5.3.4. <i>Interface monitoring</i> “.
<b>Timeout interface monitoring</b>	Default setting: <b>10 s</b> , Range: <b>1...36000 s</b> User adjustable time-out for the interface monitoring feature. Can only be varied while interface monitoring is activated. Also see above at <b>Enable interface monitoring</b> .

### 3.4.3.8 Menu “HMI Setup”

These settings refer exclusively to the control panel (HMI).

Element	Description
<b>Language</b>	Selection of the display language between German, English, Russian or Chinese.
<b>Backlight</b>	The choice here is whether the backlight remains permanently on or if it should be switched off when no input via screen or rotary knob is made for 60 s. As soon as input is made, the backlight returns automatically. Furthermore the brightness can be selected in 10 steps.
<b>HMI Lock</b>	See „3.7 Control panel (HMI) lock“ on page 61.
<b>Limits Lock</b>	See „3.8 Limits lock“ on page 62
<b>Key Sound</b>	Activates or deactivates sounds when touching a touch area in the display. It can usefully signal that the action has been accepted.
<b>Alarm Sound</b>	Activates or deactivates the additional acoustic signal of an alarm or user defined event which has been set to “Action = ALARM”. See also „3.6 Alarms and monitoring“ on page 59.
<b>Status page</b>	Enables/disables two display related options for the main screen with actual and set values: <b>Show meter bar:</b> in U/I/P mode, i. e. resistance mode not activated, a meter bar for 0-100% actual values of voltage, current and power is shown (see example figure below) <b>Alternative status page:</b> switches the main screen of the device with its actual and set values of voltage, current, power and - if activated - resistance to a simpler display with only voltage and current, plus status. Default setting: both disabled

## 3.4.4 Adjustment limits (Limits)



Adjustment limits are only effective on the related set values, no matter if using manual adjustment or remote control setting!



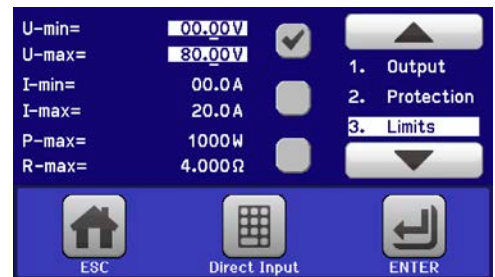

Defaults are that all set values (U, I, P, R) are adjustable from 0 to 102%.

The full range may be obstructive in some cases, especially for protection of applications against overvoltage. Therefore upper and lower limits for current (I) and voltage (U) can be set separately, which then limit the range of the adjustable set values.

For power (P) and resistance (R) only upper value limits can be set.



### ► How to configure the adjustment limits

1. On the main screen, tap **SETTINGS** to access the SETTINGS menu.
2. Tap the arrows   to select "3. Limits".
3. In each case a pair of upper and lower limits for U/I or the upper limit for P/R are assigned to the rotary knobs and can be adjusted. Tap the selection area for another choice .
4. Accept the settings with .



The set values can be entered directly using the ten-key pad. See "Direct input" touch area (bottom centre)



The adjustment limits are coupled to the set values. It means, that the upper limit may not be set lower than the corresponding set value. Example: If you wish to set the limit for the power set value (P-max) to 1000 W while the currently adjusted power set value is 1100 W, then the set value first would have to be reduced to 1000 W or less.

## 3.4.5 Changing the operating mode

In general, the manual operation of a PSI 9000 DT distinguishes between two operating modes which are tied to set value input using the rotary knobs or ten-key pad. This assignment has to be switched manually if you want to adjust any of the three set values which is currently not selected.

### ► How to change the operating mode (two options)

1. Unless the device is in remote control or the panel is locked, you can switch the operation anytime. There are two options: either tap the depiction of the right-hand knob (see figure to the right) to change its assignment between I, P and R, which is displayed on the knob depiction, or
2. you directly tap on the coloured areas with the set values, like shown in the figure to the right. The unit next to the set values, when inverted, indicates the assignment of the knob. In the example in the figure it has U and P assigned, which means U/P mode.

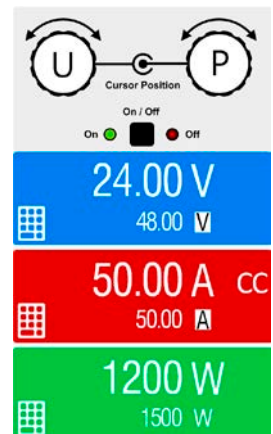

Depending on the selection the right rotary knob will be assigned different setting values, the left knob is always assigned to the voltage.



In order to avoid constant changing of the assignments it's possible, e. g. with selection U/I being active, to change the other value P by direct input, which can be accessed by tapping the small ten-key pad symbol. See section 3.4.6.

The actual operating mode, while the DC output is switched on, solely depends on the set values and the situation at the DC output (actual values). For more information refer to section „3.2. Operating modes“.



## 3.4.6 Manual adjustment of set values

The set values for voltage, current and power are the fundamental operating possibilities of a power supply and hence, in manual operation, the two rotary knobs on the front of the device are always assigned to two of these values. The default assignment is voltage and current.

As a fourth value there is the internal resistance, which requires to activate the resistance mode (R mode) in the MENU. Refer to „3.4.3. Configuration via MENU“ and „3.2.4. Internal resistance regulation“ for details.

Set values can be entered manually in two ways: via **rotary knob** or **direct input**. While manual adjustment with the knobs alter values continuously, direct input allows for even huge value steps, such as 0-100%.



*Entering a value changes it at any time, no matter if the DC output is switched on or off.*



*When adjusting set values, upper or lower limits may come into effect. See section „3.4.4. Adjustment limits (Limits)“. Once a limit is reached, the display will show a note like “Limit: U-max” etc. for 1.5 seconds next to the adjusted value or will refuse to accept a value entered by direct input.*

### ► How to adjust values with the rotary knobs

1. First check whether the value to be changed is assigned to one of the rotary knobs. The main screen displays the assignment as depicted in the figure to the right.
2. If, as shown in the example, the assignment is voltage (U, left) and power (P, right), and it's required to set the current, then the assignments can be changed by tapping the knob depiction as often as required to switch to "I" for current.
3. After successful selection, the desired value can be set within the defined limits. Selecting a digit is done by pushing the rotary knob which shifts the cursor right to left (digit will be underlined):

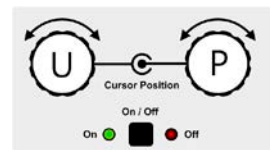

### ► How to adjust values via direct input:

1. In the main screen, depending on the rotary knob assignment, values can be set for voltage (U), current (I), power (P) or resistance (R) via direct input by tapping on the set/actual value display areas, e. g. in the uppermost area of voltage.
2. Enter the required value using the ten-key pad. Similar to a pocket calculator the key **c** clears the input. Decimal values are set by tapping the point key. For example, 54.3 V is set with **5** **4** **.** **3** and **ENTER**. Should the entered value not be within the adjustment limits, it will be rejected with an error message.
3. The display switches to the main page and the set values take effect..



## 3.4.7 Switching the main screen view

The main screen, also called status page, with its set values, actual values and device status can be switched from the standard view mode with three or four values to a simpler mode with only voltage and current display. The advantage of the alternative view mode is that actual values are displayed with **much bigger characters**, so they can be read from a larger distance. Refer to „3.4.3.8. Menu “HMI Setup”“ to see where to switch the view mode in the MENU. Comparison:

Standard status page

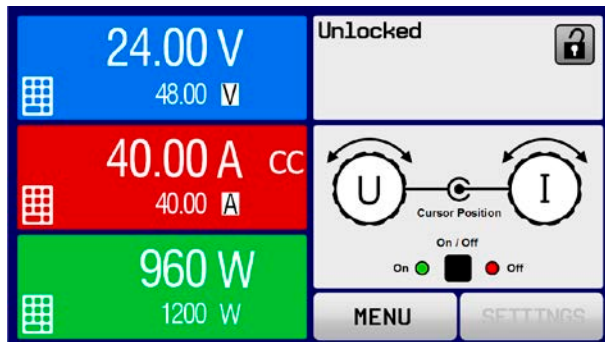

Alternative status page

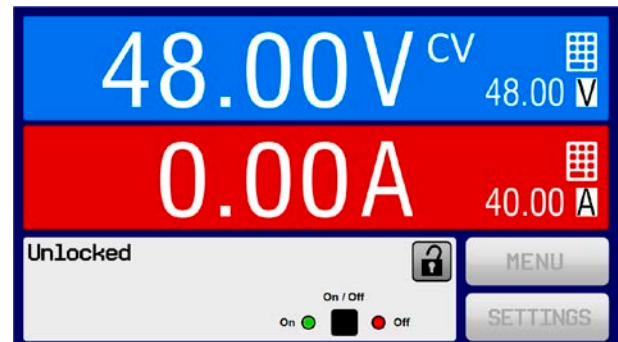

Limitations of the alternative status page:

- The set and actual values of power are not displayed and the set value of power is only indirectly accessible
- The set value of resistance isn't displayed and is only indirectly accessible
- No access to the settings overview (MENU button) while the DC output is on

Rules for manual handling of the HMI in alternative status page mode:

- The two rotary knobs are assigned to voltage (left knob) and current (right knob) all the time, except for menus
- Set values input is the same as in standard status page mode, with knobs or by direct input
- Regulation modes CP and CR are displayed alternatively to CC at the same position

## 3.4.8 The meter bars

Additionally to the actual values being displayed as numbers, a meter bar for U, I and P can be enabled in the MENU. The meter bars are not displayed as long as resistance mode, i. e. U/I/R is activated. Refer to „3.4.3.8. Menu “HMI Setup”“ to see where to enable the meter bars in the MENU. Depiction:

Standard status page with meter bar

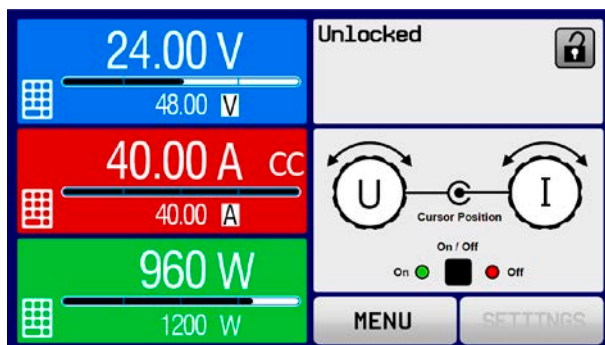

Alternative status page with meter bar

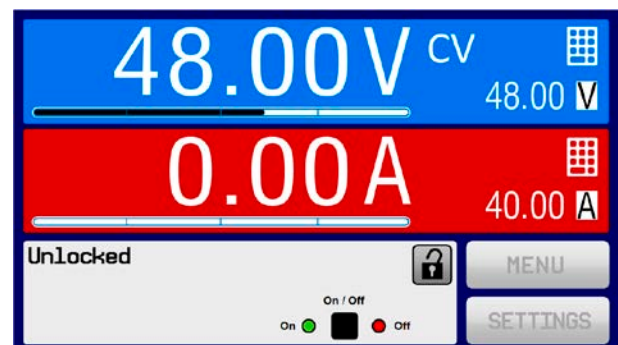

## 3.4.9 Switching the DC output on or off

The DC output of the device can be manually or remotely switched on and off. This can be restricted in manual operation by the control panel being locked.



*Switching the DC output on during manual operation or digital remote control can additionally be blocked by pin REM-SB of the built-in analog interface. For more information refer to 3.4.3.1 and example a) in 3.5.4.7.*

### ► How to manually switch the DC output on or off

1. As long as the control panel isn't fully locked press the button ON/OFF. Otherwise you are asked to disable the HMI lock first.
2. This button toggles between on and off, as long as a change isn't restricted by an alarm or the device is in remote control.

### ► How to remotely switch the DC output on or off via the analog interface

1. See section „3.5.4 Remote control via the analog interface (AI)“ on page 55.

### ► How to remotely switch the DC output on or off via the digital interface

1. See the external documentation “Programming Guide ModBus & SCPI” if you are using custom software, or refer to the external documentation of the LabView VIs or other software provided by the manufacturer.

## 3.4.10 Recording to USB stick (logging)

Device data can be recorded to USB sticks of standard 2.0 or 3.0 (not all chip vendors are supported) anytime. For specifications of the USB stick and the generated log files also refer to section „1.9.5.5. USB port (front side)“.



The logging stores files of CSV format on the stick. The layout of the log data is the same as when logging via PC with software EA Power Control. The advantage of USB logging over PC logging is the mobility and that no PC is required. The logging feature just has to be activated and configured in the MENU.

### 3.4.10.1 Configuration

Also see section 3.4.3.1. After USB logging has been enabled and the parameters **Logging interval** and **Start/Stop** have been set, logging can be started anytime from within the MENU or after leaving it, depends on the selected start/stop mode.

### 3.4.10.2 Handling (start/stop)

With setting **Start/stop with DC output ON/OFF** logging will start each time the DC output of the device is switched on, no matter if manually with the front button “On/Off” or remotely via analog or digital interface. With setting **Manual start/stop** it's different. Logging is then started and stopped only in the MENU, specifically in the logging configuration page.

Soon after logging has been started, the symbol  indicates the ongoing logging action. In case there is an error while logging, such as USB stick full or removed, it will be indicated by a different symbol . After every manual stop or switching the DC output off the logging is stopped and the log file closed.

### 3.4.10.3 Log file format

Type: text file in european or US CSV format, depending on the setting **USB file separator format** (see 3.4.3.1)

Layout:

	A	B	C	D	E	F	G	H	I	J	K	L	M
1	U set	U actual	I set	I actual	P set	P actual	R set	R actual	R mode	Output/Input	Device mode	Error	Time
2	2,00V	11,92V	1,20A	1,20A	7344W	15W	N/A	N/A	OFF	ON	CC	NONE	00:00:00,942
3	2,00V	11,90V	1,20A	1,20A	7344W	15W	N/A	N/A	OFF	ON	CC	NONE	00:00:01,942
4	2,00V	11,89V	1,20A	1,20A	7344W	15W	N/A	N/A	OFF	ON	CC	NONE	00:00:02,942
5	2,00V	11,87V	1,20A	1,20A	7344W	15W	N/A	N/A	OFF	ON	CC	NONE	00:00:03,942

Legend:

**U set / I set / P set / R set:** Set values

**U actual / I actual / P actual / R actual:** Actual values

**Error:** device alarms

**Time:** elapsed time since logging start

**Device mode:** actual regulation mode (also see „3.2. Operating modes“)

Important to know:

- R set and R actual are only recorded if UIR mode is active (refer to section 3.4.5)
- Unlike the logging on PC, every log start here creates a new log file with a counter in the file name, starting generally with 1, but minding existing files

#### 3.4.10.4 Special notes and limitations

- Max. log file size (due to FAT32 formatting): 4 GB
- Max. number of log files in folder HMI\_FILES: 1024
- With setting **Start/stop with DC output ON/OFF**, the logging will also stop on alarms or events with action **Alarm**, because they switch off the DC output
- With setting **Manual start/stop** the device will continue to log even when alarms occur, so this mode can be used to determine the period of temporary alarms like OT or PF

## 3.5 Remote control

### 3.5.1 General

Remote control is possible via the built-in analog interface, USB port or Ethernet port. Important here is that either the analog or any of the digital interfaces can be in control. It means that if, for example, an attempt were to be made to switch to remote control via the digital interface whilst analog remote control is active (pin REMOTE = LOW) the device would report an error via the digital interface. In the opposite direction, a switch-over via pin REMOTE would be ignored. In both cases, however, status monitoring and reading of values are always possible.

### 3.5.2 Control locations

Control locations are those locations from where the device can be controlled. Essentially there are two: at the device (manual operation) and outside (remote control). The following locations are defined:

Displayed location	Description
-	If neither of the other locations is displayed then manual control is active and access from the analog and digital interfaces is allowed. This location isn't explicitly displayed
<b>Remote</b>	Remote control via any interface is active
<b>Local</b>	Remote control is inhibited, only manual operation is allowed.

Remote control may be allowed or inhibited using the setting **Allow remote control** (see „3.4.3.1. Menu “General Settings”). In inhibited condition the status **Local** will be displayed in the status area of the display. Activating the lock can be useful if the device is remotely controlled by software or some electronic device, but it's required to make adjustments at the device or deal with emergency, which would not be possible remotely. This implies to remote control can be interrupted on the HMI which is done by tapping it anywhere, which causes a two-stage request of which the second stage is very important in the situation of analog remote control. Activating condition **Local** causes the following:

- If remote control via the digital interface is active (**Remote**), then it's immediately terminated and in order to continue remote control once **Local** is no longer active, it can be reactivated at the PC
- If remote control via the analog interface is active (**Remote: Analog**), then it's temporarily interrupted until remote control is allowed again by deactivating **Local**, because pin REMOTE continues to signal “remote control = on”, unless this has been changed during the **Local** period

### 3.5.3 Remote control via a digital interface

#### 3.5.3.1 Selecting an interface

The device only supports the built-in digital interfaces USB and Ethernet.

For USB, a standard USB cable is included in the delivery, as well as a driver for Windows on USB stick. The USB interface requires no setup in the MENU.

The Ethernet interface typically requires network setup (manual or DHCP), but can also be used with its default parameters right from the start.

#### 3.5.3.2 General

For the network port installation refer to „1.9.7. Ethernet port“.

The digital interfaces require little or no setup for operation and can be directly used with their default configuration. All specific settings will be permanently stored, but could also be reset to defaults with the setup menu item **Reset Device**.

Via the digital interfaces primarily the set values (voltage, current, power) and device conditions can be set and monitored. Furthermore, various other functions are supported as described in a separate programming documentation.

Switching to remote control will retain the last set values of the device until these are changed by command.

#### 3.5.3.3 Programming

Programming details for the interfaces, the communication protocols etc. are found in the external documentation “Programming Guide ModBus & SCPI” which is supplied on the included USB stick or is available as download from the EA Elektro-Automatik website.

## 3.5.3.4 Interface monitoring

Interface monitoring is a configurable functionality introduced in firmwares KE 3.09 and HMI 2.20. Its goal is to monitor (or supervise) the communication line between the device and a superior control unit, such as PC or PLC, and to ensure that the device wouldn't continue working uncontrolled in case the communication line fails. A failing line can mean that it's either physically interrupted (damaged cable, bad contact, cable pulled) or the interface port inside the device hangs.

The monitoring is always only valid for one of the digital interfaces, the one being used for remote control. It thus means that the monitoring can become temporarily inactive when the device leaves remote control. It's furthermore based on a user-definable timeout which would run out if not at least one message is sent to the device within the given time frame. After every message, the timeout would start again and reset with the next message coming. In case it runs out, following reaction of the device is defined:

- Exit remote control
- In case the DC output is switched on, either switch the DC output off or leave it on, as defined by the parameter "DC output after remote" (see 3.4.3.1)

Notes for the operation:

- The monitoring can be deactivated or activated anytime via remote control
- The timeout of the monitoring can be changed anytime via remote control; the new value would only be valid after the current timeout has elapsed
- The interface monitoring doesn't deactivate the Ethernet connection timeout (see 3.4.3.7), so these two timeouts can overlap

### 3.5.4 Remote control via the analog interface (AI)

#### 3.5.4.1 General

The built-in and galvanically isolated 15-pole analog interface (short: AI) on the rear side of the device offers the following possibilities:

- Remote control of current, voltage, power and internal resistance
- Remote status monitoring (CV, DC status)
- Remote alarm monitoring (OT, OVP, OCP, OPP, PF)
- Remote monitoring of actual values
- Remote on/off switching of the DC output

Setting the **three** set values of voltage, current and power via the analog interface always takes place concurrently. It means, that for example the voltage can't be given via the AI and current and power would be set with the rotary knobs, or vice versa. The internal resistance set value can additionally be adjusted, if resistance mode is activated via pin R-ACTIVE.

The OVP set value and other supervision (events) and alarm thresholds can't be set via the AI and therefore must be adapted to the given situation before the AI is taking over. Analog set values can be fed in by an external voltage or by the reference voltage on pin 3. As soon as remote control via the analog interface is activated, the set values on the display will be those provided by the interface.

The AI can be operated in the common voltage ranges 0...5 V and 0...10 V. The selection of the voltage range is done in the device setup. See section „3.4.3. Configuration via MENU“ for details.

The reference voltage sent out from Pin 3 (VREF) will be adapted accordingly and is then:

**0-5 V:** Reference voltage = 5 V, 0...5 V set values (VSEL, CSEL, PSEL, RSEL) correspond to 0...100% nominal values, 0...100% actual values correspond to 0...5 V at the actual value outputs (CMON, VMON).

**0-10 V:** Reference voltage = 10 V, 0...10 V set values (VSEL, CSEL, PSEL, RSEL) correspond to 0...100% nominal values, 0...100% actual values correspond to 0...10 V at the actual value outputs (CMON, VMON).

All set values are always additionally limited to the corresponding adjustment limits (U-max, I-max etc.), which would clip setting excess values for the DC output. Also see section „3.4.4. Adjustment limits (Limits)“.

#### Before you begin, please read. Important notes for use of the interface:



*After powering the device and during the start phase the AI signals undefined statuses on the digital output pins such as ALARMS 1. Those must be ignored until it's ready to work.*

- Analog remote control of the device must be activated by switching pin REMOTE (5) first. Only exception is pin REM-SB, which can be used independently
- Before the hardware is connected that will control the analog interface, it shall be checked that it can't provide voltage to the pins higher than specified
- Set value inputs, such as VSEL, CSEL, PSEL and RSEL (if R mode is activated), must not be left unconnected (i.e. floating)
- It's always required to provide all three set values at once. In case any of the set values isn't used for adjustment, it can be tied to a defined level or connected to pin VREF (solder bridge or different), so it gives 100%

#### 3.5.4.2 Resolution

The analog interface is internally sampled and processed by a digital microcontroller. This causes a limited resolution of analog steps. The resolution is the same for set values (VSEL etc.) and actual values (VMON/CMON) and is approx. 26214. Due to tolerances, the truly achievable resolution can be slightly lower.

### 3.5.4.3 Acknowledging device alarms

In case of a device alarm occurring during remote control via analog interface, the DC output will be switched off the same way as in manual control. The device would indicate an alarm (see 3.6.2) in the front display and, if activated, acoustically and also signal them on the analog interface. Which alarms actually are signalled can be set up in the device configuration menu (see 3.4.3.1).

Some device alarms (OVP, OCP and OPP) have to be acknowledged. Also see „3.6.2. Device alarm and event handling“. Acknowledgement is done with pin REM-SB switching the DC output off and on again, means a HIGH-LOW-HIGH edge (min. 50 ms for LOW), when using the default level setting for this pin.

### 3.5.4.4 Analog interface specification

Pin	Name	Type*	Description	Levels	Electrical specification
1	VSEL	AI	Set voltage value	0...10 V or 0...5 V correspond to 0..100% of $U_{Nom}$	Accuracy 0-5 V range: < 0.4% ***** Accuracy 0-10 V range: < 0.2% ***** Input impedance $R_i > 40\text{ k} \dots 100\text{ k}$
2	CSEL	AI	Set current value	0...10 V or 0...5 V correspond to 0..100% of $I_{Nom}$	
3	VREF	AO	Reference voltage	10 V or 5 V	Tolerance < 0.2% at $I_{max} = +5\text{ mA}$ Short-circuit-proof against AGND
4	DGND	POT	Ground for all digital signals		For control and status signals
5	REMOTE	DI	Switching manual / remote control	Remote = LOW, $U_{Low} < 1\text{ V}$ Manual = HIGH, $U_{High} > 4\text{ V}$ Manual, if pin not wired	Voltage range = 0...30 V $I_{Max} = -1\text{ mA}$ bei 5 V $U_{LOW\text{ to HIGH typ.}} = 3\text{ V}$ Rec'd sender: Open collector against DGND
6	ALARMS 1	DO	Overtemperature or power fail alarm	Alarm= HIGH, $U_{High} > 4\text{ V}$ No alarm= LOW, $U_{Low} < 1\text{ V}$	Quasi open collector with pull-up against $V_{cc}$ ** With 5 V on the pin max. flow +1 mA $I_{Max} = -10\text{ mA}$ at $U_{CE} = 0,3\text{ V}$ $U_{Max} = 30\text{ V}$ Short-circuit-proof against DGND
7	RSEL	AI	Set internal resistance value	0...10 V or 0...5 V correspond to 0..100% of $R_{Max}$	Accuracy 0-5 V range: < 0.4% ***** Accuracy 0-10 V range: < 0.2% ***** Input impedance $R_i > 40\text{ k} \dots 100\text{ k}$
8	PSEL	AI	Set power value	0...10 V or 0...5 V correspond to 0..100% of $P_{Nom}$	
9	VMON	AO	Actual voltage	0...10 V or 0...5 V correspond to 0..100% of $U_{Nom}$	Accuracy 0-5 V range: < 0.4% ***** Accuracy 0-10 V range: < 0.2% ***** at $I_{Max} = +2\text{ mA}$ Short-circuit-proof against AGND
10	CMON	AO	Actual current	0...10 V or 0...5 V correspond to 0..100% of $I_{Nom}$	
11	AGND	POT	Ground for all analog signals		For -SEL, -MON, VREF signals
12	R-ACTIVE	DI	R mode on / off	Off = LOW, $U_{Low} < 1\text{ V}$ On = HIGH, $U_{High} > 4\text{ V}$ On, if pin not wired	Voltage range = 0...30 V $I_{Max} = -1\text{ mA}$ bei 5 V $U_{LOW\text{ to HIGH typ.}} = 3\text{ V}$ Rec'd sender: Open collector against DGND
13	REM-SB	DI	DC output OFF (DC output ON) (ACK alarms ****)	Off = LOW, $U_{Low} < 1\text{ V}$ On= HIGH, $U_{High} > 4\text{ V}$ On = Open	Voltage range = 0...30 V $I_{Max} = +1\text{ mA}$ at 5 V Rec'd sender: Open collector against DGND
14	ALARMS 2	DO	Overvoltage alarm Overcurrent alarm Overpower alarm	Alarm = HIGH, $U_{High} > 4\text{ V}$ No alarm = LOW, $U_{Low} < 1\text{ V}$	Quasi open collector with pull-up against $V_{cc}$ ** With 5 V on the pin max. flow +1 mA $I_{Max} = -10\text{ mA}$ at $U_{CE} = 0,3\text{ V}$ , $U_{Max} = 30\text{ V}$ Short-circuit-proof against DGND
15	STATUS***	DO	Constant voltage regulation active	CV = LOW, $U_{Low} < 1\text{ V}$ CC/CP/CR = HIGH, $U_{High} > 4\text{ V}$	
			DC output	Off = LOW, $U_{Low} < 1\text{ V}$ On = HIGH, $U_{High} > 4\text{ V}$	

\* AI = Analog Input, AO = Analog Output, DI = Digital Input, DO = Digital Output, POT = Potential

\*\* Internal  $V_{cc}$  approx. 10 V

\*\*\* Only one of both signals possible, see section 3.4.3.1

\*\*\*\* Only during remote control

\*\*\*\*\* The error of a set value input adds to the general error of the related value on the DC output of the device



## 3.5.4.5 Overview of the D-Sub socket

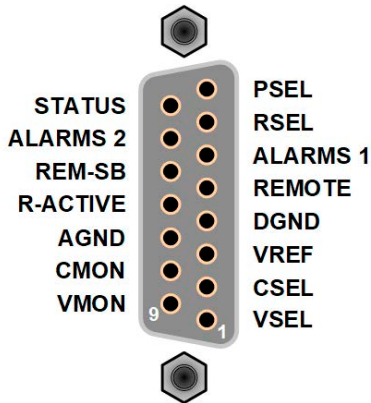

## 3.5.4.6 Simplified diagram of the pins

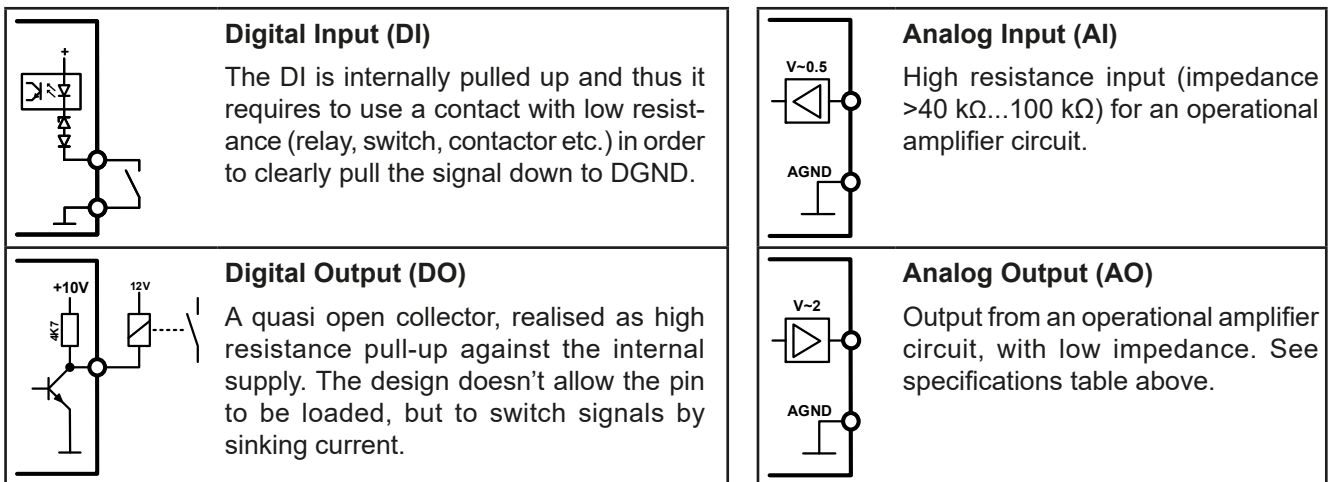

## 3.5.4.7 Application examples

### a) Switching the DC output with pin REM-SB



*A digital output, e. g. from a PLC, may be unable to correctly pull down the pin as it may not have a low output impedance. Check the specification of the controlling application to find out if the output is compatible. Also see the pin diagrams above.*

In remote control, pin REM-SB is used to switch the DC output of the device on and off. The function of the pin is also available without remote control being active. See below.

It's recommended that a low resistance contact such as a switch, relay or transistor is used to pull the pin to ground (DGND).

Following situations can occur:

- **Analog remote control has been activated**

During remote control via analog interface, only pin REM-SB determines the states of the DC output, according to the levels definitions in 3.5.4.4. The logical function and the default levels can be inverted by a parameter in the setup menu of the device. See 3.4.3.1.



*If the pin is unconnected or the connected contact is open, the pin will be HIGH. With parameter "Analog interface Rem-SB" being set to "Normal", it requests "DC output on". So when activating remote control with pin REMOTE, the DC output will instantly switch on.*

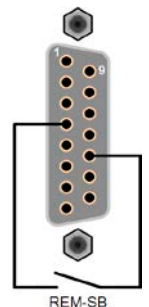

• **Analog remote control isn't active**

In this mode of operation pin REM-SB can serve as lock, preventing the DC output from being switched on by any means. This results in following possible situations:

DC output	+	Level on pin REM-SB	+	Parameter „Analog interface Rem-SB“	→	Behaviour
is off	+	HIGH	+	normal	→	The DC output isn't locked. It can be switched on by pushbutton On/Off (front panel) or via command from digital interface.
		LOW	+	inverted		
	+	HIGH	+	inverted	→	The DC output is locked. It can't be switched on by pushbutton On/Off (front panel) or via command from digital interface. When trying to switch on, a popup in the display resp. an error message will be generated.
		LOW	+	normal		

In case the DC output is already switched on, toggling the pin will switch the DC output off, similar to what it does in analog remote control:

DC output	+	Level on pin REM-SB	+	Parameter „Analog interface Rem-SB“	→	Behaviour
is on	+	HIGH	+	normal	→	The DC output remains on, nothing is locked. It can be switched on or off by pushbutton or digital command.
		LOW	+	inverted		
	+	HIGH	+	inverted	→	The DC output will be switched off and locked. Later it can be switched on again by toggling the pin. During lock, pushbutton or digital command can delete the request to switch on by pin.
		LOW	+	normal		

**b) Analog remote control of current and power**

Requires remote control to be activated (pin REMOTE = LOW)

The set values PSEL and CSEL are generated from, for example, the reference voltage VREF, using potentiometers for each. Hence the power supply can selectively work in current limiting or power limiting mode. According to the specification of max. 5 mA load for the VREF output, potentiometers of at least 10 kΩ must be used.

The voltage set value VSEL is directly connected to VREF and will thus be permanently 100%.

If the control voltage is fed in from an external source it's necessary to consider the input voltage ranges for set values (0...5 V or 0...10 V).

*Use of the input voltage range 0...5 V for 0...100% set value halves the effective resolution.*

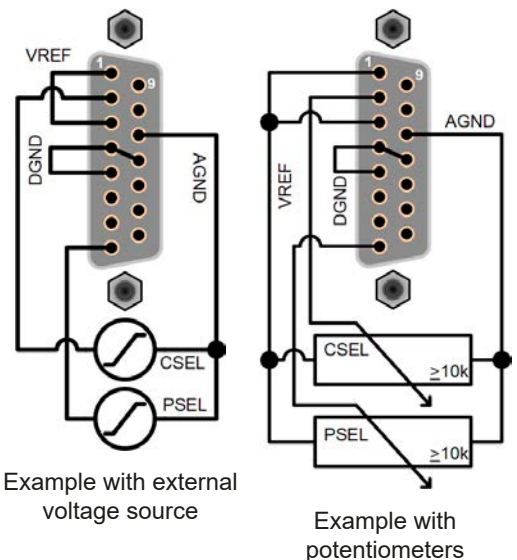

**c) Reading actual values**

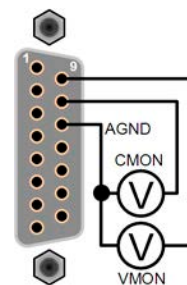

The AI provides the DC output values as current and voltage monitor. These can be read using a standard multimeter or similar.



### 3.6 Alarms and monitoring

#### 3.6.1 Definition of terms

There is a clear distinction between device alarms (see „3.3. Alarm conditions“), caused by the overvoltage protection or overheating protection, and user defined events such as OVD (overvoltage detection). Whilst device alarms serve to protect the device and the connected load by instantly switching off the DC output, user defined events can either switch off the DC output (**Action = ALARM**) or simply give an acoustic signal to make the user aware. The actions driven by user-defined events can be selected:

Action	Impact	Example
NONE	The user-defined event is disabled.	
SIGNAL	On reaching the condition which triggers the event, the action <b>SIGNAL</b> will show a text message in the status area of the display.	
WARNING	On reaching the condition which triggers the event, the action <b>WARNING</b> will show a text message in the status area of the display and pop up an additional warning message.	
ALARM	On reaching the condition which triggers the event, the action <b>ALARM</b> will show a text message in the status area of the display with an additional alarm pop-up, and additionally emit an acoustic signal (if activated). Furthermore the DC output is switched off. Certain device alarms are also signalled to the analog interface or can be queried via the digital interface.	

#### 3.6.2 Device alarm and event handling

A device alarm incident will usually lead to DC output switch-off. Alarms have to be acknowledged (see below), which can only happen if the cause of the alarm isn't persistent anymore, but not all of them require the acknowledgement BEFORE the device can continue its operation. Such alarms are OT and the PF alarm. The user can define the condition of the DC output for these two alarms, so that the device could also automatically continue to work like before the alarm. The alarm indication would then remain in the display until the user confirms.

► **How to acknowledge an alarm in the display (during manual control)**

1. If the alarm is indicated as a pop-up, tap **OK**.
2. If the alarm has already been acknowledged, but is still displayed in the status area, then first tap the status area to display the pop-up again, then acknowledge with **OK**.



In order to acknowledge an alarm during analog remote control, see „3.5.4.5. Overview of the D-Sub15 socket“. To acknowledge in digital remote control, refer to the external documentation “Programming Guide ModBus & SCPI”.

These device alarms are configurable:

Alarm	Meaning	Description	Range	Indication
OVP	OverVoltage Protection	Triggers an alarm as soon as the DC output voltage reaches the defined threshold. The DC output will be switched off.	0 V...1.1*U <sub>Nom</sub>	Display, analog IF, digital IF
OCP	OverCurrent Protection	Triggers an alarm as soon as the DC output current reaches the defined threshold. The DC output will be switched off.	0 A...1.1*I <sub>Nom</sub>	
OPP	OverPower Protection	Triggers an alarm as soon as the DC output power reaches the defined threshold. The DC output will be switched off.	0 W...1.1*P <sub>Nom</sub>	

These device alarms can't be configured and are based on hardware:

Alarm	Meaning	Description	Indication
PF	Power Fail	AC supply over- or undervoltage. Triggers an alarm if the AC supply is out of specification or when the device is cut from supply, for example when switching it off with the power switch. The DC output will be switched off which could be only temporarily, depending on the situation and setting <b>DC output after PF alarm</b> (see 3.4.3.1).	Display, analog & digital interface
OT	OverTemperature	Triggers an alarm if the internal temperature reaches a certain limit. The DC output will be switched off which could be only temporarily, depending on the setting <b>DC output after OT alarm</b> (see 3.4.3.1).	

### ► How to configure the device alarms

1. While the DC output is switched off tap touch area **SETTINGS** on the main screen.
2. On the right side tap the down arrow to select **2. Protection**.
3. Set the limits for the device alarm relevant to your application if the default value of 110% is unsuitable.



*The set values can be entered using the ten-key tab. This will appear by tapping on touch area "Direct input".*

The user also has the possibility of selecting whether an additional acoustic signal will be sounded if an alarm or user defined event occurs.

### ► How to configure the alarm sound (also see „3.4.3. Configuration via MENU“)

1. While the DC output is switched off tap touch area **MENU** on the main screen
2. In the menu page, tap **HMI Setup**
3. In the following menu page, tap **Alarm Sound**
4. In the settings page select **Sound on** or **Sound off** and confirm with



#### 3.6.2.1 User defined events

The monitoring functions of the device can be configured for user defined events. By default, events are deactivated (**Action = NONE**). Contrary to device alarms, the events only work while the DC output is switched on. It means, for instance, that the device can't detect undervoltage (UVD) anymore after switching the DC output off and the voltage is still sinking.



The following events can be configured independently and can, in each case, trigger the actions **NONE**, **SIGNAL**, **WARNING** or **ALARM**.

Event	Meaning	Description	Range
UVD	UnderVoltage Detection	Triggers an event if the output voltage falls below the defined threshold.	0 V...U <sub>Nom</sub>
OVD	OverVoltage Detection	Triggers an event if the output voltage exceeds the defined threshold.	0 V...U <sub>Nom</sub>
UCD	UnderCurrent Detection	Triggers an event if the output current falls below the defined threshold.	0 A...I <sub>Nom</sub>
OCD	OverCurrent Detection	Triggers an event if the output current exceeds the defined threshold.	0 A...I <sub>Nom</sub>
OPD	OverPower Detection	Triggers an event if the output power exceeds the defined threshold.	0 W...P <sub>Nom</sub>



*These events are not to be confused with alarms such as OT and OVP which are for device protection. User defined events can, however, if set to action ALARM, switch off the DC output and thus protect the load, like a sensitive electronic application.*

## ► How to configure user defined events

1. While the DC output is switched off tap touch area  on the main screen.
2. On the right side tap the arrows   to select **4.1 Event U** or **4.2 Event I** or **4.3 Event P**.
3. Set the monitoring limits with the left hand rotary knob and the triggered action with the right hand knob relevant to the application (also see „3.6.1. Definition of terms“).

4. Accept the settings with .



*User events are an integral part of the actual user profile. Thus, if another user profile, or the default profile, is selected and used, the events will be either differently or not configured.*



*The set values can be entered using the ten-key tab. This will appear by tapping the touch area “Direct input”.*

## 3.7 Control panel (HMI) lock

In order to avoid the accidental alteration of a value during manual operation, the rotary knobs or the touchscreen can be locked so that no alteration of values will be accepted without prior unlocking.

### ► How to lock the HMI

1. In the main page, tap the lock symbol .
2. In the settings page **HMI Lock Setup** you are then asked to chose between a complete HMI (**Lock all**) lock or one where the On/Off button is still usable (**ON/OFF possible**), resp. chose to activate the additional PIN (**Enable PIN**). The device would later request to enter this PIN every time you want to unlock the HMI, until the PIN is deactivated again.

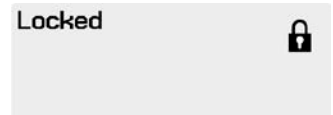

Be careful with the “Enable PIN” option if you are unsure what PIN is currently set. If you are unsure, use “Change PIN” to define a new one.

4. Activate the lock with . The status **Locked** as then shown in the figure above.

If an attempt is made to alter something whilst the HMI is locked, a requester appears in the display asking if the lock should be disabled.

### ► How to unlock the HMI

1. Tap any part of the touchscreen of the locked HMI, or turn one of the rotary knobs or press the button On/Off (only in **Lock all** situation).

2. This request pop-up will appear: .

3. Unlock the HMI by tapping on “Tap to unlock” within 5 seconds, otherwise the pop-up will disappear and the HMI remains locked. In case the additional **PIN code lock** has been activated in the menu **HMI Lock**, another requester will pop up, asking you to enter the **PIN** before it finally unlocks the HMI.

### 3.8 Limits lock

In order to avoid the alteration of the adjustment limits (also see „3.4.4. Adjustment limits (Limits)“) by an unprivileged user, the screen with the adjustment limit settings (Limits) can be locked by a PIN code. The menu pages **3.Limits** in SETTINGS and **Profiles** in MENU will then become inaccessible until the lock is removed by entering the correct PIN or in case it has been forgotten, by resetting the device as last resort.

#### ► How to lock the Limits

1. While the DC output is switched off, tap the touch area  on the main screen.
2. In the menu tap on **HMI Setup** and then on **Limits Lock**.
3. In the next page set the check mark for **Lock**.



*The same PIN as with the HMI lock is used here. It should be set before activating the Limits lock. See „3.7. Control panel (HMI) lock“*

4. Activate the lock by leaving the settings page with .



Be careful when enabling the lock, should you be unsure what PIN is currently set. In doubt use ESC to exit the menu page. In menu page “HMI Lock” you can define a different PIN, but not without entering the old one.

#### ► How to unlock the limits settings

1. While the DC output is switched off, tap the touch area  on the main screen.
2. In the menu tap on **HMI Setup** and then on **Limits Lock**.
3. In the next page tap on **Start** next to **Unlock** and then you will be asked to enter the 4-digit PIN.
4. Deactivate the lock by entering the correct PIN and submitting with **ENTER**.



### 3.9 Loading and saving an user profile

The menu “**Profiles**” serves to select between a default profile and up to 5 user profiles. A profile is a collection of all settings and set values. Upon delivery, or after a reset, all 6 profiles have the same settings and all set values are 0. If the user changes settings or sets target values then these create a working profile which can be saved to one of the 5 user profiles. These profiles or the default one can then be switched. The default profile is read-only.

The purpose of a profile is to load a set of set values, settings limits and monitoring thresholds quickly without having to readjust these. As all HMI settings are saved in the profile, including language, a profile change can also be accompanied by a change in HMI language.

On calling up the menu page and selecting a profile the most important settings can be seen, but not changed.

#### ► How to save the current values and settings as an user profile:

1. Tap the touch area  on the main screen
2. In the menu page, tap .
3. In the selection screen (right) choose between user profile 1-5 in which the settings are to be saved. The profile will then be displayed and the values can be checked, but not changed.
4. Save using the touch area .



## 3.10 The function generator

### 3.10.1 Introduction

The built-in **function generator** (short: **FG**) is able to create various signal forms and apply them to the set value of voltage or current.

All functions are based on an **arbitrary generator** and directly accessible and configurable using manual control. For remote control, the fully customisable arbitrary generator replicates the functions with sequence points containing 8 parameters each.

The following functions are retrievable, configurable and controllable:

Function	Short description
Sine wave	Sine wave generation with adjustable amplitude, offset and frequency
Triangle	Triangular wave signal generation with adjustable amplitude, offset, rise and fall times
Rectangular	Rectangular wave signal generation with adjustable amplitude, offset and duty cycle
Trapezoid	Trapezoidal wave signal generation with adjustable amplitude, offset, rise time, pulse time, fall time, idle time
DIN 40839	Simulated automobile engine start curve according to DIN 40839 / EN ISO 7637, split into 5 curve sequence points, each with a start voltage, end voltage and time
Arbitrary	Generation of a process with up to 99 freely configurable curve points, each with a start and end value (AC/DC), start and end frequency, phase angle and duration
Ramp	Generation of a linear rise or fall ramp with start and end values and time before and after the ramp



*Whilst R mode is activated, access to the function generator isn't available.*

### 3.10.2 General

#### 3.10.2.1 Restrictions

The function generator isn't accessible, neither for manual access nor for remote control, if

- resistance mode (R/I adjustment mode, also called UIR mode) is active.

#### 3.10.2.2 Principle

The power supply unit can't be considered as a high power function generator, because it's only post-connected to the FG. Thus the typical characteristics of a voltage and current source remain. Rise and fall times, caused by capacitor charge/discharge, affect the resulting signal on the DC output. While the FG is able to generate a sine wave with 1000 Hz or more, the power supply will never be able to follow the generated signal 1:1.

Depiction of principle:

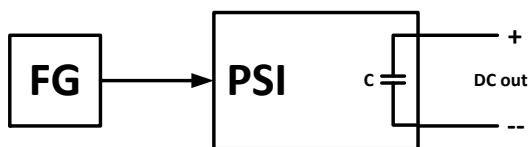

Affect of the power supply on functions:

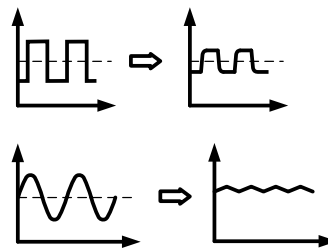

The resulting wave form on the DC output heavily depends on the frequency of the selected wave, its amplitude and the output capacitance. The effects of the power supply on the wave can only be partially compensated. For instance, it's possible to decrease the output voltage sinking time at low load conditions by adding a base load, one that is either permanently connected or temporarily switched.



*The minimum values of all adjustable parameters of the function generator, like for example a time of 0.1 ms, are not defined to match what a power supply device resp. every particular model can truly achieve.*

#### 3.10.2.3 Possible technical complications

Operation of switching mode power supplies as a voltage source can, when applying a function to the output voltage, lead to damage of the output capacitors due to continuous charging/discharging which causes overheating.

### 3.10.2.4 Minimum slope / maximum ramp time

When using a rising or falling DC offset, i. e. start offset doesn't equal end offset, with functions like ramp, trapezoid, triangle or even sine wave, it requires a minimum slope or else the adjusted settings would be neglected by the device. Calculating the minimum slope can help to determine if a certain ramp over time can be achieved by the device or not. Example: model PSI 9080-60 DT is going to be used, with 80 V and 60 A rating. **Formula: minimum slope = 0.000725 \* rated value / s.** For the example model it results in  $\Delta U/\Delta t$  of 58 mV/s and  $\Delta I/\Delta t$  of ca. 44 mA/s. The maximum time which can be achieved with the minimum slope then calculates as approximately 1379 seconds according to formula  $t_{Max} = \text{rated value} / \text{min. slope}$ .

### 3.10.3 Method of operation

In order to understand how the function generator works and how the value settings interact, the following should be noted:

**The device operates, including in function generator mode, always with the three set values U, I and P.**

The selected function can be used on one of both the values U or I, the other two are then constants and have a limiting effect. That means if, for example, a voltage of 10 V is set for the DC output, a load is connected and a sine wave function should operate on the current with an amplitude of 20 A and offset 20 A, then the function generator will create a sine wave progression of current between 0 A (min) and 40 A (max), which will result in an output power between 0 W (min) and 400 W (max). The output power, however, is limited to its set value. If this was 300 W then, in this case, the current would be limited to 30 A and, if clamped to an oscilloscope, it could be seen as truncated at 30 A and never reach the target of 40 A.

### 3.10.4 Manual operation

#### 3.10.4.1 Function selection and control



Via the touch screen all of the functions described in 3.10.1 can be selected, configured and controlled. This only available while the DC output is switched off.



#### ► How to select a function and adjust parameters

1. While the DC output is switched off, tap touch area  on the main screen.

2. In the menu overview tap on the touch area  and then on the desired function. The function selection screen (see figure above) will appear. Note: this touch area is locked in "R mode" (adjustable resistance).

3. Depending on the choice of function you would then be requested to select to which physical quantity the function is going to be applied:  or .

4. Adjust all necessary parameters.

 *Mind the minimum slope when setting up functions with ramps or, when using the arbitrary function, if the offset changes between start and end of a sequence point. See 3.10.2.4.*

5. Do not forget to adjust the overall limits of voltage, current and power, which you can access with touch



 *When entering function generator mode, those limits are reset to safe values, which can prevent the function from working at all. For example, if you apply the selected function to the output current, then the overall current limit should not interfere and should at least be as high as offset + amplitude.*



The settings of the various functions are described below. After setting it up, the function can be loaded.

## ► How to load a function

1. After setting the values for the required signal generation, tap on the

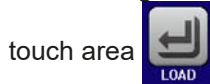

The device will then load the data into the internal controller and changes the display. Shortly afterwards the static values are set (power and voltage or current), the DC output is switched on and the touch area **START** enabled. Only then can the function be started.

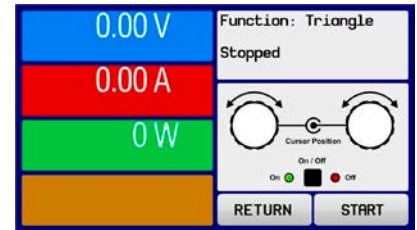

*The static values are applied to the DC output immediately after loading the function, because it switches the DC output on automatically in order to settle the start situation. These static values represent start and end values for the progress of the function, so that the function does not need to start from 0. Only exception: when applying any function to the current (I), there is no adjustable static current value, so the function would always start from 0 A.*

## ► How to start and stop a function

1. The function can be **started** either by tapping **START** or pushing the “On/Off” button, if the DC output is currently switched off. The function would then start immediately.
2. The function can be **stopped** either by tapping **STOP** or operating the “On/Off” button. However, there is a difference:
  - a) The **STOP** button stops only the function, the DC output remains ON with the static values.
  - b) The “On/Off” button stops the function and switches off the DC output.



*Every device alarm (overvoltage, overtemperature etc.), protection (OPP, OCP) or event with action = Alarm stops the function progress automatically, switches off the DC output and reports the alarm.*

### 3.10.5 Sine wave function

The following parameters can be configured for a sine wave function:

Value	Range	Description
I(A), U(A)	0...(Nominal value - (Offs)) of U, I	A = Amplitude of the signal to be generated
I(Offs), U(Offs)	(A)...(Nominal value - (A)) of U, I	Offs = Offset, based on the zero point of the mathematical sine curve, may not be smaller than the amplitude.
f (1/t)	1...10000 Hz	Static frequency of the signal to be generated

Schematic diagram:

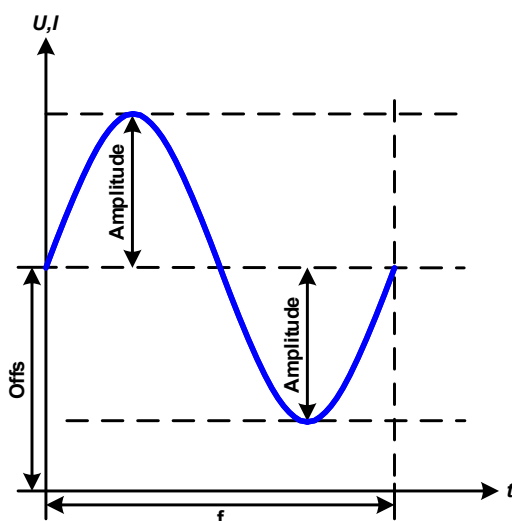

Application and result:

A normal sine wave signal is generated and applied to the selected set value, e. g. voltage (U). At a constant load resistance, the output voltage and thus also the output current will follow a sine wave.

For calculating the maximum power output the amplitude and offset values for the current have to be added.

Example: an output voltage of 30 V is set together with sin(I) with an amplitude of 12 A and an offset of 15 A. The resulting maximum power output is then achieved at the highest point of the sine wave and is  $(12 \text{ A} + 15 \text{ A}) * 30 \text{ V} = 810 \text{ W}$ .

### 3.10.6 Triangular function

The following parameters can be configured for a triangular wave function:

Value	Range	Description
I(A), U(A)	0...(Nominal value - (Offs)) of U, I	A = Amplitude of the signal to be generated
I(Offs), U(Offs)	0...(Nominal value - (A)) of U, I	Offs = Offset, based on the foot of the triangular wave
t1	0.1 ms...36000 s	Rising edge time $\Delta t$ of the triangular wave signal
t2	0.1 ms...36000 s	Falling edge time $\Delta t$ of the triangular wave signal

Schematic diagram:

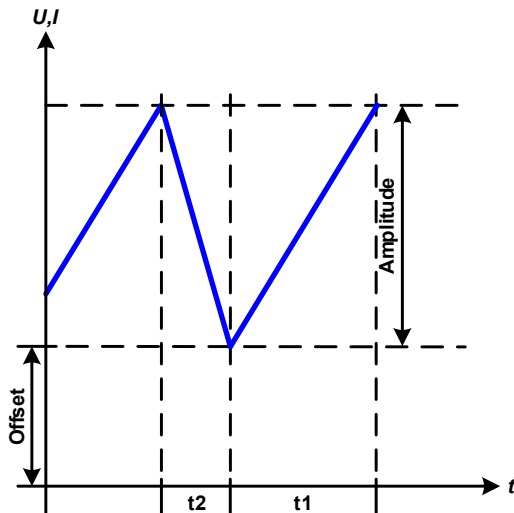

Application and result:

A triangular wave signal for output current (only effective in current limiting) or output voltage is generated. The positive and negative slope times can be set independently.

The offset shifts the signal on the Y-axis.

The sum of the intervals t1 and t2 gives the cycle time and its reciprocal is the frequency.

Example: a frequency of 10 Hz is required and would lead to periodic duration of 100 ms. This 100 ms can be freely allocated to t1 and t2, e. g. 50 ms:50 ms (isosceles triangle) or 99.9 ms:0.1 ms (right-angled triangle or sawtooth).

### 3.10.7 Rectangular function

The following parameters can be configured for a rectangular wave function:

Value	Range	Description
I(A), U(A)	0...(Nominal value - (Offs)) of U, I	A = Amplitude of the signal to be generated
I(Offs), U(Offs)	0...(Nominal value - (A)) of U, I	Offs = Offset, based on the foot of the rectangular wave
t1	0.1 ms...36000 s	Time (pulse width) of the upper level (amplitude)
t2	0.1 ms...36000 s	Time (pause width) of the lower level (offset)

Schematic diagram:

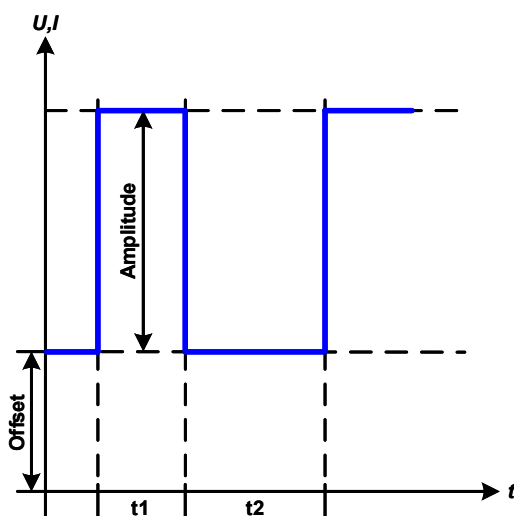

Application and result:

A rectangular or square wave signal for output current (only effective in current limiting) or output voltage is generated. The intervals t1 and t2 define how long the value of the amplitude (pulse) and how long the value of the offset (pause) are effective.

The offset shifts the signal on the Y-axis.

Intervals t1 and t2 can be used to define a duty cycle. The sum of t1 and t2 gives the cycle time and its reciprocal is the frequency.

Example: a rectangular wave signal of 25 Hz and a duty cycle of 80% are required. The sum of t1 and t2, the period, is  $1/25 \text{ Hz} = 40 \text{ ms}$ . For a duty cycle of 80% the pulse time (t1) is  $40 \text{ ms} \cdot 0.8 = 32 \text{ ms}$  and the pause time (t2) is 8 ms.

### 3.10.8 Trapezoidal function

The following parameters can be configured for a trapezoidal curve function:

Value	Range	Description
I(A), U(A)	0...(Nominal value - (Offs)) of U, I	A = Amplitude of the signal to be generated
I(Offs), U(Offs)	0...(Nominal value - (A)) of U, I	Offs = Offset, based on the foot of the trapezium
t1	0.1 ms...36000 s	Time for the positive slope of the trapezoidal wave signal.
t2	0.1 ms...36000 s	Time for the top value of the trapezoidal wave signal.
t3	0.1 ms...36000 s	Time for the negative slope of the trapezoidal wave signal.
t4	0.1 ms...36000 s	Time for the base value (offset) of the trapezoidal wave signal

Schematic diagram:

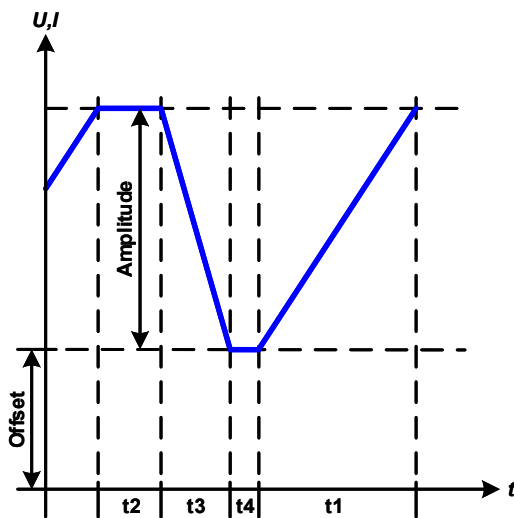

Application and result:

Here a trapezoidal signal can be applied to a set value of U or I. The slopes of the trapezium can be varied by setting different times for the rising and falling edge.

The sum of t1, t2, t3 and t4 results in the cycle time or periodic duration and its reciprocal is the frequency.

With suitable settings the trapezium can be deformed to a triangular or rectangular wave. It has, therefore, universal use.

### 3.10.9 DIN 40839 function

This function is based on the curve defined in DIN 40839 / EN ISO 7637 (test impulse 4) and is only applicable to voltage. It shall replicate the progress of the automobile battery voltage during engine starting. The curve is divided into 5 parts (see diagram below) which each have the same set of parameters. The standard values from the DIN are already set as default values for the five sequences.

The following parameters can be configured for the DIN40839 function:

Value	Range	Seq	Description
Ustart	0...Nominal value of U	1-5	Start voltage of the ramp
Uend	0...Nominal value of U	1-5	End voltage of the ramp
Seq.time	0.1 ms...36000 s	1-5	Time of the ramp
Seq.cycles	∞ or 1...999	-	Number of repetitions of the entire curve
Time t1	0.1 ms...36000 s	-	Time after cycle before repetition (cycle > 1)

Schematic diagram:

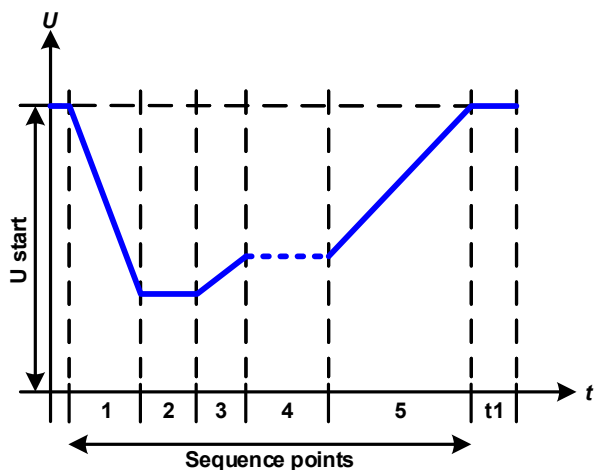

Application and result:

The function isn't suitable for standalone operation of a power supply, but optimal for a power supply in conjunction with an electronic load, such as one from EL 9000 DT series. The load acts as a sink for the rapid fall of the output voltage of the power supply enabling the output voltage progress to follow the DIN curve.

The curve conforms to test impulse 4 of the DIN. With suitable settings, other test impulses can be simulated. If the curve part in sequence point 4 should be a sine wave, then the function and its 5 sequence points would have to be transferred to the arbitrary generator.

### 3.10.10 Arbitrary function

The arbitrary (freely definable) function or function generator offers the user a wider scope of options. There are 99 curve segments (here: sequence points) available for use on either current (I) or voltage (U), all of which have the same set of parameters but can be differently configured, so that a complex function curve can be “constructed”. An arbitrary number out of the 99 sequence points can run in a sequence point block and this block can then be repeated up to 999 times or infinitely. Since the function must be assigned to either current or voltage, mix assignments of sequence point to both is not possible.

The arbitrary curve can overlay a linear progression (DC) with a sine curve (AC) whose amplitude and frequency is shaped between start and end. When both, start frequency and end frequency, are 0 Hz the AC overlay has no impact and only the DC part is effective. Each sequence point is allocated a sequence point time in which the AC/DC curve from start to end will be generated.

The following parameters can be configured for each sequence point:

Value	Range	Description
Is(AC) / Ie(AC)	0...50% of $I_{Nom}$	Start/end amplitude of the sine wave part (I mode)
Us(AC) / Ue(AC)	0...50% of $U_{Nom}$	Start/end amplitude of the sine wave part (U mode)
fs(1/T) / fe(1/T)	0 Hz...10000 Hz	Start/end frequency of the sine wave part (AC)
Angle	0°...359°	Start angle of the sine wave part (AC)
Is(DC)	Is(AC)...( $I_{Nom} - I_s(AC)$ )	Start value of the DC part (I mode)
Ie(DC)	Ie(AC)...( $I_{Nom} - I_e(AC)$ )	End value of the DC part (I mode)
Us(DC)	Us(AC)...( $U_{Nom} - U_s(AC)$ )	Start value of the DC part (U mode)
Ue(DC)	Ue(AC)...( $U_{Nom} - U_e(AC)$ )	End value of the DC part (U mode)
Seq.time	0.1 ms...36000 s	Time for the selected sequence point



*The sequence point time (Seq. time) and the start and end frequency are related. The minimum value for  $\Delta f/s$  is 9.3. Thus, for example, a setting of “fs” = 1 Hz, “fe” = 11 Hz and “Seq.time” = 5 s would not be accepted as  $\Delta f/s$  is only 2. A “Seq. time” of 1 s would be accepted, or, if the time remains at 5 s, then “fe” = 51 Hz must be set.*



*The amplitude change between start and end is related to the sequence point time. A minimal change over an extended time isn't possible and in such a case the device will report an inapplicable setting.*

After the settings for the selected sequence point are accepted with **SAVE**, further points can be configured. In a second settings screen, which is reached by tapping **NEXT** in the sequence point selection screen, following global settings for all 99 points are adjustable:

Value	Range	Description
Start seq.	1 ... End seq.	First sequence point in the sequence block
End seq.	Start seq. ... 99	Last sequence point in the sequence block
Seq. Cycles	$\infty$ or 1 ... 999	Number of cycles of the sequence block.

Schematic diagram:

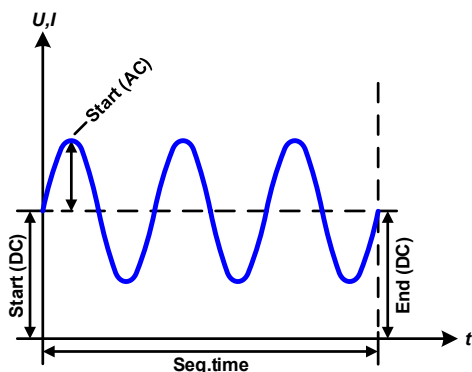

Applications and results:

#### Example 1

Focussing 1 cycle of 1 sequence point:

DC values for start and end are the same, also the AC amplitude. With a frequency >0 a sine wave progression of the set value is generated with a defined amplitude, frequency and Y-shift (offset, DC value at start and end)

The number of sine waves per cycle depend on the sequence point time and the frequency. If the sequence point time were 1 s and the frequency 1 Hz, there would be exactly 1 sine wave. If the time were 0.5 s at the same frequency, there would only be a half sine wave.

If you would adjust the time to match the period of 1 full wave and you would set the sequence cycles to infinite, it would generate a permanent sine wave with just 1 sequence point.

Schematic diagram:

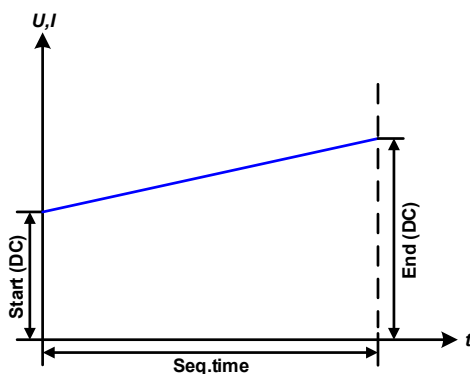
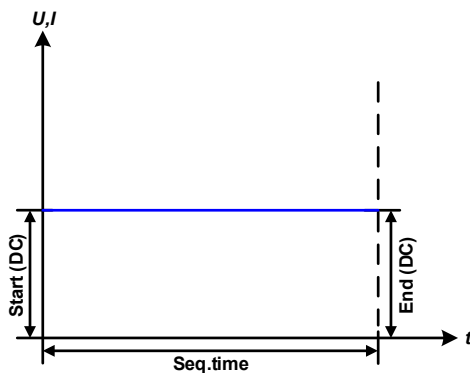
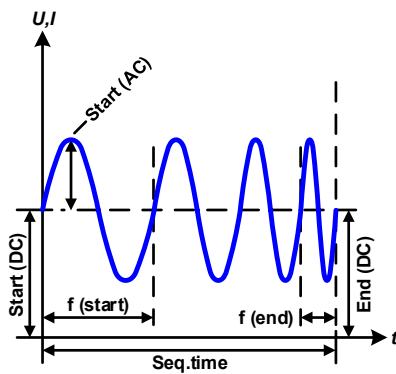
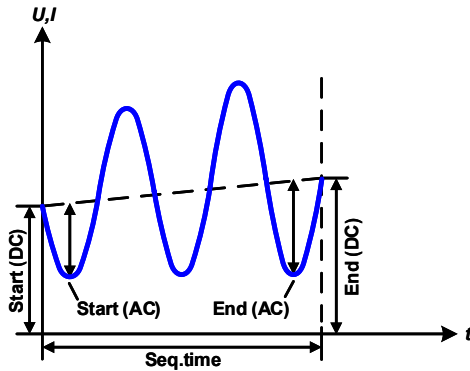
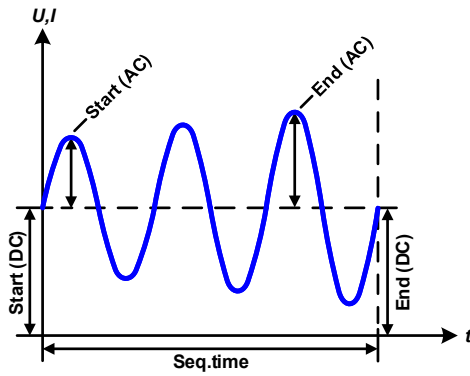

Applications and results:

## Example 2

Focussing 1 cycle of 1 sequence point:

The DC values of start and end are the same but the AC (amplitude) isn't. The end value is higher than the start value so the amplitude increases continuously with each new half sine wave through the sequence point. This, of course, only if the sequence point time and frequency allow for multiple waves to be generated. For instance, with  $f = 1 \text{ Hz}$  and **Seq. time** = 3 s, three complete waves would be generated (at **Angle** =  $0^\circ$ ) and reciprocally the same for  $f = 3 \text{ Hz}$  and **Seq. time** = 1 s.

## Example 3

Focussing 1 cycle of 1 sequence point:

The DC values of start and end are unequal, so are the AC values. In both cases the end value is higher than the start value so the offset increases from start to end (DC) and the amplitude also increases with each new half wave.

Additionally, the first wave starts with the negative half because the start angle has been set to  $180^\circ$ . The angle can be shifted at will in  $1^\circ$  steps between  $0^\circ$  and  $359^\circ$ .

## Example 4

Focussing 1 cycle of 1 sequence point:

Similar to example 1 but with a different end frequency. Here the wave depicted on the left shows the end frequency to be higher. This impacts the period of the sine waves such that each new wave will be shorter over the total span of the sequence point time.

## Example 5

Focussing 1 cycle of 1 sequence point:

Similar to example 1 but with a start and end frequency of 0 Hz. Without a frequency no sine wave part (AC) will be generated and only the DC settings will be effective. A ramp with a horizontal progression is generated, like it's required for a trapezium.

## Example 6

Focussing 1 cycle of 1 sequence point:

Similar to example 1 but with a start and end frequency of 0 Hz. Without a frequency no sine wave part (AC) will be created and only the DC settings will be effective. Here start and end values are unequal and a steadily increasing ramp is generated, like it's used with triangular, trapezoidal and ramp functions. Setting  $\text{End (DC)} > \text{Start (DC)}$  would turn the ramp into a falling one (ramp down).

By linking together a number of differently configured sequence points, complex progressions can be created. Smart configuration of the arbitrary generator can be used to match triangular, sine, rectangular or trapezoidal wave functions and thus, e. g. a curve of rectangular waves with differing amplitudes or duty cycles could be produced.

Schematic diagram:

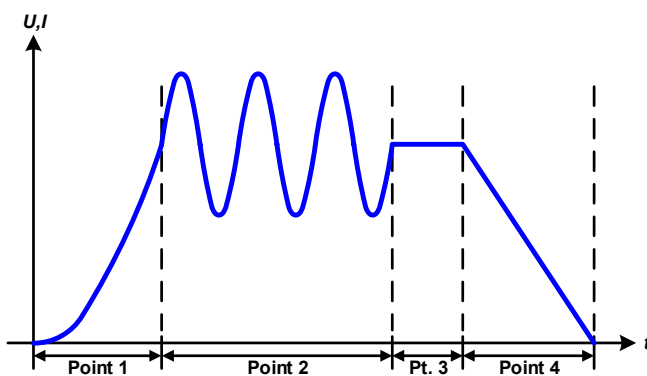
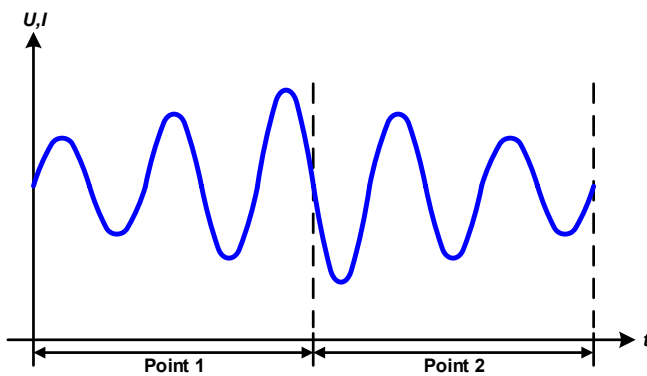
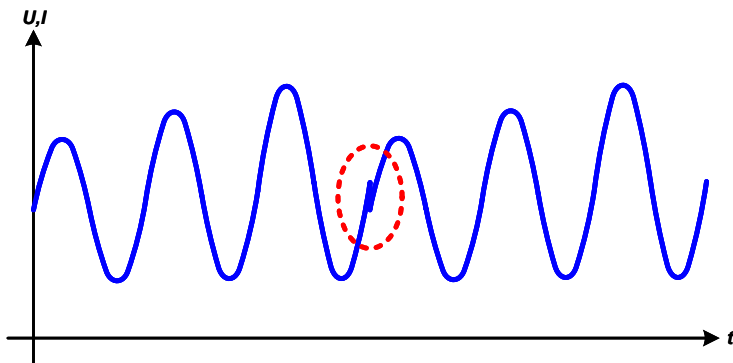

Applications and results:

### Example 7

Focussing 2 cycles of 1 sequence point:

A sequence configured as in example 3 is run. As the settings demand that the end offset (DC) is higher than the start, the second run will revert to the same start level as the first, regardless of the amplitude achieved at the end of the first run. This can produce a discontinuity in the total progression (marked in red) which may only be compensated with a careful choice of settings.

### Example 8

Focussing 1 cycle of 2 sequence points:

Two sequence points run consecutively. The first point generates a sine wave with increasing amplitude, the second with a decreasing one. Together they produce a progression as shown to the left. In order to ensure that the maximum amplitude in the middle occurs only once, the first sequence must end with a positive half wave and the second start with a negative half wave, as shown in the diagram.

### Example 9

Focussing 1 cycle of 4 sequence points:

Point 1: 1/4th of a sine wave (start angle = 270°)

Point 2: 3 sine waves (ratio of frequency to sequence point time = 1:3)

Point 3: Horizontal ramp (f = 0)

Point 4: Falling ramp (f = 0)

## 3.10.10.1 Loading and saving the arbitrary function

The 99 sequence points of the arbitrary function, which can be manually configured with the control panel of the device and which are applicable either to voltage (U) or current (I), can be saved to or loaded from a common USB stick via the front side USB port. Generally, all 99 points are saved or loaded using a text file of type CSV (semicolon separator), which represents a table of values.

In order to load a sequence point table for the arbitrary generator, following requirements have to be met:

- The table must contain exactly 99 rows (100 are also accepted for compatibility to older firmwares) with 8 subsequent columns and must not have gaps
- The column separator (semicolon or comma) must be as selected by MENU parameter **USB file separator format**; it also defines the decimal separator (dot or comma) of values
- The files must be stored inside a folder called HMI\_FILES which has to be in the root of the USB drive
- The file name must always start with WAVE\_U or WAVE\_I (not case-sensitive)
- All values in every row and column have to be within the specified range (see below)
- The columns in the table have to be in a defined order which must not be changed

Following value ranges are given for use in the CSV file, related to the manual HMI configuration of the arbitrary generator (column headers named like in Excel):

Column	Parameter	Range
A	AC start amplitude	0...50% U or I
B	AC end amplitude	0...50% U or I
C	Start frequency	0...10000 Hz
D	End frequency	0...10000 Hz
E	AC start angle	0...359°
F	DC start offset	0...(Nominal value of U or I) - AC start amplitude
G	DC end offset	0...(Nominal value of U or I) - AC end amplitude
H	Sequence point time in $\mu$ s	100...36.000.000.000 (36 billion $\mu$ s)

For details about the parameter and the arbitrary function refer to „3.10.10. Arbitrary function“.

Example CSV:



	A	B	C	D	E	F	G	H
1	20,00	30,00	5	5	90	50,00	50,00	50000000
2	30,00	20,00	5	5	90	50,00	50,00	30000000
3	0,00	0,00	0	0	0	0,00	0,00	1000
4	0,00	0,00	0	0	0	0,00	0,00	1000
5	0,00	0,00	0	0	0	0,00	0,00	1000
6	0,00	0,00	0	0	0	0,00	0,00	1000

The example shows that only the first two sequence points are configured, while all others are set to default values. The table could be loaded as WAVE\_U or WAVE\_I when using, for example, the model PSI 9080-60 DT, because the values would fit both, voltage and current. The file naming, however, is unique. A filter prevents you from loading a WAVE\_I file after you have selected **Arbitrary --> U** in the function generator menu. The file would not be listed at all.

### ► How to load a sequence point table from an USB stick

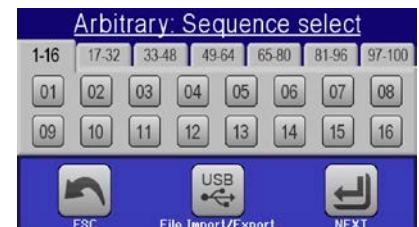
1. Do not plug the USB stick yet or remove it again.
2. Access the function selection menu of the function generator with **MENU -> Function Generator -> Arbitrary -> U/I**, to see the main screen of the sequence selector, as depicted to the right.



3. Tap touch area , then  and follow the instructions on screen. If at least one valid file has been detected (for file and path naming see 1.9.5.5), the device will show a list of files to select from with . Put the check mark next to desired file.

4. Tap touch area  in the bottom right corner. The selected file is then checked and loaded, if valid. In case it isn't valid, the device will show an error message. Then the file must be corrected and the steps repeated.

► How to save a sequence point table to an USB stick:

1. Do not plug the USB stick yet or remove it again.
2. Access the function selection menu of the function generator via **MENU -> Function Generator -> Arbitrary -> U/I**.



3. Tap on **File Import/Export**, then **SAVE to USB**. The device will request you to plug the USB stick now.
4. After plugging it, the device will try to access the stick, then to find the folder HMI\_FILES and read the content. If there are already WAVE\_U or WAVE\_I files present, they will be listed and you can either select one for overwriting with , otherwise select **-NEW FILE-**.



5. Finally save the table with **SAVE to USB**.

### 3.10.11 Ramp Function

The following parameters can be configured for a ramp function.

Value	Range	Description
Ustart / Istart	0...Nominal value of U, I	Start value (U,I)
Uend / Iend	0...Nominal value of U, I	End value (U, I)
t1	0.1 ms...36000 s	Time before ramp-up or ramp-down of the signal.
t2	0.1 ms...36000 s	Ramp-up or ramp-down time

Schematic diagram:

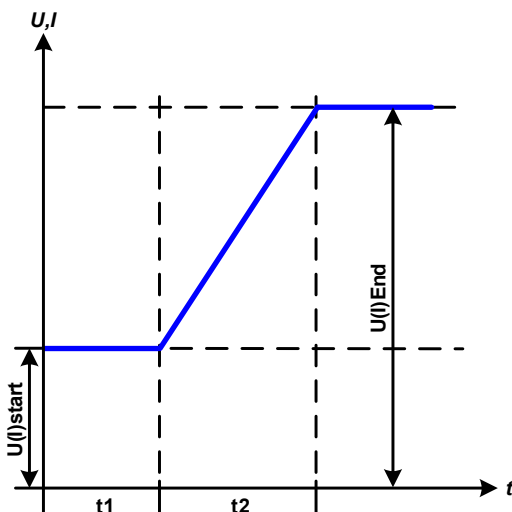

Application and result:

This function generates a rising or falling ramp between start and end values over the time t2. Time t1 creates a delay before the ramp start.

The function runs once and stops at the end value.

Important to consider are the static values of U or I which define the start levels at the beginning of the ramp. It's recommended that these values are set equal to those set for Ustart/Istart, unless the load at the DC output shall not be provided with voltage before the start of the ramp. In that case the static value should be set to zero.



*10 h after reaching the end of the ramp the function will stop automatically with either I = 0 A or U = 0 V, unless it has been stopped differently before.*

### 3.10.12 Remote control of the function generator

The function generator can be remotely controlled, but configuration and control of the functions with individual commands is different from manual operation. The external documentation "Programming Guide ModBus & SCPI" explains the approach. In general the following apply:

- The function generator isn't directly controllable via the analog interface; the only impact to the function run can come from pin REM-SB switching the DC output off, which will pause the function, so it could continue later with pin REM-SB switching the DC output on again and in case the function hasn't been stopped otherwise.
- The function generator is unavailable as long as R mode (resistance) is activated



### 3.11 Other applications

#### 3.11.1 Series connection

Series connection of two or multiple devices is basically possible, but for reasons of safety and isolation following restrictions apply:



- Both, negative (DC-) and positive (DC+) output poles are coupled to PE via type X capacitors, limiting the max. allowed potential shift (see technical specs for rating)
- Remote sensing must not be connected!
- Series connection is only allowed for devices of the same and with the same ratings, but at least same current rating, i.e. power supply with power supply like, for instance, PSI 9080-60 DT with PSI 9080-60 DT or PSI 9080-60 T or similar

Series connection isn't explicitly supported by additional connectors and signals on the devices. Nothing else than output current and voltage is shared. It means, all units have to be controlled separately regarding set values and DC output status, whether it's manual or remote control.

According to the limit of the potential shift that comes with series connection (also see sections „2.3.6. *Grounding of the DC output*“ and „1.8.3. *Specific technical data*“, item “Insulation”), models with a certain nominal output voltage must not be connected in series at all, like the 750 V model. There the DC minus is only isolated up to  $\pm 400$  V DC against PE. On the contrary, two 360 V units are allowed to be connected in series.

The analog interfaces of units in series connection are also allowed to be wired in parallel, because they are galvanically isolated from the device and the DC output. The grounds (AGND, DGND) on the analog interfaces are furthermore allowed to be directly connected to PE, like it can automatically happen when controlling and directly connecting the analog interface a PC, because the ground inside PCs is usually directly tied to PE.

#### 3.11.2 Parallel operation

Multiple devices of same kind and ideally same model can be connected in parallel in order to create a system with higher total current and hence higher power. This can be achieved by connecting all units to the DC load in parallel, so the single currents can add. There is no support for current and thus power balancing between the individual units, like in form of a master-slave system. All power supplies would have to be controlled and set up separately. However, it's possible to have a parallel control by feeding the signals on the analog interfaces. There are a few general points to consider and adhere:

- Always make parallel connections only with devices of same voltage, current and power rating
- Never connect DC cables from power supply to power supply, but instead from every power supply directly to the load, else the total current could exceed the current rating of the DC output clamps

#### 3.11.3 Operation as battery charger

A power supply can be used as a battery charger, but with some restrictions, because it misses a battery supervision and a physical separation from the load in form of a contactor, which is usually featured with true battery chargers as a protection against overvoltage or reversed polarity. A sort of a battery supervision and management can be achieved by creating custom software or also by using the battery test function in the software EA Power Control.

Following has to be considered:

- **No false polarity protection inside!** Connecting a battery with false polarity will damage the power supply severely, even if it isn't powered.
- All models of this series have an internal high resistive base load. This load would discharge a permanently connected battery slowly but constantly, even if the device isn't powered, and perhaps down to deep discharge. It's thus recommend to leave batteries connected only as long they're charged (normal charge, trickle charge).

## 4. Service and maintenance

### 4.1 Maintenance / cleaning

The device requires no maintenance. Cleaning may become necessary for the internal fans, the frequency of cleanse is depending on the ambient conditions. The fans serve to cool the internal components which are heated by the inherent power loss. Heavily dirt filled fans can lead to insufficient airflow and therefore the DC output would switch off too early due to overheating or possibly lead to defects.

Cleaning the internal fans can be performed with a vacuum cleaner or similar. For this the device needs to be opened.

### 4.2 Fault finding / diagnosis / repair

If the equipment suddenly performs in an unexpected way, which indicates a fault, or it has an obvious defect, this can't and mustn't be repaired by the user. Contact the supplier in case of suspicion and elicit the steps to be taken.

It will then usually be necessary to return the device to the supplier (with or without guarantee). If a return for checking or repair is to be carried out, ensure that:

- the supplier has been contacted and it's clarified how and where the equipment should be sent.
- the device is in fully assembled state and in suitable transport packaging, ideally the original packaging.
- a fault description in as much detail as possible is attached.
- if shipping destination is abroad, the necessary customs papers are attached.

#### 4.2.1 Replacing a defect mains fuse

The AC input of the device is protected by a 5x 20 mm fuse (for value check fuse body or technical specifications in 1.8.3) which is located on the rear of the device, inside a fuse holder (separate or in the AC socket, depends on the model). To replace the fuse, the device isn't required to be opened. Just remove the power cord and open the fuse holder with a flat screw driver. The replacement fuse must be of same value and type.

#### 4.2.2 Firmware updates



Firmware updates should only be installed when they can eliminate existing bugs in the firmware in the device or contain new features.

The firmware of the control panel (HMI), of the communication unit (KE) and the digital controller (DR), if necessary, is updated via the rear side USB port. For this the software "EA Power Control" is needed which is included with the device or available as download from our website together with the firmware update, or upon request.

However, be advised not to install updates promptly. Every update includes the risk of an inoperable device or system. We recommend to install updates only if...

- an imminent problem with your device can directly be solved, especially if we suggested to install an update during a support case
- a new feature has been added which you definitely want to use. In this case, the full responsibility is transferred to you.

Following also applies in connection with firmware updates:

- Simple changes in firmwares can have crucial effects on the application the devices are use in. We thus recommend to study the list of changes in the firmware history very thoroughly.
- Newly implemented features may require an updated documentation (user manual and/or programming guide, as well as LabView VIs), which is often delivered only later, sometimes significantly later

## 4.3 Calibration

### 4.3.1 Preface

The devices of series PSI 9000 DT feature a function to readjust the most important output values when doing a calibration and in case these values have moved out of tolerance. The readjustment is limited to compensate small differences of up to 2% of the max. value. There are several reasons which could make it necessary to readjust the device: component aging, component deterioration, extreme ambient conditions, high frequent use.

In order to determine if a value is out of tolerance, the parameter must first be verified with measurement equipment of high accuracy, but at least of half the measuring error of the PSI device. Only then a comparison between values displayed on the PSI device and true DC output values is possible.

For example, if you want to verify and possibly readjust the output current of model PSI 9080-60 DT with its max. 60 A and a current tolerance (or error) stated as max. 0.2%, you can only do that by using a suitable shunt with a max. 0.1% error or less. Also, when measuring such high currents, it's recommended to keep the process short, in order to avoid the shunt heating up too much. It's furthermore recommended to use a shunt with at least 25% reserve.

When measuring the current with a shunt, the measurement error of the multimeter attached to the shunt adds to the error of the shunt and the sum of both must not exceed the max. error of the device under calibration.

### 4.3.2 Preparation

For a successful calibration and readjustment, a few tools and certain ambient conditions are required:

- A measurement device (multimeter) for voltage, with a max. error of half of the PSI's voltage error. That measurement device can also be used to measure the shunt voltage when readjusting the current
- If the current is also going to be calibrated: a suitable DC current shunt, ideally specified for at least 1.25 times the max. output current of the PSI and with a max. error that is half of or less than the max. current error of the PSI device
- Normal ambient temperature of approx. 20-25°C
- An adjustable load, such as an electronic load, which is capable of consuming at least 102% of the max. voltage and current of the PSI device
- In case the remote sensing input is going to be calibrated, prepare a cable for the connection of remote sensing input (SENSE) to the DC load, but leave it yet unconnected

Before you can start calibrating, a few measures have to be taken:

- Warmed up PSI unit, which has run for at least 10 minutes with at least 50% power
- Abort any form of remote control, deactivate master-slave mode, disable resistance mode
- Install the shunt between PSI device and load and make sure the shunt is cooled somehow
- Connect external measurement device (multimeter) to the DC output or to the shunt, depending on whether the voltage is going to be calibrated first or the current, or use two multimeters

### 4.3.3 Calibration procedure

After the preparation, the device is ready to be calibrated. From now on, a certain sequence of parameter calibration is important. Generally, you don't need to calibrate all three parameters, but it's recommended to do so.

Important:



*When calibrating the output voltage and actual voltage display, the remote sensing input "Sense" on the rear of the device must not be disconnected.*

The calibration procedure, as explained below, is an example with model PSI 9080-60 DT. Other models are treated the same way, with values according to the particular PSI model and the required load.

### 4.3.3.1 Calibrating the set values

#### ► How to calibrate the voltage

1. Connect a multimeter to the DC output. Connect a load and set its current to approx. 5% of the rated current of the power supply, in this example  $\approx 3$  A, and 0 V, if the load is electronic.
2. In the display tap MENU, then **General Settings**, then go down to **Calibrate device** and then tap **START**.
3. In the next screen select **Voltage calibration**, then **Calibrate output val.** and **NEXT**. The power supply will switch the DC output on, set a certain output voltage and show the measured value as **U-mon**.
4. The next screen requests you to enter the measured output voltage from the multimeter in **Measured value=**. Tap the value to make a keypad appear and use it to enter the new value. Assure yourself the value is correct and submit with **ENTER**.
5. Repeat point 4. for the next three steps (total of four steps).

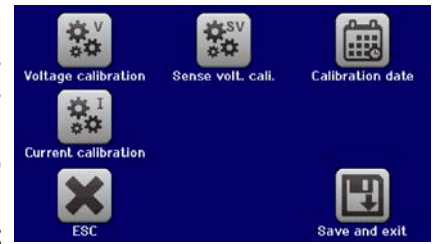

#### ► How to calibrate the current

1. Set the load to approx. 102% nominal current of the PSI device. For the sample model with 60 A this would be 61.2 A, rounded to 61 A.
2. In the display tap MENU, then **General Settings**, then go down to **Calibrate device** and then tap **START**.
3. In the next screen select **Current calibration**, then **Calibrate output val.** and **NEXT**. The device will switch the DC output on, set a certain current limit while being loaded and show the measured output current as **I-mon**.
4. The next screen requests you to enter the output current in **Measured value=**, as measured with the shunt. Tap the value to make a keypad appear and use it to enter the new value. Assure yourself it's correct and submit with **ENTER**.
5. Repeat point 4. for the next three steps (total of four steps).

### 4.3.3.2 Calibrating the remote sensing

In case you are generally using the remote sensing feature, it's recommended to also readjust its measuring circuit for best results. The procedure is identical to the calibration of voltage, except for it requires to have the sensing connector (Sense) on the rear to be plugged and connected with correct polarity to the DC output of the PSI.

#### ► How to calibrate the remote sensing voltage

1. Connect a load and set its current to approx. 5% of the rated current of the power supply, in this example  $\approx 3$  A, and also set 0 V, if the load is electronic. Connect the remote sensing input (Sense) to the DC terminal of the load with correct polarity and connect a multimeter there in parallel.
2. In the display tap MENU, then **General Settings**, then go down to **Calibrate device** and then tap **START**.
3. In the next screen select **Sense volt. calibration**, then **Calibrate output val.** and **NEXT**.
4. The next screen requests you to enter the measured sensing voltage from the multimeter in **Measured data=**. Tap the value to make a keypad appear and use it to enter the new value. Assure yourself the value is correct and submit with **ENTER**.
5. Repeat point 4. for the next three steps (total of four steps).

### 4.3.3.3 Calibrating the actual values

The actual values of output voltage (with and without remote sensing) and output current are calibrated almost the same way as the set values, but here you don't need to enter anything, you would only confirm the displayed values. Please proceed the above steps and instead of **Calibrate output val.** select **Calibrate actual val.** in the submenus. After the device shows the measured value on display, wait at least 2 seconds for the value to settle and then tap **NEXT** until you are through all steps.

## 4.3.3.4 Save and exit

After calibration you may furthermore enter the calibration date by tapping



in the selection screen and enter the date in format YYYY / MM / DD.

Last but not least save the calibration data by tapping



Leaving the calibration selection menu without tapping “Save and exit” will discard all calibration data and the procedure would have to be repeated!

## 5. Contact and support

### 5.1 General

Repairs, if not otherwise arranged between supplier and customer, will be carried out by the manufacturer. For this the device must generally be returned to the manufacturer. No RMA number is needed. It's sufficient to package the equipment adequately and send it, together with a detailed description of the fault and, if still under guarantee, a copy of the invoice, to the following address.

### 5.2 Contact options

Questions or problems with operation of the device, use of optional components, with the documentation or software, can be addressed to technical support either by telephone or e-Mail.

Headquarter	e-Mail	Telephone
EA Elektro-Automatik GmbH Helmholtzstr. 31-37 41747 Viersen Germany	Support: support@elektroautomatik.com All other issues: ea1974@elektroautomatik.com	Switchboard: +49 2162 / 37850 Support: +49 2162 / 378566



**Elektro-Automatik**

**EA Elektro-Automatik GmbH & Co. KG**

Development - Production - Sales

Helmholtzstraße 31-37

**41747 Viersen**

**Germany**

Fon: +49 2162 37 850

Fax: +49 02162 16 230

Mail: [ea1974@elektroautomatik.com](mailto:ea1974@elektroautomatik.com)

Web: [www.elektroautomatik.com](http://www.elektroautomatik.com)