



Operating Guide

PS 9000 T

DC Laboratory Power Supply



Attention! This document is only valid for devices with firmware "KE: 3.07" and "HMI: 2.04" or higher. For the availability of updates check our website.

Doc ID: PS9TEN
Revision: 02
Date: 09/2019



TABLE OF CONTENTS

1 GENERAL

1.1	About this document	4
1.1.1	Retention and use	4
1.1.2	Copyright	4
1.1.3	Validity	4
1.1.4	Symbols and warnings	4
1.2	Warranty	4
1.3	Limitation of liability	4
1.4	Disposal of equipment	5
1.5	Product key	5
1.6	Intended usage	5
1.7	Safety	6
1.7.1	Safety notices	6
1.7.2	Responsibility of the user	7
1.7.3	Responsibility of the operator	7
1.7.4	User requirements	7
1.7.5	Alarm signals	8
1.8	Technical Data	8
1.8.1	Approved operating conditions	8
1.8.2	General technical data	8
1.8.3	Specific technical data	9
1.8.4	Views	19
1.8.5	Control elements	22
1.9	Construction and function	23
1.9.1	General description	23
1.9.2	Block diagram	23
1.9.3	Scope of delivery	24
1.9.4	Optional accessories	24
1.9.5	The control panel (HMI)	25
1.9.6	USB port (rear side)	27
1.9.7	“Sense” connector (remote sensing)	27
1.9.8	Ethernet port	28
1.9.9	Analog interface	28

2 INSTALLATION & COMMISSIONING

2.1	Storage	29
2.1.1	Packaging	29
2.1.2	Storage	29
2.2	Unpacking and visual check	29
2.3	Installation	29
2.3.1	Safety procedures before installation and use	29
2.3.2	Preparation	29
2.3.3	Installing the device	29
2.3.4	Connection to DC loads	31
2.3.5	Grounding of the DC output	31
2.3.6	Connection of remote sensing	32
2.3.7	Connecting the analog interface	32
2.3.8	Connecting the USB port (rear side)	32
2.3.9	Initial commission	33
2.3.10	Commission after a firmware update or a long period of non-use	33

3 OPERATION AND APPLICATION

3.1	Personal safety	34
3.2	Operating modes	34
3.2.1	Voltage regulation / Constant voltage	34
3.2.2	Current regulation / constant current / current limiting	35
3.2.3	Power regulation / constant power / power limiting	35
3.3	Alarm conditions	36
3.3.1	Power Fail	36
3.3.2	Overtemperature	36
3.3.3	Overvoltage protection	36
3.3.4	Overcurrent protection	36
3.3.5	Overpower protection	36
3.4	Manual operation	37
3.4.1	Switching on the device	37
3.4.2	Switching off the device	37
3.4.3	Configuration via MENU	37
3.4.4	Adjustment limits (Limits)	41
3.4.5	Manual adjustment of set values	41
3.4.6	Switching the main screen view	43
3.4.7	Switching the DC output on or off	43
3.4.8	Recording to USB stick (logging)	44
3.5	Remote control	45
3.5.1	General	45
3.5.2	Control locations	45
3.5.3	Remote control via a digital interface	45
3.5.4	Remote control via the analog interface (AI)	46
3.6	Alarms and monitoring	50
3.6.1	Device alarm handling	50
3.7	Control panel (HMI) lock	51
3.8	Limits lock	51
3.9	Loading and saving an user profile	52
3.10	Other applications	53
3.10.1	Series connection	53
3.10.2	Parallel operation	53
3.10.3	Operation as battery charger	53

4 SERVICE AND MAINTENANCE

4.1	Maintenance / cleaning	54
4.2	Fault finding / diagnosis / repair	54
4.2.1	Replacing a defect mains fuse	54
4.2.2	Firmware updates	54
4.3	Calibration	55
4.3.1	Preface	55
4.3.2	Preparation	55
4.3.3	Calibration procedure	55

5 CONTACT AND SUPPORT

5.1	Repairs	57
5.2	Contact options	57

1. General

1.1 About this document

1.1.1 Retention and use

This document is to be kept in the vicinity of the equipment for future reference and explanation of the operation of the device. This document is to be delivered and kept with the equipment in case of change of location and/or user.

1.1.2 Copyright

Reprinting, copying, also partially, usage for other purposes as foreseen of this manual are forbidden and breach may lead to legal process.



1.1.3 Validity

This manual is valid for the following equipment:

Model	Article number	Model	Article number
PS 9040-20 T	06200440	PS 9080-40 T	06200447
PS 9080-10 T	06200441	PS 9200-15 T	06200448
PS 9200-04 T	06200442	PS 9500-06 T	06200449
PS 9040-40 T	06200443	PS 9040-60 T	06200450
PS 9080-20 T	06200444	PS 9080-60 T	06200451
PS 9200-10 T	06200445	PS 9200-25 T	06200452
PS 9040-40 T	06200446	PS 9500-10 T	06200453

1.1.4 Symbols and warnings

Warning and safety notices as well as general notices in this document are shown in a box with a symbol as follows:

	Symbol for a life threatening danger
	Symbol for general safety notices (instructions and damage protection bans) or important information for operation
	<i>Symbol for general notices</i>

1.2 Warranty

EA Elektro-Automatik guarantees the functional competence of the applied technology and the stated performance parameters. The warranty period begins with the delivery of free from defects equipment.

Terms of guarantee are included in the general terms and conditions (TOS) of EA Elektro-Automatik.

1.3 Limitation of liability

All statements and instructions in this manual are based on current norms and regulations, up-to-date technology and our long term knowledge and experience. The manufacturer accepts no liability for losses due to:

- Usage for purposes other than designed
- Use by untrained personnel
- Rebuilding by the customer
- Technical changes
- Use of not authorized spare parts

The actual delivered device(s) may differ from the explanations and diagrams given here due to latest technical changes or due to customized models with the inclusion of additionally ordered options.

1.4 Disposal of equipment

A piece of equipment which is intended for disposal must, according to European laws and regulations (ElektroG, WEEE) be returned to the manufacturer for scrapping, unless the person operating the piece of equipment or another, delegated person is conducting the disposal. Our equipment falls under these regulations and is accordingly marked with the following symbol:



1.5 Product key

Decoding of the product description on the label, using an example:

PS 9 080 - 40 T

					Construction (not printed everywhere) T = Tower model
					Maximum current of the device in Ampere
					Maximum voltage of the device in Volt
					Series : 9 = Series 9000
					Type identification: PS = Power Supply, always programmable

1.6 Intended usage

The equipment is intended to be used, if a power supply or battery charger, only as a variable voltage and current source, or, if an electronic load, only as a variable current sink.

Typical application for a power supply is DC supply to any relevant user, for a battery charger the charging of various battery types and for electronic loads the replacement of an ohmic resistor by an adjustable DC current sink in order to load relevant voltage and current sources of any type.



- Claims of any sort due to damage caused by non-intended usage will not be accepted.
- All damage caused by non-intended usage is solely the responsibility of the operator.

1.7 Safety

1.7.1 Safety notices

Mortal danger - Hazardous voltage



- **Electrical equipment operation means that some parts can be under dangerous voltage. Therefore all parts under voltage must be covered! This basically applies to all models, though 40 V models according to SELV can not generate hazardous DC voltage.**
- **All work on connections must be carried out under zero voltage (output not connected to load) and may only be performed by qualified and informed persons. Improper actions can cause fatal injury as well as serious material damage.**
- **Never touch the contact on the AC cables or AC socket directly after unplugging from mains supply as the danger of electric shock remains for a short moment!**
- **Never touch the contacts on DC output terminal directly after switching off the DC output, because there still can dangerous voltage present, sinking more or less slowly depending on the load! There also can be dangerous potential between negative DC output to PE or positive DC output to PE due to charged X capacitors.**



- The equipment must only be used as intended
- The equipment is only approved for use within the connection limits stated on the product label.
- Do not insert any object, particularly metallic, through the ventilator slots
- Avoid any use of liquids near the equipment. Protect the device from wet, damp and condensation.
- For power supplies and battery chargers: do not connect users, particularly low resistance, to devices under power; sparking may occur which can cause burns as well as damage to the equipment and to the user.
- For electronic loads: do not connect power sources to equipment under power, sparking may occur which can cause burns as well as damage to the equipment and to the source.
- ESD regulations must be applied when plugging interface cards or modules into the relative slot
- Interface cards or modules may only be attached or removed after the device is switched off. It's not necessary to open the device.
- Do not connect external power sources with reversed polarity to DC input or outputs! The equipment will be damaged.
- For power supply devices: avoid where possible connecting external power sources to the DC output, and never those that can generate a higher voltage than the nominal voltage of the device.
- For electronic loads: do not connect a power source to the DC input which can generate a voltage more than 120% of the nominal input voltage of the load. The equipment isn't protected against over voltage and may be irreparably damaged.
- Never insert a network cable which is connected to Ethernet or its components into the master-slave socket on the back side of the device!
- Always configure the various protecting features against overvoltage overpower etc. for sensitive loads to what the currently used application requires

1.7.2 Responsibility of the user

The equipment is in industrial operation. Therefore the operators are governed by the legal safety regulations. Alongside the warning and safety notices in this manual the relevant safety, accident prevention and environmental regulations must also be applied. In particular the users of the equipment:

- must be informed of the relevant job safety requirements
- must work to the defined responsibilities for operation, maintenance and cleaning of the equipment
- before starting work must have read and understood the operating manual
- must use the designated and recommended safety equipment.

Furthermore, anyone working with the equipment is responsible for ensuring that the device is at all times technically fit for use.

1.7.3 Responsibility of the operator

Operator is any natural or legal person who uses the equipment or delegates the usage to a third party, and is responsible during its usage for the safety of the user, other personnel or third parties.

The equipment is in industrial operation. Therefore the operators are governed by the legal safety regulations. Alongside the warning and safety notices in this manual the relevant safety, accident prevention and environmental regulations must also be applied. In particular the operator has to

- be acquainted with the relevant job safety requirements
- identify other possible dangers arising from the specific usage conditions at the work station via a risk assessment
- introduce the necessary steps in the operating procedures for the local conditions
- regularly control that the operating procedures are current
- update the operating procedures where necessary to reflect changes in regulation, standards or operating conditions.
- define clearly and unambiguously the responsibilities for operation, maintenance and cleaning of the equipment.
- ensure that all employees who use the equipment have read and understood the manual. Furthermore the users are to be regularly schooled in working with the equipment and the possible dangers.
- provide all personnel who work with the equipment with the designated and recommended safety equipment

Furthermore, the operator is responsible for ensuring that the device is at all times technically fit for use.

1.7.4 User requirements

Any activity with equipment of this type may only be performed by persons who are able to work correctly and reliably and satisfy the requirements of the job.

- Persons whose reaction capability is negatively influenced by e.g. drugs, alcohol or medication may not operate the equipment.
- Age or job related regulations valid at the operating site must always be applied.



Danger for unqualified users

Improper operation can cause person or object damage. Only persons who have the necessary training, knowledge and experience may use the equipment.

Delegated persons are those who have been properly and demonstrably instructed in their tasks and the attendant dangers.

Qualified persons are those who are able through training, knowledge and experience as well as knowledge of the specific details to carry out all the required tasks, identify dangers and avoid personal and other risks.

1.7.5 Alarm signals

The equipment offers various possibilities for signalling alarm conditions, however, not for danger situations. They are signalled optically (on the display as text) and electronically (pin/status output of an analog interface) and digitally (digital interface). All alarms will cause the device to switch off the DC output.

The meaning of the signals is as follows:

Signal OT (OverTemperature)	<ul style="list-style-type: none"> • Overheating of the device • DC output will be switched off • Non-critical
Signal OVP (OverVoltage)	<ul style="list-style-type: none"> • Overvoltage shutdown of the DC output due to high voltage entering the device or generated by the device itself due to a defect • Critical! The device and/or the load could be damaged
Signal OCP (OverCurrent)	<ul style="list-style-type: none"> • Shutdown of the DC output due to excess of the preset limit • Non-critical, protects the load from excessive current consumption
Signal OPP (OverPower)	<ul style="list-style-type: none"> • Shutdown of the DC output due to excess of the preset limit • Non-critical, protects the load from excessive power consumption
Signal PF (Power Fail)	<ul style="list-style-type: none"> • DC output shutdown due to AC undervoltage or defect in the AC input • Critical on overvoltage! AC input circuit could be damaged

1.8 Technical Data

1.8.1 Approved operating conditions

- Use only inside dry buildings
- Ambient temperature 0-50°C
- Operational altitude: max. 2000 m above sea level
- Max. 80% relative humidity, non-condensing

1.8.2 General technical data

Display: Colour TFT touch screen with gorilla glass, 3.5", 320 pt x 240 pt, capacitive

Controls: 2 rotary knobs with pushbutton functions, 2 pushbutton

The nominal values for the device determine the maximum adjustable ranges.

1.8.3 Specific technical data

320 W	Model		
	PS 9040-20 T	PS 9080-10 T	PS 9200-04 T
AC Input			
Voltage range	90...264 V AC	90...264 V AC	90...264 V AC
Connection	1ph,N,PE	1ph,N,PE	1ph,N,PE
Frequency	45-65 Hz	45-65 Hz	45-65 Hz
Fusing	MT 8 A	MT 8 A	MT 8 A
Leak current	< 3.5 mA	< 3.5 mA	< 3.5 mA
Power factor	≈ 0.99	≈ 0.99	≈ 0.99
DC Output			
Max. output voltage U_{Max}	40 V	80 V	200 V
Max. output current I_{Max}	20 A	10 A	4 A
Max. output power P_{Max}	320 W	320 W	320 W
Overvoltage protection range	0...44 V	0...88 V	0...220 V
Overcurrent protection range	0...22 A	0...11 A	0...4.4 A
Overpower protection range	0...352 W	0...352 W	0...352 W
Output capacitance	4760 μ F	3400 μ F	720 μ F
Temperature coefficient for set values Δ/K	Voltage / current: 100 ppm		
Voltage regulation			
Adjustment range	0...40.8 V	0...81.6 V	0...204 V
Accuracy ⁽¹⁾ (at 23 \pm 5°C)	< 0.1% U_{Max}	< 0.1% U_{Max}	< 0.1% U_{Max}
Line regulation at $\pm 10\%$ ΔU_{AC}	< 0.02% U_{Max}	< 0.02% U_{Max}	< 0.02% U_{Max}
Load regulation at 0...100% load	< 0.05% U_{Max}	< 0.05% U_{Max}	< 0.05% U_{Max}
Rise time 0...100% (@full load)	Max. 30 ms	Max. 60 ms	Max. 65 ms
Settling time after load step	< 1.5 ms	< 1.5 ms	< 1.5 ms
Display: Resolution	See section „1.9.5.4. Resolution of the displayed values“		
Display: Accuracy ⁽³⁾	$\leq 0.2\%$ U_{Max}	$\leq 0.2\%$ U_{Max}	$\leq 0.2\%$ U_{Max}
Ripple ⁽²⁾	< 20 mV _{PP} < 2 mV _{RMS}	< 20 mV _{PP} < 2 mV _{RMS}	< 50 mV _{PP} < 6 mV _{RMS}
Remote sensing compensation	Max. 5% U_{Max}	Max. 5% U_{Max}	Max. 5% U_{Max}
Output voltage fall time (at no load) after switching DC output off	-	Down from 100% to <60 V: less than 10 s	
Current regulation			
Adjustment range	0...20.4 A	0...10.2 A	0...4.08 A
Accuracy ⁽¹⁾ (at 23 \pm 5°C)	< 0.2% I_{Max}	< 0.2% I_{Max}	< 0.2% I_{Max}
Line regulation at $\pm 10\%$ ΔU_{AC}	< 0.05% I_{Max}	< 0.05% I_{Max}	< 0.05% I_{Max}
Load regulation at 0...100% ΔU_{OUT}	< 0.15% I_{Max}	< 0.15% I_{Max}	< 0.15% I_{Max}
Ripple ⁽²⁾	< 1 mA _{RMS}	< 1 mA _{RMS}	< 1.5 mA _{RMS}
Display: Resolution	See section „1.9.5.4. Resolution of the displayed values“		
Display: Accuracy ⁽³⁾	$\leq 0.2\%$ I_{Max}	$\leq 0.2\%$ I_{Max}	$\leq 0.2\%$ I_{Max}
Power regulation			
Adjustment range	0...326.4 W	0...326.4 W	0...326.4 W
Accuracy ⁽¹⁾ (at 23 \pm 5°C)	< 1% P_{Max}	< 1% P_{Max}	< 1% P_{Max}
Line regulation at $\pm 10\%$ ΔU_{AC}	< 0.05% P_{Max}	< 0.05% P_{Max}	< 0.05% P_{Max}
Load reg. at 10-90% ΔU_{OUT} * ΔI_{OUT}	< 0.75% P_{Max}	< 0.75% P_{Max}	< 0.75% P_{Max}

(1 Related to the nominal values, the accuracy defines the maximum deviation between an adjusted values and the true (actual) value.

Example: a 80 V model has min. 0.1% voltage accuracy, that is 80 mV. When adjusting the voltage to 5 V, the actual value is allowed to differ max. 80 mV, which means it might be between 4.92 V and 5.08 V.

(2 RMS value: LF 0...300 kHz, PP value: HF 0...20 MHz

(3 The display error adds to the error of the related actual value on the DC output

320 W	Model		
	PS 9040-20 T	PS 9080-10 T	PS 9200-04 T
Power regulation			
Display: Resolution	See section „1.9.5.4. Resolution of the displayed values“		
Display: Accuracy ⁽²⁾	≤ 0.8% P _{Max}	≤ 0.8% P _{Max}	≤ 0.8% P _{Max}
Efficiency ⁽⁴⁾	≈ 92%	≈ 92%	≈ 93%
Analog interface (optional) ⁽³⁾			
Set value inputs	U, I, P		
Actual value output	U, I		
Control signals	DC on/off, remote control on/off		
Status signals	CV, OVP, OT		
Galvanic isolation to the device	Max. 400 V _{DC}		
Sample rate of inputs & outputs	500 Hz		
Insulation			
Output (DC) to enclosure (PE)	DC minus: permanent max. ±400 V DC plus: permanent max. ±400 V + output voltage		
Input (AC) to output (DC)	Max. 2500 V, short-term		
Miscellaneous			
Cooling	Temperature controlled fan (60 mm), side inlet, rear exhaust		
Ambient temperature	0..50°C		
Storage temperature	-20...70°C		
Humidity	< 80%, not condensing		
Standards	EN 61010-1:2011-07, EN 61000-6-2:-2016-05, EN 61000-6-3:2011-09 Class B		
Overtoltage category	2		
Protection class	1		
Pollution degree	2		
Operational altitude	< 2000 m		
Digital interfaces			
Built-in (default)	1x USB-B for communication, 1x USB-A		
Built-in (optional)	1x LAN for communication		
Galvanic isolation from device	Max. 400 V _{DC}		
Terminals			
Rear side	AC input, analog interface (optional), USB-B, Ethernet (optional)		
Front side	DC output, USB-A, remote sensing		
Dimensions			
Enclosure (WxHxD)	92 x 237 x 352 mm		
Total (WxHxD)	92 x 239 x min. 401 mm		
Weight	≈ 7.5 kg	≈ 7.5 kg	≈ 7.5 kg
Article number	06200440	06200441	06200442

(1 Related to the nominal values, the accuracy defines the maximum deviation between an adjusted values and the true (actual) value.

(2 The display error adds to the error of the related actual value on the DC output

(3 For technical specifications of the analog interface see „3.5.4.4 Analog interface specification“ on page 47

(4 Typical value at 100% output voltage and 100% power

640 W	Model		
	PS 9040-40 T	PS 9080-20 T	PS 9200-10 T
AC Input			
Voltage range	90...264 V AC	90...264 V AC	90...264 V AC
Connection	1ph,N,PE	1ph,N,PE	1ph,N,PE
Frequency	45-65 Hz	45-65 Hz	45-65 Hz
Fusing	MT 8 A	MT 8 A	MT 8 A
Leak current	< 3.5 mA	< 3.5 mA	< 3.5 mA
Power factor	≈ 0.99	≈ 0.99	≈ 0.99
DC Output			
Max. output voltage U_{Max}	40 V	80 V	200 V
Max. output current I_{Max}	40 A	20 A	10 A
Max. output power P_{Max}	640 W	640 W	640 W
Overvoltage protection range	0...44 V	0...88 V	0...220 V
Overcurrent protection range	0...44 A	0...22 A	0...11 A
Overpower protection range	0...704 W	0...704 W	0...704 W
Output capacitance	4760 μ F	3400 μ F	720 μ F
Temperature coefficient for set values Δ/K	Voltage / current: 100 ppm		
Voltage regulation			
Adjustment range	0...40.8 V	0...81.6 V	0...204 V
Accuracy ⁽¹⁾ (at 23 ± 5°C)	< 0.1% U_{Max}	< 0.1% U_{Max}	< 0.1% U_{Max}
Line regulation at ±10% ΔU_{AC}	< 0.02% U_{Max}	< 0.02% U_{Max}	< 0.02% U_{Max}
Load regulation at 0...100% load	< 0.05% U_{Max}	< 0.05% U_{Max}	< 0.05% U_{Max}
Rise time 0...100% (@full load)	Max. 30 ms	Max. 60 ms	Max. 65 ms
Settling time after load step	< 1.5 ms	< 1.5 ms	< 1.5 ms
Display: Resolution	See section „1.9.5.4. Resolution of the displayed values“		
Display: Accuracy ⁽³⁾	≤ 0.2% U_{Max}	≤ 0.2% U_{Max}	≤ 0.2% U_{Max}
Ripple ⁽²⁾	< 20 mV _{PP} < 2 mV _{RMS}	< 20 mV _{PP} < 2 mV _{RMS}	< 50 mV _{PP} < 6 mV _{RMS}
Remote sensing compensation	Max. 5% U_{Max}	Max. 5% U_{Max}	Max. 5% U_{Max}
Output voltage fall time (at no load) after switching DC output off	-	Down from 100% to <60 V: less than 10 s	
Current regulation			
Adjustment range	0...40.8 A	0...20.4 A	0...10.2 A
Accuracy ⁽¹⁾ (at 23 ± 5°C)	< 0.2% I_{Max}	< 0.2% I_{Max}	< 0.2% I_{Max}
Line regulation at ±10% ΔU_{AC}	< 0.05% I_{Max}	< 0.05% I_{Max}	< 0.05% I_{Max}
Load regulation at 0...100% ΔU_{OUT}	< 0.15% I_{Max}	< 0.15% I_{Max}	< 0.15% I_{Max}
Ripple ⁽²⁾	< 1 mA _{RMS}	< 1 mA _{RMS}	< 1.5 mA _{RMS}
Display: Resolution	See section „1.9.5.4. Resolution of the displayed values“		
Display: Accuracy ⁽³⁾	≤ 0.2% I_{Max}	≤ 0.2% I_{Max}	≤ 0.2% I_{Max}
Power regulation			
Adjustment range	0...652.8 W	0...652.8 W	0...652.8 W
Accuracy ⁽¹⁾ (at 23 ± 5°C)	< 1% P_{Max}	< 1% P_{Max}	< 1% P_{Max}
Line regulation at ±10% ΔU_{AC}	< 0.05% P_{Max}	< 0.05% P_{Max}	< 0.05% P_{Max}
Load reg. at 10-90% ΔU_{OUT} * ΔI_{OUT}	< 0.75% P_{Max}	< 0.75% P_{Max}	< 0.75% P_{Max}

(1 Related to the nominal values, the accuracy defines the maximum deviation between an adjusted values and the true (actual) value.
Example: a 80 V model has min. 0.1% voltage accuracy, that is 80 mV. When adjusting the voltage to 5 V, the actual value is allowed to differ max. 80 mV, which means it might be between 4.92 V and 5.08 V.
(2 RMS value: LF 0...300 kHz, PP value: HF 0...20 MHz
(3 The display error adds to the error of the related actual value on the DC output

640 W	Model		
	PS 9040-40 T	PS 9080-20 T	PS 9200-10 T
Power regulation			
Display: Resolution	See section „1.9.5.4. Resolution of the displayed values“		
Display: Accuracy ⁽²⁾	≤ 0.8% P _{Max}	≤ 0.8% P _{Max}	≤ 0.8% P _{Max}
Efficiency ⁽⁴⁾	≈ 92%	≈ 92%	≈ 93%
Analog interface (optional) ⁽³⁾			
Set value inputs	U, I, P		
Actual value output	U, I		
Control signals	DC on/off, remote control on/off		
Status signals	CV, OVP, OT		
Galvanic isolation to the device	Max. 400 V _{DC}		
Sample rate of inputs & outputs	500 Hz		
Insulation			
Output (DC) to enclosure (PE)	DC minus: permanent max. ±400 V DC plus: permanent max. ±400 V + output voltage		
Input (AC) to output (DC)	Max. 2500 V, short-term		
Miscellaneous			
Cooling	Temperature controlled fan (60 mm), side inlet, rear exhaust		
Ambient temperature	0..50°C		
Storage temperature	-20...70°C		
Humidity	< 80%, not condensing		
Standards	EN 61010-1:2011-07, EN 61000-6-2-:2016-05, EN 61000-6-3:2011-09 Class B		
Overvoltage category	2		
Protection class	1		
Pollution degree	2		
Operational altitude	< 2000 m		
Digital interfaces			
Built-in (default)	1x USB-B for communication, 1x USB-A		
Built-in (optional)	1x LAN for communication		
Galvanic isolation from device	Max. 400 V _{DC}		
Terminals			
Rear side	AC input, analog interface (optional), USB-B, Ethernet (optional)		
Front side	DC output, USB-A, remote sensing		
Dimensions			
Enclosure (WxHxD)	92 x 237 x 352 mm		
Total (WxHxD)	92 x 239 x min. 401 mm		
Weight	≈ 7.5 kg	≈ 7.5 kg	≈ 7.5 kg
Article number	06200443	06200444	06200445

(1 Related to the nominal values, the accuracy defines the maximum deviation between an adjusted values and the true (actual) value.

(2 The display error adds to the error of the related actual value on the DC output

(3 For technical specifications of the analog interface see „3.5.4.4 Analog interface specification“ on page 47

(4 Typical value at 100% output voltage and 100% power

1000 W	Model		
	PS 9040-40 T	PS 9080-40 T	PS 9200-15 T
AC Input			
Voltage range	90...264 V AC	90...264 V AC	90...264 V AC
Connection	1ph,N,PE	1ph,N,PE	1ph,N,PE
Frequency	45-65 Hz	45-65 Hz	45-65 Hz
Fusing	T 16 A	T 16 A	T 16 A
Leak current	< 3.5 mA	< 3.5 mA	< 3.5 mA
Power factor	≈ 0.99	≈ 0.99	≈ 0.99
DC Output			
Max. output voltage U_{Max}	40 V	80 V	200 V
Max. output current I_{Max}	40 A	40 A	15 A
Max. output power P_{Max}	1000 W	1000 W	1000 W
Overvoltage protection range	0...44 V	0...88 V	0...220 V
Overcurrent protection range	0...44 A	0...44 A	0...16.5 A
Overpower protection range	0...1100 W	0...1100 W	0...1100 W
Output capacitance	6120 μ F	6120 μ F	1020 μ F
Temperature coefficient for set values Δ/K	Voltage / current: 100 ppm		
Voltage regulation			
Adjustment range	0...40.8 V	0...81.6 V	0...204 V
Accuracy ⁽¹⁾ (at 23 \pm 5°C)	< 0.1% U_{Max}	< 0.1% U_{Max}	< 0.1% U_{Max}
Line regulation at $\pm 10\%$ ΔU_{AC}	< 0.02% U_{Max}	< 0.02% U_{Max}	< 0.02% U_{Max}
Load regulation at 0...100% load	< 0.05% U_{Max}	< 0.05% U_{Max}	< 0.05% U_{Max}
Rise time 0...100% (@full load)	Max. 40 ms	Max. 40 ms	Max. 40 ms
Settling time after load step	< 1.5 ms	< 1.5 ms	< 1.5 ms
Display: Resolution	See section „1.9.5.4. Resolution of the displayed values“		
Display: Accuracy ⁽³⁾	\leq 0.2% U_{Max}	\leq 0.2% U_{Max}	\leq 0.2% U_{Max}
Ripple ⁽²⁾	< 25 mV _{PP} < 4 mV _{RMS}	< 25 mV _{PP} < 4 mV _{RMS}	< 150 mV _{PP} < 23 mV _{RMS}
Remote sensing compensation	Max. 5% U_{Max}	Max. 5% U_{Max}	Max. 5% U_{Max}
Output voltage fall time (at no load) after switching DC output off	-	Down from 100% to <60 V: less than 10 s	
Current regulation			
Adjustment range	0...40.8 A	0...40.8 A	0...15.3 A
Accuracy ⁽¹⁾ (at 23 \pm 5°C)	< 0.2% I_{Max}	< 0.2% I_{Max}	< 0.2% I_{Max}
Line regulation at $\pm 10\%$ ΔU_{AC}	< 0.05% I_{Max}	< 0.05% I_{Max}	< 0.05% I_{Max}
Load regulation at 0...100% ΔU_{OUT}	< 0.15% I_{Max}	< 0.15% I_{Max}	< 0.15% I_{Max}
Ripple ⁽²⁾	< 6 mA _{RMS}	< 6 mA _{RMS}	< 1.8 mA _{RMS}
Display: Resolution	See section „1.9.5.4. Resolution of the displayed values“		
Display: Accuracy ⁽³⁾	\leq 0.2% I_{Max}	\leq 0.2% I_{Max}	\leq 0.2% I_{Max}
Power regulation			
Adjustment range	0...1020 W	0...1020 W	0...1020 W
Accuracy ⁽¹⁾ (at 23 \pm 5°C)	< 1% P_{Max}	< 1% P_{Max}	< 1% P_{Max}
Line regulation at $\pm 10\%$ ΔU_{AC}	< 0.05% P_{Max}	< 0.05% P_{Max}	< 0.05% P_{Max}
Load reg. at 10-90% ΔU_{OUT} * ΔI_{OUT}	< 0.75% P_{Max}	< 0.75% P_{Max}	< 0.75% P_{Max}

(1 Related to the nominal values, the accuracy defines the maximum deviation between an adjusted values and the true (actual) value.

Example: a 80 V model has min. 0.1% voltage accuracy, that is 80 mV. When adjusting the voltage to 5 V, the actual value is allowed to differ max. 80 mV, which means it might be between 4.92 V and 5.08 V.

(2 RMS value: LF 0...300 kHz, PP value: HF 0...20 MHz

(3 The display error adds to the error of the related actual value on the DC output

1000 W	Model		
	PS 9040-40 T	PS 9080-40 T	PS 9200-15 T
Power regulation			
Display: Resolution	See section „1.9.5.4. Resolution of the displayed values“		
Display: Accuracy ⁽²⁾	≤ 0.8% P _{Max}	≤ 0.8% P _{Max}	≤ 0.8% P _{Max}
Efficiency ⁽⁴⁾	≈ 92%	≈ 92%	≈ 92%
Analog interface (optional) ⁽³⁾			
Set value inputs	U, I, P		
Actual value output	U, I		
Control signals	DC on/off, remote control on/off		
Status signals	CV, OVP, OT		
Galvanic isolation to the device	Max. 400 V _{DC}		
Sample rate of inputs & outputs	500 Hz		
Insulation			
Output (DC) to enclosure (PE)	DC minus: permanent max. ±400 V DC plus: permanent max. ±400 V + output voltage		
Input (AC) to output (DC)	Max. 2500 V, short-term		
Miscellaneous			
Cooling	Temperature controlled fan (60 mm), side inlet, rear exhaust		
Ambient temperature	0..50°C		
Storage temperature	-20...70°C		
Humidity	< 80%, not condensing		
Standards	EN 61010-1:2011-07, EN 61000-6-2-:2016-05, EN 61000-6-3:2011-09 Class B		
Overvoltage category	2		
Protection class	1		
Pollution degree	2		
Operational altitude	< 2000 m		
Digital interfaces			
Built-in (default)	1x USB-B for communication, 1x USB-A		
Built-in (optional)	1x LAN for communication		
Galvanic isolation from device	Max. 400 V _{DC}		
Terminals			
Rear side	AC input, analog interface (optional), USB-B, Ethernet (optional)		
Front side	DC output, USB-A, remote sensing		
Dimensions			
Enclosure (WxHxD)	92 x 237 x 412 mm		
Total (WxHxD)	92 x 239 x min. 461 mm		
Weight	≈8.5 kg	≈8.5 kg	≈8.5 kg
Article number	06200446	06200447	06200448

(1 Related to the nominal values, the accuracy defines the maximum deviation between an adjusted values and the true (actual) value.

(2 The display error adds to the error of the related actual value on the DC output

(3 For technical specifications of the analog interface see „3.5.4.4 Analog interface specification“ on page 47

(4 Typical value at 100% output voltage and 100% power

1000 / 1500 W	Model		
	PS 9500-06 T	PS 9040-60 T	PS 9080-60 T
AC Input			
Voltage range without derating	90...264 V AC	150...264 V AC	150...264 V AC
Voltage range with derating	-	90...150 V AC	90...150 V AC
Connection	1ph,N,PE	1ph,N,PE	1ph,N,PE
Frequency	45-65 Hz	45-65 Hz	45-65 Hz
Fusing	T 16 A	T 16 A	T 16 A
Leak current	< 3.5 mA	< 3.5 mA	< 3.5 mA
Power factor	≈ 0.99	≈ 0.99	≈ 0.99
DC Output			
Max. output voltage U_{Max}	500 V	40 V	80 V
Max. output current I_{Max}	6 A	60 A	60 A
Max. output power P_{Max}	1000 W	1500 W	1500 W
Max. output power P_{Max} with derating	-	1000 W	1000 W
Overvoltage protection range	0...550 V	0...44 V	0...88 V
Overcurrent protection range	0...6.6 A	0...66 A	0...66 A
Overpower protection range	0...1100 W	0...1650 W	0...1650 W
Output capacitance	130 μ F	6120 μ F	6120 μ F
Temperature coefficient for set values Δ/K	Voltage / current: 100 ppm		
Voltage regulation			
Adjustment range	0...510 V	0...40.8 V	0...81.6 V
Accuracy ⁽¹⁾ (at 23 \pm 5°C)	< 0.1% U_{Max}	< 0.1% U_{Max}	< 0.1% U_{Max}
Line regulation at $\pm 10\%$ ΔU_{AC}	< 0.02% U_{Max}	< 0.02% U_{Max}	< 0.02% U_{Max}
Load regulation at 0...100% load	< 0.05% U_{Max}	< 0.05% U_{Max}	< 0.05% U_{Max}
Rise time 0...100% (@full load)	Max. 30 ms	Max. 40 ms	Max. 40 ms
Settling time after load step	< 1.5 ms	< 1.5 ms	< 1.5 ms
Display: Resolution	See section „1.9.5.4. Resolution of the displayed values“		
Display: Accuracy ⁽³⁾	$\leq 0.2\%$ U_{Max}	$\leq 0.2\%$ U_{Max}	$\leq 0.2\%$ U_{Max}
Ripple ⁽²⁾	< 155 mV _{PP} < 33 mV _{RMS}	< 25 mV _{PP} < 4 mV _{RMS}	< 25 mV _{PP} < 4 mV _{RMS}
Remote sensing compensation	Max. 5% U_{Max}	Max. 5% U_{Max}	Max. 5% U_{Max}
Output voltage fall time (at no load) after switching DC output off	Down from 100% to <60 V: less than 10 s	-	Down from 100% to <60 V: less than 10 s
Current regulation			
Adjustment range	0...6.12 A	0...61.2 A	0...61.2 A
Accuracy ⁽¹⁾ (at 23 \pm 5°C)	< 0.2% I_{Max}	< 0.2% I_{Max}	< 0.2% I_{Max}
Line regulation at $\pm 10\%$ ΔU_{AC}	< 0.05% I_{Max}	< 0.05% I_{Max}	< 0.05% I_{Max}
Load regulation at 0...100% ΔU_{OUT}	< 0.15% I_{Max}	< 0.15% I_{Max}	< 0.15% I_{Max}
Ripple ⁽²⁾	< 8 mA _{RMS}	< 6 mA _{RMS}	< 6 mA _{RMS}
Display: Resolution	See section „1.9.5.4. Resolution of the displayed values“		
Display: Accuracy ⁽³⁾	$\leq 0.2\%$ I_{Max}	$\leq 0.2\%$ I_{Max}	$\leq 0.2\%$ I_{Max}
Power regulation			
Adjustment range	0...1020 W	0...1530 W	0...1530 W
Accuracy ⁽¹⁾ (at 23 \pm 5°C)	< 1% P_{Max}	< 1% P_{Max}	< 1% P_{Max}
Line regulation at $\pm 10\%$ ΔU_{AC}	< 0.05% P_{Max}	< 0.05% P_{Max}	< 0.05% P_{Max}
Load reg. at 10-90% ΔU_{OUT} * ΔI_{OUT}	< 0.75% P_{Max}	< 0.75% P_{Max}	< 0.75% P_{Max}

(1 Related to the nominal values, the accuracy defines the maximum deviation between an adjusted values and the true (actual) value.

Example: a 80 V model has min. 0.1% voltage accuracy, that is 80 mV. When adjusting the voltage to 5 V, the actual value is allowed to differ max. 80 mV, which means it might be between 4.92 V and 5.08 V.

(2 RMS value: LF 0...300 kHz, PP value: HF 0...20 MHz

(3 The display error adds to the error of the related actual value on the DC output

1000 / 1500 W	Model		
	PS 9500-06 T	PS 9040-60 T	PS 9080-60 T
Power regulation			
Display: Resolution	See section „1.9.5.4. Resolution of the displayed values“		
Display: Accuracy ⁽²⁾	≤ 0.8% P _{Max}	≤ 0.8% P _{Max}	≤ 0.8% P _{Max}
Efficiency ⁽⁴⁾	≈ 93%	≈ 92%	≈ 92%
Analog interface (optional) ⁽³⁾			
Set value inputs	U, I, P		
Actual value output	U, I		
Control signals	DC on/off, remote control on/off		
Status signals	CV, OVP, OT		
Galvanic isolation to the device	Max. 400 V _{DC}		
Sample rate of inputs & outputs	500 Hz		
Insulation			
Output (DC) to enclosure (PE)	DC minus: permanent max. ±400 V DC plus: permanent max. ±400 V + output voltage		
Input (AC) to output (DC)	Max. 2500 V, short-term		
Miscellaneous			
Cooling	Temperature controlled fan (60 mm), side inlet, rear exhaust		
Ambient temperature	0..50°C		
Storage temperature	-20...70°C		
Humidity	< 80%, not condensing		
Standards	EN 61010-1:2011-07, EN 61000-6-2-:2016-05, EN 61000-6-3:2011-09 Class B		
Overvoltage category	2		
Protection class	1		
Pollution degree	2		
Operational altitude	< 2000 m		
Digital interfaces			
Built-in (default)	1x USB-B for communication, 1x USB-A		
Built-in (optional)	1x LAN for communication		
Galvanic isolation from device	Max. 400 V _{DC}		
Terminals			
Rear side	AC input, analog interface (optional), USB-B, Ethernet (optional)		
Front side	DC output, USB-A, remote sensing		
Dimensions			
Enclosure (WxHxD)	92 x 237 x 412 mm		
Total (WxHxD)	92 x 239 x min. 461 mm		
Weight	≈8.5 kg	≈8.5 kg	≈8.5 kg
Article number	06200449	06200450	06200451

(1 Related to the nominal values, the accuracy defines the maximum deviation between an adjusted values and the true (actual) value.

(2 The display error adds to the error of the related actual value on the DC output

(3 For technical specifications of the analog interface see „3.5.4.4 Analog interface specification“ on page 47

(4 Typical value at 100% output voltage and 100% power

1500 W	Model	
	PS 9200-25 T	PS 9500-10 T
AC Input		
Voltage range without derating	150...264 V AC	150...264 V AC
Voltage range with derating	90...150 V AC	90...150 V AC
Connection	1ph,N,PE	1ph,N,PE
Frequency	45-65 Hz	45-65 Hz
Fusing	T 16 A	T 16 A
Leak current	< 3.5 mA	< 3.5 mA
Power factor	≈ 0.99	≈ 0.99
DC Output		
Max. output voltage U_{Max}	200 V	500 V
Max. output current I_{Max}	25 A	10 A
Max. output power P_{Max}	1500 W	1500 W
Max. output power P_{Max} with derating	1000 W	1000 W
Overvoltage protection range	0...220 V	0...550 V
Overcurrent protection range	0...27,5 A	0...11 A
Overpower protection range	0...1650 W	0...1650 W
Output capacitance	1020 μ F	130 μ F
Temperature coefficient for set values Δ/K	Voltage / current: 100 ppm	
Voltage regulation		
Adjustment range	0...204 V	0...510 V
Accuracy ⁽¹⁾ (at 23 \pm 5 °C)	< 0.1% U_{Max}	< 0.1% U_{Max}
Line regulation at $\pm 10\%$ ΔU_{AC}	< 0.02% U_{Max}	< 0.02% U_{Max}
Load regulation at 0...100% load	< 0.05% U_{Max}	< 0.05% U_{Max}
Rise time 0...100% (@full load)	Max. 40 ms	Max. 30 ms
Settling time after load step	< 1.5 ms	< 1.5 ms
Display: Resolution	See section „1.9.5.4. Resolution of the displayed values“	
Display: Accuracy ⁽³⁾	$\leq 0.2\%$ U_{Max}	$\leq 0.2\%$ U_{Max}
Ripple ⁽²⁾	< 150 mV _{PP} < 33 mV _{RMS}	< 155 mV _{PP} < 33 mV _{RMS}
Remote sensing compensation	Max. 5% U_{Max}	Max. 5% U_{Max}
Output voltage fall time (at no load) after switching DC output off	Down from 100% to <60 V: less than 10 s	
Current regulation		
Adjustment range	0...25.5 A	0...10.2 A
Accuracy ⁽¹⁾ (at 23 \pm 5 °C)	< 0.2% I_{Max}	< 0.2% I_{Max}
Line regulation at $\pm 10\%$ ΔU_{AC}	< 0.05% I_{Max}	< 0.05% I_{Max}
Load regulation at 0...100% ΔU_{OUT}	< 0.15% I_{Max}	< 0.15% I_{Max}
Ripple ⁽²⁾	< 1.8 mA _{RMS}	< 8 mA _{RMS}
Display: Resolution	See section „1.9.5.4. Resolution of the displayed values“	
Display: Accuracy ⁽³⁾	$\leq 0.2\%$ I_{Max}	$\leq 0.2\%$ I_{Max}
Power regulation		
Adjustment range	0...1530 W	0...1530 W
Accuracy ⁽¹⁾ (at 23 \pm 5 °C)	< 1% P_{Max}	< 1% P_{Max}
Line regulation at $\pm 10\%$ ΔU_{AC}	< 0.05% P_{Max}	< 0.05% P_{Max}
Load reg. at 10-90% $\Delta U_{OUT} * \Delta I_{OUT}$	< 0.75% P_{Max}	< 0.75% P_{Max}

(1 Related to the nominal values, the accuracy defines the maximum deviation between an adjusted values and the true (actual) value.

Example: a 80 V model has min. 0.1% voltage accuracy, that is 80 mV. When adjusting the voltage to 5 V, the actual value is allowed to differ max. 80 mV, which means it might be between 4.92 V and 5.08 V.

(2 RMS value: LF 0...300 kHz, PP value: HF 0...20 MHz

(3 The display error adds to the error of the related actual value on the DC output

1500 W	Model	
	PS 9200-25 T	PS 9500-10 T
Power regulation		
Display: Resolution	See section „1.9.5.4. Resolution of the displayed values“	
Display: Accuracy ⁽²⁾	≤ 0.8% P _{Max}	≤ 0.8% P _{Max}
Efficiency ⁽⁴⁾	≈ 92%	≈ 92%
Analog interface (optional) ⁽³⁾		
Set value inputs	U, I, P	
Actual value output	U, I	
Control signals	DC on/off, remote control on/off	
Status signals	CV, OVP, OT	
Galvanic isolation to the device	Max. 400 V _{DC}	
Sample rate of inputs & outputs	500 Hz	
Insulation		
Output (DC) to enclosure (PE)	DC minus: permanent max. ±400 V DC plus: permanent max. ±400 V + output voltage	
Input (AC) to output (DC)	Max. 2500 V, short-term	
Miscellaneous		
Cooling	Temperature controlled fan (60 mm), side inlet, rear exhaust	
Ambient temperature	0..50°C	
Storage temperature	-20...70°C	
Humidity	< 80%, not condensing	
Standards	EN 61010-1:2011-07, EN 61000-6-2-:2016-05, EN 61000-6-3:2011-09 Class B	
Overvoltage category	2	
Protection class	1	
Pollution degree	2	
Operational altitude	< 2000 m	
Digital interfaces		
Built-in (default)	1x USB-B for communication, 1x USB-A	
Built-in (optional)	1x LAN for communication	
Galvanic isolation from device	Max. 400 V _{DC}	
Terminals		
Rear side	AC input, analog interface (optional), USB-B, Ethernet (optional)	
Front side	DC output, USB-A, remote sensing	
Dimensions		
Enclosure (WxHxD)	92 x 237 x 412 mm	
Total (WxHxD)	92 x 239 x min. 461 mm	
Weight	≈8.5 kg	≈8.5 kg
Article number	06200452	06200453

(1 Related to the nominal values, the accuracy defines the maximum deviation between an adjusted values and the true (actual) value.

(2 The display error adds to the error of the related actual value on the DC output

(3 For technical specifications of the analog interface see „3.5.4.4 Analog interface specification“ on page 47

(4 Typical value at 100% output voltage and 100% power

1.8.4 Views

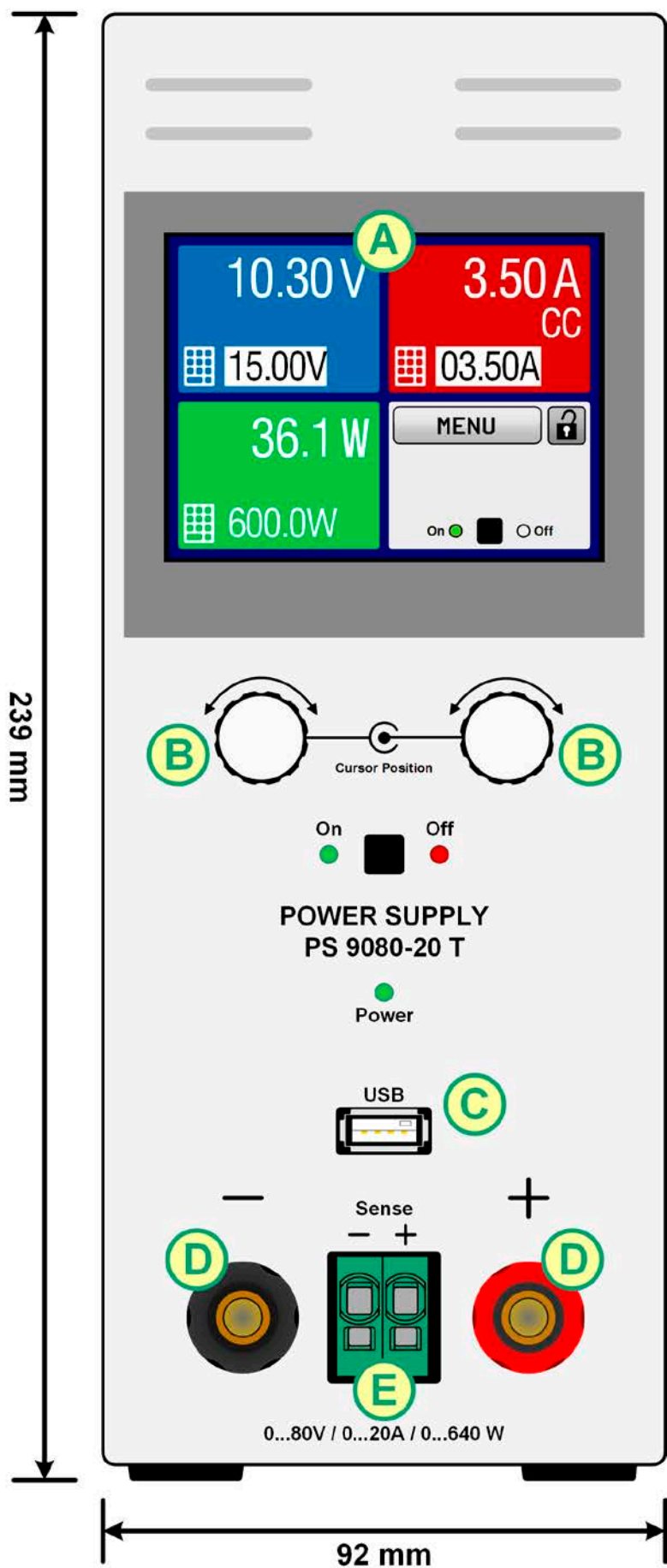

- A - Control panel with display
- B - Knobs
- C - USB port
- D - DC output
- E - Remote sensing connector

Figure 1 - Front view

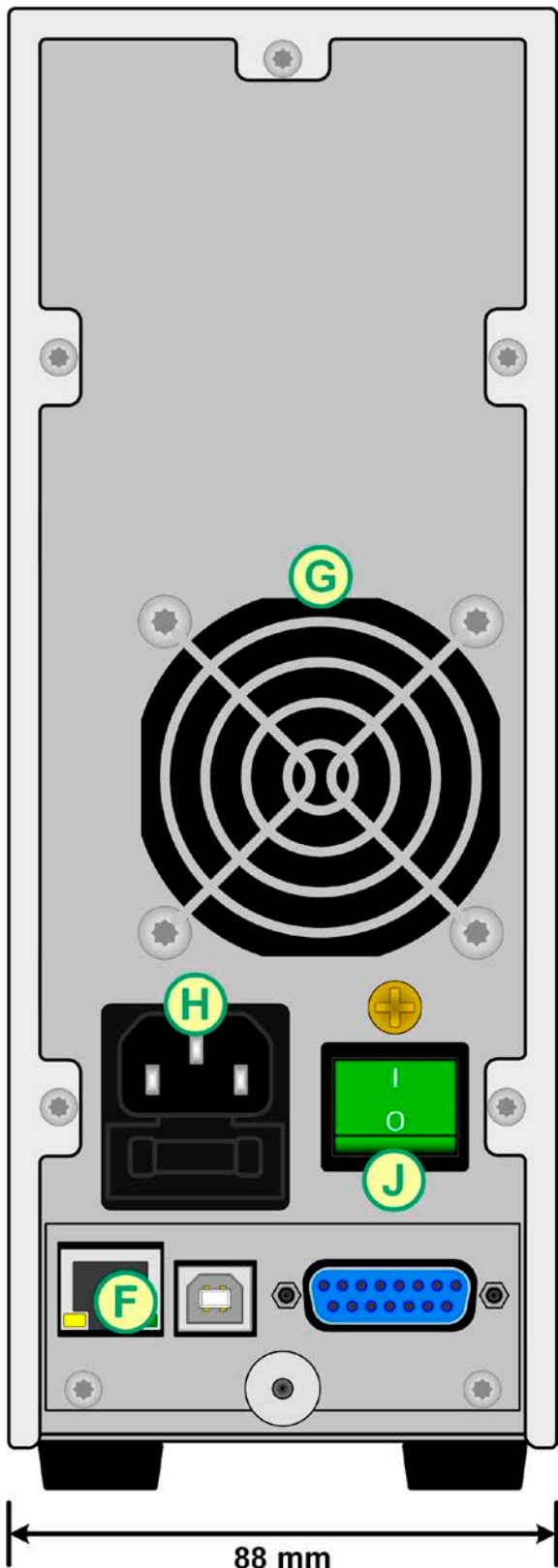

Figure 2 - Rear view (320 W / 640 W version shown)

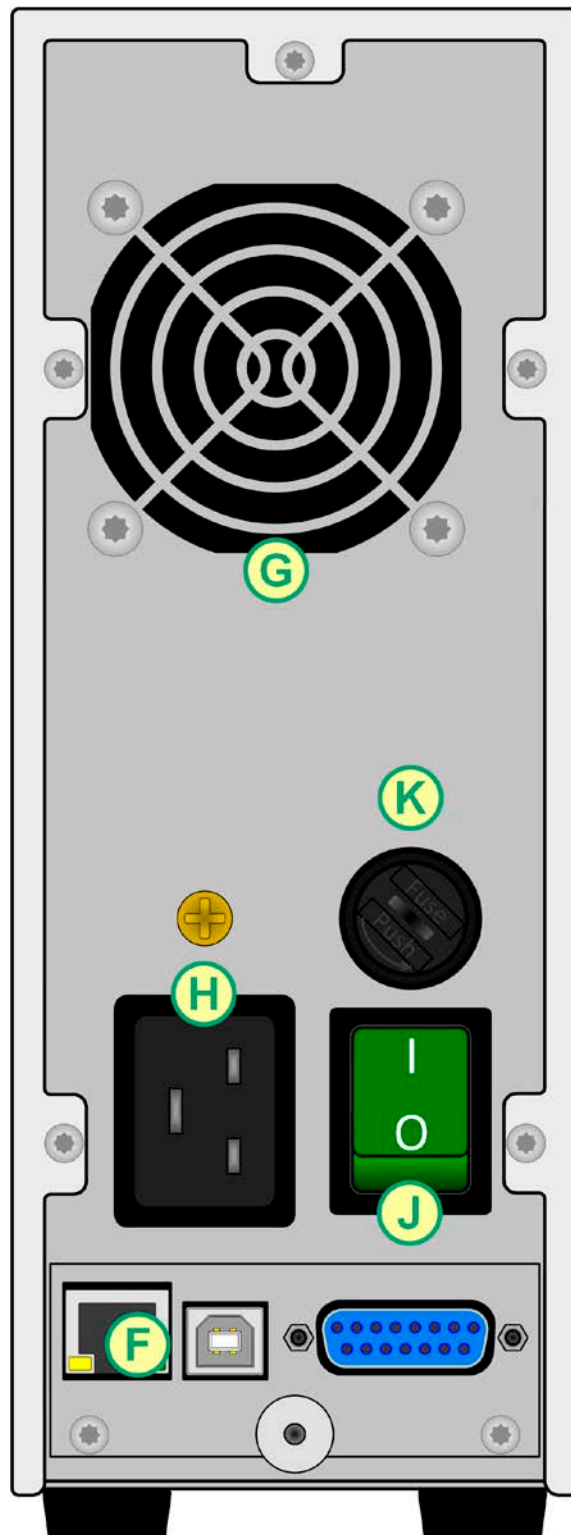

Figure 3 - Rear view (1000 W / 1500 W version shown)



Do not loosen the grounding point (brass screw above the AC inlet resp. above the power switch) in order to connect PE cables! The device is supposed to be grounded via the AC cord, while the grounding point is used to connect enclosure parts to PE.

F - Control interfaces (digital, analog) *

G - Exhaust

H - AC input connection

J - Power switch

K - AC input fuse **

* Ethernet and analog interfaces are not standard, here only depicted for demonstration

** For models with 320/640 W power rating the fuse is located inside the AC input socket



Figure 4 - Top view

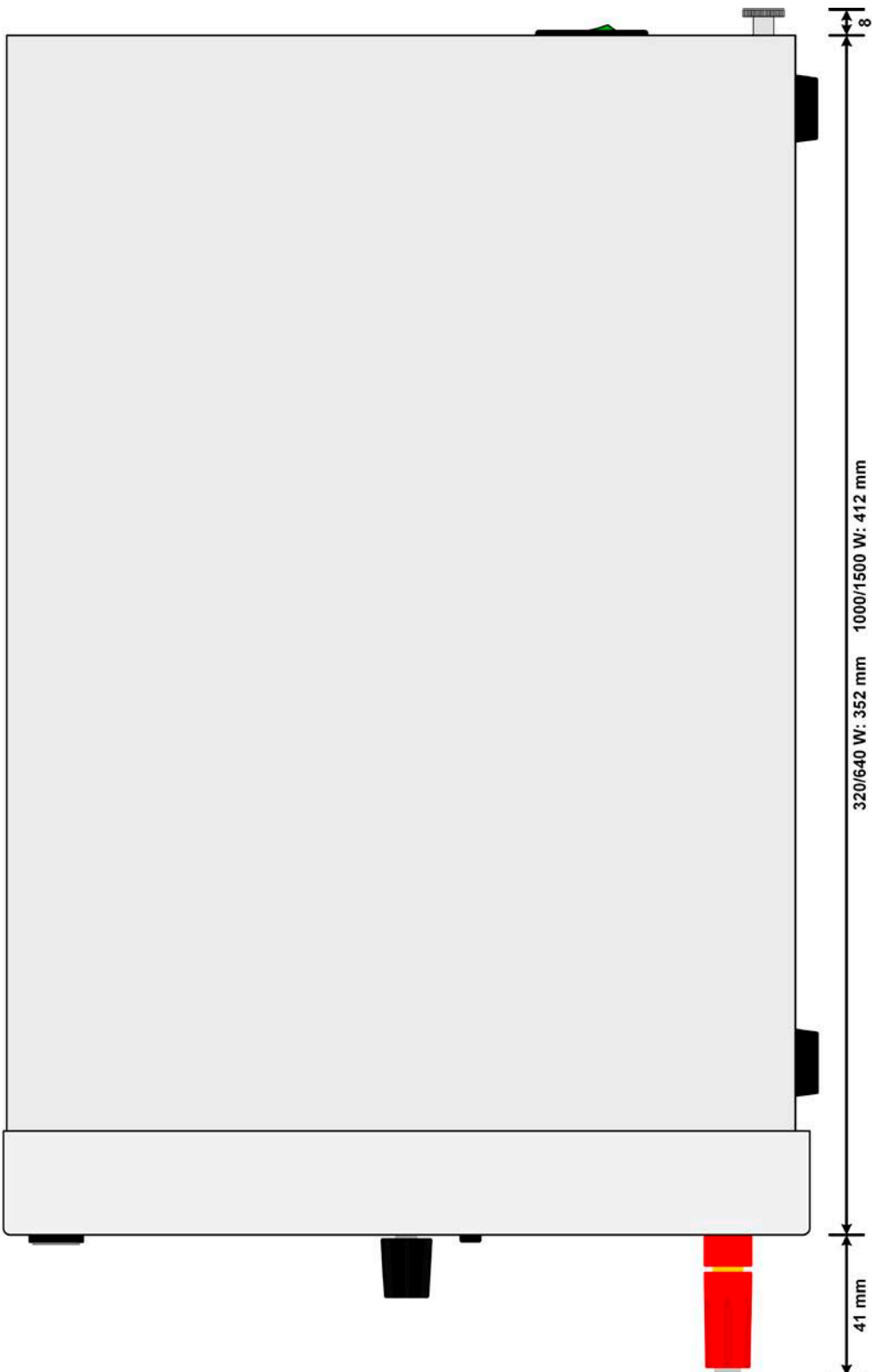

Figure 5 - Side view

1.8.5 Control elements

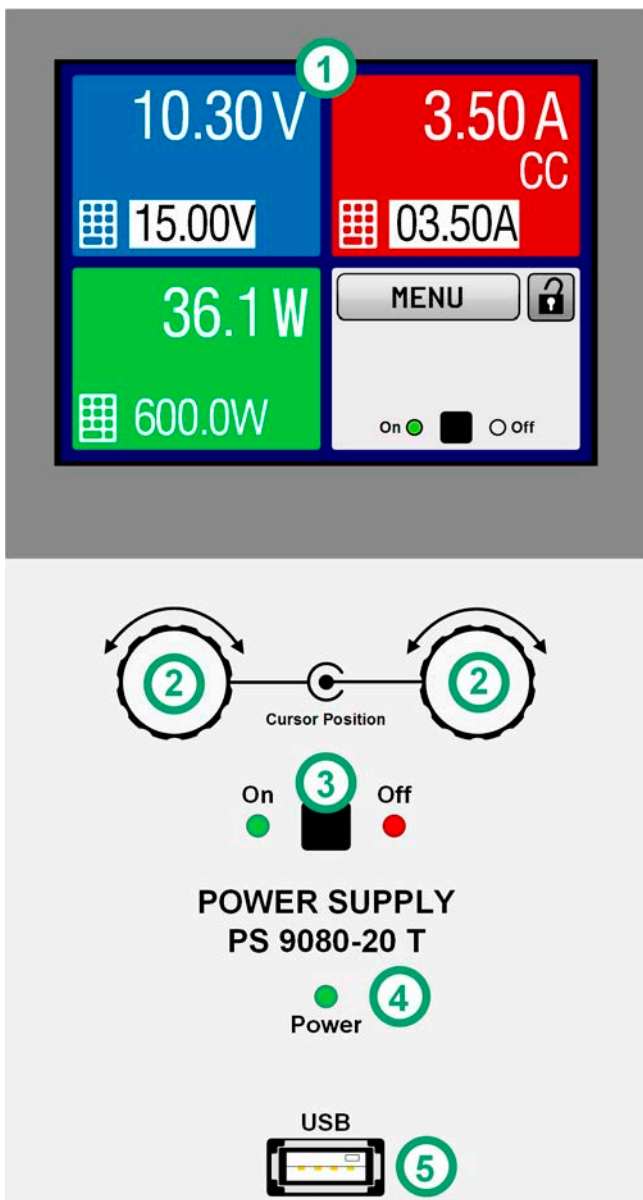

Figure 6 - Control panel

Overview of the elements on the control panel

For a detailed description see section „1.9.5. The control panel (HMI)“.

(1)	<p>Touchscreen display</p> <p>Used for selection of set values, menus, status and display of actual values and status.</p> <p>The touchscreen can be operated with the fingers or with a pen (stylus).</p>
(2)	<p>Rotary knob with push button function</p> <p>Left knob (turn): adjusting the voltage set value, or setting the parameter values in the menu.</p> <p>Left knob (push): selection of the decimal position to be changed (cursor) for the assigned value.</p> <p>Right knob (turn): adjusting the current or power set value, or setting parameter values in the menu.</p> <p>Right knob (push): selection of the decimal position to be changed (cursor) for the assigned value.</p>
(3)	<p>On/Off button for DC output</p> <p>Used to toggle the DC output between on and off. The LEDs “On” and “Off” indicate the state of the DC output, no matter if the device is manually controlled or remotely</p>
(4)	<p>LED “Power”</p> <p>Indicates different colours during the start of the device and remains green for the period of operation.</p>
(5)	<p>USB-A port</p> <p>For the connection of standard USB sticks. See section „1.9.5.5. USB port (front side)“ for more details</p>

1.9 Construction and function

1.9.1 General description

The DC laboratory power supplies of the PS 9000 T series are especially suitable for the use in test and development applications, in laboratories and research. The “T” in the series names stands for tower and point for the upright enclosure design which saves space on laboratory desks and test equipment racks.

The front USB port offers the possibility to record data in every operation mode to USB stick for later analysis. The used file type CSV enables easy transfer to tools like Microsoft Excel, where the data can be visualised and processed.

For remote control using a PC or PLC the devices are provided as standard with an USB port on the back side, which can be optionally extended to a 3-way interface with USB, Ethernet and a galvanically isolated analog port, all retrofittable by the user. The configuration of the interfaces, if necessary at all, is simple.

Both digital interface support the standard protocols ModBus and SCPI. For the implementation into National Instruments LabView suitable VIs are included in the package.

All models are controlled by microprocessors.

1.9.2 Block diagram

The block diagram illustrates the main components inside the device and their relationships.

There are digital, microprocessor controlled components (KE, DR, HMI), which can be target of firmware updates.

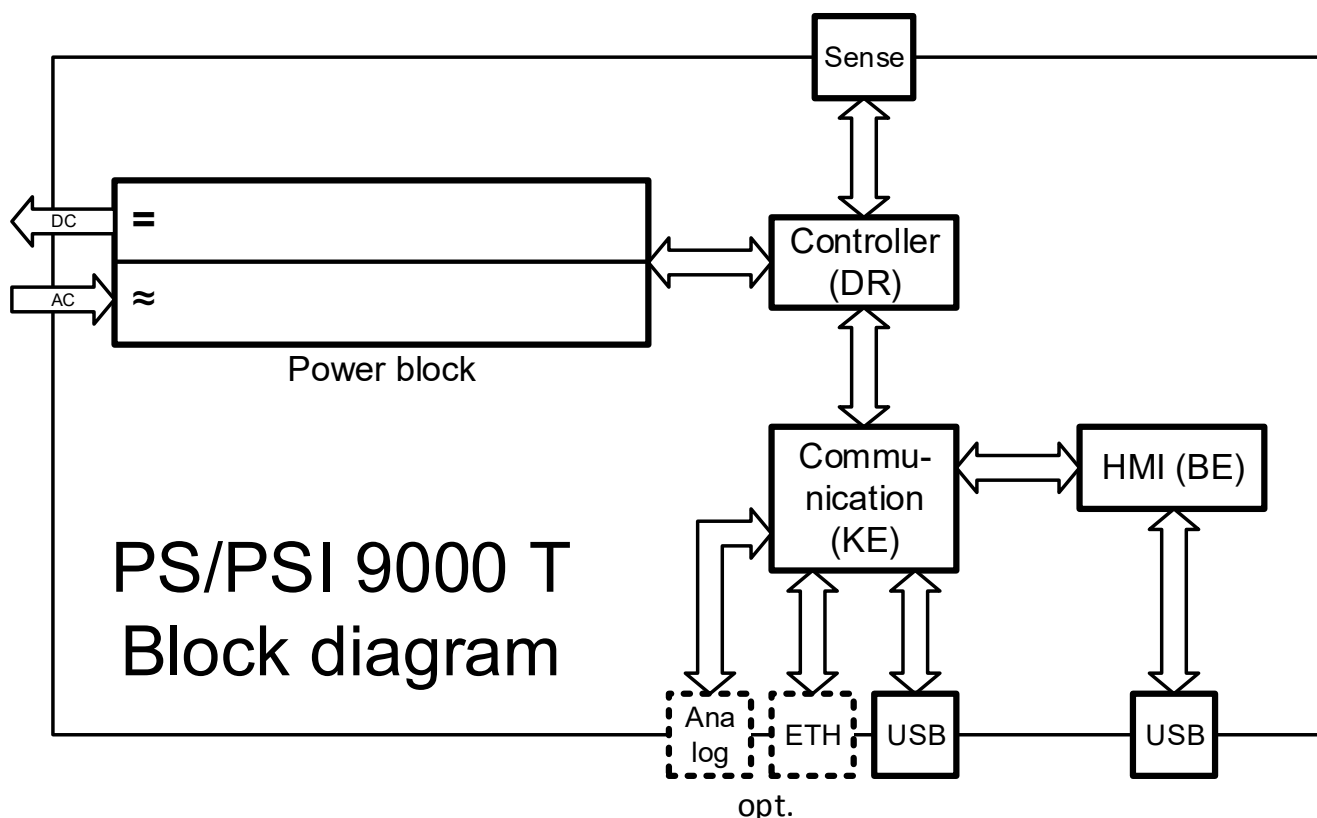

1.9.3 Scope of delivery

1 x Power supply device PS 9000 T

1 x Mains cord 2 m (1000/1500 W models) or 1.5 m (320/640 W models) with Schuko plug, UK plug or US plug, depending on shipping destination

1 x USB cable, 1.8 m

1 x USB stick with software and documentation

1.9.4 Optional accessories

The below listed optional accessories can be purchased separately from the device and can be installed by the user:

IF-KE4 Ordering nr. 33 100 231	Exchangeable interface module with USB and Ethernet ports, as well as an 15-pole analog interface (D-Sub type). All interfaces are galvanically isolated from the device. The module can be retrofitted by the end user.
--	--

1.9.5 The control panel (HMI)

The HMI (Human Machine Interface) consists of a display with touchscreen, two rotary knobs, a pushbutton and an USB port.

1.9.5.1 Touchscreen display

The graphic touchscreen display is divided into a number of areas. The complete display is touch sensitive and can be operated by finger or stylus to control the equipment.

In normal operation the screen is separated into four areas of equal size, of which three are used to show actual and set values and one to display status information:

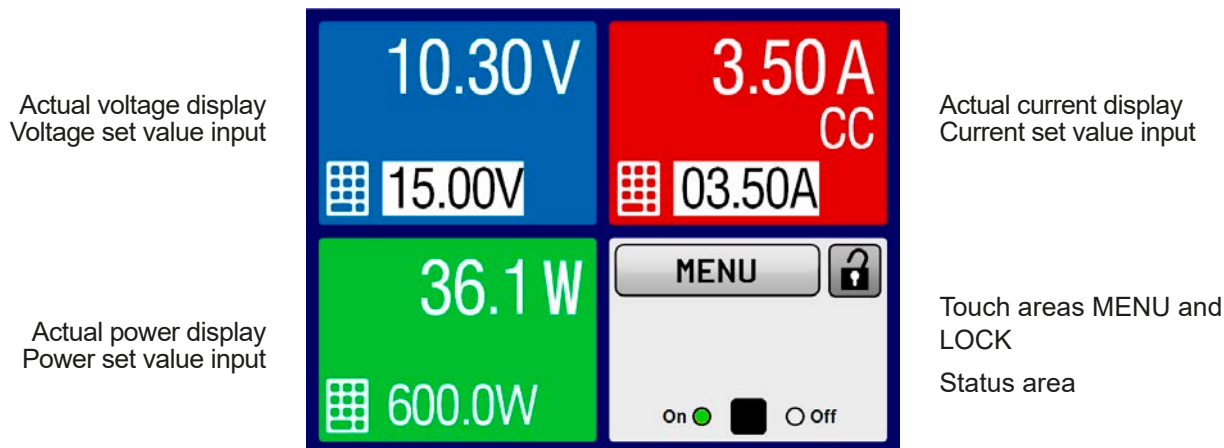

Touch areas may be enabled or disabled:

MENU Black text or symbol = Enabled Grey text or symbol = Disabled

• **Actual / set values area (blue, red, green, orange)**

In normal operation the DC output values (large numbers) and set values (small numbers) for voltage, current and power are displayed.

When the DC output is switched on, the actual regulation mode, **CV**, **CC** or **CP** is displayed in the corresponding area, like depicted in the figure above with “CC” in the red area for current.

The set values can be adjusted with the rotary knobs below the touch screen or can be entered directly via the touchscreen. When adjusting with the knobs, pushing the knob will select the digit to adjust. Logically, the values are increased by 1 in clockwise turning and decreased by 1 in anti-clockwise turning, until reaching any limit (see „3.4.4. Adjustment limits (Limits)“).



General display and settings ranges:

Display	Unit	Range	Description
Actual voltage	V	0-125% U _{Nom}	Actual values of DC output voltage
Set value voltage ⁽¹⁾	V	0-102% U _{Nom}	Set value for limiting the DC output voltage
Actual current	A	0.2-125% I _{Nom}	Actual value of DC output current
Set value current ⁽¹⁾	A	0-102% I _{Nom}	Set value for limiting the DC output current
Actual power	W	0-125% P _{Nom}	Actual value of output power, P = U * I
Set value power ⁽¹⁾	W	0-102% P _{Nom}	Set value for limiting DC output power
Adjustment limits	A, V, W	0-102% nom	U-max, I-min etc., related to the physical values
Protection settings	A, V, W	0-110% nom	OVP, OCP etc., related to the physical values

⁽¹⁾ Valid also for values related to these physical quantities, such as OVD for voltage and UCD for current

• **Status display (upper right)**

This area displays various status texts and symbols:

Display	Description
Locked	The HMI is locked
Remote:	The device is under remote control from....
Analog	...the built-in analog interface
USB	...the built-in USB port
Ethernet	...the built-in Ethernet port
Local	The device has been locked by the user explicitly against remote control
Alarm:	Alarm condition which has not been acknowledged or still exists.
 / 	Data logging to USB stick active or failed

1.9.5.2 Rotary knobs



As long as the device is in manual operation, the two rotary knobs are used to adjust set values, as well as setting the parameters in the MENU. For a detailed description of the individual functions see section „3.4 Manual operation“ on page 37.

1.9.5.3 Pushbutton function of the knobs

The rotary knobs also have a pushbutton function which is used to move the cursor by rotation while adjusting values, like this:



1.9.5.4 Resolution of the displayed values

In the display, set values can be adjusted in fixed increments. The number of decimal places depends on the device model. The values have 4 or 5 digits. Actual and set values always have the same number of digits.

Adjustable resolution and display formats for the touch panel display:

Voltage, OVP, U-min, U-max			Current, OCP, I-min, I-max			Power, OPP, P-max		
Nominal value	Digits	Min. increment	Nominal value	Digits	Min. increment	Nominal value	Digits	Min. increment
40 V / 80 V	4	0.01 V	4 A / 6 A	4	0.001 A	320 W	4	0,1 W
200 V	5	0.01 V	10 A / 15 A	5	0.001 A	640 W	4	0,1 W
500 V	4	0.1 V	20 A / 25 A	5	0.001 A	1000 W	4	1 W
			40 A / 60 A	4	0.01 A	1500 W	4	1 W



In manual operation every set value can be set in the increments given above. In this case the actual output values set by the device will lie within percentage tolerances as shown in the technical data sheets. These will influence the actual values.

1.9.5.5 USB port (front side)

The frontal USB port, located below the LED “Power”, is intended to host standard USB sticks. Such sticks can be used for data recording during all operation modes.

USB 2.0 sticks are accepted and must be **FAT32** formatted and have a **maximum capacity of 32 GB**. USB 3.0 sticks also work, but not from all manufacturers. All supported files must be held in a designated folder in the root path of the USB drive in order to be found. This folder must be named **HMI_FILES**, such that a PC would recognise the path G:\HMI_FILES if the drive were to be assigned the letter G.

The control panel of the device can read the following file formats and names from an USB stick:

profile_<nr>.csv	Previously saved user profile. The number in the file name is a counter and not related to the actual user profile number in the HMI. A max. of 10 files to select from is shown when loading an user profile.
------------------	--

The control panel of the device can save the following file formats and names to an USB stick:

profile_<nr>.csv	User profile. The number in the file name is a counter and not related to the actual user profile number in the HMI. A max. of 10 files can be stored by in the folder.
usb_log_<nr>.csv	File with log data recorded during normal operation in all modes. The file layout is identical to the those generated from the Logging feature in EA Power Control. The <nr> field in the file name is automatically counted up if equally named files already exist in the folder.

1.9.6 USB port (rear side)

The USB-B port on the back side of the device is standard with this series and is provided for communication with the device and for firmware updates. The included USB cable can be used to connect the device to a PC (USB 2.0 or 3.0). The driver is delivered on the included USB stick and installs a virtual COM port. Details for remote control can be found on the included USB stick or the web site of Elektro-Automatik.

The device can be addressed via this port either using the international standard ModBus protocol or by SCPI language. The device recognises the message protocol automatically.

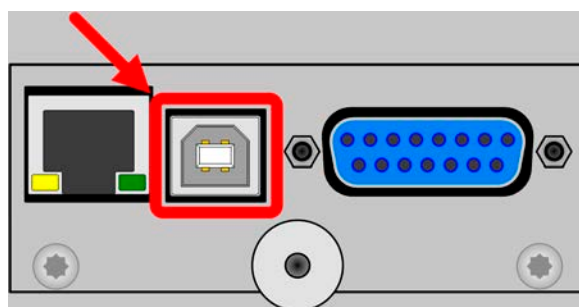

Picture shows optional IF-KE4 module

If remote control is going to be activated, the USB interface has no priority over any other interface and can therefore only be used alternatively to them. However, monitoring is always available, no matter if and via what interface the device is remotely controlled.

1.9.7 “Sense” connector (remote sensing)

In order to compensate for voltage drops along the DC cables to the load, the **Sense** input (between the DC output terminals) can be connected to the load. The device will automatically detect when the sense input is wired (Sense+) and compensate the output voltage accordingly.

The maximum possible compensation is given in the technical specifications.

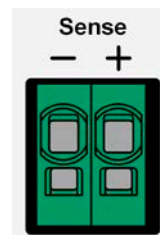

1.9.8 Ethernet port

The Ethernet port is optional. Also see section 1.9.4.

The port on the back side of the device is provided for communication with the device in terms of remote control or monitoring. The user has basically two options of access:

1. A website (HTTP, port 80) which is accessible in a standard browser under the IP or the host name given for the device. This website offers to configuration page for network parameters, as well as a input box for SCPI commands.
2. TCP/IP access via a freely selectable port (except 80 and other reserved ports). The standard port for this device is 5025. Via TCP/IP and this port, communication to the device can be established in most of the common programming languages.

Using the Ethernet port, the device can either be controlled by commands from SCPI or ModBus protocol, while automatically detecting the type of message.

The network setup can be done manually or by DHCP. The transmission speed is set to "Auto negotiation" and means it can use 10 MBit/s or 100 MBit/s. 1 GB/s isn't supported. Duplex mode is always full duplex.

If remote control is going to be activated, the Ethernet interface has no priority over any other interface and can therefore only be used alternatively to them. However, monitoring is always available, no matter if and via what interface the device is remotely controlled.

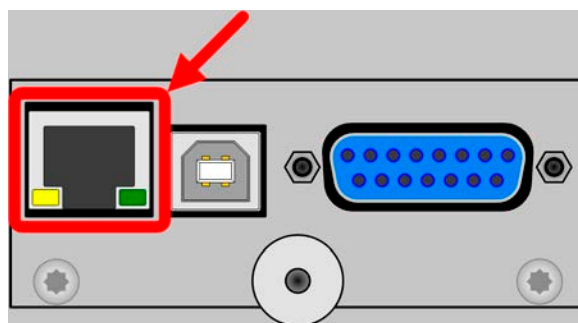

1.9.9 Analog interface

The analog interface is optional. Also see section 1.9.4.

This 15-pole Sub-D socket on the back side of the device is provided for remote control of the device via analog or digital signals.

The input voltage range of the set values and the output voltage range of the monitor values, as well as reference voltage level can be switched in the settings menu of the device between 0-5 V and 0-10 V, in each case for 0-100%.

If remote control is going to be activated, the analog interface has no priority over any other interface and can therefore only be used alternatively to them. However, monitoring is always available, no matter if and via what interface the device is remotely controlled.

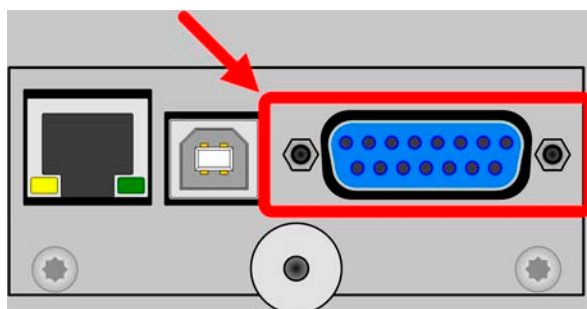

The analog interface is only analog (per definition of the word) to the outside. Internally it's processed by a microcontroller which causes it to have a limited resolution and sample rate.

2. Installation & commissioning

2.1 Storage

2.1.1 Packaging

It's recommended to keep the complete transport packaging for the lifetime of the device for relocation or return to the manufacturer for repair. Otherwise the packaging should be disposed of in an environmentally friendly way.

2.1.2 Storage

In case of long term storage of the equipment it's recommended to use the original packaging or similar. Storage must be in dry rooms, if possible in sealed packaging, to avoid corrosion, especially internal, through humidity.

2.2 Unpacking and visual check

After every transport, with or without packaging, or before commissioning, the equipment should be visually inspected for damage and completeness using the delivery note and/or parts list (see section „1.9.3. Scope of delivery“). An obviously damaged device (e.g. loose parts inside, damage outside) must under no circumstances be put in operation.

2.3 Installation

2.3.1 Safety procedures before installation and use



Before connecting to the mains ensure that the supply voltage is as shown on the product label. Overvoltage on the AC supply can cause equipment damage.

2.3.2 Preparation

Mains connection for a PS 9000 T series device is done via the included 1.5 meters or 2 meters long (depending on the power rating and input current) three-pole mains cord. In case a different AC connection is used, make sure that the other cable has at least a cross section suitable for the rated input current (stated on type label).

Dimensioning of the DC wiring to the load/consumer has to reflect the following:



- The cable cross section should always be selected for at least the maximum current of the device.
- Continuous operation at the approved limit generates heat which must be removed, as well as voltage loss which depends on cable length and heating. To compensate for these the cable cross section should be increased and/or the cable length reduced.

2.3.3 Installing the device



- Select the location for the device so that the connection to the load is as short as possible.
- Leave sufficient space behind the equipment, minimum 30 cm, for ventilation.
- Never obstruct the air inlets on the sides!
- Never place any objects on top of the unit!

2.3.3.1 Placement on horizontal standing surfaces

The device is designed as a desktop unit and must only be operated on horizontal surfaces, which are capable of securely carrying the weight of the device.

Acceptable and unacceptable operating positions:

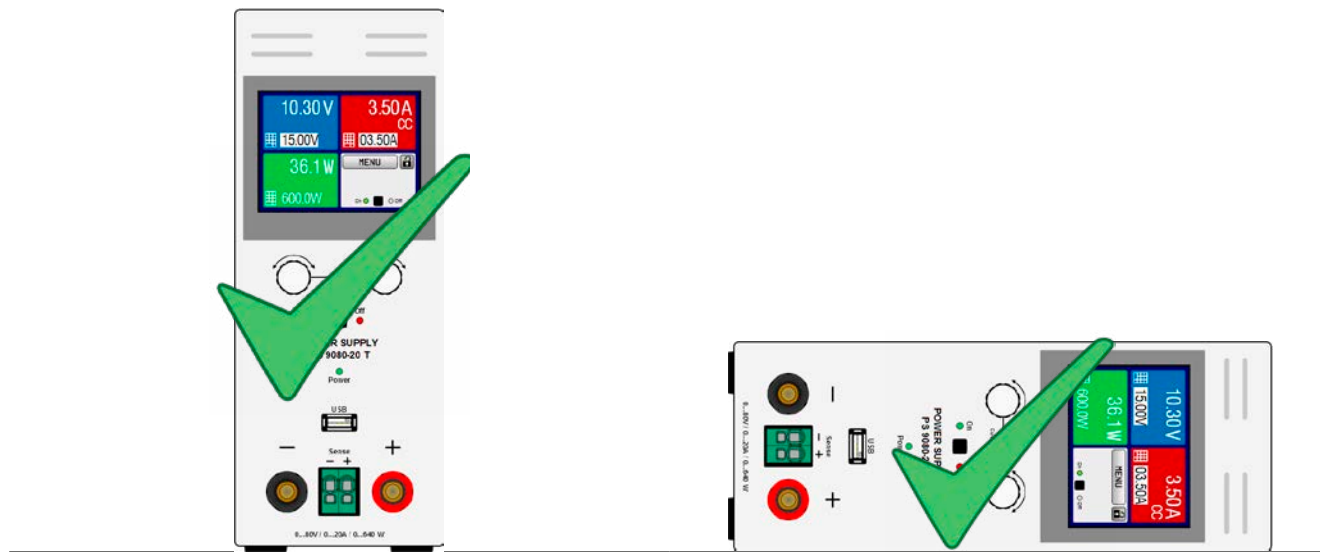

Standing surface

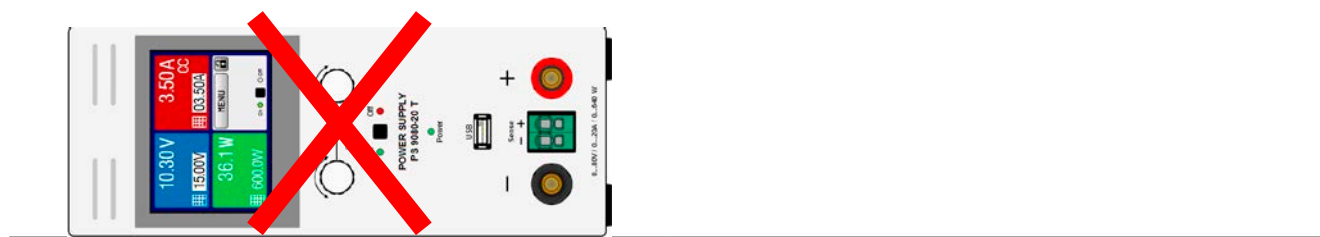

Standing surface

2.3.4 Connection to DC loads



- Connection to and operation with transformerless DC-AC inverters (for example solar inverters) is restricted, because the inverter can shift the potential of negative output (DC-) against PE (ground), which is limited to max. ± 400 V DC.
- When using any model which is rated for 40 A or higher current, attention has to be paid to where the load is connected on the DC output terminals. The front-side 4 mm connection point is only rated for **max. 32 A!**
- Connection of voltage sources which can generate a voltage higher than 110% nominal of the device model isn't allowed!
- Connection of voltage sources with reversed polarity isn't allowed!

The DC load output is on the front side of the device and isn't protected by a fuse. The cross section of the connection cable is determined by the current consumption, cable length and ambient temperature.

For cables **up to 5 m** and average ambient temperature up to 50°C, we recommend:

up to 10 A :	0.75 mm ² (AWG18)	up to 15 A :	1.5 mm ² (AWG14)
up to 20 A :	4 mm ² (AWG10)	up to 40 A :	10 mm ² (AWG8)
up to 60 A :	16 mm ² (AWG4)		

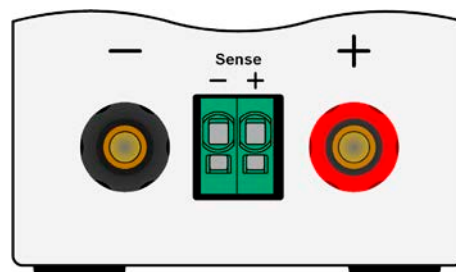

per lead (multi-conductor, insulated, openly suspended). Single cables of, for example, 16 mm² may be replaced by e.g. 2x 6 mm² etc. If the cables are long then the cross section must be increased to avoid voltage loss and overheating.

2.3.4.1 Possible connections on the DC output

The DC output on the front is of type clamp & plug and can be used with:

- 4 mm system plugs (Büschel, banana, safety) for **max. 32 A!**
- Spade lugs (6 mm or bigger)
- Soldered cable ends (only recommended for small currents up to 10 A)

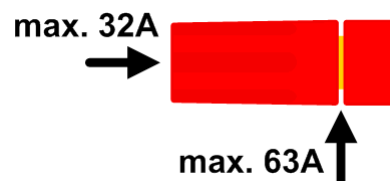

When using any type of lugs or cable end sleeves, only use those with insulation in order to ensure electric shock protection!

2.3.5 Grounding of the DC output

Grounding one of the DC output poles is permissible, but causes potential shift against PE on the opposite pole. Because of insulation, there is a max. allowed potential shift defined for the DC output poles, which depends on the device model. Refer to „1.8.3. Specific technical data“.

2.3.6 Connection of remote sensing



- Remote sensing is only effective during constant voltage operation (CV) and for other regulation modes the sense input should be disconnected, if possible, because connecting it generally increases the oscillation tendency.
- The cross section of the sense cables is noncritical. However, it should be increased with increasing cable length. Clamp terminal **Sense** is suitable for cross section of 0.2 mm² (AWG24) to 10 mm² (AWG8)
- Sense cables should be twisted and laid close to the DC cables to damp oscillation. If necessary, an additional capacitor can be installed at the load/consumer to eliminate oscillation
- The sense cables must be connected + to + and - to - at the load, otherwise both systems may be damaged

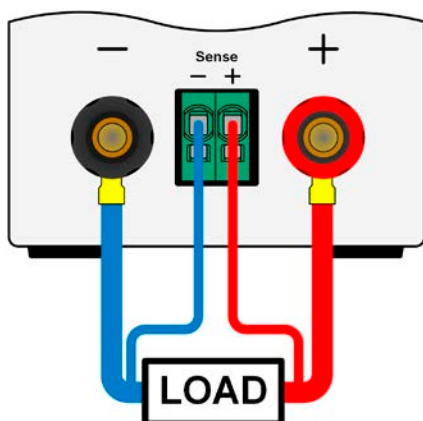

Figure 7 - Principle of remote sensing wiring

The connector Sense is a clamp terminal. It means for the remote sensing cables:

- Insert cables: crimp sleeves onto the cable ends and simply push them into the bigger square hole
- Remove cables: use a small flat screwdriver and push into the smaller square hole next to the bigger one to loosen the cable clamp, then remove cable end

2.3.7 Connecting the analog interface

The optionally available 15 pole connector (Type: Sub-D, D-Sub) on the rear side is an analog interface. To connect this to a controlling hardware (PC, electronic circuit), a standard plug is necessary (not included in the scope of delivery). It's generally advisable to switch the device completely off before connecting or disconnecting this connector, but at least the DC output.



The analog interface is galvanically isolated from the device internally. Unless absolutely required, do not connect any ground of the analog interface (AGND) to the DC minus output as this will cancel the galvanic isolation.

2.3.8 Connecting the USB port (rear side)

In order to remotely control the device via this port, connect the device with a PC using the included USB cable and switch the device on.

2.3.8.1 Driver installation (Windows)

On the initial connection with a PC the operating system will identify the device as new hardware and will start to install a driver. The required driver is for a Communications Device Class (CDC) device and is usually integrated in current operating systems such as Windows 7 or 10. But it's strongly recommended to use and install the included driver installer (on USB stick) to gain maximum compatibility of the device to our softwares.

2.3.8.2 Driver installation (Linux, MacOS)

We can't provide drivers or installation instructions for these operating systems. Whether a suitable driver is available is best found out by searching the Internet. With newer versions of Linux or MacOS, a generic CDC should be "on board".

2.3.8.3 Alternative drivers

In case the CDC drivers described above are not available on your system, or for some reason do not function correctly, commercial suppliers can help. Search the Internet for suppliers using the keywords "cdc driver windows" or "cdc driver linux" or "cdc driver macos".

2.3.9 Initial commission

For the first start-up after installation of the device, the following procedures have to be executed:

- Confirm that the connection cables to be used are of a satisfactory cross section!
- Check if the factory settings of set values, safety and monitoring functions and communication are suitable for your intended application of the device and adjust them if required, as described in the manual!
- In case of remote control via PC, read the additional documentation for interfaces and software!
- In case of remote control via the analog interface, read the section in this manual concerning analog interfaces!

2.3.10 Commission after a firmware update or a long period of non-use

In case of a firmware update, return of the equipment following repair or a location or configuration change, similar measures should be taken to those of initial start up. Refer to „2.3.9. *Initial commission*“.

Only after successful checking of the device as listed may it be operated as usual.

3. Operation and application

3.1 Personal safety



- In order to guarantee safety when using the device, it's essential that only persons operate the device who are fully acquainted and trained in the required safety measures to be taken when working with dangerous electrical voltages
- For models which can generate a voltage which is dangerous by contact, or is connected to such, all cables with lugs have to be crimped with insulated lugs. If necessary, install additional measures for protection against physical contact, such as a cover
- Whenever the load and DC output are being re-configured, the device should be switched off completely, not only the DC output!

3.2 Operating modes

A power supply is internally controlled by different control or regulation circuits, which shall bring voltage, current and power to the adjusted values and hold them constant, if possible. These circuits follow typical laws of control systems engineering, resulting in different operating modes. Every operating mode has its own characteristics which is explained below in short form.



- *Unloaded operation isn't considered as a normal operation mode and can thus lead to false measurements, for example when calibrating the device*
- *The optimal working point of the device is between 50% and 100% voltage and current*
- *It's recommended to not run the device below 10% voltage and current, in order to make sure technical values like ripple and transient times can be met*

3.2.1 Voltage regulation / Constant voltage

Voltage regulation is also called constant voltage operation (CV).

The DC output voltage of a power supply is held constant on the adjusted value, unless the output current or the output power according to $P = U_{OUT} \cdot I_{OUT}$ reaches the adjusted current or power limit. In both cases the device will automatically change to constant current or constant power operation, whatever occurs first. Then the output voltage can't be held constant anymore and will sink to a value resulting from Ohm's law.

While the DC output is switched on and constant voltage mode is active, then the condition "CV mode active" will be indicated on the graphic display by the abbreviation CV and this message will be passed as a signal to the analog interface, as well stored as status which can also be read as a status message via digital interface.

3.2.1.1 Transient time after load step

For constant voltage mode (CV), the technical date "Settling time after load step" (see 1.8.3) defines a time that is required by the internal voltage regulator of the device to settle the output voltage after a load step. Negative load steps, i.e. high load to lower load, will cause the output voltage to overshoot for a short time until compensated by the voltage regulator. The same occurs with a positive load step, i.e. low load to high load. There the output collapses for a moment. The amplitude of the overshoot resp. collapse depends on the device model, the currently adjusted output voltage and the capacity on the DC output and can thus not be stated with a specific value.

Depictions:

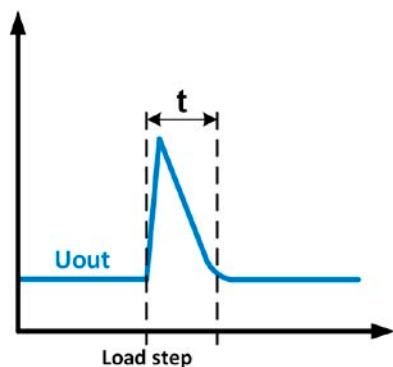

Example for neg. load step: the DC output will rise above the adjusted value for a short time. t = transient time to settle the output voltage.

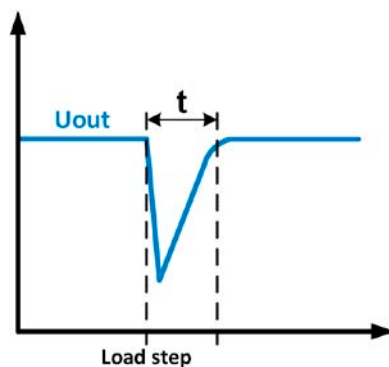

Example for pos. load step: the DC output will collapse below the adjusted value for a short time. t = transient time to settle the output voltage.

3.2.2 Current regulation / constant current / current limiting

Current regulation is also known as current limiting or constant current mode (CC).

The DC output current is held constant by the power supply, once the output current to the load reaches the adjusted limit. Then the power supply automatically switches to CC. The current flowing from the power supply is determined by the output voltage and the load's true resistance. As long as the output current is lower than the adjusted current limit, the device will be either in constant voltage or constant power mode. If, however, the power consumption reaches the set maximum power value, the device will switch automatically to power limiting and sets the output current according to $I_{MAX} = P_{SET} / U_{IN}$, even if the maximum current value is higher. The current set value, as determined by the user, is always an upper limit only.

While the DC output is switched on and constant current mode is active, then the condition "CC mode active" will be indicated on the graphic display by the abbreviation CC and this message will be passed as a signal to the analog interface, as well stored as status which can also be read as a status message via digital interface.

3.2.3 Power regulation / constant power / power limiting

Power regulation, also known as power limiting or constant power (CP), keeps the DC output power of a power supply constant if the current flowing to the load in relation to the output voltage and the resistance of load reaches the adjusted value according to $P = U \cdot I$ resp. $P = U^2 / R$. The power limiting then regulates the output current according to $I = \sqrt{P / R}$, where R is the load's resistance.

Power limiting operates according to the auto-range principle such that at lower output voltages higher current flows and vice versa in order to maintain constant power within the range P_N (see diagram to the right).

While the DC output is switched on and constant power mode is active, then the condition "CP mode active" will be shown on the graphic display by the abbreviation CP, as well stored as status which can also be read as a status message via digital interface.

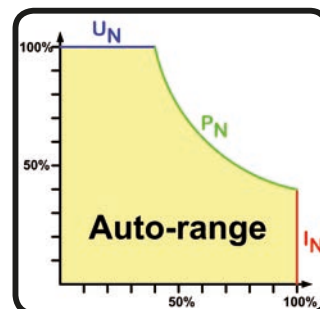

When using remote sensing, the power supply can deliver a higher voltage on the DC output than adjusted, which results in additional power and may also cause the device to enter power limitation without explicitly indicating "CP" in the display.

3.2.3.1 Power derating

Due to fusing and cross sections of conductors and the extended supply voltage range, power supply models with 1500 W rated output power have a fixed derating, which becomes active below a certain input voltage level (for value see „1.8.3. Specific technical data“). It then derates the maximum available output power down to approx. 1000 W. The derating only affects the power stage, so the full range for power set value adjustment remains, though the device will not provide full output power anymore. In this situation, constant power operation can not be indicated by status "CP". Active derating can then only be detected by reading the actual values of voltage and current and by calculating the power.



No status "CP" available if the adjusted power set value (Psel) is bigger than the derated actual output power of the device. It means, derating isn't signalled anywhere.

3.3 Alarm conditions



This section only gives an overview about device alarms. What to do in case your device indicates an alarm condition is described in section „3.6. Alarms and monitoring“.

As a basic principle, all alarm conditions are signalled optically (text + message in the display) and as a readable status and alarm counter via the digital interface. In addition, the alarms OT and OVP are reported as signals on the analogue interface. For later acquisition, an alarm counter can be read from the display or via digital interface.

3.3.1 Power Fail

Power Fail (PF) indicates an alarm condition which may have various causes:

- AC input voltage too low (mains undervoltage, mains failure)
- Defect in the input circuit (PFC) or internal auxiliary supply

As soon as a power fail occurs, the device will stop to supply power and switch off the DC output. In case the power fail was an undervoltage and will be gone later on, the alarm will vanish from display and doesn't require to be acknowledged.



Switching off the device by the mains switch can't be distinguished from a mains blackout and thus the device will signalise a PF alarm every time the device is switched off. This can be ignored.



The condition of the DC output after a PF alarm during normal operation can be set up. See „3.4.3. Configuration via MENU“.

3.3.2 Overtemperature

An overtemperature alarm (OT) can occur if an excess temperature inside the device causes it to stop supplying power temporarily. After cooling down, the device will automatically continue to supply power, while the condition of the DC output remains and the alarm doesn't require to be acknowledged.

3.3.3 Overvoltage protection

An overvoltage alarm (OVP) will switch off the DC output and can occur if:

- the power supply itself, as a voltage source, generates an output voltage higher than set for the overvoltage alarm threshold (OVP, 0...110% U_{Nom}) or the connected load somehow returns voltage higher than set for the overvoltage alarm limit
- the OV threshold has been adjusted too close above the output voltage. If the device is in CC mode and if it then experiences a negative load step, it will make the voltage rise quickly, resulting in a voltage overshoot for a short moment which can already trigger the OVP

This function serves to warn the user of the power supply acoustically or optically that the device probably has generated an excessive voltage which could damage the connected load application.



- The device isn't fitted with protection from external overvoltage
- The changeover from operation mode CC -> CV can generate voltage overshoots

3.3.4 Overcurrent protection

An overcurrent alarm (OCP) will switch off the DC output and can occur if:

- the output current in the DC output exceeds the adjusted OCP limit.

This function serves to protect the connected load application so that this isn't overloaded and possibly damaged due to an excessive current.

3.3.5 Overpower protection

An overpower alarm (OPP) will switch off the DC output and can occur if:

- the product of the output voltage and output current in the DC output exceeds the adjusted OPP limit.

This function serves to protect the connected load application so that this isn't overloaded and possibly damaged due to an excessive power consumption.

3.4 Manual operation

3.4.1 Switching on the device

The device should, as far as possible, always be switched on using the toggle switch on the rear of the device. After switching on, the display will first show the company logo, followed by a language selection which will close automatically after 3 seconds and later manufacturer's name and address, device type, firmware version(s), serial number and item number.

In setup (see section „3.4.3. Configuration via MENU“), in the second level menu “**General settings**” is an option “**DC output after power ON**” in which the user can determine the condition of the DC output after power-up. Factory setting here is “**OFF**”, meaning that the DC output on power-up is always switched off. “**Restore**” means that the last condition of the DC output will be restored, either on or off. All set values are always saved and restored.



After powering the device and during the start phase the AI signals undefined statuses on the output pins such as ERROR. Those must be ignored until it's ready to work.

3.4.2 Switching off the device

On switch-off the last output condition and the most recent set values are saved. Furthermore, a PF alarm (power failure) will be reported, but can be ignored.

The DC output is immediately switched off and after a short while fans will shut down and after another few seconds the device will be completely powered off.

3.4.3 Configuration via MENU

The MENU serves to configure all operating parameters which are not constantly required. These can be set by finger touch on the MENU touch area, but only if the DC output is switched OFF. See figure to the right.

If the DC output is switched on the settings menu will not be shown, only status information.

Menu navigation is by finger touch. Values are set using the rotary knobs. The assignments of the rotary knobs, if multiple values can be set in a particular menu, isn't always depicted. Following rule for such situations:

- upper value -> left knob
- lower value > right knob

Some setting parameters are self-explanatory, others are not. The latter will be explained on the pages following.

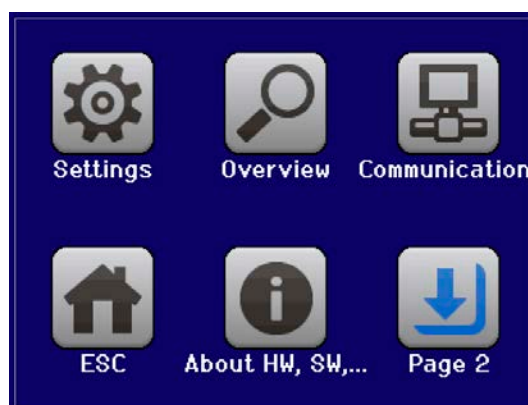
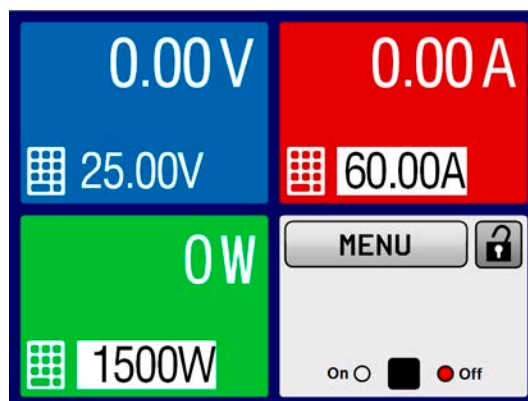

3.4.3.1 Menu “Settings”

This is main menu for all settings related to the general operation of the device and of the interface(s).

Sub menu	Description
Output Settings	Allows for adjustment of set values related to the DC output, alternatively to the handling in the main screen of the display
Protection Settings	Allows for adjustment of protection thresholds (here: OVP, OCP, OPP) related to the DC output. Also see section „3.3. Alarm conditions“
Limit Settings	Allows for adjustment of adjustment limits for set values. Also see section „3.4.4. Adjustment limits (Limits)“
General Settings	Settings for the operation of the device and its interface(s). Details below
Reset device	Touch area “ Start ” will initiate a reset of all settings (HMI, profile etc.) to default values, as shown in the menu structure diagrams on the previous pages, and all set values to 0
Calibrate device	Touch area “ Start ” starts a calibration routine (see „4.3. Calibration“), but only if the device is in U/I/P mode, i.e. R mode not activated.

3.4.3.2 Menu “General Settings”

Setting	Description
Allow remote control	Selection “ NO ” means that the device can’t be remotely controlled over either the digital or analog interfaces. If remote control isn’t allowed, the status will be shown as “ local ” in the status area on the main display. See also section 1.9.5.1
DC output after power ON	Determines the condition of the DC output after power-up. <ul style="list-style-type: none"> • OFF = DC output is always off after switching on the device. • Restore = DC output condition will be restored to the condition prior to switch off.
DC output after PF alarm	Determines how the DC output shall react after a power fail (PF) alarm has occurred: <ul style="list-style-type: none"> • OFF= DC output will be switched off and remain until user action • AUTO = DC output will switch on again after the PF alarm cause is gone and if it was switched on before the alarm occurred
DC output after remote	Determines the condition of the DC output after leaving remote control either manually or by command. <ul style="list-style-type: none"> • OFF = DC output will be always off when switching from remote to manual • AUTO = DC output will keep the last condition
Analog interface range	Selects the voltage range for the analog set value inputs, actual value outputs and the reference voltage output. <ul style="list-style-type: none"> • 0...5 V = Range is 0...100% set /actual values, reference voltage 5 V • 0...10 V = Range is 0...100% set /actual values, reference voltage 10 V See also section „3.5.4 Remote control via the analog interface (AI)“ on page 46
Analog interface Rem-SB	Selects how the input pin REM-SB of the analog interface shall be working regarding levels (see „3.5.4.4 Analog interface specification“ on page 47) and logic: <ul style="list-style-type: none"> • Normal = Levels and function as described in the table in 3.5.4.4 • Inverted = Levels and function will be inverted Also see „3.5.4.7. Application examples“
Analog Rem-SB action	Selects the action on the DC output that is initiated when changing the level of analog input REM-SB: <ul style="list-style-type: none"> • DC OFF = the pin can only be used to switch the DC output off • DC ON/OFF = the pin can be used to switch the DC output off and on again, if it has been switched on before at least from a different control location
USB file separator format	Switches the decimal point format of values and also the CSV file separator for USB logging and for other features where CSV file can be loaded <p>US = Comma separator (US standard for CSV files) Default = Semicolon separator (german/european standard for CSV files)</p>

Setting	Description
USB logging with units (V,A,W)	CSV files generated from USB logging by default add physical units to values. This can be deactivated by setting this option to “No”

3.4.3.3 Menu “Profiles”

See „3.9 Loading and saving an user profile“ on page 52.

3.4.3.4 Menu “Overview”

This menu page displays an overview of the set values (U, I, P) and alarm settings as well as settings limits. These can only be displayed, not changed.

3.4.3.5 Menu “About HW, SW...”

This menu page displays an overview of device relevant data such as serial number, article number etc., as well as an alarm history which lists the number of device alarms that probably occurred since the device has been powered.

3.4.3.6 Menu “Communication”

Apart from settings related to the USB logging feature, all settings for the digital interface(s) on the rear side are configured here. Upon delivery, the device only features an USB port which doesn't require configuration. It can be extended by an Ethernet/LAN port by installing the optional 3-way interface board IF-KE4. After installation or a complete device reset, the Ethernet port has following **default settings** assigned:

- DHCP: off
- IP: 192.168.0.2
- Subnet mask: 255.255.255.0
- Gateway: 192.168.0.1
- Port: 5025
- DNS: 0.0.0.0

Those settings can be changed anytime and configured to meet local requirements. Furthermore, there are global communication settings available regarding timing and protocols.

Submenu “IP Settings 1”

Element	Description
Addr. source	DHCP: With DHCP selected the device will try to get network parameters (IP, subnet mask, gateway, DNS) assigned from a DHCP server after power-on or when changing from Manual to DHCP and submitting the change with button ENTER. If the DHCP configuration attempt fails, the device will use the settings from Manual . In this case, the overview in screen View settings will indicate the DCHP status as DHCP (failed) , otherwise as DHCP(active) Manual (default setting): uses either the default network parameters (after reset) or the last user setting. Those parameters are not overwritten from selection DHCP and are thus available when switching to Manual again.
IP address	Only available with setting “ Manual ”. Default value: 192.168.0.2 Manual setting of the device's IP address in standard IP format (setting will be stored)
Subnet mask	Only available with setting “ Manual ”. Default value: 255.255.255.0 Manual setting of the subnet mask in standard IP format (setting will be stored)
Gateway	Only available with setting “ Manual ”. Default value: 192.168.0.1 Manual setting of the gateway address in standard IP format (setting will be stored)

Submenu “Logging”

Element	Description
Enable USB logging	Default setting: disabled Enables/disables the “log to USB stick” feature. Once enabled, you can define the log interval (multiple steps, 500 ms ... 5 s) and choose between Start/stop with DC on/off or Manual start/stop . With a properly formatted USB stick (also see 1.9.5.5) plugged, logging to USB stick can be used anytime. For more refer to „3.4.8. Recording to USB stick (logging)“.

Submenu "IP Settings 2"

Element	Description
DNS address	Default value: 0.0.0.0 Permanent manual setting of the network address of a domain name server (short: DNS) which has to be present in order to translate the host name to the device's IP, so the device could alternatively access by the host name
Port	Default value: 5025, range: 1...65535, except for reserved ports Adjust the socket port here, which belongs to the IP address and serves for TCP/P access when controlling the device remotely via Ethernet Note: since KE firmware V3.07 the device supports ModBus TCP, which automatically uses the reserved port 502. This means, it's not allowed to adjust port 502 here.

Submenu "TCP Keep-Alive"

Element	Description
Enable TCP keep-alive	Default setting: disabled Enables/disables the "keep-alive time" functionality for the device. If keep-alive is supported by the network, it can help to keep TCP connections open over long periods of no communication. This overrides the Ethernet timeout setting. See below at "Timeout ETH".

Submenu "Com Protocols" (communication protocols)

Element	Description
SCPI / ModBus	Default setting: both enabled Enables/disables SCPI or ModBus communication protocols for the device. The change is immediately effective after submitting it with ENTER button. Only one of both can be disabled.

Submenu "Com Timeout" (communication timeout)

Element	Description
Timeout USB (ms)	Default value: 5, range: 5...65535 USB/RS232 communication timeout in milliseconds. Defines the max. time between two subsequent bytes or blocks of a transferred message. For more information about the timeout refer to the external programming documentation "Programming ModBus & SCPI".
Timeout ETH (s)	Default value: 5, range: 5...65535 Connection timeout in seconds. Defines the time after which the device disconnects the Ethernet socket automatically due to inactivity, unless "TCP keep-alive" (see above) is activated and supported by the network.

3.4.3.7 Menu "HMI Setup"

These settings refer exclusively to the control panel (HMI).

Element	Description
Language	Selection of the display language between German, English, Russian or Chinese.
Backlight	The choice here is whether the backlight remains permanently on or if it should be switched off when no input via screen or rotary knob is made for 60 s. As soon as input is made, the backlight returns automatically. Furthermore the brightness can be selected in 10 steps.
HMI Lock	See "3.7 Control panel (HMI) lock" on page 51 resp. "3.8. Limits lock"
Status Page	When enabled, this option switches the main screen of the device display to a simpler version with only voltage and current plus status.

3.4.4 Adjustment limits (Limits)



Adjustment limits are only effective on the related set values, no matter if using manual adjustment or remote control setting!



The limits settings could be locked by a PIN (see MENU -> HMI Setup -> HMI Lock)

Defaults are that all set values (U, I, P) are adjustable from 0 to 102% of the rated value.

The full range may be obstructive in some cases, especially for protection of applications against overvoltage. Therefore upper and lower limits for current (I) and voltage (U) can be set separately, which then limit the range of the adjustable set values.

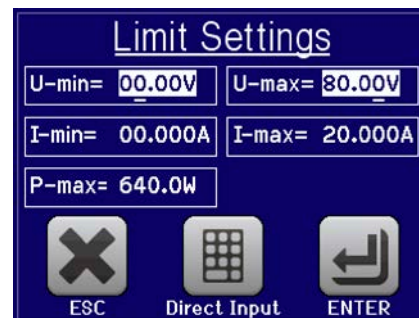

For power (P) only an upper limit can be set.



► How to configure the adjustment limits

1. On the main screen, tap  to access the SETTINGS menu.



2. Tap on  and then on  to open the menu page for the adjustment limits.
3. In each case a pair of upper and lower limits for U/I resp. the upper limit for P only is assigned to the rotary knobs and can be adjusted. Tap another pair/value to switch the selection.
4. Accept the settings with .



The set values can be entered directly using the ten-key pad. This appears when the touch area for direct input is tapped (bottom centre)



The adjustment limits are coupled to the set values. It means, that the upper limit may not be set lower than the corresponding set value. Example: If you wish to set the limit for the power set value (P-max) to 1000 W while the currently adjusted power set value is 1100 W, then the set value first would have to be reduced to 1000 W or less.

3.4.5 Manual adjustment of set values

The set values for voltage, current and power are the fundamental operating possibilities of a power supply and hence the two rotary knobs on the front of the device are always assigned to two of the values in manual operation. Default assignment is voltage and current.

Set values can be entered manually in two ways: via **rotary knob** or **direct input**.



Entering a value changes it at any time, no matter if the DC output is switched on or off. As long as the output is still switched off, the set values can be considered as presets which only become active when switching the DC output on. The characteristics of the output voltage rise depends on how you do it. There are two options: either set voltage/current/power first and then switch the DC output on or vice versa.



When adjusting the set values, upper or lower limits may come into effect. See section „3.4.4. Adjustment limits (Limits)“. Once a limit is reached, the display will show a note like “Limit: U-max” etc. for 1.5 seconds next to the adjusted value.

► How to adjust values with the rotary knobs

1. First check if the value you want to change is already assigned to one of the rotary knobs. The main screen displays the assignment with the two assigned set values being inverted.
2. If, as shown in the example, the assignment is voltage (U, left-hand knob) and current (I, right-hand knob) and you wish to set the power the assignment of the left-hand knob can be changed by tapping the green area for power. This will switch the knob to power adjustment and highlight the power value.

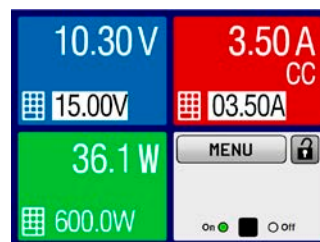

3. After successful selection, the desired value can be set within the defined limits. Selecting a digit is done by pushing the rotary knob which shifts the cursor from right to left (selected digit will be underlined):



► How to adjust values via direct input

1. In the main screen, depending on the rotary knob assignment, values can be set for voltage (U), current (I) or power (P) via direct input by tapping on the small keypad symbol in the set/actual value display areas, e.g in the uppermost area of voltage.
2. Enter the required value using the ten-key pad. Similar to a pocket calculator the key **c** clears the input.



Decimal values are set by tapping the point key. For example, 54.3 V is set with **5** **4** **.** **3** and **ENTER**.

3. The display reverts to the main page and the set values take effect.

3.4.6 Switching the main screen view

The main screen, also called status page, with its set values, actual values and device status can be switched from the standard view mode with three or four values to a simpler mode with only voltage and current display. The advantage of the alternative view mode is that actual values are displayed with **bigger characters**, so they can be read from a larger distance. Refer to „3.4.3.7. Menu “HMI Setup”“ to see where to switch the view mode in the MENU. Comparison:

Standard status page

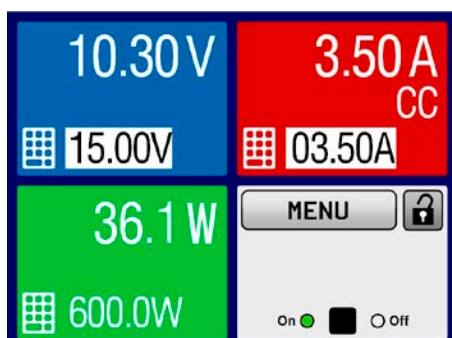

Alternative status page

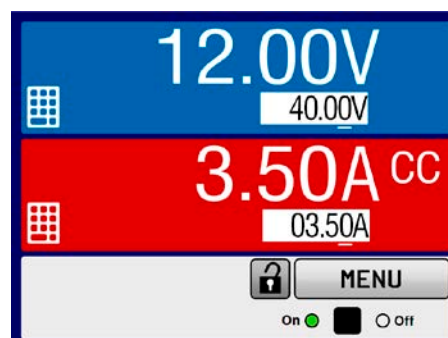

Limitations of the alternative status page:



In alternative status page mode, the set value of power isn't adjustable while the DC output is switched on. It can only be accessed and adjusted in SETTINGS while the DC output is off.

Rules for manual handling of the HMI in alternative status page mode:

- The two rotary knobs are assigned to voltage (left knob) and current (right knob) all the time, except for menus
- Set values input is the same as in standard status page mode, with knobs or by direct input
- Regulation mode CP is displayed alternatively to CC at the same position

3.4.7 Switching the DC output on or off

The DC output of the device can be manually or remotely switched on and off. This can be restricted in manual operation by the control panel being locked.



Switching the DC output on during manual operation or digital remote control could be disabled by pin REM-SB of the optional analog interface, if installed. For more information refer to 3.4.3.2 and example a) in 3.5.4.7.

► How to manually switch the DC output on or off

1. As long as the control panel isn't fully locked press the button **On/Off**. Otherwise you are asked to disable the HMI lock first.
2. This button toggles between on and off, as long as a change isn't restricted by an alarm or the device is locked in "remote". The DC output condition is displayed as either "**On**" or "**Off**", next to LEDs with corresponding colour.

► How to remotely switch the DC output on or off via the analog interface

1. See section „3.5.4 Remote control via the analog interface (AI)“ on page 46.

► How to remotely switch the DC output on or off via the digital interface

1. See the external documentation "Programming Guide ModBus & SCPI" if you are using custom software, or refer to the external documentation from LabView VIs or other software provided by the manufacturer.

3.4.8 Recording to USB stick (logging)

Device data can be recorded to USB stick (2.0, 3.0, not all vendors supported) anytime. For specifications of the USB stick and the generated log files refer to section „1.9.5.5. USB port (front side)“.



The logging stores files of CSV format on the stick. The layout of the log data is the same as when logging via PC with software EA Power Control. The advantage of USB logging over PC logging is the mobility and that no PC is required. The logging feature just has to be activated and configured in the MENU.

3.4.8.1 Configuration

Also see section 3.4.3.6. After USB logging has been enabled and the parameters “Logging interval” and “Start/Stop” have been set, logging can be started anytime from within the MENU or after leaving it, depends on the selected start/stop mode.

3.4.8.2 Handling (start/stop)

With setting “**Start/stop with DC on/off**” logging will start each time the DC output of the device is switched on, no matter if manually with the front button “On/Off” or remotely via analog or digital interface. With setting “**Manual start/stop**” it’s different. Logging is then started and stopped only in the MENU, in the logging configuration page.

Soon after logging has been started, the symbol  indicates the ongoing logging action. In case there is an error while logging, such as USB stick full or removed, it will be indicated by another symbol (). After every manual stop or switching the DC output off the logging is stopped and the log file closed.

3.4.8.3 Log file format

Type: text file in european CSV format

Layout:

	A	B	C	D	E	F	G	H	I	J	K	L	M
1	U set	U actual	I set	I actual	P set	P actual	R set	R actual	R mode	Output/Input	Device mode	Error	Time
2	2,00V	11,92V	1,20A	1,20A	7344W	15W	N/A	N/A	OFF	ON	CC	NONE	00:00:00,942
3	2,00V	11,90V	1,20A	1,20A	7344W	15W	N/A	N/A	OFF	ON	CC	NONE	00:00:01,942
4	2,00V	11,89V	1,20A	1,20A	7344W	15W	N/A	N/A	OFF	ON	CC	NONE	00:00:02,942
5	2,00V	11,87V	1,20A	1,20A	7344W	15W	N/A	N/A	OFF	ON	CC	NONE	00:00:03,942

Legend:

U set / I set / P set / R set: Set values (resistance isn’t available with this series, so it shows N/A)

U actual / I actual / P actual / R actual: Actual values (ditto regarding resistance)

Error: device alarms

Time: elapsed time since logging start

Device mode: actual regulation mode (also see „3.2. Operating modes“)

Important to know:

- Unlike the logging on PC, every log start here creates a new log file with a counter in the file name, starting generally with 1, but minding existing files

3.4.8.4 Special notes and limitations

- Max. log file size (due to FAT32 formatting): 4 GB
- Max. number of log files in folder HMI_FILES: 1024
- With setting “**Start/stop with DC on/off**”, the logging will also stop on alarms, because they switch off the DC output
- With setting “**Manual start/stop**” the device will continue to log even on occurring alarms, so this mode can be used to determine the period of temporary alarms like OT or PF

3.5 Remote control

3.5.1 General

Remote control is possible via the built-in USB port (rear side) or the optionally available interfaces Analog and Ethernet (also see sections 1.9.4, 1.9.8 and 1.9.9). Important here is that only the analog or any of the digital interfaces can be in control. It means that if, for example, an attempt were to be made to switch to remote control via the digital interface whilst analog remote control is active (pin REMOTE = LOW) the device would report an error via the digital interface. In the opposite direction, a switch-over via pin REMOTE would be ignored. In both cases, however, status monitoring and reading of values are always possible.

3.5.2 Control locations

Control locations are those locations from where the device is controlled. Essentially there are two: at the device (manual operation) and outside (remote control). The following locations are defined:

Displayed location	Description
-	If neither of the other locations is displayed then manual control is active and access from the analog and digital interfaces is allowed. This location isn't explicitly displayed
Remote	Remote control via any interface is active
Local	Remote control is locked, only manual operation is allowed.

Remote control may be allowed or inhibited using the setting “**Allow remote control**” (see „3.4.3.2. Menu “General Settings”). In inhibited condition the status “**Local**” will be displayed in the bottom right area. Activating the lock can be useful if the device is remotely controlled by software or some electronic device, but it's required to make adjustments at the device or deal with emergency, which would not be possible remotely.

Activating condition “**Local**” causes the following:

- If remote control via the digital interface is active (“**Remote**”), then it's immediately terminated and in order to continue remote control once “**Local**” is no longer active, it can be reactivated at the PC
- If remote control via the analog interface is active (“**Remote**”), then it's temporarily interrupted until remote control is allowed again by deactivating “**Local**”, because pin REMOTE continues to signal “remote control = on”, unless this has been changed during the “**Local**” period

3.5.3 Remote control via a digital interface

3.5.3.1 Selecting an interface

The device only supports the built-in digital interfaces USB and Ethernet (optionally available).

For USB, a standard USB cable is included in the delivery, as well as a driver for Windows on USB stick. The USB interface requires no setup in the MENU.

The Ethernet interface typically requires network setup (manual or DHCP), but can also be used with its default parameters right from the start.

3.5.3.2 General

For the network port installation refer to „1.9.8. Ethernet port“.

The digital interface require little or no setup for operation and can be directly used with their default configuration. All specific settings will be permanently stored, but could also be reset to defaults with the setup menu item “**Reset Device**”.

Via the digital interface primarily the set values (voltage, current, power) and device conditions can be set and monitored. Furthermore, various other functions are supported as described in separate programming documentation.

Changing to remote control will retain the last set values for the device until these are changed. Thus a simple voltage control by setting a target value is possible without changing any other values.

3.5.3.3 Programming

Programming details for the interfaces, the communication protocols etc. are to be found in the documentation “Programming Guide ModBus & SCPI” which is supplied on the included USB stick or which is available as download from the EA Elektro-Automatik website.

3.5.4 Remote control via the analog interface (AI)

3.5.4.1 General

The optionally available, galvanically isolated, 15-pole analog interface (short: AI, also see section 1.9.9) is located on the back side of the device after installation and offers the following possibilities:

- Remote control of current, voltage and power
- Remote status monitoring (CV)
- Remote alarm monitoring (OT, OVP, PF)
- Remote monitoring of actual values
- Remote on/off switching of the DC output

Setting the **three** set values of voltage, current and power via the analog interface always takes place concurrently. It means, that for example the voltage can't be given via the AI and current and power set by the rotary knobs, or vice versa.

The OVP set value and alarm thresholds can't be set via the AI and therefore must be adapted to the given situation before the AI is put in operation. Analog set values can be fed in by an external voltage or generated by the reference voltage on pin 3. As soon as remote control via the analog interface is activated, the values displayed will be those provided by the interface.

The AI can be operated in the common voltage ranges 0...5 V and 0...10 V in each case 0...100% of the nominal value. The selection of the voltage range can be done in the device setup. See section „3.4.3. Configuration via MENU“ for details.

The reference voltage sent out from Pin 3 (VREF) will be adapted accordingly and is then:

0-5 V: Reference voltage = 5 V, 0...5 V set values (VSEL, CSEL, PSEL) correspond to 0...100% nominal values, 0...100% actual values correspond to 0...5 V at the actual value outputs (CMON, VMON).

0-10 V: Reference voltage = 10 V, 0...10 V set values (VSEL, CSEL, PSEL) correspond to 0...100% nominal values, 0...100% actual values correspond to 0...10 V at the actual value outputs (CMON, VMON).

Input of excess set values (e.g. >5 V in selected 5 V range or >10 V in the 10 V range) are clipped by setting the set value at 100%.

Before you begin, please read. Important notes for use of the interface:



After powering the device and during the start phase the AI signals undefined statuses on the output pins such as ERROR. Those must be ignored until it's ready to work.

- Analog remote control of the device must be activated by switching pin REMOTE (5) first. Only exception is pin REM-SB, which can be used independently
- Before the hardware is connected that will control the analog interface, it shall be checked that it can't provide voltage to the pins higher than specified
- Set value inputs, such as VSEL, CSEL, PSEL, must not be left unconnected (i.e. floating). In case any of the set values isn't used for adjustment, it can be tied to a defined level or connected to pin VREF (solder bridge or different), so it gives 100%

3.5.4.2 Resolution and sample rate

The analog interface is internally sampled and processed by a digital microcontroller. This causes a limited resolution of analog steps. The resolution is the same for set values (VSEL etc.) and actual values (VMON/CMON) and is approx. 16384 (14 bits). Due to tolerances, the truly achievable resolution can be slightly lower.

There is furthermore a max. sample rate of 500 Hz for the inputs. It means, the device can acquire analog set values and statuses on digital pins 500 times per second.

3.5.4.3 Acknowledging device alarms

Device alarms (see 3.6.1) are always indicated in the front display and some of them are also reported as signal on the analog interface socket (see 3.5.4.4), for example the overvoltage alarm (OV), which is considered as critical.

In case of a device alarm occurring during remote control via analog interface, the DC output will be switched off the same way as in manual control. While alarms OT and OV can be monitored via the corresponding pins of the interface, other alarms like overcurrent (OC) can't. Those could only be monitored and detected via the actual values of voltage and current being all zero contrary to the set values.

Some device alarms have to be acknowledged, either by the user of the device or by the controlling unit. Also see „3.6.1. Device alarm handling“. Acknowledgement is done with pin REM-SB switching the DC output off and on again, means a HIGH-LOW-HIGH edge (min. 50 ms for LOW).

3.5.4.4 Analog interface specification

Pin	Name	Type*	Description	Levels	Electrical specification-
1	VSEL	AI	Set voltage value	0...10 V or. 0...5 V correspond to 0..100% of U_{Nom}	Accuracy 0-5 V range: < 0.4% **** Accuracy 0-10 V range: < 0.2% **** Input impedance R_i >40 k...100 k
2	CSEL	AI	Set current value	0...10 V or. 0...5 V correspond to 0..100% of I_{Nom}	
3	VREF	AO	Reference voltage	10 V or 5 V	Tolerance < 0.2% at $I_{max} = +5$ mA Short-circuit-proof against AGND
4	DGND	POT	Ground for all digital signals		For control and status signals
5	REMOTE	DI	Switching internal / remote control	Remote = LOW, $U_{Low} < 1$ V Internal = HIGH, $U_{High} > 4$ V Internal = Open	Voltage range = 0...30 V $I_{Max} = -1$ mA at 5 V U_{LOW to HIGH typ. = 3 V Rec'd sender: Open collector against DGND
6	ERROR	DO	Overheating alarm or Power Fail	Alarm = HIGH, $U_{High} > 4$ V No Alarm = LOW, $U_{Low} < 1$ V	Quasi open collector with pull-up against V_{cc} ** With 5 V on the pin max. flow +1 mA $I_{Max} = -10$ mA at $U_{CE} = 0,3$ V $U_{Max} = 30$ V Short-circuit-proof against DGND
7	-	-	-	-	-
8	PSEL	AI	Set power value	0...10 V or. 0...5 V correspond to 0..100% of P_{Nom}	Accuracy 0-5 V range: < 0.4% **** Accuracy 0-10 V range: < 0.2% **** Input impedance R_i >40 k...100 k
9	VMON	AO	Actual voltage	0...10 V or. 0...5 V correspond to 0..100% of U_{Nom}	Accuracy 0-5 V range: < 0.4% **** Accuracy 0-10 V range: < 0.2% **** at $I_{Max} = +2$ mA Short-circuit-proof against AGND
10	CMON	AO	Actual current	0...10 V or. 0...5 V correspond to 0..100% of I_{Nom}	
11	AGND	POT	Ground for all analog signals		For -SEL, -MON, VREF signals
12	-	-	-	-	-
13	REM-SB	DI	DC output OFF (DC output ON) (ACK alarms ***)	Off = LOW, $U_{Low} < 1$ V On = HIGH, $U_{High} > 4$ V On = Open	Voltage range = 0...30 V $I_{Max} = +1$ mA at 5 V Rec'd sender: Open collector against DGND
14	OVP	DO	Overvoltage alarm	Alarm OV = HIGH, $U_{High} > 4$ V No alarm OV = LOW, $U_{Low} < 1$ V	Quasi open collector with pull-up against V_{cc} ** With 5 V on the pin max. flow +1 mA $I_{Max} = -10$ mA at $U_{CE} = 0,3$ V, $U_{Max} = 30$ V Short-circuit-proof against DGND
15	CV	DO	Constant voltage regulation active	CV = LOW, $U_{Low} < 1$ V CC/CP/CR = HIGH, $U_{High} > 4$ V	

* AI = Analog Input, AO = Analog Output, DI = Digital Input, DO = Digital Output, POT = Potential

** Internal V_{cc} approx. 10 V

*** Only during remote control

**** The error adds to the general error of the related value on the DC output of the device

3.5.4.5 Overview of the Sub-D Socket

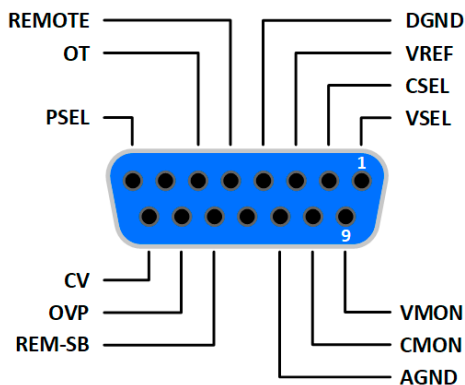

3.5.4.6 Simplified diagram of the pins

	<p>Digital Input (DI) It requires to use a switch with low resistance (relay, switch, circuit breaker etc.) in order to send a clean signal to the DGND.</p>		<p>Analog Input (AI) High resistance input (impedance >40 kΩ....100 kΩ) for an OA circuit.</p>
	<p>Digital Output (DO) A quasi open collector, realised as high resistance pull-up against the internal supply. In condition LOW it can carry no load, merely switch, as shown in the diagram with a relay as example.</p>		<p>Analog Output (AO) Output from an OA circuit, only minimally impedant. See specifications table above.</p>

3.5.4.7 Application examples

a) Switching the DC output with pin REM-SB

A digital output, e.g. from a PLC, may be unable to cleanly pull down the pin as it may not be of low enough resistance. Check the specification of the controlling application. Also see pin diagrams above.

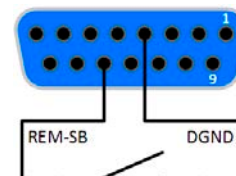

In remote control, pin REM-SB is be used to switch the DC output of the device on and off. The function of the pin is also available without remote control being active. See below.

It's recommended that a low resistance contact such as a switch, relay or transistor is used to switch the pin to ground (DGND).

Following situations can occur:

- **Remote control has been activated**

During remote control via analog interface, only pin REM-SB determines the states of the DC output, according to the levels definitions in 3.5.4.4. The logical function and the default levels can be inverted by a parameter in the setup menu of the device. See 3.4.3.2.

If the pin is unconnected or the connected contact is open, the pin will be HIGH. With parameter "Analog interface REM-SB" being set to "normal", it requests "DC output on". So when activating remote control, the DC output will instantly switch on.

• **Remote control isn't active**

In this mode of operation pin REM-SB can serve as lock, preventing the DC output from being switched on by any means. This results in following possible situations:

DC output	+	Level on pin REM-SB	+	Parameter „Analog interface Rem-SB“	→	Behaviour
is off	+	HIGH	+	Normal	→	The DC output isn't locked. It can be switched on by pushbutton "On/Off" (front panel) or via command from digital interface.
		LOW	+	Inverted		
	+	HIGH	+	Inverted	→	The DC output is locked. It can't be switched on by pushbutton "On/Off" (front panel) or via command from digital interface. When trying to switch on, a popup in the display resp. an error message will be generated.
		LOW	+	Normal		

In case the DC output is already switched on, toggling the pin will switch the DC output off, similar to what it does in analog remote control:

DC output	+	Level on pin REM-SB	+	Parameter „Analog interface Rem-SB“	→	Behaviour
is on	+	HIGH	+	Normal	→	The DC output remains on, nothing is locked. It can be switched on or off by pushbutton or digital command.
		LOW	+	Inverted		
	+	HIGH	+	Inverted	→	The DC output will be switched off and locked. Later it can be switched on again by toggling the pin. During lock, pushbutton or digital command can delete the request to switch on by pin.
		LOW	+	Normal		

b) Remote control of current and power

Requires remote control to be activated (pin REMOTE = LOW)

The set values PSEL and CSEL are generated from, for example, the reference voltage VREF, using potentiometers for each. Hence the power supply can selectively work in current limiting or power limiting mode. According to the specification of max. 5 mA for the VREF output, potentiometers of at least 10 kΩ must be used.

The voltage set value VSEL is directly connected to VREF and will thus be permanently 100%.

If the control voltage is fed in from an external source it's necessary to consider the input voltage ranges for set values (0...5 V oder 0...10 V).

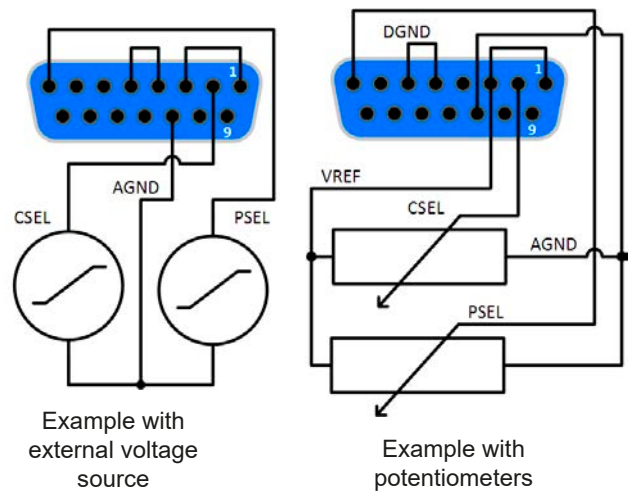

Use of the input voltage range 0...5 V for 0...100% set value halves the effective resolution.

c) Reading actual values

The AI provides the DC output values as current and voltage monitor. These can be read using a standard multimeter or similar.

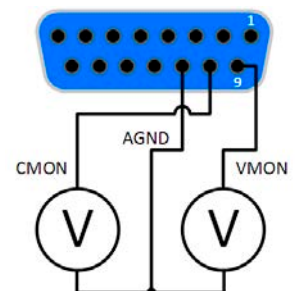

3.6 Alarms and monitoring

3.6.1 Device alarm handling

A device alarm incident will usually lead to DC output switch-off. Some alarms must be acknowledged (see below), which can only happen if the cause of the alarm isn't persistent anymore. Other alarms acknowledge themselves if the cause has vanished, like the OT and the PF alarm.

► **How to acknowledge an alarm in the display (during manual control)**

1. If the alarm is indicated as a pop-up, tap **OK**.
2. If the alarm has already been acknowledged, but is still displayed in the status area, then first tap the status area to display the pop-up, and then acknowledge with **OK**.



In order to acknowledge an alarm during analog remote control, see „3.5.4.3. Acknowledging device alarms“. To acknowledge in digital remote, refer to the external documentation “Programming ModBus & SCPI”.

Some device alarms are configurable:

Alarm	Meaning	Description	Range	Indication
OVP	OverVoltage Protection	Triggers an alarm if the DC output voltage reaches the defined threshold. The DC output will be switched off.	0 V...1.1*U _{Nom}	Display, analog IF, digital IF
OCP	OverCurrent Protection	Triggers an alarm if the DC output current reaches the defined threshold. The DC output will be switched off.	0 A...1.1*I _{Nom}	Display, digital IF
OPP	OverPower Protection	Triggers an alarm if the DC output power reaches the defined threshold. The DC output will be switched off.	0 W...1.1*P _{Nom}	Display, digital IF

These device alarms can't be configured and are based on hardware:

Alarm	Meaning	Description	Indication
PF	Power Fail	AC supply over- or undervoltage. Triggers an alarm if the AC supply is out of specification or when the device is cut from supply, for example when switching it off with the power switch. The DC output will be switched off.	Display, analog & digital interface
OT	OverTemperature	Triggers an alarm if the internal temperature reaches a certain limit. The DC output will be switched off.	Display, analog & digital interface

► **How to configure the device alarms**

1. While the DC output is switched off, tap the touch area  on the main screen.
2. In the menu tap on “**Settings**” and then on “**Protection Settings**”.
3. Set the thresholds for the device alarms relevant to your application if the default value of 103% (OVP) resp. 110% (OCP, OPP) is unsuitable.

 *The set values can be entered using the ten-key tab. This will appear by tapping the touch area “Direct input”.*

3.7 Control panel (HMI) lock

In order to avoid the accidental alteration of a value during manual operation, the rotary knobs or the touchscreen can be locked so that no alteration of values will be accepted without prior unlocking.

► How to lock the HMI

1. In the main page, tap the lock symbol .
2. In the settings page “**HMI Lock Setup**” you are then asked to choose between a complete HMI lock (check mark set for “**Lock HMI**”) or a partial lock where the On/Off button on the front of the device is still usable (check mark also set for “**On/Off**”). You may also choose to activate the additional PIN (“**Enable PIN**”). The device would later request to enter this PIN every time you want to unlock the HMI, until the PIN is deactivated again.

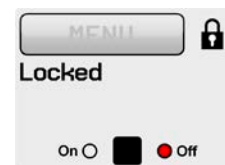

Be careful with the “**Enable PIN**” option if you are unsure what PIN is currently set. If you are unsure, use “**Change PIN**” to define a new one.

3. Activate the lock with . The status “**Locked**” as shown in the figure to the right.

If an attempt is made to alter something whilst the HMI is locked, a requester appears in the display asking if the lock should be disabled.

► How to unlock the HMI

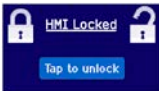
1. Tap any part of the touchscreen of the locked HMI, or turn one of the rotary knobs or press the button “On/Off” (only in “Lock all” situation).
2. This request pop-up will appear: . The pop-up shows a lock icon, the text 'HMI Locked', and a blue button labeled 'Tap to unlock'.
3. Unlock the HMI by tapping on “Tap to unlock” within 5 seconds, otherwise the pop-up will disappear and the HMI remains locked. In case the additional **PIN code lock** has been activated in the menu “**HMI Lock**”, another requester will pop up, asking you to enter the **PIN** before it finally unlocks the HMI.

3.8 Limits lock

In order to avoid the alteration of the adjustment limits (also see „3.4.4. Adjustment limits (Limits)“) by an unprivileged user, the screen with the adjustment limit settings (“Limits”) can be locked by a PIN code. The menu pages “**Limit Settings**” and “**Profiles**” will then become inaccessible until the lock is removed. Tapping a locked menu page. i.e. touch area is greyed out, will give the option to unlock the access by entering the PIN.

► How to lock the limits settings page

1. While the DC output is switched off, tap the touch area  on the main screen.
2. In the menu tap on “**Page 2**”, then “**HMI Setup**” and there “**HMI Lock**”.
3. In the settings page set the check mark for “**Lock limits**” and also “**Enable PIN**”.





Enabling the PIN for the limits lock is recommended. The PIN is also used for the HMI lock.

4. Activate the lock by leaving the settings page with .



Be careful with the “**Enable PIN**” option if you are unsure what PIN is currently set. If you are unsure, use “**Change PIN**” to define a new one.

► How to unlock the limits settings

1. While the DC output is switched off, tap the touch area  on the main screen.
2. In the menu tap on “**Page 2**”, then “**HMI Setup**” and there “**HMI Lock**”.
3. In the settings page “**HMI Lock Setup**” remove the check mark for “**Lock Limits**”. In the following pop-up tap on “**Unlock**” and then you will be asked to enter the 4-digit PIN.
4. Deactivate the lock by submitting the correct PIN with .

3.9 Loading and saving an user profile

The menu “**Profiles**” serves to select between a default profile and up to 5 user profiles. A profile is a collection of all settings and set values. Upon delivery, or after a reset, all 6 profiles have the same settings and all set values are 0. If the user changes settings or sets target values then these create a working profile which can be saved to one of the 5 user profiles. These profiles or the default one can then be switched. The default profile is read-only.

The purpose of a profile is to load a set of set values, settings limits and monitoring thresholds quickly without having to readjust these. As all HMI settings are saved in the profile, including language, a profile change can also be accompanied by a change in HMI language.

On calling up the menu page and selecting a profile the most important settings can be seen, but not changed.

► How to save the current values and settings (working profile) as an user profile

1. While the DC output is switched off, tap the touch area  on the main screen
2. In the menu page, tap on “**Page 2**” and then on “**Profiles**”.
3. In the selection screen (see image to the right) choose between user profiles 1-5 in which the settings are to be saved. The profile will then be displayed and the values can be checked, but not changed.
4. Tap on touch area “**Save/Load**” and in the next screen save the user profile with touch area “**Save**”.



► How to load an user profile to work with

1. While the DC output is switched off, tap the touch area  on the main screen
2. In the menu page, tap on “**Page 2**” and then on “**Profiles**”.
3. In the selection screen (see image to the right) choose between user profiles 1-5 in which the settings are to be saved. The profile will then be displayed and the values can be checked, but not changed.
4. Tap on touch area “**Save/Load**” and in the next screen load the user profile with touch area “**Load**”.

User profiles can also be loaded from and saved to a properly formatted USB stick (see section 1.9.5.5 for details).

► How to load an user profile from USB stick or save to

1. While the DC output is switched off, tap the touch area  on the main screen
2. In the menu page, tap on “**Page 2**” and then on “**Profiles**”.
3. In the selection screen (see image to the right) choose between user profiles 1-5 in which the settings are to be saved. The profile will then be displayed and the values can be checked, but not changed.
4. Tap on touch area “**Import/Export**” and in the next screen either save the profile to USB stick by tapping on “Save to USB” or load it from the stick with “Load from USB”.



- When loading a profile from USB stick it will overwrite all previously stored values of the selected user profile
- The number in the profile file name isn't related to the user profile number from which it once was saved or to which is it going to be loaded
- The selector for picking a profile file to load can only list the first 10 files in the folder
- Profile files are checked for validity upon load to determine if the stored values match the device

After a profile has been loaded from USB stick it doesn't become effective automatically. Like when switching between profiles, it requires to load the user profile into the working profile. See above for the steps.

3.10 Other applications

3.10.1 Series connection

Series connection of two or multiple devices is basically possible, but for reasons of safety and isolation following restrictions apply:



- Both, negative (DC-) and positive (DC+) output poles are coupled to PE via type X capacitors, limiting the max. allowed potential shift (see technical specs for rating)
- Remote sensing must not be connected!
- Series connection is only allowed with devices of the same kind and model, i.e. power supply with power supply like, for instance, PS 9080-60 T with PS 9080-60 T or PSI 9080-60 T

Series connection isn't explicitly supported by additional connections and signals on the devices. Nothing else than output current and voltage is shared. It means, all units have to be controlled separately regarding set values and DC output status, whether it's manual or remote control.

According to the limit of the potential shift that comes with series connection (also see section „2.3.5. Grounding of the DC output“), models with a certain nominal output voltage must not be connected in series at all, for example a 500 V model. There the DC minus is only isolated up to ± 400 V DC against PE. On the opposite, two 200 V units are allowed to be connected in series.

The analog interfaces of units in series connection are allowed to be wired in parallel, because they are galvanically isolated from the device and the DC output. The grounds (AGND, DGND) on the analog interface are also allowed to be directly connected to PE, like it automatically happens when controlling and directly connecting it to a PC.

3.10.2 Parallel operation

Multiple devices of same kind and ideally same model can be connected in parallel in order to create a system with higher total current and hence higher power. This can be achieved by connecting all units to the DC load in parallel, so the single currents can add. There is no support for a balancing between the individual units, like in form of a master-slave system. All power supplies would have to be controlled and set up separately. However, it's possible to have a parallel control by the signals on the analog interface, as this one is galvanically isolated from the rest of the device. There are few general points to consider and adhere:

- Always make parallel connections only with device of same voltage, current and power rating
- Never connect the ground signal of any analog interface with the negative DC output, because it will void the galvanic isolation. This rule is especially important when going to connect any DC output pole to ground (PE) or to shift its potential.
- Never connect DC cables from power supply to power supply, but instead from every power supply device directly to the load, else the total current will exceed the current rating of the DC output clamp

3.10.3 Operation as battery charger

A power supply can be used as a battery charger, but with some restrictions, because it misses a battery supervision and a physical separation from the load in form of a relay or contactor, which is usually featured with true battery chargers as a protection against overvoltage or reversed polarity.

Following has to be considered:

- No false polarity protection inside! Connecting a battery with false polarity will damage the power supply severely, even if it's not powered.
- All models of this series have an internal high resistive base load. This base load would, more or less slowly, discharge a permanently connected battery while the DC output is switched, also when the device isn't powered. It's thus recommended to leave the DC output switched on as long as the battery is connected (equals to trickle charge) and disconnect the battery as soon as charging is finished.

4. Service and maintenance

4.1 Maintenance / cleaning

The device needs no maintenance. Cleaning may be needed for the internal fan, the frequency of cleanse is depending on the ambient conditions. The fan serves to cool the components which are heated by the inherent power loss. A heavily dirt filled fan can lead to insufficient airflow and therefore the DC output would switch off too early due to overheating or possibly lead to defects.

Cleaning the internal fans can be performed with a vacuum cleaner or similar. For this the device probably requires to be opened.

4.2 Fault finding / diagnosis / repair

If the equipment suddenly performs in an unexpected way, which indicates a fault, or it has an obvious defect, this can not and must not be repaired by the user. Contact the supplier in case of suspicion and elicit the steps to be taken.

It will then usually be necessary to return the device to the supplier (with or without guarantee). If a return for checking or repair is to be carried out, ensure that:

- the supplier has been contacted and it's clarified how and where the equipment should be sent.
- the device is in fully assembled state and in suitable transport packaging, ideally the original packaging.
- optional extras such as an AnyBus interface module is included if this is in any way connected to the problem.
- a fault description in as much detail as possible is attached.
- if shipping destination is abroad, the necessary customs papers are attached.

4.2.1 Replacing a defect mains fuse

The device is protected one 5x 20 mm fuse (for value check fuse body or technical specifications in 1.8.3) which is located on the rear of the device, inside a fuse holder (separate or in the AC socket, depends on the model). To replace the fuse, the device isn't required to be opened. Just remove the power cord and unscrew the fuse holder with a flat screw driver. The replacement fuse must be of same value and type.

4.2.2 Firmware updates



Firmware updates should only be installed when they can eliminate existing bugs in the firmware in the device or contain new features.

The firmware of the control panel (HMI), of the communication unit (KE) and the digital controller (DR), if necessary, is updated via the rear side USB port. For this the software EA Power Control is needed which is included with the device or available as download from our website together with the firmware update, or upon request.

However, be advised not to install updates promptly. Every update includes the risk of an inoperable device or system. We recommend to install updates only if...

- an imminent problem with your device can be solved directly, especially if we suggested to install an update during a support case
- a new feature has been added which you definitely want to use. In this case, the full responsibility is transferred to you.

Following also applies in connection with firmware updates:

- Simple changes in firmwares can have crucial effects on the application the devices are use in. We thus recommend to study the list of changes in the firmware history very thoroughly.
- Newly implemented features may require an updated documentation (user manual and/or programming guide, as well as LabView VIs), which is often delivered only later, sometimes significantly later

4.3 Calibration

4.3.1 Preface

The devices of series PS 9000 T feature a function to readjust the most important output values when doing a calibration and in case these values have moved out of tolerance. The readjustment is limited to compensate small differences of up to 1% or 2% of the max. value. There are several reasons which could make it necessary to readjust an unit: component aging, extreme ambient conditions, high frequent use.

In order to determine if a value is out of tolerance, the parameter must be verified first with measurement tools of high accuracy and with at least half the error of the PS device. Only then a comparison between values displayed on the PS device and true DC output values is possible.

For example, if you want to verify and possibly readjust the output current of model PS 9080-60 T at the max. 60 A, which is stated with a max. error of 0.2%, you can only do that by using a suitable shunt with max. 0.1% error or less. Also, when measuring such high currents, it's recommended to keep the process short, in order to avoid the shunt heating up too much. It's furthermore recommended to use a shunt with at least 25% reserve.

When measuring the current with a shunt, the measurement error of the multimeter on the shunt adds to the error of the shunt and the sum of both must not exceed the max. error of the device under calibration.

4.3.2 Preparation

For a successful calibration and readjustment, a few tools and certain ambient conditions are required:

- A measurement device (multimeter) for voltage, with a max. error of half the PS's voltage error. That measurement device can also be used to measure the shunt voltage when readjusting the current
- If the current is also going to be calibrated: a suitable DC current shunt, ideally specified for at least 1.25 times the max. output current of the PS and with a max. error that is half or less than the max. current error of the PS device
- Normal ambient temperature of approx. 20-25°C
- Warmed up PS unit, which has been run for at least 10 minutes under 50% power
- An adjustable load, such as an electronic load, which is capable of consuming at least 102% of the max. voltage and current of the PS device

Before you can start calibrating, a few measures have to be taken:

- Let the PS device warm up in connection with the voltage / current source
- In case the remote sensing input is going to be calibrated, prepare a cable for the remote sensing connector to DC output, but leave it yet unconnected
- Abort any form of remote control
- Install the shunt between PS device and load and make sure the shunt is cooled somehow
- Connect external measurement device to the DC output or to the shunt, depending on whether the voltage is going to be calibrated first or the current

4.3.3 Calibration procedure

After the preparation, the device is ready to be calibrated. From now on, a certain sequence of parameter calibration is important. Generally, you don't need to calibrate all three parameters, but it's recommended to do so.

Important:



When calibrating the output voltage, the remote input "Sense" on the rear of the device has to be disconnected.

The calibration procedure, as explained below, is an example with model PS 9080-60 T. Other models are treated the same way, with values according to the particular PS model and the required load.

4.3.3.1 Calibrating the set values

► How to calibrate the voltage

1. Connect a multimeter to the DC output. Connect a load and set its current to approx. 5% of the nominal current of the power supply, in this example ≈ 3 A, and 0 V (if the load is electronic).
2. While the DC output is switched off enter MENU, then tap on „Settings“, then on “Page 2” and there on “Calibrate device”.
3. In the next screen select **Voltage calibration**, then **Calibrate output val.** and **NEXT**. The power supply will switch the DC output on, set a certain output voltage and show the measured value as **U-mon**.
4. The next screen requests you to enter the measured output voltage from the multimeter at **Measured value=**. Enter it using the keypad, that appears when tapping the value. Assure yourself the value is correct and submit with **ENTER**.
5. Repeat point 4. for the next three steps (total of four steps).

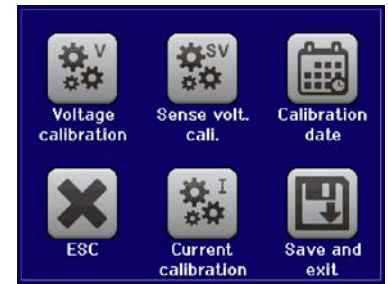

► How to calibrate the current

1. Set the load to approx. 102% nominal current of the PS device. For the sample model with 60 A this would be 61.2 A, rounded to 61 A.
2. While the DC output is switched off enter MENU, then tap on „Settings“, then on “Page 2” and there on “Calibrate device”.
3. In the next screen select **Current calibration**, then **Calibrate output val.** and **NEXT**. The device will switch the DC output on, set a certain current limit while loaded and show the measured output current as **I-mon**.
4. The next screen requests you to enter the output current **Measured value=** measured with the shunt. Enter it using the keypad, assure yourself the value is correct and submit with **ENTER**.
5. Repeat point 4. for the next three steps (total of four steps).

4.3.3.2 Calibrating the remote sensing

In case you are generally using the remote sensing feature, it's recommended to also readjust this parameter for best results. The procedure is identical to the calibration of voltage, except for it requires to have the sensing connector (Sense) on the rear to be plugged and connected with correct polarity to the DC output of the PS.

► How to calibrate the remote sensing voltage

1. Connect a load and set its current to approx. 5% of the nominal current of the power supply, in this example ≈ 3 A, and 0 V (if the load is electronic). Connect the remote sensing input (Sense) to the DC terminal of the load with correct polarity and connect a multimeter there in parallel.
2. While the DC output is switched off enter MENU, then tap on „Settings“, then on “Page 2” and there on “Calibrate device”.
3. In the next screen select **Sense volt. calibration**, then **Calibrate output val.** and **NEXT**. The power supply will switch the DC output on, set a certain output voltage and show the measured value as **U-mon**.
4. The next screen requests you to enter the measured sensing voltage **Measured data=** from the multimeter. Enter it using the keypad, that appears when tapping the value. Assure yourself the value is correct and submit with **ENTER**.
5. Repeat point 4. for the next three steps (total of four steps).

4.3.3.3 Calibrating the actual values

The actual values of output voltage (with and without remote sensing) and output current are calibrated almost the same way as the set values, but here you don't need to enter anything, just confirm the displayed values. Please proceed the above steps and instead of “Calibrate output val.” select “Calibrate actual val.” in the submenu. After the device started showing the measured value on display, wait at least 2 seconds for the value to settle and then tap **NEXT** until you are through all steps.

4.3.3.4 Save and exit

After calibration you may furthermore enter the current date as “calibration date” by tapping



in the selection screen and enter the date in format YYYY / MM / DD.

Last but not least save the calibration data permanently by tapping

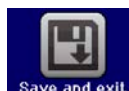

 Leaving the calibration selection menu without tapping “Save and exit” will discard calibration data and the procedure would have to be repeated!

5. Contact and support

5.1 Repairs

Repairs, if not otherwise arranged between supplier and customer, will be carried out by the manufacturer. For this the device must generally be returned to the manufacturer. No RMA number is needed. It's sufficient to package the equipment adequately and send it, together with a detailed description of the fault and, if still under guarantee, a copy of the invoice, to the address below.

5.2 Contact options

Questions or problems with operation of the device, use of optional components, with the documentation or software, can be addressed to technical support either by telephone or e-Mail.

Address	e-Mail	Telephone
EA Elektro-Automatik GmbH Helmholtzstr. 31-37 41747 Viersen Germany	Support: support@elektroautomatik.com All other issues: ea1974@elektroautomatik.com	Switchboard: +49 2162 / 37850 Support: +49 2162 / 378566



Elektro-Automatik

EA Elektro-Automatik GmbH & Co. KG

Development - Production - Sales

Helmholtzstraße 31-37

41747 Viersen

Germany

Fon: +49 2162 37 850

Fax: +49 02162 16 230

ea1974@elektroautomatik.de

www.elektroautomatik.de