

EA-PS 3000 C 160 W - 640 W

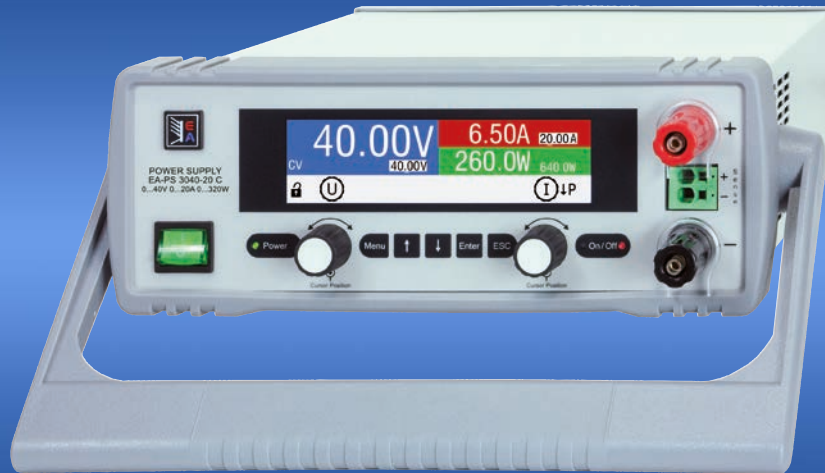

Programmable desktop DC Power supplies



EA-PSI 9080-60 DT

U **I** **P** **OVP** **OCP** **OPP** **OTP**

Option: **USB** **LAN**

- Wide AC supply voltage range: 90...264 V, with active PFC
- Output power ratings: 0...160 W up to 0...640 W
- Output voltages: 0...40 V up to 0...200 V
- Output currents: 0...2 A up to 0...40 A
- Flexible, power regulated output stage
- Various protections (OVP, OCP, OPP, OT)
- Color display for values, status and notifications
- Carrying handle
- Remote sensing
- Optional, galvanically-isolated interfaces
 - USB
 - USB + Analog
 - USB + Ethernet
- SCPI command set and ModBus RTU support
- LabView VI support

General

The new series EA-PS 3000 C offers the user compact desktop power supply devices for a wide-range of applications where it requires small voltages, currents and powers. The small enclosure dimensions, the intuitive control panel with the color display and the frontally-accessible DC output facilitate setup, connection and handling on place.

Besides standard features of power supplies these devices offer some additional functions to simplify handling and to save time. Apart from set value adjustment with knobs, the user can also quickly configure several protection thresholds and call user profiles.

AC supply

The equipment uses an active **Power Factor Correction** (short: PFC), enabling worldwide use on a mains input from 90 V_{AC} up to 264 V_{AC}.

DC output

DC output voltages between 0...40 V and 0...200 V, output currents between 0...2 A and 0...40 A and output power ratings between 0...160 W and 0...640 W are available. Current, voltage and power can thus be adjusted continuously between 0% and 100%, no matter if manually or remotely controlled (analog or digital). The output terminals are located on the front side of the devices.

EA-PS 3000 C 160 W - 640 W

Autoranging power stage

All models are equipped with a flexible autoranging output stage which provides a higher output voltage at lower output current, or a higher output current at lower output voltage, always limited to the max. nominal output power. The maximum power set value is adjustable with these models. Therefore, a wide range of applications can already be covered by the use of just one unit.

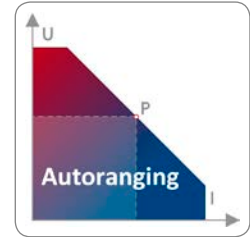

Remote sensing

The standard sensing input can be connected directly to the load in order to compensate voltage drops along the cables. If the sensing input is connected to the load, the power supply will detect this and adjust the output voltage automatically to ensure the accurate required voltage is available at the load.

Protective features

For protection of the equipment connected, it is possible to set an overvoltage protection threshold (OVP), as well as one for overcurrent (OCP) and overpower (OPP). As soon as one of these thresholds is reached for any reason, the DC output will be immediately shut off and a status signal will be generated on the display and via the interfaces. There is furthermore an overtemperature protection, which will shut off the DC output if the device overheats.

Handling (HMI)

Manual operation is done with a color display, two rotary knobs and six pushbuttons. The large display shows all relevant set values and actual values at a glance. The whole setup is also done with the human-machine interface. The display is multilingual (German, English, Russian, Chinese).

Remote control & connectivity

For remote control, there are three types of interface cards optionally available which can be quickly and easily installed by user on location:

- USB
- USB + Ethernet
- USB + Analog

When using the digital interfaces (USB, Ethernet), Windows users can profit from the free software "EA Power Control". It offers a feature called "Sequencing", where the device is controlled through a semi-automatic table in CSV format. This table represents a simple test procedure and can be created and edited in MS Excel or other CSV editors and then be imported into the software tool. This software also allows for the control of up to 20 units at once with an optional feature called "Multi Control" (licensed, not free of charge). See page 110 for more information.

Software and programming

For remote control from a Windows PC there is a software EA Power Control (see page 110) included with the device. It can be used with multiple different or identical models of this series in order to monitor and control the units. The software furthermore includes a feature to record data and to control the units by a semi-automatic table processing.

For even more sophisticated, customer specific applications there is a complete programming documentation and also LabView VIs for direct implementation available.

All models of series EA-PS 3000 C support the common command language SCPI and the ModBus RTU protocol via Ethernet and USB.

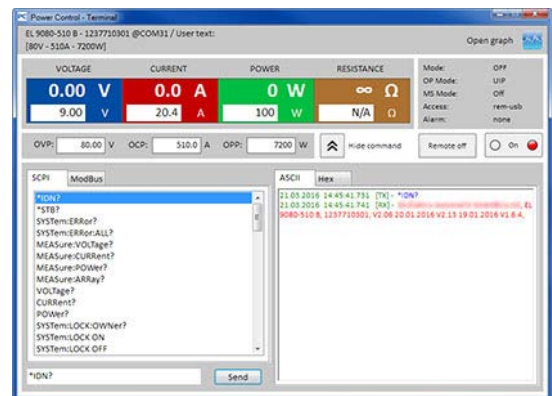

Options

- Interface card (digital or digital/analog), plug 'n play, retrofittable
 - ♦ USB (IF-KE5 USB, ordering nr. 33100232)
 - ♦ USB + Ethernet (IF-KE5 USB/LAN, ordering nr. 33100233)
 - ♦ USB + Analog (IF-KE5 USB/Analog, ordering nr. 33100234)



USB

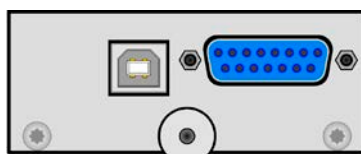

USB+Analog



USB+Ethernet

EA-PS 3000 C 160 W - 640 W

Product views

- A
- B**
- C
- D
- E

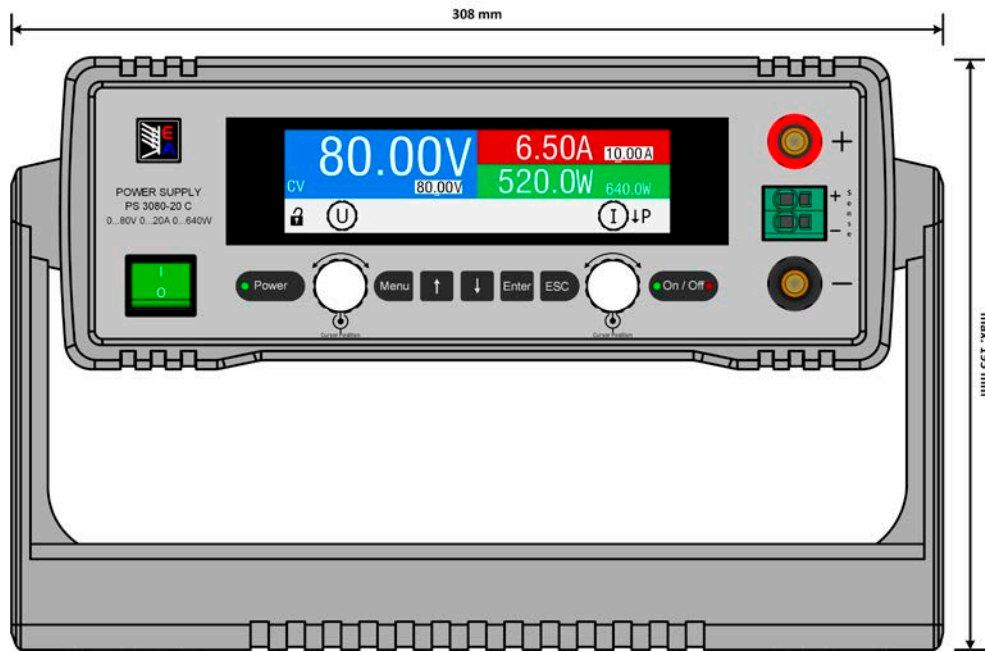

Front view with tilt stand in vertical position

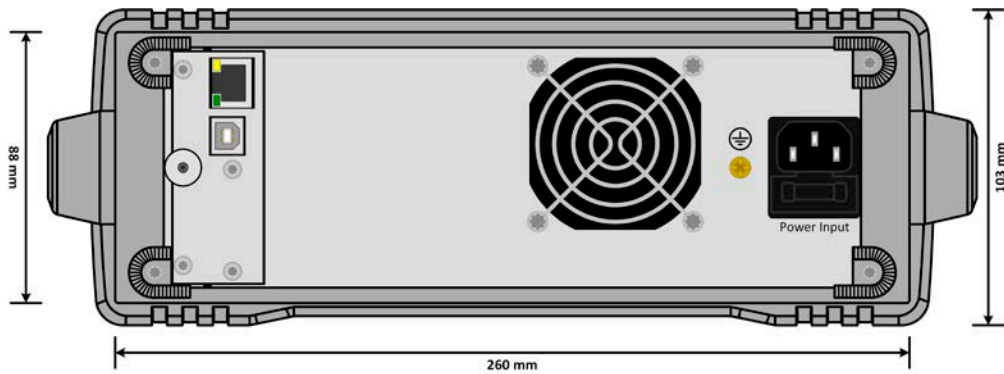

Rear view with installed interface USB + Ethernet (optional)

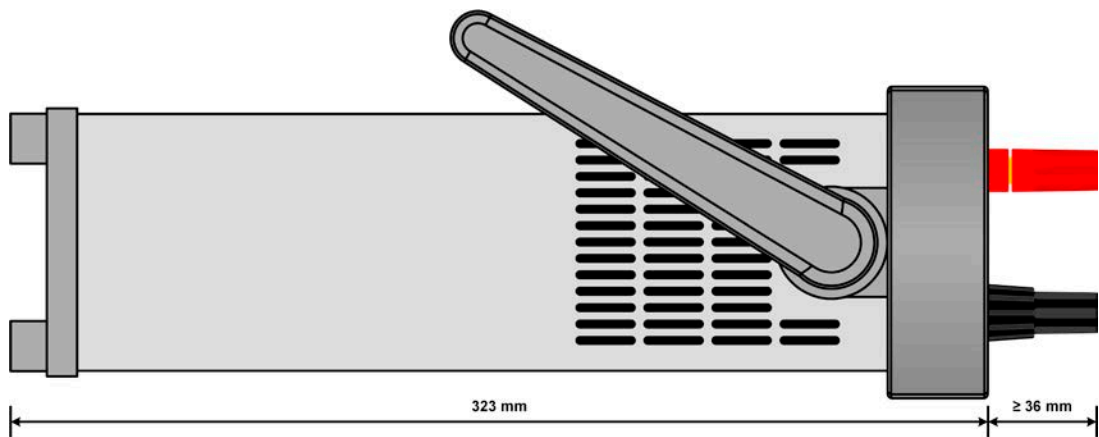

Side view (160/320 W models)

EA-PS 3000 C 160 W - 640 W

Technical Data	Series EA-PS 3000 C
AC: Supply	
- Voltage / Frequency	90...264 V, 45...66 Hz
- Power factor correction (PFC)	>0.99
DC: Voltage	
- Accuracy	<0.1% of rated value
- Load regulation 0-100%	<0.05% of rated value
- Line regulation $\pm 10\% \Delta U_{AC}$	<0.02% of rated value
- Regulation 10-100% load	<2ms
DC: Current	
- Accuracy	<0.2% of rated value
- Load regulation 1-100% ΔU_{DC}	<0.15% of rated value
- Line regulation $\pm 10\% \Delta U_{AC}$	<0.05% of rated value
DC: Power	
- Accuracy	<0.5% of rated value
Protection class	1
Display / control panel	Color display, knobs and pushbuttons
Digital interfaces (optional)	
- Available models	IF-KE5 USB (33100232): 1x USB Typ B IF-KE5 USB/LAN (33100233): 1x USB Typ B + 1x Ethernet (RJ45)
Analog interface (optional)	15 pole D-Sub, galvanically isolated
- Available models	IF-KE5 USB/ANALOG (33100234): 1x Analog + 1x USB Typ B
- Signal range	0...5 V or 0...10 V (switchable)
- Inputs	U, I, P, remote control on-off, DC output on-off
- Outputs	U, I, overvoltage, alarms, reference voltage
- Accuracy U / I / P	0...10 V: <0.2% 0...5 V: <0.4%
Cooling	Temperature-controlled fan
Operation temperature	0...50 °C
Storage temperature	-20...70 °C
Humidity	<80%, non-condensing



Model	Power	Voltage	Current	Ripple ⁽¹⁾	Weight	Dimensions (W x H x D) ⁽²⁾	Ordering number
EA-PS 3040-10 C	0...160 W	0...40 V	0...10 A	30 mV _{pp} / 3 mV _{RMS}	≈4 kg (8.8 lb)	308 mm x 103 mm x 323 mm (12.1" x 4" x 12.7")	35320208
EA-PS 3080-05 C	0...160 W	0...80 V	0...5 A	35 mV _{pp} / 4 mV _{RMS}	≈4 kg (8.8 lb)	308 mm x 103 mm x 323 mm (12.1" x 4" x 12.7")	35320209
EA-PS 3200-02 C	0...160 W	0...200 V	0...2 A	70mV _{pp} / 13mV _{RMS}	≈4 kg (8.8 lb)	308 mm x 103 mm x 323 mm (12.1" x 4" x 12.7")	35320210
EA-PS 3040-20 C	0...320 W	0...40 V	0...20 A	30 mV _{pp} / 3 mV _{RMS}	≈4 kg (8.8 lb)	308 mm x 103 mm x 323 mm (12.1" x 4" x 12.7")	35320211
EA-PS 3080-10 C	0...320 W	0...80 V	0...10 A	35 mV _{pp} / 4 mV _{RMS}	≈4 kg (8.8 lb)	308 mm x 103 mm x 323 mm (12.1" x 4" x 12.7")	35320212
EA-PS 3200-04 C	0...320 W	0...200 V	0...4 A	70mV _{pp} / 13mV _{RMS}	≈4 kg (8.8 lb)	308 mm x 103 mm x 323 mm (12.1" x 4" x 12.7")	35320213
EA-PS 3040-40 C	0...640 W	0...40 V	0...40 A	25 mV _{pp} / 4 mV _{RMS}	≈5 kg (11 lb)	308 mm x 103 mm x 350 mm (12.1" x 4" x 13.8")	35320214
EA-PS 3080-20 C	0...640 W	0...80 V	0...20 A	40 mV _{pp} / 6 mV _{RMS}	≈5 kg (11 lb)	308 mm x 103 mm x 350 mm (12.1" x 4" x 13.8")	35320215
EA-PS 3200-10 C	0...640 W	0...200 V	0...10 A	100mV _{pp} / 25mV _{RMS}	≈5 kg (11 lb)	308 mm x 103 mm x 350 mm (12.1" x 4" x 13.8")	35320216

(1) RMS value: measures at LF with BWL 300 kHz, PP value: measured at HF with BWL 20MHz

(2) Enclosure only, not over all (see depictions)