

Chroma

Programmable AC Source
61601/61602/61603/61604
User's Manual

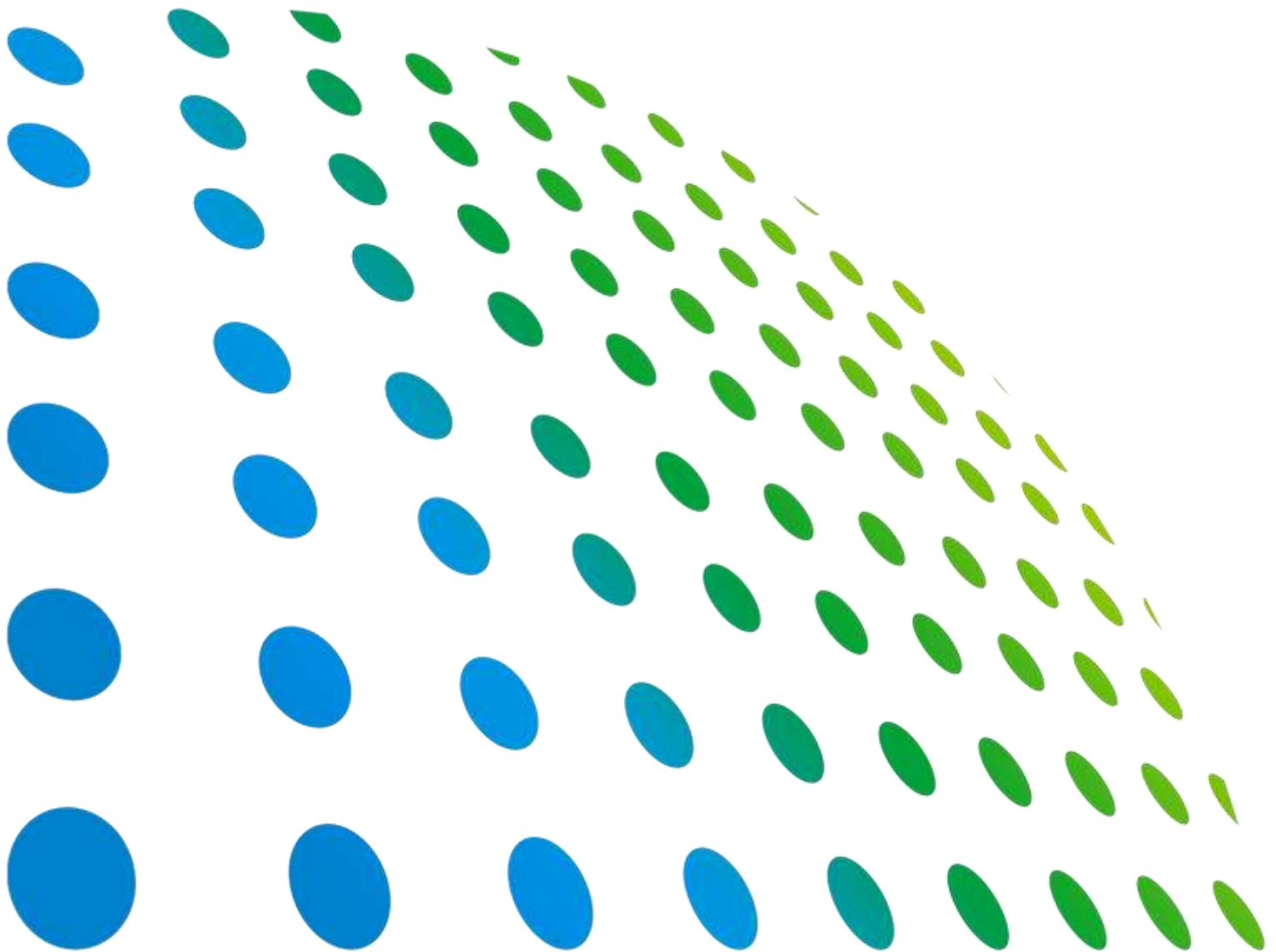

Get more product & global distributor information in the Chroma ATE APP



Programmable AC Source 61601/61602/61603/61604 User's Manual



Version 2.2
March 2021

Legal Notices

The information in this document is subject to change without notice.

Chroma ATE INC. makes no warranty of any kind with regard to this manual, including, but not limited to, the implied warranties of merchantability and fitness for a particular purpose. Chroma ATE INC. shall not be held liable for errors contained herein or direct, indirect, special, incidental or consequential damages in connection with the furnishing, performance, or use of this material.

CHROMA ATE INC.

88 Wenmao Rd., Guishan Dist., Taoyuan City 333001, Taiwan

Copyright Notices. Copyright 2002 Chroma ATE INC., all rights reserved. Reproduction, adaptation, or translation of this document without prior written permission is prohibited, except as allowed under the copyright laws.

Warranty

All of Chroma's instruments are warranted against defects in material and workmanship for a period of one year from date of shipment. Chroma agrees to repair or replace any assembly or component found to be defective, under normal use during this period. Chroma's obligation under this warranty is limited solely to repairing any such instrument, which in Chroma's sole opinion proves to be defective within the scope of the warranty when returned to the factory or to an authorized service center. Purchaser is responsible for the shipping and cost of the service item to Chroma factory or service center. Shipment should not be made without prior authorization by Chroma.

This warranty does not apply to any products repaired or altered by persons not authorized by Chroma, or not in accordance with instructions furnished by Chroma. If the instrument is defective as a result of misuse, improper repair, or abnormal conditions or operations, repairs will be billed at cost.

Chroma assumes no responsibility for its product being used in a hazardous or dangerous manner either alone or in conjunction with other equipment. High voltage used in some instruments may be dangerous if misused. Special disclaimers apply to these instruments. Chroma assumes no liability for secondary charges or consequential damages and in any event, Chroma's liability for breach of warranty under any contract or otherwise, shall not exceed the purchase price of the specific instrument shipped and against which a claim is made.

Any recommendations made by Chroma for use of its products are based upon tests believed to be reliable, but Chroma makes no warranty of the results to be obtained. This warranty is in lieu of all other warranties, expressed or implied, and no representative or person is authorized to represent or assume for Chroma any liability in connection with the sale of our products other than set forth herein.

CHROMA ATE INC.

88 Wenmao Rd., Guishan Dist.,
Taoyuan City 333001, Taiwan
Tel: 886-3-327-9999
Fax: 886-3-327-8898
e-mail: info@chromaate.com

www.chromaate.com

Material Contents Declaration

The recycling label shown on the product indicates the Hazardous Substances contained in the product as the table listed below.

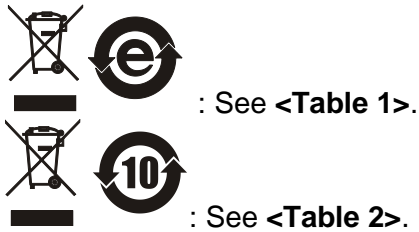

<Table 1>

Part Name	Hazardous Substances					
	Lead	Mercury	Cadmium	Hexavalent Chromium	Polybrominated Biphenyls/ Polybromodiphenyl Ethers	Selected Phthalates Group
	Pb	Hg	Cd	Cr ⁶⁺	PBB/PBDE	DEHP/BBP/DBP/DIBP
PCBA	O	O	O	O	O	O
CHASSIS	O	O	O	O	O	O
ACCESSORY	O	O	O	O	O	O
PACKAGE	O	O	O	O	O	O

“O” indicates that the level of the specified chemical substance is less than the threshold level specified in the standards of SJ/T-11363-2006, EU Directive 2011/65/EU, and 2015/863/EU.

“X” indicates that the level of the specified chemical substance exceeds the threshold level specified in the standards of SJ/T-11363-2006, EU Directive 2011/65/EU, and 2015/863/EU.

Remarks:

1. The CE marking on product is a declaration of product compliance with EU Directive 2011/65/EU and 2015/863/EU.
2. This product is complied with EU REACH regulation and no SVHC in use.

Disposal

Do not dispose of electrical appliances as unsorted municipal waste, use separate collection facilities. Contact your local government for information regarding the collection systems available. If electrical appliances are disposed of in landfills or dumps, hazardous substances can leak into the groundwater and get into the food chain, damaging your health and well-being. When replacing old appliances with new one, the retailer is legally obligated to take back your old appliances for disposal at least for free of charge.



<Table 2>

Part Name	Hazardous Substances					
	Lead	Mercury	Cadmium	Hexavalent Chromium	Polybrominated Biphenyls/ Polybromodiphenyl Ethers	Selected Phthalates Group
	Pb	Hg	Cd	Cr ⁶⁺	PBB/PBDE	DEHP/BBP/DBP/DIBP
PCBA	×	○	○	○	○	○
CHASSIS	×	○	○	○	○	○
ACCESSORY	×	○	○	○	○	○
PACKAGE	○	○	○	○	○	○

“○” indicates that the level of the specified chemical substance is less than the threshold level specified in the standards of SJ/T-11363-2006, EU Directive 2011/65/EU, and 2015/863/EU.

“×” indicates that the level of the specified chemical substance exceeds the threshold level specified in the standards of SJ/T-11363-2006, EU Directive 2011/65/EU, and 2015/863/EU.

1. Chroma is not fully transitioned to lead-free solder assembly at this moment; however, most of the components used are RoHS compliant.
2. The environment-friendly usage period of the product is assumed under the operating environment specified in each product’s specification.
3. This product is complied with EU REACH regulation and no SVHC in use.

Disposal

Do not dispose of electrical appliances as unsorted municipal waste, use separate collection facilities. Contact your local government for information regarding the collection systems available. If electrical appliances are disposed of in landfills or dumps, hazardous substances can leak into the groundwater and get into the food chain, damaging your health and well-being. When replacing old appliances with new one, the retailer is legally obligated to take back your old appliances for disposal at least for free of charge.





Declaration of Conformity

For the following equipment :

Programmable AC Source

(Product Name/ Trade Name)

61501, 61502, 61503, 61504, 61505, 61601, 61602, 61603, 61604, 61605

(Model Designation)

CHROMA ATE INC.

(Manufacturer Name)

88 Wenmao Rd., Guishan Dist., Taoyuan City 333001, Taiwan

(Manufacturer Address)

Is herewith confirmed to comply with the requirements set out in the Council Directive on the Approximation of the Laws of the Member States relating to Electromagnetic Compatibility (2014/30/EU) and Low Voltage Directive (2014/35/EU). For the evaluation regarding the Directives, the following standards were applied :

EN 61326-1:2013 Class A

EN 61000-3-2:2014, EN 61000-3-3:2013

EN 61326-1:2013(industrial locations)

EN 61000-4-2:2009, EN 61000-4-3:2006+A1:2008+A2:2010, EN 61000-4-4:2012,

EN 61000-4-5:2006, EN 61000-4-6:2014, EN 61000-4-8:2010, EN 61000-4-11:2004

IEC/EN 61010-1:2010

The equipment describe above is in conformity with Directive 2011/65/EU and 2015/863/EU of the European Parliament and of the Council on the restriction of the use of certain hazardous substances in electrical and electronic equipment.

The following importer/manufacturer or authorized representative established within the EUT is responsible for this declaration :

CHROMA ATE INC.

(Company Name)

88 Wenmao Rd., Guishan Dist., Taoyuan City 333001, Taiwan

(Company Address)

Person responsible for this declaration:

Mr. Vincent Wu

(Name, Surname)

T&M BU Vice President

(Position/Title)

Taiwan

(Place)

2020.12.23

(Date)

(Legal Signature)

Safety Summary

The following general safety precautions must be observed during all phases of operation, service, and repair of this instrument. Failure to comply with these precautions or specific WARNINGS given elsewhere in this manual will violate safety standards of design, manufacture, and intended use of the instrument. *Chroma* assumes no liability for the customer's failure to comply with these requirements.



BEFORE APPLYING POWER

Verify that the power is set to match the rated input of this power supply.



PROTECTIVE GROUNDING

Make sure to connect the protective grounding to prevent an electric shock before turning on the power.

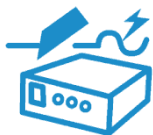

NECESSITY OF PROTECTIVE GROUNDING

Never cut off the internal or external protective grounding wire, or disconnect the wiring of protective grounding terminal. Doing so will cause a potential shock hazard that may bring injury to a person.



FUSES

Only fuses with the required rated current, voltage, and specified type (normal blow, time delay, etc.) should be used. Do not use repaired fuses or short-circuited fuse holders. To do so could cause a shock or fire hazard.



DO NOT OPERATE IN AN EXPLOSIVE ATMOSPHERE

Do not operate the instrument in the presence of flammable gases or fumes. The instrument should be used in an environment of good ventilation.















DO NOT REMOVE THE COVER OF THE INSTRUMENT

Operating personnel must not remove the cover of the instrument. Component replacement and internal adjustment can be done only by qualified service personnel.

⚠ WARNING

1. Lethal voltage. AC source may output 426 V peak voltage.
2. Touching the connected circuit or output terminal on the front or rear panel when power is on may result in death.

Safety Symbols

	DANGER – High voltage.
	Explanation: To avoid injury, death of personnel, or damage to the instrument, the operator must refer to an explanation in the instruction manual.
	High temperature: This symbol indicates the temperature is now higher than the acceptable range of human. Do not touch it to avoid any personal injury.
	Protective grounding terminal: To protect against electrical shock in case of a fault. This symbol indicates that the terminal must be connected to ground before operation of equipment.
	Functional grounding: To identify an earth (ground) terminal in cases where the protective ground is not explicitly stated. This symbol indicates the power connector does not provide grounding.
	Frame or chassis: To identify a frame or chassis terminal.
	Alternating Current (AC)
	Direct Current (DC) / Alternating Current (AC)
	Direct Current (DC)
	Push-on/Push-off power switch
	The WARNING sign denotes a hazard. It calls attention to a procedure, practice, or the like, which, if not correctly performed or adhered to, could result in personal injury. Do not proceed beyond a WARNING sign until the indicated conditions are fully understood and met.
	The CAUTION sign denotes a hazard. It may result in personal injury or death if not noticed timely. It calls attention to procedures, practices and conditions.
	The Notice sign denotes important information in procedures, applications or the areas that require special attention. Be sure to read it carefully.

ACOUSTIC NOISE INFORMATION

This product has a sound pressure emission (at the operator's side) < 65dB(A).

Protection Plates

In order to protect the terminals of the Chroma 61500/61600 AC power source from damage during shift or transportation, users can choose to install the enclosed rear panel protection plates (2 pieces) as an option.

Installation Instruction:

1. Remove the 4 screws from both sides of the rear panel (Figure 1).
2. Mount the protection plates with the screws included in the bag (Figure 2).

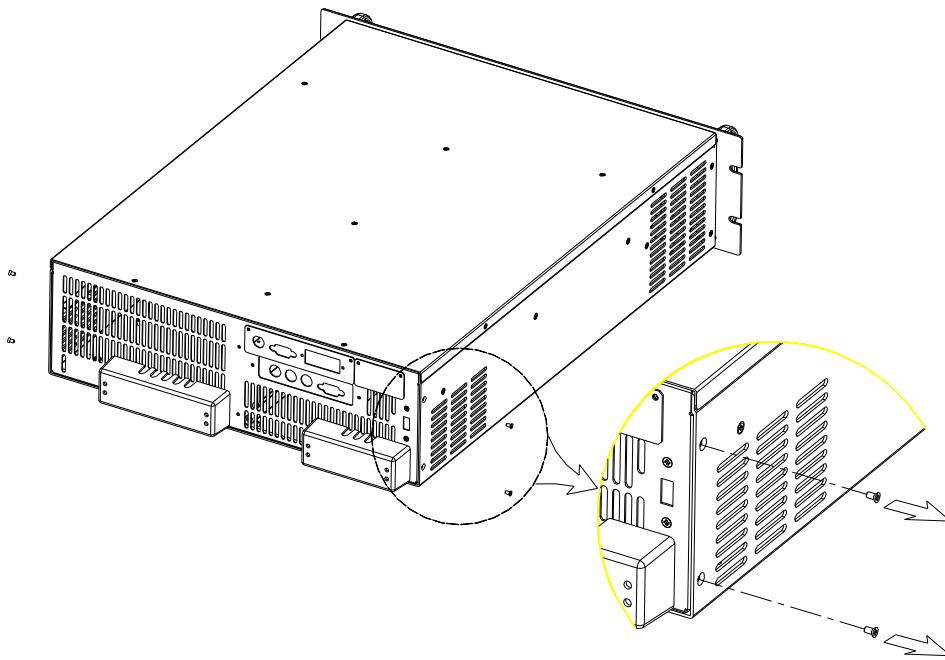

Figure 1

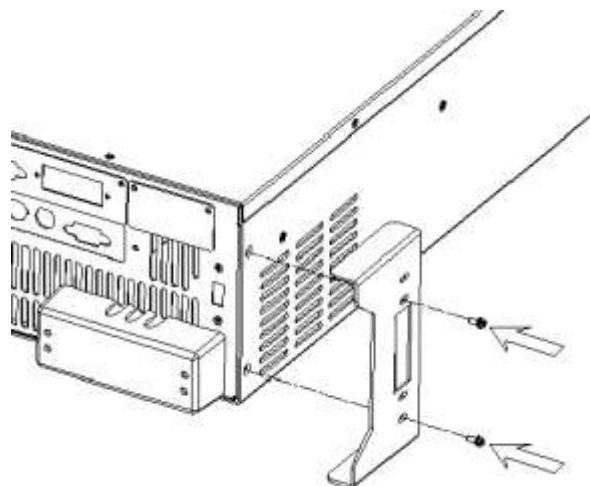

Figure 2

Revision History

The following lists the additions, deletions and modifications in this manual at each revision.

Date	Version	Revised Sections
Jan. 2002	1.0	Complete this manual
Jan. 2004	1.1	Modify "The Rear Panel" "DATA LOCK" "COUPLE Mode of Output (AC+DC, AC, DC)" "THREE PHASE MODE" "PARALLEL MODE" "The GPIB Capability of the AC Source"
May 2005	1.2	Change the address and phone no. of Chroma
Aug. 2005	1.3	Modify "The Rear Panel" "Input Connection" "Remote Sense Connection" "COUPLE Mode of Output (AC+DC, AC, DC)" "THREE PHASE MODE" "PARALLEL MODE"
Oct. 2007	1.4	Add the following: – "Material Contents Declaration". – "Protection Plates" – "HIGH VOLTAGE OPTION". – the description of "NOTICE" in the section of "OUTPUT RELAY". Modify the following sections: – the Figure 3-1 in the section of "Operation through Keypad and RPG". – "the definition of letters" in the section of "MAIN PAGE (Output Setting and Measurement)". – the content and notice in the section of "RANGE". – "CALIBRATION CHOICE PAGE" in the section of "MANUAL CALI Functional List".
Mar. 2008	1.5	Add the following – the description in the section of "Slew Rate of Output Transient". – Notice in the section of "HIGH VOLTAGE OPTION". – the description in the section of "Appendix A: Pin Assignment of TTL Signal". Modify the following sections: – the Figure 3-1 in the section of "Operation through Keypad and RPG". – the pages in the section of "OUTPUT Functional List".
Feb. 2010	1.6	Modify the content of "CE Declaration".
Jun. 2013	1.7	Modify the content of "CE Declaration" Delete "parallel connectivity remark" from description of rear panel (item 6) Delete the Parallel Mode section (3.7.6) and remove the Parallel Mode from figure 3.1 Add warning message for PV inverter test application under the protection chapter (3.9)
Oct. 2013	1.8	Add a Notice in the section of "HIGH VOLTAGE OPTION"
Oct. 2015	1.9	Add the following sections:

		<ul style="list-style-type: none"> - “Rear Panel (with USB and Ethernet)” in the chapter of “General Information” - “USB and Ethernet Setting” in the chapter of “Local Operation”
		<p>Modify the following sections:</p> <ul style="list-style-type: none"> - “I/O Connectors (Option)” in the chapter of “Installation” - “CONF Functional List” in the chapter of “Local Operation”
Jul. 2016	2.0	<p>Modify the following sections:</p> <ul style="list-style-type: none"> - “CE Declaration of Conformity”. - the description in the chapter of “Remote Operation”.
May 2017	2.1	<p>Modify the following:</p> <ul style="list-style-type: none"> - “Material Contents Declaration”. - “CE Declaration of Conformity”. - Figure 1-1 Front Panel in the section of “Names of Parts”. - Fixture connection figure in the section of “COUPLE Mode of Output (AC+DC, AC, DC)”.
Mar. 2021	2.2	<p>Add “User Manual Customer Feedback”.</p> <p>Update address.</p>

Table of Contents

1.	General Information	1-1
1.1	Introduction.....	1-1
1.2	Key Features.....	1-1
1.3	Specifications.....	1-1
1.4	Names of Parts.....	1-3
1.4.1	Front Panel.....	1-3
1.4.2	Rear Panel (with GPIB).....	1-5
1.4.3	Rear Panel (with USB and Ethernet).....	1-6
2.	Installation	2-1
2.1	Inspection.....	2-1
2.2	Preparation for Use.....	2-1
2.3	Requirements of Input Power.....	2-1
2.3.1	Ratings.....	2-1
2.3.2	Input Connection.....	2-1
2.4	Output Connection.....	2-3
2.5	Remote Sense Connection.....	2-3
2.6	Power-on Procedure.....	2-4
2.7	I/O Connectors (Option).....	2-5
3.	Local Operation	3-1
3.1	Introduction.....	3-1
3.2	Operation through Keypad and RPG.....	3-1
3.3	MAIN PAGE (Output Setting & Measurement).....	3-3
3.4	CHOICE PAGE (Functional List Choice).....	3-4
3.5	SETUP Functional List.....	3-4
3.5.1	RANGE.....	3-5
3.5.2	Vac LIMIT.....	3-5
3.5.3	Vdc LIMIT (+), Vdc LIMIT (-).....	3-6
3.5.4	I LIMIT, DELAY.....	3-6
3.5.5	OUTPUT RELAY.....	3-7
3.5.6	BUZZER.....	3-7
3.5.7	DATALOCK.....	3-8
3.5.8	Is START, Is INTERVAL.....	3-8
3.6	CONF Functional List.....	3-9
3.6.1	REMOTE INHIBIT.....	3-10
3.6.2	EXT. V, COUPLE.....	3-10
3.6.3	POWER ON STATUS.....	3-12
3.6.4	GPIB Address, RS-232C (with GPIB).....	3-12
3.6.5	USB and Ethernet Setting.....	3-13
3.7	OUTPUT Functional List.....	3-14
3.7.1	COUPLE Mode of Output (AC+DC, AC, DC).....	3-15

3.7.2	OUTPUT DEGREE.....	3-16
3.7.3	Slew Rate of Output Transient.....	3-17
3.7.4	HIGH VOLTAGE OPTION.....	3-18
3.7.5	THREE PHASE MODE	3-18
3.8	Save and Recall.....	3-21
3.8.1	Save and Recall Output Setting.....	3-21
3.8.2	Save and Recall System Data	3-23
3.9	Protection.....	3-25
4.	Calibration.....	4-1
4.1	Introduction	4-1
4.2	MANUAL CALI Functional List	4-1
4.2.1	Output Voltage & Voltage Measurement Calibration.....	4-2
4.2.2	Current Measurement Calibration.....	4-5
4.2.3	External Vref Calibration.....	4-6
5.	Theory of Operation.....	5-1
5.1	General.....	5-1
5.2	Description of Overall System	5-1
6.	Self Test & Troubleshooting	6-1
6.1	General.....	6-1
6.2	Self-test	6-1
6.3	Troubleshooting	6-2
7.	Remote Operation.....	7-1
7.1	General Information	7-1
7.1.1	Setting the GPIB Address & RS-232C Parameters.....	7-1
7.1.2	Wire Connection of RS-232C	7-1
7.2	The GPIB Capability of the AC Source.....	7-2
7.3	Introduction to Programming.....	7-3
7.3.1	Conventions	7-3
7.3.2	Numerical Data Formats.....	7-3
7.3.3	Boolean Data Format	7-3
7.3.4	Character Data Format.....	7-3
7.3.5	Basic Definition.....	7-4
7.4	Traversal of the Command Tree	7-5
7.5	Execution Order.....	7-5
7.6	The Commands of the AC Source	7-6
7.6.1	Common Command Dictionary.....	7-6
7.6.2	Instrument Command Dictionary	7-7
7.7	Command Summary	7-17
Appendix A	Pin Assignment of TTL Signal.....	A-1

1. General Information

1.1 Introduction

The series of Chroma AC source 61601/61602/61603/61604 are high efficiency AC source which provide sine wave output with low distortion, and accurate measurement of power. The DSP microprocessor generates accurate, stable output voltage and frequency. The PWM design of power stage allows for full volt-ampere into loads. The front panel has both RPG (rotary pulse generator) and keypad controls for setting the output voltage and frequency. The LCD provides a complete operating state of the unit to the user. Remote programming is accomplished either through the GPIB bus or the RS-232C serial port.

1.2 Key Features

A. Configuration

- Local operation from the keypad on the front panel.
- Remote operation via GPIB or RS-232C interface.
- Protection against Over-power, Over-Current, Over-temperature, Fan-fail.
- Temperature-controlled fan speed.
- Built-in output isolation relays.

B. Input/Output

- Selective output voltage with full scale of 150V/300V/Auto.
- Remote control by the use of analog voltage reference.
- Universal of input voltage range 90Vac ~ 250Vac.
- Measurement of V, I, P, CF and PF.
- Remotely inhibited control.
- AC ON/OFF output signal.

1.3 Specifications

The operation specifications of the model 61601/61602/61603/61604 are listed below (on the next page). All specifications have been tested according to the standard Chroma test procedures. All specifications are based on a remote sense connection, $25 \pm 1^\circ\text{C}$, and resistor load unless specified otherwise.

Model	61601	61602	61603	61604
AC OUTPUT RATING				
Max. power	500 VA	1K VA	1.5K VA	2K VA
Voltage				
Range	150V / 300V / Auto			
Accuracy	0.2%+0.2%F.S.	0.2%+0.2%F.S.	0.2%+0.2%F.S.	0.2%+0.2%F.S.
Resolution	0.1 V	0.1 V	0.1 V	0.1 V
Distortion	0.3% @50/60Hz 1% 15- 1K Hz	0.3% @50/60Hz 1% 15- 1K Hz	0.3% @50/60Hz 1% 15- 1K Hz	0.3% @50/60Hz 1% 15- 1K Hz
Line regulation	0.1%	0.1%	0.1%	0.1%
Load regulation	0.2%	0.2%	0.2%	0.2%
Temp. coefficient	0.02% per degree from 25°C			
Maximum current				
r.m.s.	4A / 2A	8A / 4A	12A / 6A	16A / 8A
peak	24A / 12A	48A / 24A	72A / 36A	96A / 48A
Frequency				
Range	DC, 15-1K Hz	DC, 15-1K Hz	DC, 15-1K Hz	DC, 15-1K Hz
Accuracy	0.15%	0.15%	0.15%	0.15%
DC OUTPUT RATING				
Power	250W	500W	750W	1K W
Voltage	212V / 424V	212V / 424V	212V / 424V	212V / 424V
Current	2A / 1A	4A / 2A	6A / 3A	8A / 4A
INPUT RATING				
Voltage range	1Φ100 – 240V ±10%V _{LN}	1Φ100 – 240V ±10%V _{LN}	1Φ100 – 240V ±10%V _{LN}	1Φ100 – 240V ±10%V _{LN}
Frequency range	47-63 Hz	47-63 Hz	47-63 Hz	47-63 Hz
Current	8A Max.	16A Max.	21A Max.	28A Max.
Power factor	0.97 Min.	0.98 Min.	0.98 Min.	0.98 Min.
MEASUREMENT				
Voltage				
Range	150V / 300V	150V / 300V	150V / 300V	150V / 300V
Accuracy	0.2%+0.2%F.S.	0.2%+0.2%F.S.	0.2%+0.2%F.S.	0.2%+0.2%F.S.
Resolution	0.1 V	0.1 V	0.1 V	0.1 V
Current				
Range (peak)	24A	48A	72A	96A
Accuracy (r.m.s.)	0.4%+0.3%F.S.	0.4%+0.3%F.S.	0.4%+0.3%F.S.	0.4%+0.3%F.S.
Accuracy (peak)	0.4%+0.6%F.S.	0.4%+0.6%F.S.	0.4%+0.6%F.S.	0.4%+0.6%F.S.
Resolution	0.01 A	0.01 A	0.01 A	0.01 A
Power				
Accuracy	0.4%+0.4% F.S.	0.4%+0.4% F.S.	0.4%+0.4% F.S.	0.4%+0.4% F.S.
Resolution	0.1 W	0.1 W	0.1 W	0.1 W
OTHERS				
Efficiency	68 %	77 %	78 %	80 %
Size (W×H×D)	483 mm x 134 mm x 610 mm			
Weight	20 Kg	20 Kg	21 Kg	21 Kg
Protection	UVP, OCP, OPP, OTP, FAN			
Temperature Range				
Operation	0 °C to 40 °C			
Storage	-40 °C to 85 °C			
Humidity	30 % to 90 %			
Safety & EMC	FCC 15J class A, CE			

Note : *1: Maximum distortion is tested on output 125VAC (150V RANGE) and

- 250VAC (300V RANGE) with maximum current to linear load.
- *2: Load regulation is tested with sinewave and remote sense.
- *3: Efficiency is tested on input voltage 110V.

1.4 Names of Parts

1.4.1 Front Panel

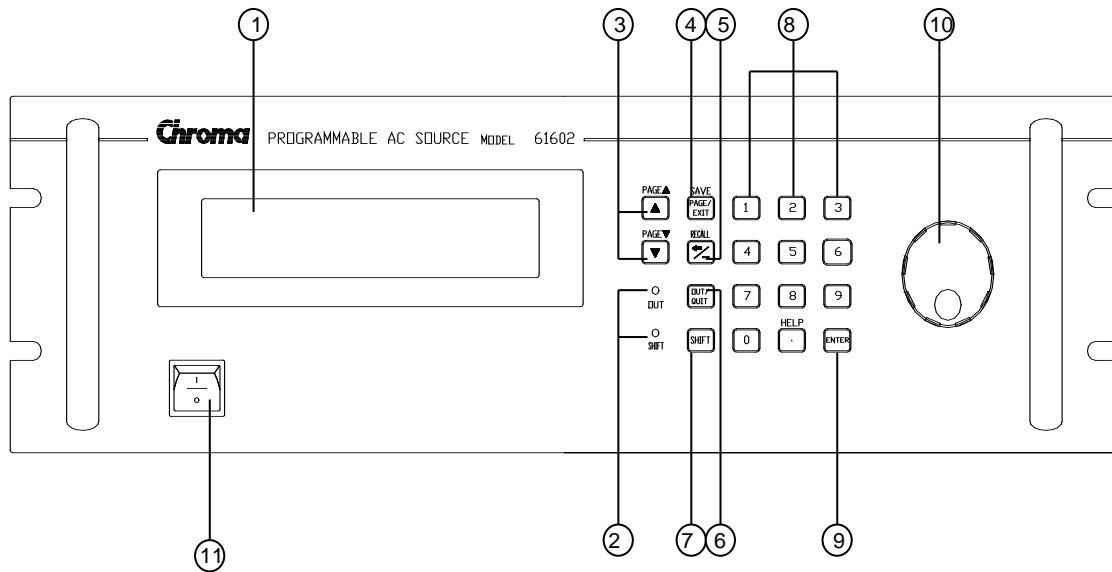





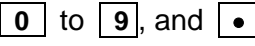





Figure 1-1 Front Panel

Table 1-1 Description of the Front Panel

Item	Symbol	Description
1		Display: The LCD is to display configuration, output setup, and measurement results.
2		Indicator LED: "OUT" and "SHIFT", for showing activation of output and shift mode, are available which are located on the keypad area next to the corresponding keys.
3	  -----or----- PAGE ▲ PAGE ▼	Cursor moving keys: These two keys are to move the cursor to different directions respectively. In normal mode, pressing any of these two keys will change the place of the cursor. Under shift mode, these keys enable the LCD display to change to last page or next page if there are ▲ or ▼ patterns in right-down side of display.
4	 -----or----- SAVE	PAGE or EXIT command key: Pressing this key will make the LCD display switching between MAIN PAGE and CHOICE PAGE. Or change to CHOICE PAGE in each functional list. Under shift mode, pressing this key on MAIN PAGE, the uses can save the output setting (see 3.8.1). If pressing the key on CHOICE PAGE, the user can save system data (see 3.8.2).

5	 -----or----- RECALL	Backspace and Minus command key: Pressing this key will erase the keyin number. Or it may show " - ", if no number is in front of cursor. Under shift mode, pressing the key on MAIN PAGE, the user can recall the output setting (see 3.8.1). If pressing the key on CHOICE PAGE, the user can recall system data (see 3.8.2).
6		OUT/QUIT command key: Pressing this key may enable the ac source output voltage or quit the output voltage.
7		Shift mode selection key: Pressing this key will switch the ac source from normal operational mode to the shift mode.
8	 -----or----- HELP	Numeric and decimal keys: The user can program numeric data by pressing the digital keys and the decimal key. Under shift mode, pressing  acts the HELP function. The LCD display will show more information about cursor locating place.
9		 key: It is to confirm the setting of parameters.
10		RPG: The user can input programming data or options by turning the RPG to the desired ones.
11		Main power switch: It is to power on or off.

1.4.2 Rear Panel (with GPIB)

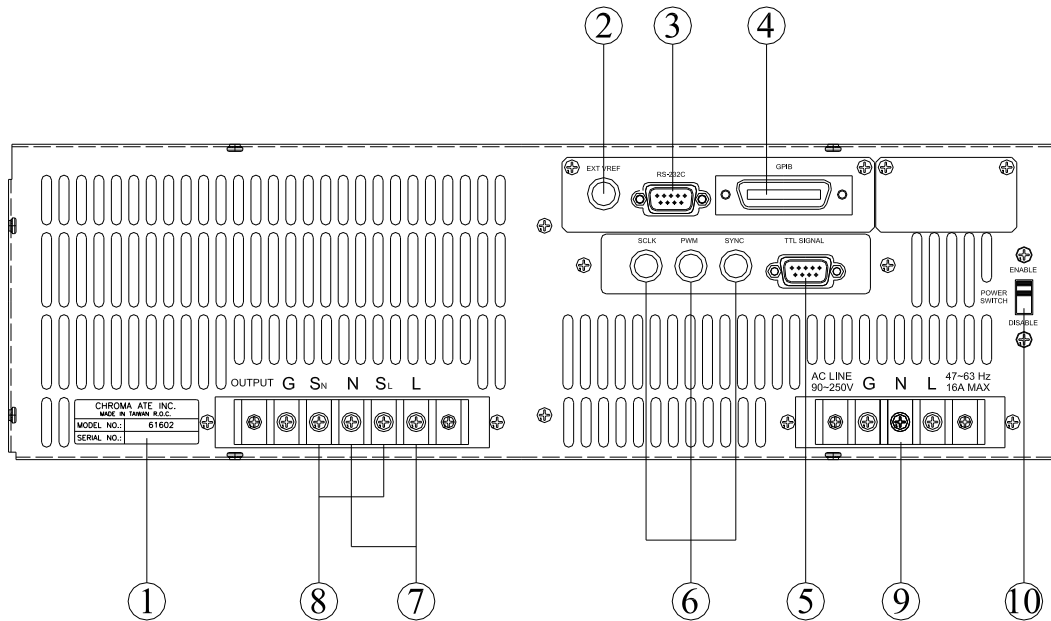

Figure 1-2 Rear Panel

Table 1-2 Description of the Rear Panel

Item	Name	Description
1	Label	The label includes model number, series number of the AC source.
2	Ext. Ref.	The BNC connector inputs control waveform amplitude from external analog signal.
3	RS-232C	The 9-pin, D-type female connector transfers control commands to and from the remote PC for remote operation.
4	GPIB Connector	A remote controller using GPIB bus is connected to the AC source through this connector for remote operation.
5	TTL SIGNAL	The 9-pin, female connector transfers control signals (fault_out, remote inhibit, and AC_ON).
6	SCLK, PWM, SYNC	SYNC transfers a pulse signal synchronously when output changes. It also sends synchronizing signal for 3-phase mode operation.
7	Output Connector	This connector outputs power to the loading device.
8	Remote Sense Connector	It senses directly at the terminals of the load to eliminate any voltage drop on the connecting cable. Make sure of connecting the terminal "SL" of the remote sense connector to the terminal "L" of the load, and the "SN" to the "N" of the load. Reverse polarity is not allowed.
9	Power Line in Connector	Power line input is connected to the AC source through this connector.
10	Power Switch	It enables or disables the main power switch. Users can power on or off with the main power switch when the power switch is set to "ENABLE". Conversely the main power switch is inactive when the power switch is set to "DISABLE".

1.4.3 Rear Panel (with USB and Ethernet)

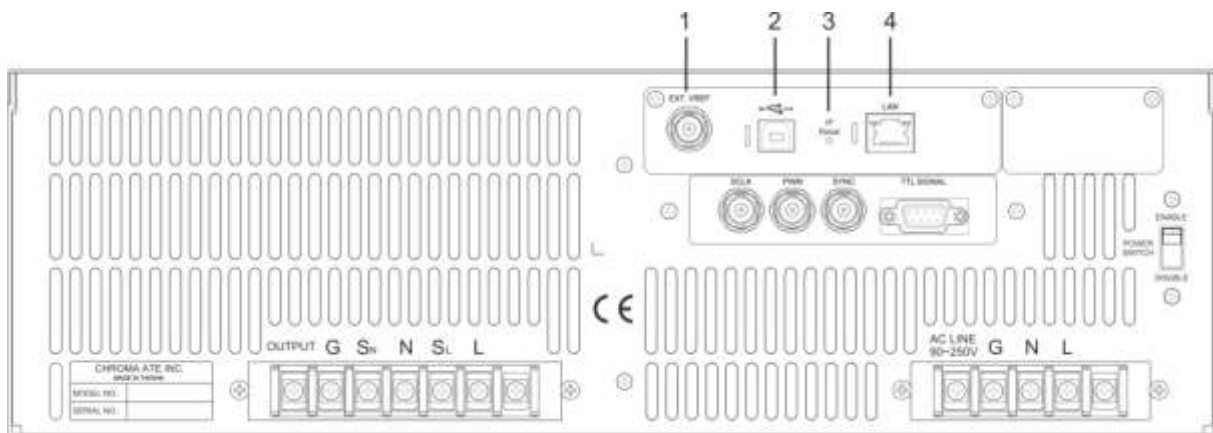

Figure 1-3 Rear Panel (With USB & Ethernet)

Table 1-3 Description of the Rear Panel

Item	Name	Description
1	Ext. Ref.	A BNC connector to control waveform amplitude via external analog (simulated).
2	USB	Connecting AC source and PC for communication.
3	IP Reset	Reset the IP address.
4	LAN	Connecting AC source and PC for network communication.

2. Installation

2.1 Inspection

After unpacking the instrument, please inspect any damage that may have occurred during the shipment. Save all packing materials in case the instrument has to be returned one day. If any damage is found, please file a claim with the carrier immediately. Do not return the instrument to the factory without obtaining the prior RMA acceptance from Chroma.

2.2 Preparation for Use

In the beginning, the instrument must be connected with an appropriate AC line input. Then, since it is intelligently cooled by fans, it must be installed in sufficient space for circulation of air. It should be used in an area where the ambient temperature does not exceed 40°C.

2.3 Requirements of Input Power

2.3.1 Ratings

Input Voltage Range	:	1 Φ 100 – 240V \pm 10%V _{LN}
Input Frequency	:	47-63 Hz
Max. Current	:	61601: 8 A 61602: 16 A 61603: 21 A 61604: 28 A

 **CAUTION** : The AC source will be damaged if it is operated at an input voltage that is outside its configured input range.

2.3.2 Input Connection

The input terminal block is located on the rear panel of the instrument. The power cord must be a three-conductor cord rated at least for 85°C. The power line input must have a current rating which is greater than or equal to the maximum current rating of the AC source. Do not use three separate wires to connect power to the input of the AC source.

See Figure 2-1 and do the following things one by one:

1. Remove the safety cover from the back of the AC source.
2. Screw the power cord to the terminal blocks of the AC source as follows:
Green or green/yellow wire to the terminal labeled "G".
White or blue wire to the terminal labeled "N".
Black or brown wire to the terminal labeled "L".
3. Slip the safety cover over the ac input terminal strip, and secure the cover with two screws.

⚠ WARNING To protect the operators, the wire connected to the GND terminal must be connected to the earth ground. Under no circumstances shall this AC source be operated without an adequate ground connection.

Installation of the power cord must be done by a professional and in accordance with local electrical codes.

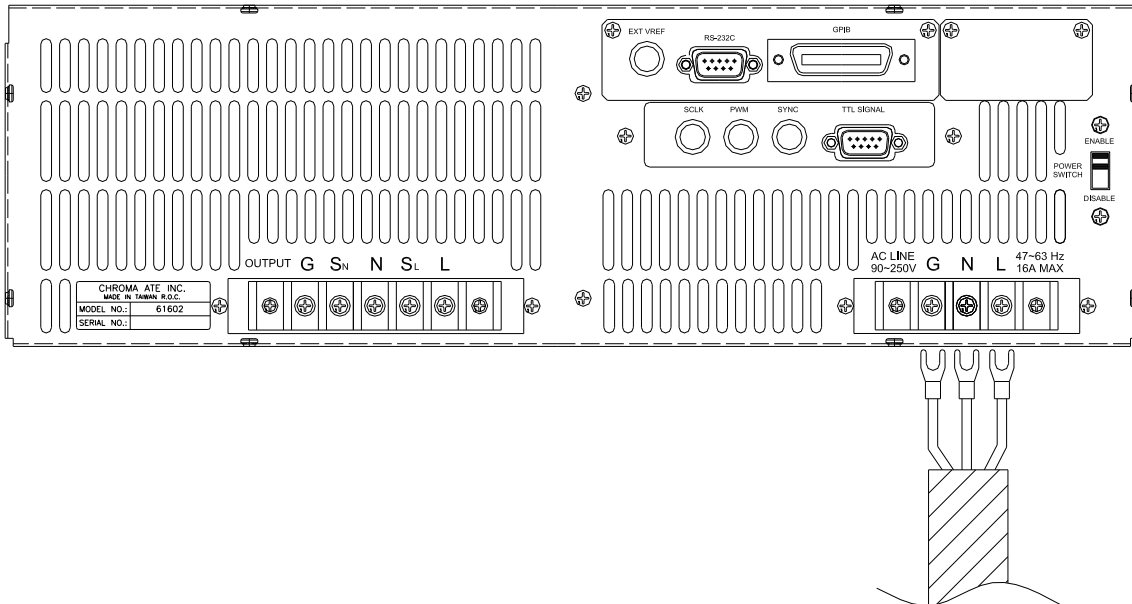

Figure 2-1 Input Connection

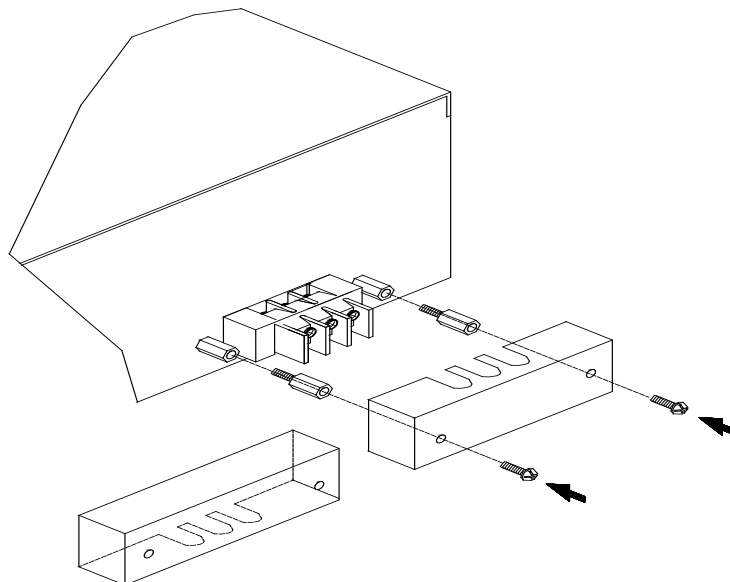

Figure 2-2 Input Terminal Cover

2.4 Output Connection

The output terminal block is located in the rear of the AC source. Load connecting to the "N" and "L" is done at the output terminals. To meet the safety requirements, the safety cover must be fastened. The wires to the load must be sufficiently large gauges, so they will not overheat while carrying the output current. Please see *Figure 2-3* on the next page.



Output terminal labeled "L" is the "+" terminal, terminal labeled "N" is the "-" terminal when output voltage contains DC composition.

2.5 Remote Sense Connection

The remote sense function of the AC source monitors the voltage at the load instead at the output terminal of the AC source. It ensures the delivery of accurate voltage as programmed at the load by automatically compensating the output voltage drop over the connecting cable.

Remove the iron chip from the "SN" and "SL" terminals, connect the remote sense to the load as shown in *Figure 2-3*. Because the sensing leads carry only a few milliamperes, the wires for sensing are much lighter than the load leads. The sensing leads are part of the feedback path of the AC source, so they must be kept at a low resistance in order to maintain the best performance. Connect the sensing leads carefully so that they will not be open-circuited. If the sensing leads are left unconnected or become open-circuited during operation, the AC source will disable the output. The sensing leads must be a twisted pair to minimize the pickup of external noise. The sensing leads need to be connected to the load as close as possible.

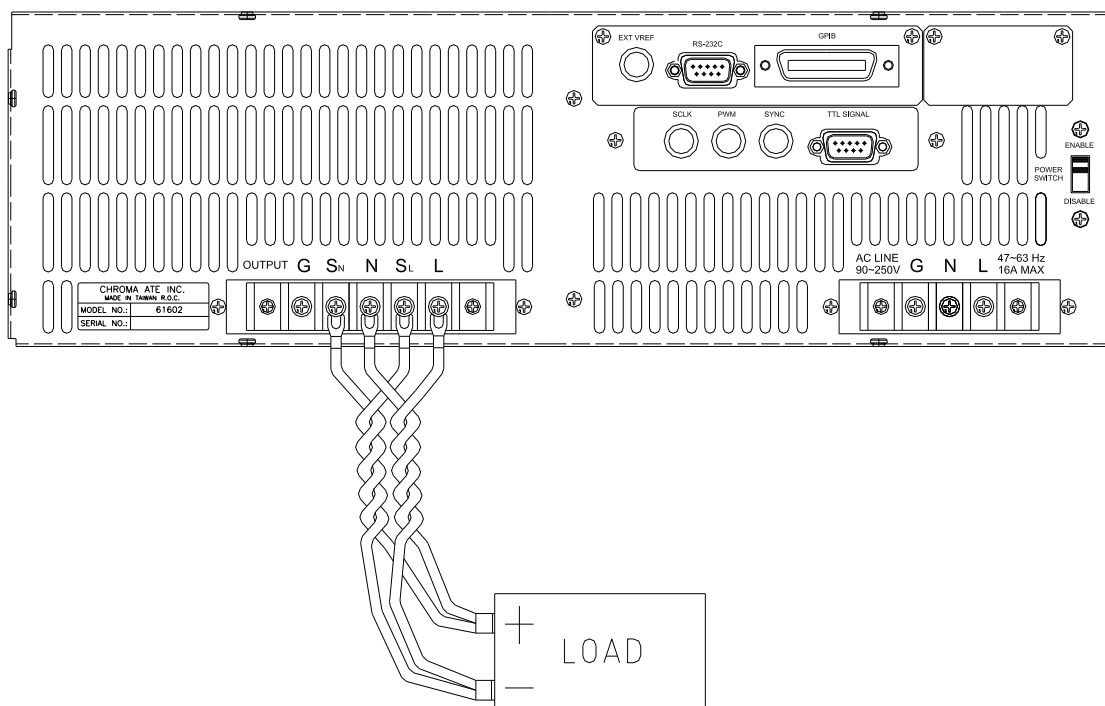

Figure 2-3 Output & Remote Sense Connection

2.6 Power-on Procedure

⚠ WARNING Before turning on the instrument, all protective earth terminals, extension cords, and devices connected to the instrument must be connected to a protective earth ground. Any interruption of the protective earth grounding will cause a potential shock hazard that could result in personal injury.

Apply the line power and turn on the power switch on the front panel. The AC source will do a series of self tests. The LCD on the front panel will light up and display as below:

SELF TEST
WAIT

Meanwhile, the AC source does the memory, data and communication self-test. After the routines of the self test are done, the display shows the MODEL number, and the serial number of the AC source, and it shows an "OK" at the right side of each test item indicating that the item is no problem. It takes about six seconds to complete the routines of the self-test. Then the display shows the versions of software as below.

MODEL : 61602	SERIAL NO : 123456
1. DISPLAY < OK >	Ver : 1.01
2. WAVEFORM < OK >	Ver : 1.02
3. REMOTE < OK >	Ver : 1.03

If any failure is detected on a certain item, an "ERROR CODE" will be shown at the right side of that item. The error messages and trouble-shooting are shown on 6.2. The test item "3. REMOTE" shows " < EMPTY > ", if the option board (with GPIB and RS-232) is not connected.

After finishing memory, data and communication self-test, the AC source do the power output self-test. In this procedure, the output relays are in OFF status to sure not harming the load connecting on output terminal. The AC source will program 300Vac and measure the voltage. If the measured voltage is over $300V \pm 5V$, the power self-test is failed, and the display will show "NG". If it's ok, the display is shown as below. Then, it changes to MAIN PAGE automatically.

OUTPUT SELF TEST < OK >

📌 Notice 1. The user can do diagnosis if error or NG happened in power-on self-test procedure. Please see 6.2.

2. The inner digital circuit of AC source maybe not reset if turn off power then turn on immediately. Waiting more than 3 seconds is suggested to turn on power after turning off.

2.7 I/O Connectors (Option)

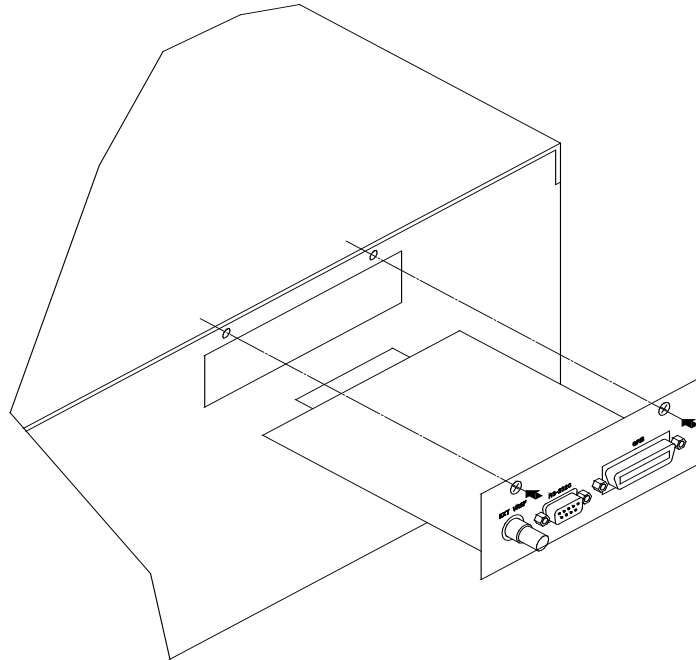

Figure 2-4 Option Board

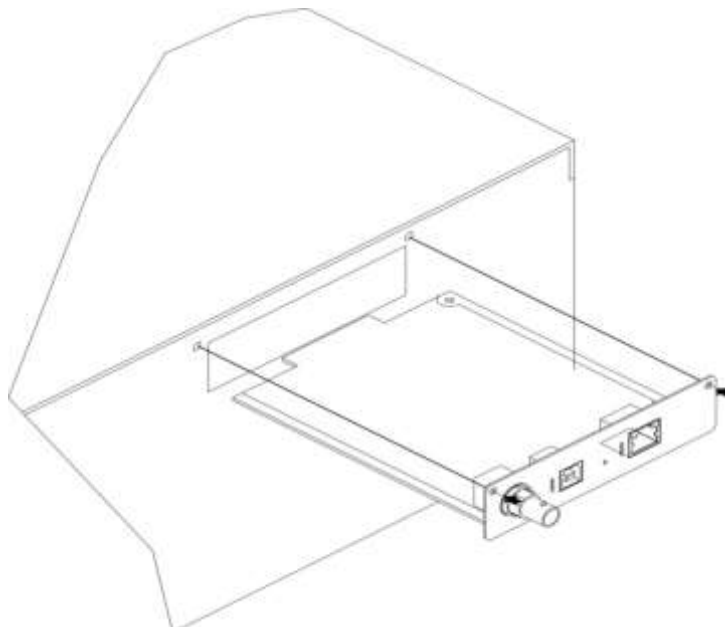

Figure 2-5 Option Board (with USB and Ethernet)

3. Local Operation

3.1 Introduction

The AC source can be configured to operate in local or remote mode. The operation in remote mode through a remote GPIB controller or RS-232C will be described in Chapter Seven. In this section the operation in local mode through the keypad on the front panel for data entry and test is going to be described. The AC source is configured for local operation when it is turned on.

3.2 Operation through Keypad and RPG

The AC source provides the user-friendly programming interface using the keypad and RPG (Rotary Pulse Generator) on the front panel to the user. Each display of the LCD on the AC source represents an operational menu.

The command tree is shown in *Figure 3-1*. Before describing each menu, the following show how to use keypad and RPG to set command. When the procedure of power-on is finished (see 2.6), the display will show MAIN PAGE as below.

Vac = 0.0	F = 60.00	Vdc = 0.0	H
V = 0.00	F = 0.00	I = 0.00	▲
P = 0.0	PF = 0.000	CF = 0.00	▼

Press ▲, ▼ to move cursor to choose the item. Use numeric and decimal keys or RPG to set value, then press **ENTER** to confirm. The user can press **PAGE/EXIT** to change to CHOICE PAGE as below. Or press **PAGE/EXIT** again to return to MAIN PAGE.

PAGE CHOICE = 1_
1. SETUP 2.CONF 3.OUTPUT 4. MANUAL CALI

In CHOICE PAGE, the user can press numeric key then **ENTER** to choose the functional lists. After entering each functional list, press ▲, ▼ to move cursor to destination. If the settings are expressed by number, the user can use numeric and decimal keys or RPG to set value, then press **ENTER** to confirm. If the settings are expressed by words, the user can turn RPG to choice, then press **ENTER** to confirm.

If there are ▲ or ▼ patterns in right-down side of display, it means there are functional list on last page or next page. The user can press **SHIFT** then ▲ or ▼ to change page. If finish the setting, press **PAGE/EXIT** to return to CHOICE PAGE.

MAIN PAGE (output setting and measurement)

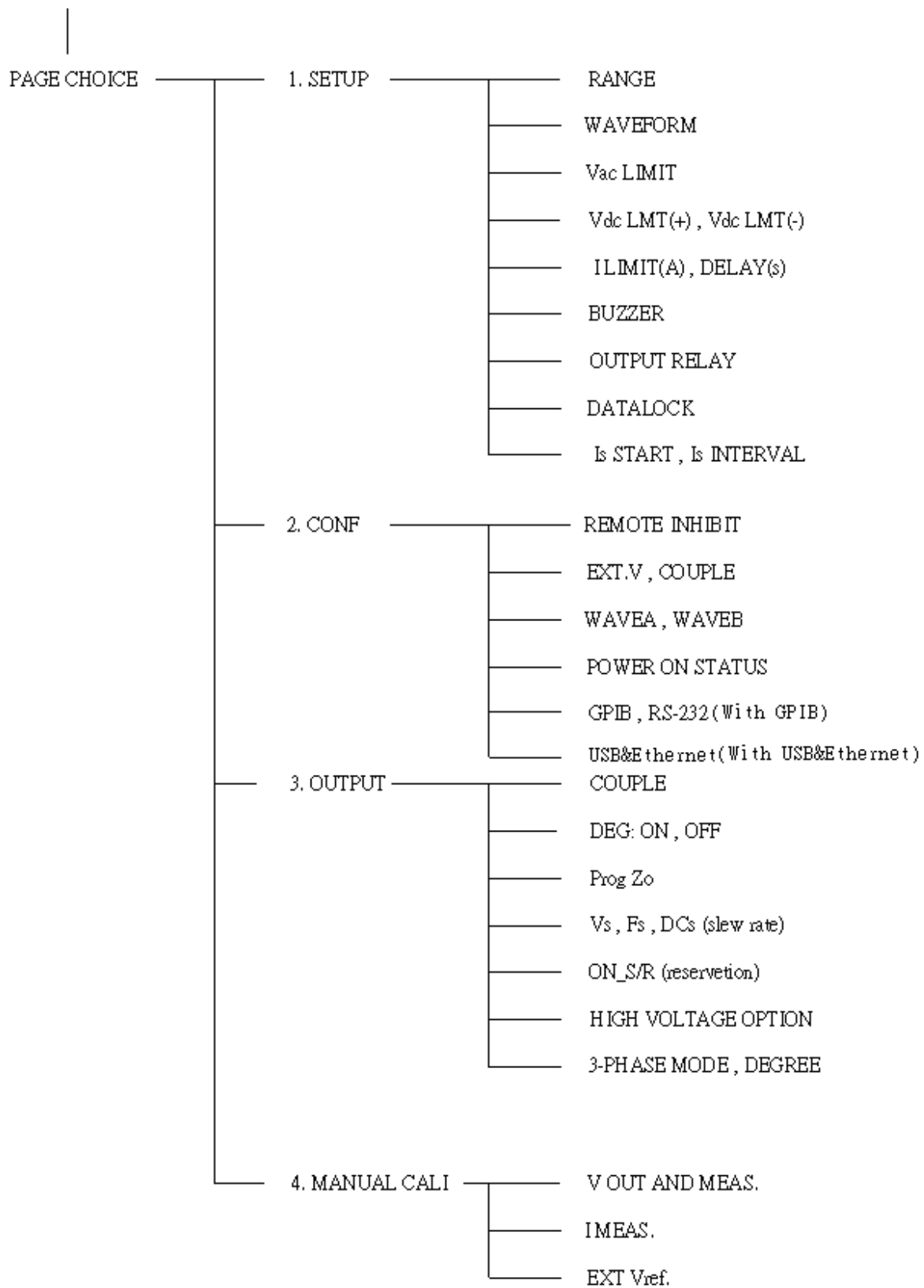

Figure 3-1

3.3 MAIN PAGE (Output Setting & Measurement)

When the user turns on the AC source, after self testing steps, the display shows the MAIN PAGE. The upper line of display shows the output settings. The state of default output settings can be set on POWER ON STATUS in CONF functional list (see 3.6.3). The lower lines show the measurements of AC source output. Please see the following.

Vac = 0.0	F = 60.00	Vdc = 0.0	L
V = 0.00	F = 0.00	I = 0.00	▲
P = 0.0	PF = 0.000	CF = 0.00	▼

Press **SHIFT**, then ▲ or ▼ to change to next page. Please see the following.

Vac = 0.0	F = 60.00	Vdc = 0.0	L
Vdc = 0.00	Idc = 0.00	Ip = 0.0	▲
Is = 0.0	VA = 0.0	VAR = 0.0	▼

On the right-up side of display, a letter "L" shows the status of RANGE (see 3.5.1). The definition of letters:

L : 150V RANGE
 H : 300V RANGE
H : 600V RANGE
 A : AUTO RANGE

The definitions of output setting parameters:

Vac : It is the AC composition of output voltage in Volts.
 F : It is the output frequency in Hertz.
 Vdc : It is the DC composition of output voltage in Volts.

Notice

When COUPLE = AC+DC, the output is the combination of Vac and Vdc. But the combination of peak voltage can not exceed the limit of each range (150V RANGE: 212.1V, 300V RANGE: 424.2V). If it is happened, the output voltage will quit to 0V automatically, and show the protection condition.

The definitions of measurement parameters:

V : It is the measurement readings of Voltage in Volts. (true RMS measurement)
 F : It is the output Frequency in Hertz.
 I : It is the measurement readings of Current in Amperes. (true RMS measurement)
 P : It is the true Power measurement in Watts.
 PF : It is the Power Factor, and its calculation formula = true power/ (Vrms × Irms)
 CF : It is the Crest Factor, and its calculation formula = Ipeak/Irms.

- Vdc : It is the DC composition measurement readings of Voltage in Volts.
Idc : It is the DC composition measurement readings of Current in Amperes.
Ip : It is the peak current measurement in Amperes.
Is : It is I surge, and only measured from the occurrence of output transition as defined in 3.5.8.
VA : It is Apparent Power in Watts, and its calculation formula = $V_{rms} \times I_{rms}$.
VAR : Its calculation formula = $\sqrt{VA^2 - P^2}$

3.4 CHOICE PAGE (Functional List Choice)

If displays on MAIN PAGE or on functional list, press **PAGE/EXIT** to change to CHOICE PAGE as below:

```
PAGE CHOICE = 1_  
1. SETUP  2.CONF  3.OUTPUT  4. MANUAL CALI
```

Users can press **1** - **4** to choose operational list item, then press **ENTER** to confirm it.

The display will switch to MAIN PAGE when press **PAGE/EXIT** on CHOICE PAGE.

3.5 SETUP Functional List

On CHOICE PAGE (see 3.4), press **1** then **ENTER**, choose the SETUP functional list.

```
PAGE CHOICE = 1_  
1. SETUP  2.CONF  3.OUTPUT  4. MANUAL CALI
```

```
RANGE = 150V [ SETUP ]  
Vac LIMIT = 300V  
Vdc LMT (+) = 424.2 V   Vdc LMT (-) = 0.0V  
I LIMIT (A) = 0.0      DELAY (S) = 0.0 ▼
```

Press **SHIFT**, then **▼** to change to next page.

```

BUZZER = ON   OUTPUT RELAY = ON [ SETUP ]
DATALOCK = OFF
Is START = 0.0 ms
Is INTERVAL= 50.0 ms

```

3.5.1 RANGE

The AC source supplies full range of output voltage with three options of 150 V, 300 V, or AUTO. The user can set RANGE on SETUP functional list (see 3.5). This parameter controls relays to parallel (150V RANGE) or series (300V RANGE) power stages to obtain more current or higher voltage. The 600V range can only work with A615003 fixture. The AUTO range means that the output range switches automatically between 150V and 300V as required.

To set the range of output voltage as AUTO as below:

1. Move the cursor to the command line of Range.

```
Range = 300V_
```

2. Turn the RPG to change the option from "300V" to "AUTO", then press **ENTER**.

```
Range = AUTO
```

Notice

The AC source will set output voltage as 0 V first in order to eliminate voltage spike when range changes. Then, it will set output voltage as set value. It may cause UUT to shut down or get bad if the output is active, when range changes. Besides, the instrument has AUTO RANGE function under FIX. MODE. Others are without AUTO RANGE function.

3.5.2 Vac LIMIT

The setting of Vac LIMIT will restrict the value of Vac in MAIN PAGE. The user can set Vac LIMIT on SETUP functional list (see 3.5). This command is about user-programmable protection, not hardware protection.

The procedures for setting Current Vac LIMIT = 120V, are described as below:

1. Move the cursor to the command line of "Vac LIMIT =".

```
Vac LIMIT = 300.0_
```

2. Press **1**, **2**, **0** then press **ENTER** to change the value to "120.0".

```
Vac LIMIT(A) = 120.0
```

Notice

The setting of Vac LIMIT is not restricted by RANGE, but the Vac on MAIN PAGE is restricted by RANGE. For example, in 150V RANGE, although Vac LIMIT=200V, the largest value of Vac setting is 150V.

3.5.3 Vdc LIMIT (+), Vdc LIMIT (-)

Vdc LIMIT (+) and Vdc LIMIT (-) limit the setting value of Vdc on MAIN PAGE. The user can set both on SETUP functional list (see 3.5). The setting value of Vdc can not be higher than Vdc LIMIT (+), or can not be lower than Vdc LIMIT (-). Vdc LIMIT (+) must be positive or zero, Vdc LIMIT (-) must be negative or zero. This command is about user-programmable protection, not hardware protection.

The procedures of setting Vdc LMT (+)=200V, Vdc LMT (-)=-50V, are described as below:

- | | |
|---|---------------------------------------|
| 1. Move the cursor to the command line of "Vdc LIMIT(+)" = ". | Vdc LMT(+) = 424.2_ Vdc LMT(-) = 0.0 |
| 2. Press [2] , [0] , [0] then press ENTER to change the value to "200.0". | Vdc LMT(+) = 200.0 Vdc LMT(-) = 0.0_ |
| 3. The cursor moves to the command line of "Vdc LIMIT(-)" = " automatically. | Vdc LMT(+) =200.0 Vdc LMT(-) = -50_ |
| 4. Press [↔ / -] , [5] , [0] then press ENTER to change the value to "-50.0". | Vdc LMT(+) = 200.0 Vdc LMT(-) = -50.0 |

 **Notice**

1. The setting of Vdc LIMIT is not restricted by RANGE, but the Vdc on MAIN PAGE still restricted by RANGE. For example, in 150V RANGE, although Vdc LIMIT=250V the largest value of Vac setting is 212.1V.
2. When AC source output contains Vdc, it's better to restrict the value of Vdc. It may cause damage if output polarity is reverse, especially the load is polar.

3.5.4 I LIMIT, DELAY

Limitation of output RMS current, and delay time are the parameters for triggering over current protection. The user can set both on SETUP functional list (see 3.5). The discussion of limitation in this command is about user-programmable protection, not hardware protection.

The procedures of setting Current limit = 4A, Delay time = 1 sec., are described as below:

- | | |
|--|-----------------------------------|
| 1. Move the cursor to the command line of "I LIMIT(A)" = ". | I LIMIT(A) = 0.00_ DELAY(S) = 0.0 |
| 2. Press [4] , then press ENTER to change the value to "4.00". | I LIMIT(A) = 4_ DELAY(S) = 0.0 |
| 3. The cursor moves to the command line of "DELAY(S)" = " automatically. | I LIMIT(A) = 4.00 DELAY(S) = 0.0_ |

4. Press **1**, **ENTER** to change the value to "1.0".

I LIMIT(A) = 4.00 DELAY(S) = 1.0_

Notice

1. When " I LIMIT (A) = 0 ", means the limitation of output current is equal to specification.
2. DELAY time is valid for eliminating transient current spike, but not work when the output current is over specification. The resolution is 0.5s.

3.5.5 OUTPUT RELAY

There are relays on the output of the AC source for the connection to load. When output relay is "ON", it means that the output relay is closed in spite of that the output status of the AC source is in QUIT mode. When output relay is "OFF", it means that the output relay is closed only as the output status is in RUN mode. If the output status is in QUIT mode, the output relay will be opened. The user can set OUTPUT RELAY on SETUP functional list (see 3.5).

To set the output relay as ON as below:

1. Move the cursor to the command of OUTPUT RELAY.
2. Turn RPG to set output relay ON, then press **ENTER**.
A click sound will be produced from the AC source when output relay is activated.

OUTPUT RELAY=OFF_

OUTPUT RELAY= ON

Notice

1. Before powering off, please confirm if the AC SOURCE is outputting voltage. For ensure the life of the AC SOURCE, it powered off under outputting status is prohibited strongly.

3.5.6 BUZZER

The buzzer of the AC source beeps when the user presses the keypad on the front panel, or turns the PRG knob. If the user does not need it, he can turn it off. The user can set BUZZER on SETUP functional list (see 3.5).

To turn off the buzzer as follows:

1. Move the cursor to the command line of "Buzzer=".
2. Turn RPG to change the option from ON to OFF, then press **ENTER**.

Buzzer = ON_

Buzzer = OFF

3.5.7 DATALOCK

The AC source allows the user to lock data entries, so the pre-defined parameters can be protected from being modified by an unauthorized person. The user can set DATALOCK on SETUP functional list (see 3.5). The user also can set DATALOCK = FUNC to operate "One-key Recall". It means the user can recall the voltage output setting which stored in the memory (see 3.8.1) only need to press **1**-**9** key directly in Main Page.

The procedures of the setting data lock are shown as below:

1. Move the cursor to the command line of "DATALOCK=".

DATALOCK = OFF_

2. Turn RPG to change the option from OFF to ON, then press **ENTER**.

DATALOCK = ON

 **Notice**

1. The user must select OFF to unlock.
2. If users use FUNC, please be sure the voltage output settings are stored in the memory. Unexpected voltage output may damage the UUT.

3.5.8 Is START, Is INTERVAL

Is is the surge peak current of AC source output shown in MAIN PAGE. Is measurement starts at Is START after output voltage transition. The length of measurement time is Is INTERVAL. The user can set both on SETUP functional list (see 3.5).

The procedures of setting Is START=10ms, Is INTERVAL = 200 ms, are described as below:

1. Move the cursor to the command line of "Is START = ".

Is START= 0.0_ ms

2. Press **1**, **0** then press **ENTER** to change the value to "10.0".

Is START = 10.0 ms

3. The cursor moves to the command line of "Is INTERVAL = " automatically.

Is INTERVAL = 50.0_ ms

4. Press **2**, **0**, **0** then press **ENTER** to change the value to "200.0".

Is INTERVAL = 200.0_ ms

3.6 CONF Functional List

On CHOICE PAGE (see 3.4), press **2** then **ENTER**, choose the CONF functional list.

```

PAGE CHOICE = 2_
1. SETUP  2.CONF  3.OUTPUT  4. MANUAL CALI
  
```

```

REMOTE INHIBIT = OFF           [ CONF ]
EXT. V =OFF           COUPLE = AC-AMPLIFIER
                                                                    ▼
  
```

Press **SHIFT**, then **▼** to change to next page.

```

POWER ON STATUS :  Output = OFF   [ CONF ]
Vac = 0.0           F = 60.00      Vdc = 0.0
ADDR = 0           PARITY = NONE
BAUD = 9600
                                                                    ▲
  
```

When using with option board (with USB and Ethernet), an extra function page will appear for setting network connection.

```

POWER ON STATUS :  Output = OFF   [ CONF ]
Vac = 0.0           F = 60.00      Vdc = 0.0
                                                                    ▲
                                                                    ▼
  
```

```

DHCP=OFF           < NONE_CONNECT > [ CONF ]
IP Address  =0     .0  .0  .0
Subnet Mask =0     .0  .0  .0
Gateway     =0     .0  .0  .0      APPLY=NO ▲
  
```

When no option board is in use, the figure is shown as below.

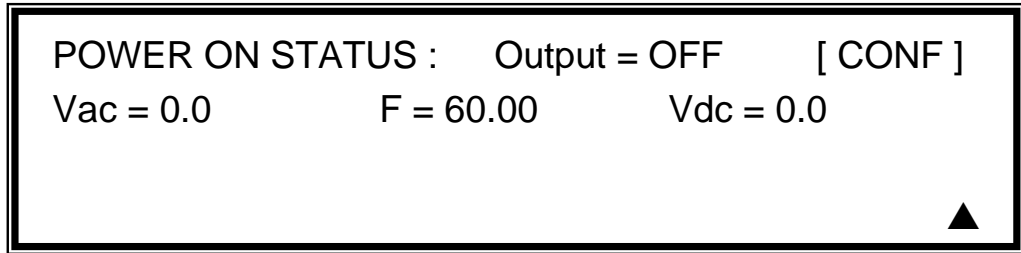

3.6.1 REMOTE INHIBIT

The output of the AC source can be inhibited by the external control or by manual trigger. The remote inhibit signal is received from 9-pin male connector on rear panel (see Appendix A). The user can set REMOTE INHIBIT on CONF functional list (see 3.6). There are three states for the feature of remote inhibit : OFF, LIVE, and TRIG.

- OFF : It is to disable the feature of remote inhibit.
- LIVE : The output of the AC source will be disabled if TTL signal is LOW, but will be automatically recovered if TTL signal is HIGH.
- TRIG : The output of the AC source will be disabled if TTL signal is LOW, and will remain the state even TTL signal becomes HIGH. The user has to press **ENTER** to reset the AC source.

The procedures of setting from OFF to LIVE are shown as below:

1. Move the cursor to the command of "REMOTE INHIBIT" to set inhibition by the TTL signal from the external control.

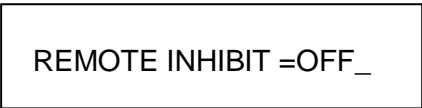

2. Turn RPG to change the option from OFF to LIVE, then press **ENTER**.



The remote inhibit is a TTL signal transferred via the special I/O connector. For details please refer to pin assignment in *Appendix A*.

3.6.2 EXT. V, COUPLE

The AC source allows the user to make use of the controlled analog signal from external devices for the setting of its output. The BNC connector of the EXT Vref on the rear panel lets the user apply signal to the AC source for the setting of output voltage. The user can set EXT. V and COUPLE on CONF functional list (see 3.6). There are two coupling mode to present AC source output from external V reference: AC_AMPLIFIER and DC_LEVEL_CTL.

AC_AMPLIFIER: The output voltage (Vout) is the synthesis of voltage programming on MAIN PAGE and the amplification of external V reference with Voltage range from -10 V to 10 V. When Vac=0 and Vdc=0 on MAIN PAGE, Vout can be calculated using the following formula :

$$V_{out} (dc) = V_{ref} (dc) / 10 V_{dc} \times 424.2 V_{dc} \quad (300V \text{ RANGE})$$

$$V_{out} (dc) = V_{ref} (dc) / 10 V_{dc} \times 212.1 V_{dc} \quad (150V \text{ RANGE})$$

or

$$V_{out} (ac) = V_{ref} (ac) / 7.072 V_{ac} \times 300 V_{ac} \quad (300V \text{ RANGE})$$

$$V_{out} (ac) = V_{ref} (ac) / 7.072 V_{ac} \times 150 V_{ac} \quad (150V \text{ RANGE})$$

Example (1): set V_{out} to 100Vdc:

1. Select RANGE = 300V in SETUP functional list, apply external $V=2.357V_{dc}$, the $V_{out} = 100V_{dc}$.
2. Select RANGE = 150V in SETUP functional list, apply external $V=4.715V_{dc}$, the $V_{out} = 100V_{dc}$.

Example (2): set V_{out} to 100Vac:

1. Select RANGE = 300V in SETUP functional list, apply external $V=2.357V_{ac}$, the $V_{out} = 100V_{ac}$.
2. Select RANGE = 150V in SETUP functional list, apply external $V=4.715V_{ac}$, the $V_{out} = 100V_{ac}$.

DC_LEVEL_CTL: The output voltage ($V_{out} (ac)$) responses linearly proportional to the controlled DC level with voltage ranging from -10 V to 10 V. V_{out} can be calculated using the following formula:

$$V_{out} (ac) = | V_{ref} (dc) | / 10 V_{dc} \times 300V_{ac} \quad (300V \text{ RANGE})$$

$$V_{out} (ac) = | V_{ref} (dc) | / 10 V_{dc} \times 150V_{ac} \quad (150V \text{ RANGE})$$

Example (1): set V_{out} to 100Vac:

1. Select RANGE = 300V in SETUP functional list, apply external $V=3.333V_{dc}$ (or $-3.333V_{dc}$), the $V_{out} = 100V_{ac}$.
2. Select RANGE = 150V in SETUP functional list, apply external $V=6.667V_{dc}$ (or $-6.667V_{dc}$), the $V_{out} = 100V_{ac}$.

The procedures of setting EXT. V = ON, COUPLE = DC_LEVEL_CTL, are described as below:

1. Move the cursor to the command of "EXT. V = ".

EXT.V = OFF_ COUPLE=AC_AMPLIFIER

2. Turn RPG to change the option from OFF to ON, then press **ENTER**.

EXT.V = ON COUPLE=AC_AMPLIFIER_

3. The cursor moves to the command line of "COUPLE = " automatically.

EXT.V = ON COUPLE=DC_LEVEL_CTL

4. Turn RPG to select DC_LEVEL_CTL, then press **ENTER**.

EXT.V = ON COUPLE=DC_LEVEL_CTL_

Notice

When EXT. V=ON, COUPLE=DC_LEVEL_CTL, the output voltage (V_{out}) will respond to the external control DC voltage level only. The user cannot control V_{out} amplitude through the keypad on the front panel, until EXT.V=OFF again.

WARNING

1. As COUPLE = AC_AMPLIFIER and the frequency of V_{ref} is over 1000Hz, it might cause AC source damage. The user should obey

- the formula if $F > 1000\text{Hz}$: $V_{\text{ref}} (\text{pk-pk, V}) \times F (\text{Vref, Hz}) < 10000 \text{ VHz}$
- 2. Because of the bandwidth limitation of AC source, the output may distortion. Especially when external V reference consists of high frequency composition.

3.6.3 POWER ON STATUS

The AC source allows the user to set the status of the output when power is switched on. The user can set POWER ON STATUS on CONF functional list (see 3.6). After setting, the user should save them before powering off (see 3.8.2).

To set the output is on, as 120 Vac, 50Hz, 10Vdc when power-on.

1. Move the cursor to the line of "POWER ON STATUS : output =".

POWER ON STATUS : output = OFF_

2. Turn RPG to set output ON, then press **ENTER**.

POWER ON STATUS : output = ON

3. Press **1** , **2** , **0** , **ENTER** to set Vac=120.

Vac = 120.0 F=60.0_ Vdc = 0.0

4. Press **5** , **0** , then press **ENTER** to set F=50.

Vac = 120.0 F=50.0 Vdc = 0.0

5. Press **1** , **0** , then press **ENTER** to set Vdc=10.

Vac = 120.0 F=50.0 Vdc = 10.0

3.6.4 GPIB Address, RS-232C (with GPIB)

The AC source offers the mode of remote operation too. The user can set them on CONF functional list (see 3.6). For details please refer to *Chapter 7*. Prior to remote operation the user has to set the GPIB address 10 as below:

1. Move the cursor to the command line of GPIB address.

ADDR = 30_

2. Press **1** , **0** , **ENTER** to set address 10.

ADDR = 10

 **Notice** : Addressing space ranges from 1 to 30.

The AC source offers another remote operation through the RS-232C bus. Communication

protocol is set as follows:

To set parity=ODD, baud rate=19200.

1. Move the cursor to the command line of PARITY.

PARITY= NONE_ BAUD=9600

2. Turn RPG to select ODD, then press **ENTER**.

PARITY=ODD BAUD=9600_

3. The cursor moves automatically to the setting position of "BAUD". Turn RPG to select "19200", then press **ENTER**.

PARITY=ODD BAUD=19200



Notice

The options of baud rate are 9600/19200. The options of parity are EVEN/ODD/NONE.

3.6.5 USB and Ethernet Setting

Select auto (ON) or manual (OFF) to verify the network IP.

1. Move the cursor to DHCP line.

DHCP=OFF_

2. Turn RPG to select "ON", then press **ENTER**.

DHCP=ON_

Set the IP address based on the network search.

1. Move the cursor to IP Address line.

IP Address =0_ .0 .0 .0

2. Press **5,0,ENTER,1,0,0,ENTER,1,5,0,ENTER,2,5,5,ENTER** to set the IP address.

IP Address =50 .100 .150 .255_

Set the Subnet Mask based on the network search.

1. Move the cursor to Subnet Mask line.

Subnet Mask =0_ .0 .0 .0

2. Press **5,0,ENTER,1,0,0,ENTER,1,5,0,ENTER,2,5,5,ENTER** to set Subnet Mask address.

Subnet Mask =50 .100 .150 .255_

Set the Gateway based on the network search.

1. Move the cursor to Gateway line.

Gateway =0_ .0 .0 .0

2. Press **5,0,ENTER, 1,0,0,ENTER, 1,5,0,ENTER 2,5,5,ENTER** to set Gateway address.

Gateway =50 .100 .150 .255_



CAUTION

The range of IP Address, Subnet Mask and Gateway settings is from 0 to 255.

Apply the IP settings by selecting Yes or No.

1. Move the cursor to APPLY line.

APPLY=NO_

2. Turn RPG to select "YES", and then **ENTER**.

APPLY=YES_

3.7 OUTPUT Functional List

On CHOICE PAGE (see 3.4), press **3** then press **ENTER**, choose the OUTPUT functional list.

PAGE CHOICE = 3_
 1. SETUP 2.CONF 3.OUTPUT 4. MANUAL CALI

COUPLE = AC+DC_ DEG : ON= 0.0 OFF=IMMED
 Vs (V/ms) = 0.000 Fs (Hz/ms) = 0.000 ▲
 DCs (V/ms) = 0.000 ON_S/R = OFF ▼

Press **SHIFT**, then ▼ to change to next page.

HIGH VOLTAGE OPTION = NONE [OUTPUT]
 3-PHASE MODE=OFF ▲
 DEGREE=0.0 ▼

3.7.1 COUPLE Mode of Output (AC+DC, AC, DC)

There are three couple mode of AC source output: AC+DC, AC and DC. The user can set COUPLE on OUTPUT functional list (see 3.7) to fit the application. Then, the display of MAIN PAGE will change corresponding to the mode.

The procedures of setting from AC+DC to AC are shown as below:

1. Move the cursor to the command of "COUPLE="

COUPLE = AC+DC_

2. Turn RPG to change the option from AC+DC to AC, then press **ENTER**.

COUPLE = AC

Notice

The DC mode of AC source is applied to doing some voltage tests. The AC source has not such many output capacitors; some features like voltage ripple, load transient, are not as good as DC source. But it can supply positive and negative DC voltage without changing output connector.

WARNING

Chroma 61600 AC source have AC/DC/AC+DC output function, at DC output part, it's still different from really DC source, the reason as below:

1. The big ripple noise at DC output, it is because of AC source have no output capacitor.
2. The AC source output relay will switch off when the current over the specification, it will cause output voltage interruption.
P.S. Normally the DC source will change to C.C. mode, then the output voltage slow down to 0V.
3. Another major reason is, it cannot accept add/increase large capacitor, more than 20uF at output side directly. It may cause output unstable and damage AC source.

For solving above weak point, we suggest that adds a special fixture for sure and protection.

61600 AC SOURCE

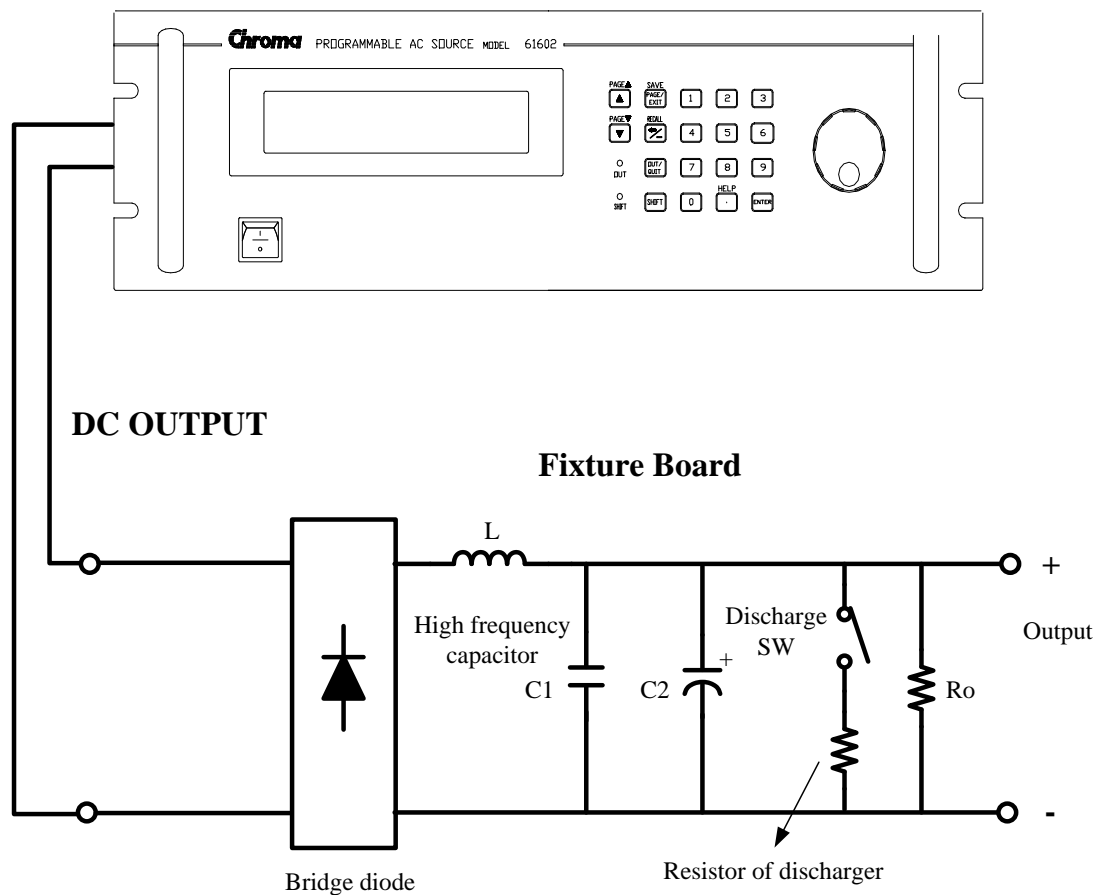

Illustration for fixture:

1. Bridge diode: Because of internal control circuit of AC source, if users connect more than 20uF capacitor at output side, it may cause output unstable. It's better to use bridge diode for isolating external capacitor. Also, it could prevent from wrong connection for polarity of output DC level. But, it will cause 1.6V drop when adds the bridge diode. (The user can compensate the output DC voltage by setting voltage level. For example, the user can program 11.6V in order to get 10 V on the output of fixture board.)
2. L and high frequency capacitor: They can filter high frequency ripple and noise. But it is not necessary if doesn't care ripple noise.
3. C and SW: It could switch off if UUT already has capacitor.
4. Discharger resistor and SW: It could discharge the capacitor for avoiding remnant voltage to hit user when output off. But, users need to consider about power consumption, the discharger resistor power should be enough for it.

3.7.2 OUTPUT DEGREE

The AC source can control the transition angle of the waveform when it out or quit. The user set DEG ON and OFF to achieve it in OUTPUT functional list (see 3.7)

The procedures for setting output phase angle DEGREE ON=90 and OFF=180, are described as below:

1. Move the cursor to the command line of "ON = ".

```
DEG ON = 0.0_ OFF= IMMED
```

2. Press **9**, **0**, then **ENTER** to change the value to " 90.0".

```
DEG ON = 90.0 OFF= IMMED_
```

3. The cursor moves to the command line of "OFF= " automatically.

4. Press **1**, **8**, **0**, then press **ENTER** to change the value to " 180.0".

```
DEG ON = 90.0 OFF= 180.0
```

Notice

If " OFF=IMMED", the output voltage quits immediately when the user presses **QUIT**. But if a value of degree is set, the output voltage will last until the setting degree. Key in "OFF= 360" became " OFF= IMMED".

3.7.3 Slew Rate of Output Transient

The AC source can control the transition waveform of the output by setting COUPLE on OUTPUT functional list (see 3.7). User can set three commands to achieve the transient state of output waveform: Vs (V/ms), Fs (Hz/ms), DCs (V/ms).

Vs : the slew rate of output Vac.

Fs : the slew rate of output frequency.

DCs : the slew rate of output Vdc.

When user run OUT of AC source or change the output setting in MAIN PAGE, the output voltage and frequency will change corresponding to the Vs, Fs, DCs commands. The procedures of setting Vs (V/ms)=0.2, Fs (Hz/ ms)=0.1, DCs (V/ms)=1, are described as below:

1. Move the cursor to the command line of "ON_S/R = ".

```
ON_S/R=OFF
```

2. Turn RPG to set the output to ON and then press **ENTER**.

```
ON_S/R=ON
```

3. Move the cursor to the command line of "Vs (V/ms) = ".

```
Vs (V/ms) = 0.000_
```

4. Press **0**, **.**, **2**, then press **ENTER** to change the value to "0.2".

```
Vs (V/ms) = 0.200
```

5. The cursor moves to the command line of "Fs (Hz/ms)=" automatically. Press **0**, **.**, **1**, then press **ENTER**.

Fs (Hz/ms) = 0.100

6. The cursor moves to the command line of "DCs (V/ms)=" automatically. Press **1**, then press **ENTER**.

DCs (V/ms) = 1.000_

Notice

1. When user set Vs (V/ms)=0, Fs (Hz/ms)=0, DCs (V/ms)=0, the output transient is in the fastest speed.
2. Vs, Fs DCs have large input range in software programming, but the output cannot exactly follow the slew rate when Vs, DCs are too large.
3. When user run **OUT** of AC source, the output will follow the setting to final state. But when user run **QUIT**, the output will vary to 0 V immediately. If user want to quit the output with the setting slew rate, he must key in 0 V then press **ENTER**.

3.7.4 HIGH VOLTAGE OPTION

For special request, a new 600 Vac option will be added to the Range column in SETUP Function for setting when connected to A615003 fixture. Please be noted that only when work with the A615003 fixture can 600Vac be outputted; or the output voltage is 1/2 of the setting.

The procedures of setting high voltage option:

1. Move the cursor to "HIGH VOLTAGE OPTION" command line.

HIGH VOLTAGE OPTION= NONE

2. Turn RPG from "NONE" to "A615003" and then press **ENTER**.

HIGH VOLTAGE OPTION= A615003

Notice

- Connecting the / FAULT-OUT signal of TTL PIN8 on AC Source rear panel to TTL PIN8 on A615003 rear panel as selecting HIGH VOLTAGE item in OPTION of AC Source 61501 - 61504, thus A615003 can be activated.
- When the A615003 Transformer Unit is operated with the AC Source, please set up the voltage slew rate first before performing high voltage output.

3.7.5 THREE PHASE MODE

When users need a three-phase AC power, it's allowed to assemble three AC sources to be a three-phase AC power. Users can set 3-PHASE MODE on OUTPUT functional list (see 3.7). The AC source setting as MASTER sends SYNchronized signal to SLAVES to position phase angle. The SLAVES also use the signal to trigger and shut down the output. To send

synchronized signal, users have to use a special cable. One terminal of the cable is connected to SYN (in rear panel, BNC connector), it's the MASTER. Another terminals connects to /Remote-Inhibit of TTL signal (in rear panel, 9-Pin D-Type connector, see *Appendix A*), it's the SLAVE. For more information about the cable, please consult your dealer.

The procedure of using THREE PHASE MODE:

1. Connect the N terminals of AC source outputs. (For 3-phase, Y connection).
2. Connect the cable for synchronism.
3. Power on all AC sources. Keep all in output quit state.
4. Set the 3-PHASE MODE = MATER, DEGREE = 0. And set another AC source 3-PHASE MODE = SLAVE, DEGREE = 240 or 120. Press **PAGE/EXIT** twice to MAIN PAGE. Set the voltage and frequency on each AC source. It is better for all AC sources set the same frequency.
5. Press **OUT/QUIT** at MASTER to start output. Press **OUT/QUIT** again to quit the output. **OUT/QUIT** of SLAVE is no use when 3-phase mode.

To change THREE PHASE MODE from OFF to SLAVE as below:

1. Move the cursor to the command line of "3-PHASE MODE=".

```
3-PHASE MODE = OFF_
```

2. Turn RPG to change the option from OFF to SLAVE, then press **ENTER**.

```
3-PHASE MODE = SLAVE
```

3. The cursor move to the command line of " DEGREE =" automatically.

```
DEGREE = 0.0_
```

4. Press **1** , **2** , **0**, then press **ENTER**.

```
DEGREE = 120.0
```

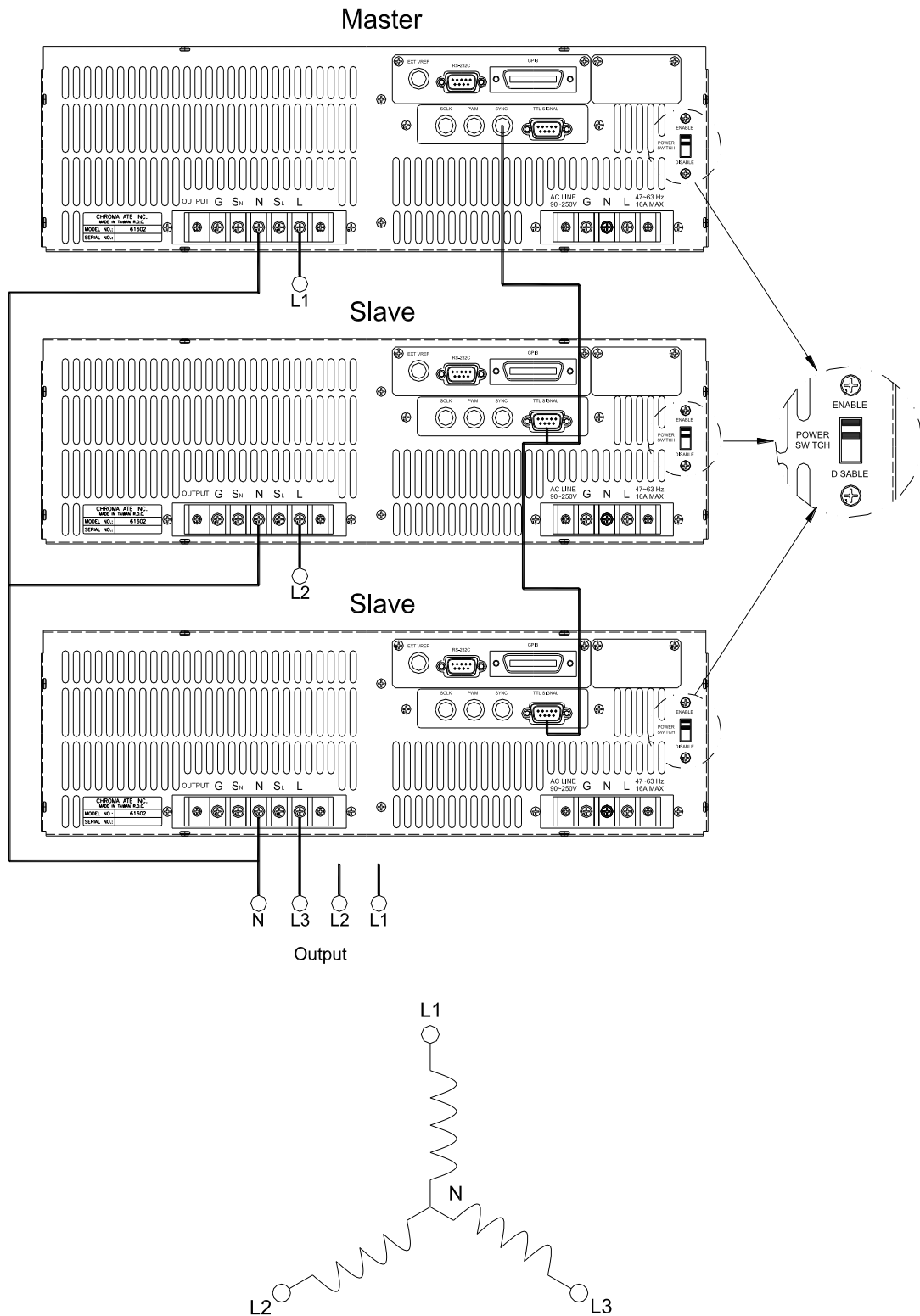

Notice

1. The DEGREE of MASTER is 0, and the DEGREE of SLAVE is 120, it means the SLAVE is 120 degree lead of MASTER.
2. The first cycle of SLAVE waveform will be distorted if the DEG ON (output on degree, see 3.7.2) doesn't be set correctly. For example, if the MASTER DEG ON = 90, the DEG ON of SLAVE

must be 210 ($120 + 90 = 210$). Another SLAVE must DEG ON = 330 ($240 + 90 = 330$).

Notice

1. If the DEG OFF (quit degree, see 3.7.2) of MASTER and SLAVE are IMMED, the MASTER phase angle will quit on zero degree, and the SLAVE will quit on 120 or 240 degree. But if users assign quit degree, for example, if the MASTER DEG OFF = 90, the DEG OFF of SLAVE must be 210 ($120 + 90 = 210$). Another SLAVE must DEG OFF = 330 ($240 + 90 = 330$).
2. The voltage setting of 3-phase output is line-to-neutral V_{LN} for each phase. If users need the line-to-line voltage V_{LL} , the V_{LN} must equal to $V_{LL} / 1.732$.

Notice

The user can use two units of 61600 AC source to connect in series to get higher voltage by three-phase mode. The phase degree should be set on 180 degree. And the user also needs to set the right DEG ON and OFF to get right phase when output is ON or OFF.

WARNING

1. Only one AC source can be set to MASTER, or it may cause damage when run 3-PHASE MODE.
2. Users can not connect L terminals of AC source outputs together, even set the DEGREE = 0 of SLAVE.
3. For safety concern, the 3-phase mode can't save to power-on status.

3.8 Save and Recall

The AC source offers two modes for the user to save and recall output setting or system data. They are described in 3.8.1 and 3.8.2.

3.8.1 Save and Recall Output Setting

The AC source offers nine channels for the user to save a set of frequently used Vac, F, Vdc, and to recall them for later use. For example, in the MAIN PAGE (see 3.3), keyin the output settings as below and save the settings to memory channel 5.

Vac = 230.0	F = 50.00	Vdc = 10.0_	H
V = 0.00	F = 0.00	I = 0.00	▲
P = 0.0	PF = 0.000	CF = 0.00	▼

Press **SHIFT**, then **PAGE/EXIT**, to run the SAVE function. The display will show as below:

CHOICE 1 - 9, PRESS (ENTER) TO SAVE MAIN PAGE			
1.	Vac = 0.0	F = 60.00	Vdc = 0.0
2.	Vac = 120.0	F = 60.00	Vdc = 0.0
3.	Vac = 0.0	F = 60.00	Vdc = 0.0 ▼

The cursor stays in channel 1. The user can press **1** - **9** to select channel or use **▲**, **▼**, or press **SHIFT** then **▼** to change page to the destination. The cursor stays in channel 5 after pressing **5**.

CHOICE 1 - 9, PRESS (ENTER) TO SAVE MAIN PAGE			
4.	Vac = 0.0	F = 60.00	Vdc = 0.0
5.	Vac = 0.0	F = 60.00	Vdc = 0.0 ▲
6.	Vac = 0.0	F = 60.00	Vdc = 0.0 ▼

Press **ENTER** to save the output settings to channel 5. The display will show saving status for about 3 seconds. The display is shown as below.

Saving now, do not shut down	
------------------------------------	--

Then output settings in MAIN PAGE show in channel 5. The display is shown as below.

CHOICE 1 - 9, PRESS (ENTER) TO SAVE MAIN PAGE			
4.	Vac = 0.0	F = 60.00	Vdc = 0.0
5.	Vac = 230.0	F = 50.00	Vdc = 10.0 ▲
6.	Vac = 0.0	F = 60.00	Vdc = 0.0 ▼

Then, press **PAGE/EXIT** to return to MAIN PAGE.

Recalling from memory channel to MAIN PAGE is shown the following: In MAIN PAGE, press **SHIFT** then **↵/-** to run the RECALL function. The display will show as below:

CHOICE 1 - 9, PRESS (ENTER) TO RECALL			
1.	Vac = 0.0	F = 60.00	Vdc = 0.0
2.	Vac = 120.0	F = 60.00	Vdc = 0.0
3.	Vac = 0.0	F = 60.00	Vdc = 0.0 ▼

The cursor stays in channel 1. The user can press **1** - **9** to select channel or use

▲, ▼, or press **SHIFT** then ▼ to change page to the destination. The cursor stays in channel 2. after pressing **2**. The display is shown as below.

CHOICE 1 - 9, PRESS (ENTER) TO RECALL			
1.	Vac = 0.0	F = 60.00	Vdc = 0.0
2.	Vac = 120.0	F = 60.00	Vdc = 0.0
3.	Vac = 0.0	F = 60.00	Vdc = 0.0 ▼

Press **ENTER**, the display return to MAIN PAGE automatically. And the output settings are Vac = 120, F = 60, Vdc = 0, just as the settings saved in memory channel 2.

Vac = 120.0_	F = 60.00	Vdc = 0.00	H
V = 0.00	F = 0.00	I = 0.00	▲
P = 0.0	PF = 0.000	CF = 0.00	▼

If the recalling setting is output of RANGE or over the V LIMIT (see 3.5.2, 3.5.3), the display will show the following:

Conflicting with RANGE or V LIMIT			
Press ENTER key			

Press **ENTER** to return to recall page. Check if the settings violating the RANGE or V LIMIT.

Notice

1. Saving and recalling output settings are acted for MAIN PAGE setting only, the other parameters are ignored.
2. In different couple mode of output (see 3.7.1), the lack of settings will be regular to Vac=0V, F=60Hz, Vdc=0V automatically. For example, in DC output mode, Vac=0V, F=60Hz, Vdc is the setting value in MAIN PAGE as running the SAVE function.

3.8.2 Save and Recall System Data

The AC source offers three memory groups for the user to save system data and to recall them for later use. The system data includes all parameters in function list like SETUP (see 3.5), CONF (see 3.6) and OUTPUT (see 3.7). In the CHOICE PAGE (see 3.4), press **SHIFT**, then **PAGE/EXIT**, to run the SAVE function. The displays are shown as below.

PAGE CHOICE = 1_
1. SETUP 2.CONF 3.OUTPUT 4. MANUAL CALI

Save all parameters to Group (1 - 3) : 1_

Press **1** - **3** to choose one group to save, then press **ENTER** to confirm. The display will show the saving status sentence about three seconds as below.

Save all parameters to Group (1 - 3) : 1_
Saving now, do not shut down

Then, press **PAGE/EXIT** to return to CHOICE PAGE.

Recalling system data from memory group is shown the following: In CHOICE PAGE, press **SHIFT** then **← / -** to run the RECALL function. The display will show as below:

Recall parameters of Group (1 - 3) : 1_

Press **1** - **3** to choose one group to recall, then press **ENTER** to confirm. Then, the display will return to CHOICE PAGE after loading the data.

 **Notice**

The AC source provides three memory groups: 1, 2, and 3. The memory group 1 keeps power-on defaults. The setup data saved into memory group 1 will be recalled automatically when the AC source is powered on again. Those saved into other memory groups must be recalled manually.

3.9 Protection

The AC source provides protection for software and hardware. When protection is happened, the AC source will quit the output and turn off the output relays, then show the condition of protection in display. If any protection is triggered to hold normal output, please remove the errors, then press **ENTER** to unlock the protection so as to resume the normal operation.

Protections for software are listed as below:

Protection	Description
OVER CURRENT	When output current is over the I limit or the current specification.
OVER POWER	When output power is over the specification.
OUTPUT OVP	1. It is feedback open protection, and means that the feedback loop is broken or the output voltage goes wrong. 2. When the out voltage is over the limit of each RANGE. See 3.3.

Protections for hardware are listed as below:

Protection	Description
FAN FAIL	It is fan failure protection, and means that the cooling fan malfunctions.
INT - AD	It is inner AD power stage (see 5.1) protection, and means that the output voltage is over or under the specific value.
INT - DD	It is inner DD power stage (see 5.1) protection, and means that the output voltage is over or under the specific value.
OUTPUT SHORT	It is short protection, and means that the output terminals are shorted.
INPUT FAIL	It is power failure protection, and means that the line input voltage is lower or higher than specification.
OVER TEMP	It is over temperature protection, and will be enabled when the internal temperature of the AC source is too high.

⚠ WARNING : This product is not capable of withstanding reverse current or negative power during inverter testing. Hence dummy load with proper rating should be implemented to dissipate current generated from inverter.

4. Calibration

4.1 Introduction

The ac source built a simple way to calibrate the output and measurement accuracy without opening cover. Users can do it just follow the procedures step by step. A voltage meter, current meter, suitable load and +5V dc source are needed for while calibration procedure. Connections for these instruments please refer to *Figure 4-1*. There are three items need to calibrate. But it is not necessary to calibrate all at once. User can just choose one item if needs.

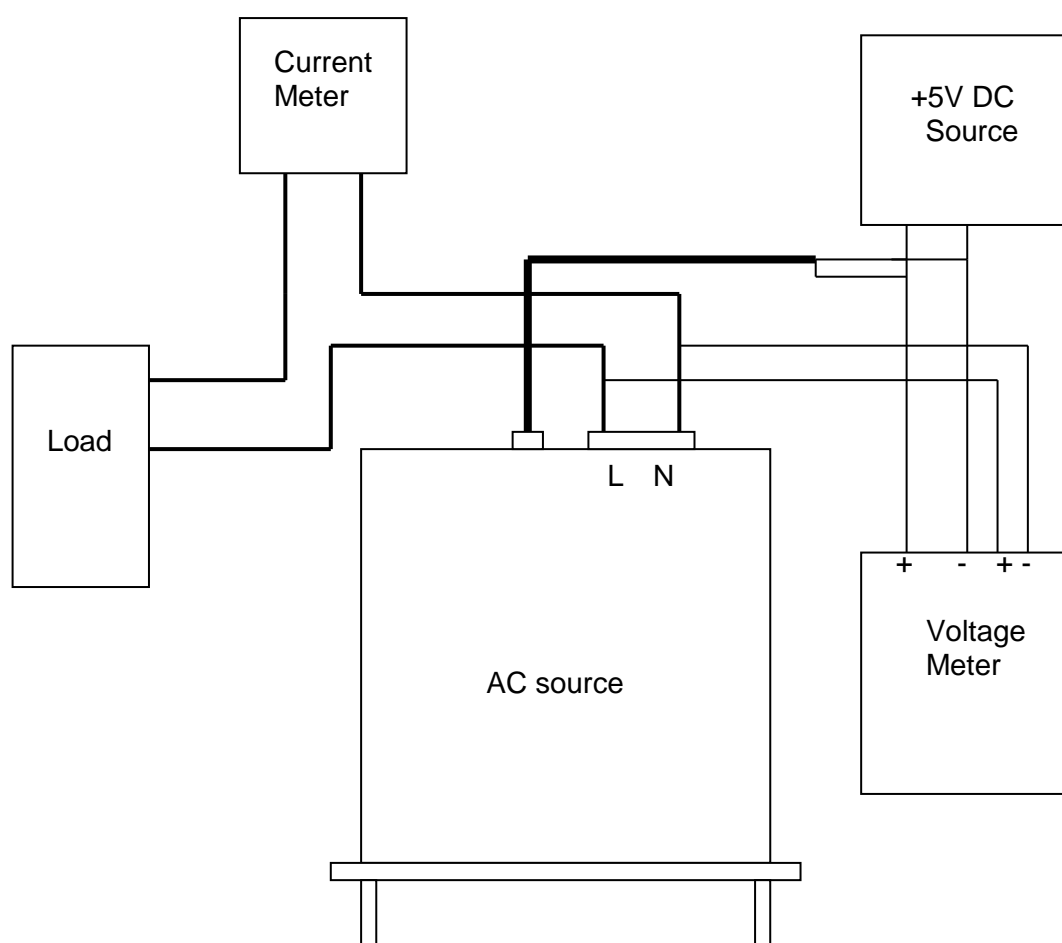

Figure 4-1

4.2 MANUAL CALI Functional List

Users can choose "4. MANUAL CALI " in CHOICE PAGE to enter the calibration procedure. Before showing the calibration items, for safety reason, user must enter password. The password is shown in this manual, in order to confirm the user read the manual before doing the calibration procedure.

PAGE CHOICE = 4_

1. SETUP 2.CONF 3.OUTPUT 4. MANUAL CALI

Enter Password : _

(You can get password in user's manual !)

Enter Password : * * * * _

(You can get password in user's manual !)

 **Notice**

1. The Password of entering calibration procedure is " **7377** ", then press **ENTER**.
2. Before calibrating the AC source, users should read the procedure in detail. Otherwise, it may lose some data in memory because of improper operation.

The display changes to CALIBRATION CHOICE PAGE as below after keying the right password.

CALIBRATION CHOICE = 1_ [CALIB]

1. V OUT AND MEAS. 2. I MEAS.

3. EXT Vref.

V OUT AND MEAS.: output voltage and voltage measurement accuracy calibration.

I MEAS.: current measurement accuracy calibration.

EXT Vref.: external Vref calibration.

4.2.1 Output Voltage & Voltage Measurement Calibration

Users can enter CALIBRATION CHOICE page after pressing password, see 4.2. Then, press **1**, **ENTER**, to do the output voltage and voltage measurement calibration.

CALIBRATION CHOICE = 1
 1. V OUT AND MEAS. 2. I MEAS.
 3. EXT V.

Please Remove Load Before Calibrating
 Press <ENTER> to start

1. V OUT AND MEAS. ACCURACY CALI 150V RNG
 A. KEYIN THE MEASURED Vdc
 Vdc offset = _ mV

In this step A of V OUT AND MEAS. ACCURACY CALI, the user should key in the AC source's DC output voltage measured by digital voltage meter (DVM) in mV. Then, monitor the reading of DVM, key in the DC output voltage repeatedly until DC output is less than ± 10 mV.

 **Notice**

- 1. The Vdc offset may be positive or negative. The positive of DVM connect to the Line of AC source output, and the negative of DVM connect to the Neutral of AC source output. See *Figure 4-1*.
- 2. The load must be off at all steps of V OUT AND MEAS. ACCURACY CALI.

Then press **SHIFT**, then  to change to next step.

1. V OUT AND MEAS. ACCURACY CALI 150V RNG
 B. WAIT TWO SECONDS THEN (ENTER)
 Vac = 0.00 V Vdc = 0.00 V

In this step B of V OUT AND MEAS. ACCURACY CALI., the display shows the offset of Vac and Vdc measured by AC source. They are produced by internal components. Wait two seconds then press **ENTER**, then Vac = 0.00, Vdc = 0.00 .

 **Notice**

- The AC source calibration steps are allowed to do individually, but it is better to follow the calibration procedure step by step (step A, step B ...). Or it may cause output and measurement errors.

Then press **SHIFT**, then **▼** to change to next step.

1. V OUT AND MEAS. ACCURACY CALI 150V RNG
C. (ENTER) THEN CHECK OUTPUT IS 15VAC
D. (ENTER) THEN KEYIN DVM MEAS. 150VAC ▲
0.00_ V ▼

In above step C of V OUT AND MEAS. ACCURACY CALI., the user should not turn on the load. Press **ENTER**, then check the output voltage measured by DVM is about 15VAC. This step is just to make sure the connection is correctly.

Then go to next step D. Press **ENTER**, check the output voltage measured by DVM is about 150VAC. Keyin the exact value measured by DVM, then press **ENTER**.

Then press **SHIFT**, then **▼** to change to next step.

1. V OUT AND MEAS. ACCURACY CALI 300V RNG
E. (ENTER) THEN CHECK OUTPUT IS 30VAC
F. (ENTER) THEN KEYIN DVM MEAS. 300VAC ▲
0.00_ V

In above step E of V OUT AND MEAS. ACCURACY CALI., the user should not turn on the load. Press **ENTER**, then check the output voltage measured by DVM is about 30VAC. This step is just to make sure the connection is correctly.

Then go to next step F. Press **ENTER**, check the output voltage measured by DVM is about 300VAC. Key in the exact value measured by DVM, then press **ENTER**.

Step F is the final step of V OUT AND MEAS. ACCURACY CALI. Press **PAGE/EXIT** to exit that page. Then display will show as below. Press **ENTER** to save the calibration results.

Press (ENTER) to save.
Press (PAGE/EXIT) not to save.

 **Notice**

1. Users can press **PAGE/EXIT** to exit to the calibration choice page at every step.
2. See the above display, if press **PAGE/EXIT** not to save the result, the result of calibration still works, until turn the power off.

4.2.2 Current Measurement Calibration

Users can enter CALIBRATION CHOICE page after pressing password, see 4.2. Then, press **2**, **ENTER**, to do the current measurement calibration.

CALIBRATION CHOICE = 2
 1. V OUT AND MEAS. 2. I MEAS.
 3. EXT Vref.

1. CURRENT MEAS. ACCURACY CALI 150V RNG
A. WAIT TWO SECONDS THEN (ENTER)

 lac = 0.00 A ldc = 0.00 A ▼

In above step A of CURRENT MEAS. ACCURACY CALI., the display shows the offset of lac and ldc measured by AC source. They are produced by internal components. Wait two seconds then press **ENTER**, then lac = 0.00A, ldc = 0.00A.

Then press **SHIFT**, then ▼ to change to next step.

1. CURRENT MEAS. ACCURACY CALI 150V RNG
 B. (ENTER) THEN CHECK CURRENT IS 1.6A
 C. (ENTER) THEN KEYIN CURRENT MEAS. 16A
 0.00 A ▲

In above step B of CURRENT MEAS. ACCURACY CALI., press **ENTER** then AC source will output 12.5VAC. The user should apply suitable load to output, to make the output current measured by current meter (or power analyzer) be about 1.6A (for 61604). The different model shows different current value in display. If the output current is ok after applying load, press **ENTER**, then AC source will output 125VAC. The output current will be 10 times of step B, 16A. Key in the exact value of current measured by current meter. The output current of step B. and step C. are shown as below:

Model	Step B.	Step C.
61601 (500 VA)	0.4 A	4 A
61602 (1000 VA)	0.8 A	8 A
61603 (1500 VA)	1.2 A	12 A
61604 (2000 VA)	1.6 A	16 A

Step C is the final step of CURRENT MEAS. ACCURACY CALI. Press **PAGE/EXIT** to exit that page. Then display will show as below. Press **ENTER** to save the calibration result.

Press (ENTER) to save .
Press (PAGE/EXIT) not to save .

 **Notice**

1. The resistance of applied load must be constant, so that the load current is proportional to output voltage. If not, the step B of CURRENT MEAS. ACCURACY is insignificant. Users only need to meet the current of step C. When output voltage is 125VAC.
2. When doing the procedure of calibration, the protection is removed temporarily. It may cause damage of AC source if applying unsuitable load.

4.2.3 External Vref Calibration

Users can enter CALIBRATION CHOICE page after pressing password (see 4.2). Then, press **3**, **ENTER**, to do the external Vref calibration. See details as below. It is not necessary to do this item if no option board (GPIB, RS-232 and Vref board) is installed.

CALIBRATION CHOICE = 3
1. V OUT AND MEAS. 2. I MEAS.
3. EXT Vref.

Please Remove Load Before Calibrating

Press <ENTER> to start

3. EXTERNAL Vref CALI 150V RANGE
A. Vref INPUT SHORT
WAIT TWO SECONDS THEN (ENTER)
Vdc = 0.00 V

In above step A of EXTERNAL Vref CALI., short the external Vref input terminal to make input is 0V, then the display shows the measured Vdc from AC source. They are offset voltages produced by internal components. Wait two seconds then press **ENTER**, then Vdc = 0V.

Then press **SHIFT**, then **▼** to change to next step.

3. EXTERNAL Vref CALI	150V RANGE
B. INPUT EXT. V 5VDC - WAIT TWO SECOND	
KEYIN EXT. V DVM MEAS.	
0.000_ VDC	(ENTER) ▲

In above step B of EXTERNAL Vref CALI., the user apply +5Vdc to Vref BNC connector from outer DC source. Check the output voltage of AC source is about 106Vdc, then keyin the exact value of input Vref voltage (not AC source output) measured from DVM.

Step B is the final step of EXTERNAL Vref CALI. Press **PAGE/EXIT** to exit that page. Then display will show as below. Press **ENTER** to save the calibration result.

Press (ENTER) to save. Press (PAGE/EXIT) not to save.
--

5. Theory of Operation

5.1 General

The AC source consists of 9 print circuit boards and other components. Each of the PCBs has its specific function that will be described in the following subsection.

5.2 Description of Overall System

Figure 5-1 shows the overall system. Main power flows through the A/D, D/D, D/A power stage converter. The A/D power stage is designated as I board, and generates DC voltage from the line input. The DC voltage of A/D output is applied to the D/D power stage. The G board of D/D stage takes power from the A/D output. It generates two isolated DC outputs for D/A power stage. The H board of D/A inverter generates AC output through full bridge controlled by B board. The D/A power stage is through G board relays in parallel or series control to obtain more current and higher voltage.

B board is identified as DSP processor and D/A controller. The DSP processor is applied to control output frequency and voltage, to measure voltage and current through G board, to perform remote control through GPIB, RS-232C or EXT Vref interface on Optional E board, to respond TTL signals through D board. A board is identified as user interface controller. It scans front panel keys through K board, and sends settings and measurement messages on LCD module.

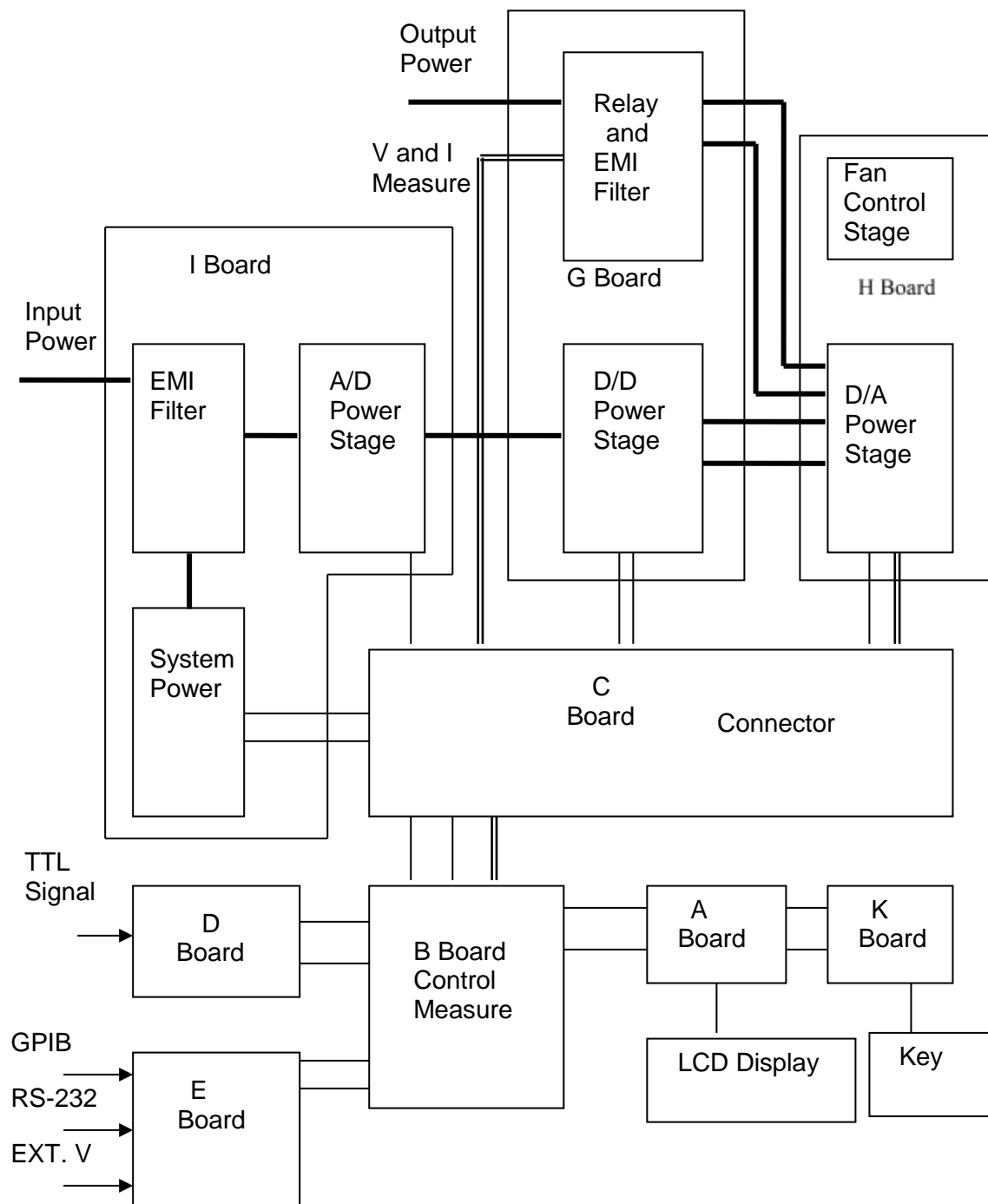

Figure 5-1

6. Self Test & Troubleshooting

6.1 General

This section describes the self test steps and suggested troubleshooting procedures when AC source does not function normally. If the problem cannot be solved using the information given here, consult the distributor whom you purchased the unit.

6.2 Self-test

When power-on the AC source, it performs a series of self-test. Firstly, it does the memory, data and communication self-test. They contain three items: DISPLAY, WAVEFORM, and REMOTE. If any failure is detected on a certain item, an "error code" will be shown at the right side of that item. The following table shows all the error messages:

Error Code	Description	Remark
Bit 0	SRAM error	0 – OK, 1 - ERROR
Bit 1	CODE error	0 – OK, 1 – ERROR
Bit 2	DATA error	0 – OK, 1 – ERROR
Bit 3	Communication error	0 – OK, 1 - ERROR
Bit 4	Output test result	0 – OK, 1 – ERROR
Bit 5	Reserved	
Bit 6	Reserved	
Bit 7	Reserved	

Example: If error code shows " ERROR = 05 ", the error code in binary is "00000101". The bit 0 and bit 2 are "1". So " ERROR = 05 " means SRAM error and DATA error occurs.

Error message	Description	Action
SRAM error	SRAM test fail.	Consult your dealer for assistance.
CODE error	Program code test fail.	Consult your dealer for assistance.
DATA error	Data in Flash or EEPROM test fail.	Consult your dealer for assistance.
Communication error	Can not communicate.	1. Power off the AC source, wait three seconds, power on again. 2. Consult your dealer for assistance.

After the memory, data and communication self test, the AC source does the power output self test. In this procedure, the output relays are in OFF state to sure not harming the load connecting on output terminal. Then, the AC source will check if there is any protection signal sent from hardware. If it does, the display shows "Output self test <NG>". It means the AC source is abnormal. Press **ENTER** to see what protection condition is. If no protection signal, the AC source will program 300Vac and measure the voltage. If the measured voltage is over $300V \pm 5V$, the power self-test is failed, and the display also shows "Output self test <NG> ". Probably AC source has not been calibrated (updated the software especially). Users can do following steps to reassure.

1. Press **ENTER** to ignore the NG.
2. If no PROTECTION, press **PAGE/EXIT** to change to MAIN PAGE.
3. Program a small voltage as 10Vac then press **OUT/QUIT**, see the measurement from LCD display if V is about 10V or not.

If the reading of V is about 10V, the AC source needs to calibrate (see *Chapter 4*). If the reading does not change apparently or show an unreasonable value, or display shows PROTECTION, the AC source does have some problems. Consult your dealer for assistance.

6.3 Troubleshooting

The following table lists the operating problems and suggests corrective actions:

Problem	Reason	Solution
Poor measurement of V, I.	Aging of components result in deviation of characteristics.	Periodic calibration is required. Refer to <i>Chapter 4</i> . Calibration.
Distorted output	<ol style="list-style-type: none"> 1. The AC source output voltage is too low. 2. The rectified load is too large at high frequency. 	<ol style="list-style-type: none"> 1. Program higher output voltage. 2. Reduce the load or lower the output frequency.
OVER TEMP protection (OTP)	<ol style="list-style-type: none"> 1. Ambient temperature is too high. 2. Air way is obstructed. 	<ol style="list-style-type: none"> 1. Operate the unit 0 ~ 40°C 2. Unblock the air way.
OVER POWER protection (OPP)	The output power is over specification.	Remove the over power or lower down output voltage.
OVER CURRENT protection (OCP)	The output current is over specification or I LIMIT.	Remove the overload or relax the I LIMIT.
OUTPUT SHORT protection	<ol style="list-style-type: none"> 1. The output is shorted. 2. External current reverse. 	<ol style="list-style-type: none"> 1. Remove the short. 2. Remove the load.
INPUT FAIL protection (UVP)	The AC source line input voltage is too low or too high.	Measure input voltage, and regulate it if it's over specification.
INT _ AD protection	<ol style="list-style-type: none"> 1. Line input voltage cycle dropout. 2. Instant over current of output. 3. AD power stage damaged. 	<ol style="list-style-type: none"> 1. Check the stability of input voltage. 2. Remove the load. 3. If cannot reset the status of protection, consult the dealer for assistance.
INT _ DD protection	<ol style="list-style-type: none"> 1. Line input voltage cycle dropout. 2. Instant over current of output. 3. DD power stage damaged. 	<ol style="list-style-type: none"> 1. Check the stability of input voltage. 2. Remove the load. 3. If cannot reset the status of protection, consult the dealer for assistance.
OUTPUT OVP protection	<ol style="list-style-type: none"> 1. Remote sense is open. 2. Output voltage peak is over range. 	<ol style="list-style-type: none"> 1. Connect the output to remote sense terminals. 2. Check the settings of Vac and Vdc on MAIN PAGE.
Cannot control AC source by GPIB	<ol style="list-style-type: none"> 1. The AC source unit address is incorrect. 2. GPIB cable is loose at rear. 	<ol style="list-style-type: none"> 1. Update address. 2. Check connection, tighten the screws.

7. Remote Operation

7.1 General Information

The AC source can be controlled remotely through the GPIB or the RS-232C port. The GPIB port is mostly used, but the RS-232C port is helpful too.

Technically speaking, the GPIB interface is quite different from the RS-232C interface. The GPIB interface is an 8-bit parallel data bus owning a host of bus commands for synchronization, and up to one Megabyte transfer rate. The RS-232C interface, a series bus with a few handshake lines for synchronization, is less capable, so its requirement is not so much, and the user can write a simple program to do basic remote control easily.

7.1.1 Setting the GPIB Address & RS-232C Parameters

The AC source is shipped with the GPIB address which is set at 30. The address can be only changed from the "CONF" functional list menu (please refer to 3.6.4). This menu is also used to select the RS-232C interface, and specify the parameters of RS-232C such as baud rate and parity.

7.1.2 Wire Connection of RS-232C

The AC source is shipped with the baud rate which is set at 19200, and with parity which is set as None. For RS-232C interface, only the signals of TxD and RxD are used for its transfer of data. The RS-232C connector is a 9-pin D subminiature female connector. The following table describes the pins and signals of RS-232C connector.

Pin No.	Input/Output	Description
1	---	No connection
2	OUTPUT	TxD
3	INPUT	RxD
4	---	No connection
5	---	GND
6	---	No Connection
7	---	No Connection
8	---	No Connection
9	---	No connection

Interconnection between the computer (compatible with IBM PC) and the AC source is illustrated below:

PIN	IBM PC	AC Source
1	DCD	No Connection
2	RX ←	TX
3	TX →	RX
4	DTR	No Connection
5	GND	GND
6	DSR	No Connection
7	RTS	No Connection
8	CTS	No Connection
9	RI	No Connection

7.2 The GPIB Capability of the AC Source

GPIB Capability	Description	Interface Functions
Talker/Listener	Commands and response messages can be sent and received over the GPIB bus. Status information can be read using a series poll.	AH1, SH1, T6, L4
Service Request	The AC source sets the SRQ line true if there is an enabled service request condition.	SR1
Remote/Local	The AC source powers up in local state. In local state, the front panel is operative, and the AC source responds to the commands from GPIB. In remote state*, all front panel keys except the "<PAGE/EXIT>" key are disabled. Press "<PAGE/EXIT>" key to return the AC source to local state.	RL1

*Remote State:

The panel shows remote message on the LCD display as below:

Vac = 0.0	F = 60.00	Vdc = 0.0	R H
V = 0.00	F = 0.00	I = 0.00	▲
P = 0.0	PF = 0.000	CF = 0.00	▼

There is an "R" on right up side of LCD display to indicate the AC source is in remote state. In remote state, all front panel keys except the "<PAGE/EXIT>" key are disabled. Press the "<PAGE/EXIT>" key to return the AC source to the local state.

7.3 Introduction to Programming

All commands and response messages are transferred in form of ASCII codes. The response messages must be read completely before a new command is sent, otherwise the remaining response messages will be lost, and a query interrupt error will occur.

7.3.1 Conventions

Angle brackets	<	>	Items in angle brackets are parameter abbreviations.
Vertical bar			Vertical bar separates alternative parameters.
Square brackets	[]	Items in square brackets are optional. For example, OUTP [: STATE] means that : STATE may be omitted.
Braces	{	}	Braces indicate the parameters that may be repeated. The notation <A> {<, B>} means that parameter "A" must be entered while parameter "B" may be omitted or entered once or more times.

7.3.2 Numerical Data Formats

All data programmed to or returned from the AC source are ASCII. The data can be numerical or character string.

Numerical Data Formats

Symbol	Description	Example
NR1	It is a digit with no decimal point. The decimal is assumed to be at the right of the least significant digit.	123, 0123
NR2	It is a digit with a decimal point.	12.3, .123
NR3	It is a digit with a decimal point and an exponent.	1.23E+2

7.3.3 Boolean Data Format

The Boolean parameter <Boolean> takes only the form ON|OFF.

7.3.4 Character Data Format

The character strings returned by query command may take either of the following forms:

<CRD>	Character Response Data: character string with maximum length of 12.
<SRD>	String Response Data: character string.

7.3.5 Basic Definition

Command Tree Table:

The commands of the AC source are based on a hierarchical structure, also known as a tree system. In order to obtain a particular command, the full path to that command must be specified. This path is represented in the table by placing the highest node in the farthest left position of the hierarchy. Lower nodes in the hierarchy are indented in the position to the right, below the parent node.

Program Headers:

Program headers are key words that identify the command. They follow the syntax described in subsection 7.6 of IEEE 488.2. The AC source accepts characters in both upper and lower case without distinguishing the difference. Program headers consist of two distinctive types, common command headers and instrument-controlled headers.

Common Command and Query Headers:

The syntax of common command and query headers is described in IEEE 488.2. It is used together with the IEEE 488.2-defined common commands and queries. The commands with a leading “ * ” are common commands.

Instrument-Controlled Headers:

Instrument-controlled headers are used for all other instrument commands. Each of them has a long form and a short form. The AC source only accepts the exact short and long forms. A special notation will be taken to differentiate the short form header from the long one of the same header in this subsection. The short forms of the header are shown in characters of upper case, whereas the rest of the headers are shown in those of lower case.

Program Header Separator (:):

If a command has more than one header, the user must separate them with a colon (FETC:CURR?, VOLT:DC 10). Data must be separated from program header by one space at least.

Program Message:

Program message consists of a sequence of zero or more elements of program message unit that is separated by separator elements of program message unit.

Program Message Unit:

Program message unit represents a single command, programming data, or query.

Example: `FREQ?, OUTPut ON.`

Program Message Unit Separator (;):

The separator (semicolon ;) separates the program message unit elements from one another in a program message.

Example: `VOLT:AC 110 ; FREQ 120<PMT>`
Program Message Terminator (<PMT>):

A program message terminator represents the end of a program message. Three permitted terminators are:

- (1) <END>: end or identify (EOI)
- (2) <NL>: new line which is a single ASCII-encoded byte 0A (10 decimals).
- (3) <NL> <END>: new line with EOI.

Note The response message is terminated by <NL> <END> for GPIB, and <NL> for RS-232C.

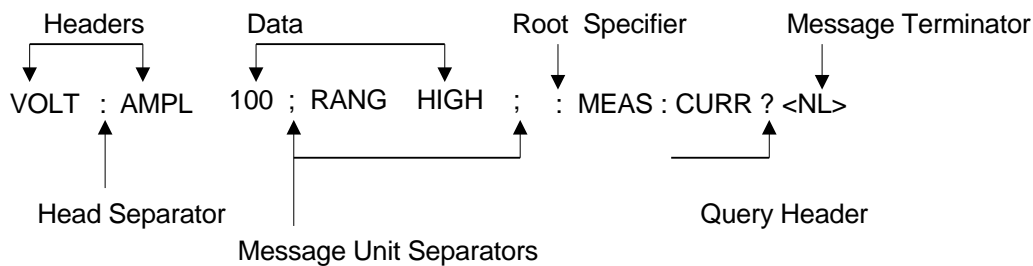

Figure 7-1 The Structure of Command Message

7.4 Traversal of the Command Tree

Multiple program message unit elements can be sent in a program message. The first command is always referred to the root node. Subsequent commands are referred to the same tree level as the previous command in a program message. A colon preceding a program message unit changes the header path to the root level.

Example:

OUTPut : PROTection : CLear	All colons are header separators.
: OUTPut : PROTection : CLear	Only the first colon is a specific root.
OUTPut : PROTection : CLear; : VOLT : AC 100	Only the third colon is a specific root.

7.5 Execution Order

The AC source executes program messages by the order received. Program message units except coupled commands are executed in order of reception. The execution of coupled commands is deferred until program message terminator is received. A coupled command sets parameters which are affected by the setting of other commands. Problems may arise, because the prior state of the AC source will affect the response of a coupled parameter to its programming.

For example, assume that the current output voltage range is LOW, a new state is desired with output voltage range HIGH, and amplify 220 Volt. If the commands

```
VOLTage : AC          220<PMT>
VOLTage : RANGE     HIGH<PMT>
```

are sent, data out of range error will be produced. Such kind of error can be avoided by reversing the order, or sending the commands in one program message. For the above

example, the program message

VOLTage : AC 220 ; VOLTage : RANGE HIGH<PMT>

can be sent without error.

7.6 The Commands of the AC Source

This subsection is going to talk about the syntax and parameters for all commands of the AC source. The examples given for each command are generic.

Syntax Forms	Definitions of syntax are in long form headers, whereas only short form headers appear in examples.
Parameters	Most commands require a parameter.
Return Parameters	All queries return a parameter.
Models	If a command is merely applied to specific models, these models will be listed in the Model only entry. If there is no Model only entry, the command will be applied to all models.

7.6.1 Common Command Dictionary

Common commands begin with a “ * ”, and consist of three letters and/or one “ ? ” (query). Common commands and queries are listed alphabetically.

*CLS	Clear status This command clears the following registers (1) Questionable Status Event (2) Status Byte (3) Error Queue
*ESE<n>	Standard event status enabled This command programs the Standard Event register bits. If one or more of the enabled events of the Standard Event register is set, the ESB of Status Byte Register is set too.

Bit Configuration of Standard Event Status Enabled Register

Bit Position	7	6	5	4	3	2	1	0
Bit Name	PON	---	CME	EXE	DDE	QYE	---	OPC
CME = Command error				DDE = Device-dependent error				
EXE = Execution error				OPC = Operation complete				
PON = Power-on				QYE = Query error				

*ESE?	Return standard event status enabled The query reads the Standard Event Status Event register. Reading of the register clears it. The bits of configuration are the same as Standard Event Status Enabled Register.
-------	--

- *IDN? Return the AC source identification string
Return Parameter Chroma ATE, 61600,123456,1.00,1.01,1.02
Chroma ATE : Company name
61600 : Model name
123456 : Serial number
1.00, 1.01,1.02 : Firmware version of display, waveform and remote
- *RCL<n> Restore the values of the specific group which is previously stored in memory. It's better to wait about 18 seconds to send the next command.
Parameter 1 - 3
- *RST This command resets the AC source to the initial states. It's better to wait about 18 second to send the next command.
- *SAV<n> Save the values into the specific group in memory. It's better to wait about 5 seconds to send the next command.
Parameter 1 - 3
- *SRE This command sets conditions of the Service Request Enabled Register. If one or more of the enabled events of the Status Byte Register is set, the MSS and RQS of Status Byte Register are set too.
- *SRE? This query returns the Service Request Enabled Register.
- *STB? This query returns the Status Byte Register.

Bit configuration of Status Byte Register

Bit Position	7	6	5	4	3	2	1	0
Condition	--	MSS RQS	ESB	MAV	QUES	--	--	--

ESB = event status byte summary
 QES = questionable status summary
 RQS = request for service
 MSS = master status summary
 MAV = message available

- *TST? This command queries the self-test result of the AC source.

7.6.2 Instrument Command Dictionary

The commands are listed in alphabetical order. Commands followed by question marks (?) take only the query forms. When commands take both the command and query forms, they are noted in the query syntax descriptions.

7.6.2.1 FETCH & MEASURE Sub-system

FETCh | MEASure

[: SCALar]	
: CURRent	
: AC?	Query the rms current
: DC?	Query the DC current level
: AMPLitude : MAXimum?	Query the peak current
: CRESfactor?	Query the current crest factor
: INRush	Query the inrush current
: FREQuency?	Query the frequency
: POWer	
: AC	
[: REAL]?	Query the true power
: APParent?	Query the apparent power
: REACTive	Query the reactive power
: PFACTor?	Query the power factor
: VOLTage	
: ACDC?	Query the rms voltage
: DC?	Query the DC voltage

This command lets the user get measurement data from the AC source. Two measurement commands are available: MEASure and FETCh. MEASure triggers the acquisition of new data before returning data. FETCh returns the previously acquired data from measurement buffer.

FETCh [: SCALar] : CURRent : AC?

MEASure [: SCALar] : CURRent : AC?

Description	: These queries return the rms current which is being output at the output terminal.
Query Syntax	: FETCh : CURRent : AC?, MEASure : CURRent : AC?
Return Parameters	: <NR2>

FETCh [: SCALar] : CURRent : AMPLitude : MAXimum?

MEASure [: SCALar] : CURRent : AMPLitude : MAXimum?

Description	: These queries return the absolute value of peak current.
Query Syntax	: FETCh : CURRent : AMPLitude : MAXimum?, MEASure : CURRent : AMPLitude : MAXimum?
Return Parameters	: <NR2>

FETCh [: SCALar] : CURRent : CRESfactor?

MEASure [: SCALar] : CURRent : CRESfactor?

Description	: These queries return the output current crest factor. It is the ratio of peak output current to rms output current.
Query Syntax	: FETCh : CURRent : CRESfactor? MEASure : CURRent : CRESfactor?
Return Parameters	: <NR2>

FETCh [: SCALar] : FREQuency?

MEASure [: SCALar] : FREQuency?

Description	: These queries return the output frequency in Hertz.
Query Syntax	: FETCh : FREQuency? MEASure : FREQuency?

Return Parameters : <NR2>

FETCh [: SCALAr] : POWer : AC [: REAL] ?

MEASure [: SCALAr] : POWer : AC [: REAL] ?

Description : These queries return the true power which is being output at output terminals in watts.

Query Syntax : FETCh : POWer : AC?
MEASure : POWer : AC?

Return Parameters : <NR2>

FETCh [: SCALAr] : POWer : AC : APParent?

MEASure [: SCALAr] : POWer : AC : APParent?

Description : These queries return the apparent power which is being output at output terminals in volt-amperes.

Query Syntax : FETCh : POWer : AC : APParent?
MEASure : POWer : AC : APParent?

Return Parameters : <NR2>

FETCh [: SCALAr] : POWer : AC : REACTive?

MEASure [: SCALAr] : POWer : AC : REACTive?

Description : These queries return the reactive power which is being output at output terminals in volt-amperes. Reactive power is

computed as: $VAR = \sqrt{APPARENTPOWER^2 - REALPOWER^2}$

Query Syntax : FETCh : POWer : AC : REACTive?
MEASure : POWer : AC : REACTive?

Return Parameters : <NR2>

FETCh [: SCALAr] : POWer : AC : PFACTor?

MEASure [: SCALAr] : POWer : AC : PFACTor?

Description : These queries return the power factor which is being output at output terminals. Power factor is computed as:

$PF = TRUE\ POWER / APPARENT\ POWER$

Query Syntax : FETCh : POWer : AC : PFACTor?
MEASure : POWer : AC : PFACTor?

Return Parameters : <NR2>

FETCh [: SCALAr] : VOLTage : ACDC?

MEASure [: SCALAr] : VOLTage : ACDC?

Description : These queries return the rms voltage which is being output at the output terminals.

Query Syntax : FETCh [: SCALAr] : VOLTage : ACDC?
MEASure [: SCALAr] : VOLTage : ACDC?

Return Parameters : <NR2>

FETCh [: SCALAr] : VOLTage : DC?

MEASure [: SCALAr] : VOLTage : DC?

Description : These queries return the DC composition of output voltage which is being output at the output terminals.

Query Syntax : FETCh [: SCALAr] : VOLTage : ACDC?
MEASure [: SCALAr] : VOLTage : ACDC?

Return Parameters : <NR2>

7.6.2.2 OUTPUT Sub-system

OUTPut

[: STATe]
 : RELay
 : SLEW
 : VOLTage
 : AC
 : DC
 : FREQuency
 : OUT
 : COUPle
 : PROTection
 : CLear
 OPTIon
 : HV

OUTPut [: STATe]

Description : This command enables or disables the output of the AC source.
 Query Syntax : OUTPut [: STATe]?
 Parameters : OFF | ON
 Return Parameters : OFF | ON

OUTPut : RELay

Description : This command sets output relay on or off.
 Query Syntax : OUTPut : RELay?
 Parameters : OFF | ON, ON sets the output relay of the AC source on (closed). OFF sets the output relay of the AC source off (open).
 Return Parameters : OFF | ON

OUTPut : SLEW : VOLTage : AC

Description : This command sets the slew rate of the AC output voltage.
 Query Syntax : OUTPut : SLEW : VOLTage : AC?
 Parameters : <NR2>, valid range: 0.000V/ms ~ 1200.000V/ms
 Return Parameters : <NR2>

OUTPut : SLEW : VOLTage : DC

Description : This command sets the slew rate of the DC composition voltage.
 Query Syntax : OUTPut : SLEW : VOLTage : DC?
 Parameters : <NR2>, valid range: 0.000V/ms ~ 1000.000V/ms
 Return Parameters : <NR2>

OUTPut : SLEW : FREQuency

Description : This command sets the slew rate of the output frequency.
 Query Syntax : OUTPut : SLEW : FREQuency?
 Parameters : <NR2>, valid range: 0.000 Hz/ms ~ 1000.000Hz/ms
 Return Parameters : <NR2>

OUTPut : SLEW : OUT

Description : This command enables or disables the output slew rate when user runs **OUT** of AC source.
 Query Syntax : OUTPut : SLEW : OUT?

Parameters : ON | OFF
 Return Parameters : ON | OFF

OUTPut : COUPling

Description : This command selects the couple setting of the output signal.
 Query Syntax : OUTPut : COUPling?
 Parameters : AC | DC | ACDC
 Return Parameters : AC | DC | ACDC

OUTPut : PROTEction : CLear

Description : This command clears the latch that disables the output when an overcurrent (OC), overtemperature (OT), overpower (OP) or remote inhibit (RI) is detected. All conditions which have generated the fault must be removed before the latch is cleared.
 Query Syntax : None
 Parameters : None
 Return Parameters : None

OUTPut : OPTIon : HV

Description : This command sets the high voltage output option state.
 Query Syntax : OUTPut : OPTIon : HV?
 Parameters : NONE | A615003
 Return Parameters : NONE | A615003

7.6.2.3 SOURCE Sub-system**[SOURce :]**

CURRent
 : LIMit
 : DELay
 : INRush
 : STARt
 : INTerval
 FREQency
 [: {CW | IMMEDIATE}]
 VOLTage
 [: LEVel][: IMMEDIATE][:AMPLitude]
 : AC
 : DC
 : LIMit
 : AC
 : DC
 : PLUS
 : MINus
 : RANGE

[SOURce :] CURRent : LIMit

Description : This command sets the rms current limit of the AC source for software protection.
 Query Syntax : [SOURce :] CURRent : LIMit?
 Parameters : <NR2>, valid range: 0.00 ~ maximum current spec. of the

Return Parameters : specific model. (unit: A)
: <NR2>

[SOURce :] CURRent : DELay

Description : This command sets the delay time for triggering over current protection.
Query Syntax : [SOURce :] CURRent : DELay?
Parameters : <NR2>, valid range: 0.0 ~ 5.0 (unit: 0.5 second)
Return Parameters : <NR2>

[SOURce :] CURRent : INRUsh : START

Description : This command sets the start time of the inrush current measurement.
Query Syntax : [SOURce :] CURRent : INRUsh : START?
Parameters : <NR2>, valid range: 0.0 ~ 999.9 (unit: ms)
Return Parameters : <NR2>

[SOURce :] CURRent : INRUsh : INTerval

Description : This command sets the measuring interval of the inrush current measurement.
Query Syntax : [SOURce :] CURRent : INRUsh : INTerval?
Parameters : <NR2>, valid range: 0.0 ~ 999.9 (unit: ms)
Return Parameters : <NR2>

[SOURce :] FREQuency [: {CW | IMMEDIATE}]

Description : The command sets the frequency of the output waveform of the AC source in Hz.
Query Syntax : [SOURce :] FREQuency [: {CW | IMMEDIATE}]?
Parameters : <NR2>, valid range: 15.00 ~ 1000.00 (unit: Hz)
Return Parameters : <NR2>

[SOURce :] VOLTage [: LEVel][: IMMEDIATE][: AMPLitude] : AC

Description : This command sets the AC composition of output voltage in Volts.
Query Syntax : [SOURce :] VOLTage [: LEVel][: IMMEDIATE][: AMPLitude] : AC?
Parameters : <NR2>, valid range: 0.0 ~ 150.0 (in low range), 0.0 ~ 300.0 (in high range)
Return Parameters : <NR2>

[SOURce :] VOLTage [: LEVel][: IMMEDIATE][: AMPLitude] : DC

Description : This command sets the DC composition of output voltage in Volts.
Query Syntax : [SOURce :] VOLTage [: LEVel][: IMMEDIATE][: AMPLitude] : DC?
Parameters : <NR2>, valid range: -212.1 ~ 212.1 (in low range), -424.2 ~ 424.2 (in high range)
Return Parameters : <NR2>

[SOURce :] VOLTage : LIMit : AC

Description : This command sets the setting of Vac LIMIT which will restrict the value of Vac.
Query Syntax : [SOURce :] VOLTage : LIMit : AC?
Parameters : <NR2>, valid range: 0.0 ~ 300.0 (unit: V)

Return Parameters : <NR2>

[SOURce :] VOLTage : LIMit : DC : PLUS

Description : This command sets the setting of Vdc LIMIT(+) which will restrict the value of Vdc.

Query Syntax : [SOURce :] VOLTage : LIMit : DC : PLUS?

Parameters : <NR2>, valid range: 0.0 ~ 414.2 (unit: V)

Return Parameters : <NR2>

[SOURce :] VOLTage : LIMit : DC : MINus

Description : This command sets the setting of Vdc LIMIT(-) which will restrict the value of Vdc.

Query Syntax : [SOURce :] VOLTage : LIMit : DC : MINus?

Parameters : <NR2>, valid range: 0.0 ~ -414.2 (unit: V)

Return Parameters : <NR2>

[SOURce :] VOLTage : RANGE

Description : This command sets output voltage range with four options of LOW(150 V), HIGH(300 V), AUTO or HV(600 V).

Query Syntax : [SOURce :] VOLTage : RANGE?

Parameters : LOW | HIGH | AUTO | HV

Return Parameters : LOW | HIGH | AUTO | HV

7.6.2.4 CONFIGURE Sub-system

[SOURce :]

CONFigure
: INHibit
: EXTernal
: COUPling

[SOURce :] CONFigure : INHibit

Description : This command sets REMOTE INHIBIT state. There are three states for the features of remote inhibit: OFF, LIVE, and TRIG.

Query Syntax : [SOURce :] CONFigure : INHibit?

Parameters : OFF | LIVE | TRIG

Return Parameters : OFF | LIVE | TRIG

[SOURce :] CONFigure : EXTernal

Description : This command enables or disables the external controlled analog signal input from external devices.

Query Syntax : [SOURce :] CONFigure : EXTernal?

Parameters : OFF | ON

Return Parameters : OFF | ON

[SOURce :] CONFigure : COUPling

Description : This command sets the coupling mode to present AC source output from external V reference: AC_AMPLIFIER and DC_LEVEL_CTL.

Query Syntax : [SOURce :] CONFigure : COUPling?

Parameters : AC | DC

Return Parameters : AC | DC

7.6.2.5 PHASE Sub-system

[SOURce :]

PHASe
: ON
: OFF

[SOURce :] PHASe : ON

Description : This command sets the transition angle of the waveform when it out. Default DEGREE ON is 0 degree.
Query Syntax : [SOURce :] PHASe : ON?
Parameters : <NR2>, valid range: 0.0 ~ 359.9
Return Parameters : <NR2>

[SOURce :] PHASe : OFF

Description : This command sets the transition angle of the waveform when it quit.
Query Syntax : [SOURce :] PHASe : OFF?
Parameters : <NR2>, valid range: 0.0 ~ 360.0, 360.0: mean is IMMED.
Return Parameters : <NR2>

7.6.2.6 STATUS Sub-system

STATus

: OPERation
[: EVENT]?
: ENABLE
: QUEStionable
: CONDition
: ENABLE
: NTRansition
: PTRansition

STATus : OPERation [: EVENT]?

Description : This command queries the Operation Status register.
Query Syntax : STATus : OPERation [: EVENT]?
Parameters : None
Return Parameters : Always zero.

STATus : OPERation : ENABLE

Description : This command sets the Operation Status Enable register. The register is a mask which enables specific bits from the Operation Status register.
Query Syntax : STATus : OPERation : ENABLE?
Parameters : <NR1>, valid range: 0 ~ 255
Return Parameters : Always Zero

STATus : QUEStionable : CONDition?

Description : This query returns the value of the Questionable Condition register, which is a read-only register that holds the real-time

questionable status of the AC source.
 Query Syntax : STATus : QUEStionable : CONDition?
 Parameters : NONE
 Return Parameters : <NR1>, valid range: 0 ~ 511

STATus : QUEStionable [: EVENT] ?

Description : This query returns the value of the Questionable Event register. The Event register is a read-only register which holds all events that are passed by the Questionable NTR and/or PTR filter. If QUES bit of the Service Request Enabled register is set, and the Questionable Event register > 0, QUES bit of the Status Byte register is set too.
 Query Syntax : STATus : QUEStionable [: EVENT]?
 Parameters : NONE
 Return Parameters : <NR1>, valid range: 0 ~ 511

STATus : QUEStionable : ENABLE

Description : This command sets or reads the value of the Questionable Enable register. The register is a mask which enables specific bits from the Questionable Event register to set the questionable summary (QUES) bit of the Status Byte register.
 Query Syntax : STATus : QUEStionable : ENABLE?
 Parameters : <NR1>, valid range: 0 ~ 65535
 Return Parameters : <NR1>

STATus : QUEStionable : NTRansition

Description : These commands make the values of the Questionable NTR register set or read.

These registers serve as polarity filters between the Questionable Enable and Questionable Event registers, and result in the following actions:

- * When a bit of the Questionable NTR register is set at 1, a 1-to-0 transition of the corresponding bit in the Questionable Condition register will cause that bit in the Questionable Event register to be set.
- * When a bit of the Questionable PTR register is set at 1, a 0-to-1 transition of the corresponding bit in the Questionable Condition register will cause that bit in the Questionable Event register to be set.
- * If the two same bits in both NTR and PTR registers are set at 0, no Transition of that bit in the Questionable Condition register can set the corresponding bit in the Questionable Event register.

Bit Configuration of Questionable Status Register

Bit Position	15-9	8	7	6	5	4	3	2	1	0
Condition	---	OVP	INP	OCP	FAN	SHT	OTP	OPP	INT-DD	INT-AD

OVP : Output Voltage protection
 INP : Line input protection.
 OCP : Over Current protection.
 FAN : Fan failure.
 SHT : Output short protection.

OTP : Over temperature protection.
 OPP : Over power protection.
 INT-DD : Inner DD power stage protection
 INT-AD : Inner AD power stage protection

Query Syntax : STATus : QUEStionable : NTRansition?
 Parameters : <NR1>, valid range: 0 ~ 65535
 Return Parameters : <NR1>

STATus : QUEStionable : PTRansition

Description : These commands make the values of the Questionable PTR register set or read. Please refer to the description of the previous command.
 Query Syntax : STATus : QUEStionable : PTRansition?
 Parameter : <NR1>, valid range: 0 ~ 511
 Return parameters : <NR1>

7.6.2.7 SYSTEM Sub-system

SYSTEM

: **ERRor?**
 : **VERsion?**
 : **LOCal**
 : **REMote**

SYSTEM : ERRor?

Description : This command queries the error string of the command parser.
 Query Syntax : SYSTem : ERRor?
 Parameters : NONE
 Return Parameters : Response error string:
 No Error
 Data Format Error
 Data Range Error
 Too Many Errors
 Execution Error

SYSTEM : VERsion?

Description : This query requests the AC source to identify itself.
 Query Syntax : SYSTem : VERsion?
 Parameters : NONE
 Return Parameters :

SYSTEM : LOCAl

Description : This command can only be used under the control of RS-232C. If SYST : LOC is programmed, the AC source will be set in the LOCAL state, and the front panel will work.
 Query Syntax : NONE
 Parameters : NONE
 Return Parameters : NONE

SYSTEM : REMote

Description : This command can only be used under the control of RS-232C.

If SYST : REM is programmed, the AC source will be set in the REMOTE state, and the front panel will be disabled except the "<PAGE/EXIT> key.

Query Syntax : NONE
 Parameters : NONE
 Return Parameters : NONE

7.6.2.8 SERIES Sub-system

SERIES : STATE

Description : This command sets the three phase mode of AC source.
 Query Syntax : SERIES : STATE?
 Parameters : OFF | SLAVE | MASTER
 Return Parameters : OFF | SLAVE | MASTER

INSTRUMENT : DEGREE

Description : This command sets the degree of three phase mode.
 Query Syntax : INSTRUMENT : DEGREE?
 Parameters : <NR2>, valid range: 0.0 ~ 359.9
 Return Parameters : <NR2>

7.7 Command Summary

Common Commands

* CLS Clear status
 * ESE<n> Standard event status enable
 * ESE? Return standard event status enable
 * IDN? Return the AC source identification
 * RCL<n> Recall the AC source file
 * RST Reset the AC source to the initial states
 * SAV<n> Save the AC source status
 * SRE Set request enable register
 * STB? Return status byte
 * TST? Return the self-test result of the AC source

Instrument Commands

FETCH | MEASURE

[: SCALAR]
 : CURRENT
 : AC?
 : DC?
 : AMPLITUDE : MAXIMUM?
 : CRESTFACTOR?
 : INRUSH
 : FREQUENCY?
 : POWER
 : AC
 [: REAL]?

: APParent?
: REACtive
: PFACtor?
:VOLTage
: ACDC?
: DC?

OUTPut

[: STATe]
: RELay
: SLEW
: VOLTage
: AC
: DC
: FREQuency
: OUT
:COUPling
:PROTection
: CLear
: OPTIon
:HV

[SOURce :]

CURRent
: LIMit
: DELay
: INRush
: START
: INTerval
FREQuency
[: {CW | IMMEDIATE}]
VOLTage
[: LEVel][: IMMEDIATE][: AMPLitude]
: AC
: DC
: LIMit
: AC
: DC
: PLUS
: MINus
: RANGE

[SOURce :]

PHASe
: ON
: OFF

[SOURce :]

CONFigure
: INHibit
: EXTeRnal
: COUPling

STATus

: OPERation
 [: EVENT]?
 : ENABle
: QUEStionable
 : CONDition
 : ENABle
 : NTRansition
 : PTRansition

SERies

: STATE

INSTrument

: DEGRee

Appendix A Pin Assignment of TTL Signal

9-Pin D-Type Male Connector:

Pin No.	Signal	Pin No.	Signal
1	GND	6	GND
2	/ Remote-Inhibit	7	GND
3	GND	8	/ FAULT-OUT
4	AC-ON	9	---
5	---		

/ Remote-Inhibit: When voltage level of this pin becomes LOW, it can inhibit the output of AC source (See 3.6.1).

AC-ON: When AC source output voltage, this pin will become HIGH, and it becomes LOW when quit output.

/ FAULT-OUT: The voltage level of this pin is HIGH if AC source is in normal state. It becomes LOW when AC source is in protection state.

Connecting the / FAULT-OUT signal of TTL PIN8 on AC Source rear panel to TTL PIN8 on A615003 rear panel as turning on the functions of A615003 thus it can be activated.



CHROMA ATE INC.

info@chromaate.com

www.chromaate.com