



4024 Series Spectrum Analyzer

User Manual





Approved UK Distributor for Ceyear

Visit: www.mcs-testequipment.com
Email: sales@mcs-testequipment.com
Call: 01492 550 398

MCS Test
New Vision Business Park
Glascoed Road
St Asaph
LL17 0LP

4024 Series Spectrum Analyzer

User Manual

AV2.731.1075SSCN

Verification of Conformity

Certificate No. : CTL1803263090-EC
Applicant : China Electronics Technology Instruments Co., Ltd
Address : NO.98, Xiangjiang Road, Huangdao District, Qingdao, China
Product : SPECTRUM ANALYZER
Trademark : 思仪 Ceyear
Model(s) : 4024A, 4024B, 4024C, 4021D, 4024E, 4024F, 4024G
Manufacturer : China Electronics Technology Instruments Co., Ltd
Address : NO.98, Xiangjiang Road, Huangdao District, Qingdao, China
Test Report : CTL1803263090-E

Complies with the requirements of the
EC EMC directive 2004/108/EC with amendments.
 Test Standards:

EN 61326-1: 2013
EN 61000-3-2: 2014
EN 61000-3-3: 2013

Remarks:

The **CE** markings as shown below can be affixed on the product after preparation of necessary conformity documentation, as stipulated in article 10 of the Council Directive 93/68/EEC.



Liang Qi

For Chief Executive
 Apr. 04, 2018



Shenzhen CTL Testing Technology Co., Ltd.

Add: Floor 1-A, Baisha Technology Park, No.3011, Shaheji Road, Nanshan District, Shenzhen, China 518055
 Tel: (86)0755-89486194 Web: www.ctl-lab.com E-mail: ctl@ctl-lab.com

Verification of Conformity

Certificate No. : CTL1803263090-SC
Applicant : China Electronics Technology Instruments Co.,Ltd
Address : NO.98, Xiangjiang Road, Huangdao District, Qingdao, China
Product : SPECTRUM ANALYZER
Trademark : 思仪 Ceyear
Model(s) : 4024A, 4024B, 4024C, 4024D, 4024E, 4024F, 4024G
Manufacturer : China Electronics Technology Instruments Co.,Ltd
Address : NO.98, Xiangjiang Road, Huangdao District, Qingdao, China
Test Report : CTL1803263090-S

Complies with the requirements of the
EC LVD directive 2014/35/EU

Test Standards:

EN 61010-1:2010

Remarks:

Based on the voluntary assessment of the product sample and technical file, we confirm that the above-mentioned product meets the requirements of the EC directive. The CE mark as show below can be used, under the responsibility of the manufacturer or the importer, after completion of an EC declaration of conformity and compliance with all relevant EC directives.



Liuyang Qi

For Chief Executive
April 28, 2018



Shenzhen CTL Testing Technology Co., Ltd.

Add: Floor 1--A, Baisha Technology Park, No.3011, Shaheji Road, Nanshan District, Shenzhen, China 518055

Tel: (86)0755-89486194 Web: www.ctl-lab.com E-mail: ctl@ctl-lab.com

Environment and Safety Instructions

I. Safety Protection

1. Safety precautions for the instrument

- 1) Adopt designated packing container during handling, prevent instrument from falling down or fierce collision which may result in damage;
- 2) Please do use the AC-DC adapter provided accompanying the instrument for power supply, or improper power adapter will cause damage to the instrument.
- 3) Supply power to instrument with 220V AC three-core stabilized voltage power, prevent damaging interior hardware due to high power spike pulse interference;
- 4) Ensure the good grounding of power supply as poor or wrong grounding may cause damage to the instrument.
- 5) Take anti-electrostatic measures in operation, such as anti-electrostatic straps, to prevent electrostatic damage to this instrument.
- 6) The DC signal above 16V and signal power above 30dBm are prohibited; otherwise, this instrument may be damaged.
- 7) The battery used for powering up this instrument or installed in this instrument should be replaced with one of the same type or recommended equivalent type; otherwise, explosion may occur.
- 8) It is not allowed to insert any solids into the instrument from opening of shell or pour any fluids into inside or outside of shell to prevent interior short circuit and/or electric shock, fire or personal injury.
- 9) To prevent this instrument from overheating, the slot or opening for internal ventilation must not be covered. It is prohibited to place the instrument in sofa, blanket or closed housing unless there is good ventilation.
- 10) It is prohibited to place this product onto heating equipment such as the heater or heating fan. The ambient temperature must not exceed the maximum temperature specified in this manual.
- 11) It is notable that when the instrument is in fire, toxic gas or liquid harmful to human being may be released.

2. Safety precautions for other instrument & equipment

- 1) Check the working condition and turn off RF output before connecting the instrument, otherwise it may output high power signal to damage the equipment to be tested;
- 2) The output power may be high in the self-test of this instrument. Please disconnect all external devices.
- 3) If the fault alarm is sent in operation of the spectrum analyzer, reminding the user of status anomaly, you should turn off the RF switch or power switch and disconnect all external devices, so as to prevent the influence on the tested equipment.

3. Personal safety precautions

- 1) It is requested to handle the instrument and packing container with proper tools and put them down gently to prevent from personal injury due to instrument falling.
- 2) Ensure that the power supply is well grounded, as poor or wrong grounding may result in personal injuries.
- 3) Get the instrument cut off before wiping to prevent electric shock; only wipe the outside of the instrument with dry or slightly wet soft cloth other than the inside.
- 4) Instrument operator should have received special training before using the product and should be highly focused during the using process. This instrument must be operated by physically and mentally appropriate person. Otherwise, person injury or property loss may be caused.
- 5) This instrument has potential risks of microwave radiation in the high-power status. Please take corresponding anti-radiation measures.

- 6) Prohibit using the instrument if the power line is found damaged. The power line should be checked on a regular basis. Take safety precautions appropriately and place power line properly to ensure the power line will not be damaged and personnel will not stumble over the power line or be shocked by electricity.
- 7) Prohibit using the instrumentation open air in disastrous weather such as lightening to avoid damage to instrument and human being.
- 8) It is not allowed to insert any solids into the instrument from opening of shell or pour any fluids into inside or outside of shell to prevent interior short circuit and/or electric shock, fire or personal injury.
- 9) Similar to other industrial products, allergic materials (allergens such as aluminum) are unavoidable. Once allergic reactions (such as rash, repeated sneezing, eye irritation or dyspnea) are detected, see a doctor immediately and find out the reason. Note that toxic gas or liquid that is harmful to the human body may be released once the instrument is on fire. In this case, the reasonable fire extinguishing measures should be taken or the instrument should be taken away from the operation station.
- 10) The electromagnetic compatibility of the instrument conforms to the requirements of the specifications. However, electromagnetic radiation may occur to some degree. The operator should check whether there are special people vulnerable to such radiation in the working environment. If required, appropriate measures should be taken to avoid hazards.
- 11) The instrument must be opened by the authorized personnel. The instrument should be powered off before it is opened or operated in other way. Instrument adjustment, part replacement, maintenance and repair must be done by the technical personnel of the manufacturer. Parts related to the safety must be replaced with original parts.

II. Environmental Protection

1. Disposal of packing container

We are sure that pack container of products is harmless waste, please save packing container and liner for future transportation or dispose them according to local environmental regulations.

2. Treatment of scrapped articles

- 1) The parts replaced in repair or upgrading should be recycled or dealt with by China Electronics Technology Instruments Co., Ltd. The scrapped instrument must not be discarded or treated without permission. Please notify China Electronics Technology Instruments or professional recycling units with qualifications to recycle or deal with the scrapped instrument.
- 2) If required, the internal battery may not be discarded without permission after replacement. It should be separately recycled as chemical waste.

Unless otherwise specified, the above-mentioned operations should abide by Regulations on Recovery Processing of Waste Electrical and Electronic Products and local environmental laws and regulations.

Foreword

This manual is the fourth version of the User Manual of 4024 Series Spectrum Analyzer.

The information contained in this User Manual is subject to change without prior notice.



Statement:

China Electronics Technology Instruments reserves the right of final interpretation for the contents and terms used in this Manual.

Our company owns the copyright of this Manual. Without prior approval of it, any unit or individual shall not modify or tamper the content of this Manual, or reproduce or transmit this Manual for profit. Otherwise, China Electronics Technology Instruments shall reserve the right to investigate legal liability against the copyright infringer.

Thank you for choosing 4024 series spectrum analyzers developed and produced by China Electronics Technology Instruments Co., Ltd.

We take customer demands as our own duty, providing you high-quality measuring instrument and the best after-sales service. We always adhere to the business philosophy of "superior quality and considerate service", and are committed to offering satisfactory products and service for our clients. Please contact us according to the following information:

This manual introduces the purpose, operation method, operation precautions, performance characteristics, basic operation principle and fault query of the 4024 series spectrum analyzer developed and produced by China Electronics Technology Instruments Co., so as to help you to get familiar with and master the operation method and key operation points as soon as possible. In order to skillfully operate this instrument, please carefully read this manual and properly follow the guidance during operation.

The User Manual includes 13 chapters:

Chapter I briefly introduces the basic information of 4024 series spectrum analyzer, including main technical characteristics, available or achievable functions and achievable technical specifications.

Chapter II to XI mainly describes the operating instructions. Chapter II describes what should be done after receiving one new spectrum analyzer and what should be noted in operation. Chapter III mainly introduces the front panel and external interfaces of the spectrum analyzer. Chapter IV introduces the spectrum analysis measurement mode; Chapter V introduces the interference analysis measurement mode (optional); Chapter VI introduces the power measurement mode (optional); Chapter VII introduces the analog demodulation measurement mode (optional); Chapter VIII introduces the channel scanning measurement mode (optional); Chapter IX introduces the field strength measurement mode (optional). Chapter X introduces the Signal Analyzer mode (optional); Chapter XI and XII describe technical specifications. They briefly describe the working principle of 4024 series spectrum analyzer, and provide the performance characteristic test method of the main technical specifications.

Chapter XIII describes the maintenance requirements: Including the steps to query faults, error description and repair procedures.

Due to our limited knowledge, there may be some omissions or errors, and you are welcome to correct any

error. We are sorry for the flaws which may cause your inconvenience.

Editor

Sep. 2018

Contents

Chapter I Overview	1
Section 1 Product Overview	2
1.1.1 <i>Brief Introduction</i>	2
1.1.2 <i>Product features</i>	2
1.1.3 <i>Functions</i>	3
1.1.4 <i>Typical application</i>	3
Section 2 Main Technical Specifications	5
Article I Instructions	8
Chapter II Operation Guide	10
Section 1 Unpacking Inspection	10
2.1.1 <i>Model confirmation</i>	10
2.1.2 <i>Appearance inspection</i>	10
Section 2 Safety Instructions	10
2.2.1 <i>Environmental requirements</i>	10
2.2.2 <i>Selection of power line</i>	11
2.2.3 <i>Power supply requirements</i>	11
2.2.4 <i>Electrostatic protection (ESD)</i>	12
2.2.5 <i>Input/output port protection</i>	13
2.2.6 <i>Cleaning of display of front panel</i>	13
Section 3 Battery Installation and Replacement	14
2.3.1 <i>Battery description</i>	14
2.3.2 <i>Battery installation and replacement</i>	14
2.3.3 <i>Battery status check</i>	14
2.3.4 <i>Battery charging</i>	15
Section 4 User Inspection	15
2.4.1 <i>Start-up of spectrum analyzer</i>	15
2.4.2 <i>Shutdown of spectrum analyzer</i>	15
Chapter III Basic Operation	16
Section 1 Description of front panel	16
3.1.1 <i>Display zone</i>	16
3.1.2 <i>Number input zone</i>	19
3.1.3 <i>Function key zone</i>	19
3.1.4 <i>Reset button</i>	20
3.1.5 <i>Power switch</i>	20
Section 2 Interface Description	21
3.2.1 <i>Power interface</i>	21
3.2.2 <i>Test ports</i>	21
3.2.3 <i>Digital interface</i>	22
3.2.4 <i>Instrument symbols</i>	22
Chapter IV Spectrum Analysis Mode	24

Section 1 Introduction to Typical Measurements	25
4.1.1 Channel power measurement	26
4.1.2 Occupied bandwidth measurement	28
4.1.3 Adjacent channel power ratio measurement	30
4.1.4 Third-order IM distortion measurement	32
4.1.5 Drift signal measurement	36
4.1.6 Noise signal measurement	37
4.1.7 Distortion measurement	40
4.1.8 Pulse RF signal measurement	47
4.1.9 Signal source measurement (option)	52
Section 2 Structure of Spectrum Analysis Menu	55
Section 3 Description of “Spectrum Analysis” Menu	61
4.3.1 Frequency menu	61
4.3.2 Span menu	62
4.3.3 IF output menu	63
4.3.4 Amplitude menu	64
4.3.5 Bandwidth menu	65
4.3.6 Detector menu	66
4.3.7 Marker menu	67
4.3.8 Peak menu	68
4.3.9 Mode menu	69
4.3.10 Sweep menu	70
4.3.11 Triggering menu	71
4.3.12 Trace menu	72
4.3.13 Limit menu	73
4.3.14 Measurement menu	74
4.3.15 Signal source menu (option)	81
4.3.16 File menu	83
4.3.17 System menu	83
Chapter V Interference Analyzer Measurement Mode (optional)	85
Section 1 Introduction to Typical Measurements	85
5.1.1 Spectrogram measurement	85
5.1.2 RSSI measurement	86
Section 2 Structure of Interference Analyzer Menu	88
Section 3 Description of Interference Analyzer Menu	90
5.3.1 Frequency menu	90
5.3.2 Span menu	91
5.3.3 Amplitude menu	91
5.3.4 Bandwidth menu	92
5.3.5 Marker menu	93
5.3.6 Peak menu	94
5.3.7 Sweep menu	95
5.3.8 Auto Save menu	95
5.3.9 Measurement menu	96
5.3.10 File menu	96

Chapter VI Power Meter Mode (optional)	97
Section 1 Introduction to Typical Measurements	97
Section 2 Structure of Power Meter Menu	99
Section 3 Description of Power Meter Menu	100
6.3.1 <i>Frequency menu</i>	100
6.3.2 <i>Amplitude menu</i>	100
6.3.3 <i>Bandwidth menu</i>	101
6.3.4 <i>Calibrate menu</i>	101
6.3.5 <i>Limit menu</i>	101
6.3.6 <i>File menu</i>	102
Chapter VII AM-FM-PM Analyzer Mode (optional)	103
Section 1 Introduction to Typical Measurements	103
Section 2 Structure of AM-FM-PM analyzer Menu	105
Section 3 Description of AM-FM-PM Analyzer Menu	107
7.3.1 <i>Frequency menu</i>	107
7.3.2 <i>Span menu</i>	108
7.3.3 <i>Amplitude menu</i>	108
7.3.4 <i>Bandwidth menu</i>	109
7.3.5 <i>Marker menu</i>	110
7.3.6 <i>Peak menu</i>	111
7.3.7 <i>RF spectrum menu</i>	112
7.3.8 <i>Audio spectrum menu</i>	112
7.3.9 <i>Audio waveform menu</i>	113
7.3.10 <i>Measurement menu</i>	113
7.3.11 <i>File menu</i>	113
Chapter VIII Channel Scanner Mode (optional)	115
Section 1 Introduction to Typical Measurements	115
8.1.1 <i>Channel Scanner</i>	115
8.1.2 <i>Frequency Scanner</i>	116
8.1.3 <i>List scanner</i>	117
Section 2 Structure of Channel Scanner Menu	118
Section 3 Description of Channel Scanner Menu	119
8.3.1 <i>Scanner menu</i>	119
8.3.2 <i>Channel Scanner menu</i>	119
8.3.3 <i>Frequency Scanner menu</i>	120
8.3.4 <i>List Scanner menu</i>	120
8.3.5 <i>Measurement menu</i>	121
8.3.6 <i>File menu</i>	121
Chapter IX Field Strength Measurement Mode (optional)	123
Section 1 Introduction to Typical Measurements	123
9.1.1 <i>PScan</i>	123
9.1.2 <i>FScan</i>	124
9.1.3 <i>MScan</i>	124

Section 2 Structure of Field Strength Menu	126
Section 3 Description of Field Strength Menu	128
9.3.1 <i>Frequency menu ([PScan] mode)</i>	128
9.3.2 <i>Frequency menu ([FScan] mode)</i>	128
9.3.3 <i>Amplitude menu</i>	129
9.3.4 <i>Bandwidth menu</i>	130
9.3.5 <i>Marker menu</i>	130
9.3.6 <i>Peak menu</i>	130
9.3.7 <i>Sweep/Antenna menu</i>	131
9.3.8 <i>Edit List menu</i>	131
9.3.9 <i>Demodulation menu</i>	132
9.3.10 <i>Measurement menu</i>	132
9.3.11 <i>File menu</i>	132
Chapter X Signal analyzer mode (option)	133
Section 1 Introduction to typical measurement	133
Section 2 Structure of signal analysis menu	136
Section 3 Description of signal analysis menu	138
10.3.1 <i>Frequency menu</i>	138
10.3.2 <i>Span menu</i>	139
10.3.3 <i>Amplitude menu</i>	139
10.3.4 <i>Bandwidth menu</i>	140
10.3.5 <i>Marker menu</i>	141
10.3.6 <i>Peak menu</i>	142
10.3.7 <i>Sweep menu</i>	143
10.3.8 <i>Record menu</i>	143
10.3.9 <i>Configuration menu</i>	144
10.3.10 <i>Tune Listen menu</i>	144
10.3.11 <i>IQ Capture menu</i>	145
10.3.12 <i>ShortCut menu</i>	146
10.3.13 <i>File menu</i>	146
Article II Technical Instructions	147
Chapter XI Operating Principle	149
Chapter XII Performance Characteristic Test	151
Article III Maintenance Instructions	184
Chapter XIII Troubleshooting and Repair	186
Section 1 Fault Information Description	186
Section 2 Repair Method	187
Appendix A Performance Characteristic Test Results	188



Chapter I Overview

The following safety notes are used throughout this manual. Familiarize yourself with each of the notes and its meaning before operating this instrument.



“Warning” indicates danger. It reminds the user to pay attention to a certain operation process, operation method or similar situations. Noncompliance with the rules or improper operation may result in personal injuries. You shall fully understand and meet all the conditions in the warning before proceeding to the next step.



“Attention” indicates important prompts and no danger. It reminds the user to pay attention to a certain operation process, operation method or similar situations. Noncompliance with the rules or improper operations may result in damage to the instrument or loss of important data. You shall fully understand and meet all the conditions in the caution before proceeding to the next step.

Section 1 Product Overview

1.1.1 Brief Introduction

4024 series spectrum analyzer has the advantages of broad operating band, high performance specifications, high sweeping speed, multiple test functions, easy operation, etc. From the perspective of performance specifications, this instrument has low average noise level, low phase noise and high scanning speed. From the perspective of measurement functions, this instrument has various measurement modes such as spectrum analysis, interference analysis, analog demodulation, power measurement, channel scanning and field strength measurement and various intelligent measurement functions such as the channel power, occupied bandwidth, adjacent channel power, tune listening, emission mask and C/N. Due to integration of the 8.4-inch LCD and capacitive touch screen, the display definition and operational convenience are improved. This instrument has a small and light structure, and can be flexibly powered up and easily operation. Therefore, this instrument is applicable to field operation. The appearance is shown in Fig. 1-1.



Fig. 1-1 4024 Series Spectrum Analyzer

1.1.2 Product features

Based on the highly integrated, modular and standardized design, 4024 series spectrum analyzer has excellent performance, with main characteristics as follows:

- Broad frequency coverage: 4 models from 9kHz to 44GHz;
- Low average noise level: -157dBm@1Hz RBW;
- Excellent phase noise performance: -106dBm/Hz@100kHz; offset: @1GHz carrier;
- High sweeping speed: Minimum sweeping time within 1GHz span: <20ms;
- Resolution bandwidth: 1Hz~10MHz;
- Tracking Generator:4GHz,6.5GHz,9GHz;
- Full-band pre-amplifier: Standard configuration;

- Various measurement modes: Spectrum analysis, interference analysis (spectrogram and RSSI), analog demodulation (AM/FM/PM), channel scanning, high-precision USB power measurement, field strength measurement, etc.
- Various intelligent measurement functions: Field strength measurement, channel power, occupied bandwidth, adjacent channel power, audio demodulation, carrier-noise ratio, emission mask, IQ capture, etc.
- Various auxiliary test interfaces: 10MHz reference input/output interface, GPS antenna interface, zero-span IF output interface, external trigger input interface, etc.
- Convenient and fast user operation experience: 8.4-inch large-screen high-brightness LCD, large-font display, convenient capacitive touch screen, LCD and touch screen integration, various display modes, automatic adjustment of backlight brightness, etc.
- Operating temperature range: -10°C to 50°C this instrument can be powered up with the battery or adapter.

1.1.3 Functions

4024 series spectrum analyzer has a wide range of measurement functions, mainly including:

- Spectrum analysis, used for basic spectrum analysis of signals, including various intelligent measurement functions such as the field strength measurement, channel power, occupied bandwidth, adjacent channel power, emission mask, carrier-noise ratio, audio demodulation and IQ capture;
- Listing scanning (optional), used for continuous scanning measurement of multiple bands;
- Interference analysis (optional), including spectrogram and RSSI measurement;
- Analog demodulation, used for analysis of modulation characteristics of AM/FM/PM signals;
- Power measurement, used for high-precision power measurement of the USB interface;
- Channel scanning (optional), used for signal power measurement of multiple channels or frequencies;
- Field strength measurement (optional), used for CW measurement, frequency scanning measurement and list scanning measurement;
- GPS positioning (optional), realized with the external GPS antenna;
- Zero-span IF output (optional), used for output of the IF output interface under zero span;
- Tracking Generator(optional),used for output of Generator or Tracking Generator.

1.1.4 Typical application

■ On-site comprehensive performance evaluation of electronic weapon equipment

4024 series spectrum analyzer has the advantages of broad operating band, high performance specifications, high sweeping speed, multiple test functions, easy operation, etc. In addition, this handheld instrument is small and light and can be powered up with the battery. Therefore, this instrument can be applied in on-site installation/commissioning and maintenance/guarantee of various kinds of electronic weapon equipment such as the radar, communication, electronic countermeasures and reconnaissance and precision guidance.

■ On-site testing and diagnosis of transmitter and receiver

4024 series spectrum analyzer has various measurement modes such as the spectrum analysis, interference analysis, analog demodulation, power measurement, channel scanning and field strength measurement, and various intelligent measurement functions such as the channel power, occupied bandwidth, adjacent channel power, C/N, field strength and emission mask. Therefore, it can be used for comprehensive spectrum analysis and diagnosis services in on-site testing of transmitters and receivers.

■ **Broadband spectrum monitoring and interference identification**

4024 series spectrum analyzer can be applied with the external directional antenna in electromagnetic environment detection, radio interference analysis, electromagnetic environment background evaluation, spectrum monitoring, identification of illegal channel interference signals, etc.

Section 2 Main Technical Specifications

Technical specifications of 4024 series instruments have been strictly tested before delivery. The user may test and verify such instruments according to the technical specifications in this manual. Refer to Table 1-1 for main technical specifications of 4024 series.

Caution

4024 series spectrum analyzer comply with various performance indicator requirements within the given operating temperature range after 2h storage and 30min warm-up under the ambient temperature.

Supplementary features in the form of typical value are only for reference but not assessment.

Table 1-1 Technical Specifications of 4024 Series Spectrum Analyzer

Inspection items	Indicator requirement	
Model	4024A/B/C/D/E/F/G	
Frequency range	4024A: 9kHz~4GHz 4024C: 9kHz~9GHz 4024E: 9kHz~26.5GHz 4024G: 9kHz~44GHz	4024B: 9kHz~6.5GHz 4024D: 9kHz~20GHz 4024F: 9kHz~32GHz
Frequency reference	Nominal frequency: 10MHz Frequency reference error: $\pm(\text{Last calibration date} \times \text{aging rate} + \text{temperature stability} + \text{calibration accuracy})$ Aging rate: $\pm 5 \times 10^{-7}/\text{year}$ Temperature stability: $\pm 1 \times 10^{-7}(-10^{\circ}\text{C} \sim 50^{\circ}\text{C}, \text{relative to } 25 \pm 5^{\circ}\text{C})$ Initial calibration accuracy: $\pm 3 \times 10^{-7}$ Note: The default time elapsed since the last calibration date is one year.	
Sweep time	Range: 10 μ s~600s (Zero Span) Accuracy: $\pm 2.00\%$ (Zero Span)	
Frequency readout accuracy	$\pm(\text{Frequency reading} \times \text{frequency reference error} + 2\% \times \text{span} + 10\% \times \text{resolution bandwidth})$	
Frequency span	Range: 100Hz~upper frequency limit of corresponding model or 0Hz Accuracy: $\pm 2.0\%$	
Resolution Bandwidth	Range: 1Hz~10MHz (step by 1-3)	
Video Bandwidth	Range: 1Hz~10MHz (step by 1-3)	
Single-sideband phase noise (Carrier wave 1GHz, 20°C ~30°C)	4024A/B/C: $\leq -108\text{dBc}/\text{Hz}@10\text{kHz Offset}$ $\leq -112\text{dBc}/\text{Hz}@100\text{kHz Offset}$ $\leq -118\text{dBc}/\text{Hz}@1\text{MHz Offset}$ $\leq -129\text{dBc}/\text{Hz}@10\text{MHz Offset}$	4024D/E/F/G: $\leq -102\text{dBm}/\text{Hz}@10\text{kHz Offset}$ $\leq -106\text{dBm}/\text{Hz}@100\text{kHz Offset}$ $\leq -111\text{dBm}/\text{Hz}@1\text{MHz Offset}$ $\leq -123\text{dBm}/\text{Hz}@10\text{MHz Offset}$
Display average noise level (50 Ω load at the input end, 0dB input attenuation, average detector mode, logarithmic Video Type, RBW normalization to 1Hz, 20-30°C, tracking Generator off)	Preamp off: $\leq -138\text{dBm}$ (10MHz~20GHz) $\leq -127\text{dBm}$ (32GHz~40GHz)	$\leq -135\text{dBm}$ (20GHz~32GHz) $\leq -120\text{dBm}$ (40GHz~44GHz) Preamp on: $\leq -157\text{dBm}$ (10MHz~20GHz) $\leq -148\text{dBm}$ (32GHz~40GHz)

Total level uncertainty (frequency range 10MHz~40GHz, input signal 0 dBm~-50dBm, all settings are auto couple, 20°C ~30°C)		±1.80dB (10MHz~13GHz) ±2.30dB (13GHz~40GHz)	
Second harmonic distortion (attenuation: 0dB; input signal: -30dBm)		4024A/B/C: <-65dBc	4024D/E/F/G: <-60dBc
3-order intermodulation distortion (-15dBm double-tone signal, 100kHz spacing, 0dB attenuation, pre-amplifier off)		4024A/B/C: ≥+10dBm 50MHz~9GHz	4024D/E/F/G: ≥+7dBm 50MHz~4GHz ≥+6dBm 4GHz~13GHz ≥+6dBm 13GHz~44GHz
1dB gain compression (Double-tone test, 10MHz signal spacing)		4024A/B/C: ≥+2dBm 50MHz~9GHz	4024D/E/F/G: ≥-2dBm 50MHz~4GHz ≥-3dBm 4GHz~13GHz ≥-3dBm 13GHz~44GHz
Image response, multiple response and out-of-band response. (mixer level: -10dBm)		≤-65dBc 10MHz~20GHz ≤-60dBc 20GHz~44GHz	
Residual response (RF input match, 0dB attenuation, tracking Generator off)		4024A/B/C: (exceptional frequency: 3200MHz) Preamp on: ≤-95dBm (10MHz~9GHz) Preamp off: ≤-82dBm (10MHz~9GHz)	4024D/E/F/G: (exceptional frequency: 3200MHz) Preamp on: ≤-100dBm (10MHz~20GHz) ≤-95dBm (20GHz~44GHz) Preamp off: ≤-90dBm (10MHz~13GHz) ≤-85dBm (13GHz~20GHz) ≤-80dBm (20GHz~44GHz)
Scale fidelity		±1.00dB	
Input attenuator		4024A/B/C: Scope of attenuation 0dB~30dB, 5dB step Conversion uncertainty: ±1.20dB	4024D/E/F/G: Scope of attenuation 0dB~50dB, 10dB step Conversion uncertainty: ±1.20dB
Maximum safety input level		4024A/B/C: +27dBm, typical value (≥10dB attenuation, pre-amplifier off) +20dBm, typical value (<10dB attenuation, pre-amplifier off) +10dBm, typical value (pre-amplifier on)	4024D/E/F/G: +30dBm, typical value (≥10dB attenuation, pre-amplifier off) +23dBm, typical value (<10dB attenuation, pre-amplifier off) +13dBm, typical value (pre-amplifier on)
Reference level		Range: logarithmic type: -120dBm~+30dBm 1dB step linear type: 22.36uV~7.07 V, 0.1% step Conversion uncertainty: ±1.20dB (reference level 0dBm~-60dBm)	
Display scale		Logarithm scale 0.1~10dB per scale, 0.1dB step minimum (10-scale display) Linear scale: 10 scale display Scale unit: V, A, W, dBm, dBW, dBV, dBmV, dBuV, dBA, dBmA, dBuA	
Tracking Generator (Option)	Frequency Range	4024A: 100kHz~4GHz 4024B: 100kHz~6.5GHz 4024C: 100kHz~9GHz	
	Amplitude Range	0dBm~-40dBm	
	Minimum Amplitude Step	0.1dB	
	Amplitude Accuracy	±2.50dB (Frequency Range 10MHz~9GHz, Amplitude Range	

		0dBm~-40dBm ,20°C~30°C)
	Sideband Noise	1GHz frequency point, 0dBm output: ≤-90dBc/Hz@10kHz frequency offset ≤-95dBc/Hz@100kHz frequency offset ≤-110dBc/Hz@1MHz frequency offset

Article I Instructions



Chapter II Operation Guide

Section 1 Unpacking Inspection

2.1.1 Model confirmation

You'll find the following items after unpacking the carton:

a) 4024 Series Spectrum Analyzer	1 pcs
b) Power adapter	1
c) Three-core power line	1 pcs
d) Quick Operation Guide	1
e) USB cable	1 pcs
f) Built-in rechargeable lithium ion battery	1
g) Product certificate	1
h) Options	Several
i) Packing list	1

Please check the articles above against the order contract and packing list. If you have any questions, please contact us in line with the contact information in Preface or contact the business center of our company, we'll tackle problems as soon as possible.

Caution

The instrument is a kind of valuable device and should be handled with care.

2.1.2 Appearance inspection

Checks if instrument is damaged during transportation, if any obvious damage is detected, don't power it up. Contact our business center according to the contact information in the foreword. We'll repair or replace the instrument immediately depending on the situation.

Section 2 Safety Instructions

The safety performance of 4024 series spectrum analyzer complies with the requirements of GJB3947A-2009. This instrument contains no part to be operated by the user. The instrument shell must not be opened without permission; otherwise, personal injury may be caused. In order to protect your safety and properly operate this instrument, please carefully the following safety instruments before operation.

2.2.1 Environmental requirements

In order to guarantee the service life and measurement validity and accuracy, 4024 series should be tested under the following environmental conditions.

- Temperature range:

Storage temperature range: -40°C to +70°C

Operating temperature range: -10°C to +50°C

Operating temperature range of power supply by Li-ion battery: 0°C~+45°C



As the battery storage temperature range is -20°C to 60°C, the battery must not work continuously in a long time at high temperature, so as to avoid risks arising from high temperature. It is recommended to use the adapter to supply power.

- Low air pressure:

Low air pressure (altitude): 0-4600m

2.2.2 Selection of power line

4024 series spectrum analyzer is equipped with the three-core power line conforming to international safety standards. The power line should be inserted into the appropriate power socket with the protective ground wire so as to make the instrument shell grounded during operation. It is recommended to use the power line provided with this instrument. The power line should be replaced with one 250V/10A power line of the same type.

2.2.3 Power supply requirements

4024 series can be powered up in three methods:

- AC power supply and power supply with adapter

The accompanying AC-DC adapter must be used for AC power supply. The adapter input should be 100-240V 50/60Hz AC power.

The AC-DC adapter must not be connected to the test instrument in order to prevent the instrument from overheating when transported and carried with a knapsack. The voltage input range of the AC-DC adapter is relatively wide, so you must ensure that the power voltage is within the range specified in Table 2-1 during operation.

Caution

The working voltage and frequency ranges are subject to the parameters provided on the nameplate of the power adapter.

Table 2-1 Power Supply Requirements

Power supply parameter	Applicable range
Input voltage	100V-240VAC
Rated input current	1.7A
Work frequency	50/60Hz
Output Voltage/Current	15.0V/4.0A

➤ DC power supply

Voltage: 15V

Current: 3A (min.)

➤ Power supply with built-in battery

4024 series instruments can be powered up with the rechargeable lithium ion battery. The battery will discharge if it is not used for a long time. Therefore, the battery must be recharged before use. Refer to Section 3 for battery operation details. Basic parameters of accompanying battery are as follows:

Nominal voltage: 10.8V

Nominal capacity: 7800mAh

Caution

The rechargeable battery must not be exposed to fire or high-temperature environments (above 70°C), or placed in fresh water or salt water, or made wet. It must be kept away from children.

The rechargeable battery is reusable and should be stored in proper container to avoid short circuit. Heavy metals such as nickel and chromium in the battery can pollute natural environment. Waste battery shall not be discarded but shall be put into a special battery recycle box.

2.2.4 Electrostatic protection (ESD)

Static electricity is highly destructive to electronic components and equipment, so this instrument must be powered up on the anti-static table. Attention should be paid to electrostatic protection when using the device. If condition permits, the following electrostatic protection measures may be taken:

- Make sure all the instruments are correctly grounded to prevent static generation.
- The staff must wear anti-static wrist straps before contact with connectors or core wires or any assembly.
- The center conductor must be grounded before the cable is connected to the instrument in the test. This can be realized through the following steps: Connect a short-circuiter to one end of the cable to realize short circuit between the central conductor and outer conductor of the cable. When wearing an anti-static

wrist band, hold on to the casing of the cable connector and connect the casing to the other end of the cable before removing the short-circuiter.

2.2.5 Input/output port protection

The standard impedance of the RF port of 4024 series spectrum analyzer is 50Ω. Therefore, the appropriate load impedance for the test signal or port should be applied in strict accordance with the port requirements during operation, so as to prevent subsequent circuits from damage.



The RF input end of the spectrum analyzer has the requirements for maximum allowable input level. The applied signal must not exceed the limits; otherwise, this instrument may be damaged.

2.2.6 Cleaning of display of front panel

If required after operation of certain time, the display panel of the instrument can be cleaned according to the following steps.

- a) Shut down the instrument and disconnect the power line.
- b) Wipe display panel with clean and soft cotton cloth with detergent.
- c) Dry display panel with clean and soft cotton cloth.
- d) Do not connect power line until detergent dries out.

Caution

There is anti-static coating on display surface, do not use fluoride-bearing detergent or acidic/alkaline detergent. Do not spray detergent on display panel directly, otherwise it may penetrate into and damage the instrument.

Section 3 Battery Installation and Replacement

2.3.1 Battery description

4024 series spectrum analyzer is equipped with one large-capacity rechargeable lithium ion battery, with the endurance of about 2.5h. In order to facilitate the long-time field test and prevent the test interruption caused by insufficient battery capacity, the user may purchase the standby battery. It is recommended to purchase one of the same model as that provided along with the instrument.

Caution

To guarantee service life of the battery, the battery should be removed from battery holder during the transportation and long-time storage, and try not to make the battery power less than 5%, otherwise the battery may not be able to charge.

2.3.2 Battery installation and replacement

The battery of 4024 series spectrum analyzer can be installed or replaced easily. The user may install or replace it according to the requirements in Fig. 2-1.

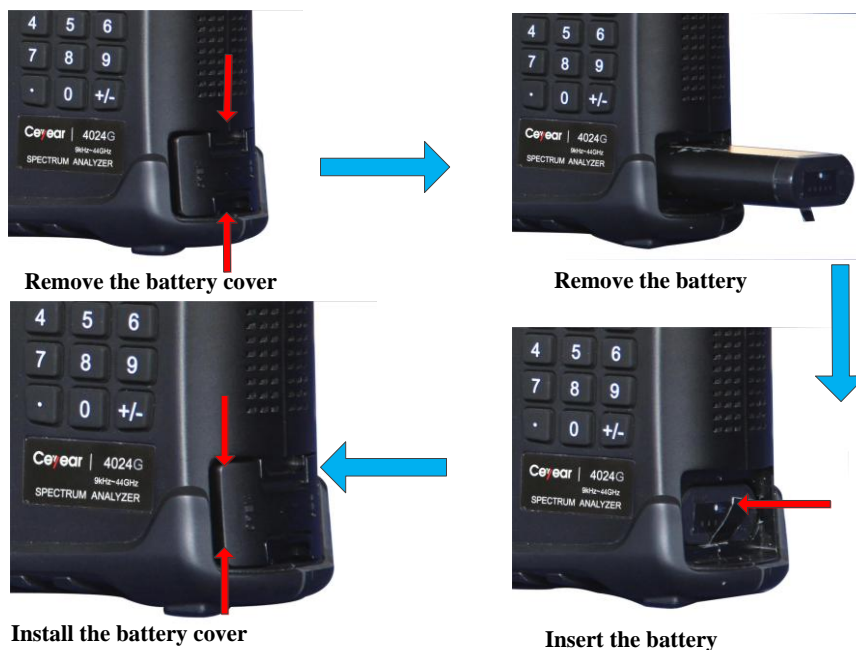

Fig. 2-1 Battery Installation and Replacement Steps

2.3.3 Battery status check

4024 series spectrum analyzer is provided with one battery, of which the standby time is 2.5h under full-capacity conditions.

The user can view the battery status in the following methods:

- Observe the battery icon on the system status bar to roughly know the battery capacity. If only 15% exists in the battery icon, replace or charge the battery promptly.
- Take out the battery and press the button on the white point at the tail end of the battery. Then the indicator above the button will be ON, showing the current residual capacity. If only one indicator is ON, the battery should be charged promptly.

2.3.4. Battery charging

Caution

The power indicator is located in the yellow power ON key.

The battery can be charged when 4024 series spectrum analyzer is OFF or operating. Charging steps:

- a) Install the battery to be charged into the machine.
- b) Connect the external power supply with the accompanying AC-DC adapter.
- c) If the battery is charged in the OFF state, the power indicator in the left lower corner of the front panel will be yellow and flicker, indicating that the battery is being charged, and after the battery is fully charged, the indicator will be yellow and normally on. If the battery is charged in the operating state, the power indicator will be green and flicker, indicating that the battery is being charged, and after the battery is fully charged, the indicator will be green and normally on. In this case, the battery icon on the right side of the system status bar of the display will be full.

In addition, the battery power more than 5% should be charged for about 4h in the shutdown status.

Section 4 User Inspection

2.4.1 Start-up of spectrum analyzer

Connect 4024 series spectrum analyzer to the external power supply with the power adapter. Observe the power indicator on the front panel. If the power indicator is yellow, it indicates that the standby power supply is normal. Gently press the power switch on the front panel for more than 3s. Observe whether the power indicator on the front panel turns green and whether the backlight of the display is ON. You should wait for about 30s for start-up of the display. Then the normal start-up image will appear. The display screen should include no warming prompt 10min after start warm-up.

Note: “Flicker” of the indicator indicates that the electricity quantity of the internal battery is not full and the battery is being charged.

2.4.2 Shutdown of spectrum analyzer

Press the yellow power switch [

Chapter III Basic Operation

Section 1 Description of front panel

The front panel of 4024 series spectrum analyzer is shown below.

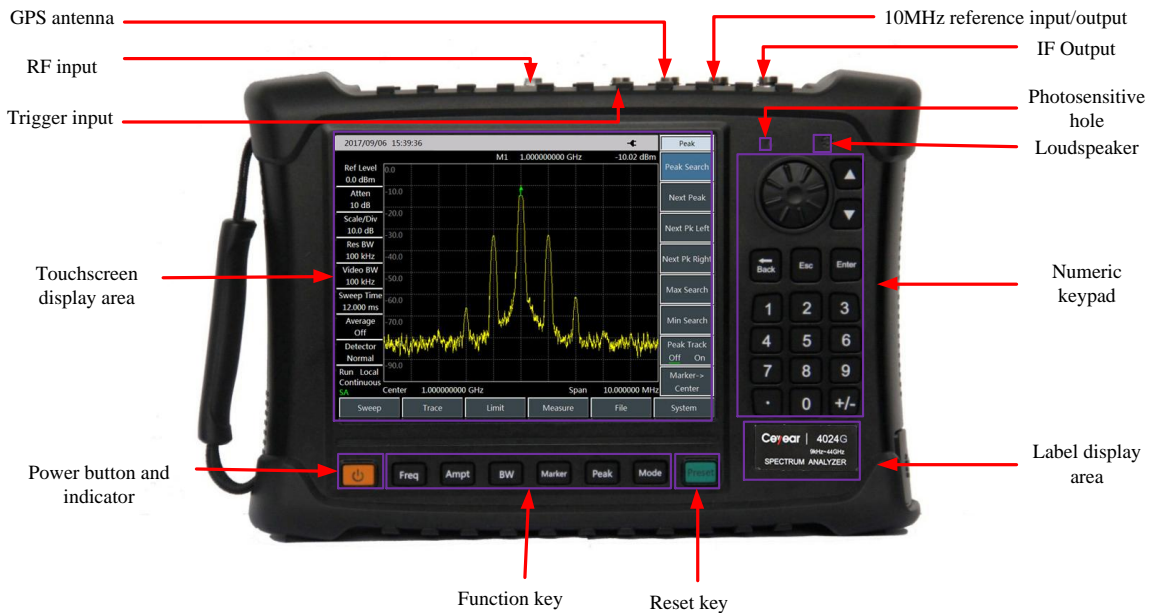

Fig. 3-1 Front Panel

Caution

The keys on the front panel are shown in the [XXX] form in this manual, where XXX is the key name; Bottom buttons on the touch screen are shown in the [XXX] form, where XXX is the button name; and buttons of the right menu are shown in the [XXX] form, where XXX is the menu name.

3.1.1 Display zone

4024 series spectrum analyzer is equipped with one 8.4-inch colorful touch screen. Parameter setting and information display can be performed by means of touch, thus eliminating the troublesome soft and hard key menu setting steps and greatly simplifying user operations.

The display zone shows the following information when different functions are active: multiple instrument windows, in which various settings and measurement data are shown; operating status information; current input data such as the frequency when required; current operating time of the system; and menu information corresponding to the current valid operating window. Refer to Fig. 3-2 for the specific introduction.

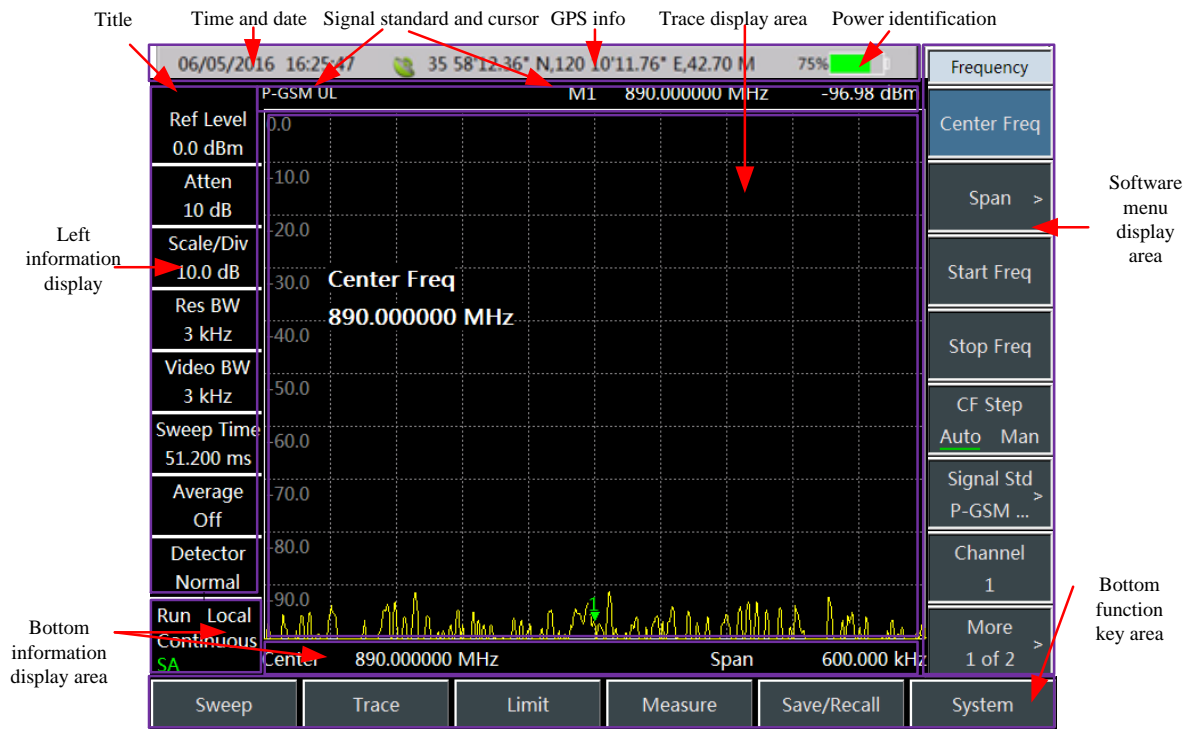

Fig. 3-2 Display Zone

The information display zone in the screen display zone of 4024 series spectrum analyzer shows various settings and instrument statuses of the current measurement. Based on the information location on the screen, the information display zone is divided into the top information display zone, marker, signal standard and title display zone, left information display zone, measurement data display zone, soft key menu display zone, bottom information display zone and bottom function buttons, 7 in total.



1) Top information display zone



The top information display zone in the top of the screen shows the system date/time and the current power supply type, battery capacity and GPS status of the spectrum analysis in sequence from left to right.

Setting and modification of the system date and time: Press [System]→[Date/Time].

Modification of the date format: Press [System]→[Date format].

For the battery type and battery status indicator on the right side of the top information display zone, various symbols are shown depending on the external power supply and battery capacity, the symbols corresponding to various power supply modes of the spectrum analyzer are described as follows:

- If the spectrum analyzer with no battery is powered up with the external power supply, “” will be displayed;
- If the spectrum analyzer is powered up with the fully charged battery and no external power adapter is connected, “100% ” will be displayed; and if the battery is fully charged and the external power adapter is connected, “100% ” will be displayed. With the battery capacity decreasing in operation, the green zone of the battery capacity symbol will decrease gradually.

- If the spectrum analyzer with the battery is connected to the external power adapter but the battery capacity is less than 100%, the battery will be charged, and the icon “95% ” will be displayed.
- If the spectrum analyzer is not connected with any external power supply, and the battery capacity is less than 20%, the battery is in the undervoltage state, and the icon “10% ” will be displayed. In this case, the battery should be charged promptly. If the battery capacity is less than 10%, the spectrum analyzer may further operate for about 10min. In this case, measurement results should be kept promptly. If the battery capacity is less than 5%, the spectrum analyzer will be shut down automatically.

2) Marker, signal standard and title display zone

Press [System]→[Tip Off On], and the title information will be displayed in this zone.

Press **【Freq】** →[Signal Std], and the current signal standard name will be displayed.

Press [Maker] or **【Peak】**, and the frequency and amplitude information of the current active marker will be displayed.

3) Measurement trace display zone

The measurement trace display zone shows measurement data. The contents displayed in this display zone vary in different measurement modes.

4) Left information display zone

This information display zone on the left upper part of the screen shows the current measurement information, such as the reference level, attenuator setting, display scale, resolution bandwidth, video bandwidth and sweep time, which can be respectively set with corresponding function keys shown in the table below.

Table 3-1 Functions of Left Display Zone in Spectrum Analysis Mode of 4024 Series

Label	Description	Corresponding Functional Key
1	Reference level 0.0dBm	【Ampt】 →[Reference level]
2	Attenuation 20dB	【Ampt】 →[Atten <u>Auto</u> Man]
3	Scale/Division 10.0dB	【Ampt】 →[Scale/Div]
4	Resolution Bandwidth 3MHz	【BW】 →[Res BW <u>Auto</u> Man]
5	Video Bandwidth 3MHz	【BW】 →[Video BW <u>Auto</u> Man]
6	Sweep time 441.000ms	【Sweep】 →[Sweep time <u>Auto</u> Man]
7	Average	【BW】 →[Average <u>Off</u> On]
8	Detector Auto	【BW】 →[Average Detector]

5) Bottom information display zone

This information zone located at the bottom of the screen mainly includes two kinds of information:

- Local: showing the current operating status of the spectrum analyzer: local or remote control.
- The current center frequency and span information are displayed at the bottom of the screen. In the zero span mode of the spectrum analyzer, the bottom information zone will display the following information in sequence: starting time, center frequency and stop time.

6) Key menu display zone

In order to improve the operation flexibility of 4024 series spectrum analyzer and fully utilize the excellent performance of the touch screen, the host software of 4024 series includes 8 gray touch keys on the right side, of which the corresponding functions are directly displayed in the corresponding key zones.

7) Button function button zone

The bottom function button zone includes 6 function buttons, which have the same functions as hard keys and are applied to display various menu names in different measurement modes so as to facilitate measurement.

3.1.2 Number input zone

The number input zone includes the direction keys, knob, number keys, Backspace, Cancel and OK. All the input can be modified by keys and knob in input area. Details of keys in input area are as below.

- **Direction keys:** The UP and DOWN key are applied to increase or decrease the value. The leftward and rightward keys are not provided here. The step value of the UP and DOWN key is set according to the step of each parameter.
- **Knob:** Increase or decrease the value. When the knob is rotated clockwise, the value will be increased; otherwise, the value will be decreased. The knob can be used with the UP/DOWN key to change the value, with the same step as the UP/DOWN key.
- **Numeric keys:** Set the number (including the negative number).
- **Backspace:** Cancel the last number one by one according to the number status.
- **Cancel:** Cancel the current invalid data.
- **OK:** Confirm the current parameter setting.

3.1.3 Function key zone

The function key zone at the bottom of the screen is used for changing measurement parameter settings, including six keys.

- **【Freq】:** Set the center frequency, starting/stop frequency, span, frequency step, etc. of measurement.
- **【Ampt】:** Set the reference level, attenuator setting, display scale, unit, pre-amplifier control, etc.
- **【Bandwidth】:** Set the resolution bandwidth, video bandwidth, detector type, average, etc. of measurement.
- **【Marker】:** Set specific parameters of the measurement cursor.

- **【Peak】** : Obtain the peak parameter.
- **【Mode】** : Set the measurement mode, including spectrum analysis, interference analysis, analog demodulation, power measurement, channel scanning and field strength measurement.

3.1.4 Reset button

Press **【Preset】** to shut down the instrument and power up it again.

3.1.5 Power switch

Turn on /turn off the spectrum analyzer. When the instrument powered up with the external power supply through the adapter is in the “Standby” state, the yellow indicator near the power switch will be ON. If the power switch is pressed for more than 3s, the indicator will turn green, indicating that this instrument is “operating”. When the power switch is pressed for more than 3s in the operating state, the spectrum analyzer will be shut down.

Note: “Flicker” of the indicator indicates that the electricity quantity of the battery is not full at present and the battery is being charged.

Section 2 Interface Description

Peripheral interfaces of 4024 series are mainly concentrated on the top panel, as shown in Fig. 3-3, and can be divided into three parts: power interface, test port and digital interface.

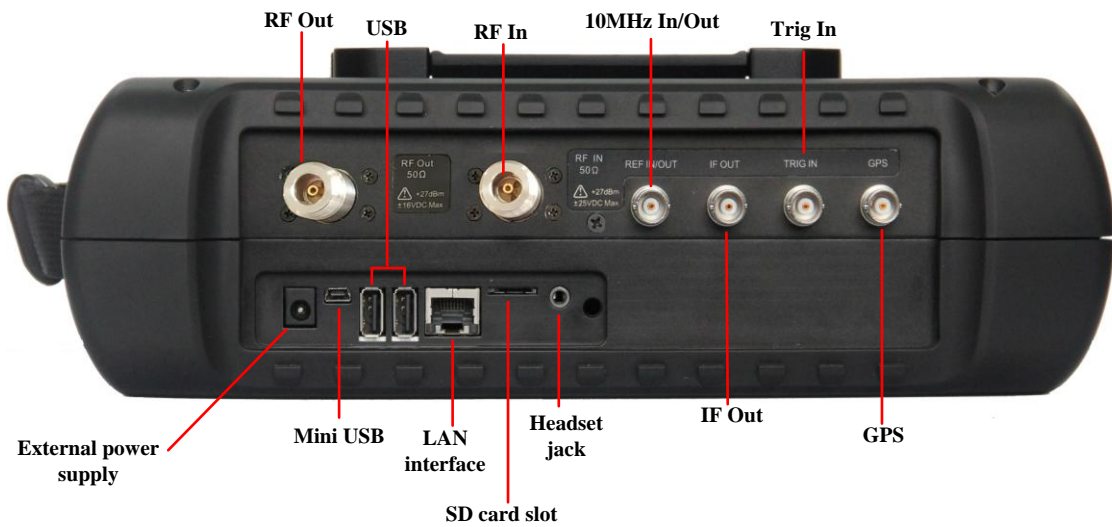

Fig. 3-3 Interface Description

3.2.1 Power interface

The power interface of the device is for powering the device through DC output of AC-DC adapter or through external DC power source. The conductor inside the external power interface is positive and the external conductor is grounded.

3.2.2 Test ports

1. RF input port: It is used for inputting the signal to be tested. The indicator of the test signal input port of 4024 series is 50Ω. The N-type female port is applied for 4024D/E and 2.4mm male port for 4024F/G.
2. RF Output port: This port is for signal output. 50Ω impedance, N-type female port, provided only when customers need the tracking generator option.
3. 10MHz Input/Output port: This port is for connecting 10MHz signal of other devices as the reference signal of the analyzer. It can also be used for outputting the internal 10MHz reference signal for other devices.
4. IF output port: Under zero span, this port can be used for outputting the IF signal for other devices through software configuration.
5. Trigger input port: The external triggering mode of 4024 series is available. The scope of trigger source should be -5V~+5V when connecting the external trigger source to the trigger input port of the Spectrum Analyzer. Rising edge trigger or fall edge trigger can be set by the software.
6. GPS antenna port: This port can be use for connecting GPS antenna device for locating current position of the Spectrum Analyzer.



To better protect the Spectrum Analyzer, some identifiers are provided at the test port of the device. The user must pay attention to the content on these identifiers when using this device, in order to avoid any permanent damage to the device.

Refer to 2.4 for details of instrument symbols in the figure.

3.2.3 Digital interface

- 1) Mini USB interface: It is used for connection of the external PC, which is used for program control or data transmission of 4024 series through the program control commands or function library.

Caution

Equipment drive should be installed for connecting the device to PC through USB interface for the first time.

- 2) USB A type interface: This interface is used for connecting USB peripheral equipment, such as USB storage device, USB power detector.
- 3) LAN (network) interface: This 10/100Mbps network interface can be connected by the network cable to the computer (PC), which is used for program control or data transmission of 4024 series through the program control commands or function library.
- 4) SD card slot: This Micro SD card slot can be used to extend the storage space of the device.
- 5) Headset jack: This is a standard headset jack for 3.5mm/3 line for audio output of FM/AM/SSB demodulation. When a headset is not connected to this jack, the audio output will be realized through the loudspeaker of the device. When a headset is connected to this jack, audio output will be automatically switched from the loudspeaker to the headset.

3.2.4 Instrument symbols

Instrument symbols (warning labels) in the figure mean that the maximum power of the test port input is +30dBm, and the maximum input DC level is 16VDC. When the device is in operation, the user is not allowed to connect signal exceeding this range to the port. Otherwise, the device may be destroyed!

Chapter IV Spectrum Analysis Mode

This chapter mainly introduces relevant information of the spectrum analysis mode of 4024 series spectrum analyzer, including some typical measurement functions and methods, so that the user that operates this instrument for the first time can have a general knowledge on some typical applications and test operations of the spectrum analysis mode after reading this section and get familiar with the operation of this mode.

Caution

All operations in this chapter are based on the spectrum analysis mode and not separately described below.

Due to rich measurement functions, the spectrum analysis mode of 4024 series includes a number of complex parameters. In addition to basic functional parameters such as the frequency, amplitude, bandwidth average, trace, sweeping and marker parameters, it also includes characteristic functional parameters such as the signal track, noise marker, peak track, counter, list scanner, trigger, limit, field strength measurement, channel power, occupied bandwidth, adjacent channel power, C/N, emission mask, IQ capture, audio monitor, etc.

➤ Signal Track

If the drift signal is tested, the active marker should be placed onto the peak point of the signal by the signal tracking function of the spectrum analyzer. In this case, the marker peak will always be displayed at the center frequency of the spectrum analyzer, thus facilitating measurement.

➤ Noise marker

The noise marker displays the noise power at which noise near the active marker is normalized to the 1Hz bandwidth. When the noise marker is enabled, the detector is set into the “RMS” mode, and the amplitude unit is set as “Log” (dBm, dBmV, dBuV, dBW, dBV, dBA, dBmA, dBuA), the marker reading unit will automatically change into dBm/Hz. When the amplitude unit is set as “Linear” (V, W, A), the marker reading unit will automatically change into $V(\text{Hz})^{1/2}$ or $W(\text{Hz})^{1/2}$ or $A(\text{Hz})^{1/2}$.

➤ Peak Track

When the peak tracking function is enabled, the peak will be searched once by the marker after each sweeping.

➤ Counter

When the frequency counter function is enabled, the marker reading will be made more accurate, which can help to improve the accuracy of frequency measurement. The measurement accuracy is Class Hz, and the error within 10Hz.

➤ List Scanner

The list scanner function supports the user to edit the scanning segment, and the spectrum analyzer will scan the edited list based on the set frequency range and other parameters.

➤ Trigger

Select the trigger mode under “Sweep” or “Measure”, including [Free Run], [Video], [External], [Slope] and [Delay]. The user can select the corresponding mode according to needs. When the previous single or

continuous sweep finishes, the next sweep or measurement is automatically triggered. Set the trigger mode as [Video]. When the positive slope part of input trigger signal passes through the video trigger level determined by [Trigger Polarity Positive Negative], the sweep will be triggered. In the [external] trigger mode, synchronize the “Sweep” or “Measure” with next voltage cycle.

➤ Limit

The limit function is applied to monitor signals within one band. The spectrum analyzer provides the upper and lower limit. The user can set the limits. When the amplitude of one signal within one band is more than the set upper limit or less than the set lower limit, the spectrum analyzer will send the alarm signal.

➤ Field strength measurement

The spectrum analyzer has the function of field strength measurement, including soft menus such as [Field Strength Off On], [Recall Antenna], [Edit Antenna] and [Save Antenna]. The field strength can be rapidly tested with such menus and corresponding test antennas.

➤ C/N

The C/N function is applied to measure the ratio of the carrier power to noise power, including the carrier bandwidth, noise bandwidth, offset frequency, span, carrier power, noise power and C/N.

➤ Emission mask

The emission mask function is applied to recall the limit as the mask to measure whether the signal power exceeds the mask limit. The mask parameter is one limit, the value of which is determined by means of limit recalling. The mask can be moved right and left or up and down according to the center frequency and reference power. In the mask, the limit center is always moved right and left to the center frequency, and also moved up and down to the reference power point based on the calculated reference power. The reference power is divided into the peak power and channel power, which are determined by the reference power.

➤ IQ capture

The IQ capture function is applied to capture IQ data and save such data into the instrument based on the capture time, sample rate and capture mode set by the user.

➤ Audio monitor

The spectrum analyzer has the tune listening function, which can be applied for radio monitoring. The sound effect can be improved by adjusting the resolution bandwidth during demodulation of the sound difference. In the demodulation mode, the resolution bandwidth should be preferably set as 300kHz-30kHz.

Section 1 Introduction to Typical Measurements

The spectrum analysis mode of 4024 series is a basic operating mode. The Quick Operation Guide of 4024 Series Spectrum Analyzer has introduces some typical measurement of this mode, including some basic measurement methods such as basic signal measurement, improvement of frequency measurement accuracy, measurement of small signals and distinguishing of signals of approximate frequencies. Additionally, this section introduces the advanced typical measurement functions and methods of the spectrum analysis mode of 4024 series, mainly including:

- a) Channel power measurement;
- b) Occupied bandwidth measurement;

- c) Adjacent channel power ratio measurement;
- d) Third-order IM distortion measurement;
- e) Drift signal measurement;
- f) Noise signal measurement;
- g) Distortion measurement;
- h) Pulse RF signal measurement.
- i) Signal source measurement(option).
- j) Coverage Map(option)

Caution

If **【Preset】** on the front panel is pressed, the spectrum analyzer will operate again. Unless specially explained, it starts from pressing **【Preset】** key in the following examples.

4.1.1 Channel power measurement

Taking the measurement of the channel power of the FM signal for example, this section describes how to apply the channel power measurement function of 4024 series spectrum analyzer to measure the channel power of the signal.

1) Definition of channel power

Channel power measurement of one of the most common measurements of the RF transmission system, in which the channel power refers to the power of the signal within a certain frequency range in the specific interval. If the specific power is not measured in the power amplifier and filter circuit test, it indicates that the system is faulty. The channel power measurement is applied to evaluate the communication transmitter, and determine the quality of RF transmission by comparison with the specific communication protocol.

4024 series spectrum analyzer can be used for measuring the channel power of the FM signal. As the FM signal is different from the CW signal in several aspects, it can be made more accurate by means of accurate setting.

2) Measurement procedures

The channel power of one FM signal can be measured with 4024 series spectrum analyzer according to the following procedures.

- a) Set the signal generator to output the FM signal:

Use the signal generator to generate one FM signal. Set the frequency as 1GHz, power as -10dBm, FM offset as 500kHz and demodulation rate as 10kHz. Connect the output of the signal generator to the RF input end of the spectrum analyzer through one cable, as shown in Fig. 4-1. Enable the ON state of the modulation output and radio frequency.



Fig. 4-1 Schematic Diagram of Connection of Signal Generator and Spectrum Analyzer

b) Reset the spectrum analyzer into the default state:

Press **【Preset】** .

c) Enable the channel power measurement function:

Press **【Measure】** , [Channel Power] and [Channel Power Off On]. Thus the channel power measurement function is enabled.

d) Set the center frequency:

Press **【Measure】** , [Channel Power] and [Center Freq] to set the center frequency with number keys. Set the center frequency of the spectrum analyzer as the frequency of the tested signal, i.e. 1GHz.

e) Set the channel power bandwidth:

Press **【Measure】** , [Channel Power] and [Channel BW] and set the channel power bandwidth as 1MHz with number keys.

f) Set the channel power span:

Press **【Measure】** , [Channel Power] and [Span] and set the channel power sweeping bandwidth as 2MHz with number keys.

g) Set the resolution bandwidth and video bandwidth of the spectrum analyzer:

Press **【BW】** and [RBW Auto Man], and set the resolution bandwidth as 30kHz;

Press **【BW】** and [VBW Auto Man], and set the video bandwidth as 30kHz or less.

Caution

The channel power bandwidth refers to the frequency width of the power displayed by the spectrum analyzer within the bandwidth, while the channel power span refers to the sweeping frequency range of the spectrum analyzer. The channel power span should be more than or equal to the channel power bandwidth; otherwise, the channel span will be automatically set to be equal to the channel power bandwidth. The ratio of the channel power span to channel power bandwidth is a constant (the ratio between 1 to 10). When the channel power bandwidth changes, this ratio will remain unchanged. It can be changed by changing the channel power span. For example, when the channel power bandwidth is doubled, the channel power span will be increased by the same times.

h) Enable the average function:

Press **【BW】** and [Average Off On], set the averaging times as 16, and enable the average function.

If the channel power measurement function is enabled, the “Auto” mode of the detector will change into the “RMS” mode. Two vertical white lines on the screen indicates the channel power bandwidth, and measurement results are displayed at the bottom of the screen. The channel power measurement interface is shown in Fig. 4-2.

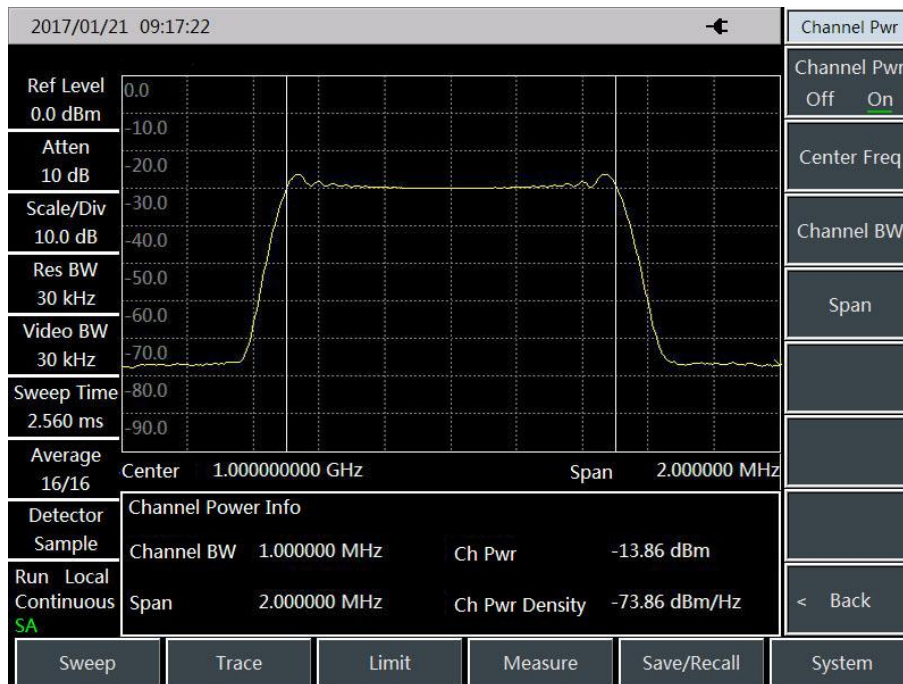

Fig. 4-2 Channel Power Measurement of FM Signal

4.1.2 Occupied bandwidth measurement

Taking the measurement of the occupied bandwidth of the FM signal for example, this section describes how to use the occupied bandwidth measurement function of 4024 series spectrum analyzer to measure the occupied bandwidth of the signal.

1) Definition of occupied bandwidth

The occupied bandwidth refers to the bandwidth including energy of certain proportion to the total transmitted power, with the center frequency of the specified channel as the center. By using the occupied bandwidth measurement function of 4024 series spectrum analyzer, measurement results can be given rapidly, clearly and accurately. Depending on the modulation mode, two methods can be applied to calculate the occupied bandwidth.

a) Power percentage:

The occupied bandwidth of the signal is obtained by calculating the bandwidth of the frequency of certain percentage to the total power of the transmitted power. The power percentage can be set by the user.

b) Power drop dBc:

The occupied bandwidth in this calculation method is defined as follows: spacing between two frequency points corresponding to signal power drop by dBc on both sides of the frequency point where the signal peak power is. The signal power drop dBc can be set by the user.

2) Measurement procedures

The occupied bandwidth can be measured with 4024 series spectrum analyzer according to the following procedures:

a) Set the signal generator to output the FM signal:

Use the signal generator to generate one FM signal. Set the frequency as 1GHz, power as -10dBm, FM offset as 500kHz and demodulation rate as 10kHz. Connect the output of the signal generator to the RF input end of the spectrum analyzer through one cable, as shown in Fig. 4-1. Enable the ON state of the modulation output and radio frequency.

b) Reset the spectrum analyzer into the default state:

Press **【Preset】** .

c) Set the center frequency:

Press **【Freq】** and [Center Freq] to set the center frequency with number keys. Set the center frequency of the spectrum analyzer as the frequency of the tested signal, i.e. 1GHz.

d) Set the resolution bandwidth:

Press **【BW】** and [RBW Auto Man], and set the resolution bandwidth as an appropriate value.

e) Set the video bandwidth:

Press **【BW】** and [VBW Auto Man], and set the video bandwidth as an appropriate value.

In order to improve the measurement accuracy, it is recommended to set the ratio of the resolution bandwidth to video bandwidth to be more than 10. Press [RBW/VBW] to change this ratio.

f) Enable the occupied bandwidth measurement mode of the spectrum analyzer:

Press **【Measure】** , [OBW] and [OBW Off On].

After the occupied bandwidth measurement function is enabled, the spectrum analyzer will change into the occupied bandwidth measurement interface, and measurement results will be displayed at the bottom of the screen. Refer to Fig. 4-3 for the schematic diagram of occupied bandwidth measurement. Two vertical white lines on the screen intuitively indicate the frequency range of the occupied bandwidth. After the occupied bandwidth measurement function is enabled, the “Auto” mode of the detector will automatically change into the “RMS” mode. The user can change the measurement method, occupied bandwidth span, etc. with corresponding menus, so as to obtain more accurate measurement results.

g) Select the measurement method:

Press **【Measure】** , [OBW] and [Method % dBc], and select the occupied bandwidth measurement method. You can set the method as the power percentage or power drop dBc. The underline indicates the current mode, and the default setting is the percentage.

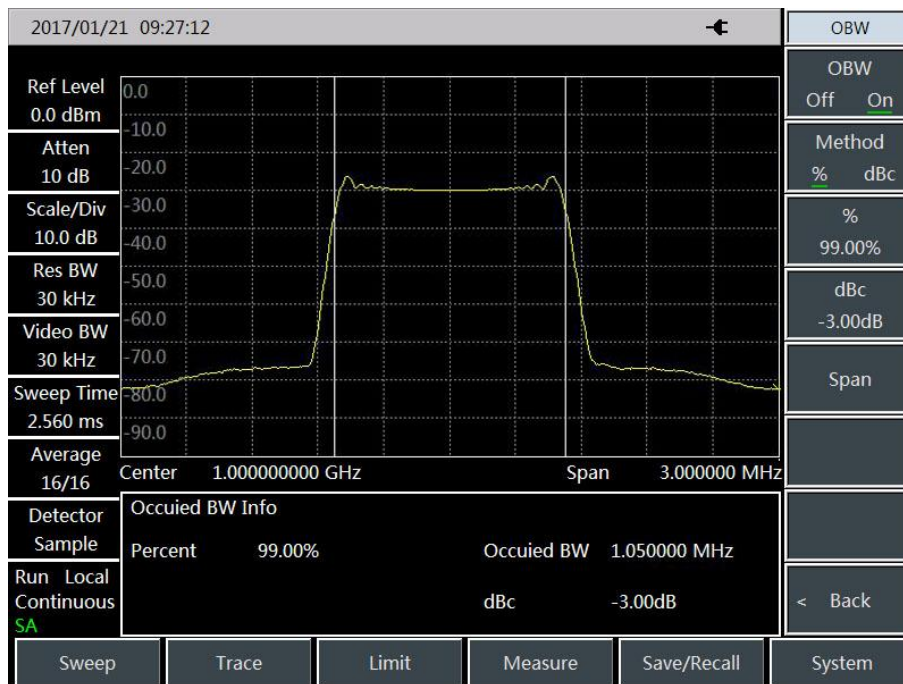

Fig. 4-3 Occupied Bandwidth Measurement

h) Change the percentage:

If the percentage method is selected, you can press **【Measure】**, [OBW] and [% 99%], and use the number keys, UP/DOWN keys or knob to change the percentage. The percentage range is 10% to 99.99%, with the minimum step of 0.01%. The default setting is 99%.

i) Change the dBc value:

If the dBc method is selected, you can press **【Measure】**, [OBW] and [dBc -3.00dB] and use the number keys, UP/DOWN keys or knob to change the dBc value. The dBc range is -0.1dB to -100dB, with the minimum step of 0.01dB. The default setting is -3dB.

j) Change the occupied bandwidth span:

Press **【Measure】**, [OBW] and [Span], and enter the occupied bandwidth span with number keys. Press corresponding soft keys to enter the unit. The default setting is 3MHz.

k) Disable the occupied bandwidth measurement:

Press **【Measure】**, [OBW] and [OBW Off On], and disable the occupied bandwidth measurement. The interface will change into the spectrum measurement interface.

4.1.3 Adjacent channel power ratio measurement

Taking the measurement of the adjacent channel power ratio of the FM signal for example, this section describes how to use 4024 series spectrum analyzer to measure the adjacent channel power ratio.

1) Definition of adjacent channel power ratio

The adjacent channel power ratio (ACPR), also known as the adjacent channel leakage power ratio (ACLR) refers to the ratio of the transmitted power of one channel to the radiation power of the adjacent channel. It

is generally expressed as the ratio of the power within the specified bandwidth under various offsets of the adjacent channel to the total power of the channel. The adjacent channel power mainly depends on the extension of the modulated sideband and noise of the transmitter.

The adjacent channel power ratio measurement can be applied, as a substitute of the traditional dual-audio IM distortion measurement, in nonlinear system tests. The measurement result of the adjacent channel power ratio can be expressed in two forms: power ratio and power density.

2) Measurement procedures

In the traditional measurement of the narrow-band signal, the distortion performance of the transmitter is evaluated generally by means of dual-audio signal IM measurement. The broadband modulation signal includes both the dense spectrum components and high peak signal (also known as the crest factor). IM products of spectrum components of the signal are always around the spectrum. The IM measurement of the broadband FM signal is complex, while ACPR is closely related to IM products arising from nonlinear distortion. Therefore, ACPR is a better method to measure the nonlinear distortion of the broadband FM signal.

The ACPR of the broadband FM signal can be measured with the ACPR measurement function of 4024 series spectrum analyzer according to the following procedures.

a) Set the signal generator to output the broadband FM signal:

Use the signal generator to generate one FM signal. Set the frequency as 1GHz, power as -10dBm, FM offset as 500kHz and demodulation rate as 10kHz. Connect the output of the signal generator to the RF input end of the spectrum analyzer through one cable, as shown in Fig. 4-1. Enable the ON state of the modulation output and radio frequency.

b) Reset the spectrum analyzer into the default state:

Press **【Preset】** .

c) Set the reference level of the spectrum analyzer:

Press **【Ampt】** , [Ref Level] and -10[dBm];

Press **【Ampt】** and [Scale/Div] and set the scale as 10dB/division.

d) Set the resolution bandwidth and video bandwidth:

Press **【BW】** and [RBW Auto Man], and set the resolution bandwidth as 30kHz;

Press **【BW】** and [VBW Auto Man], and set the video bandwidth as 30kHz or less.

e) Enable the ACPR measurement:

Press **【Measure】** , [ACPR] and [ACPR Off On] to enable the ACPR interface.

f) Set the center frequency of the main channel:

Press [Center Freq] and set the center frequency of the main channel with number keys, i.e. 1GHz.

g) Set the bandwidth of the main channel:

Press [Main Ch BW] and set the bandwidth of the main channel with number keys, i.e. 1MHz.

h) Set the adjacent channel bandwidth:

Press [Adj Ch BW] and set the adjacent channel bandwidth with number keys, i.e. 2MHz.

i) Set the channel spacing:

Press [Ch Spacing] and set the channel spacing as 1MHz with number keys.

j) Enable the ACPR test:

Press [ACPR Off On]. Then the measurement results will be displayed at the bottom of the screen. Refer to Fig. 4-4 for the schematic diagram of ACPR measurement.

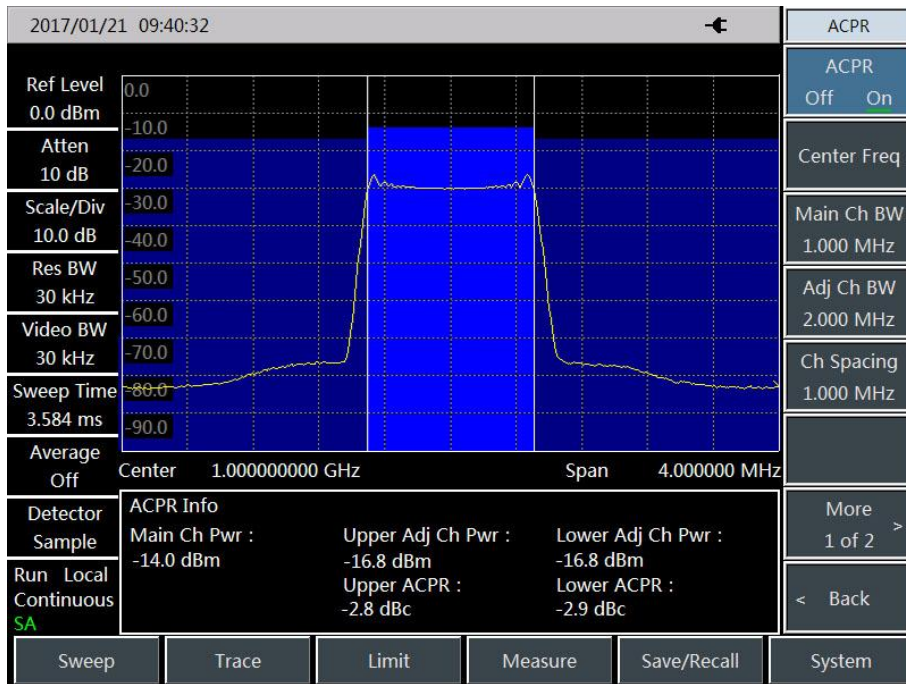

Fig. 4-4 ACPR Measurement

k) Limit setting:

The limit test function can be applied so as to easily observe whether the adjacent channel power is beyond the set range. Press **[Measure]**, [ACPR] and [More 1/2] to enter the ACPR limit test setting menu.

Press [Upper Limit] and enter the upper limit with number keys.

Press [Lower Limit] and enter the lower limit with number keys.

l) Enable the limit test function:

Press [Limit Test Off On] to enable the limit test function. If the adjacent channel power is beyond the set limits, the screen background will become red for indication.

4.1.4 Third-order IM distortion measurement

1) Definition of third-order IM distortion

Mutual interference between equipment in common in crowd operating environment of the communications system. For example, second-order and third-order IM distortion is common in narrow-band systems. When there are two signals (F_1 and F_2) in one system, they and second harmonic

distortion signals generated by them ($2F_1$ and $2F_2$) mix and become third-order IM products $2F_2-F_1$ and $2F_1-F_2$ very close to original signals, thus resulting in high-order IM distortion. Such distortion products are mostly generated by devices such as amplifiers and mixers in the system.

The measurement of third-order IM distortion is described below. This section provides an example of how to display two signals at the same time on the screen of the spectrum analyzer, and introduces how to set the resolution bandwidth, mixer level and reference level, as well as some marker functions.

2) Measurement procedures

a) Connect the tested instrument with spectrum analyzer as shown in Fig. 4-5.

This example involves one 6dB directional coupler, one 1GHz signal generator and one 1.001GHz signal generator. Of course, the signal generators of other frequencies are allowed. However, the frequency interval must be approximately 1MHz in this example.

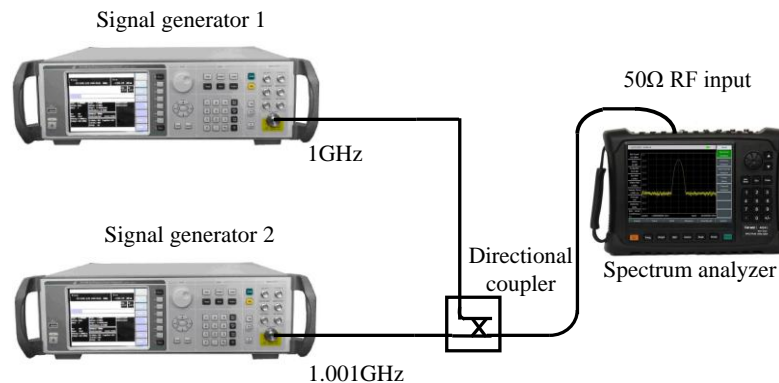

Fig. 4-5 Connection of Third-order IM Distortion Measurement System

Set the output frequency of one signal generator as 1GHz and the output frequency of the other signal generator as 1.001GHz, so that the frequency interval of two signals transmitted into the spectrum analyzer is 1MHz.

Set the same output amplitude for both signal generators (-20dBm in this example).

b) Set the spectrum analyzer until both signals are displayed on its screen at the same time.

Press **【Preset】** .

Press **【Freq】** , [Center Frequency], 1.0005[GHz].

Press **【Freq】** , [Span] and 5[MHz].

You can see that both signals are at the center of the screen, as shown in Fig. 4-6. If the applied frequency interval is different from that in this example, select the span more than three times of the frequency interval of the signal generators.

c) Reduce the resolution bandwidth until you can see the distortion product:

Press **【BW】** and reduce the resolution bandwidth with the step key **【↓】** .

d) Adjust both signal generators until the amplitudes of input signals are the same.

Press [Maker], [Delta], **【Peak】** and [Next Peak] or [Next Pk Left] or [Next Pk Right]. Adjust the signal generator corresponding to the marker until the amplitude difference is zero. If required, reduce the video

bandwidth.

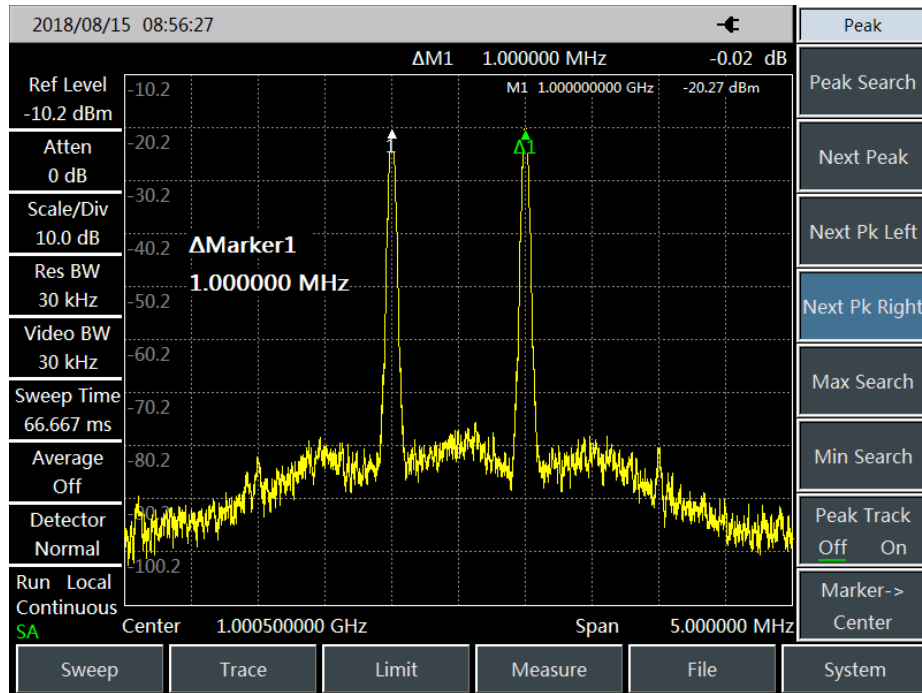

Fig. 4-6 Signals at Center of Display of Spectrum Analyzer

e) Set the reference level and make the signal peak at the reference level:

Press **【Peak】** and [Peak Search], and read the peak power.

Press **【Ampt】**, [Reference Level].

In order to achieve the best measurement accuracy, the signal peak of the signal generators should be set at the reference level, as shown in Fig. 4-7.

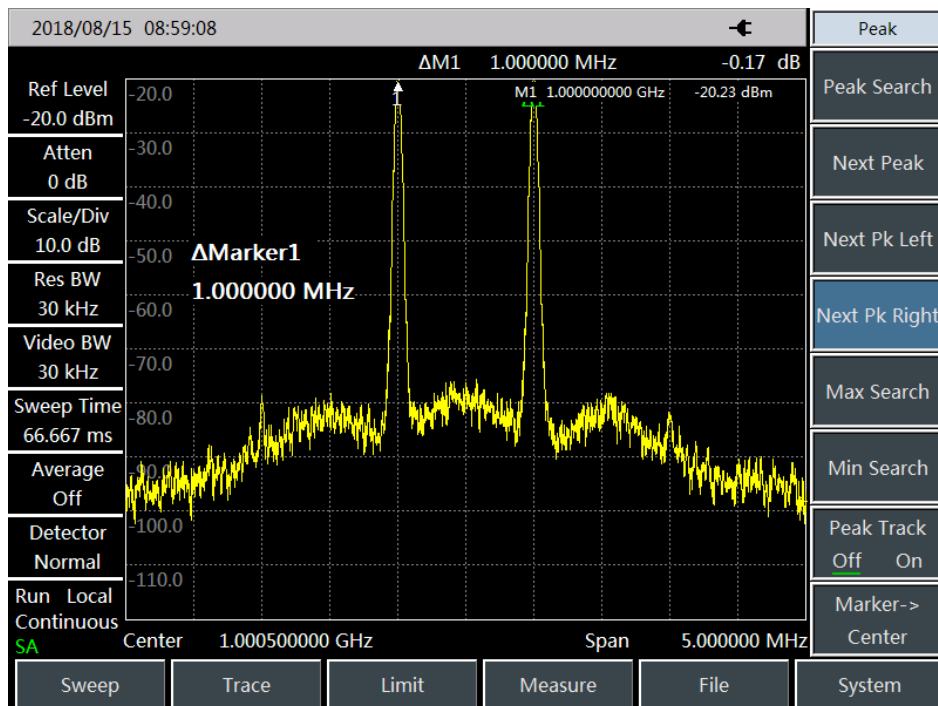

Fig. 4-7 Signal Peak at Reference Level

f) Set the second marker and measure the distortion product:

Once the marker is activated, the second marker will be generated by the differential marker function, and

the difference between both markers will be displayed. In this case, relative measurement can be performed easily.

Press **【Peak】** to activate one marker.

Press [Maker] and [Delta] to activate the second marker.

Press **【Peak】** and [Next Pk Left] or [Next Pk Right] to set the second marker at the peak point of the distortion product beside the signal generated by the signal generator. As shown in Fig. 4-8, the frequency and amplitude difference of both markers will be shown in the marker display zone, and the marker amplitude difference will be the measured value of third-order IM distortion.

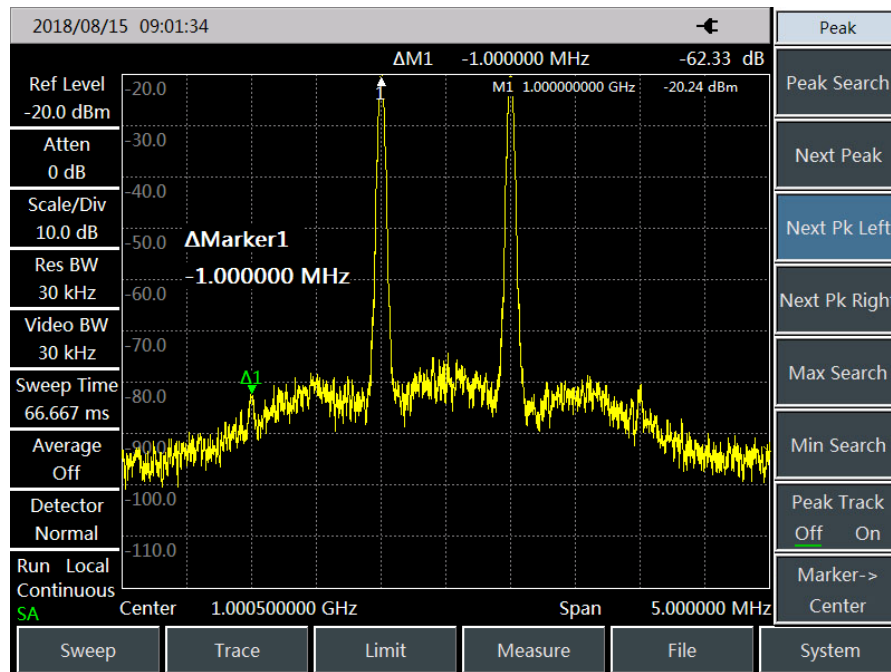

Fig. 4-8 Relative Measurement of Internal Modulation Distortion

g) Calculation of third-order interception (TOI) point:

The ratio (in dB) of the distortion component level to signal level has no great significance for system distortion, unless the signal level is specified. The interception point can be applied to specify and evaluate the system distortion level. The difference between the third-order distortion component level and fundamental signal level is twice of that between the fundamental signal level and third-order interception point. The third-order interception (TOI) point can be calculated by the following formula:

$$TOI = L_{in} - \frac{\Delta dB_{im3}}{2}$$

Where:

L_{in} : Refer to two input signal levels, in dBm.

ΔdB_{im3} : means the difference between the third-order IM product and input signal level, in dB.

As shown in Fig. 4-7, if the differential marker reading is -62.33dB and the signal level is -20.24dBm, the third-order interception (TOI) point is:

$$TOI = -20.24 - (-62.33/2) = 10.925(\text{dBm})$$

4.1.5 Drift signal measurement

1) Definition of drift signal

If the drift signal is measured with the spectrum analyzer, the center frequency should be changed in different period so as to facilitate observation. If the signal tracking function of the spectrum analyzer is enabled, the marker peak will always be displayed at the center frequency of the spectrum analyzer, thus facilitating measurement.

This section introduces how to measure the drift signal, in which the signal tracking function, marker function and maximum holding function of the spectrum analyzer are applied to observe the amplitude trace and occupied bandwidth of the drift signal.

2) Measurement of frequency drift for signal generator

The spectrum analyzer is able to measure the short-time and long-time stability of the signal generator. By using the maximum trace holding function, the spectrum analyzer can display the maximum peak amplitude and frequency drift of the input signal. The max hold function of track may be used to measure the occupied bandwidth of signal.

In this example, the signal tracking function of the spectrum analyzer is applied to keep the drift signal always displayed at the center and the maximum trace holding function to capture the drift.

a) Set the output signal of the signal generator:

Set the signal generator to output the 300MHz and -20dBm signal. Connect the output of the signal generator to the input port of the spectrum analyzer, as shown in Fig. 4-1. Enable the RF output.

b) Set the center frequency, span and reference level of the spectrum analyzer:

Press **【Preset】** .

Press **【Freq】** , [Center Frequency], 300[MHz].

Press **【Freq】** , [Span] and 10[MHz].

Press **【Ampt】** , [Ref Level] and -10[dBm].

c) Set the marker at the signal peak, and enable the signal tracking function.

Press **【Peak】** and [Peak Track Off On].

Press **【Freq】** and [Signal Track Off On].

d) Reduce the span:

Press **【Freq】** , [Span] and 500 [kHz]. You can see that the signal is always at the center.

e) Disable the signal tracking function:

Press **【Freq】** and [Signal Track Off On].

f) Use the maximum holding function to measure the signal drift.

Press [Trace] and [Max Hold].

When the signal changes, the max hold will maintain the maximum response to the input signal.

g) Activate the trace 2 and set it into the continuous clearing and writing mode.

Press [Trace], [Trace 1 2 3] and [Clear Write].

h) Change the output frequency of the signal generator.

Slowly change the output frequency of the signal generator, with the step of 1kHz and the range of ± 50 kHz.

The spectrum analyzer will display the information shown in Fig. 4-9.

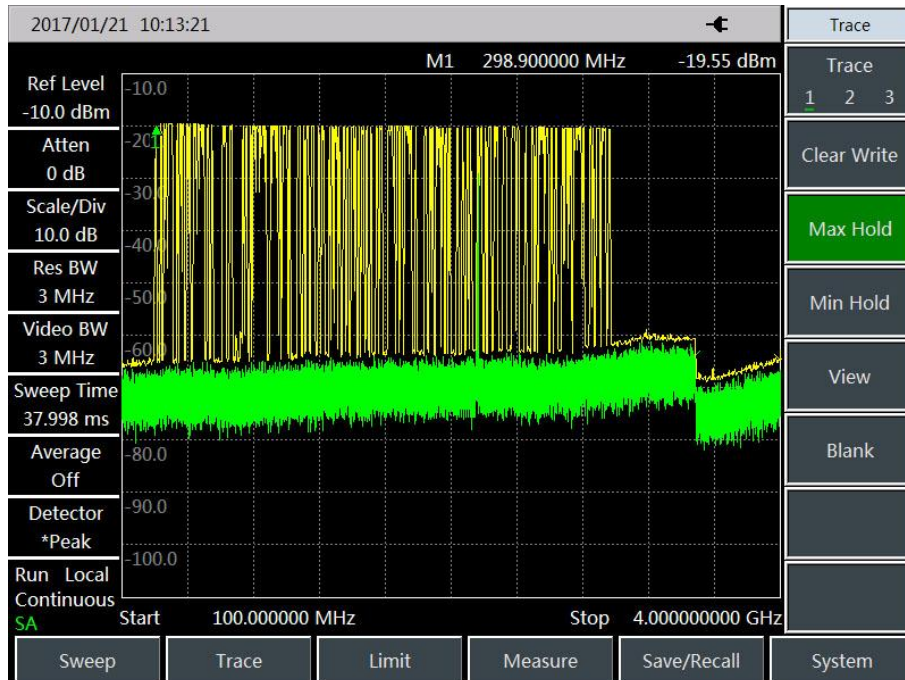

Fig. 4-9 Observation of Drift Signal by Maximum Holding Function

4.1.6 Noise signal measurement

1) Definition of noise signal

In communications systems, signal-to-noise ratio (SNR) is usually used to express noise amplitude. When the noise level in the system increases, SNR decreases, and it will be harder to demodulate modulated signals. SNR measurement is also used to indicate measurement of ratio of carrier against noise in communications systems.

Measurement of the S/N and noise by the marker function of 4024 series spectrum analyzer is described below. In the example, SNR is measured with the signal (carrier) having only single frequency point. If the modulation signal is tested, this test process should be modified to correct the level of the modulation signal.

2) Measure SNR

a) Set the output signal of the signal generator:

Set the frequency of the signal generator as 1GHz and power as -10dBm. Connect the output of the signal generator to the input port of the spectrum analyzer, as shown in Fig. 4-1. Enable the ON state of the radio frequency.

b) Set the center frequency, span, reference level and attenuator.

Press **【Preset】** .

Press **【Freq】** , [Center Frequency], 1[GHz].

Press **【Freq】** , [Span] and 5[MHz].

Press **【Ampt】** , [Ref Level] and -10[dBm].

Press **【Ampt】** , [Atten Auto Man] and 40[dB].

c) Set the marker at the signal peak and the differential marker at the noise location with the offset of 200kHz.

Press **【Peak】** and [Peak Track Off On].

Press **【Marker】** , [Delta] and 200[kHz].

d) Enable the noise marker function and observe the S/N:

Press **【Marker】** and [Marker Noise Off On]. As shown in Fig. 4-10, the S/N reading is in dB/Hz, as the noise value refers to the noise bandwidth normalized to 1Hz.

This value decreases by $10 \times \log(BW)$. If you wish to obtain noise values under different channel bandwidth, the measurement result needs to be corrected based on current bandwidth. For example, if the reading of the spectrum analyzer is -85dB/Hz and the channel bandwidth is bandwidth, S/N is:

$$S/N = 85 \text{ dB/Hz} - 10 \times \log(30 \text{ kHz}) = 40.2 \text{ dB/(30 kHz)}$$

If the differential marker is less than one fourth of the edge distance between the signal peak and response, errors may occur in noise measurement.

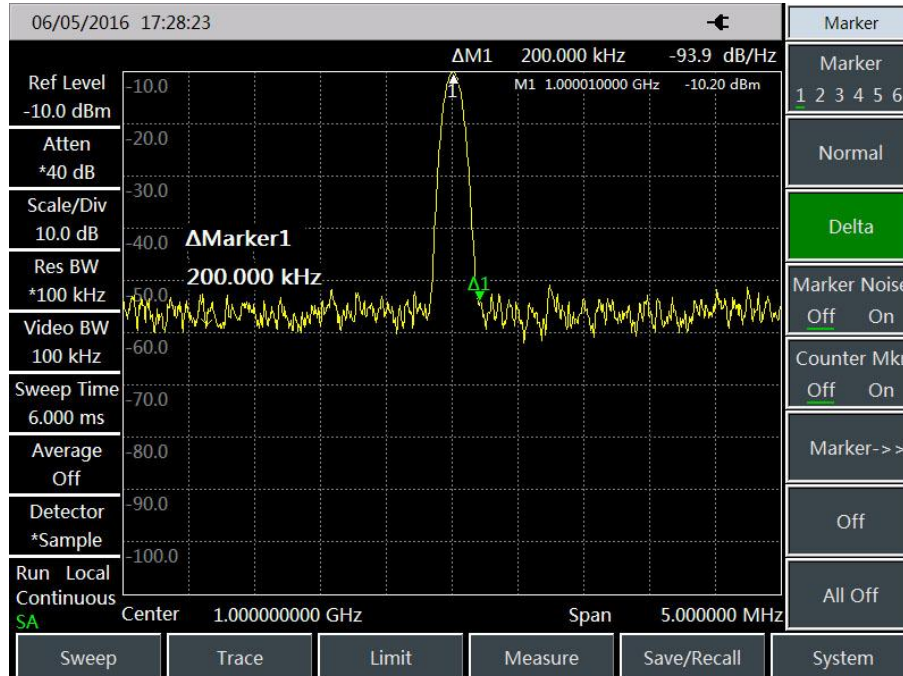

Fig. 4-10 S/N Measurement

3) Noise measurement by noise marker function

In this example, the noise of 1Hz bandwidth is measured by the noise marker function, using the 1GHz external signal.

a) Set the output signal of the signal generator:

Set the frequency of the signal generator as 1GHz and power as -10dBm. Connect the output of the signal generator to the input port of the spectrum analyzer, and enable the ON state of the radio frequency.

b) Set the center frequency, span, reference level and attenuator.

Press **【Preset】** .

Press **【Freq】** , [Center Frequency], 999.98[MHz]

Press **【Freq】** , [Span] and 100[kHz].

Press **【Ampt】** , [Ref Level] and -10[dBm].

Press **【Ampt】** , [Atten Auto Man] and 40[dB].

c) Activate the noise marker.

Press [Maker] and [Marker Noise Off On].

Note: The “RMS” mode of the detector will be enabled automatically. To obtain the noise power under different bandwidth, you can correct the current bandwidth based on $10 \times \log(\text{BW})$. For example, if the noise power within 1 kHz bandwidth is to be obtained, $10 \times \log(1000)$ or 30 dB has to be added to the reading.

d) Reduce the measurement error by increasing the sweep time:

Press **【Sweep】** , [Sweep Time Auto Man] and 3[s].

In the “Average” mode of the detector, you can increase the sweep time so that the trace data are averaged in a longer interval, so as to reduce the measurement error.

e) Move the marker to 1GHz.

Press [Maker] and rotate the knob on the front panel until the noise marker reading is 1GHz.

The noise marker value is calculated based on 5% of points on the whole sweep trace, with the marker location as the center. The noise marker will not be at the signal peak since such position has no enough trace points for calculation. Therefore, when the resolution bandwidth is narrow, the noise level will average trace points below the signal peak. As shown in Fig.4-11:



Fig. 4-11 Noise Measurement by Noise Marker Function

f) Set the spectrum analyzer into the zero span mode, with the marker location as the center.

Press **【Peak】** and [Marker→Center].

Press **【Freq】** , [Span] and [Zero Span].

Read the [Maker].

In this case, the amplitude reading of the noise marker is correct, as the averages of all points are at the same frequency, which is not affected by the shape of the resolution bandwidth filter. The noise marker is calculated based on the average of the interested frequency points. The power of discrete frequency points should be measured in the zero span mode, with the spectrum analyzer tuned to the interested frequency point.

4.1.7 Distortion measurement

Mutual interference between equipment in common in crowd operating environment of the communications system. For example, second-order and third-order intermodulation distortion is common in narrowband systems. When there are two signals (F_1 and F_2) in one system, they and second harmonic distortion signals generated by them ($2F_1$ and $2F_2$) mix and become third-order intermodulation products $2F_2-F_1$ and $2F_1-F_2$ very close to original signals, thus resulting in high-order intermodulation distortion. Such distortion products are mostly generated by devices such as amplifiers and mixers in the system. Most transmission units and signal generators have harmonics and their components need to be measured.

1) Identification of distortion generated by spectrum analyzer

In the case of large signal input, the spectrum analyzer may be subject to distortion, which will affect the distortion measurement results of true signals. You can set the attenuator to determine which signal is a distortion signal generated by the spectrum analyzer. This example shows whether the spectrum analyzer is subject to harmonic distortion based on the input signal.

a) Set the output signal of the signal generator:

Set the frequency of the signal generator as 200MHz and power as 0dBm. Connect the output of the signal generator to the input port of the spectrum analyzer, as shown in Fig. 4-1. Enable the ON state of the radio frequency.

b) Set the center frequency and span of the spectrum analyzer.

Press **【Preset】** .

Press **【Freq】** , [Center Frequency] and 400[MHz].

Press **【Freq】** , [Span] and 500[MHz].

You can see on the trace of the spectrum analyzer that the harmonic distortion of the signal is subject to 200MHz deviation from the original 200MHz signal, as shown in Fig. 4-11.

c) Set the center frequency of the spectrum analyzer at the first harmonic distortion location.

Press **【Peak】** and [Next Peak]

Press **【Peak】** and [Marker→Center].

d) Set the span as 50MHz and reset the center frequency.

Press **【Freq】** , [Span] and 50[MHz].

Press [Marker→] and [Marker→Center].

e) Set the attenuator as 0dB.

Press , [Atten Auto Man] and 10[dB].

Press **【Peak】** and [Peak Track Off On].

Press [Maker] and [Delta].

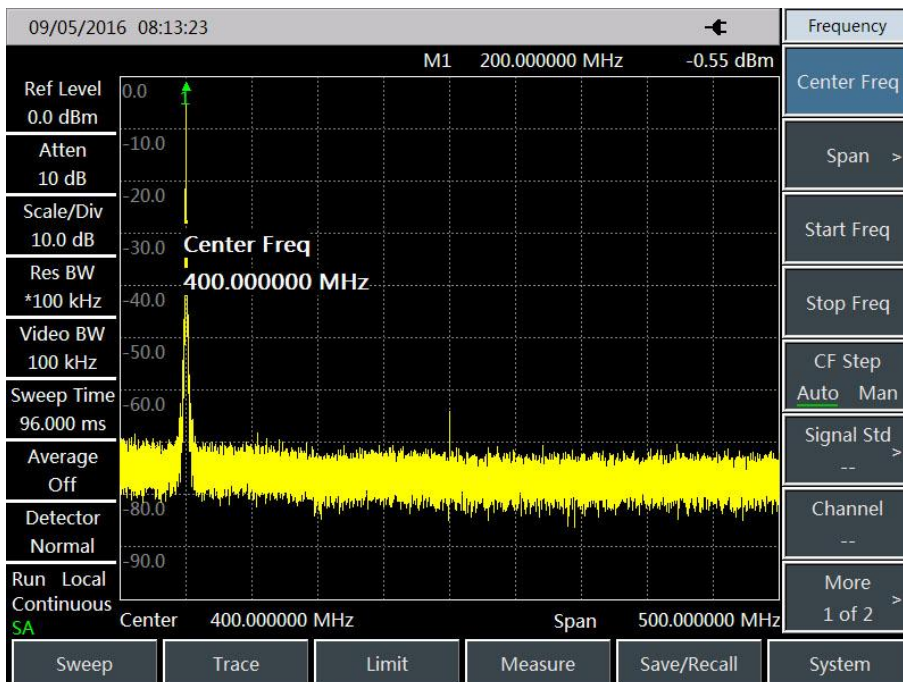

Fig. 4-12 Observation of Harmonic Distortion

f) Increase the attenuator setting to 10dB:

Press [Atten Auto Man] and 10[dB].

Observe the differential marker reading, as shown in Fig. 4-13. The reading is the distortion difference of the attenuator at 0dB and 10dB. If the attenuator is changed and the differential marker reading is 1dB or more, it indicates that the spectrum analyzer is subject to certain distortion. If the differential marker reading is not obvious, the attenuation may be increased.

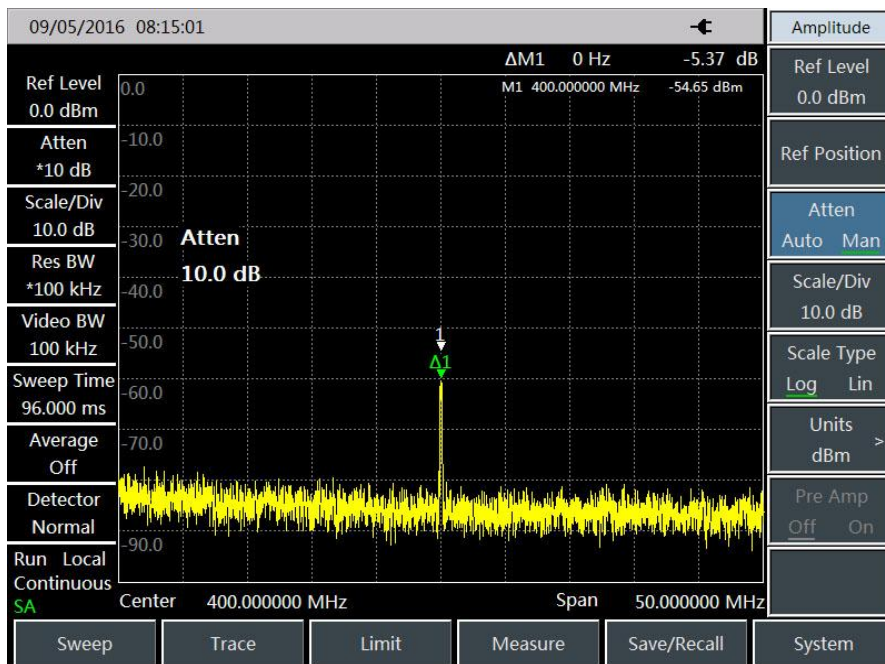

Fig. 4-13 Attenuator Setting - 10dB

The amplitude reading of the differential marker is provided by two sources: 1. If the RF attenuation is increase, S/N will decrease, and this reading will be positive. 2. If the harmonic distortion of the spectrum analyzer decreases, this reading will be negative. The larger the reading, the bigger the error of measurement. In such case, the attenuator setting may be changed to reduce absolute amplitude of such delta marker reading.

2) Quick harmonic measurement

In this section, harmonic components are measured of a signal with frequency of 1 GHz and power of -10 dBm generated by the signal generator.

a) Set the output signal of the signal generator:

Set the frequency of the signal generator as 1GHz and power as -10dBm. Connect the output of the signal generator to the input port of the spectrum analyzer, as shown in Fig. 4-1. Enable the ON state of the radio frequency.

b) Set the starting frequency and stop frequency of the spectrum analyzer.

Press **【Preset】** key.

Press **【Freq】**, [Start Freq], 800[MHz], [Stop Freq] and 2.5[GHz].

As shown in Fig. 4-14, the fundamental wave and second harmonic will be displayed on the screen.

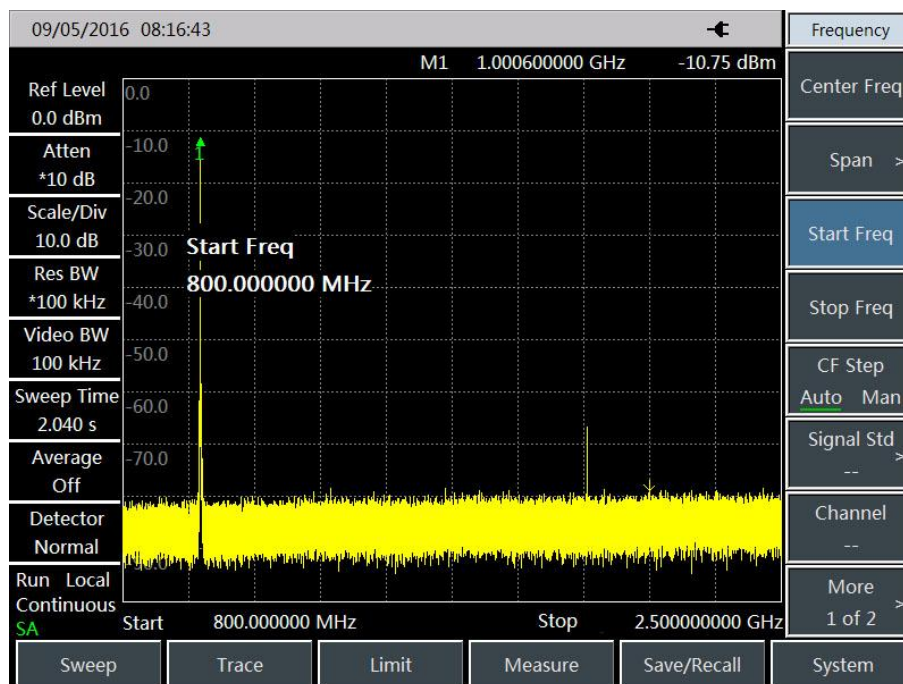

Fig. 4-14 Input Signal and Harmonic

c) Set the video bandwidth to smooth noise so as to improve the resolution.

Press [Bandwidth], [Video Bandwidth Auto Man] to enable auto off.

Use **【↓】** key to reduce video bandwidth.

d) In order to improve the measurement accuracy, set the peak level of the fundamental wave as the reference level.

Press **【Peak】** and [Peak Search], and read the peak power.

Press **【Ampt】** and [Ref Level], and set it as the peak power. Results are shown in Fig. 4-15.

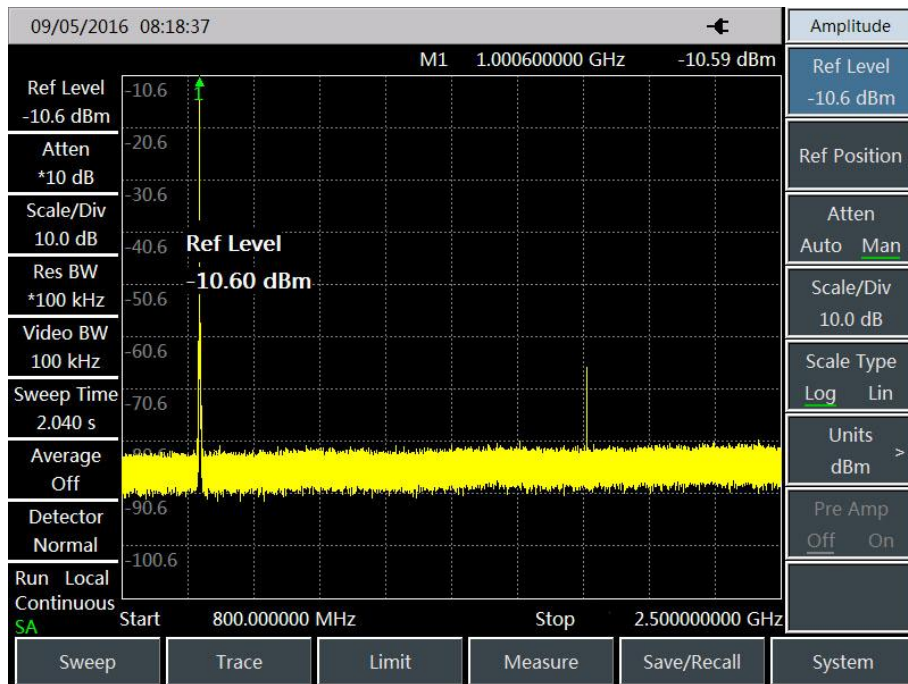

Fig. 4-15 Setting of Signal Peak as Reference Level for Maximum Accuracy

e) Activate the second marker.

Press [Delta], and [Next Peak].

In this case, the fixed marker is on the fundamental wave, while the mobile marker is on the peak point of the second harmonic, as shown in Fig. 4-16.

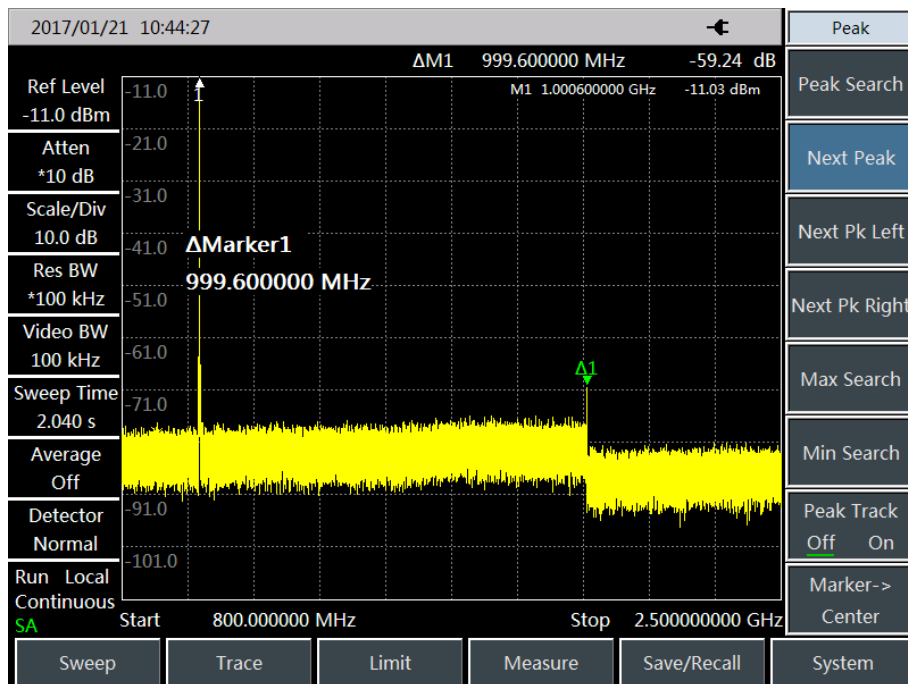

Fig. 4-16 Second Harmonic Measurement based on Marker Difference

f) Measure the harmonic distortion (Method 1).

The fundamental wave and the second harmonic as shown in the figure has an amplitude difference of

about -60 dB, or a harmonic distortion of 0.1% (see Fig. 4-17).

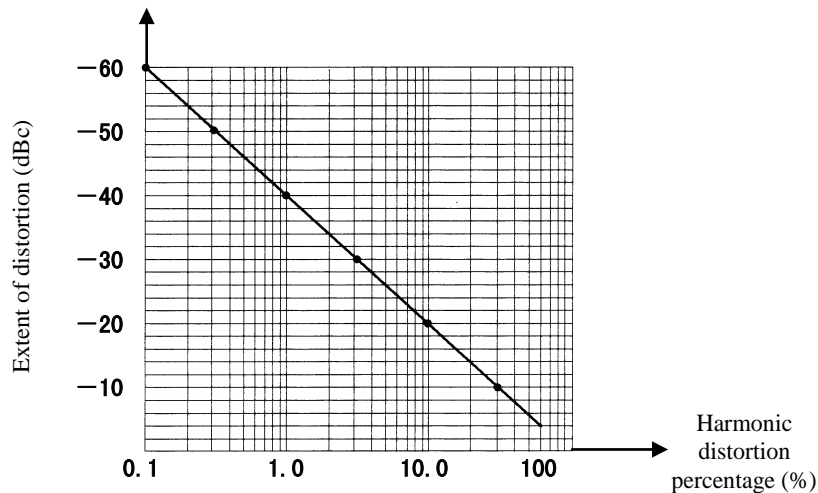

Fig. 4-17 Conversion of Percentage of Harmonic Distortion Amplitude

To measure the third harmonic, press [Next Pk Right] and read the amplitude ratio of other harmonics to the fundamental wave.

g) Measure the harmonic distortion (Method 2).

Press **【Ampt】**, [Units] and [Volt].

In this case, the unit of the differential marker will automatically change into volt. An easy way to determine distortion percentage is to change the unit to volt. Move the decimal of the proportion indicated by the differential marker rights for two places to obtain the distortion percentage. The minimum ratio that can be displayed is 0.01 or 1%.

3) Accurate harmonic measurement

It takes more steps to measure in this method, but since measurement is done with smaller span and resolution bandwidth for each signal, the signal-to-noise ratio is increased and more accurate measurement result will be obtained. It will be explained below how to measure the harmonic of 1 GHz signals.

a) Set the output signal of the signal generator:

Set the frequency of the signal generator as 1GHz and power as -10dBm. Connect the output of the signal generator to the input port of the spectrum analyzer, as shown in Fig. 4-1. Enable the ON state of the radio frequency.

b) Set the starting frequency and stop frequency of the spectrum analyzer.

Press **【Preset】** key.

Press **【Freq】**, [Start Freq], 800[MHz], [Stop Freq] and 2.5[GHz].

c) Set the video bandwidth to smooth noise so as to improve the resolution.

Press [Bandwidth], [Video Bandwidth Auto Man] to enable auto off.

Use **【↓】** key to reduce video bandwidth.

d) Reduce the span by the signal tracking function.

Press **【Peak】** to activate the signal peak of marker search.

Press **【Freq】** and [Signal Track Off On].

Press **【Freq】**, [Span] and 100[kHz].

e) Disable signal tracking.

Press **【Freq】** and [Signal Track Off On].

f) Move the signal peak to the top division to obtain the highest amplitude measurement accuracy.

Press **【Peak】** and [Peak Search], and read the peak power.

Press **【Ampt】** and [Ref Level], and set it as the peak power. Results are shown in Fig. 4-18.

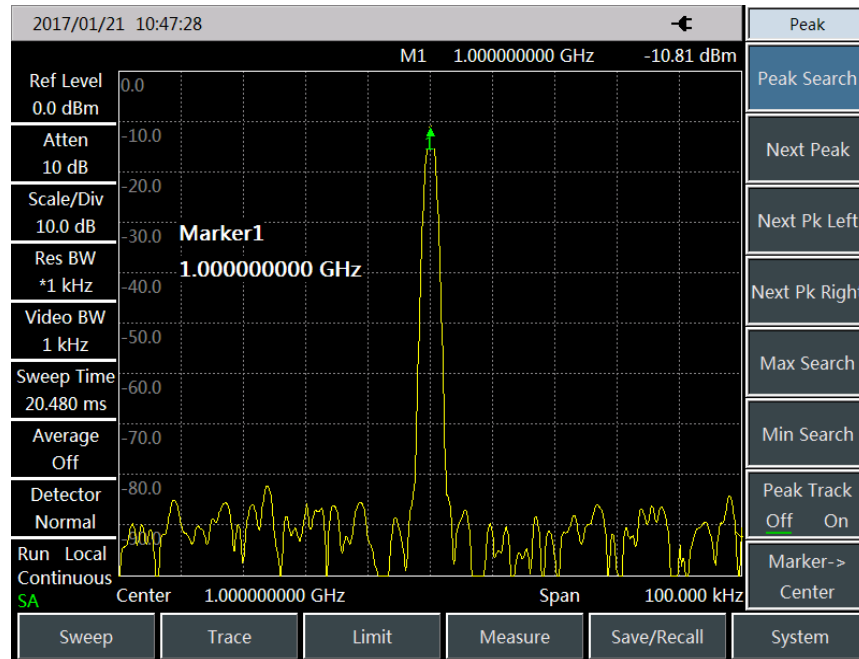

Fig. 4-18 Input Signal under 100kHz Span

g) Set the step of the center frequency as the signal frequency of the fundamental wave.

Press **【Freq】** and [CF Step Auto] and enter 1 GHz.

h) Measure the second harmonic.

Press [Maker], [Marker->], [Marker->Center] and step key **【↑】**. Change the center frequency of the spectrum analyzer to second harmonic by stepping operation. Press **【Peak】** and [Peak Search], and read the peak power.

Press **【Ampt】** and [Ref Level], and set it as the peak power. Adjust the harmonic peak to the reference level. The second harmonic amplitude is shown in Fig. 4-19.

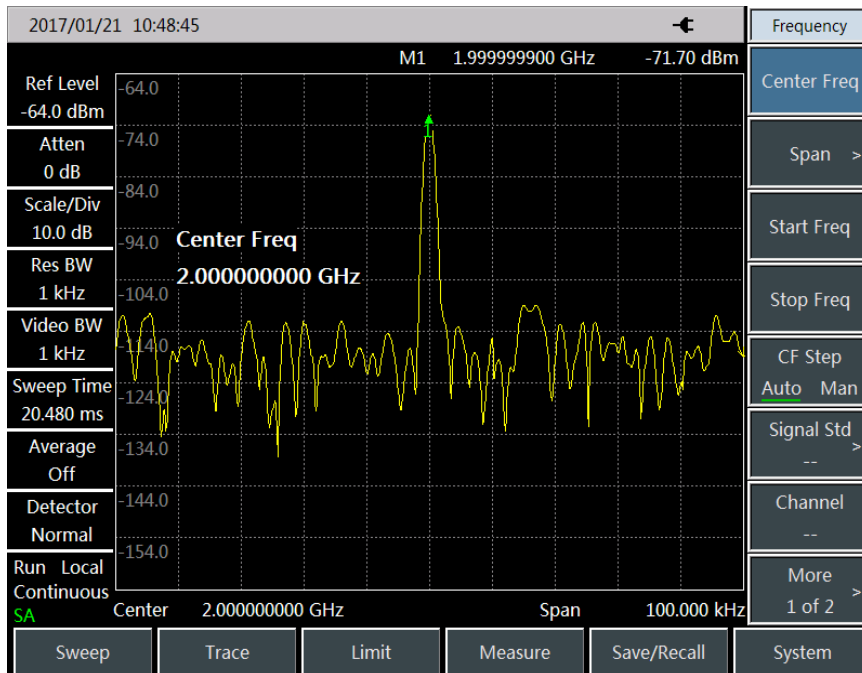

Fig. 4-19 Second Harmonic Amplitude

i) Calculate the harmonic distortion.

Change the distortion percentage of the second harmonic to fundamental wave as shown in Fig. 4-17. The unit can be changed again to volt in order to read the voltage ratio of two signals.

j) Measure other harmonics.

Repeat Step (i) to (j) to other harmonics to be measured. Calculate the distortion percentage of each harmonic.

Total signal harmonic distortion percentage is also subject to frequent test. In order to test such parameter, amplitude of each harmonic should be tested with linear unit (such as volt) rather than relative unit dBc.

Press **【Ampt】**, [Units] and [Volt] to set the amplitude unit as volt. The measured signal amplitude can be applied in the following equation to calculate the total harmonic distortion:

$$\text{Total harmonic distortion} = \frac{100 \times \sqrt{(A_2)^2 + (A_3)^2 + \dots + (A_n)^2}}{A_1} \%$$

Where:

A_1 - refers to fundamental wave amplitude (V)

A_2 - refers to second harmonic amplitude (V)

A_3 - refers to third harmonic amplitude (V)

A_n refers to n^{th} harmonic amplitude (V)

If the signal amplitude is carefully measured as shown in the above example, the obtained harmonic distortion percentage is accurate.

4.1.8 Pulse RF signal measurement

1) Definition of pulse RF signal

The pulse RF signal refers to a RF pulse string of the same repetition frequency and constant pulse width, shape and amplitude. This section introduces several methods of measuring pulse RF signal parameters, including how to measure the center frequency, pulse width and pulse repetition frequency. In addition, the measurement of peak pulse power is also discussed.

The resolution bandwidth has great influence on pulse RF signal measurement. You must understand the relationship between the resolution bandwidth and pulse repetition frequency. If the resolution bandwidth is narrower than the pulse repetition frequency, only individual frequency components of the pulse RF signal will appear on the screen. This is known as the narrow band mode. The mode in which the resolution bandwidth is broader than the pulse repetition frequency is known as the broad band mode. In this case, you can see the spectrum envelope formed by pulse segments that are equalized by the tested pulse repetition frequency.

2) Center frequency, side lobe ratio and pulse width measurement of pulse RF signal

a) Set the output signal of the signal generator:

Set the frequency of the signal generator as 1GHz and power as -20dBm. Connect the output of the signal generator to the input port of the spectrum analyzer, as shown in Fig. 4-1. Set the repetition frequency of pulse modulation as 1kHz and pulse width as 900ns. Enable the pulse modulation and RF output.

b) Set the spectrum analyzer:

The pulse RF signal is generally measured in the broad band mode. In order to prevent the influence of the video filter on measurement results, the video bandwidth should be set as 3MHz.

Press **【Preset】** key.

Press **【Freq】** , [Center Frequency] and 1[GHz].

Press **【Freq】** , [Span], 10[MHz], **【Sweep】** , [Sweep Time Auto Man] and 60[ms].

Press **【BW】** , [RBW Auto Man], 100 [kHz], [VBW Auto Man] and 100 [kHz].

Press **【BW】** , [Detector] and **【Peak】** to activate the peak detector.

Enable the center frequency function and adjust the span until the center side lobe and at least one pair of side lobes appear on the screen, as shown in Fig. 4-20.

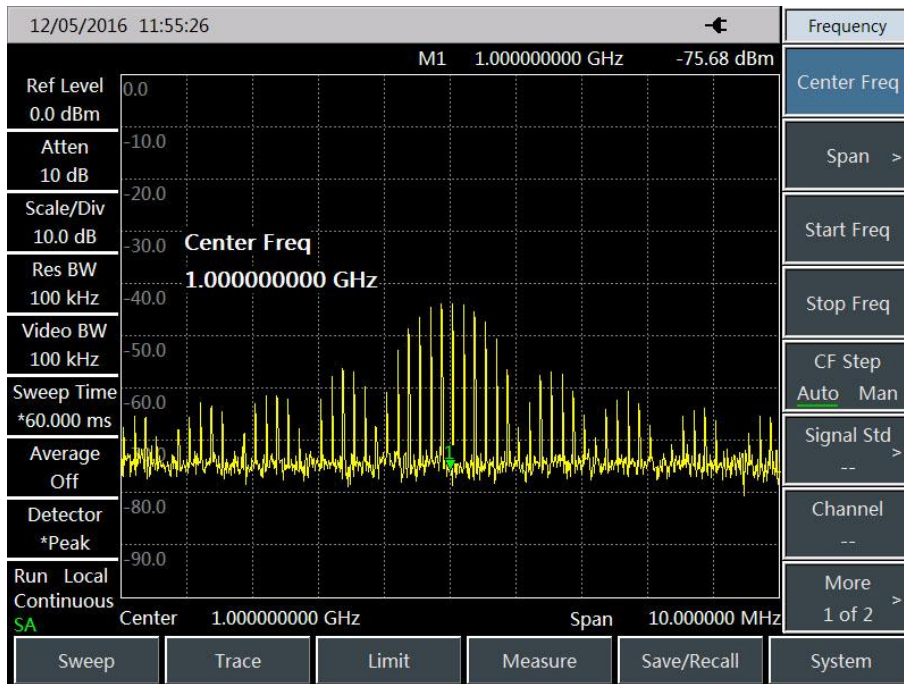

Fig. 4-20 Main Lobe and Side Lobe

Increase the sweep time (decrease the sweeping speed) until the graph is filled into a solid line, as shown in Fig. 4-21. If the spectrum line cannot be filled, it indicates that the instrument is not in the broad band mode. In this case, the following steps of measurement of the sidelobe ratio, pulse width and peak pulse power will not apply. The resolution bandwidth should be more than 1kHz.

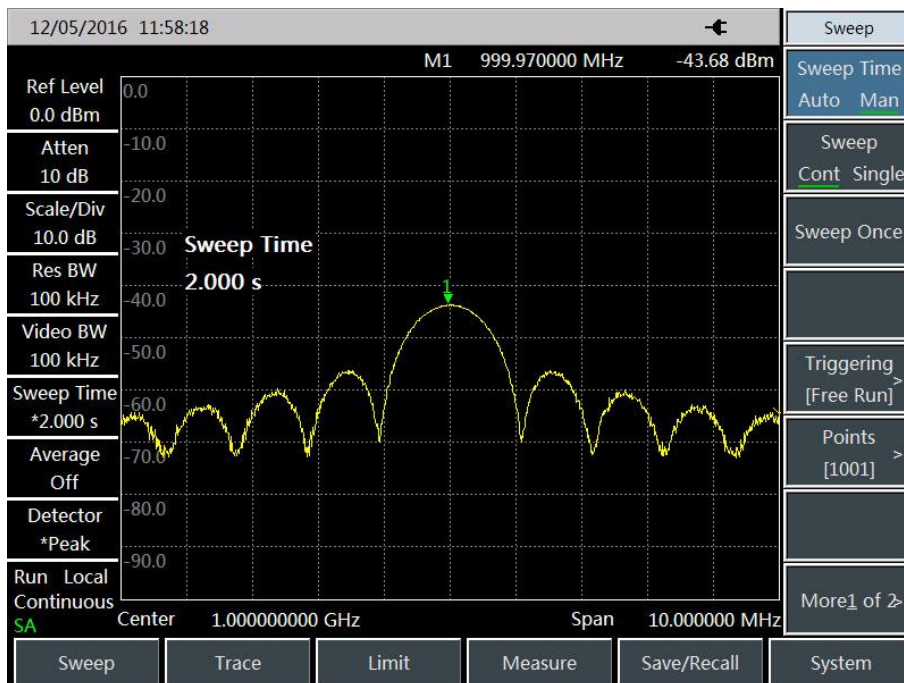

Fig. 4-21 Trace Display in Solid Line Form

c) Read the center frequency of the pulse and amplitude of the main lobe.

Press **【Peak】**.

The marker reading is the center frequency of the pulse and amplitude of the main lobe.

d) Set the marker at the center frequency of the main lobe, and measure the side lobe ratio:

Press **【Peak】** , [Maker], [Delta], **【Peak】** and [Next Peak].

The amplitude difference between the main lobe and side lobe is the side lobe ratio, as shown in Fig. 4-22.

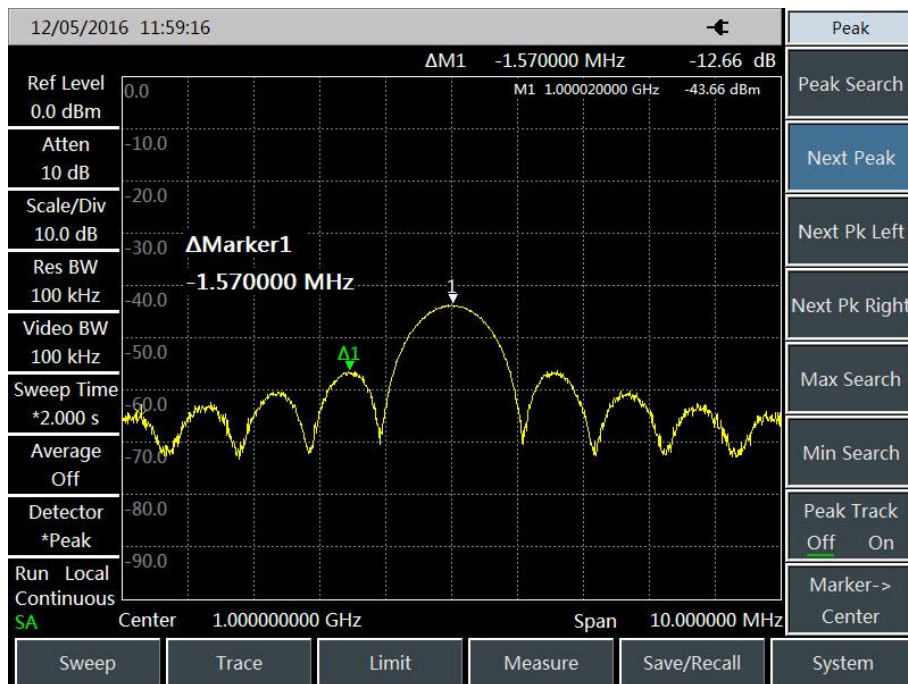

Fig. 4-22 Side Lobe Ratio Shown by the Marker

e) Measure the pulse width, which is equal to the reciprocal of the frequency difference between the peaks of two side lobe envelopes.

Press [Maker], [Delta], **【Peak】** , [Next Pk Right] and [Next Pk Right].

In this case, the reciprocal of the frequency difference indicated by the differential marker is the pulse width, as shown in Fig. 4-23. To obtain the most accurate pulse width, you can manually adjust the marker location and measure the distance between the zero crossing points of two adjacent side lobes. You can also reduce the resolution bandwidth to make the zero crossing point sharper and measurement accuracy higher.

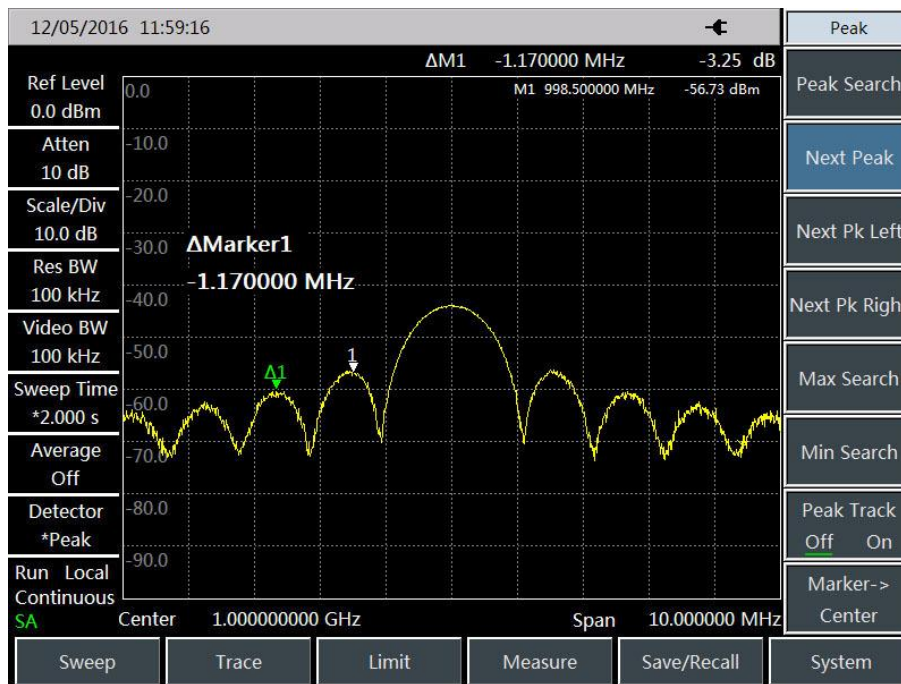

Fig. 4-23 Pulse Width Shown by the Marker

3) Pulse repetition frequency (PRF) measurement

The pulse repetition interval (PRI) refers to the time interval between any two adjacent pulse responses.

a) Set the output signal of the signal generator:

Set the frequency of the signal generator as 1GHz and power as -20dBm. Connect the output of the signal generator to the input port of the spectrum analyzer. Set the repetition frequency of pulse modulation as 1kHz and pulse width as 900ns. Enable the pulse modulation and RF output.

b) Set the spectrum analyzer:

Press **【Preset】** key.

Press **【Freq】** and 1[GHz].

Press **【Freq】**, [Span], 10[MHz], **【Sweep】**, [Sweep Time Auto Man] and 1.705[s].

Press **【BW】**, [RBW Auto Man] and 1[kHz].

Press **【BW】**, [VBW Auto Man] and 3[MHz].

Press **【BW】**, [Detector] and **【Peak】** to activate the peak detector.

Adjust the span until the main lobe and at least one side lobes appear on the screen.

Readjust the output amplitude of the signal generator until it is shown in the screen. Reduce the sweep time (i.e. increase the sweeping speed) until the contents similar to those in Fig. 4-24 are displayed.

c) Measure the pulse repetition interval:

Press **【Sweep】** and [Sweep Cont Single]

Press **【Peak】**, [Marker][Delta] and **【Peak】** [Next Peak]. The difference of two markers is the pulse repetition interval (PRI), and its reciprocal is the pulse repetition frequency (PRF).

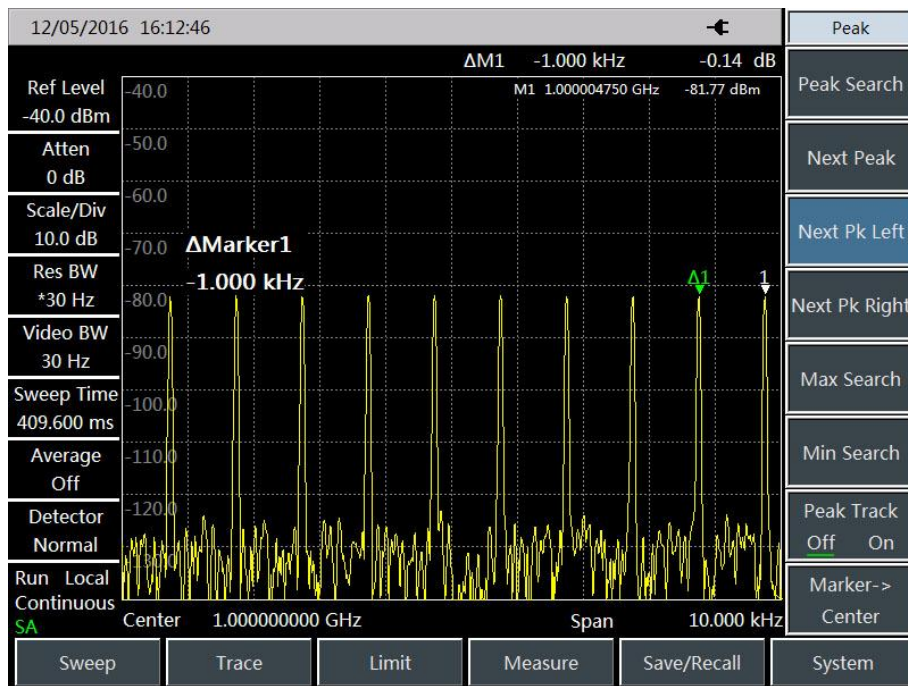

Fig. 4-24 Measurement of Pulse Repetition Frequency

4) Peak pulse power measurement

Now we have obtained the main lobe amplitude and pulse width. In addition, we can easily obtain the resolution bandwidth of the spectrum analyzer. Therefore, the peak pulse power can be obtained based on such parameters.

In the broad-band measurement mode of the spectrum analyzer:

$$\text{Peak pulse power} = (\text{main lobe amplitude}) - (20 \log T_{\text{eff}} \times \text{BW}_i)$$

Where:

T_{eff} - pulse width, in second. Second

BW_i - impact bandwidth, in Hz (equal to the resolution bandwidth applied in 1.5× “Pulse width measurement”)

In the narrow-band measurement mode of the spectrum analyzer:

$$\text{peak pulse power} = (\text{main lobe amplitude}) - (20 \log T_{\text{eff}}/T)$$

Where:

T_{eff} - pulse width, in second. Second

T —pulse repetition frequency

The phenomenon in which the peak pulse power is not equal to the main lobe amplitude is known as pulse desensitization. The sensitivity of the spectrum analyzer will not be decreased by the pulse signal. Accurately, pulse desensitization is caused by distribution of the CW carrier power of pulse modulation to a number of spectrum components (i.e. carrier and sideband). Therefore, each spectrum only contains part of the total power.

Caution

In measurement of the main lobe amplitude, you should change the attenuator of the spectrum analyzer and verify that the main lobe amplitude will not change accordingly. If the change exceeds 1dB, it indicates that the spectrum analyzer is in the gain compression state. In this case, you must increase the attenuation amount of the attenuator.

4.1.9 Signal source measurement (option)

The signal source measurement mode includes independent source output mode and generator output mode, of which the independent source mode is point frequency source mode to realize the signal output at single frequency point and fixed power, and the generator output mode needs to coordinate with spectral analysis function. Under the generator mode, the signal source will scan synchronously with the frequency under spectral analysis.

1) Independent source measurement

Under the independent source measurement mode, it is allowed to realize the signal output at fixed frequency by the following steps:

- Press **【Measure】** → [Generator] → [Generator Off On], the point frequency source output will be selected by default after the Generator switch is turned on;
- Press **【Measure】** → [Generator] → [Output Power 0dBm], it is allowed to set the power of output signal.
- Press **【Measure】** → [Generator] → [CW Freq 1GHz], it is allowed to set the frequency of output signal.

The signal with output frequency of 1GHz and output power of 0dBm is as shown in Fig. 4-25:

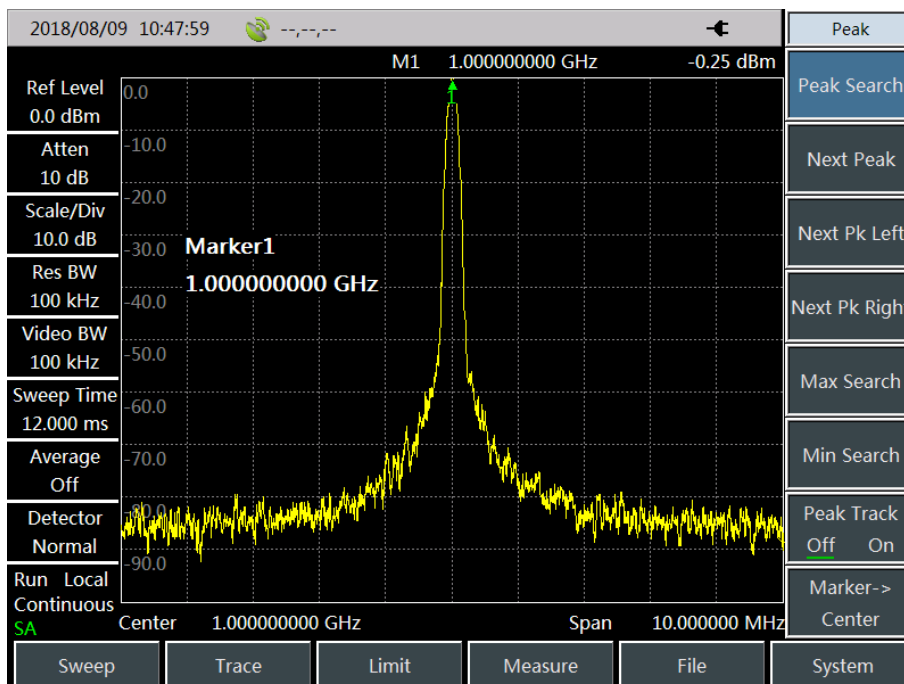

Fig. 4-25 Schematic diagram of point frequency source output signal

2) Generator measurement

Under the tracking mode, it is allowed to measure the magnitude-frequency characteristics of measured piece by using the synchronous frequency scan of signal source and spectral analysis. For details, please refer to the following setting procedures:

- Press **【Freq】** → [Start Freq], to set the start frequency as 100MHz;
- Press **【Freq】** → [Stop Freq], to set the stop frequency as 4GHz;
- Press **【Measure】** → [Generator] → [Generator Off On], to start the source switch;
- Press **【Measure】** → [Generator] → [Power -20dBm], to set the power of output signal;
- Press **【Measure】** → [Generator] → [Mode CW Track], to change the signal source mode to tracking mode.

The schematic diagram of output signal is as shown in Fig. 4-26:

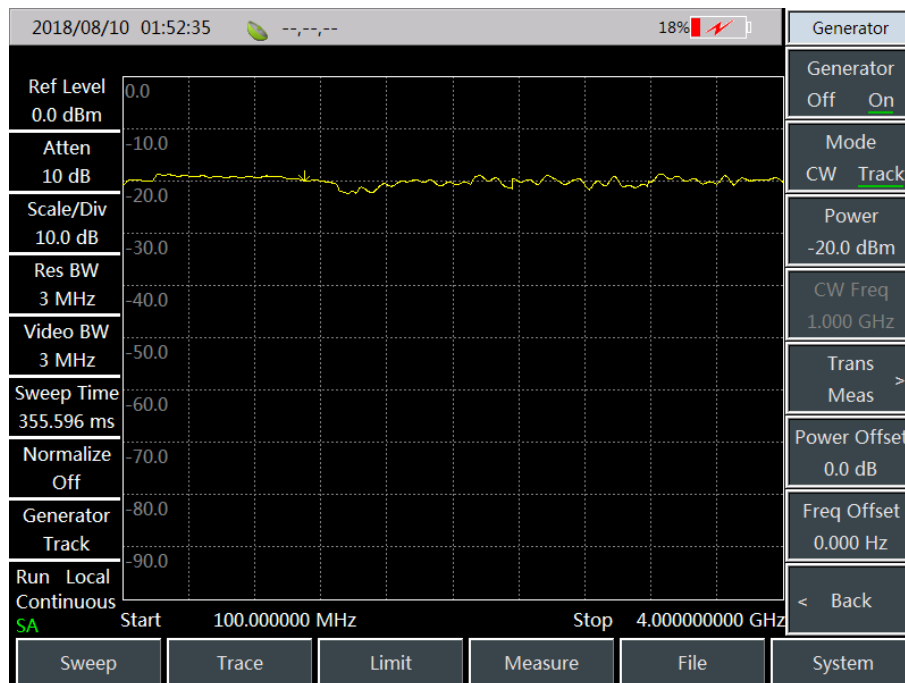

Fig. 4-26 Schematic diagram of tracking mode

3) Generator normalized measurement

The normalized measurement is to subtract the effect of cable loss from the measuring process. It can reflect the magnitude-frequency characteristics of measured piece more accurately. For example, to test the magnitude-frequency characteristics of 2.3GHz~2.4GHz band-pass filter, it is allowed to conduct the following procedures:

- Press **【Freq】** → [Start Freq], to set the start frequency as 2.1GHz;
- Press **【Freq】** → [Stop Freq], to set the stop frequency as 2.6GHz;
- Press **【Freq】** → [Generator] → [Generator Off On], to start the source switch;

- d) Press **【Measure】** → [Generator] → [Mode CW Track], to change the signal source mode to tracking mode;
- e) Connect the cable to signal source RF output end and frequency spectrum input end, and press **【Measure】** → [Generator] → [Trans Meas] → [Normalize Off On], to start the normalization switch;
- f) After the scanning is completed, it is allowed to add the filter of measured piece and directly observe the magnitude-frequency characteristics of measured piece.

The magnitude-frequency characteristics diagram of 2.3GHz~2.4GHz band-pass filter is as shown in Fig. 4-27:

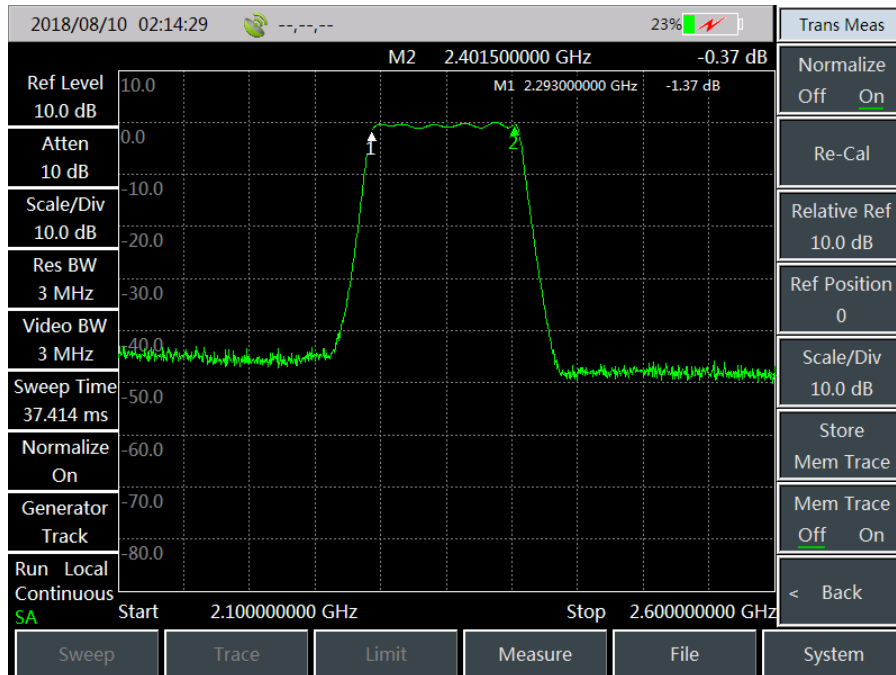

Fig. 4-27 Magnitude-frequency characteristics diagram of 2.3GHz~2.4GHz band-pass filter

Section 2 Structure of Spectrum Analysis Menu

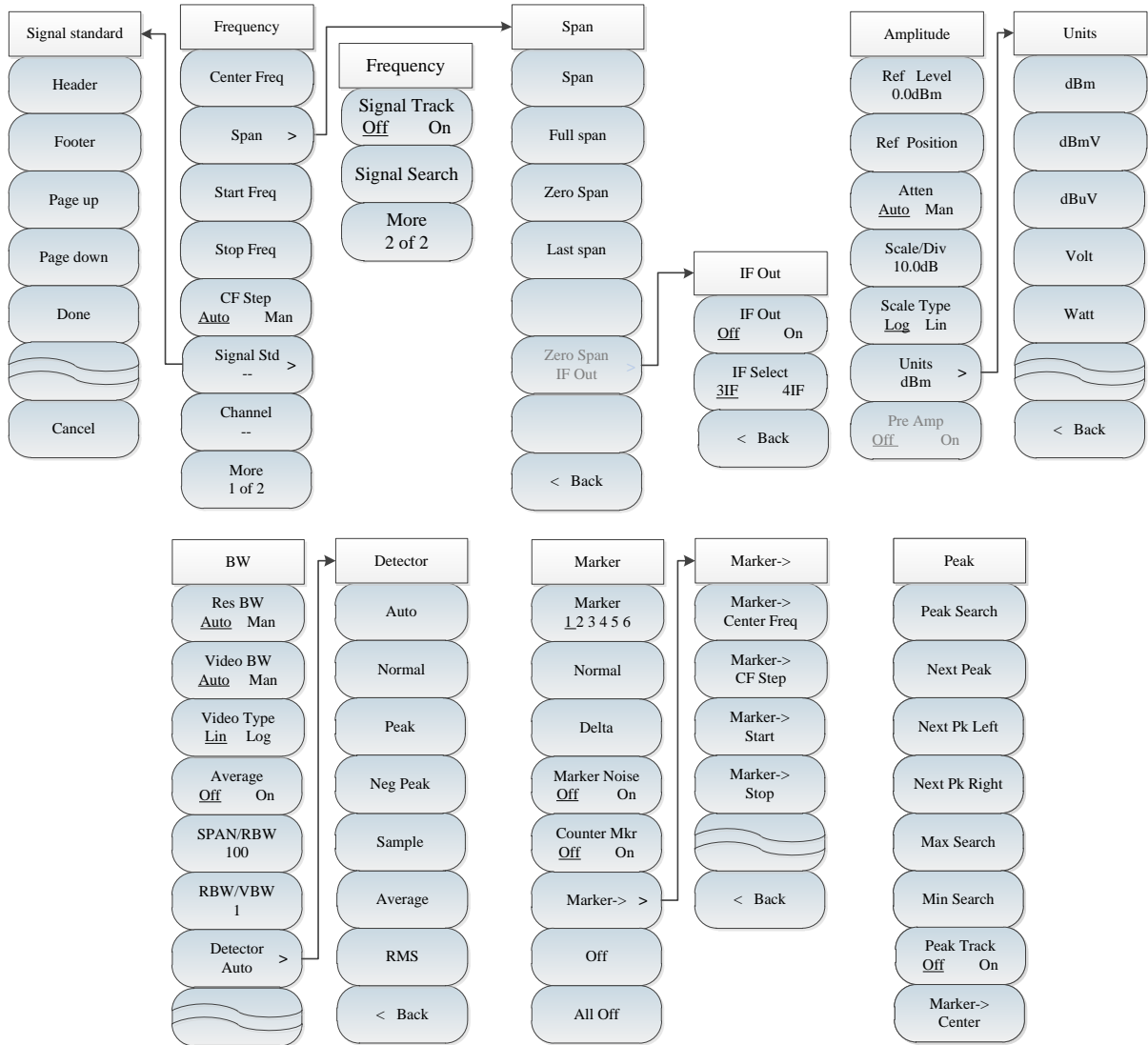

Fig. 4-30 Overall Block Diagram of Spectrum Analysis Menu

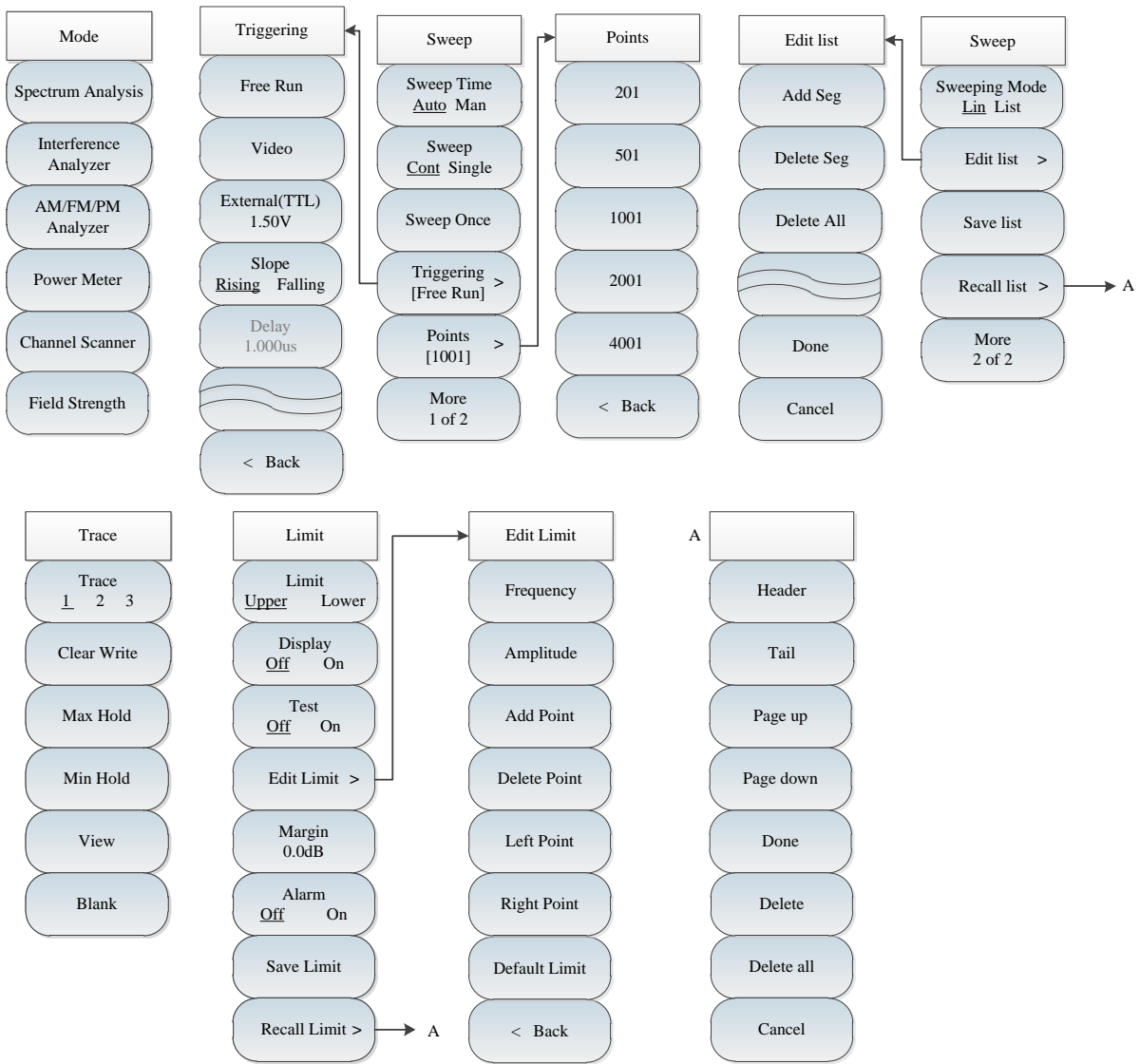

Fig. 4-31 Overall Block Diagram of Spectrum Analysis Menu (continued)

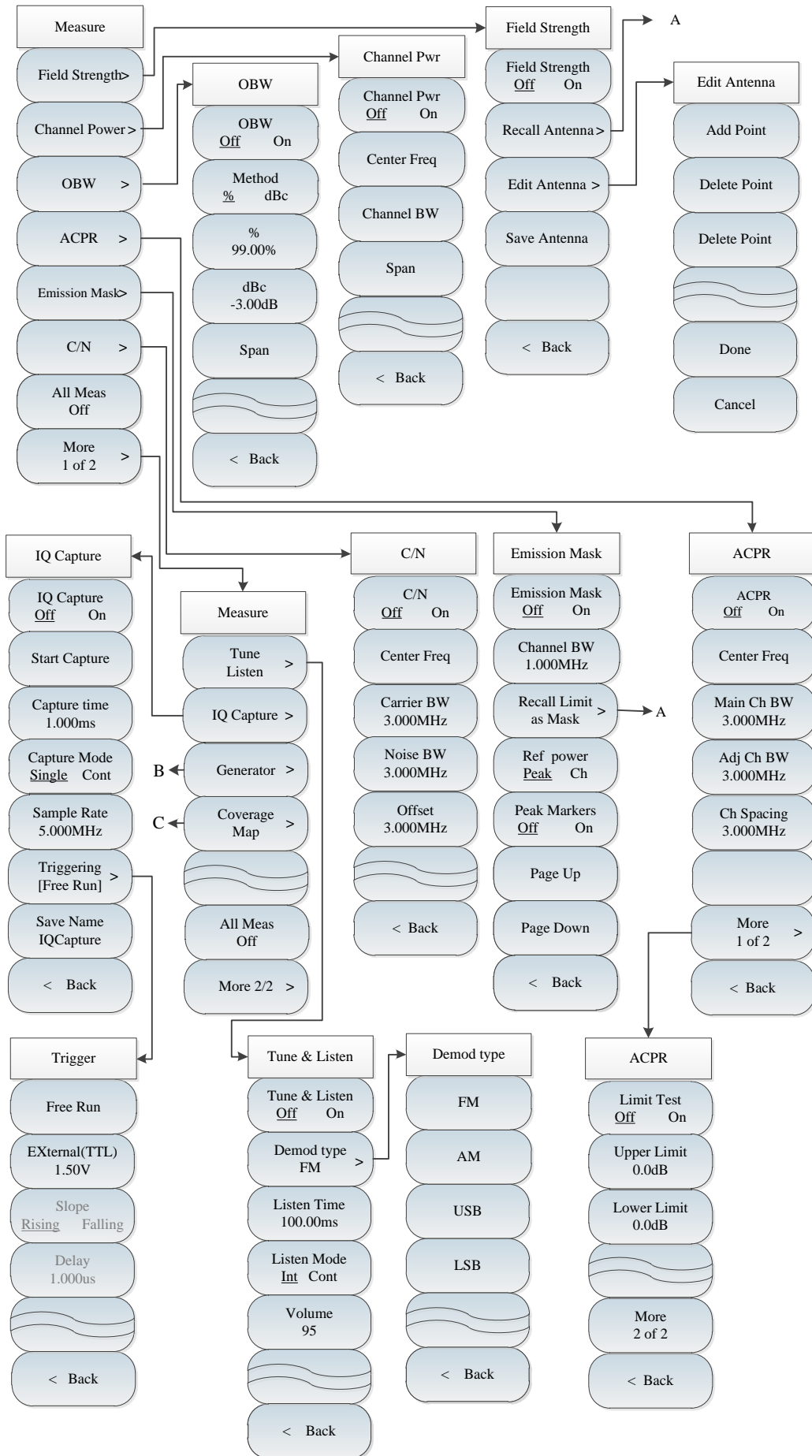

Fig. 4-32 Overall Block Diagram of Spectrum Analysis Menu (continued)

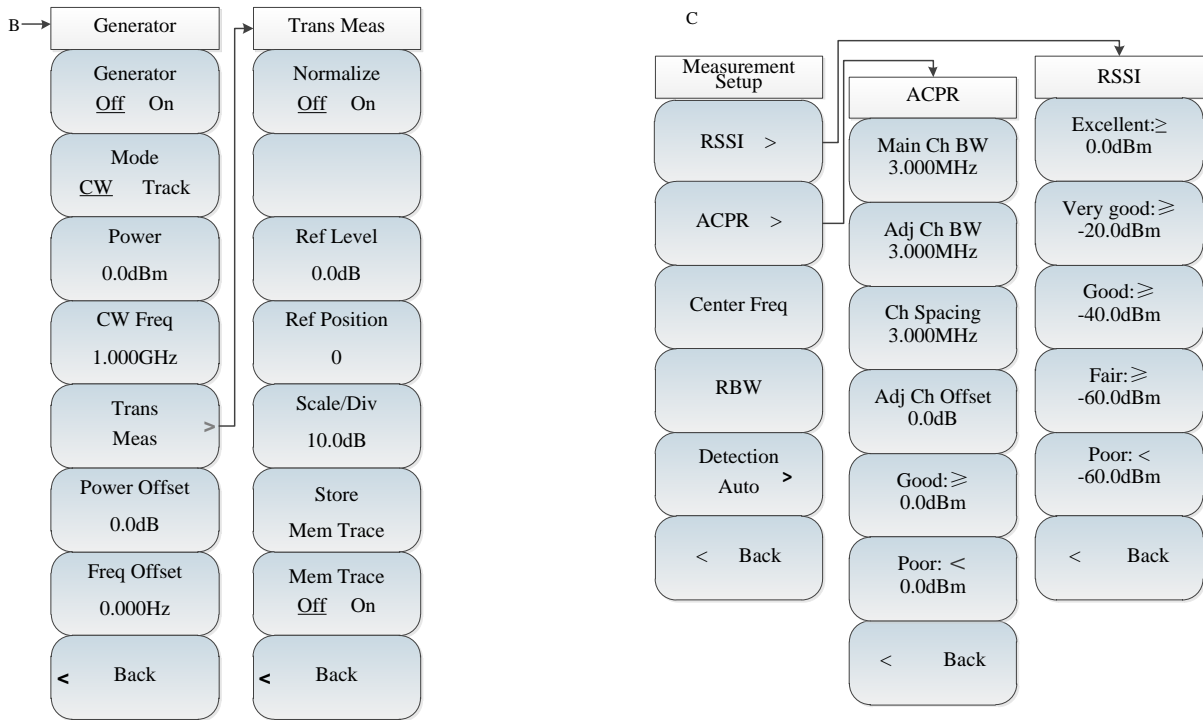

Fig. 4-33 Overall Block Diagram of Spectrum Analysis Menu (continued)

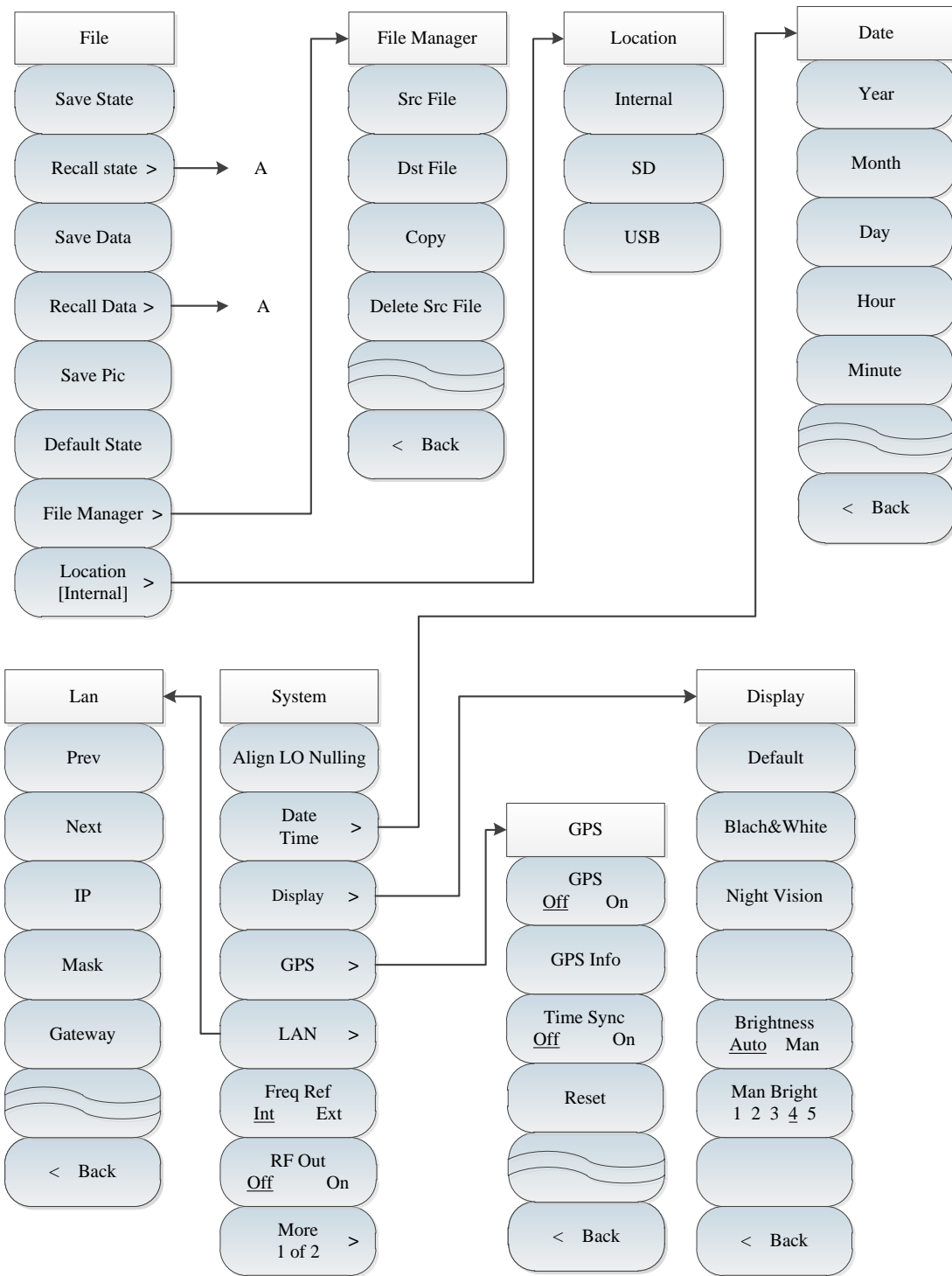

Fig. 4-34 Overall Block Diagram of Spectrum Analysis Menu (continued)

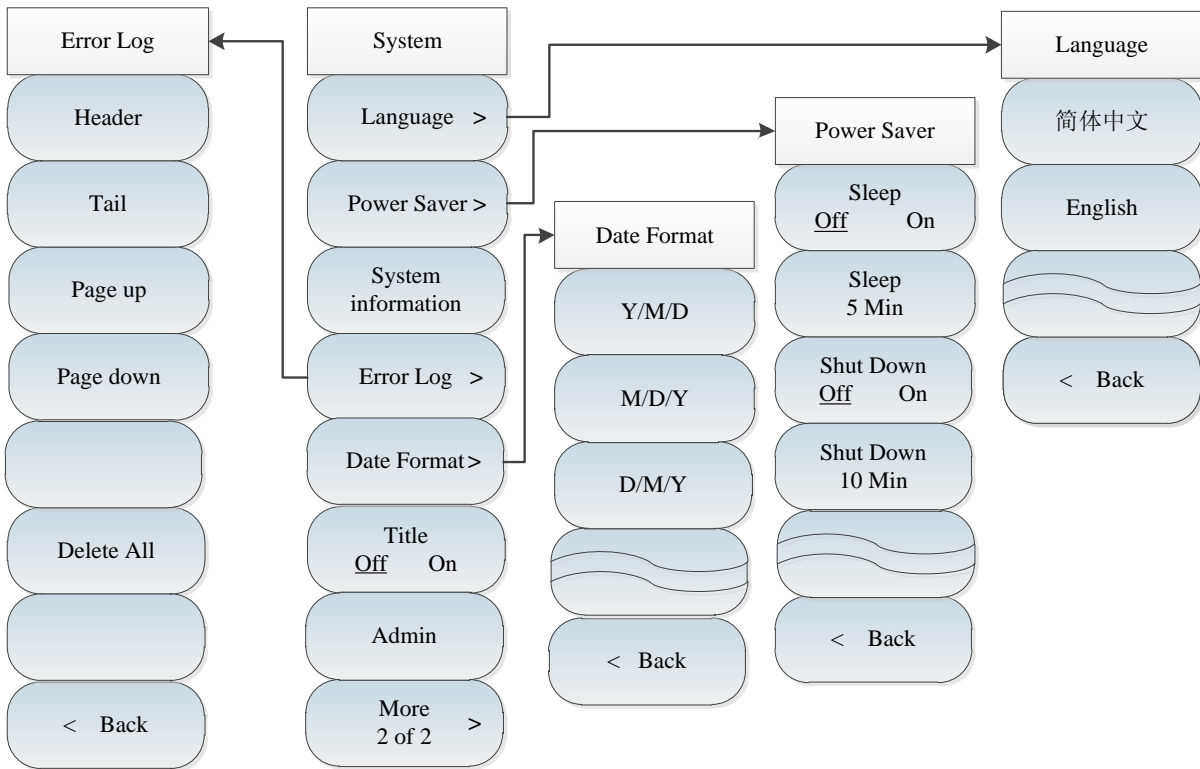

Fig. 4-35 Overall Block Diagram of Spectrum Analysis Menu (continued)

Section 3 Description of “Spectrum Analysis” Menu

4.3.1 Frequency menu

Frequency	<p>{Center frequency}: Press →[Center Freq] and set it with the number keys on the front panel. Then select [GHz], [MHz], [kHz] or [Hz] in the frequency unit menu, or set the center frequency with the 【↑】 or 【↓】 key or knob.</p>
Center Freq	<p>{Span}: Press 【Freq】→[Span] to enable the span setting menu. Refer to the [Span] menu description for specific details.</p>
Span >	<p>{Starting frequency}: Press 【Freq】 → [Start Freq], and set it with number keys on the front panel. Select [GHz], [MHz], [kHz] or [Hz] in the frequency unit menu or set the starting frequency with the 【↑】 or 【↓】 key or knob.</p>
Start Freq	<p>{Stop Freq}: Press 【Freq】 → [Stop Freq], and set it with number keys on the front panel. Select [GHz], [MHz], [kHz] or [Hz] in the frequency unit menu or set the stop frequency with the 【↑】 or 【↓】 key or knob.</p>
Stop Freq	<p>{Step frequency}: Press 【Freq】 → [Step Freq], and set it with number keys on the front panel. Select [GHz], [MHz], [kHz] or [Hz] in the frequency unit menu or set the step frequency with the 【↑】 or 【↓】 key or knob.</p>
CF Step <u>Auto</u> Man	<p>{Signal Std}: Click it and the signal standard menu will pop up, including soft menus such as [Head], [Tail], [Page Up], [Page Down] and [Done]. Click [Done] to select the required signal standard file.</p>
Signal Std -- >	<p>{Channel}: Click it to display the contents and number of the selected signal standard.</p>
Channel --	<p>{Special note}: The channel should be set based on the applied signal standard; otherwise, the prompt that setting is not allowed will pop up.</p>
More 1 of 2	

Frequency	<p>{Signal Track <u>Off</u> On}: Click this menu to enable or disable signal tracking. After each sweeping, the active marker will be set at the peak point of the signal by the signal tracking function. The peak frequency will be set as the center frequency. By selecting [Signal <u>On</u> Off], the signal drifting slowly will be automatically kept at the center of the screen.</p>
Signal Track <u>Off</u> On	<p>{Signal Search}: Click this menu to enable signal search. After search the whole span, the active marker will be set at the peak point of the signal, if no signal, there will be a tip shown on the screen.</p>
Signal Search	<p>{Special note}: The channel should be set based on the applied signal standard; otherwise, the prompt that setting is not allowed will pop up.</p>
More 2 of 2	

4.3.2 Span menu

Span	<p>{Span}: Press 【Freq】 → [Span] and set the span of the current mode with number keys on the front panel. Select [GHz], [MHz], [kHz] or [Hz] in the frequency unit menu or set the span with the 【↑】 or 【↓】 key or knob. The span step should be 1, 2 or 5.</p>
Span	<p>{Full span}: Press 【Freq】 → [Span]→ [Full Span], and set the span of the current measurement mode as the maximum span. The full span is related to the instrument mode. For 4024G series spectrum analyzer, the full span is 44.1GHz.</p>
Full span	<p>{Zero span}: Press 【Freq】 →[Span]→[Zero Span], and set the span of the current measurement mode as the minimum span. Under the full span, it should be set as 0Hz.</p>
Zero Span	<p>{Last span}: Press 【Freq】 → [Span]→ [Last Span], and set the span of the current measurement mode as the last span.</p>
Last span	<p>{Zero Span IF Out}: Press 【Freq】 → [Span]→ [Zero Span IF Out] to activate the IF output menu.</p>
Zero Span IF Out	<p>{Special note}: The full span and zero span function will be invalid when some measurement functions are enabled.</p>
Zero Span IF Out	<p>{Special note}: The IF output menu, as a functional option, can only be applied in the zero span mode.</p>
< Back	

4.3.3 IF output menu

The zero-span IF output function is optional. The IF signal output can be achieved through the IF output interface under the zero span to meet the user's measurement requirements.

IF Out	<p>[Special note]: The IF output menu, as a functional option, can only be applied in the zero span mode.</p>
IF Out <u>Off</u> On	<p>{IF Out <u>Off</u> On}: Press 【Freq】→ [Span]→ [IF Out]→ [IF Out <u>Off</u> On] and enable or disable IF output with keys.</p>
IF Select <u>3IF</u> 4IF	<p>{IF Select <u>3IF</u> 4IF}: Press 【Freq】 →[Span]→[IF Out]→[IF Select <u>3IF</u> 4IF] and select the 3IF or 4IF output with keys.</p>
< Back	<p>{Back}: Press 【Freq】 → [Span]→ [IF Out]→ [Back] to go back to the span menu.</p>
	<p>[Special note]: The IF output function is an option under zero span. If 3IF is selected, the IF output interface will output the third IF frequency, i.e. 140.25MHz; and if 4IF is selected, the IF output interface will output the fourth IF frequency, i.e. 31.25MHz.</p>

4.3.4 Amplitude menu

Amplitude	<p>{Ref Level}: Press 【Ampt】 → [Ref Level] and set it with number keys on the front panel. Select [dBm], [-dBm], [mV] or [μV] in the frequency unit menu, or set the reference level with the 【↑】 or 【↓】 key or knob.</p> <p>{Ref Position}: Press 【Ampt】 → [Ref Position], and select the position of the reference line in the rectangular coordinate graph by clicking corresponding number keys.</p>
Ref Level 0.0dBm	<p>{Atten <u>A</u>uto Man}: Press 【Ampt】 → [Atten <u>A</u>uto Man] to adjust the input attenuation of the spectrum analyzer. In the AUTO mode, the input attenuator is associated with reference level. Under Man Mode, use number keys, stepping keys or knob to change the attenuation of the attenuator. The attenuation range is 0dB to 50dB.</p>
Ref Position	
Atten <u>A</u> uto Man	<p>{Scale/Div}: Press 【Ampt】 → [Scale/Div]. Adjust the size of the vertical coordinate division on the screen, and set the value with number keys on the front panel. Select the frequency unit, or set the value with the 【↑】 or 【↓】 key or knob. The setting range is 0.1dB/division to 20dB/division. The default setting is 10dB/division.</p>
Scale/Div 10.0dB	<p>{Scale Type <u>L</u>og Lin}: Press 【Ampt】 → [Scale Type <u>L</u>og Lin], and set the vertical-axis scale as the logarithmic or linear scale. The default logarithmic scale is in dBm, while the default linear scale is in mV.</p>
Scale Type <u>L</u> og Lin	
Units dBm >	<p>{Amplitude unit}: Press 【Ampt】 → [Units], and select the vertical-axis unit, including [dBm], [dBmV], [dBuV], [Volt] and [Watt].</p>
Pre Amp <u>O</u> ff On	<p>{Pre Amp <u>O</u>ff On}: Turn on or off the pre Amp. This function cannot be activated until the reference level is less than -40dBm.</p>
	<p>[Special note]: The level of the input signal must be +13dBm or less before the pre-amplifier is turned on; otherwise, the instrument will be damaged.</p>

4.3.5 Bandwidth menu

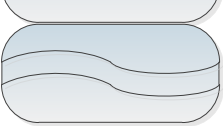
BW	<p>{Res BW <u>A</u>uto Man}: Press 【BW】 → [Res BW <u>A</u>uto Man] and adjust the resolution bandwidth within the range of 1Hz-10MHz. The resolution bandwidth can be changed with the number keys, step keys or knob in the manual mode, by the step of 1, 3 or 10. It can be changed with the span according to the SPAN/RBW value in the auto mode.</p>
Res BW <u>A</u> uto Man	<p>{Video BW <u>A</u>uto Man}: Press 【BW】 → [Video BW <u>A</u>uto Man] to adjust the video bandwidth in the active functional zone. The adjustment range is 1Hz-10MHz. In the manual mode, the video bandwidth can be changed with the number keys, step keys or knob in the manual mode, by the step of 1, 3 or 10. In the auto mode, it can be changed with the span according to the RBW/VBW value.</p>
Video BW <u>A</u> uto Man	<p>{Average <u>O</u>ff On}: Press 【BW】 → [Average <u>O</u>ff On] to enable the averaging function. traces will be continuously averaged to achieve the smoothing effects.</p>
Video Type <u>L</u> in Log	<p>{SPAN/RBW}: Press 【BW】 → [SPAN/RBW] to set the ratio of the current span to resolution bandwidth. The value will be displayed in the input zone. The default setting is 100. This ratio can be applied in the associated mode of the resolution bandwidth.</p>
Average <u>O</u> ff On	<p>{RBW/VBW}: Press 【BW】 → [RBW/VBW] to set the ratio of the current video bandwidth to resolution bandwidth. The default setting is 1. When the resolution bandwidth changes, the video bandwidth will automatically change in the auto mode to meet the ratio requirements. This ratio will be displayed in the input zone and applied in the associated mode of both bandwidths. If a new ratio is selected, the video bandwidth will change to meet the new ratio requirements, while the resolution bandwidth will remain unchanged.</p>
SPAN/RBW 100	<p>{Detector}: Press 【BW】 → [Detector], and the soft menu of detector mode will pop up. Refer to the [Detector] menu description for details.</p>
RBW/VBW 1	
Detector Auto >	
	

4.3.6 Detector menu

Detector	<p>{Auto}: The default setting of the detector menu is the normal mode.</p>
Auto	<p>{Normal}: If noise is detected in this mode, the positive and negative peak measurement results will be displayed at the same time, so as to achieve the display effects similar to those of the analog instrument. If the signal is detected, only the positive peak will be displayed. This is the most commonly used detector mode. You can see the signal and noise floor at the same time, with no signal loss.</p>
Normal	<p>{Peak}: Enable the positive peak mode. This mode can ensure that no peak signal will be missing, thus facilitating measurement of signals close to the noise floor. The positive peak detector is selected in the [Max Hold] mode.</p>
Peak	<p>{Neg Peak}: Enable the negative peak mode. In this mode, the negative peak level will be displayed on the trace. This is applied in self-inspection of the broadband MMW spectrum analyzer in most cases, and rarely applied in measurement. The modulation envelope of AM signals can be well reproduced. The positive peak detector is selected in the [Min Hold] mode.</p>
Neg Peak	<p>{Sample}: Enable the sample mode of the detector. This mode is conducive for noise signal measurement. Compared with the normal mode, noise can be better measured. This mode is generally applied in the video average and noise marker function.</p>
Sample	<p>{Average}: Enable the average mode of the detector. The average of sample data within each sampling interval will be displayed on the trace.</p>
Average	<p>{RMS}: Enable the RMS mode of the detector. The RMS value of sample data within each sampling interval will be displayed on the trace.</p>
RMS	<p>{Back}: Go back to the previous menu.</p>
< Back	

4.3.7 Marker menu

	<p>{Marker 1 2 3 4 5 6}: Press 【Marker】 → [Marker 1 2 3 4 5 6] to select various markers. Activate one marker and set it at the trace center. The values will be displayed in the marker display zone in the right upper corner of the screen.</p>
Marker	<p>{Normal}: Press 【Marker】 → [Normal] to display the marker frequency and amplitude. Move the active marker with the knob, step keys or number keys. The default amplitude is in dB.</p>
Marker 1 2 3 4 5 6	<p>{Delta}: Press 【Marker】 → [Delta] to display the amplitude difference and frequency difference (time difference under zero bandwidth) of two markers. Move the active marker with the knob, step keys or number keys. The default amplitude difference is in dB.</p>
Normal	
Delta	<p>{Marker Noise <u>Off</u> On}: Press 【Marker】 → [Marker Noise <u>Off</u> On] to enable or disable the noise marker. If the ON state is selected, the noise marker will be active. Read the noise power at which noise is normalized to 1Hz bandwidth near the active marker. In this case, the “RMS” mode of the detector is active.</p>
Marker Noise <u>Off</u> On	
Counter Mkr <u>Off</u> On	<p>{Counter Mkr <u>Off</u> On}: Press 【Marker】 → [Counter Mkr <u>Off</u> On] to enable or disable the marker counter function. If no marker is active but the marker counter function is enabled, one mobile marker will be activated in the middle of the screen.</p>
Marker-> >	
Off	<p>{Marker >>}: Press 【Marker】 → [Marker->], and soft menus related to the marker functions will pop up. Such menus are related to the frequency and bandwidth of the spectrum analyzer and the normal or differential mode of the marker. By using such marker functions, the user can change spectrum analyzer settings with the marker as the reference.</p>
All Off	<p>{Off}: Press 【Marker】 → [Off] to disable the current marker and related marker functions, such as: [marker Noise].</p> <p>{All Off}: Press 【Marker】 → [All Off] to disable all markers and related marker functions, such as: [marker Noise].</p>

Marker->	{Marker→Center} : Press 【Marker】 → [Marker→] → [Marker→Center]. The marker will move to the center frequency, and the center frequency will be displayed on the screen.
Marker-> Center Freq	{Marker→CF Step} : Press 【Marker】 → [Marker→] → [Marker→CF Step] and set the step of the center frequency. The step is equal to the marker frequency. If the differential marker function is activated, the frequency step is equal to the frequency of the differential marker.
Marker-> CF Step	{Marker→Start} : Press 【Marker】 → [Marker→] → [Marker→Start], and set the starting frequency as the marker frequency.
Marker-> Start	{Marker→Stop} : Press 【Marker】 → [Marker→] → [Marker→Stop] and set the stop frequency as the marker frequency.
Marker-> Stop	{Back} : Go back to the previous menu.
< Back	

4.3.8 Peak menu

Peak	{Maximum Peak} : Press 【Peak】 → [Peak Search] to set one marker at the peak of the trace. The marker frequency and amplitude will be displayed in the right upper corner of the screen.
Peak Search	{Next Peak} : Press 【Peak】 → [Next Peak] to move the active marker to next peak associated with the current marker location on the trace. The lower peak can be rapidly found by repeatedly pressing this key.
Next Peak	{Next Pk Left} : Press 【Peak】 → [Next Pk Left] to find next peak on the left side of the current marker location.
Next Pk Left	{Next Pk Right} : Press 【Peak】 → [Next Pk Right] to find next peak on the right side of the current marker location.
Next Pk Right	{Max Search} : Press 【Peak】 → [Max Search] to set one marker at the lowest point of the trace. The marker frequency and amplitude will be displayed in the right upper corner of the screen.
Max Search	{Min Search} : Press 【Peak】 → [Min Search] to set one marker at the lowest point of the trace. The marker frequency and amplitude will be displayed in the right upper corner of the screen.
Min Search	{Peak Track Off On} : Press 【Peak】 → [Peak Track <u>Off</u> On] to enable the peak tracking function. The current marker will search the peak once after each sweeping. Any operation will not be allowed if the peak tracking function is disabled.
Peak Track <u>Off</u> On	{Marker→} : Press 【Peak】 → [Marker→] to set the marker frequency as the center frequency. This function can be applied to rapidly move the signal to the screen center.
Marker-> Center	

4.3.9 Mode menu

The default functional mode under the mode menu is the spectrum analyzer mode. You can add the following functional options according to the needs: interference analyzer, AM-FM-PM analyzer, power meter, channel scanner and field strength.

Mode	{Spectrum Analyser} : Press 【Mode】 → [Spectrum Analyzer] to enable the spectrum analyzer mode.
Spectrum Analysis	{Interference Analyzer} : Press 【Mode】 → [Interference Analyzer] to enable the interference analyzer mode. Refer to Chapter V “Interference Analyzer Mode” for details.
Interference Analyzer	{AM-FM-PM Demodulation} : Press 【Mode】 → [AM-FM-PM Analyzer] to enable the AM-FM-PM analyzer mode. Refer to Chapter VII “AM-FM-PM Analyzer Mode” for details.
AM/FM/PM Analyzer	{Power meter} : Press 【Mode】 → [Power Meter] to enable the power meter mode. Refer to Chapter VI “Power Meter Mode” for details.
Power Meter	{Channel Scanner} : Press 【Mode】 → [Channel Scanner] to enable the channel scanner mode. Refer to Chapter VIII “Channel Scanner Mode” for details.
Channel Scanner	{Field Strength} : Press 【Mode】 → [Field Strength] to enable the field strength measurement mode. Refer to Chapter IX “Field Strength Measurement Mode” for details.
Field Strength	

4.3.10 Sweep menu

The sweep time refers to the time required for the LO tuning of the spectrum analyzer within the selected frequency interval, and directly affects the time of one test. It generally changes with the span, resolution bandwidth and video bandwidth. In the auto mode, the minimum sweep time will be adopted by the spectrum analyzer after measurement setting. The sweep time can be increased in the manual mode to meet specific measurement needs.

The default sweep mode is linear sweeping, while list sweeping is optional. Multiple segment can be swept continuously. The functions of editing, saving and recalling the list are available, thus facilitating the operation.

<div style="border: 1px solid black; padding: 5px; margin-bottom: 5px; text-align: center;">Sweep</div> <div style="border: 1px solid black; border-radius: 10px; padding: 5px; margin-bottom: 5px; text-align: center;">Sweep Time <u>Auto</u> Man</div> <div style="border: 1px solid black; border-radius: 10px; padding: 5px; margin-bottom: 5px; text-align: center;">Sweep <u>Cont</u> Single</div> <div style="border: 1px solid black; border-radius: 10px; padding: 5px; margin-bottom: 5px; text-align: center;">Sweep Once</div> <div style="border: 1px solid black; border-radius: 10px; padding: 5px; margin-bottom: 5px; text-align: center;">Triggering [Free Run] ></div> <div style="border: 1px solid black; border-radius: 10px; padding: 5px; margin-bottom: 5px; text-align: center;">Points [1001] ></div> <div style="border: 1px solid black; border-radius: 10px; padding: 5px; margin-bottom: 5px; text-align: center;">More 1 of 2</div>	<p>{Sweep Time <u>Auto</u> Man}: Press 【Sweep】 →[Sweep Time Auto Man] to adjust the sweep time of the spectrum analyzer. Use the number keys, step keys or knob to adjust the sweep time. If “Man” is underlined, the sweep time can be set manually. If “Auto” is underlined, the sweep time will be automatically associated according to the resolution bandwidth, frequency bandwidth and video bandwidth.</p> <p>{Sweep <u>Cont</u> Single}: Press 【Sweep】 →[Sweep Type] to enable the continuous or single sweeping mode.</p> <p>{Sweep Once}: Press 【Sweep】 → [Sweep Once] to sweep once again.</p> <p>{Triggering}: Press 【Sweep】 → [Triggering] to select the triggering mode, including [Free Run], [Video], [External], etc. Refer to the trigger menu for details.</p> <p>{Points [1001]}: This is optional. Press 【Sweep】 →[Points] to enable the soft menu of points select. You can use soft keys such as [201], [501], [1001], [2001], [4001] to set sweep points.</p>
<div style="border: 1px solid black; padding: 5px; margin-bottom: 5px; text-align: center;">Sweep</div> <div style="border: 1px solid black; border-radius: 10px; padding: 5px; margin-bottom: 5px; text-align: center;">Sweeping Mode <u>Lin</u> List</div> <div style="border: 1px solid black; border-radius: 10px; padding: 5px; margin-bottom: 5px; text-align: center;">Edit list ></div> <div style="border: 1px solid black; border-radius: 10px; padding: 5px; margin-bottom: 5px; text-align: center;">Save list</div> <div style="border: 1px solid black; border-radius: 10px; padding: 5px; margin-bottom: 5px; text-align: center;">Recall list ></div> <div style="border: 1px solid black; border-radius: 10px; padding: 5px; margin-bottom: 5px; text-align: center;">More 2 of 2</div>	<p>{Sweep Mode <u>Lin</u> List}: Press 【Sweep】 →[Sweep Mode] to enable the linear or list mode. In the linear mode, sweeping will be performed based on the linear frequency interval, and the frequency intervals of adjacent measurement points are the same. The list mode is optional, in which sweeping will be performed based on the set frequency range and other parameters in the edited list.</p> <p>{Edit list}: This is optional. Press 【Sweep】 →[Edit List] to enable the soft menu of list editing. You can use soft keys such as [Add Seg], [Delete Seg] and [Delete All] to manage and edit the sweep list. The selected segment will be in green. After editing the segment, press [Done] and [OK] to go back to the sweep menu.</p> <p>{Save List}: This is optional. Press 【Sweep】 →[Save List] to save the current list into the spectrum analyzer for future recalling.</p> <p>{Recall List}: This is optional. Press 【Sweep】 →[Recall List], and the list dialog box will pop up, in which you can recall or delete the required list.</p>

4.3.11 Triggering menu

It is applied to select the triggering mode under “Sweep” or “Measure”, including [Free Run], [Video], [External], [Slope] and [Delay]. The user can select the corresponding triggering mode based on the needs.

Triggering	{Free Trigger} : When the previous single or continuous sweep finishes, the next sweep or measurement is automatically triggered.
Free Run	{Video} : Set the trigger mode as [Video]. Once the input signal exceeds the set video triggering level sweeping will be triggered. The trigger level value can be set by the number keys, stepping keys or knob. The green line on the screen indicates the selected trigger level.
Video	{External(TTL)} : Enable the [External] mode. Synchronize “Sweep” or “Measure” with next voltage cycle.
External(TTL) 1.50V	{Slope} : Control the positive or negative polarity of level triggering. The rising edge will be applied for triggering in the case of positive polarity, and falling edge in the case of negative polarity.
Slope Rising Falling	{delayed} : The level triggering delay can be set. In this case, the spectrum analyzer will wait for the delay time after receiving the external trigger signal and before sweeping.
Delay 1.000us	
< Back	

4.3.12 Trace menu

This is applied to display the trace. You can enable [clear], [max], [min], etc. based on various test needs. For example, if the maximum holding function of the trace is enabled in drift signal measurement, the maximum peak amplitude and frequency drift of the input signal will be display.

Trace	<p>{Trace 1 2 3}: Press [Trace]→[Trace 1 2 3] to select the trace. Three traces are available in the spectrum analyzer: 1, 2 and 3. The selected trace number and status menu will be underlined.</p>
Trace <u>1</u> 2 3	<p>{Clear Write}: Press [Trace]→[Clear Write] to refresh all data of the previous trace and continuously display the signal received by the spectrum analyzer in the sweep mode.</p>
Clear Write	<p>{Max Hold}: Press [Trace]→[Max Hold] to hold the maximum value of the points on the selected trace. In addition, the value will be updated based on the new maximum value detected in each sweeping. In the “Auto” mode of the detector, the positive peak will be enabled.</p>
Max Hold	<p>{Min Hold}: Press [Trace]→[Min Hold] to hold the minimum value of the points on the selected trace. In addition, the value will be updated based on the new minimum value detected in each sweeping. In the “Auto” mode of the detector, the negative peak will be enabled.</p>
Min Hold	<p>{View}: Press [Trace]→[View] to hold and display the amplitude data of the selected trace. Such data are not updated in the sweeping mode of the spectrum analyzer.</p>
View	<p>{Blank}: Press [Trace]→[Blank] to start background processing, without display on the screen.</p>
Blank	

4.3.13 Limit menu

Limit	{Limit <u>Upper</u> Lower} : Press 【Limit】 → [Limit <u>Upper</u> Lower] to set the current limit as the upper or lower limit.
Limit <u>Upper</u> Lower	{Display <u>Off</u> On} : Press 【Limit】 → [Display <u>Off</u> On] to enable or disable the limit function.
Display <u>Off</u> On	{Test <u>Off</u> On} : Press 【Limit】 → [Test <u>Off</u> On] to enable or disable the limit test.
Test <u>Off</u> On	{Edit Limit} : Press 【Limit】 → [Edit Limit], including [Frequency], [Amplitude], [Add Point], [Delete Point], [Left Point], [Right Point] and [Default Limit], to view the frequency and amplitude of the limit point, and add or delete the limit point.
Edit Limit >	{Margin} : Press 【Limit】 → [Margin] to set the offset allowance.
Margin 0.0dB	{Alarm <u>Off</u> On} : Press 【Limit】 → [Alarm <u>Off</u> On] to enable or disable the audio alarm. The enabled audio alarm will be valid when the upper or lower limit test is ON. The buzzer will utter a short sound if the value is beyond the upper and lower limit during sweeping of the current screen.
Alarm <u>Off</u> On	{Save Limit} : Press 【Limit】 → [Save Limit] to save the limit.
Save Limit	{Recall Limit} : Press 【Limit】 → [Recall Limit], including [Head], [Tail], [Page Up], [Page Down], [Done], [Delete] and [Cancel] to recall or delete the saved limit.
Recall Limit >	

4.3.14 Measurement menu

<div style="border: 1px solid black; padding: 5px; margin-bottom: 5px;">Measure</div> <div style="border: 1px solid black; border-radius: 15px; padding: 5px; margin-bottom: 5px;">Field Strength></div> <div style="border: 1px solid black; border-radius: 15px; padding: 5px; margin-bottom: 5px;">Channel Power</div> <div style="border: 1px solid black; border-radius: 15px; padding: 5px; margin-bottom: 5px;">OBW ></div> <div style="border: 1px solid black; border-radius: 15px; padding: 5px; margin-bottom: 5px;">ACPR ></div> <div style="border: 1px solid black; border-radius: 15px; padding: 5px; margin-bottom: 5px;">Emission Mask></div> <div style="border: 1px solid black; border-radius: 15px; padding: 5px; margin-bottom: 5px;">C/N ></div> <div style="border: 1px solid black; border-radius: 15px; padding: 5px; margin-bottom: 5px;">All Meas Off</div> <div style="border: 1px solid black; border-radius: 15px; padding: 5px; margin-bottom: 5px;">More 1 of 2 ></div>	<p>{Field Strength}: Press 【Measure】 →[Field Strength] to enable the field strength measurement function and recall the related functional menu. Refer to the [Field Strength] menu description for details.</p> <p>{Channel Power}: Press 【Measure】 →[Channel Power] to enable the channel power function and recall the related functional menu. Refer to [Channel Power] menu description for details.</p> <p>{OBW}: Press 【Measure】 →[OBW] to enable the occupied bandwidth function and recall the related functional menu. Refer to [OBW] menu description for details.</p> <p>{ACPR}: Press 【Measure】 →[ACPR] to select the adjacent channel power function and recall the related functional menu. Refer to [ACPR] menu description for details.</p> <p>{Emission mask}: Press 【Measure】 →[Emission Mask] to enable the emission mask function and recall the related functional menu. Refer to [Emission Mask] menu description for details.</p> <p>{C/N}: Press 【Measure】 →[C/N] to enable the C/N measurement function and recall the related functional menu. Refer to [C/N] menu description for details.</p> <p>{All Meas Off}: Press 【Measure】 → [All Meas Off] to disable measurement functions.</p>
<div style="border: 1px solid black; padding: 5px; margin-bottom: 5px;">Measure</div> <div style="border: 1px solid black; border-radius: 15px; padding: 5px; margin-bottom: 5px;">Tune Listen ></div> <div style="border: 1px solid black; border-radius: 15px; padding: 5px; margin-bottom: 5px;">IQ Capture ></div> <div style="border: 1px solid black; border-radius: 15px; padding: 5px; margin-bottom: 5px;">All Meas Off</div> <div style="border: 1px solid black; border-radius: 15px; padding: 5px; margin-bottom: 5px;">More 2/2 ></div>	<p>{Tune Listen}: Press 【Measure】 → [More 1/2]→ [Tune Listen] to enable the tune listening function. Refer to [Tune Listen] menu description for details.</p> <p>{IQ Capture}: Press 【Measure】→ [More 1/2]→ [IQ Capture] to enable the IQ capture function. Refer to [IQ Capture] menu description for details.</p>

The spectrum analyzer has the function of field strength measurement, including soft menus such as [Field Strength Off On], [Recall Antenna], [Edit Antenna] and [Save Antenna]. The field strength can be rapidly tested with such menus and corresponding test antennas.

Field Strength	{Field Strength Off On} : Press 【Measure】 → [Field Strength]→ [Field Strength <u>Off</u> On] to enable or disable the field strength measurement function.
Field Strength <u>Off</u> On	{Recall Antenna} : Press 【Measure】 → [Field Strength]→ [Recall Antenna], and soft menus such as [Head], [Tail], [Page Up], [Page Down], [Done] and [Delete] will pop up, you can select and recall the saved antenna factor file in the spectrum analyzer.
Recall Antenna	{Edit Antenna} : Press 【Measure】 → [Field Strength]→ [Edit Antenna], and soft menus such as [Add Point], [Delete Point], [Delete All], [Done] and [Cancel] will pop up. You can edit the antenna factor.
Edit Antenna	{Save Antenna} : Press 【Measure】 → [Field Strength]→ [Save Antenna] to save the antenna factor.
Save Antenna	{Back} : Press 【Measure】 → [Field Strength]→ [Back] to exit the field strength menu and go back to the “Measure” menu.
< Back	

The spectrum analyzer has the function of channel power measurement. You can measure the channel power of the signal by setting relevant parameters in the functional menu and selecting the appropriate resolution bandwidth and span. Refer to the channel power measurement requirements in the first section of this chapter for specific operations.

Channel Pwr	{Channel Pwr Off On} : Press 【Measure】 → [Channel Power]→ [Channel Pwr <u>Off</u> On] to enable or disable the channel power measurement function.
Channel Pwr <u>Off</u> On	{Center Freq} : Press 【Measure】 → [Channel Power]→ [Center Freq] and set the center frequency with number keys.
Center Freq	{Channel BW} : Press 【Measure】 → [Channel Power]→ [Channel BW] and set the channel bandwidth with number keys.
Channel BW	{Span} : Press 【Measure】 → [Channel Power]→ [Span] and set the channel span with number keys.
Span	[Special attention] : The channel power bandwidth refers to the frequency width of the power displayed by the spectrum analyzer within the bandwidth, while the channel power span refers to the sweeping frequency range of the spectrum analyzer. The channel power span should be more than or equal to the channel power bandwidth. Otherwise, the channel power bandwidth will be automatically set to be equal to the channel power span. The ratio of the channel power span to channel power bandwidth is a constant. It remains unchanged when the channel power span is changed. You can change this ratio by changing the channel power bandwidth. For example, when the channel power span is doubled, the channel power bandwidth will be increased by the same times.
< Back	

Results can be rapidly, clearly and accurately in occupied bandwidth measurement of the spectrum analyzer. Depending on the modulation mode, two methods can be applied to calculate the occupied bandwidth: power percentage and power drop dBc. The user can select the appropriate occupied bandwidth measurement method according to the needs. Refer to the occupied bandwidth measurement requirements in the first section of this chapter for specific operations.

OBW	{OBW <u>Off</u> On} : Press 【Measure】 → [OBW] → [OBW <u>Off</u> On] to enable or disable the occupied bandwidth measurement function.
OBW <u>Off</u> On	{Method % dBc} : Press 【Measure】 → [OBW] → [Method % dBc] to select the appropriate test method, including percentage and drop dBc. In the percentage method, the occupied bandwidth of the signal is obtained by calculating the bandwidth of the frequency of certain percentage to the total power of the transmitted power, and the power percentage can be set by the user. In the drop dBc method, the occupied bandwidth is defined as follows: spacing between two frequency points corresponding to signal power drop by dBc on both sides of the frequency point where the signal peak power is. The signal power drop dBc can be set by the user.
Method % dBc	
% 99.00%	
dBc -3.00dB	
Span	{%} : Press 【Measure】 → [OBW] → [%] to set the power percentage in the percentage method.
	{dBc} : Press 【Measure】 → [OBW] → [dBc] to set the signal power drop dBc in the power drop dBc method.
< Back	{Span} : Press 【Measure】 → [OBW] → [Channel Sweep] to set the sweeping frequency bandwidth of occupied bandwidth measurement.

The spectrum analyzer has the function of adjacent channel power ratio measurement. The user can obtain measurement results by setting relevant parameters of the channel. By using the limit test function, the user can define the adjacent channel limits so as to easily observe whether the adjacent channel power exceeds the set range. Refer to the requirements of adjacent channel power ratio measurement in the first section of this chapter for specific operations.

ACPR	{ ACPR Off On }: Press 【Measure】 → [ACPR] → [ACPR Off On] to enable or disable the ACPR measurement function.
ACPR Off On	{ Center Freq }: Press 【Measure】 → [ACPR] → [Center Freq] and set the center frequency with number keys.
Center Freq	{ Main Ch BW }: Press 【Measure】 → [ACPR] → [Main Ch BW] and set the main channel bandwidth with number keys.
Main Ch BW 3.000MHz	{ Adj Ch BW }: Press 【Measure】 → [ACPR] → [Adj Ch BW] and set the adjacent channel bandwidth with number keys.
Adj Ch BW 3.000MHz	{ Ch Spacing }: Press 【Measure】 → [ACPR] → [Ch Spacing] and set the channel spacing with number keys.
Ch Spacing 3.000MHz	
More 1 of 2 >	
< Back	

ACPR	{ Limit Test Off On }: Press 【Measure】 → [ACPR] → [Limit Test Off On] to enable or disable the upper and lower limit test of the adjacent channel power.
Limit Test Off On	{ Upper Limit }: Press 【Measure】 → [ACPR] → [Upper Limit] to set the upper limit of the power of the adjacent channel test.
Upper Limit 0.0dB	{ Lower Limit }: Press 【Measure】 → [ACPR] → [Lower Limit] to set the lower limit of the power of the adjacent channel test.
Lower Limit 0.0dB	{ Special note }: If ACPR exceeds the set limit in the limit test, the screen background will turn red as the mark.
More 2 of 2	
< Back	

The spectrum analyzer has the C/N measurement function, which is applied to measure the ratio of the carrier power to noise power.

C/N	{C/N <u>Off</u> On} : Press 【Measure】 → [C/N]→ [C/N <u>Off</u> On] to enable or disable the C/N function.
C/N <u>Off</u> On	{Center Freq} : Press 【Measure】 → [C/N]→ [Center Freq] and set the center frequency of measurement with number keys.
Center Freq	{Carrier BW} : Press 【Measure】 → [C/N]→ [Carrier BW] and set the carrier bandwidth with number keys. The default setting is 3MHz.
Carrier BW 3.000MHz	{Noise BW} : Press 【Measure】 → [C/N]→ [Noise BW] and set the noise bandwidth with number keys. The default setting is 3MHz.
Noise BW 3.000MHz	{Offset} : Press 【Measure】 → [C/N]→ [Offset] and set the frequency offset with number keys. The default setting is 3MHz.
Offset 3.000MHz	
	
< Back	

The emission mask function is applied to measure whether the signal power exceeds the mask limits, where the limits are recalled as the masks. The mask can be moved right and left or up and down according to the center frequency and reference power. In the mask, the limit center is always moved right and left to the center frequency, and also moved up and down to the reference power point based on the calculated reference power.

Emission Mask	<p>{Emission Mask Off On}: Press 【Measure】 → [Emission Mask]→ [Emission Mask <u>Off</u> On] to enable or disable the emission mask function.</p>
Emission Mask <u>Off</u> On	<p>{Channel BW}: Press 【Measure】→ [Emission Mask]→ [Channel BW] and set the reference channel bandwidth with number keys.</p>
Channel BW 1.000MHz	<p>{Recall Limit}: Press 【Measure】→ [Emission Mask]→ [Recall Limit], and relevant soft menus will pop up, including [Head], [Tail], [Page Up], [Page Down], [Done] and [Delete]. The user can select the limit file to be recalled.</p>
Recall Limit as Mask >	<p>{Ref power}: Press 【Measure】 → [Emission Mask]→ [Ref Power] to set the reference power setting mode. The peak power or channel power may be used as the reference power.</p>
Ref power <u>Peak</u> Ch	<p>{Peak Markers Off On}: Press 【Measure】 → [Emission Mask]→ [Peak Markers <u>Off</u> On] to enable or disable the peak marker.</p>
Peak Markers <u>Off</u> On	<p>{Page Up}: Press 【Measure】 → [Emission Mask]→ [Page Up] to view the information on the previous page.</p>
Page Up	<p>{Page Down}: Press 【Measure】 → [Emission Mask]→ [Page Down] to view the information on the following page.</p>
Page Down	
< Back	

By using the IQ capture function, the original IQ data can be captured according to the capture time, sample rate and capture mode set by the user, and data files can be saved for data analysis.

IQ Capture	{IQ Capture <u>Off</u> On} : Press 【Measure】 → [More 1/2] → [IQ Capture] → [IQ Capture <u>Off</u> On] to enable or disable the IQ capture function.
IQ Capture <u>Off</u> On	{Start Capture} : Press 【Measure】 → [More 1/2] → [IQ Capture] → [Start Capture] to start IQ capture.
Start Capture	{Capture time} : Press 【Measure】 → [More 1/2] → [IQ Capture] → [Capture Time] to set the IQ capture time.
Capture time 1.000ms	{Capture Mode} : Press 【Measure】 → [More 1/2] → [IQ Capture] → [Capture Mode] to enable the single or continuous IQ capture. In the single mode, the data will be captured once only. In the continuous mode, the data will be captured once after each sweeping of the stroke, and capturing will not be stopped until otherwise set by the user.
Capture Mode <u>Single</u> Cont	{Sample Rate} : Press 【Measure】 → [More 1/2] → [IQ Capture] → [Sample Rate] to set the sample rate of IQ capture.
Sample Rate 5.000MHz	{Triggering} : Press 【Measure】 → [More 1/2] → [IQ Capture] → [Triggering] to set the triggering mode, including [Free Run] and [External]. In the [External] mode, [Slope] and [Delay] can be set.
Triggering [Free Run] >	{Save Name IQCapture} : Press 【Measure】 → [More 1/2] → [IQ Capture] → [Save Name] to save the captured data.
Save Name IQCapture	
< Back	

Tune & Listen	{Tune Listen <u>Off</u> On} : Press 【Measure】 → [More 1/2] → [Tune Listen] → [Tune Listen <u>Off</u> On] to enable or disable the tune listening function.
Tune & Listen <u>Off</u> On	{Demod type} : Press 【Measure】 → [More 1/2] → [Tune Listen] → [Demod Type] to set the demodulation type. The following demodulation types are available: [FM], [AM], [USB] or [LSB].
Demod type FM >	{Demod Time} : Press 【Measure】 → [More 1/2] → [Tune Listen] → [Demod Time] to set the listening time.
Listen Time 100.00ms	{Listen Mode} : Press 【Measure】 → [More 1/2] → [Tune Listen] → [Listen Mode] to set the listening mode. The default setting is the intermittent listening mode, in which the data will be listened for the set listening time after sweeping of one screen, and the above cycle is repeated. In the continuous mode, data will not be swept but will be continuously listened after sweeping of one screen.
Listen Mode <u>Int</u> Cont	{Volume} : Press 【Measure】 → [Tune Listen] → [Volume] to set the loudspeaker volume in the tune listening mode.
Volume 95	
	
< Back	

4.3.15. Signal source menu (option)

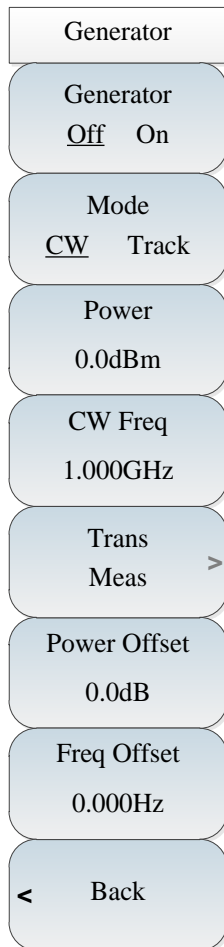

{**Signal Source Off On**}: press **【 Measure 】** → [More 1 of 2] → [Generator] → [Generator **Off On**], to activate or deactivate the signal source.

{**Tracking Mode Off On**}: press **【 Measure 】** → [More 1 of 2] → [Signal Source] → [Mode **CW Track**], to activate or deactivate the signal source tracking mode.

{**Special Notice**}: the tracking mode switch is effective when the signal source switch is started. In case of Off, the independent source mode and the point frequency source output will be activated independent of spectral analysis. At this time, the set point frequency and output power menus will be effective but the transmission measurement, power offset and frequency offset menus are ineffective; in case of Track, the tracking mode will be activated, the synchronous scanning will be done at signal source frequency and spectral analysis mode frequency, the set point frequency menu will be ineffective, and the output power, power offset, frequency offset and transmission measurement will be effective.

{**power 0.0 dBm**}: press **【 Measure 】** → [More 1 of 2] → [Generator] → [Power 0.0dBm], to change the output power by using number key or key **【 ↑ 】** or **【 ↓ 】**.

{**Special Notice**}: the output power range is -40dBm~0dBm with step size of 1dB.

{**CW Freq 1.000GHz**}: press **【 Measure 】** → [More 1 of 2] → [Generator] → [CW Freq 1.000GHz], to change the CW frequency by using number key or key **【 ↑ 】** or **【 ↓ 】**.

{**Trans Meas**}: press **【 Measure 】** → [More 1 of 2] → [Generator] → [Trans Meas], to activate the sub-menu of transmission measurement. For details, please refer to the instructions of transmission measurement menu.

{**Power Offset 0.0dB**}: press **【 Measure 】** → [More 1 of 2] → [Generator] → [Power Offset 0.0dB]. When there is gain or loss between generator output and peripheral equipment, it is allowed to use this parameter to set the signal source power offset so as to indicate the actual power of system. This parameter cannot change the actual output power of generator but its power reading.

{**Special Notice**}: The parameter range is -200dB~200dB with default value of 0dB and step size of 1dB, which is effective when the tracking mode is activated.

{**Freq Offset 0.000Hz**}: press **【 Measure 】** → [More 1 of 2] → [Generator] → [Freq Offset 0.000Hz], to set the offset value of generator output signal frequency and current spectrometer scan frequency.

{**Special Notice**}: The parameter range is -300MHz~300MHz with default value of 0Hz, which is effective when the tracking mode is activated. The frequency offset must be set to ensure that the generator can reach the maximum frequency at 100kHz.

Trans Meas	{Normalize <u>Off</u> On} : press 【Measure】 → [More 1 of 2] → [Generator] → [Trans Meas] → [Normalize <u>Off</u> On], to activate or deactivate the normalized measurement.
Normalize <u>Off</u> On	{Ref Level 0.0dB} : press 【Measure】 → [More 1 of 2] → [Generator] → [Trans Meas] → [Ref Level 0.0dB], to activate the normalized and adjust the ref level so as to adjust the vertical position of trace on screen.
Ref Level 0.0dB	{Special Notice} : The parameter range is -200dB~200dB with default value of 0dB and step size of 1dB, which is effective when the tracking mode and normalized are activated.
Ref Position 0	{Ref Position 0} : press 【Measure】 → [More 1 of 2] → [Generator] → [Trans Meas] → [Ref Position 0], to activate the normalized and adjust the ref position so as to adjust the vertical position of normalized ref level on screen.
Scale/Div 10.0dB	{Special Notice} : The parameter range is 0~10 with default value of 5 and step size of 1, which is effective when the tracking mode is activated.
Store Mem Trace	{Scale/Div 10.0dB} : press 【Measure】 → [More 1 of 2] → [Generator] → [Trans Meas] → [Scale/Div 10.0dB], to activate the normalized and adjust the scale/div so as to adjust the Y-axis precision of trace on screen.
Mem Trace <u>Off</u> On	{Special Notice} : The parameter range is 0~10 with default value of 5 and step size of 1, which is effective when the tracking mode is activated.
< Back	{Store Mem Trace} : press 【Measure】 → [More 1 of 2] → [Generator] → [Trans Meas] → [Store Mem Trace]. It is allowed to save the data of current mem trace.
	{Mem Trace <u>Off</u> On} : press 【Measure】 → [More 1 of 2] → [Generator] → [Trans Meas] → [Mem Trace <u>Off</u> On]. Set whether the mem trace is displayed or not.

4.3.16 File menu

File	{Save State} : Press [File]→[Save State] to save the current sweeping parameters.
Save State	
Recall state >	{Recall state} : Press [File]→ [Recall State], and the state file list will pop up, including relevant soft menus such as [Head], [Tail], [Page Up], [Page Down], [Done] and [Delete]. You can read the saved state file and recall the corresponding state parameters into current sweeping.
Save Data	{Save Data} : Press [File]→ [Save Data] to save the trace data.
Recall Data >	{Recall Data} : Press [File]→ [Recall Data], and the data file list will pop, including relevant soft menus such as [Head], [Tail], [Page Up], [Page Down], [Done] and [Delete]. You can read the saved data file and recall the corresponding state parameters into current sweeping.
Save Pic	{Save Pic} : Press [File]→ [Save Pic] to capture the current screen picture.
Default State	{Default State} : Press [File]→[Default State] to recover the default setting.
File Manager >	{File Manager} : Press [File]→ [File Manager] and the file manager menu will pop up, including relevant soft menus such as [Src File], [Dst File], [Copy] and [Delete File]. You can copy and delete the file.
Location [Internal] >	• {Location} : Press [File]→[Location] to select the saving location. “Internal” means the internal memory, while “Others” means the memory with the USB interface and SD card. If the security characteristics are selected, the internal memory will not be available.

4.3.17 System menu

The system menu lists the system-related settings of 4024 series spectrum analyzer. In addition to the date/time, date format, system language, network setting and frequency reference, characteristic menus such as the LO nulling alignment, GPS positioning (optional) and power saver are available.

4024 series spectrum analyzer has the function of LO nulling alignment, which is conducive for LO null calibration when required. To accurately measure the amplitude of the signal with the frequency below 5MHz, attention should be paid to the zero-frequency signal. If the zero-frequency signal is above >-20dBm, LO null calibration should be performed so as to prevent gain compression caused by too large amplitude of the zero-frequency signal.

The optional GPS positioning function of 4024 series can be achieved with the external GPS antenna. The user can view the number of current satellites in service and the longitude, latitude and altitude information. This function is applicable to accurate positioning in fields.

In the power saver mode, the spectrum analyzer will enter the sleep state in the case of no operation within the sleep time, including shutdown of the LCD, internal module power, etc. If any key is pressed again, the spectrum analyzer will exit the sleep state and change into the normal operating mode.

<div style="border: 1px solid black; padding: 5px; margin-bottom: 5px; text-align: center;">System</div> <div style="border: 1px solid black; border-radius: 15px; padding: 5px; margin-bottom: 5px; text-align: center;">Align LO Nulling</div> <div style="border: 1px solid black; border-radius: 15px; padding: 5px; margin-bottom: 5px; text-align: center;">Date Time ></div> <div style="border: 1px solid black; border-radius: 15px; padding: 5px; margin-bottom: 5px; text-align: center;">Display ></div> <div style="border: 1px solid black; border-radius: 15px; padding: 5px; margin-bottom: 5px; text-align: center;">GPS ></div> <div style="border: 1px solid black; border-radius: 15px; padding: 5px; margin-bottom: 5px; text-align: center;">LAN ></div> <div style="border: 1px solid black; border-radius: 15px; padding: 5px; margin-bottom: 5px; text-align: center;">Freq Ref Int Ext</div> <div style="border: 1px solid black; border-radius: 15px; padding: 5px; margin-bottom: 5px; text-align: center;">RF Out Off On</div> <div style="border: 1px solid black; border-radius: 15px; padding: 5px; margin-bottom: 5px; text-align: center;">More 1 of 2 ></div>	<p>{AliLO Nulling}: Press [System]→[AliLO Nulling] to enable the LO nulling alignment function. The user can easily apply this function when required. Alignment results will be saved in the internal memory of the instrument.</p> <p>{Date}: Press [System]→ [Date/Time] to set the date and time.</p> <p>{Display}: Press [System]→ [Display] to set the display mode, including relevant settings of [Default], [Black & White], [Night Vision] and [Brightness].</p> <p>{GPS}: Press [System]→ [GPS] and soft menus related to GPS will pop up, including [GPS <u>Off</u> On], [GPS Info] and {Preset} . You can enable or disable the GPS function, view GPS details and reset GPS.</p> <p>[Special note]: The GPS positioning function is optional.</p> <p>{LAN}: Press [System]→ [LAN] to set the network setting of the spectrum analyzer, including [Prev], [Next], [IP], [Mask] and [Gateway].</p> <p>{Freq Ref <u>Int</u> Ext}: Press [System]→[Freq Ref <u>Int</u> Ext] to select the internal or external frequency reference according to the needs.</p> <p>{Ref Output <u>Off</u> On}: Press [System]→[Ref Output <u>Off</u> On] to enable or disable the interval reference according to the needs in the internal reference mode.</p> <p>[Special note]: The external reference frequency must be 10MHz±100Hz, and the amplitude must be 0dBm (range: -2dBm to +10dBm). The external reference frequency must be applied through the “10MHz reference input” of the cover.</p>
<div style="border: 1px solid black; padding: 5px; margin-bottom: 5px; text-align: center;">System</div> <div style="border: 1px solid black; border-radius: 15px; padding: 5px; margin-bottom: 5px; text-align: center;">Language ></div> <div style="border: 1px solid black; border-radius: 15px; padding: 5px; margin-bottom: 5px; text-align: center;">Power Saver ></div> <div style="border: 1px solid black; border-radius: 15px; padding: 5px; margin-bottom: 5px; text-align: center;">System information</div> <div style="border: 1px solid black; border-radius: 15px; padding: 5px; margin-bottom: 5px; text-align: center;">Error Log ></div> <div style="border: 1px solid black; border-radius: 15px; padding: 5px; margin-bottom: 5px; text-align: center;">Date Format ></div> <div style="border: 1px solid black; border-radius: 15px; padding: 5px; margin-bottom: 5px; text-align: center;">Title Off On</div> <div style="border: 1px solid black; border-radius: 15px; padding: 5px; margin-bottom: 5px; text-align: center;">Admin</div> <div style="border: 1px solid black; border-radius: 15px; padding: 5px; margin-bottom: 5px; text-align: center;">More 2 of 2 ></div>	<p>{language}: Press [System]→ [Language] to set the language, including [simplified Chinese] and [English].</p> <p>{Power Saver}: Press [System]→ [Power Saver] to set the auto sleep and auto shutdown mode, including [Sleep <u>Off</u> On], [Sleep], [Shut Down <u>Off</u> On] and [Shut Down], so as to minimize power loss.</p> <p>{System Info}: Press [System]→[System Info] to view the system information, including the application software version, custom image version, etc.</p> <p>{Date Format}: Press [System]→ [Date Format] to set the date format.</p> <p>• {Error Log}: Press [System]→ [Error Log] and relevant soft menus will pop up, including [Head], [Tail], [Page Up], [Page Down] and [Delete All]. You can view relevant error information.</p> <p>{Tip <u>Off</u> On}: Press [System]→ [Tip <u>Off</u> On] to select the current title of the name.</p> <p>{Admin}: Press [System]→[Admin] and enter the administrator password to perform system administration and setting.</p> <p>[Special note]: The administration function is only available to the factory commissioning personnel or technical support personnel when required, and must not be applied by the user; otherwise, the instrument may be damaged.</p>

Chapter V Interference Analyzer Measurement Mode (optional)

Section 1 Introduction to Typical Measurements

The interference analyzer mode is an extension of the spectrum analyzer mode. In 4024 series spectrum analyzer, the interference analyzer mode is divided into the following three modes:

Spectrum measurement (refer to the relevant chapter of spectrum analysis requirements for specific operations, not repeated here);

Spectrogram measurement;

Received signal strength indicator (RSSI) measurement.

Caution

All operations in this chapter are based on the interference analyzer mode, which will not be described separately below.

5.1.1 Spectrogram measurement

The cyclic or intermittent signal can be easily observed in the 3D spectrogram display, i.e. frequency, amplitude and time. The time signal amplitudes are reflected by various colors in the spectrogram display.

In order to better observe the measured signal, the following steps can be taken:

- Press **【Freq】** → [Span] → [Full Span] and **【Peak】** to obtain the maximum value of the current signal. Then press [Marker → Center] and set the current peak as the center frequency. In this case, the maximum value will be displayed at the center of the trace zone.
- Press **【BW】** → [RBW Auto Man] and set the appropriate resolution bandwidth with the number keys, **【↑】**, **【↓】** or knob. Similarly, set the appropriate video bandwidth.
- Press **【Ampt】** → [Ref Level] and set the current maximum point close to the top of the display zone. Press [Scale/Div] and set the appropriate scale/division to facilitate viewing
- Press [Record] → [Sweep Interval Auto] and set the sweep interval.

Caution

If the sweep interval is more than 0, the trace will be in the maximum holding state, so as to ensure that the maximum value of the signal in each sweeping will be displayed on the screen.

- Press **【Sweep Time】** and set the record time. Then press [Auto Save Off On] to enable the auto saving mode. In this case, the data will be saved automatically after sweeping of one screen.
- Press **【Record】** → [Time Cursor] and move the horizontal line with the number keys, **【↑】**, **【↓】** or knob in the vertical direction of the spectrogram. The following spectrogram will display the trace information on the line.

Caution

If the time marker value is more than 0, the trace and spectrogram will not be refreshed.

- The interference analyzer mode of 4024 series spectrum analyzer involves six independent markers,

which are used for reading the amplitude and frequency corresponding of the marker. Specific operations are as follows: [Maker]→[Marker 1 2 3 4 5 6].

h) Press [File]→[Save Pic] to save the current spectrogram information in the picture form.

The spectrogram test structure is in Fig. 5-1 (the displayed contents vary from parameter settings, and Fig. 5-1 only show an example).

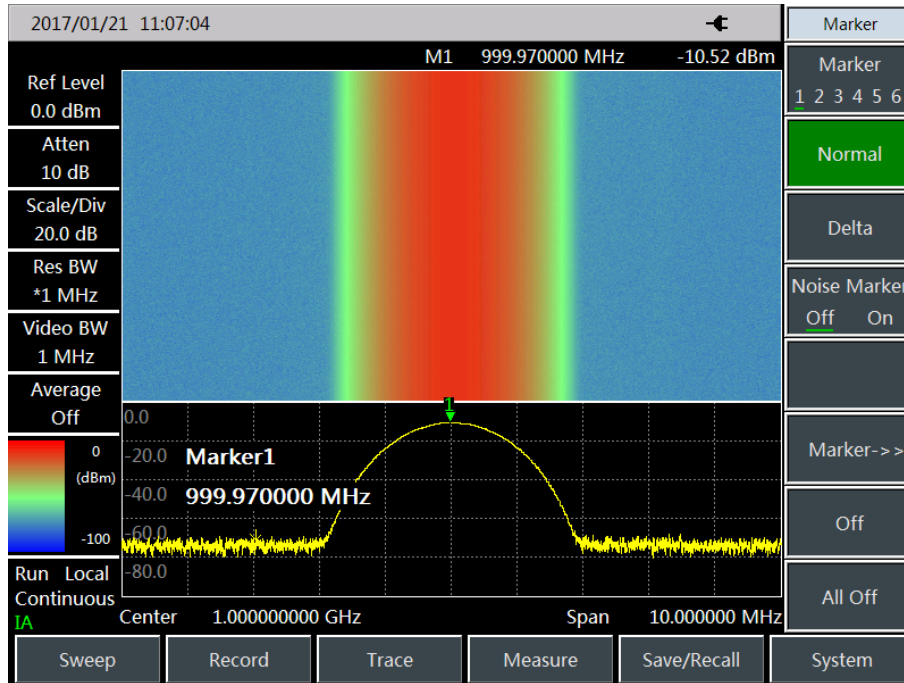

Fig. 5-1 Interference Analyzer Spectrogram

5.1.2 RSSI measurement

RSSI measurement is mainly applied to measure the strength changes of one CW signal within a certain period.

In order to better observe the measured signal, the following steps can be taken:

- Press [Record]→[Sweep Interval] to set the sweep interval, which represents the sweep time between two adjacent points in each sweeping.
- Press [Record]→[Sweep Time] to set the span record time. After reaching the set span time, the display interface will not be refreshed.
- Press [Record]→[Auto Save Off On] to enable the auto saving function. The data will be automatically saved into the file after sweeping of each screen.

Caution

If the span time is set, only the latest data points on the screen will be recorded, instead of all data points within the whole span.

The RSSI test structure is shown in Fig. 5-2 (the displayed contents vary from parameter settings and Fig. 5-2 only show an example).

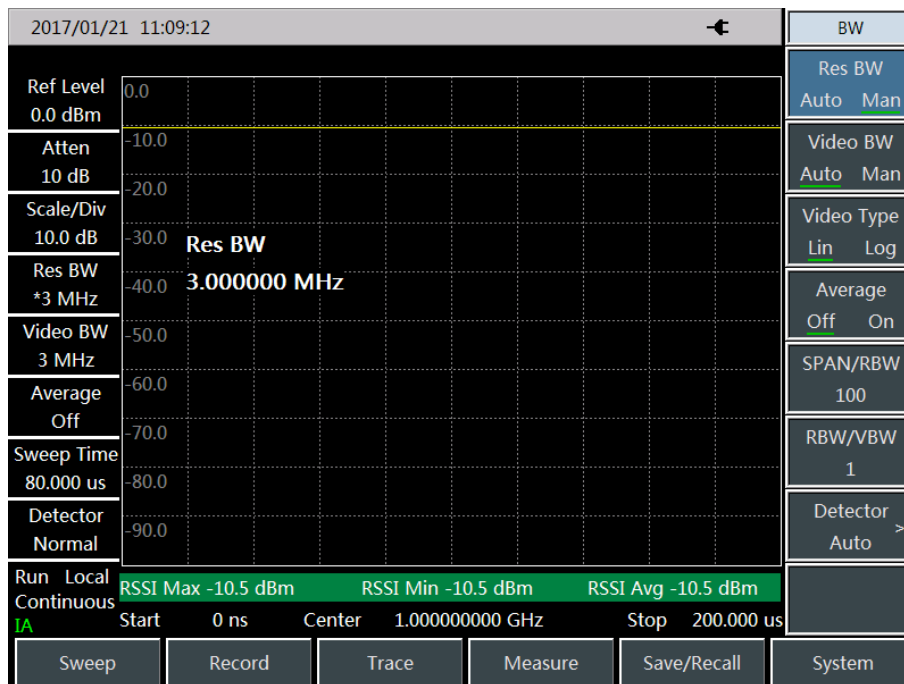

Fig. 5-2 RSSI Test Diagram of Interference Analyzer

Section 2 Structure of Interference Analyzer Menu

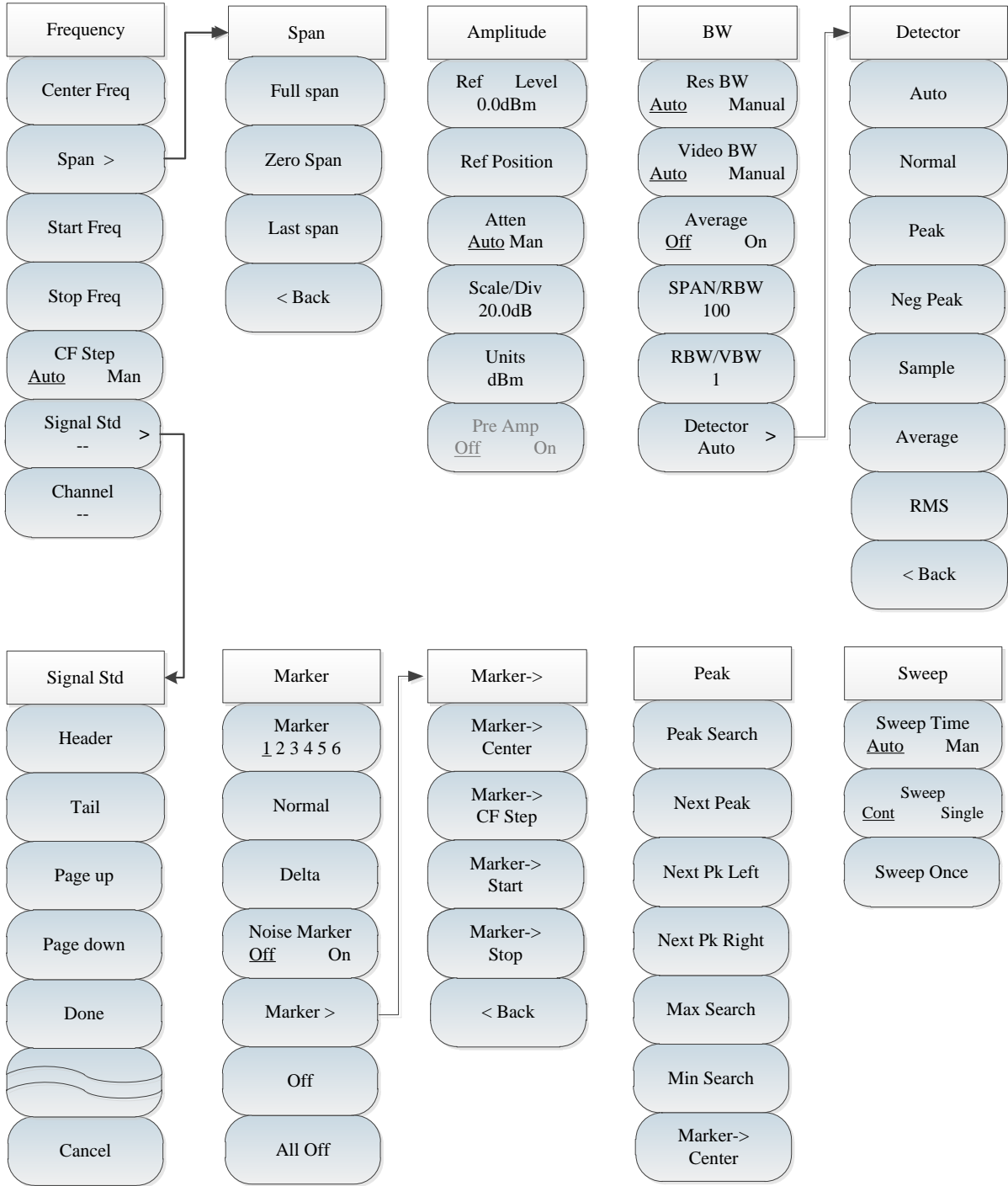

Fig. 5-3 Overall Block Diagram of Interference Analyzer Menu

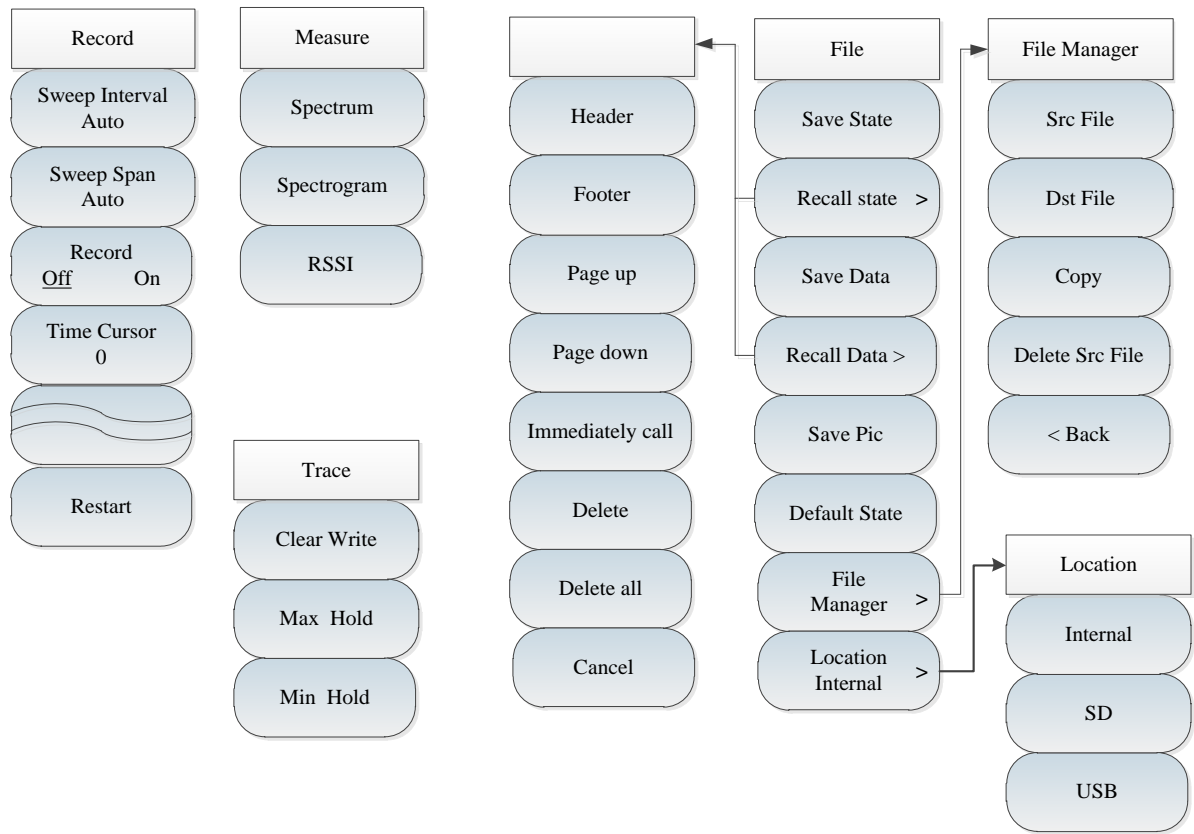

Fig. 5-4 Overall Block Diagram of Interference Analyzer Menu (continued)

Section 3 Description of Interference Analyzer Menu

5.3.1 Frequency menu

<div style="border: 1px solid black; padding: 5px; margin-bottom: 5px;">Frequency</div> <div style="border: 1px solid black; border-radius: 15px; padding: 5px; margin-bottom: 5px;">Center Freq</div> <div style="border: 1px solid black; border-radius: 15px; padding: 5px; margin-bottom: 5px;">Span ></div> <div style="border: 1px solid black; border-radius: 15px; padding: 5px; margin-bottom: 5px;">Start Freq</div> <div style="border: 1px solid black; border-radius: 15px; padding: 5px; margin-bottom: 5px;">Stop Freq</div> <div style="border: 1px solid black; border-radius: 15px; padding: 5px; margin-bottom: 5px;">CF Step Auto Man</div> <div style="border: 1px solid black; border-radius: 15px; padding: 5px; margin-bottom: 5px;">Signal Std -- ></div> <div style="border: 1px solid black; border-radius: 15px; padding: 5px;">Channel --</div>	<p>{Center Freq}: Press 【Freq】 →[Center Freq], and set it with number keys on the front panel. Select [GHz], [MHz], [kHz] or [Hz] in the frequency unit menu or set the center frequency with the 【↑】 or 【↓】 key or knob.</p> <p>[Special note]: When the 【↑】 or 【↓】 key or knob is applied, the frequency step should be the same as the set value of [Step Freq]. You can set the step frequency with the number keys or 【↑】 or 【↓】 key or knob after changing [CF Step <u>Auto Man</u>] into [CF Step <u>Auto Man</u>].</p> <p>{Span}: Press →[Span] to activate the span menu. Set the span with the number keys, and select the frequency unit, or set the span with the 【↑】 or 【↓】 key or knob. Refer to [Span] menu description for details.</p> <p>[Special note]: When the span is changed with the 【↑】 or 【↓】 key or knob, the step should be 1-2-5 (the RSSI mode must be set under zero span).</p> <p>{Start Freq}: Press 【Freq】 →[Start Freq], and set it with number keys on the front panel. Select the frequency unit, or set the value with the 【↑】 or 【↓】 key or knob.</p> <p>{Stop Freq}: Press 【Freq】→[Stop Freq], and set it with number keys on the front panel. Select the frequency unit, or set the value with the 【↑】 or 【↓】 key or knob.</p> <p>{Signal Std}: Press 【Freq】→[Signal Std] and select the signal standard with the 【↑】 or 【↓】 key or knob, recall the signal standard by [Done] or [OK] in the dialog box. Refer to the dialog box for details.</p> <p>[Special note]: When the signal standard is applied, the center frequency and span will be set as those defined in the signal standard.</p> <p>{Channel }: Press 【Freq】 →[Channel], and the channel setting dialog box will pop up. Set the channel with the number keys or 【↑】 or 【↓】 key or knob.</p> <p>[Special note]: The channel should be set based on the applied signal standard; otherwise, the prompt that setting is not allowed will pop up.</p>
---	---

5.3.2 Span menu

<div style="border: 1px solid black; padding: 5px; margin-bottom: 5px; text-align: center;">Span</div> <div style="border: 1px solid black; border-radius: 15px; padding: 5px; margin-bottom: 5px; text-align: center;">Full span</div> <div style="border: 1px solid black; border-radius: 15px; padding: 5px; margin-bottom: 5px; text-align: center;">Zero Span</div> <div style="border: 1px solid black; border-radius: 15px; padding: 5px; margin-bottom: 5px; text-align: center;">Last span</div> <div style="border: 1px solid black; border-radius: 15px; padding: 5px; margin-bottom: 5px; text-align: center;">< Back</div>	<p>{Span}: Press 【Freq】 → [Span] to activate the span menu. Set the span with the number keys, and select the frequency unit, or set the span with the 【↑】 or 【↓】 key or knob. Refer to [Span] menu description for details.</p> <p>[Special note]: When the span is changed with the 【↑】 or 【↓】 key or knob, the step should be 1-2-5.</p> <p>{Full span}: Press 【Freq】 → [Span] → [Full Span] and set the current span as 44.1GHz.</p> <p>{Span}: Press 【Freq】 → [Span] → [Zero Span] and set the current span as 0Hz.</p> <p>{Last span}: Press 【Freq】 → [Span] → [Zero Span] and recover the last span.</p> <p>{Back}: Press 【Freq】 → [Span] → [Back] to go back to the 【Freq】 menu.</p> <p>[Special note]: The RSSI mode must be enabled under zero span.</p>
--	---

5.3.3 Amplitude menu

<div style="border: 1px solid black; padding: 5px; margin-bottom: 5px; text-align: center;">Amplitude</div> <div style="border: 1px solid black; border-radius: 15px; padding: 5px; margin-bottom: 5px; text-align: center;">Ref Level 0.0dBm</div> <div style="border: 1px solid black; border-radius: 15px; padding: 5px; margin-bottom: 5px; text-align: center;">Ref Position</div> <div style="border: 1px solid black; border-radius: 15px; padding: 5px; margin-bottom: 5px; text-align: center;">Atten Auto Man</div> <div style="border: 1px solid black; border-radius: 15px; padding: 5px; margin-bottom: 5px; text-align: center;">Scale/Div 20.0dB</div> <div style="border: 1px solid black; border-radius: 15px; padding: 5px; margin-bottom: 5px; text-align: center;">Units dBm</div> <div style="border: 1px solid black; border-radius: 15px; padding: 5px; margin-bottom: 5px; text-align: center;">Pre Amp Off On</div>	<p>{Ref level}: Press 【Ampt】 → [Ref Level] and set it with the number keys on the front panel. Select [dBm], [-dBm], [mV] or [uV] in the frequency unit menu, or set the value with the 【↑】 or 【↓】 key or knob.</p> <p>[Special note]: When the 【↑】 or 【↓】 key or knob is applied, the step should be 10dB.</p> <p>{Ref position}: Press 【Ampt】 → [Ref Position], and set the reference position with the number keys or 【↑】 or 【↓】 key or knob.</p> <p>{Atten <u>A</u>uto <u>M</u>an}: Press 【Ampt】 → [Atten <u>A</u>uto <u>M</u>an] to enable the auto or manual mode of the attenuator. You can change the mode with the number keys or the 【↑】 or 【↓】 key or knob.</p> <p>[Special note]: The attenuation range is 0dB - 60dB, with the step of 10dB.</p> <p>{Scale/Div}: Press 【Ampt】 → [Scale/Div] and set it with the number keys or the 【↑】 or 【↓】 key or knob. The scale/division setting range is 0.1dB-20dB.</p> <p>{Units}: The amplitude unit is dBm in the interference analyzer mode.</p> <p>{Pre Amp <u>O</u>ff <u>O</u>n}: Press 【Ampt】 → [Pre Amp <u>O</u>ff <u>O</u>n] to turn on or off the pre-amplifier.</p>
--	---

5.3.4 Bandwidth menu

<div style="border: 1px solid black; padding: 5px; margin-bottom: 5px; text-align: center;">BW</div> <div style="border: 1px solid black; border-radius: 10px; padding: 5px; margin-bottom: 5px; text-align: center;">Res BW Auto Manual</div> <div style="border: 1px solid black; border-radius: 10px; padding: 5px; margin-bottom: 5px; text-align: center;">Video BW Auto Manual</div> <div style="border: 1px solid black; border-radius: 10px; padding: 5px; margin-bottom: 5px; text-align: center;">Average Off On</div> <div style="border: 1px solid black; border-radius: 10px; padding: 5px; margin-bottom: 5px; text-align: center;">SPAN/RBW 100</div> <div style="border: 1px solid black; border-radius: 10px; padding: 5px; margin-bottom: 5px; text-align: center;">RBW/VBW 1</div> <div style="border: 1px solid black; border-radius: 10px; padding: 5px; margin-bottom: 5px; text-align: center;">Detector Auto ></div>	<p>{Res BW <u>A</u>uto Man}: Press 【BW】 → [Res BW <u>A</u>uto Man], and set it with the number keys on the front panel or the 【↑】 or 【↓】 key or knob.</p> <p>[Special note]: The resolution bandwidth depends on the bandwidth of the IF filter, while the trace shape depends on the filter of IF bandwidth. This instrument supports variable resolution bandwidth settings from 1Hz to 10MHz, with the step of 1-3-10.</p> <p>{Video BW <u>A</u>uto Man}: Press 【BW】 → [Video BW Auto <u>M</u>an] and change it with the number keys or the 【↑】 or 【↓】 key or knob.</p> <p>[Special note]: The video bandwidth filter is used for smoothing the trace so as to improve the ability to detect weak noise signals. This instrument supports variable resolution bandwidth settings from 1Hz to 10MHz, with the step of 1-3-10.</p> <p>{Average <u>O</u>ff On}: Press 【BW】 → [Average <u>O</u>ff On]. The averaging function can be used smoothing the displayed trace without changing the video bandwidth filter. It can be changed with the number keys or the 【↑】 or 【↓】 key or knob.</p> <p>{SPAN/RBW}: Press 【BW】 → [SPAN/RBW] to set the ratio of the span to resolution bandwidth. In the auto mode, the resolution bandwidth will change automatically with the span. This ratio can be changed with the number keys or the 【↑】 or 【↓】 key or knob.</p> <p>{RBW/VBW}: Press 【BW】 → [RBW/VBW]. In the auto mode, the video bandwidth will change automatically with the resolution bandwidth. This ratio can be changed with the number keys or the 【↑】 or 【↓】 key or knob.</p> <p>{Detector}: Press 【BW】 → [Detector] to enable the detector function menu. Refer to [Detector] menu for details.</p>
---	--

Detector	{Auto} : Press 【BW】 → [Detector] → [Auto] to enable the spectrum analyzer mode of the detector.
Auto	{Normal} : Press 【BW】 → [Detector] → [Normal] to enable the most commonly used detector mode. You can see the signal and noise floor at the same time, with no signal loss.
Normal	{Peak} : Press 【BW】 → [Detector] → 【Peak】 to prevent missing of any peak signal. This function can be applied to measure the signal close to the noise floor.
Peak	{Neg Peak} : Press 【BW】 → [Detector] → [Neg Peak]. This function is used in self-inspection of the MMW integrated test instrument in most cases and rarely in tests. By using this function, the modulation envelope of AM signal can be well reproduced.
Neg Peak	{Sample} : Press 【BW】 → [Detector] → [Sample]. This function is conducive for noise signal measurement. Compared with the normal mode of the detector, noise can be better measured.
Sample	{Average} : Press 【BW】 → [Detector] → [Average] to average the data within the sampling interval.
Average	{RMS} : Press 【BW】 → [Detector] → [RMS] to obtain the RMS value of the data within the sampling interval.
RMS	
< Back	

5.3.5 Marker menu

Marker	{Marker 1 2 3 4 5 6} : Press 【Marker】 → [Marker 1 2 3 4 5 6] to change various markers. The selected marker will be underlined.
Marker <u>1</u> 2 3 4 5 6	{Normal} : Press 【Marker】 → [Normal] to enable the normal mode of the current marker.
Normal	{Delta} : Press 【Marker】 → [Delta] to display the amplitude difference and frequency difference (time difference under zero bandwidth) of two markers. Move the active marker with the knob, step keys or number keys. The default amplitude difference is in dB.
Delta	{Marker Noise <u>Off</u> On} : Press 【Marker】 → [Marker Noise <u>Off</u> On]. The noise marker will indicate the noise power normalized to 1Hz bandwidth near the active marker. In this case, the “RMS” mode of the detector will be enabled. In default state, if the noise marker is enabled, the unit of the marker reading will automatically change into dBm/Hz.
Noise Marker <u>Off</u> On	{Marker→} : Press 【Marker】 → [Marker→] to open the marker function menu. By using such marker functions, the user can change the instrument display, with the marker as the reference. Refer to [Marker→] menu for details.
Marker >	{Off} : Press 【Marker】 → [Off] to disable the current active marker.
Off	{All Off} : Press 【Marker】 → [All Off] to disable all active markers.
All Off	

	[Special note]: Marker functions are not available in the RSSI mode.
Marker->	{Marker→Center} : Press 【Marker】 → [Marker→] → [Marker→Center]. The marker will move to the center frequency, and the center frequency will be displayed on the screen.
Marker-> Center	{Marker→CF Step} Press 【Marker】 → [Marker→] → [Marker→CF Step] and set the step of the center frequency. The step is equal to the marker frequency. If the differential marker function is activated, the frequency step is equal to the frequency of the differential marker.
Marker-> CF Step	{Marker→Start} Press 【Marker】 → [Marker→] → [Marker→Start], and set the starting frequency as the marker frequency.
Marker-> Start	{Marker→Stop} : Press 【Marker】 → [Marker→] → [Marker→Stop] and set the stop frequency as the marker frequency.
Marker-> Stop	{Back} : Go back to the previous menu.
< Back	(not available in the RSSI mode)

5.3.6 Peak menu

	{Max Search} : Press 【Peak】 → [Max Search] to set the current active marker at the maximum peak of the measured trace. The frequency and amplitude of the marker will be displayed in the middle upper part of the screen.
Peak	{Next Peak} : Press 【Peak】 → [Next Peak] to set the active marker at next peak associated with the current marker location on the trace.
Peak Search	{Next Pk Left} : Press 【Peak】 → [Next Pk Left] to find next peak on the left side of the current marker location.
Next Peak	{Next Pk Right} : Press 【Peak】 → [Next Pk Right] to find next peak on the right side of the current marker location.
Next Pk Left	{Max Search} : Set one marker at the highest point of the trace. The frequency and amplitude of the marker will be displayed in the right upper corner of the screen. The active functions will not change when this key is pressed.
Next Pk Right	{Min Search} : Press 【Peak】 → [Min Search] to set one marker at the lowest point of the trace. The frequency and amplitude of the marker will be displayed in the right upper corner of the screen. The active functions will not change when this key is pressed.
Max Search	{Marker→Center} : Press 【Peak】 → [Marker→Center] and set the center frequency as the marker frequency. By using this function, the signal can be rapidly moved to the screen center.
Min Search	(not available in the RSSI mode)
Marker-> Center	

5.3.7 Sweep menu

Sweep	<p>{Sweep Time <u>Auto</u> Man}: Press 【Sweep】 → [Sweep Time <u>Auto</u> Man] to switch the sweep time between the auto and manual modes. The current state is underlined. In the auto mode, the minimum sweep time will be set automatically by the integrated test instrument based on the current state and displayed on the screen. In the manual mode, you can enter the sweep time with the number keys and select the time unit with corresponding soft keys. When RBW and VBW are changed in the auto mode, the sweeping speed will change accordingly. The larger the RBW and VBW values are, the higher the sweeping speed is; and vice versa. Based on the compliance with minimum sweep time constraints, the maximum sweep time of 4024 series spectrum analyzer can be set as max. 800s under the non-zero span and max. 600s under zero span.</p>
Sweep Time <u>Auto</u> Man	<p>{Sweep <u>Cont</u> Single}: Press 【Sweep】 → [Sweep <u>Cont</u> Single]. The sweep type is decisive to the sweeping mode of the integrated test instrument and the time to stop sweeping and start holding. Two options are available in the interference analyzer mode: continuous and single.</p>
Sweep <u>Cont</u> Single	<p>{Sweep <u>Once}</u>: Press 【Sweep】 → [Sweep <u>Once</u>] to sweep once again.</p>
Sweep Once	

5.3.8 Auto Save menu

Record	<p>{Sweep Interval}: Press 【Record】 → [Sweep Interval Auto], and set the sweeping interval. In the default mode, the trace will be in the maximum holding state, so that all signals measured within the sweeping interval can be recorded.</p>
Sweep Interval Auto	<p>{Sweep Span}: Press 【Record】 → [Sweep Span Auto]. The span time will be the whole sweeping period. After reaching the span time, recording will be stopped.</p>
Sweep Span Auto	<p>{Record <u>Off</u> On}: Press 【Record】 → [Record <u>Off</u> On] to enable or disable the “Auto Save” mode.</p>
Record <u>Off</u> On	<p>[Special note]: This function cannot be enabled until the span time is set.</p>
Time Cursor 0	<p>{Time Cursor}: Press 【Record】 → [Time Cursor] to view historical data.</p>
Time Cursor 0	<p>[Special note]: This must be applied in the spectrogram mode.</p>
Restart	<p>{Restart}: Press 【Record】 → [Restart] to restart sweeping.</p>
Restart	<p>[Special note]: This is not available in the spectrum analyzer mode. The time cursor function is not available in the RSSI mode.</p>

5.3.9 Measurement menu

Measure	{Spectrum} : Press 【Measure】 → [Spectrum] to enable the spectrum measurement mode.
Spectrum	{Spectrogram} : Press 【Measure】 → [Spectrogram] to enable the spectrogram measurement mode.
Spectrogram	{RSSI} : Press 【Measure】 → [RSSI] to enable the RSSI measurement mode.
RSSI	

5.3.10 File menu

Refer to the introduction to the spectrum analyzer measurement mode for file menu details.

Chapter VI Power Meter Mode (optional)

Section 1 Introduction to Typical Measurements

In the power meter mode of 4024 series spectrum analyzer, the USB interface is connected with an external USB power probe through the USB cable to test the power. Using 8723X USB power probe provided by China Electronics Technology Instruments Co., Ltd., RF/microwave signals up to 40GHz can be tested, and the true average power with high dynamic range from -60dBm to +20dBm can be measured. The measurement reading will be shown on the display interface of the USB power meter mode of 4024 series. The block diagram of the test is shown in Fig. 6-1. The attenuator can be added according to the needs.

Caution

All operations in this chapter are based on the power meter mode, which will not be separately described below. This mode can be selected as follows:
【Mode】 → [Power Meter].

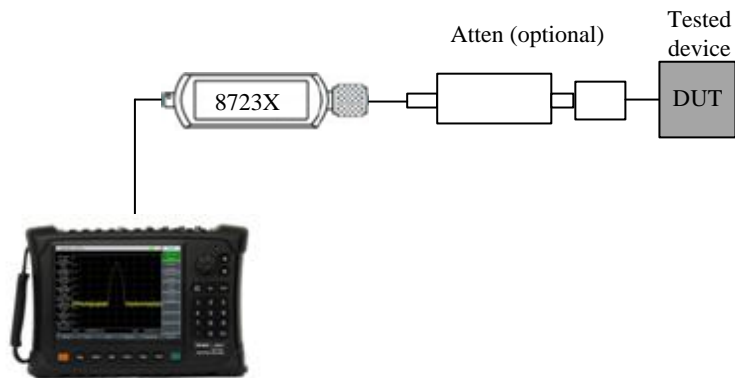

Fig. 6-1 Power Meter Structure

The power meter interface is shown in Fig. 6-2 (an example).

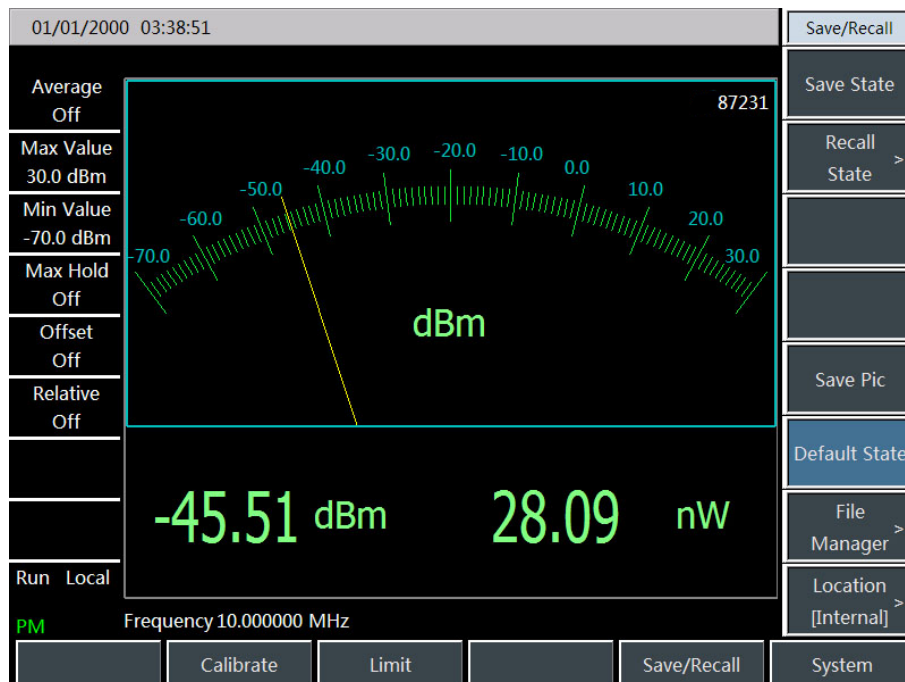

Fig. 6-2 Power Meter Interface

It is recommended to purchase the USB-based high-performance microwave power probe, which is developed by China Electronics Technology Instruments Co., Ltd. The following models are mainly available, and you can purchase the power probe according to test needs.

Caution

At first, observe the maximum input power range identified on the USB power probe, and ensure that the input is within the specified range, so as to prevent the probe from damage as a result of over high power.

Table 6-1 8723XUSB Power Probe

Model	Frequency range	Input power range	Input connector mode
87230	9kHz-6GHz	-50dBm to +20dBm	N(m)
87231	10MHz~18GHz	-60dBm to +20dBm	N(m)
87232	50MHz~26.5GHz	-60dBm to +20dBm	3.5mm(m)
87233	50MHz~40GHz	-60dBm to +20dBm	2.4mm(m)

Connection of power probe

- Connect the small end of the USB cable to 8723X USB power probe.
- Connect the large end of the USB cable to the USB interface of the spectrum analyzer. The green indicator of the power probe will be ON a moment later.
- The USB power probe can be shut down after the USB cable is removed. In this case, the green LED indicator will be OFF.

Caution

8723X USB power probe is provided with a USB cable. You can use your own USB cable conforming to international safety standards.

Section 2 Structure of Power Meter Menu

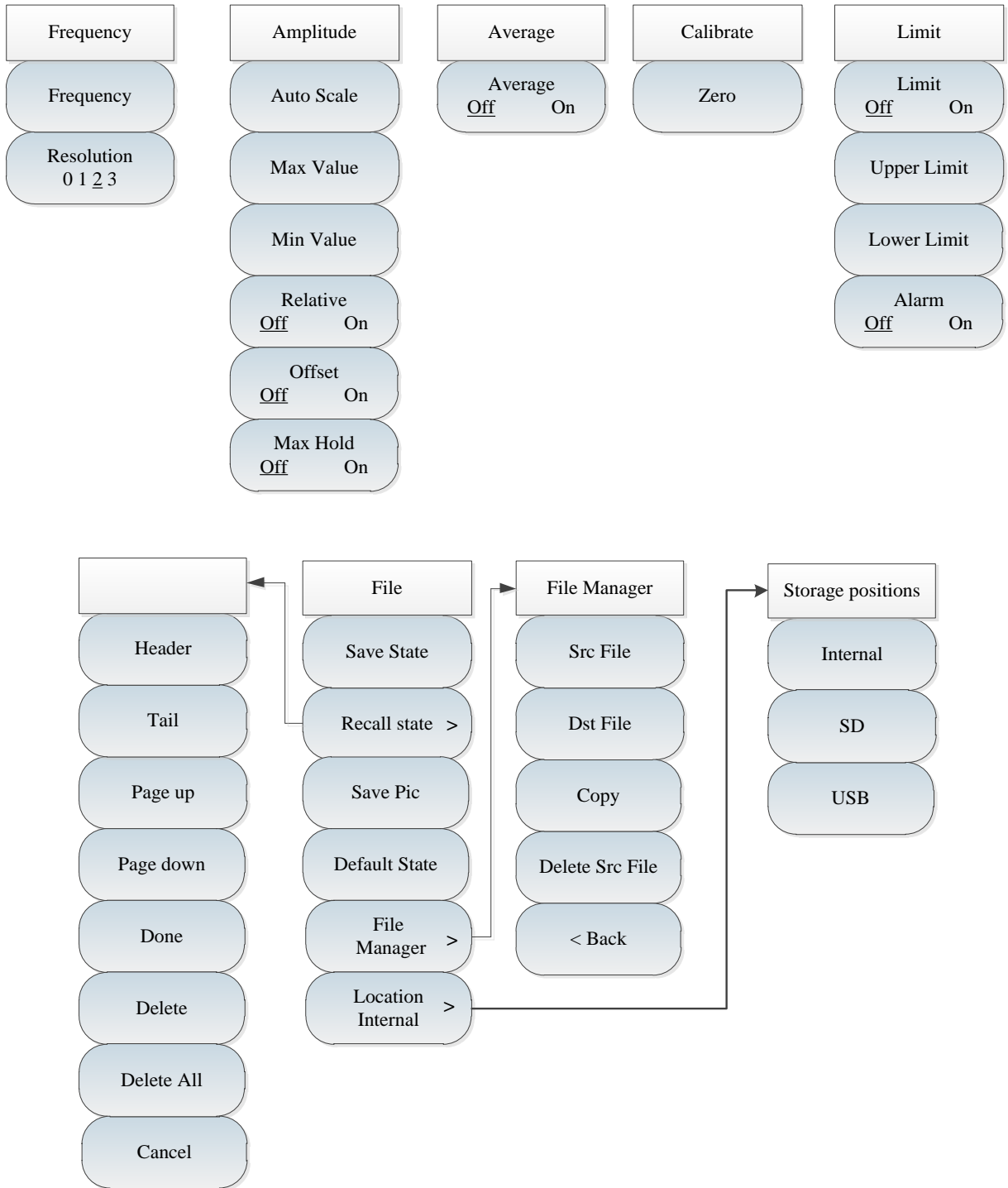

Fig. 6-3 Overall Block Diagram of Power Meter Menu

Section 3 Description of Power Meter Menu

6.3.1 Frequency menu

Frequency	{Freq} : Press {Freq} → [Frequency] and set the frequency with the number keys. Then select the corresponding frequency menu, or change the frequency with the {↑} or {↓} key or knob, with the step of 10MHz.
Frequency	[Special note]: The frequency setting range is related to the selected USB power probe. Refer to Table 6-1 for details.
Resolution 0 1 2 3	{Resolution 0 1 2 3} : Press {Freq} → [Resolution 0 1 2 3] and change the display accuracy of measurement data. 0 indicates the integer, 1 indicates one decimal, 2 indicate two decimals, and 3 indicate 3 decimals.

6.3.2 Amplitude menu

Amplitude	{Auto Scale} : Press {Ampt} → [Auto Scale] and make the measurement signal displayed within 10dB.
Auto Scale	{Max Value} : Press {Ampt} → [Max Value] to set the maximum value of the current signal. You can change the maximum value with the number keys or {↑} or {↓} key or knob. The default step is 1dB.
Max Value	{Min Value} : Press {Ampt} → [Min Value] to set the minimum value of the current signal. You can change the minimum value with the number keys or {↑} or {↓} key or knob. The default step is 1dB.
Min Value	{Relative Off On} : Press {Ampt} → [Relative <u>Off</u> On]. The relative measurement function reflects the power change of the set reference signal, in dB and %. When the relative measurement function is enabled, the current power level will be measured and saved. At the same time, one power level relative to the saved value will be displayed.
Relative <u>Off</u> On	{Offset Off On} : Press {Ampt} → [Offset <u>Off</u> On]. If the power of the tested part is higher than the maximum power that can be measured by the instrument, the attenuator can be connected to reduce the tested power to be within the normal measurement range. The power offset function can be used for setting the offset of the added attenuator or connecting cable so as to balance the attenuation amount or cable loss. At the same time, the amplifier gain can be increased by setting the power offset. If the value is positive, the loss will be compensated; and if the value is negative, the gain will be compensated.
Offset <u>Off</u> On	{Max Hold Off On} : Press {Ampt} → [Max Hold <u>Off</u> On] to enable the maximum holding function. In this case, the measured maximum value of the signal will be displayed.
Max Hold <u>Off</u> On	

6.3.3 Bandwidth menu

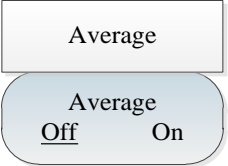
	<p>{Average Off On}: Press 【BW】 → [Average <u>Off</u> On]. Change the average with the number keys or 【↑】 or 【↓】 key or knob, with the step of 1.</p> <p>[Special note]: The averaging function is generally applied to smooth the trace in measurement of the low-power signal or signal close to the noise power, so as to reduce the influence of random noise on measurement, and improve the measurement accuracy. However, the measurement speed will be reduced at the same time. The averaging frequency is decisive to the average reading frequency. The higher the averaging frequency is, the more noise will be reduced.</p>
---	--

6.3.4 Calibrate menu

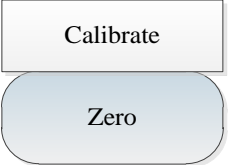
	<p>{Zero}: Press 【Calibrate】 → [Zero].</p> <p>[Special attention]: To improve measuring precision of the instrument, zero calibration of the instrument is necessary before small signal power measuring of 8723X Series USB Power Probe. Zero calibration refers to measurement and saving of noise of the whole measurement channel. Deduct zero correction value, i.e. the noise of the whole measurement channel during the measurement to obtain input signal level of the channel. The USB power probe is calibrated in the same way as the ordinary power probe. The calibration here refers to internal calibration of the USB power probe, in which the switch is added at the front end of the measurement channel. The user can measure and save the channel noise without disconnecting the sensor from the tested part. The RF signal should be always applied on the power probe during internal zero calibration, so as to reduce the wear of the probe connector and shorten the test time.</p>
--	--

6.3.5 Limit menu

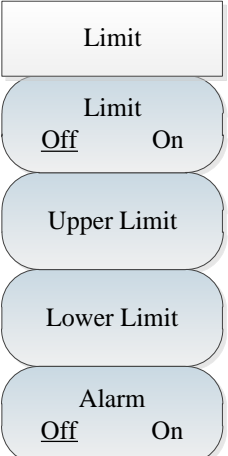
	<p>{Limit Off On}: Press 【Limit】 → [Limit <u>Off</u> On] to enable the limit.</p> <p>{Upper Limit}: Press 【Limit】 → [Upper Limit]. Change the upper limit with the number keys or 【↑】 or 【↓】 key or knob, with the step of 1dB.</p> <p>{Lower Limit}: Press 【Limit】 → [Lower Limit]. Change the lower limit with the number keys or 【↑】 or 【↓】 key or knob, with the step of 1dB.</p> <p>{Alarm Off On}: Press 【Limit】 → [Alarm <u>Off</u> On]. The limit alarm should be enabled when the limit is ON. If the measured data exceed the set limits, the instrument will send alarm prompts.</p>
---	---

6.3.6 File menu

Refer to the file menu description in the spectrum analyzer mode.

Caution

The functions of saving and recalling the data file are not available in the power meter mode!

Chapter VII AM-FM-PM Analyzer Mode (optional)

Section 1 Introduction to Typical Measurements

The AM-FM-PM analyzer mode is used for displaying the spectrum of AM, FM and PM signals and analyzing relevant parameters. The main spectrum and relevant parameters are shown below:

RF spectrum: Similar to the spectrum analyzer mode, the frequency spectrum of the modulation signal will be displayed, and the occupied bandwidth can be measured.

Audio spectrum: Display the frequency spectrum of the demodulated audio signal.

Audio waveform: Display the waveform of the demodulated audio signal within the time domain.

Parameter analysis: Measure and analyze the carrier power, modulation rate, carrier offset, modulation depth (AM), modulation frequency offset (FM), modulation phase deviation (PM), S/N, modulation distortion and total harmonic distortion of the modulated signal.

Caution

All operations in this chapter are based on the AM-FM-PM analyzer mode, which will not be separately described below.

Three spectrograms can be displayed at the same time or respectively in the AM-FM-PM analyzer mode.

Press **【Measure】** and select [RF Spectrum], [Audio Spectrum], [Audio Waveform] and [Summary] to display one or all spectrum(s).

In order to better observe the measured signal, the following steps can be taken:

- 1) Press **【Measure】** → [Demod Type AM FM PM] to select the type of the analog signal to be demodulated.
- 2) Press **【Freq】** → [Center Freq] and set the center frequency of the measured signal.
- 3) Press **【BW】** → [IFBW], and set the appropriate IF bandwidth with the number keys or **【↑】** or **【↓】** key or knob.
- 4) Press **【Ampt】** → [Ref Level] and set the reference level of the RF spectrum. Press [Scale/Div] and set the appropriate scale/division to facilitate the viewing of RF spectrum.
- 5) Press [Audio Spectrum] → [Span] and set the appropriate span. Press [Scale/Div] and set the appropriate scale/division to facilitate the viewing of the frequency spectrum of the audio signal.
- 6) Press [Audio Waveform] → [Sweep Time], and set the display time of the audio signal waveform. Press [Scale/Div] and set the appropriate scale/division to facilitate the viewing of the frequency spectrum of the audio signal.

Caution

Set the appropriate IF bandwidth. The IF bandwidth should be more than the width of the modulation signal, so as to accurately demodulate the signal. You can observe the bandwidth in the RF spectrum. At the same time, noise may be produced in the case of too large IF bandwidth, which will affect the accuracy of parameter measurement.

Taking the FM signal measurement for example, the AM-FM-PM analyzer mode is introduced as follows. At first, input the FM signal generated by one signal source to the RF input end of the instrument. Set the signal frequency as 6GHz, amplitude as -10dBm, modulation rate as 3kHz and modulation offset as 30kHz. Measurement procedures are as follows:

- 1) Press **【Measure】** → [Demod Type AM FM PM] and select FM.
- 2) Press **【Freq】** → [Center Freq] and set the center frequency of the measured signal as 6GHz.
- 3) Press **【BW】** → [IFBW] and set the IF bandwidth as 100kHz.
- 4) Press [Audio Spectrum]→ [Span], and set the span as 50kHz.
- 5) Press [[Audio Waveform] → [Sweep Time] and set the sweep time as 2ms.

Measurement results are shown in Fig. 7-1.

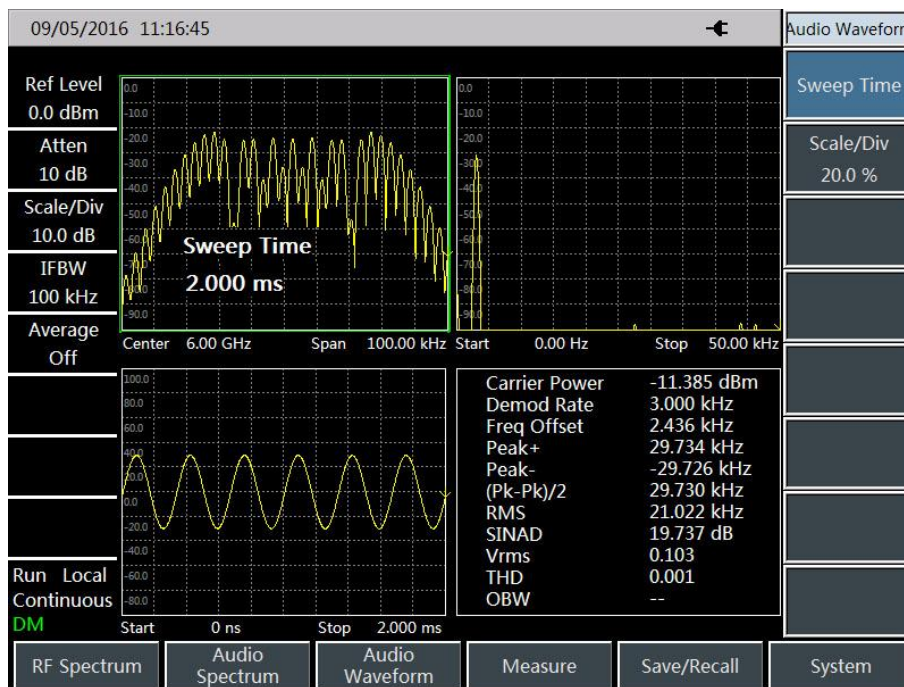

Fig. 7-1 FM Demodulation Analysis Results

Section 2 Structure of AM-FM-PM analyzer Menu

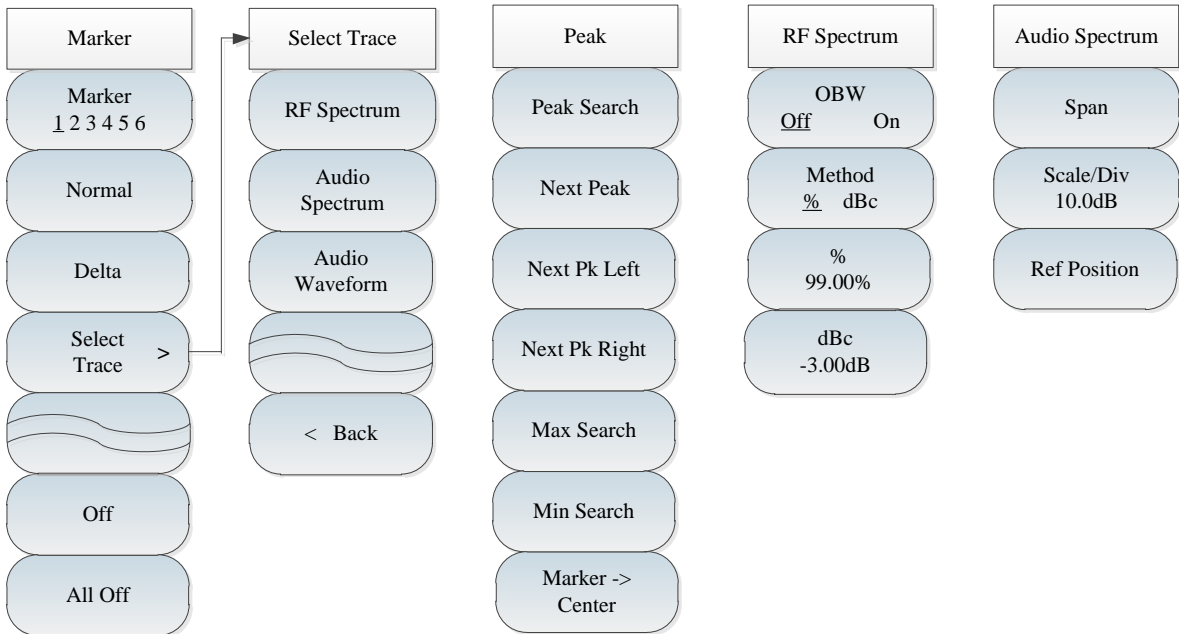
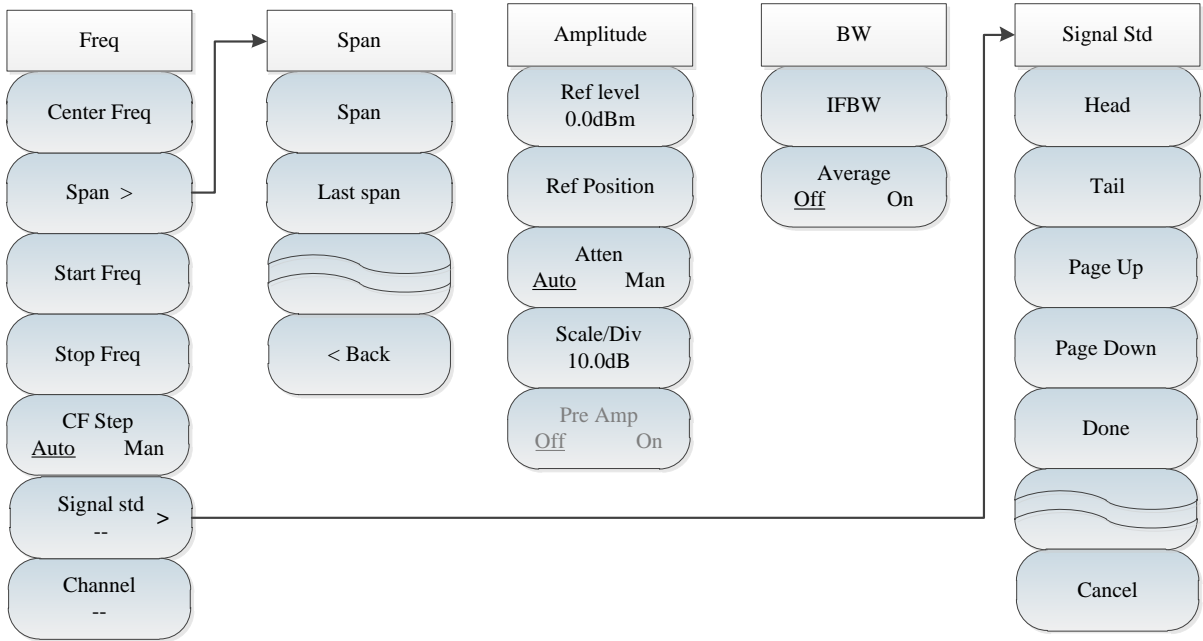

Fig. 7-2 AM-FM-PM Analyzer Menu

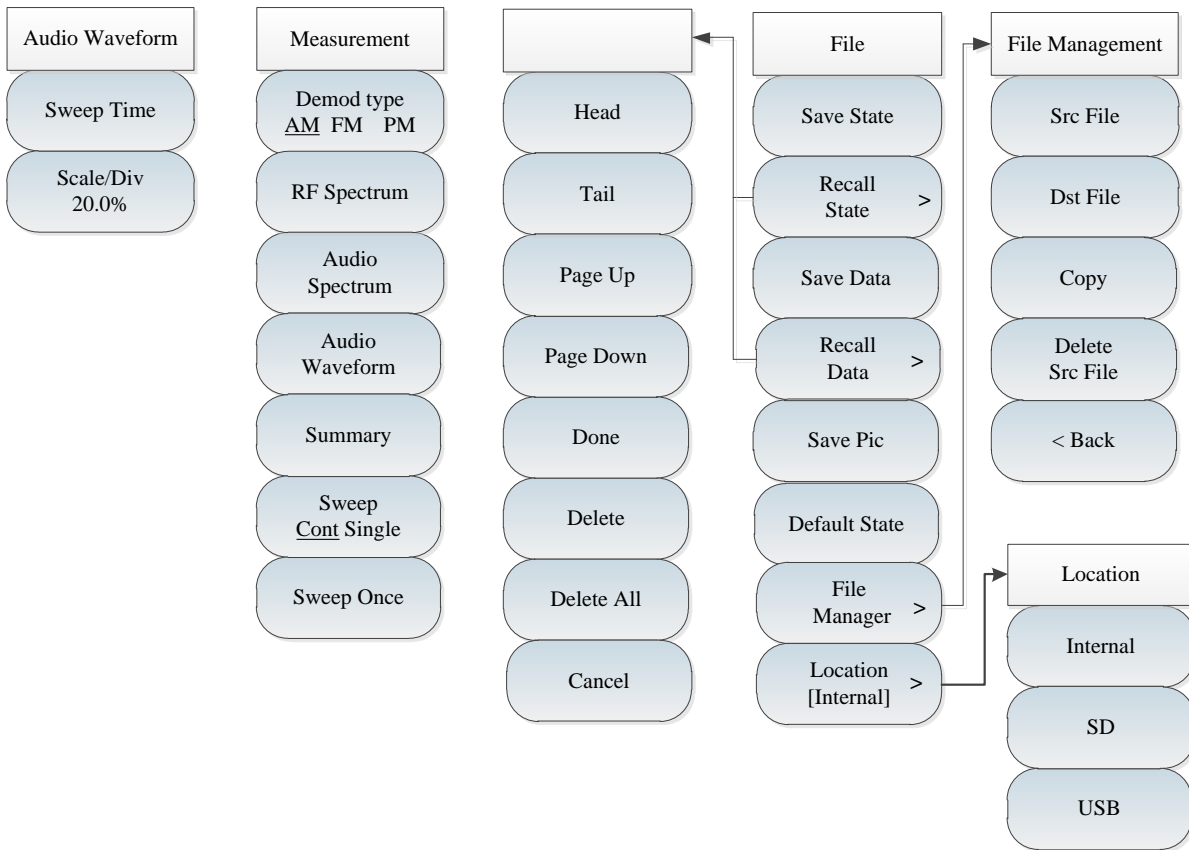

Fig. 7-3 AM-FM-PM Analyzer Menu (continued)

Section 3 Description of AM-FM-PM Analyzer Menu

7.3.1 Frequency menu

Freq	<p>{Center Freq}: Press 【Freq】 →[Center Freq] and set it with the number keys on the front panel. Then select [GHz], [MHz], [kHz] or [Hz] in the frequency unit menu, or set the center frequency with the 【↑】 or 【↓】 key or knob.</p>
Center Freq	<p>[Special note]: When the 【↑】 or 【↓】 key or knob is applied, the frequency step should be the same as the set value of [Step Freq]. You can set the step frequency with the number keys or 【↑】 or 【↓】 key or knob after changing [CF Step <u>Auto</u> Man] into [CF Step Auto <u>Man</u>].</p>
Span >	<p>{Span}: Press 【Freq】 →[Span] to activate the span menu. Set the span with the number keys, and select the frequency unit, or set the span with the 【↑】 or 【↓】 key or knob. Refer to [Span] menu description for details.</p>
Start Freq	<p>[Special note]: When the span is changed with the 【↑】 or 【↓】 key or knob, the step should be 1-2-5.</p>
Stop Freq	<p>{Start freq}: Press 【Freq】→[Start Freq], and set the starting frequency with the number keys on the front panel. Select the corresponding frequency unit or set the starting frequency with the 【↑】 or 【↓】 key or knob.</p>
CF Step Auto Man	<p>{Stop Freq}: Press 【Freq】 →[Stop Freq], and set the stop frequency with the number keys on the front panel. Select the corresponding frequency unit or set the stop frequency with the 【↑】 or 【↓】 key or knob.</p>
Signal std --	<p>{Signal Std}: Press 【Freq】→[Signal Std], and relevant soft menus will pop up, including [Head], [Tail], [Page Up], [Page Down] and [Done]. Select the related signal standard, and recall it with [Done] or [ok] in the menu.</p>
Channel --	<p>[Special note]: When the signal standard is applied, the center frequency and span will be set as those defined in the signal standard.</p>
	<p>{Channel}: Press 【Freq】 →[Channel], and the channel setting dialog box will pop up. Set the channel with the number keys or 【↑】 or 【↓】 key or knob.</p>
	<p>[Special note]: The channel should be set based on the applied signal standard; otherwise, the prompt that setting is not allowed will pop up.</p>

7.3.2 Span menu

Span	{Span} : Press 【Freq】 → [Span] to activate the span menu. Set the span with the number keys, or change the span by selecting the frequency unit or with the 【↑】 or 【↓】 key or knob.
Span	[Special note] : When the span is changed with the 【↑】 or 【↓】 key or knob, the step should be 1-2-5.
Last span	{Last span} : Press 【Freq】 → [Span] → [Last Span] and recover the last span.
< Return	{Back} : Press 【Freq】 → [Span] → [Back] to go back to the 【Freq】 menu.

7.3.3 Amplitude menu

Amplitude	{Reference level} : Press 【Ampt】 → [Ref Level] and set it with the number keys on the front panel. Select [dBm], [-dBm], [mV] or [uV] in the frequency unit menu, or set the value with the 【↑】 or 【↓】 key or knob.
Ref level 0.0dBm	[Special note] : When the 【↑】 or 【↓】 key or knob is applied, the step should be 10dB.
Ref Position	{Reference position} : Press 【Ampt】 → [Ref Position], and set the reference position with the number keys or 【↑】 or 【↓】 key or knob.
Atten Auto Man	{Atten <u>A</u>uto <u>M</u>an} : Press 【Ampt】 → [Atten <u>A</u> uto <u>M</u> an] to enable the auto or manual mode of the attenuator. You can change the mode with the number keys or the 【↑】 or 【↓】 key or knob.
Scale/Div 10.0dB	[Special note] : The attenuation range is 0dB to +60dB, with the step of 10dB.
Pre Amp Off On	{Scale/Division} : Press 【Ampt】 → [Scale/Div] and set it with the number keys or the 【↑】 or 【↓】 key or knob. The scale/division setting range is 0.1dB-20dB.
	{Pre Amp <u>O</u>ff <u>O</u>n} : Press 【Ampt】 to control the ON/OFF state of the pre-amplifier. This function cannot be activated until the reference level is less than -40dBm.

7.3.4 Bandwidth menu

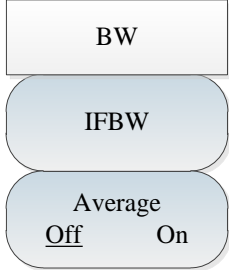
 <p>The diagram shows three vertically stacked buttons. The top button is rectangular and labeled 'BW'. The middle button is rounded and labeled 'IFBW'. The bottom button is rounded and labeled 'Average' with 'Off' and 'On' options below it.</p>	<p>{IF bandwidth} Press 【BW】 → [IFBW] and set the IFBW with the number keys on the front panel. Select the corresponding frequency unit, i.e. [GHz], [MHz], [kHz] or [Hz], or set the IFBW with the 【↑】 or 【↓】 key or knob.</p> <p>[Special note]: The IF bandwidth should be more than the bandwidth of the modulated signal so as to accurately demodulate the signal. You can observe the bandwidth of the modulated signal in the RF spectrum. Noise may be generated in the case of too large IF bandwidth, which will affect the accuracy of parameter measurement. The IF bandwidth range is from 10kHz to 300kHz, with the step of 1-3-10.</p> <p>{Average <u>Off</u> On}: Press 【BW】 →[Average <u>Off</u> On]. The averaging function is used for smoothing the displayed trace. When the averaging function is enabled, the averaging frequency can be selected with the number keys or 【↑】 or 【↓】 key or knob.</p>
--	--

7.3.5 Marker menu

Marker	{Marker 1 2 3 4 5 6} : Press 【Marker】 → [Marker 1 2 3 4 5 6] to change various markers. The selected marker will be underlined.
Marker 1 2 3 4 5 6	{Normal mode} : Press 【Marker】 → [Normal] to enable the normal mode of the current marker.
Normal	{Delta mode} : Press 【Marker】 → [Delta] to enable the delta mode of the current marker. In this case, the frequency difference and amplitude difference (time difference under zero span) between the differential marker and reference marker will be displayed. The amplitude will be displayed in dB.
Delta	
Select Trace	{Select Trace} : Press 【Marker】 → [Select Trace], and soft menus related to the trace will pop up, including [RF Spectrum], [Audio Spectrum] and [Audio Waveform]. Refer to the [Select Trace] menu for details.
Off	{Off} : Press 【Marker】 → [Off] to disable the current active marker.
All Off	{All Off} : Press 【Marker】 → [All Off] to disable all active markers.

Select Trace	{Select Trace} : Press 【Marker】 → [Select Trace].
RF Spectrum	{RF spectrum} : Press 【Marker】 → [Select Trace] → [RF Spectrum] to select the trace in the RF spectrum. In this case, the marker can only be operated on this trace.
Audio Spectrum	{Audio Spectrum} : Press 【Marker】 → [Select Trace] → [Audio Spectrum], and select the trace in the audio spectrum. In this case, the marker can only be operated on this trace.
Audio Waveform	{Audio Waveform} : Press 【Marker】 → [Select Trace] → [Audio Waveform], and select the trace in the audio waveform. In this case, the marker can only be operated on this trace.
< Back	

7.3.6 Peak menu

Peak	<p>{Maximum Peak}: Press 【Peak】 →[Max Peak] to set the current active marker at the maximum peak of the measured trace. The frequency and amplitude of the marker will be displayed in the middle upper part of the screen.</p>
Peak Search	<p>{Next Peak}: Press 【Peak】 →[Next Peak] to set the active marker at next peak associated with the current marker location on the trace.</p>
Next Peak	<p>{Next Peak Left}: Press 【Peak】 →[Next Pk Left] to find next peak on the left side of the current marker location.</p>
Next Pk Left	<p>{Next Peak Right}: Press 【Peak】 →[Next Pk Right] to find next peak on the right side of the current marker location.</p>
Next Pk Right	<p>{Maximum value}: Set one marker at the highest point of the trace. The frequency and amplitude of the marker will be displayed in the right upper corner of the screen. The active functions will not change when this key is pressed.</p>
Max Search	<p>{Minimum value}: Press 【Peak】 →[Min Search] to set one marker at the lowest point of the trace. The frequency and amplitude of the marker will be displayed in the right upper corner of the screen. The active functions will not change when this key is pressed.</p>
Min Search	<p>{Marker→Center}: Press 【Peak】 →[Marker→Center] and set the center frequency as the marker frequency. By using this function, the signal can be rapidly moved to the screen center, which is only effective for the RF spectrum.</p>
Marker -> Center	<p>[Special note]: Each peak, maximum value and minimum value will be searched on the selected trace. Refer to [Select Trace] menu for details.</p>

7.3.7 RF spectrum menu

RF Spectrum	<p>[Special note]: The occupied bandwidth measurement in the RF spectrum is similar to that in the spectrum analyzer mode. The RF spectrum is only applied in the AM-FM-PM analyzer mode.</p>
OBW Off On	<p>{OBW Off On}: Press [RF Spectrum]→ [OBW Off On] to enable or disable the occupied bandwidth measurement.</p>
Method % dBc	<p>{Method % dBc}: Press [RF Spectrum]→ [Method % dBc] and select various measurement methods: percentage or drop dBc. In the percentage method, the occupied bandwidth of the signal is obtained by calculating the bandwidth of the frequency of certain percentage to the total power of the transmitted power, and the power percentage can be set by the user. In the drop dBc method, the occupied bandwidth is defined as follows: spacing between two frequency points corresponding to signal power drop by dBc on both sides of the frequency point where the signal peak power is. The signal power drop dBc can be set by the user.</p>
% 99.00%	<p>{%}: Press [RF Spectrum]→ [%] and set the percentage.</p>
dBc -3.00dB	<p>{dBc}: Press [RF Spectrum]→ [dBc] and set the dBc value.</p>

7.3.8 Audio spectrum menu

Audio Spectrum	<p>{Span}: Press [Audio Spectrum]→ [Span], and set the span of the audio spectrum. The span should be large enough to display the audio signal and related harmonics. You can change the span with the number keys and select the frequency unit, or with the 【↑】 or 【↓】 key or knob.</p>
Span	<p>{Scale/Division}: Press [Audio Spectrum]→ [Scale/Div], and set the scale of the audio spectrum, so as to facilitate the observation of the audio spectrum trace. You can change the scale unit with the number keys and select the power unit [dB] or [-dB], or use the 【↑】 or 【↓】 key or knob.</p>
Scale/division 10.0dB	<p>{Reference position}: Press [Audio Spectrum]→ [Ref Position], and set the reference position of the audio spectrum to facilitate the observation of the audio spectrum line. You can change the reference position with the number keys and click [OK], or with the 【↑】 or 【↓】 key or knob.</p>
Reference position	

7.3.9 Audio waveform menu

Audio Waveform	<p>{Sweep time}: Press [Audio Waveform]→ [Sweep Time] and set the audio waveform sweeping time. The longer the sweep time is and the more points are sampled, the stabler the measurement results will be.</p>
Sweep Time	<p>{Scale/Division}: Press [Audio Waveform]→ [Scale/Div] and set the scale of the audio waveform to facilitate the observation of the audio spectrum trace. You can change the scale unit with the number keys and select [%] or click [OK], or with the 【↑】 or 【↓】 key or knob.</p>
Scale/Div 20.0%	<p>{Special note}: The scale unit changes with the type of the modulation signal. The scale unit should be percentage (%) in AM signal measurement, frequency unit (Hz, kHz or GHz) in FM signal measurement and radian (Rad) in PM signal measurement.</p>

7.3.10 Measurement menu

Measurement	<p>{Demo Type AM FM PM}: Press 【Measure】→ [Demod Type AM FM PM] and select the type of the modulation signal.</p>
Demod type <u>AM</u> FM PM	<p>{RF Spectrum}: Press 【Measure】 → [RF Spectrum] to display the RF spectrum only.</p>
RF Spectrum	<p>{Audio Spectrum}: Press 【Measure】 → [Audio Spectrum] to display the audio spectrum only.</p>
Audio Spectrum	<p>{Audio Waveform}: Press 【Measure】 → [Audio Waveform] to display the audio waveform only.</p>
Audio Waveform	<p>{Summary}: Press 【Measure】 → [Summary] to display the RF spectrum, audio spectrum and audio waveform at the same time.</p>
Summary	<p>{Sweep <u>Cont</u> Single}: Press 【Measure】 → [Sweep <u>Cont</u> Single] to enable continuous or single sweeping.</p>
Sweep <u>Cont</u> Single	<p>{Sweep Once}: Press 【Measure】→ [Sweep Once] to trigger sweeping once. Sweeping can only be performed once again in the single mode.</p>
Sweep Once	

7.3.11 File menu

Refer to the file menu description in the spectrum analyzer mode.

Chapter VIII Channel Scanner Mode (optional)

Section 1 Introduction to Typical Measurements

The channel scanner mode can be applied to measure the signal power of multiple channels. The signal power is displayed in the bar graph or list form. At most, the signal power of 20 channels can be displayed. This can be divided into three modes according to the channel setting: channel scanner, frequency scanner and list scanner.

Channel scanner: Set the measured channel by setting the signal standard, starting channel and channel step.

Frequency scanner: Set the measured channel by setting the starting frequency and frequency step.

List Scanner: Set the measured channel by setting the list.

The bandwidth and number of measured channels can be set in the above three modes.

Caution

All operations in this chapter are based on the channel scanner mode, which will not be separately described below.

8.1.1 Channel Scanner

Below is an example of the Channel Scanner mode, mainly involving the following procedures.

- 1) Press **【Sweep】** → [Channel Scanner] → [Signal Std], and set the signal standard of measurement.
- 2) Press **【Sweep】** → [Channel Scanner] → [Start Channel] and set the starting channel of measurement. In this case, the starting channel should meet the requirements of the selected signal standard.
- 3) Press **【Sweep】** → [Channel Scanner] → [Number of Channels], and set the number of measured channels. At most 20 channels can be measured at the same time.
- 4) Press **【Sweep】** → [Channel Scanner] → [Channel Step] and set the channel step of measurement. A certain number of channels will be measured with the starting channel as the initial channel, based on the set channel step.
- 5) Press **【Sweep】** → [Display Graph Table] and enable the graph display mode.
- 6) Press **【Sweep】** → [Power Display Curr Max] and enable the maximum option. Set the maximum power of each displayed channel.

Caution

The power cannot be set as the maximum value until the maximum holding function is enabled.

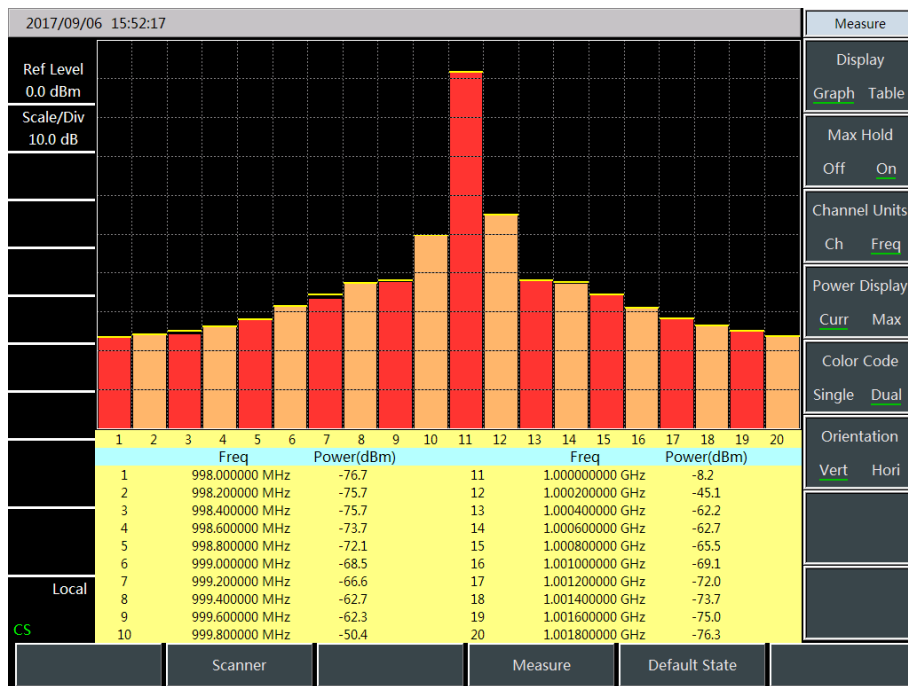

Fig. 8-1 Schematic Diagram of Channel Scanner

8.1.2 Frequency Scanner

Below is an example of the Frequency Scanner mode, mainly involving the following procedures.

- 1) Press **【Sweep】** → [FScan] → [Start Freq], and set the center frequency of the starting channel.
- 2) Press **【Sweep】** → [FScan] → [Step Freq], and set the frequency step of the measured channel.
- 3) Press **【Sweep】** → [FScan] → [Bandwidth], and set the bandwidth of the measured channel.
- 4) Press **【Sweep】** → [FScan] → [Number of Channels], and set the number of measured channels. At most 20 channels can be measured at the same time.
- 5) Press **【Measure】** → [Display Graph Table] and enable the graph display mode.
- 6) Press **【Measure】** → [Power Display Curr Max], and enable the “Current” option. Set the current power of each channel.
- 7) Press **【Measure】** → [Color Code Single Dual] and enable the dual color mode.
- 8) Press **【Measure】** → [Orientation Vert Hori] and enable the horizontal mode.

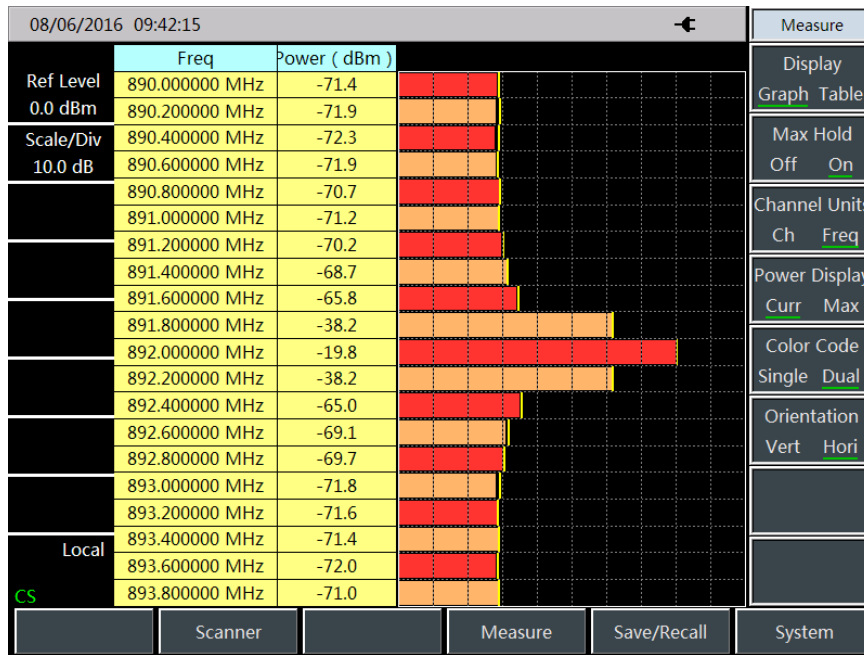

Fig. 8-2 Schematic Diagram of Frequency Scanner

8.1.3 List scanner

Below is an example of the Frequency Scanner mode, mainly involving the following procedures.

- 1) Press **【Sweep】** → [MScan] → [Edit List] and edit the channel list to be swept. The information of each channel can be set by setting the signal standard and channel number or setting the frequency and bandwidth in the list.
- 2) Press **【Sweep】** → [MScan] → [Number of Channels], and set the number of measured channels. At most 20 channels can be measured at the same time.
- 3) Press **【Sweep】** → [Display Graph Table] and enable the graph display mode.
- 4) Press **【Sweep】** → [Power Display Curr Max], and enable the “Current” option. Set the current power of each channel.

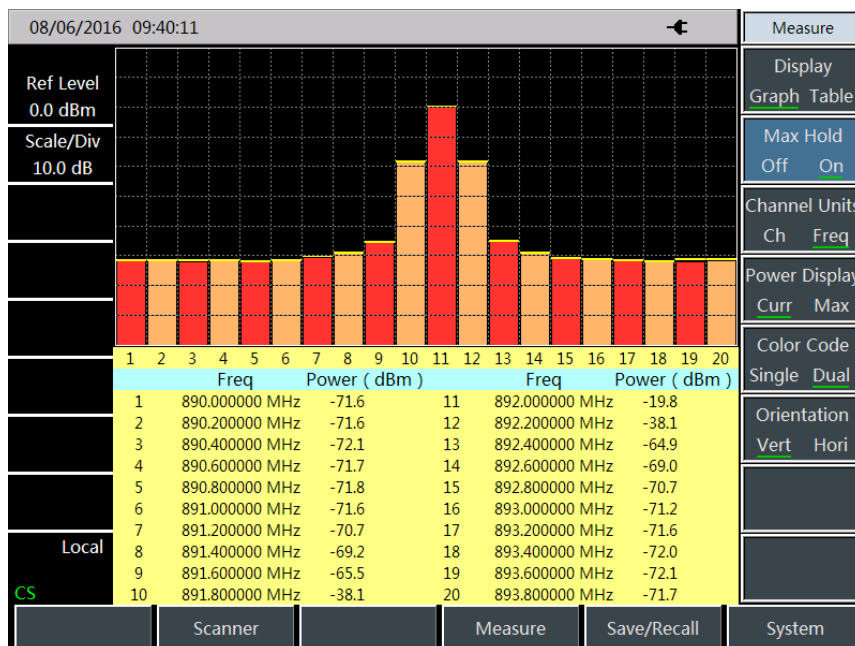

Fig. 8-3 Schematic Diagram of List Scanner

Section 2 Structure of Channel Scanner Menu

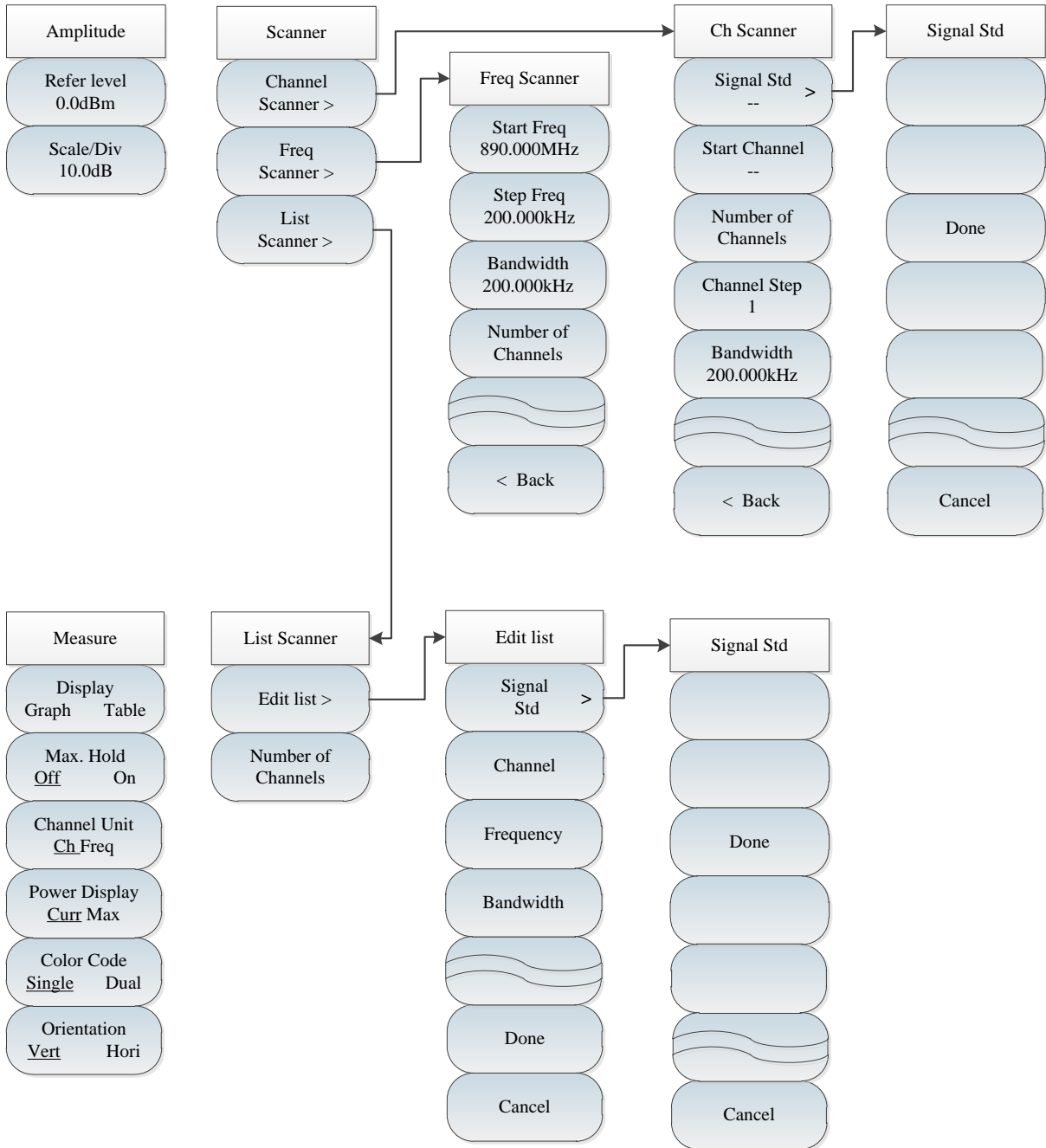

Fig. 8-1 Channel Scanner Menu

Section 3 Description of Channel Scanner Menu

8.3.1 Scanner menu

Scanner	{Channel Scanner} : Press 【Sweep】 → [Channel Scanner], set the channel scanner mode and activate [Channel Scanner] menu. You can the channel parameters in [Channel Scanner] menu. Refer to [Channel Scanner] menu.
Channel Scanner >	{Freq Scanner} : Press 【Sweep】 → [Freq Scanner], set the frequency scanner mode and activate [Freq Scanner] menu. You can the channel parameters in [Freq Scanner]. Refer to [Freq Scanner] menu.
Freq Scanner >	{List Scanner} : Press 【Sweep】 → [List Scanner], set the list scanner mode and activate [List Scanner] menu. You can the channel parameters in [List Scanner]. Refer to [List Scanner] menu.
List Scanner >	

8.3.2 Channel Scanner menu

Ch Scanner	{Signal standard} : Press 【Sweep】 → [Channel Scanner]→ [Signal Std], and the existing signal standard list will pop up, including relevant menus such as [Head], [Tail], [Page Up] and [Page Down]. Click [Done], and select the corresponding signal standard.
Signal Std --	
Start Channel --	{Start Channel} : Press 【Sweep】 →[Channel Scanner]→[Start Channel], and set the number of the starting channel. In this case, the starting channel will be the initial channel of measurement and cannot be set until the signal standard is selected.
Number of Channels	{Number of Channels} : Press 【Sweep】 → [Channel Scanner]→ [Number of Channels], and set the number of measured channels. At most 20 channels can be measured.
Channel Step 1	{Channel Step} : Press 【Sweep】 → [Channel Scanner]→ [Channel Step], and set the step between the measured channels.
Bandwidth 200.000kHz	{bandwidth} : Press 【Sweep】 → [Channel Scanner]→ [Bandwidth], and set the bandwidth of the measured channel.
< Back	

8.3.3 Frequency Scanner menu

Freq Scanner	{Start frequency} : Press 【Sweep】 → [Freq Scanner] → [Start Freq], and set the center frequency of the starting channel.
Start Freq 890.000MHz	{Step Freq} : Press 【Sweep】 → [Freq Scanner] → [Step Freq], and set the frequency step between channels.
Step Freq 200.000kHz	{bandwidth} : Press 【Sweep】 → [Freq Scanner] → [Bandwidth], and set the bandwidth of the measured channel.
Bandwidth 200.000kHz	{Number of Channels} : Press 【Sweep】 → [Freq Scanner] → [Number of Channels], and set the number of measured channels. At most 20 channels can be measured.
Number of Channels	
< Back	

8.3.4 List Scanner menu

List Scanner	{Edit list} : Press 【Sweep】 → [List Scanner] → [Edit List], and the corresponding [Edit List] menu will pop up. Refer to [Edit List] menu for details.
Edit list >	{Number of Channels} : Press 【Sweep】 → [List Scanner] → [Number of Channels], and set the number of measured channels. At most 20 channels can be measured.
Number of Channels	

Edit list	{Signal Std} : Press [Edit List] → [Signal Std] and the signal standard list will pop up, including [Head], [Tail], [Page Up] and [Page Down]. Select the required signal standard and click [Done].
Signal Std	
Channel	{Channel} : Press [Edit List]→ [Channel] to display the selected signal standard, channel range, etc. The user can also emit channel and click [Done] to save the setting.
Frequency	{Center Freq} : Press [Edit List]→ [Center Freq], edit the center frequency of the selected channel, and click [Done] to save the setting.
Bandwidth	{bandwidth} : Press [Edit List]→ [Bandwidth], edit the bandwidth of the selected channel, and click [Done] to save the setting.
Done	{Done} : Press [Edit List]→ [Done] to save the modified settings and go back to the List Scanner menu.
Cancel	{Cancel} : Press [Edit List]→ [Cancel] to cancel the modified settings and go back to the List Scanner menu.

8.3.5 Measurement menu

Measure	{Display <u>Graph</u> Table} : Press 【Measure】 →[Display <u>Graph</u> Table] and select the graph/table mode, as shown in Fig. 8-7 and 8-8.
Display <u>Graph</u> Table	
Max. Hold <u>Off</u> On	{Max Hold <u>Off</u> On} : Press 【Measure】 → [Max Hold <u>Off</u> On] to enable or disable the maximum holding function.
Channel Unit <u>Ch</u> Freq	{Channel Units <u>Ch</u> Freq} : Press 【Measure】 →[Channel Units <u>Ch</u> Freq] and set the channel or frequency display mode.
Power Display <u>Curr</u> Max	{Power Display <u>Curr</u> Max} : Press 【Measure】 →[Power Display <u>Curr</u> Max] and set the current or maximum display mode. The maximum power cannot be set until the maximum holding function is enabled.
Color Code <u>Single</u> Dual	{Color Code <u>Single</u> Dual} : Press 【Measure】 →[Color Code <u>Single</u> Dual], and set the single or dual display mode.
Orientation <u>Vert</u> Hori	{Orientation <u>Vert</u> Hori} : Press 【Measure】 →[Orientation <u>Vert</u> Hori] and set the vertical or horizontal display mode.

8.3.6 File menu

Refer to the description of the file menu in the spectrum analyzer mode.

Chapter IX Field Strength Measurement Mode (optional)

Section 1 Introduction to Typical Measurements

The field strength measurement is indispensable in radiation strength measurement of the tested equipment and can be divided into three modes: PScan, FScan and MScan.

PScan: Observe the offset, amplitude and field strength of the current point by setting the point frequency.

FScan: Observe the amplitude and field strength changes within a certain frequency range by setting the starting frequency, step frequency and number of points.

MScan: Observe the amplitude and field strength of frequency points in the list by recalling the edited or saved list.

Caution

All the operations in this chapter are based on the Field Strength mode, which will not be separately described below.

9.1.1 PScan

Main operation procedures of [PScan]:

- 1) Press **【Measure】** → [PScan] to enable the point frequency measurement mode.
- 2) Press **【Freq】** → [Pot Freq] and set the point frequency within the range of [1MHz, 44.1GHz].
- 3) Press **【BW】** → [BW] and set the bandwidth as 150Hz, 300Hz, 600Hz, 1.5kHz, 2.4kHz, 6kHz, 9kHz, 15kHz, 30kHz, 50kHz, 120kHz or 150kHz.
- 4) Press **【Swp/Ant】** → [Recall Antenna], and select the antenna factor file.
- 5) Press [Demod] and set the demodulation type and volume.

The schematic diagram of PScan mode is shown in the figure below (example).

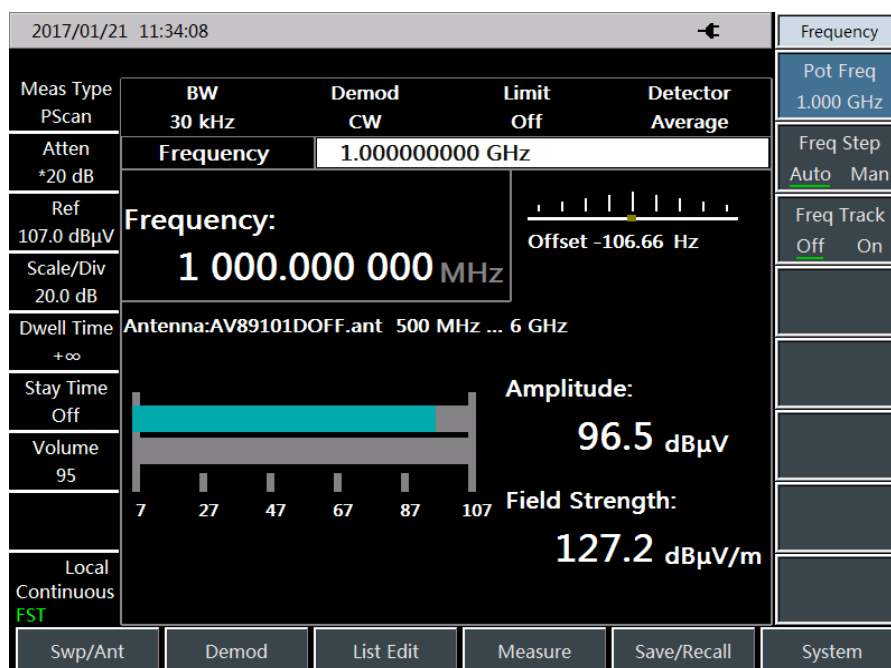

Fig. 9-1 Schematic Diagram of PScan Mode

9.1.2 FScan

Main operation steps of FScan:

- 1) Press **【Measure】** → [FScan] to enable the frequency sweeping mode.
- 2) Press **【Freq】** → [Stt Freq] and set the starting frequency of sweeping.
- 3) Press **【Freq】** → [Step Freq] and set the step frequency of sweeping.
- 4) Press **【Freq】** → [Points] and set the number of sweeping points.
- 5) Press **【BW】** → [BW] and set the bandwidth as 150Hz, 300Hz, 600Hz, 1.5kHz, 2.4kHz, 6kHz, 9kHz, 15kHz, 30kHz, 50kHz, 120kHz or 150kHz.
- 6) Press **【Swp/Ant】** → [Recall Antenna], and select the antenna factor file.
- 7) Press **【Swp/Ant】** → [Dwell Time +∞ Man], and set the dwell time.
- 8) Press **【Swp/Ant】** → [Dwell Time Off On] to enable or disable the dwell time.
- 9) Press **【Marker】** → [Marker Off On] to enable or disable the marker.
- 10) Press **【Peak】** to directly set the marker at the maximum point

Caution

The dwell time refers to the time of dwelling at the frequency point exceeding the set limit in the ON state.

The schematic diagram of FScan mode is shown in the figure below (example).

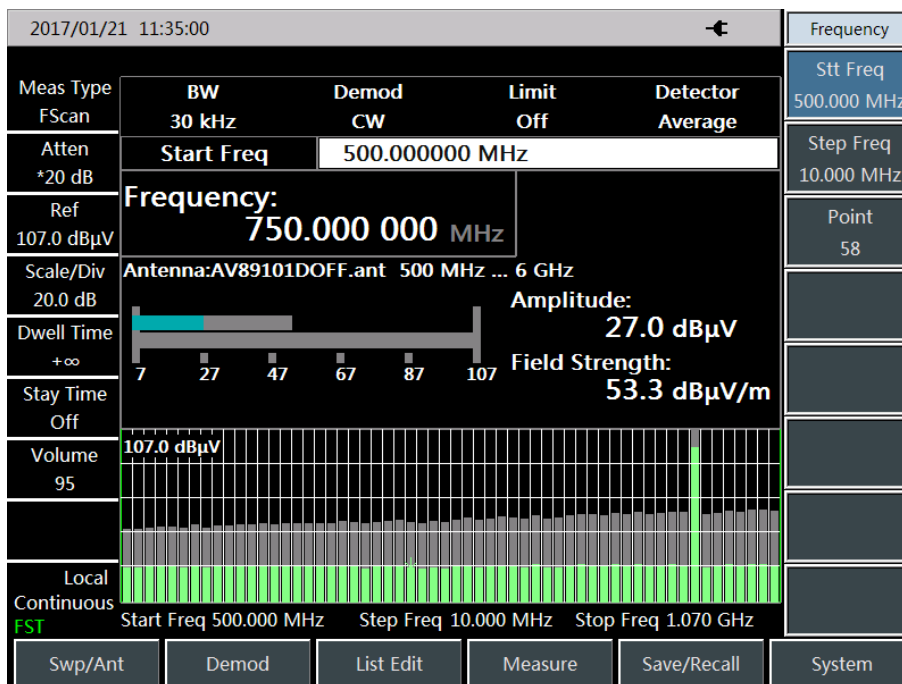

Fig. 9-2 Schematic Diagram of FScan Mode

9.1.3 MScan

Main operation steps of MScan:

- 1) Press **【List Edit】** → [Edit List] and edit the current list.

- 2) Press **【Measure】** → [MScan] to enable the MScan mode.
- 3) Press **【List Edit】** → [Edit List] → [Freq] and set the step frequency of sweeping.
- 4) Press **【List Edit】** → [Edit List] → [BandWidth] and set the bandwidth as 150Hz, 300Hz, 600Hz, 1.5kHz, 2.4kHz, 6kHz, 9kHz, 15kHz, 30kHz, 50kHz, 120kHz or 150kHz.
- 5) Press **【Swp/Ant】** → [Recall Antenna], and select the antenna factor file.
- 6) Press **【Swp/Ant】** → [Dwell Time +∞ Man], and set the dwell time.
- 7) Press **【Swp/Ant】** → [Dwell Time Off On] to enable or disable the dwell time.
- 8) Press **【Marker】** → [Marker Off On] to enable or disable the marker.
- 9) Press **【Peak】** to directly set the marker at the maximum point.

Caution

The MScan mode can be changed only the list is not empty.

The schematic diagram of MScan mode is shown in the figure below (example).

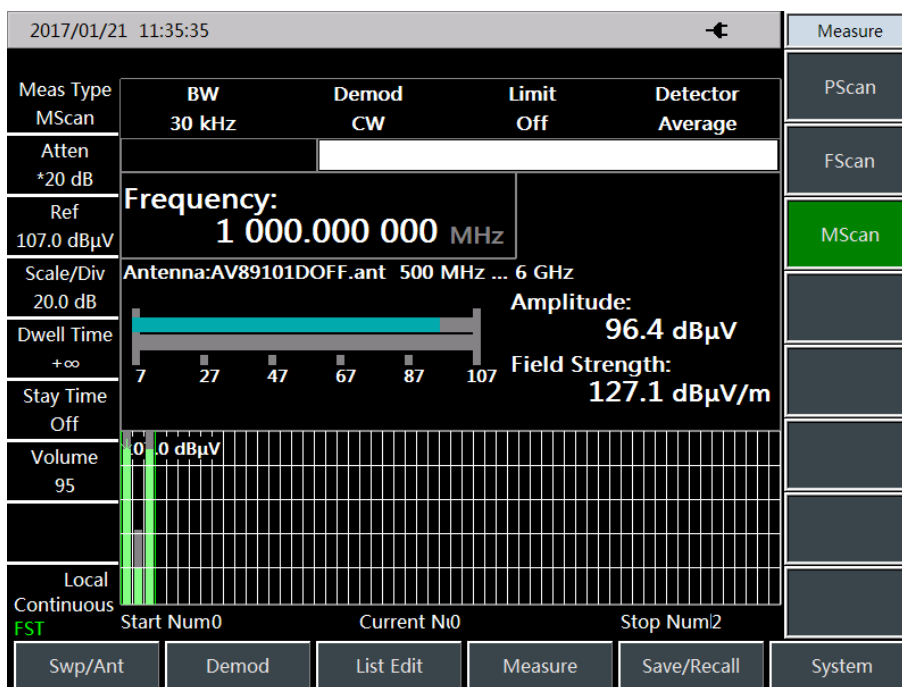

Fig. 9-3 Schematic Diagram of MScan Mode

Section 2 Structure of Field Strength Menu

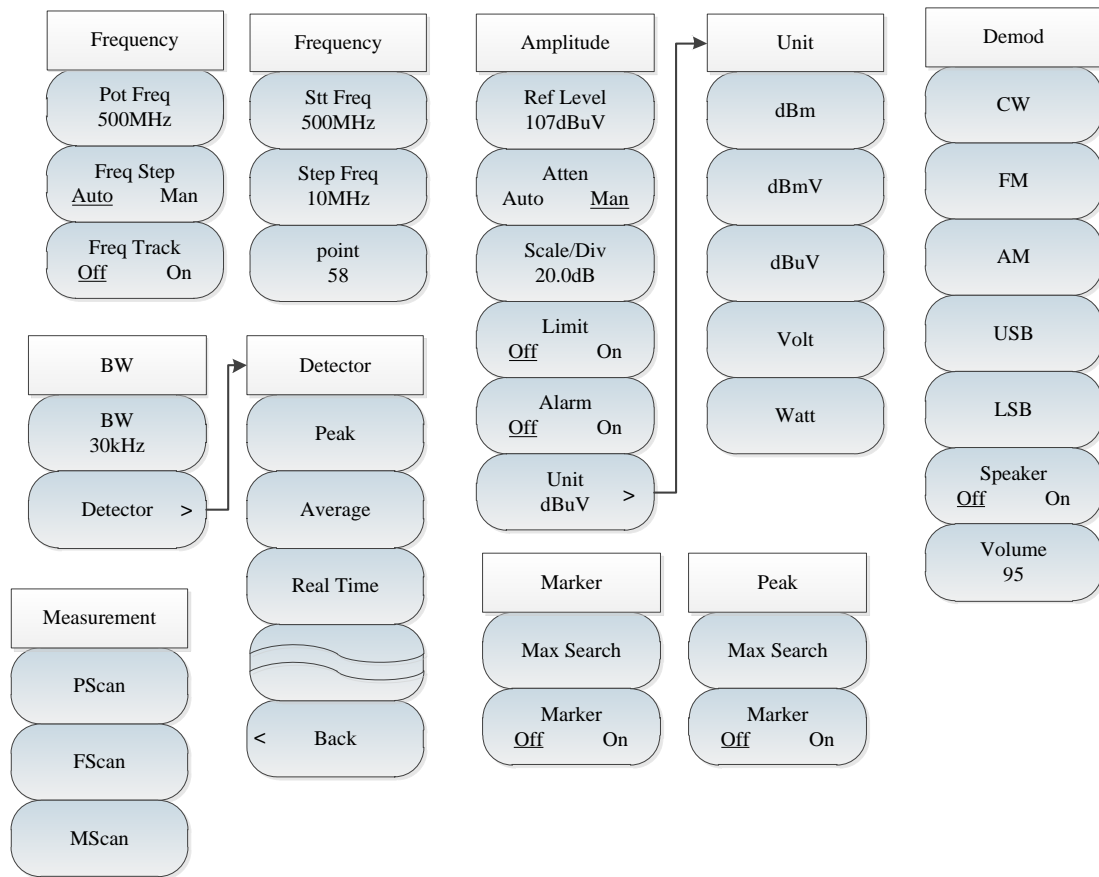

Fig. 9-4 Overall Block Diagram of Field Strength Menu

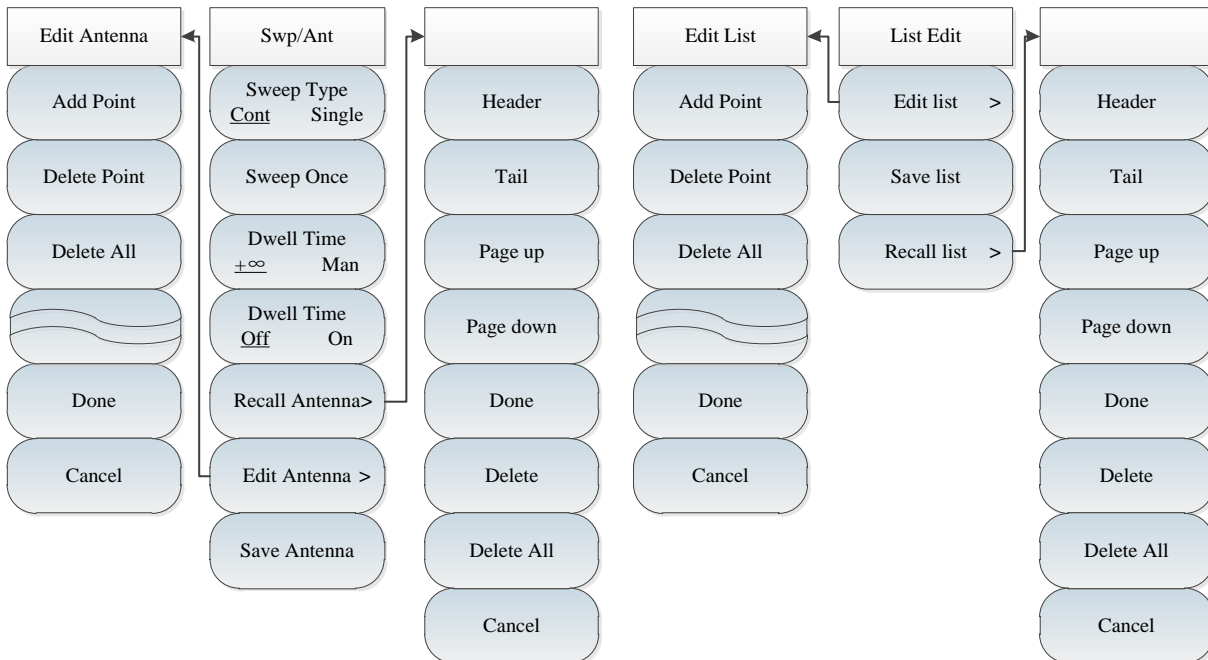

Fig. 9-5 Overall Block Diagram of Field Strength Menu (continued)

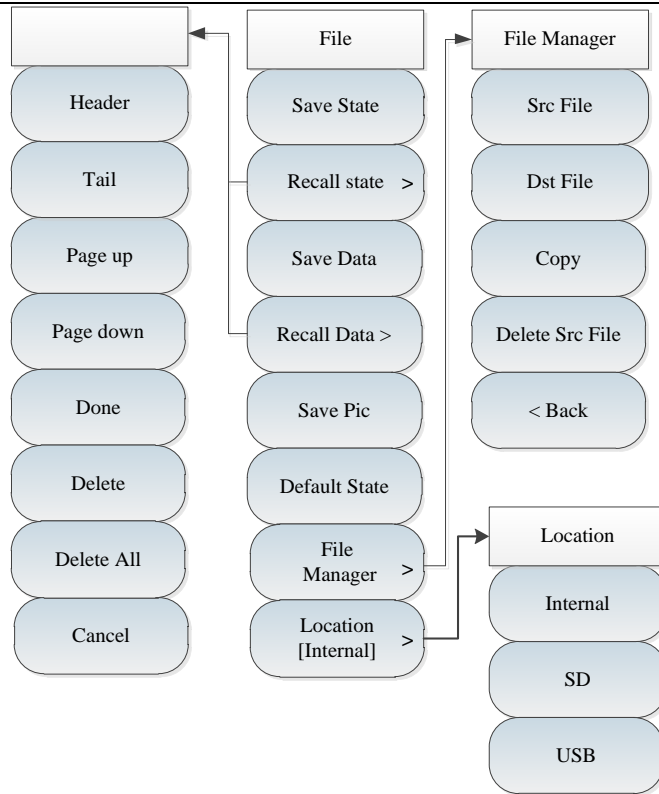

Fig. 9-6 Overall Block Diagram of Field Strength Menu (continued)

Section 3 Description of Field Strength Menu

9.3.1 Frequency menu ([PScan] mode)

<p>Frequency</p>	<p>{Pot Freq}: Press 【Freq】 → [Freq] and set the frequency with the number keys on the front panel. Select [GHz], [MHz], [kHz] or [Hz] in the frequency unit menu, or change the point frequency with the 【↑】 or 【↓】 key or knob.</p>
<p>Pot Freq 500MHz</p>	<p>[Special note]: The point frequency setting range is 1MHz to 44.1GHz.</p>
<p>Freq Step Auto Man</p>	<p>{Freq step}: Press 【Freq】 → [Freq Step Auto <u>Man</u>] and set the point frequency step with the 【↑】 or 【↓】 key or knob. The frequency step should be set as 1MHz in the auto mode.</p>
<p>Freq Track Off On</p>	<p>{Freq Track <u>Off</u> On}: Press 【Freq】 → [Freq Track <u>Off</u> On] to enable or disable frequency tracking. When the frequency tracking is enabled, the instrument is able to automatically track the frequency of the peak point, and the tracked frequency will be displayed on the current frequency display zone of the screen.</p>
	<p>[Special note]: The peak point in frequency tracking refers to the peak point of the amplitude signal searched within the current bandwidth range.</p>

9.3.2 Frequency menu ([FScan] mode)

<p>Frequency</p>	<p>{Stt Freq 500MHz}: Press 【Freq】 → [Stt Freq 500MHz] and set the starting frequency with the number keys on the front panel. Select [GHz], [MHz], [kHz] or [Hz] in the frequency unit menu, or set the starting frequency with the 【↑】 or 【↓】 key or knob.</p>
<p>Stt Freq 500MHz</p>	<p>[Special note]: The setting range of the starting frequency is 1MHz to 44.1GHz.</p>
<p>Step Freq 10MHz</p>	<p>{Step Freq 10MHz}: Press 【Freq】 → [Step Freq 10MHz], and set the sweeping frequency step with the 【↑】 or 【↓】 key or knob.</p>
<p>point 58</p>	<p>{Point 58}: Press 【Freq】 → [Point 58] and set the number of frequency sweeping points between 2 and 58.</p>

9.3.3 Amplitude menu

Amplitude	<p>{Ref Level 107dBuV} : Press 【Ampt】 → [Ref Level 107dBuV] and set the reference value with the number keys on the front panel. Select [dBuV], [-dBuV], [mV] or [uV] in the frequency unit menu, or set the reference value with the 【↑】 or 【↓】 key or knob.</p>
Ref Level 107dBuV	<p>[Special note]: The setting range of the reference value is -43dBuV to 147dBuV.</p>
Atten Auto <u>Man</u>	<p>{Atten Auto <u>Man</u>}: Press 【Ampt】 → [Atten Auto <u>Man</u>]. In the auto mode, the attenuation amount of the attenuator will be adjusted automatically according to the reference value. In the manual mode, the set attenuation amount will always be applied in the attenuator.</p>
Scale/Div 20.0dB	<p>{Scale/Div 20.0dB}: Press 【Ampt】 → [Scale/Div 20.0dB] and set the scale/division with the number keys on the front panel. Select [dB] or [-dB] in the frequency unit menu, or set the reference value with the 【↑】 or 【↓】 key or knob.</p>
Limit <u>Off</u> On	<p>{Limit <u>Off</u> On}: Press 【Ampt】 → [Limit <u>Off</u> On] to enable or disable the limit.</p>
Alarm <u>Off</u> On	<p>{Alarm <u>Off</u> On}: Press 【Ampt】 → [Alarm <u>Off</u> On] to enable or disable the audio alarm.</p>
Unit dBuV >	<p>{Units dBuV}: Press 【Ampt】 → [Units] to enable the unit menu, including [dBm], [dBmV], [dBuV], [Volt] or [Watt].</p>

9.3.4 Bandwidth menu

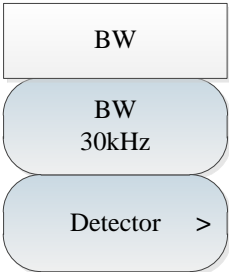
	<p>{BW 30kHz}: Press 【BW】 → [BW 30kHz] and set the bandwidth with the number keys on the front panel. Select [GHz], [MHz], [kHz] or [Hz] in the frequency unit menu, or set the reference value with the 【↑】 or 【↓】 key or knob.</p> <p>{Special note}: The bandwidth must be set as 150Hz, 300Hz, 600Hz, 1.5kHz, 2.4kHz, 6kHz, 9kHz, 15kHz, 30kHz, 50kHz, 120kHz or 150kHz.</p> <p>{Detector}: Press 【BW】 → [Detector] to enable the detector menu, including: Peak, Average and Real Time.</p>
---	---

9.3.5 Marker menu

	<p>{Max Search}: Press 【Marker】 → [Max Search] to set the marker at the maximum point.</p> <p>{Marker Off On}: Press 【Marker】 → [Marker <u>Off</u> On] to enable or disable the marker display.</p> <p>{Special note}: The marker menu will be valid only in the FScan and MScan mode.</p>
--	---

9.3.6 Peak menu

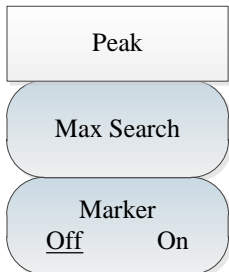
	<p>{Max Search}: Press 【Peak】 → [Max Search] to set the marker at the maximum point.</p> <p>{Marker Off On}: Press 【Peak】 → [Marker <u>Off</u> On] to enable or disable the marker display.</p> <p>{Special note}: The peak menu will be valid only in the FScan and MScan mode.</p>
---	---

9.3.7 Sweep/Antenna menu

Swp/Ant	<p>{Sweep <u>Cont</u> Single}: Press 【Swp/Ant】 → [Sweep <u>Cont</u> Single] to enable the continuous or single sweeping mode.</p> <p>{Sweep Once}: Press 【Swp/Ant】 → [Sweep Once] to sweep once again.</p> <p>{Dwell Time <u>+∞</u> Man}: Press 【Swp/Ant】 → [Dwell Time <u>+∞</u> Man] to set the dwell time. The dwell time refers to the time of dwelling at the point with the amplitude beyond the limits in the ON state. The default setting is infinite, and the manual setting range is 1ms to 40s.</p> <p>{Special note}: The dwell time will be valid only when the limits are in the ON state.</p> <p>{Dwell Time <u>Off</u> On}: Press 【Swp/Ant】 → [Dwell Time <u>Off</u> On] to set the dwell time. The dwell time refers to the waiting time at each point in sweeping. The default setting is the OFF state, and the manual setting range is 1ms to 40s.</p> <p>{Special note}: The dwell time will be valid only in the FScan and MScan mode.</p> <p>{Recall Antenna}: Press 【Swp/Ant】 → [Recall Antenna] and soft menus such as [Head], [Tail], [Page Up], [Page Down], [Done] and [Delete] will pop up. You can select and recall the saved antenna factor file.</p> <p>{Edit Antenna}: Press 【Swp/Ant】 → [Recall Antenna], and soft menus such as [Add Point], [Delete Point], [Delete All], [Done] and [Cancel] will pop up. This menu is applied to edit the antenna factor.</p> <p>{Save Antenna}: Press 【Swp/Ant】 → [Save Antenna] to open the antenna saving dialog box, where the antenna factor file can be saved.</p>
Sweep Type <u>Cont</u> Single	
Sweep Once	
Dwell Time <u>+∞</u> Man	
Dwell Time <u>Off</u> On	
Recall Antenna >	
Edit Antenna >	
Save Antenna	

9.3.8 Edit List menu

List Edit	<p>{Edit list}: Press [Edit List] → [Edit List], and soft menus such as [Add Point], [Delete Point], [Delete All], [Done] and [Cancel] will pop up, by which the list can be edited.</p> <p>{Save List}: Press [Edit List] → [Save List] to open the list saving dialog box, where the list file can be saved.</p> <p>{Recall List}: Press [Edit List] → [Recall List] and soft menus such as [Head], [Tail], [Page Up], [Page Down], [Done] and [Delete] will pop up, by which the saved list can be selected and recalled.</p>
Edit list >	
Save list	
Recall list >	

9.3.9 Demodulation menu

Demod	{ CW }: Press [Demod]→ [CW] to disable the demodulation mode.
CW	{ FM }: Press [Demod]→ [FM] to enable the FM mode.
FM	{ AM }: Press [Demod]→ [AM] to enable the AM mode.
AM	{ USB }: Press [Demod]→ [USB] to enable the upper sideband mode.
USB	{ LSB }: Press [Demod]→ [LSB] to enable the lower sideband mode.
LSB	{ Speaker <u>Off</u> On }: Press [Demod]→[Speaker <u>Off</u> On] to enable or disable the audio alarm function.
Speaker Off On	{ Special note }: If the audio alarm is enabled, the demodulation mode such as [FM], [AM], [USB] and [LSB] will not be available.
Volume 95	{ Volume 95 }: Press [Demod]→[Volume 95] to set the demodulation volume. Set the required volume with the number keys or 【↑】 or 【↓】 key or knob.

9.3.10 Measurement menu

Measure	{ PScan }: Press 【Measure】 →[PScan] to enable the MScan mode of field strength.
PScan	{ FScan }: Press 【Measure】 →[FScan] to enable the FScan mode of field strength.
FScan	{ MScan }: Press 【Measure】 →[MScan] to enable the MScan mode of field strength.
MScan	{ Special note }: Ensure that the list exists before enabling the MScan mode. You can view it by clicking [Edit List]- [Edit List].

9.3.11 File menu

Refer to the description of the file menu in the spectrum analyzer mode.

Chapter X Signal analyzer mode (option)

Section 1 Introduction to typical measurement

The signal analysis measurement mode is to provide the rapid analysis of interference signal, realize the display and playback of historical data by waterfall chart, quickly realize the modification of center frequency and span parameters by shortcut menu and quickly realize the audio output and IQ Capture function.

Caution

All operations of this chapter are based on that the signal analysis mode has been selected. This will not be separately described below.

The main interface of signal analysis measurement mode will measure by reference to interference analysis waterfall chart for the convenience of observing the periodic or jumped interference signal. The signal analysis is specially designed with shortcut menu to quickly set the center frequency and span parameters, activate the audio output and IQ Capture and improve the rapid analysis of interference signal. The main interface display of signal analysis is as shown in Fig. 10-1:

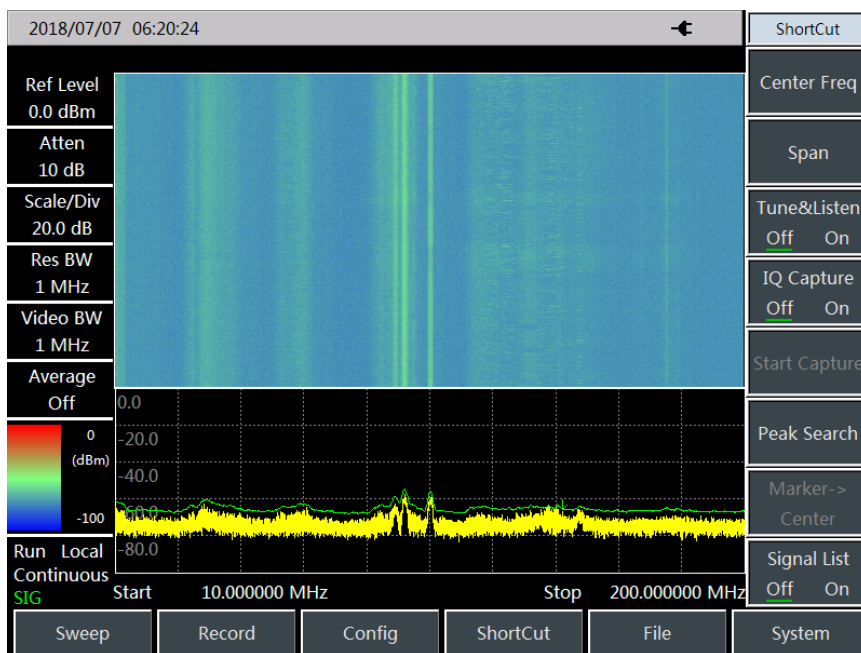

Fig. 10-1 Main interface display of signal analysis measurement mode

The signal analysis includes signal list menu to view the frequency, amplitude, capture time and other parameters of captured interference signal, as shown in Fig. 10-2.

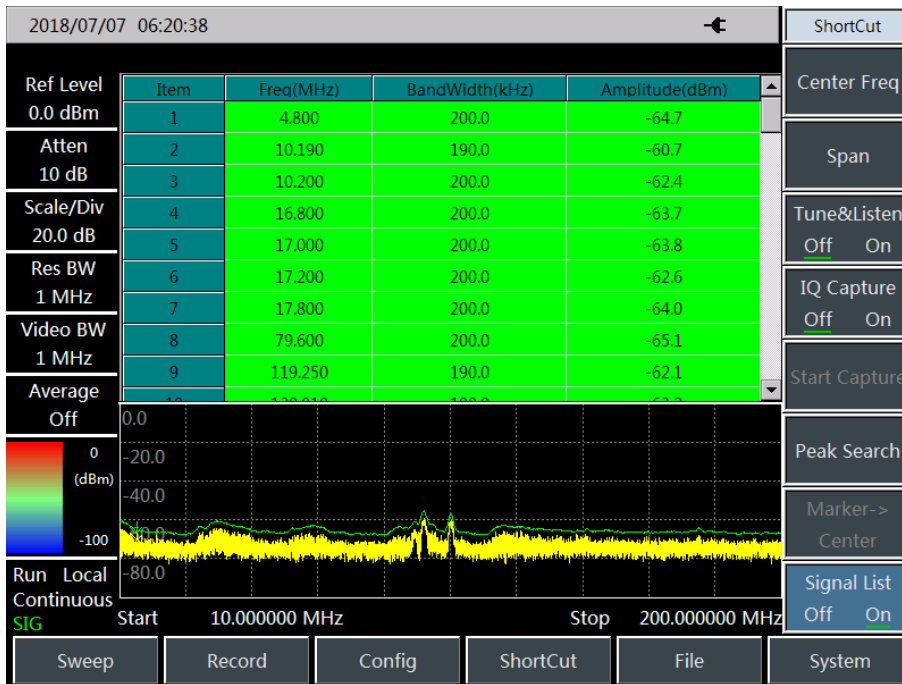

Fig. 10-2 Interface of signal list

IQ Capture function can directly save IQ data of interference signal and its interface is as shown in Fig. 10-3:

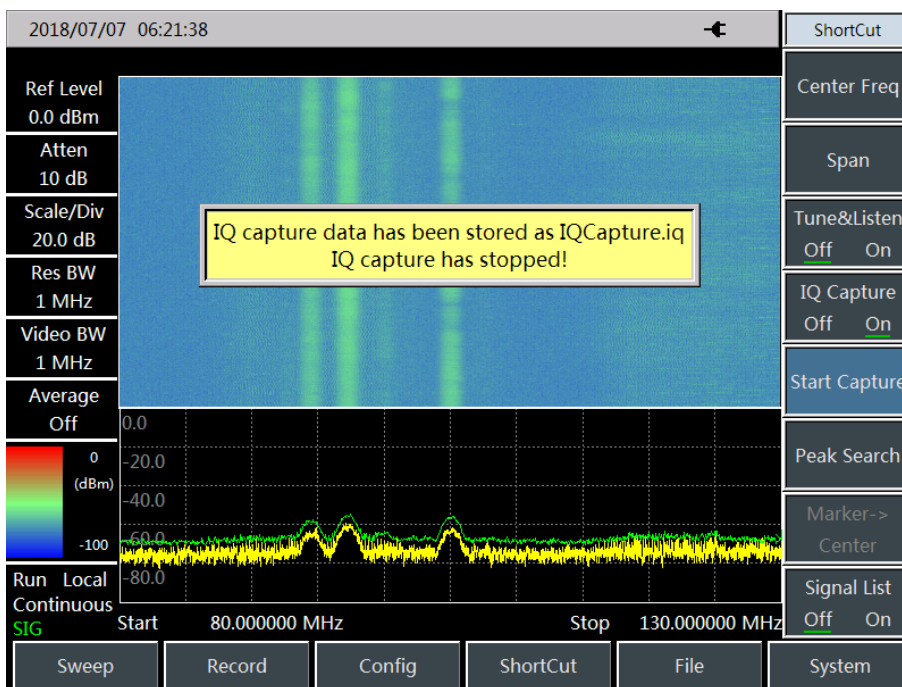

Fig. 10-3 Schematic diagram of IQ Capture function

Under the signal analysis mode, the current test task can be saved quickly as an automatically generated file as per current intermediate frequency and test time.

The storage task of signal analysis is as shown in Fig. 10-4:

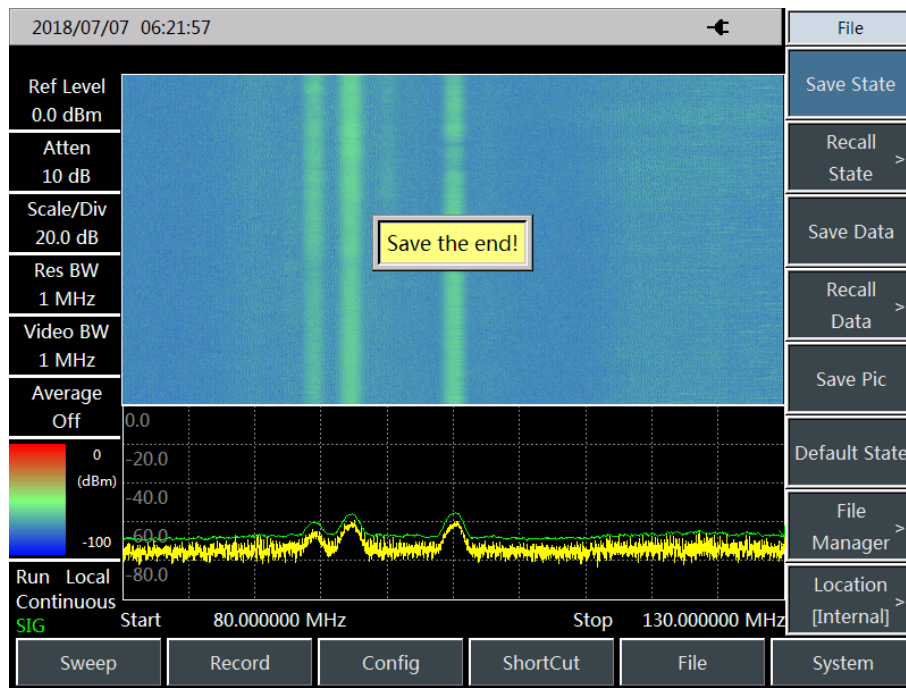

Fig. 10-4 Schematic diagram of signal analysis storage task

Section 2 Structure of signal analysis menu

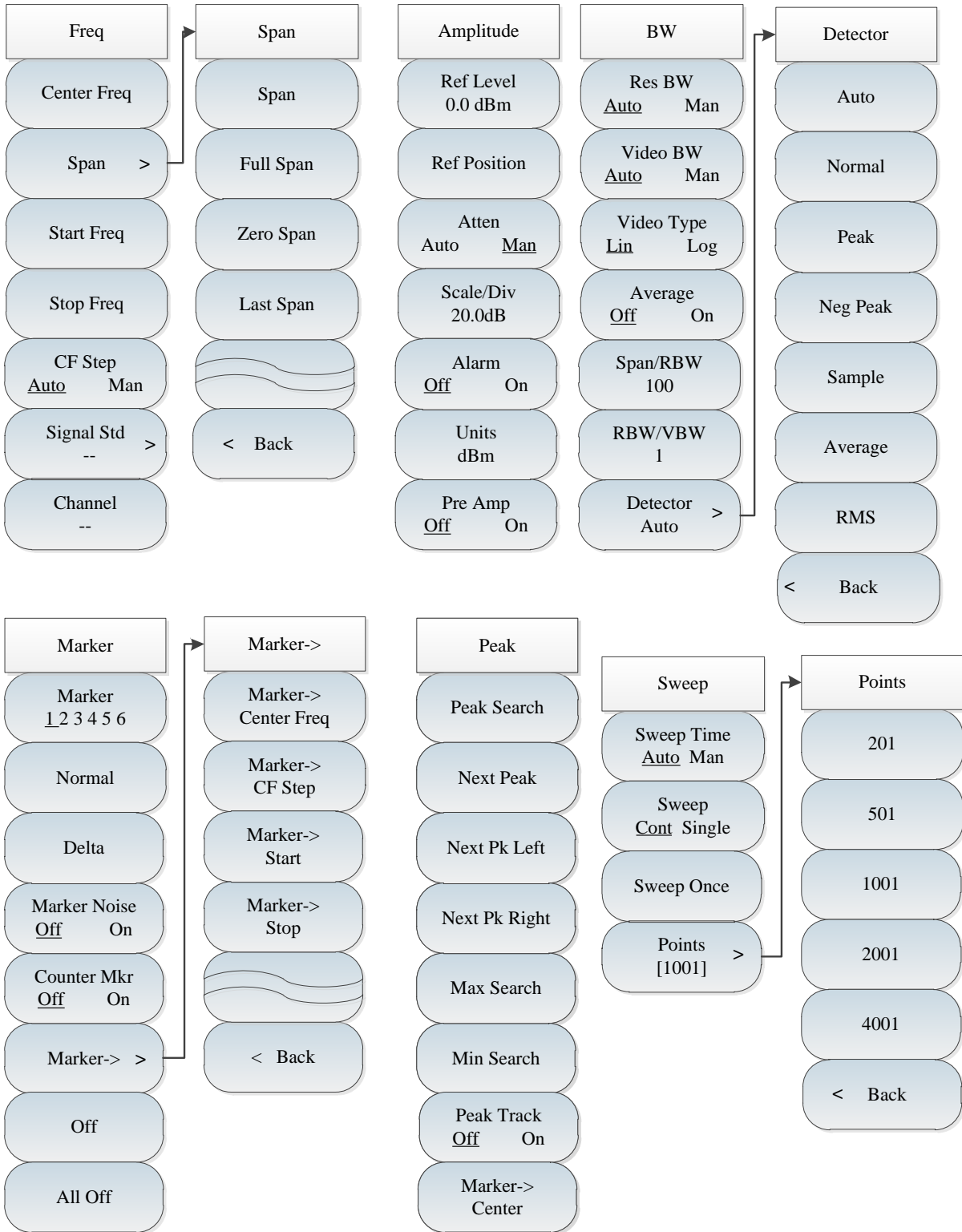

Fig. 10-5 Block diagram of signal analysis menu

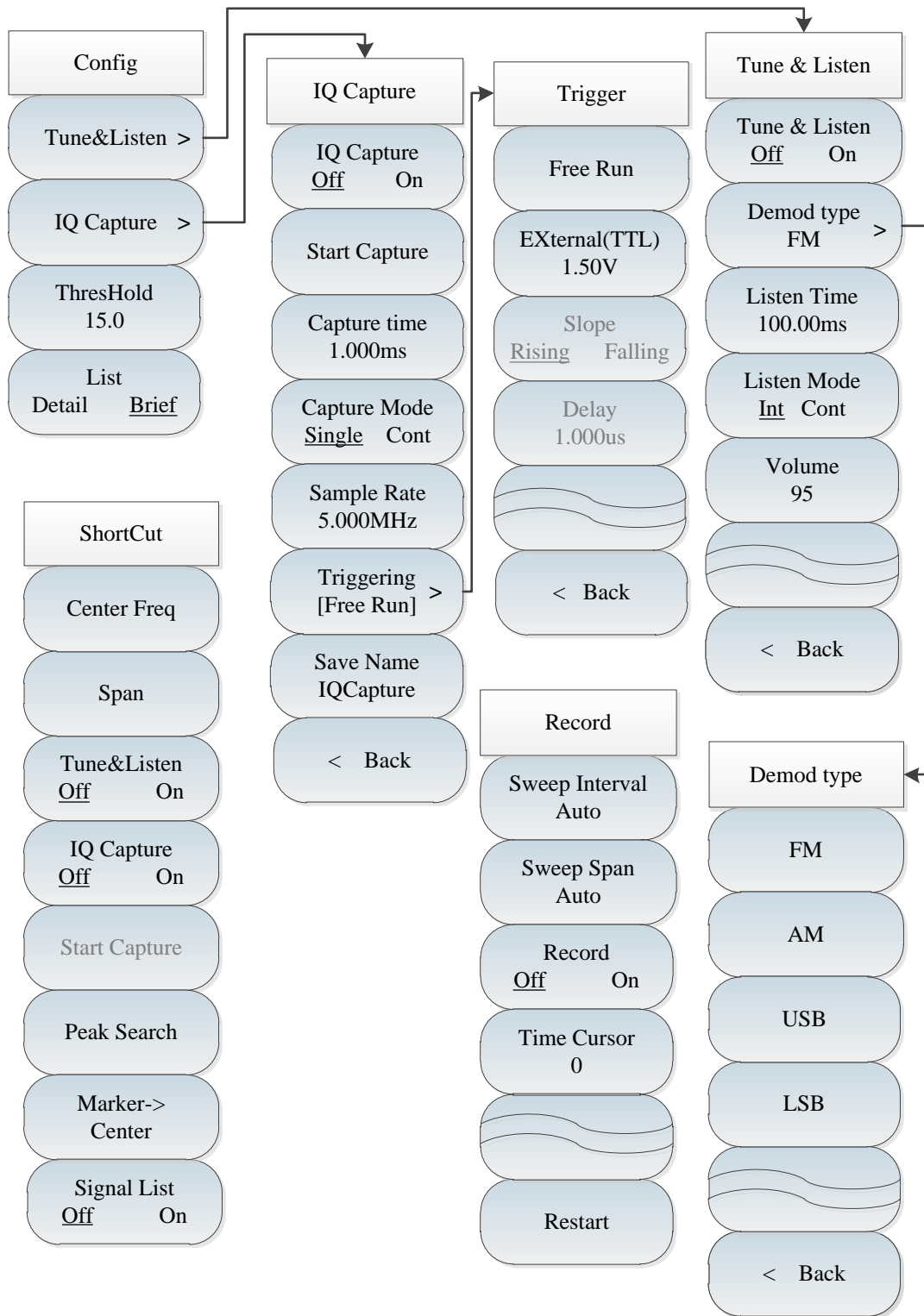

Fig. 10-6 Block diagram of signal analysis menu (continued)

Section 3 Description of signal analysis menu

10.3.1 Frequency menu

Freq	<p>{Center Freq}: press 【Freq】 → [Center Freq], to select [GHz], [MHz], [kHz] or [Hz] by number key on front panel or 【↑】 or 【↓】 key and spinning wheel in frequency menu.</p> <p>{Special Notice}: in case of using 【↑】 or 【↓】 key and spinning wheel, the frequency step is same with the set value of [Step Freq]. After pressing [Step Freq <u>A</u>uto <u>M</u>an] to switch to [Step Freq Auto <u>M</u>an], it is allowed to use the number key or 【↑】 or 【↓】 key and spinning wheel to set the step frequency.</p>
Center Freq	
Span >	<p>{Span}: press 【Freq】 → [Span], to activate the span sub-menu by using number key, frequency unit or 【↑】 or 【↓】 key and spinning wheel. For details, please refer to the description of [Span].</p> <p>{Special Notice}: use 【↑】 or 【↓】 key and spinning wheel to change span as per the step size of 1-2-5.</p>
Start Freq	<p>{Start Freq}: press 【Freq】 → [Start Freq], to use the number key on front panel, frequency unit or 【↑】 or 【↓】 key and spinning wheel to set the Start Freq.</p>
Stop Freq	<p>{Stop Freq}: press 【Freq】 → [Stop Freq], to use the number key on front panel, frequency unit or 【↑】 or 【↓】 key and spinning wheel to set the Stop Freq.</p>
CF Step Auto Man	<p>{Signal Std}: press 【Freq】 → [Signal Std], to select a signal standard by using 【↑】 or 【↓】 key and spinning wheel and call it by [Done] menu or [Enter] key. For details, please refer to the dialog box menu.</p> <p>{Special Notice}: after the signal standard is loaded, the center frequency and span will be set as defined in signal standard.</p>
Signal Std > --	<p>{Channel}: press 【Freq】 → [Channel], to pop up the channel number dialog box and set the channel number by using number key or 【↑】 or 【↓】 key and spinning wheel.</p> <p>{Special Notice}: the channel number shall be set after the signal standard has been loaded. Otherwise the message of failure to set will be given.</p>
Channel --	

10.3.2 Span menu

Span	<p>{Span}: press 【Freq】 → [Span], to activate the span sub-menu by using number key, frequency unit or 【↑】 or 【↓】 key and spinning wheel. For details, please refer to the description of [Span].</p> <p>{Special Notice}: use 【↑】 or 【↓】 key and spinning wheel to change span as per the step size of 1-2-5.</p>
Span	
Full Span	<p>{Full Span}: press 【Freq】 → [Span] → [Full Span], to set the current span as 44.1GHz.</p>
Zero Span	<p>{Zero Span}: press 【Freq】 → [Span] → [Zero Span], to set the current span as 0Hz.</p>
Last Span	<p>{Last Span}: press 【Freq】 → [Span] → [Zero Span], to recover the span to last value.</p>
< Back	<p>{Back}: press 【Freq】 → [Span] → [Back], to return to [Freq] sub-menu.</p>

10.3.3 Amplitude menu

Amplitude	<p>{Ref Level}: press 【Ampt】 → [Ref Level], to set the ref level by using the number key on front panel, [dBm], [-dBm], [mV] or [uV] or 【↑】 or 【↓】 key and spinning wheel.</p> <p>{Special Notice}: in case of using 【↑】 or 【↓】 key and spinning wheel, the step is 10dB.</p>
Ref Level 0.0 dBm	
Ref Position	<p>{Ref Position}: press 【Ampt】 → [Ref Position], to change the ref position by using the number key or 【↑】 or 【↓】 and spinning wheel.</p>
Atten Auto <u>Man</u>	<p>{Atten <u>Auto</u> Man}: press 【Ampt】 → [Atten <u>Auto</u> Man], to use the menu to activate the automatic or manual mode of attenuator by number key or 【↑】 or 【↓】 key and spinning wheel.</p> <p>{Special Notice}: the setting range of attenuator is 0dB - 50dB with step size of 10dB.</p>
Scale/Div 20.0dB	<p>{Scale/Div}: press 【Ampt】 → [Scale/Div], to set the scale/div as 0.1dB ~ 20dB by number key or 【↑】 or 【↓】 key and spinning wheel.</p>
Alarm <u>Off</u> On	<p>{Units}: the amplitude unit shall be taken as dBm.</p>
Units dBm	
Pre Amp <u>Off</u> On	<p>{Pre Amp <u>Off</u> On}: press 【Ampt】 → [Pre Amp <u>Off</u> On], to activate or deactivate the preamplifier.</p>

10.3.4 Bandwidth menu

BW	<p>{Res BW <u>A</u>uto Man}: press 【BW】 →[Res BW <u>A</u>uto Man], to set the RBW by using the number key on front panel or 【↑】 or 【↓】 key and spinning wheel.</p>
Res BW <u>A</u> uto Man	<p>{Special Notice}: the RBW depends on the bandwidth of intermediate frequency filter while the shape of trace depends on the intermediate frequency bandwidth filter. This apparatus can change the RBW within 1Hz~10MHz and at the step size of 1-3-10.</p>
Video BW <u>A</u> uto Man	<p>{Video BW <u>A</u>uto Man}: press 【BW】 →[Video BW <u>A</u>uto Man], to change the video bandwidth by using the number key or 【↑】 or 【↓】 key and spinning wheel.</p>
Video Type <u>L</u> in Log	<p>{Special Notice}: the video bandwidth filter is used to smooth trace so as to improve the ability of detecting weak signal in noise signal. This apparatus can change the RBW within 1Hz~10MHz and at the step size of 1-3-10.</p>
Average <u>O</u> ff On	<p>{Video type <u>L</u>in Log}: press 【BW】 →[Video type <u>L</u>in Log], to set the data processing of video bandwidth filter.</p>
Span/RBW 100	<p>{Average <u>O</u>ff On}: press 【BW】 →[Average <u>O</u>ff On], to smoothen the trace by using the number key or 【↑】 or 【↓】 key and spinning wheel when the video bandwidth filter is not changed.</p>
RBW/VBW 1	<p>{SPAN/RBW}: press 【BW】 →[SPAN/RBW], to set the ratio between span and RBW by using the number key or 【↑】 or 【↓】 key and spinning wheel. Under the automatic mode, the RBW will vary with span.</p>
Detector Auto >	<p>{RBW/VBW}: press 【BW】 →[RBW/VBW], to set the ratio between RBW and VBW by using the number key or 【↑】 or 【↓】 key and spinning wheel. Under the automatic mode, the video bandwidth will vary with RBW.</p> <p>{Detection}: press 【BW】 →[Detector], to open the detection sub-menu. For details, please refer to [Detector] menu.</p>

Detector	{Auto} : press 【BW】 → [Detector] → [Auto]. The detection is same with spectral analysis mode.
Auto	{Normal} : press 【BW】 → [Detector] → [Normal]. This is a most common detection mode, through which the signal and noise floor can be displayed without signal loss.
Normal	{Peak} : press 【BW】 → [Detector] → [Peak], to ensure no loss of any peak signal. This is used to measure the signal which is very close to the noise floor.
Peak	{Neg Peak} : press 【BW】 → [Detector] → [Neg Peak], to reproduce the modulation envelope. This is used in self-inspection of integrated bandwidth millimeter wave tester in most circumstances but it is rarely used in test.
Neg Peak	{Sample} : press 【BW】 → [Detector] → [Sample]. This is helpful to measure the noise signal. Compared with standard detection, it can measure the noise in a better way.
Sample	{Average} : press 【BW】 → [Detector] → [Average], to conduct the average processing of data within sampling interval.
Average	{RMS} : press 【BW】 → [Detector] → [RMS], to conduct the RMS processing of data within sampling interval.
RMS	
< Back	

10.3.5 Marker menu

Marker	{Marker <u>1</u> 2 3 4 5 6} : press 【Marker】 → [Marker <u>1</u> 2 3 4 5 6], to activate the different marker display. The selected marker will be underlined.
Marker <u>1</u> 2 3 4 5 6	{Normal} : press 【Marker】 → [Normal], to set the current marker display mode as normal.
Normal	{Delta} : press 【Marker】 → [Delta], to set the current marker display mode as delta. The delta shows the frequency difference and amplitude difference between difference marker and reference marker (or time difference under zero span). If amplitude, the show value is expressed in dB.
Delta	{Marker Noise <u>Off</u> On} : press 【Marker】 → [Marker Noise <u>Off</u> On], to show the noise power which is used to normalize the noise adjacent to the activated marker to 1Hz bandwidth. At this time, the detector is set as sampling detection mode. After the marker noise is activated, the unit of marker reading is automatically switched to dBm/Hz.
Marker Noise <u>Off</u> On	{Marker->} : press 【Marker】 → [Marker->], to open the marker function sub-menu. This function enables that user can use the marker to change the apparatus display. For details, please refer to [Marker->] function menu.
Counter Mkr <u>Off</u> On	{Marker Off} : press 【Marker】 → [Marker Off], to deactivate the current marker.
Marker-> >	{All Off} : press 【Marker】 → [All off], to deactivate all activated markers.
Off	
All Off	

Marker->	{Marker->Center Freq} : press 【Marker】 → [Marker->] → [Marker->Center Freq], to move the marker to the center frequency place and display the reading of center frequency on screen.
Marker-> Center Freq	{Marker->Step Freq} : press 【Marker】 → [Marker->] → [Marker->Step Freq], to set the step size of center frequency, namely, the frequency step is equal to marker frequency. When the difference marker function is activated, the frequency step is equal to the frequency of difference marker.
Marker-> CF Step	{Marker->Start Freq} : press 【Marker】 → [Marker->] → [Marker->Start Freq], to set the start frequency as marker frequency.
Marker-> Start	{Marker->Stop Freq} : press 【Marker】 → [Marker->] → [Marker->Stop Freq], to set the stop frequency as marker frequency.
Marker-> Stop	{Return} : return to the previous menu.
< Back	

10.3.6 Peak menu

Peak	{Peak Search} : press 【Peak】 → [Peak Search], to set the current marker at the maximum peak point of measuring trace and indicate the frequency and amplitude of the marker.
Peak Search	{Next Peak} : press 【Peak】 → [Next Peak], to move the marker to next peak point on trace which is linked with current marker.
Next Peak	{Next Pk Left} : press 【Peak】 → [Next Pk Left], to search the next peak on the left of current marker position.
Next Pk Left	{Next Pk Right} : press 【Peak】 → [Next Pk Right], to search the next peak on the right of current marker position.
Next Pk Right	{Max Search} : this is used to place a marker at the highest point of trace and display the frequency and amplitude of the marker in the top right corner of screen. When this key is pressed, the activated function will not change.
Max Search	{Min Search} : this is used to place a marker at the lowest point of trace and display the frequency and amplitude of the marker in the top right corner of screen. When this key is pressed, the activated function will not change.
Min Search	{Marker->Center} : press 【Peak】 → [Marker->Center], to set the center frequency as marker frequency. This function can quickly move the signal to the center of screen.
Peak Track Off On	
Marker-> Center	

10.3.7 Sweep menu

Sweep	<p>{Sweep Time <u>Auto Man</u>}: press 【Sweep】 →{Sweep Time <u>Auto Man</u>}, to switch the sweep time between automatic and manual modes. The current state will be underlined. When the sweep time is automatic, the integrated tester will automatically set the fastest sweep time as per the current apparatus state and the fastest sweep time will be displayed on screen. When the sweep time is manual, it is allowed to enter the sweep time by using number key and select the time unit to complete setting by using relevant soft key. In case of automatic sweep time, the scan frequency speed will vary with RBW and VBW. The bigger RBW and VBW are, the quicker the scan speed is; the less RBW and VBW are, the slower the scan speed is. When the minimum sweep time limit is met, the sweep time of AV4024 series spectrum analyzer can set up to 800s for non-zero span and 600s for zero span.</p>
Sweep Time <u>Auto Man</u>	<p>{Sweep Type <u>Cont Single</u>}: press 【Sweep】 →{Sweep Type <u>Cont Single</u>}, to select the sweeping mode. The setting of sweep type can decide the scanning direction of an integrated tester and the time when it can stop scanning and enter the hold mode. Under the interference analysis mode, there are two sweeping modes, continuous sweeping and single sweeping.</p>
Sweep <u>Cont Single</u>	<p>{Sweep Once}: press 【Sweep】 →{Sweep Once}, to start single again.</p>
Sweep Once	<p>{Points}: press 【Sweep】 →{Points}, to select the scan points as [201], [501], [1001], [2001] and [4001].</p>
Points [1001] >	



10.3.8 Record menu

Record	<p>{Swp Interval}: press 【Record】 →{Swp Interval Auto}, to set the scan interval. After the sweep time is set, the trace will switch to the maximum hold mode by default to ensure that all measured signals within scan interval can be recorded.</p>
Sweep Interval Auto	<p>{Sweep Span}: press 【Record】 →{Sweep Span Auto}. The span time means the whole sweep time. When the span time is reached, the record will stop.</p>
Sweep Span Auto	<p>{Record <u>Off On</u>}: press 【Record】 →{Record <u>Off On</u>}, to switch the auto save switch by menu.</p>
Record <u>Off On</u>	<p>{Special Notice}: the auto save function can be activated after the span time is set.</p>
Time Cursor 0	<p>{Time Cursor}: press 【Record】 →{Time Cursor}, to view the historical data.</p>
Time Cursor 0	<p>{Special Notice}: it can be used only under the waterfall chart measurement mode.</p>
Time Cursor 0	<p>{Restart}: press 【Record】 →{Restart}, to restart the scanning.</p>
Restart	

10.3.9 Configuration menu

Config	{Tune&Listen} : press 【Config】 →[Tune&Listen], to activate the Tune Listen function. For details, please refer to the description of [Tune Listen] menu.
Tune&Listen >	{IQ Capture} : press 【Config】 →[IQ Capture], to activate IQ Capture function. For details, please refer to the description of [IQ Capture] menu.
IQ Capture >	{Threshold 15.0} : press 【Config】 →[Threshold 15.0], to set the threshold value by using number key, spinning wheel or up or down key.
ThresHold 15.0	{List Detail <u>Brief</u>} : press 【Config】 →[List Detail <u>Brief</u>], to select the signal list display mode by menu. Under the brief mode, display the frequency, bandwidth and amplitude of capturing the interference signal; under the detail mode, display the capture time and capture frequency of signal.
List Detail <u>Brief</u>	

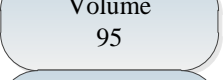
10.3.10 Tune Listen menu

Tune & Listen	{Tune&Listen <u>Off</u> On} : press 【Config】 →[Tune&Listen]→[Tune&Listen <u>Off</u> On], to activate or deactivate the Tune Listen function.
Tune & Listen <u>Off</u> On	{Demod type} : press 【Config】 →[Tune&Listen]→[Demod type], to set the demodulation type. It is allowed to select [FM], [AM], [USB] or [LSB].
Demod type FM	{Listen Time} : press 【Config】 →[Tune&Listen]→[Listen Time], to set the listen time.
Listen Time 100.00ms	{Listen Mode} : press 【Config】 →[Tune&Listen]→[Listen Mode], to set the listen mode. the default state is intermittent listen mode, under which the data will be first scanned for one screen and then be demodulated as per listen time and such cycle will recirculate; the continuous mode is to scan the data for one screen and then demodulate continuously till that the data is not scanned.
Listen Mode <u>Int</u> Cont	{Volume} : press 【Config】 →[Tune&Listen]→[Volume], to set the sound volume of loudspeaker under listen mode.
Volume 95	
	
	
< Back	

10.3.11 IQ Capture menu

IQ Capture	{IQ Capture <u>Off</u> On} : press 【Config】 →[IQ Capture]→[IQ Capture <u>Off</u> On], to activate or deactivate IQ Capture function.
IQ Capture <u>Off</u> On	{Start Capture} : press 【Config】 →[IQ Capture]→[Start Capture], to start IQ data capture and record function.
Start Capture	{Capture Time} : press 【Config】 →[IQ Capture]→[Capture Time], to set IQ Capture Time. It should be noted that IQ Capture Time cannot exceed sweep time.
Capture time 1.000ms	{Capture Type} : press 【Config】 →[IQ Capture]→[Capture Type], to set IQ Capture type as single or continuous.
Capture Mode <u>Single</u> Cont	{Sample Rate} : press 【Config】 →[IQ Capture]→[Sample Rate], to pop up the dialog box of sample rate and set the sample rate of IQ Capture as 12.5MHz, 5MHz, 1.25MHz, 500kHz, 125kHz or 50kHz.
Sample Rate 5.000MHz	{Triggering} : press 【Config】 →[IQ Capture]→[Triggering], to select [Free Run] or [External]. In case of external trigger, it is allowed to set [Slope] or [Delay].
Triggering [Free Run] >	{Save Name} : press 【Config】 →[IQ Capture]→[Save Name], to set the name of IQ Capture file.
Save Name IQCapture	
< Back	

10.3.12 ShortCut menu

ShortCut	
Center Freq	{Center Freq} : press 【ShortCut】 → [Center Freq], press 【Freq】 → [Center Freq], to set the center frequency by using the number key on front panel, [GHz], [MHz], [kHz] or [Hz] or 【↑】 or 【↓】 key and spinning wheel in frequency unit menu.
Span	{Span} : press 【ShortCut】 → [Span], press 【Freq】 → [Span], to activate the span sub-menu by using number key, frequency unit or 【↑】 or 【↓】 key and spinning wheel.
Tune&Listen Off On	{Tune Listen Off On} : press 【ShortCut】 → [Tune&Listen Off On], to activate or deactivate the tune listen function.
IQ Capture Off On	{IQ Capture Off On} : press 【ShortCut】 → [IQ Capture Off On], to activate or deactivate IQ Capture function.
Start Capture	{Start Capture} : press 【ShortCut】 → [Start Capture], to start IQ Capture.
Peak Search	{Peak Search} : press 【ShortCut】 → [Peak Search], to set the current marker at the maximum peak point of measuring trace and indicate the frequency and amplitude of the marker.
Marker-> Center	{Marker→Center Freq} : press 【ShortCut】 → [Marker→Center Freq], to set the center frequency as marker frequency. This function can quickly move the signal to the center of screen.
Signal List Off On	{List Off On} : press 【ShortCut】 → [List Off On], to open or close the signal list.

10.3.13 File menu

Please refer to the file menu description under spectral analysis mode.

Article II Technical Instructions



Chapter XI Operating Principle

4024 series spectrum analyzers have four operating bands: 9kHz-20GHz, 9kHz-26.5GHz, 9kHz-32GHz and 9kHz-44GHz, and various measurement functions such as spectrum measurement analysis, field strength measurement, occupied bandwidth measurement, channel power measurement, adjacent channel power measurement, tune listening and IQ capture. With options for interference analysis, AM-FM-PM signal demodulation analysis and USB power measurement, the RF signal parameters such as the frequency and amplitude can be measured. The functional block diagram of 4024 series spectrum analyzer is shown in Fig. 11-1.

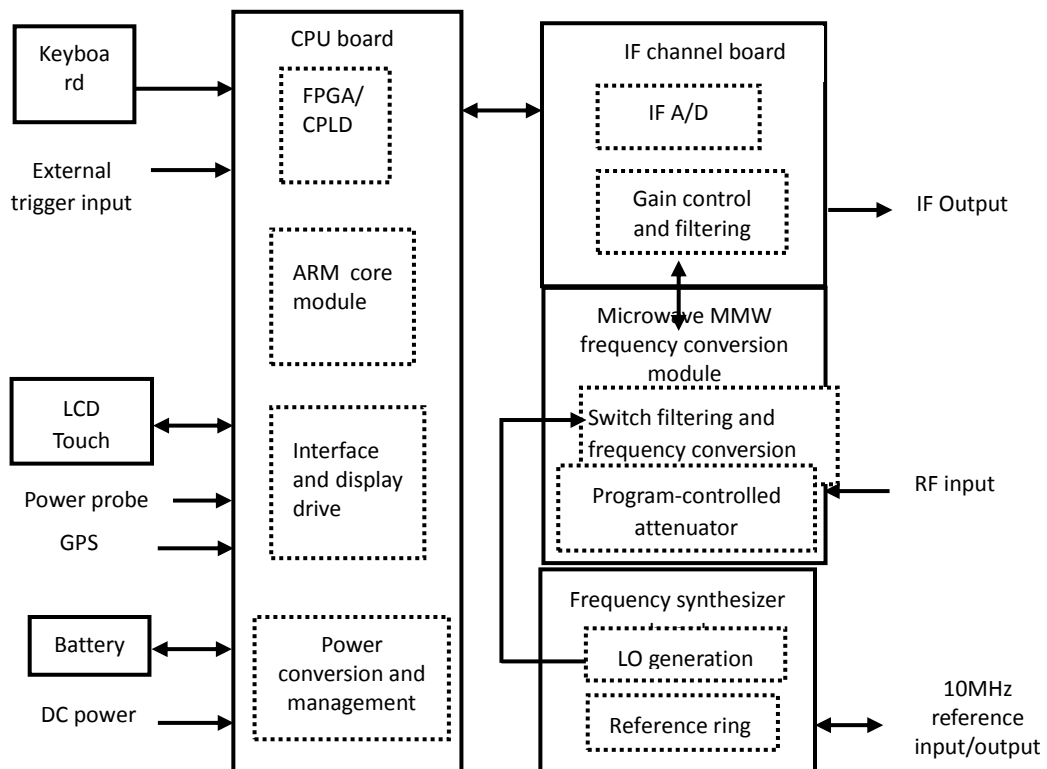

Fig. 11-1 Overall Functional Block Diagram

System hardware can be divided into the microwave MMW frequency conversion module, frequency synthesizer board, IF channel board, CPU board, display, keyboard, battery, etc.

The microwave MMW frequency conversion module includes two parts: 60dB program-controlled step attenuator and switch filtering and frequency conversion part. The attenuation value of the program-controlled step attenuator is automatically associated according to the reference level or manually set by the user to provide the appropriate mixer level. The switch filtering and frequency conversion part is used for band filtering and frequency conversion of RF input signals and output of IF signals to the IF channel board.

The IF channel board is used for filtering IF signal input of the frequency conversion module. Gain control is implemented based on bands so as to adjust the amplitude of AD sample signals and finally output differential digital signals to FPGA after AD conversion, so as to achieve the functions of digital

down-conversion, IF filtering, video filtering, etc.

The CPU board includes the power conversion and management circuit, interface and display circuit, FPGA/CPLD control and digital signal processing circuit and ARM core module, and is used for DC/DC conversion and operation management of the power supply of the whole instrument, digital signal processing, logic circuit control, etc. Finally, digital signals in the sweep curve, spectrogram and other forms, as test results are transmitted to the LCD display.

The frequency synthesizer board has the function of providing 10MHz reference input/output for the outside, with the internal reference ring output signal as the LO frequency reference, and also providing high-stability clock signals for AD sampling and FPGA. The LO generation circuit is used for providing LO signals for the mixer in the microwave MMW frequency conversion module, and related to the hardware sweeping speed, phase noise, sideband emission and other specifications of the whole instrument.

Chapter XII Performance Characteristic Test

Sufficient test equipment and inspection facilities of appropriate accuracy and quality should be provided according to the requirements of GB/T 6592-1996, and be calibrated by the measurement department and within the validity of measurement. You may also use other instruments meeting the test requirements of this standard. Refer to the table below for test instruments.

Table 12-1 Recommended Instruments for 4024 Series Spectrum Analyzer

S/N	Instrument name	Main technical indexes	Recommended cable
1	Synthesized signal generator	Frequency range: 250kHz to 50GHz Power output: -100dBm to +15dBm Frequency accuracy: $\pm 0.02\%$ Power level capable of being calibrated and saved With the functions of internal and external AM and low-frequency output.	1464C Or E8257D
2	Spectrum analyzer	Frequency range: 3Hz to 26.5GHz, DANL: <-100dBm	4051E or E4440A
3	Function generator	Waveform: Sine, triangle, square, etc. Frequency range: 1 μ Hz-80MHz Amplitude range: 1mV to 10V	Agilent 33250A
4	Power meter	Power range: -70dBm to +20dBm Calibrator frequency: 50MHz Calibrator amplitude: 0dBm	Anritsu ML2437A
5	Power probe	Frequency range: 10MHz~50GHz Power range: -70dBm to +20dBm	Anritsu MA2445D
6	Vector Network Analyzer	Frequency range: 50MHz to 50GHz	N5247A or 36587A
7	Power divider	Frequency range: 50kHz to 50GHz Insertion loss: <8dB	81313 or 11667C
8	RF directional coupler	Frequency range: 300kHz to 4GHz; orientation: 35dB VSWR: <1.45	70607
9	Directional coupler	Frequency range: 2GHz to 50GHz; coupling: 16dB Orientation: 14dB; flatness: 0.75dB VSWR: <1.45; insertion loss: <1.3dB	70603
10	Low-pass filter	Cutoff frequency: 1.0GHz; insertion loss: <0.9dB; out-of-band suppression: >65dB	SLP-1200
11	Low-pass filter	Cutoff frequency: 6.8GHz; insertion loss: <2dB; out-of-band suppression: >50dB	81613
12	Low-pass filter	Cutoff frequency: 18GHz; insertion loss: <2dB; out-of-band suppression: >40dB	FLP-1800
13	Low-pass filter	Cutoff frequency: 26.5GHz; insertion loss: <2dB; out-of-band suppression: >40dB	FLP-2650
14	50 Ω adapter	Impedance: 50 Ω	70508

Table 12-2(continued) Recommended Instruments for 4024 Series Spectrum Analyzer

S/N	Instrument name	Main technical indexes	Recommended cable
15	Adapter	2.4mm(f)-2.4mm(f)	711120
16	Adapter	3.5mm(m)-3.5mm(m)	71119
17	Adapter	2.4mm(f)-3.5mm(f)	71125
18	Adapter	2.4mm(m)-3.5mm(m)	71122
18	Adapter	3.5mm(f)-3.5mm(f)	
19	Adapter	BNC(f)-SMA(m)	BNC/SMA-JK
20	Adapter	BNC(m)-BNC(f)-BNC(m)	BNC-KJK
21	Cable	BNC(m)-BNC(m), two	Self-produced
22	Low-loss cable	2.4mm cable (m-m), two	11PA-11PA-PT H147-1500-J
23	Computer	Win XP or Win7 platform	
24	Leakage current withstand voltage tester	Leakage current: 0.5 mA ~ 20 mA; voltage: 242 V, 3 kV, 5 kV	CJ2673
25	Variable-frequency power supply	Frequency: 47 Hz ~ 400 Hz; voltage: 0 ~ 3,000 V	AFC-1kW
26	High/low-temperature alternating temperature & humidity chamber	Temperature: -70°C to +150°C; humidity: 25-98%RH	ESL-10P
27	High/low-temperature temperature & humidity exchange box	Temperature: -70°C to +80°C; humidity: 50-98%RH	Y751C
28	Impact test bench	Maximum load: 100kg; acceleration: (50-400) m/s ²	P-100
29	Electrodynamics vibration generator	Maximum load: 500kg; maximum displacement: 51mm(p-p) Rated thrust: 31.36kN; frequency range: 5-2500Hz	DC-3200-36
30	Leakage current withstand voltage tester	Leakage current: 0.5 mA ~ 20 mA; voltage: 242 V, 3 kV, 5 kV	CJ2673
31	Digital display megger	FLUKE1508	FLUKE1508

The tester of the same performance characteristics can be used as a substitute,

This section provides the recommended method for testing of main technical specifications of 4024 series spectrum analyzer, which can fully reflect the performance and status of this instrument. The following indicator test of the spectrum analyzer must not be performed until no error prompt appears after at least 2h storage in the stable operating environment and 15min warm-up.

Caution

Detailed operation procedures for each index test are prepared according to test instrument in the diagram. If other equivalent test instrument is adopted, refer to the instructions of the test instrument for operation procedures. Reset instrument in test procedures refers to manufacturer's reset mode. If the instrument is under reset state defined by user, change it into manufacturer's reset state and then reset, ensuring original state of the instrument is known.

1. Frequency range

Description: The frequency range of the spectrum analyzer is tested with one 9kHz signal and one signal with the frequency equal to the upper limit of the spectrum analyzer. The signals within the nominal frequency range of 4024 series spectrum analyzer are generated by the signal generator of high frequency stability and applied to test whether the frequency measurement capabilities of 4024 series comply with the requirements.

a) Test equipment

Synthesized signal generator..... 1464C

b) Adapters

Two 2.4mm(f)-2.4mm (f) adapters

One BNC(m)-3.5mm(f) adapter

One 2.4mm(f)-3.5mm(m) adapter

c) Cables

One BNC(m-m) cable

One 2.4mm(m-m) cable

d) Test steps

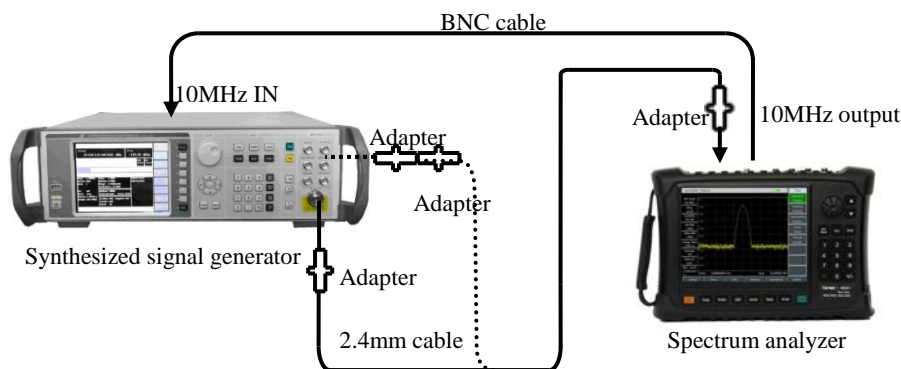

Fig. 12-1 Frequency Range Test

1) Connect the test equipment as shown by dotted lines in Fig. 12-1. Use 4024 series spectrum analyzer

(hereinafter referred to as the spectrum analyzer) to provide the reference frequency for the synthesized signal generator 1464C. Connect the low-frequency output port of the synthesized signal generator to the RF input end of the spectrum analyzer (as shown by the dotted line in Fig. 12-1).

2) Set the synthesized signal generator as follows. **【Freq】** [Set LF generator] **【Freq】** 9kHz, **【Ampt】** -10dBm, [Back], [LF Output Off **On**].

3) Set the center frequency of the spectrum analyzer as 9kHz, span as 1kHz, reference level as 0dBm, resolution bandwidth as 10Hz and other items into the AUTO mode. Press **【Peak】** on the spectrum analyzer. If the marker points at the maximum signal response, the marker amplitude is free from obvious jitter and the signal is clear, the corresponding center frequency is the lower limit of the frequency range. Compare this value and that of the corresponding test item in the Performance Test Schedule of Records of 4024 Series Spectrum Analyzer (hereinafter referred to as the Schedule of Records of 4024 Series Spectrum Analyzer). Mark “√” if the comparison result complies with requirements of the records; otherwise, mark “×”.

4) As shown by the solid lines in Fig. 12-1, connect the synthesized signal generator with the adapter and cable, and then connect the RF output end of 1464C to RF input end of the spectrum analyzer. Set the output frequency of the signal generator as the maximum frequency of the spectrum analyzer of the corresponding model, disable the modulation function, and set the output power as -10dBm.

5) Set the center frequency of the spectrum analyzer as the maximum frequency of the corresponding model, the span as 1kHz, reference level as 0dBm, resolution bandwidth as 10Hz and other items into the AUTO mode. Press **【Peak】** on the spectrum analyzer. If the marker points at the maximum signal response, the marker amplitude is free from obvious jitter and the signal is clear, the corresponding center frequency is the upper limit of the frequency range. Compare this value and that of the corresponding test item in the Performance Test Schedule of Records of 4024 Series Spectrum Analyzer (hereinafter referred to as the Schedule of Records of 4024 Series Spectrum Analyzer). Mark “√” if the comparison result complies with requirements of the records; otherwise, mark “×”.

2. Frequency readout accuracy

Description: The frequency accuracy represents the proximity of the frequency value measured by the spectrum analyzer to the corresponding true value. The frequency value measured by sweeping of the spectrum analyzer is affected by the reference frequency, sweep width, resolution bandwidth, etc. The frequency readout accuracy, representing the difference between the measured value to true value, is tested with an input signal of the known frequency. The smaller the difference is, the higher the accuracy is.

a) Test equipment

Synthesized signal generator 1464C

b) Adapters

Two 2.4mm(f)-2.4mm (f) adapters

c) Cables

One 2.4mm(m-m) cable

d) Test steps

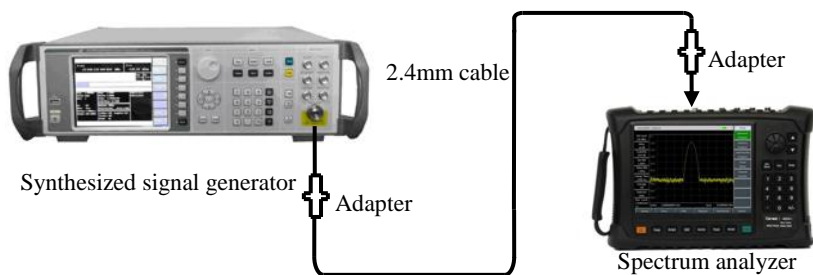

Fig. 12-2 Block Diagram of Test of Frequency Readout Accuracy

- 1) As shown in Fig. 12-2, connect the test instrument, and then connect the RF output end of the signal generator to RF input end of the spectrum analyzer.
- 2) Press **【Preset】** on the signal generator. According to the requirements in the “Frequency Readout Accuracy” column in the Schedule of Records of 4024 Series Spectrum Analyzer, set the output frequency of the signal generator as f_0 , power level as -10dBm, and enable the RF output.
- 3) Set the center frequency of the spectrum analyzer as f_0 , span as 500kHz, reference level as 0dBm and the resolution bandwidth and sweep time into the AUTO mode.
- 4) Press **【Peak】** on the spectrum analyzer, and read the signal peak frequency f_s with the marker.
- 5) Calculate the frequency readout error Δf by Formula (1):

$$\Delta f = f_s - f_0 \tag{1}$$

- 6) Record Δf as the test result into the corresponding test item of the Schedule of Records of 4024 Series Spectrum Analyzer.
- 7) Repeat Step 2 to 6 to all frequency and span combinations under the corresponding test items of the Schedule of Records of 4024 Series Spectrum Analyzer.

3. Sweep width accuracy

Description: Use two synthesized signal generators to provide two signals of known frequency as the input of the spectrum analyzer. Set the center frequency of the spectrum analyzer as the median of such two frequencies. Measure the frequency difference of such two signals by the marker function. Calculate and record the measured difference and the error percentage of the difference marker to span. The frequency reference of both signal generation should be the same as that of the spectrum analyzer.

Note: It is allowed to use only one signal generator for test. At first, set the center frequency and span of the spectrum analyzer. Set the frequency of the signal generators as that of the first signal generator. Set the differential marker on the spectrum analyzer and then set the frequency of the signal generator as that of the second signal generator. Read the differential marker of both signals on the spectrum analyzer, and record it as the measured value. The reference frequency of the signal generators should be the same as that of the spectrum analyzer.

a) Test equipment

Synthesized signal generator..... 1464C

b) Adapters

Two 2.4mm(f)-2.4mm (f) adapters

c) Cables

One BNC(m-m) cable

One 2.4mm(m-m) cable

d) Test steps

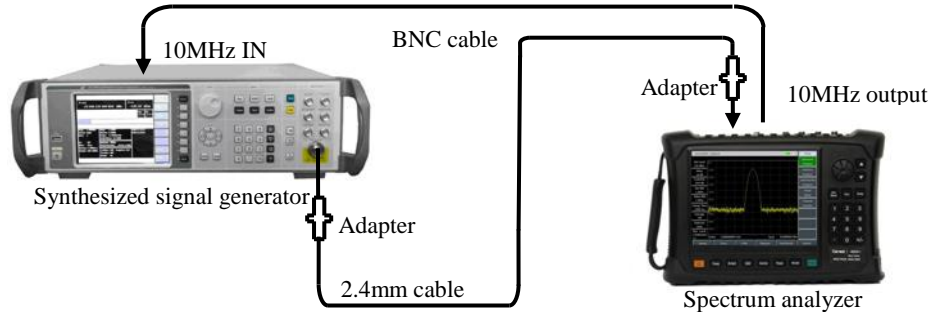

Fig. 12-3 Setting for Bandwidth Accuracy Test

1) Connect the test instrument as shown in Fig. 12-3. The spectrum analyzer will provide the frequency reference for the synthesized signal generator.

2) Set the center frequency f_0 of the spectrum analyzer as 22GHz (10GHz for 4024 D series, 13.25GHz for 4024 E series and 16GHz for 4024 F series) and the reference level as 0dBm. Set the span according to the requirements in the “Span Accuracy” column of the Schedule of Records of 4024 Series Spectrum Analyzer.

3) Set the output frequency of the signal generator as f_1 ($f_1 = f_0 - 0.4 \times \text{span}$, where the span is the set span of the spectrum analyzer), and the power as -10dBm. Enable the RF output.

4) Press **【Peak】**, **【Marker】** and **[Delta]** in sequence on the spectrum analyzer.

5) Set the output frequency of the signal generator as f_2 ($f_2 = f_0 + 0.4 \times \text{span}$) and the output power as -10dBm.

6) Press **【Peak】** on the spectrum analyzer, and set the differential marker as f_2 . After sweeping, read the frequency difference Δf of both signals.

7) Record the frequency difference Δf , and calculate the span accuracy by the following formula:

$$\text{Span accuracy} = 100 \times [\Delta f - (0.8 \times \text{span})] / (0.8 \times \text{span}) \% \quad (2)$$

Record the results corresponding to the test items in the Schedule of Records of 4024 Series Spectrum Analyzer.

8) Disable all markers. Respectively set the span of the spectrum analyzer and frequency of the signal generator according to the span of the spectrum analyzer in the table of records, and repeat Step 3-8 until all spans are tested.

4. Sweep time

Description: The AM signal will be displayed on the spectrum analyzer under zero span. Adjust the frequency of the modulation signal until the peak interval is uniformly distributed on the screen. Count the frequency of the modulation signal and calculate the actual sweep time. Compare the calculated value with the specified time to obtain the sweep time accuracy. The sweep time accuracy is guaranteed in the design.

In order to reduce the test time, the typical sweep time should be applied in testing and verification.

Note: The synthesized signal generator and function generator can be substituted by the synthesized signal generator with the built-in AM option.

a) Test equipment

Synthesized signal generator..... 1464C

Function generator Agilent Agilent 33250A

b) Adapters

Two 2.4mm(f)-2.4mm(f) adapters

c) Cables

Two BNC(m-m) cables

One 2.4mm(m-m) cable

d) Test steps

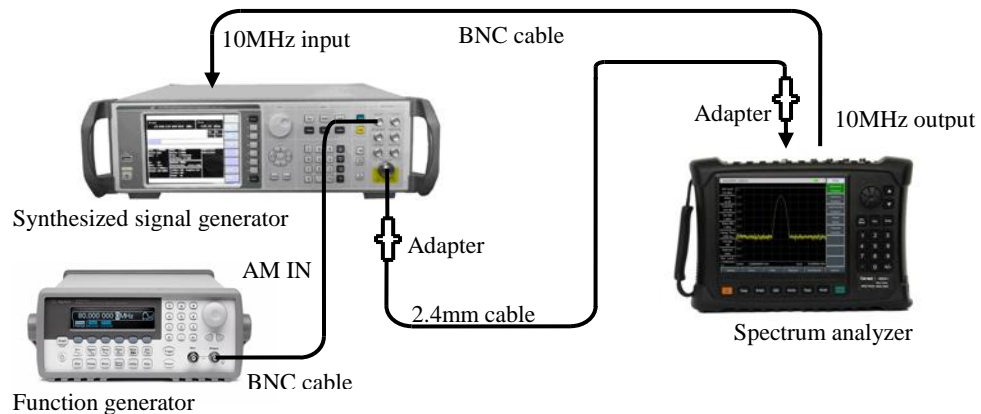

Fig. 12-4 Setting for Sweep Time Accuracy Test

1) Connect the test equipment as shown in Fig. 12-4. Connect the output of the function generator to the AM input end of the signal generator, and the RF output of the signal generator to the RF input port of the spectrum analyzer to be tested. The spectrum analyzer will provide the frequency reference for the synthesized signal generator.

2) Set the center frequency of the spectrum analyzer as 4GHz, span as 0Hz and resolution bandwidth and video bandwidth respectively as 10MHz. The sweep time can be set as min. 10 μ s and max. 600s. Mark “√” if such settings comply with the requirements of the “Sweep Time Range (zero span)” in the Schedule of Records of 4024 Series Spectrum Analyzer; otherwise, mark “×”.

3) Reset 1464C instrument, and finish the following settings: 4GHz frequency, -5dBm power, [Modulation] [AM] [Amplitude Input], [External], [Back], [AM On Off]. Enable AM and RF output.

4) Finish the following settings with soft keys on Agilent 33250A: **【Ampt】**, 1 [Vrms], [Offset] 0 [V], [Output]. Set the output waveform as [RAMP].

5) Set the scale type of the spectrum analyzer as “Linear”, detector mode as “Peak”, resolution bandwidth as 3MHz and video bandwidth as 3MHz.

6) Set **【Freq】** 10 [kHz] on Agilent 33250A. Set the spectrum analyzer: [Sweep time] 1[ms], [Sweep Type Cont Single].

7) Set the spectrum analyzer by pressing **【Peak】** and [Next Pk Left] or [Next Pk Right] to locate the marker at the first peak on the left. Press **【Marker】** [Delta]. Then press **【Peak】** and [Next Pk Left] or [Next Pk Right] to locate the marker on the ninth peak on the left. Read the differential marker and perform the following calculation:

$$\text{Sweep time error} = 100 \times ((\text{delta marker reading} \times 1.25 - \text{set sweep time}) / \text{set sweep time})\% \quad (3)$$

Record the calculation data corresponding to 1ms sweep time of the test items in the Schedule of Records of 4024 Series Spectrum Analyzer.

8) Disable the marker and repeat Step 6 to 7 corresponding to other sweep time values in the table. Set the modulation rate (frequency) in Step 6 according to the following formula:

$$\text{Modulation rate} = 10 / \text{set sweep time} \quad (4)$$

5. Resolution bandwidth

Description: The resolution bandwidth represents the ability of the spectrum analyzer to clearly separate two input signals. It is affected by the IF filter bandwidth, phase noise, sweep time, etc. Most of spectrum analyzer are equipped with the LC filter, crystal filter, SAW and digital filter to achieve various resolution bandwidths.

Connect the output of the synthesized signal generator to the RF input end of the spectrum analyzer. Set the bandwidth of 4024 series approximately as twice of the current resolution bandwidth (-3dB for conveniences in measurement). Reduce the output amplitude of the signal source by 3dB to achieve -3dB. Set the marker reference; increase the output of the signal source by 3dB to the previous level, and start sweeping. The marker difference is the measured value corresponding to 3dB bandwidth.

The reading of the 3dB bandwidth test function of 4024 series can be used as the test value. The span error of 4024 series may result in some errors of the resolution bandwidth accuracy. Compared with the resolution bandwidth error, the span error can be ignored.

a) Test equipment

Synthesized signal generator..... 1464C

b) Adapters

Two 2.4mm(f)-2.4mm(f) adapters

c) Cables

One BNC(m-m) cable

One 2.4mm(m-m) cable

d) Test steps

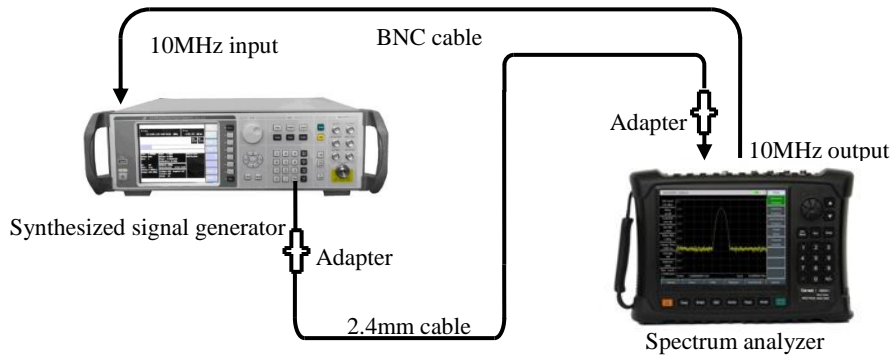

Fig. 12-5 Setting for Resolution Bandwidth Accuracy Test

- 1) Connect the test equipment as shown in Fig. 12-5. The spectrum analyzer will provide the frequency reference for the signal generator.
- 2) Set the synthesized signal generator as follows: frequency: 100MHz; power: -2dBm; power step: 1dB.
- 3) Reset the spectrum analyzer. Press **【Measure】** [OBW] to enable the occupied bandwidth measurement function. Select the dBc method and change X into -3.01dB.
- 4) Set the spectrum analyzer as follows: center frequency: 100MHz span: 30MHz; amplitude scale: 1dB/division; resolution bandwidth; 10MHz; other items: default.
- 5) Adjust the output power of the synthesized signal generator until the signal level is 2-3 divisions less than the reference level.
- 6) Make 4024 series instrument search the peak. Record the marker difference Δf_{-3dB} corresponding to 3dB bandwidth. Calculate the resolution bandwidth accuracy δ by the following formula, and record the calculation result under the corresponding test item in the Schedule of Records of 4024 Series Spectrum Analyzer.

$$\delta = \frac{\Delta f_{-3dB} - RBW}{RBW} \times 100\% \quad (5)$$

- 7) Set the spectrum analyzer according to the resolution bandwidth listed under the “Resolution Bandwidth Accuracy” item in the Schedule of Records of 4024 Series Spectrum Analyzer. Set the bandwidth approximately as twice of the resolution bandwidth, and repeat Step 6 to 7 until all resolution bandwidth values are tested.

6. Resolution bandwidth conversion uncertainty

Description: Connect the RF output of the synthesized signal generator to the input port of the spectrum analyzer, and adjust the output signal amplitude until the signal level is 2-3 divisions less than the reference level of the spectrum analyzer. Fix the amplitude of the synthesized signal generator and change the resolution bandwidth of the spectrum analyzer. The difference is the uncertainty of resolution bandwidth conversion. The resolution bandwidth step of 4024 series spectrum analyzer is 1-3.

a) Test equipment

Synthesized Signal generator 1464C

b) Adapters

Two 2.4mm(f)-2.4mm (f) adapters

c) Cables

One BNC(m-m) cable

One 2.4mm(m-m) cable

d) Test steps

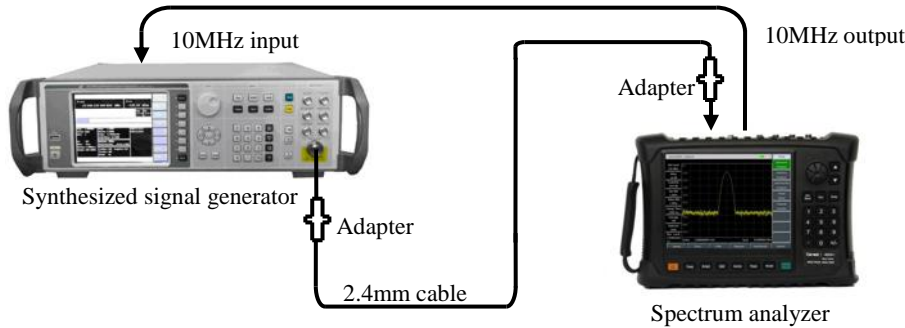

Fig. 12-6 Setting for Resolution Bandwidth Conversion Uncertainty

1) Connect the test equipment as shown in Fig. 12-6. The spectrum analyzer will provide the frequency reference for 1464C synthesized signal generator.

2) Finish spectrum analyzer settings as follows:

Center frequency	2000MHz
Span	10MHz
Logarithmic scale dB/division	1 dB
Automatic resolution bandwidth.....	Automatic
RBW/VBW	10
SPAN/RBW	100

3) In this case, the resolution bandwidth associated automatically with the spectrum analyzer will be 100kHz. Press **【Peak】** on the spectrum analyzer to set the marker at the peak. Enable the delta mode of the marker.

4) Set the span of the spectrum analyzer according to the resolution of the corresponding test item in the Schedule of Records of 4024 Series Spectrum Analyzer. Then set the ratio of the span to resolution bandwidth as 100.

5) Search the peak and read the amplitude difference of the differential marker. Record it as the conversion uncertainty of the current resolution bandwidth in the Schedule of Records of 4024 Series Spectrum Analyzer.

6) Repeat Step 4 and 5 until all resolution bandwidth values are tested.

7. Sideband noise

Description: The sideband noise is an indicator representing the short-time stability of the LO signal frequency of the spectrum analyzer.

Measure the sideband noise of the 1.0GHz and 0dBm reference signal under the carrier offset of 10kHz, 100kHz, 1MHz and 10MHz. Average the sideband noise of each frequency offset point by the noise marker and video averaging function. In the case of any spurious response at the set frequency offset, make the

marker deviated from the spurious response to ensure the accuracy of measurement.

a) Test equipment

Synthesized signal generator..... 1464C

b) Adapters

Two 2.4mm(f)-2.4mm(f) adapters

c) Cables

One BNC(m-m) cable

One 2.4mm(m-m) cable

d) Test steps

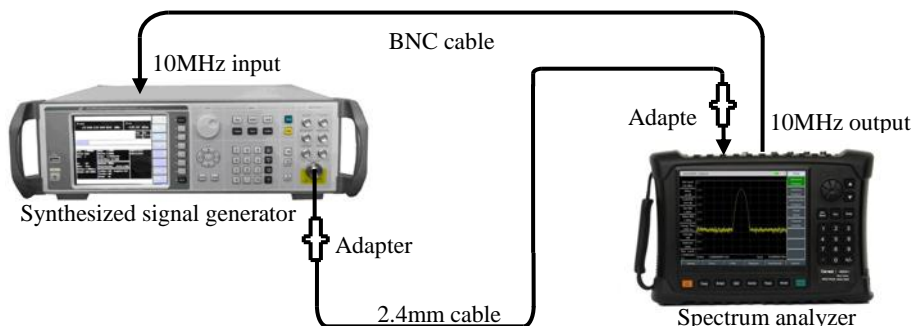

Fig. 12-7 Schematic Diagram of Sideband Noise Test

- 1) Connect the test instrument as shown in Fig. 12-7. The spectrum analyzer will provide the frequency reference for the synthesized signal generator.
- 2) Set the output frequency of the signal generator as 1GHz and output power as 0dBm.
- 3) Set **【Freq】** 1 [GHz], **【Span】** 30 [kHz], **【Ampt】** [Ref Level] 0 [dBm] on the spectrum analyzer.
- 4) Press **【Peak】** **【Marker】** [Delta] on the spectrum analyzer. Set the differential marker as 10kHz, and enable the noise marker function.
- 5) Set the resolution bandwidth and video bandwidth as shown in Table 12-3. Enable the averaging function, and perform averaging 10 times.
- 6) Record the amplitude of the differential marker as the sideband noise corresponding to the +10kHz offset under the related test item in the Schedule of Records of 4024 Series Spectrum Analyzer.
- 7) Press **【Marker】** -10[kHz] on the spectrum analyzer. Record the amplitude of the differential marker as the sideband noise corresponding to the -10kHz offset under the related test item in the Schedule of Records of 4024 Series Spectrum Analyzer.
- 8) Set the spectrum analyzer as shown in Table 12-3. Test the single-sideband noise corresponding to the ±100kHz, ±1MHz and ±10MHz offset. Record the amplitudes of the differential marker under the related test item in the Schedule of Records of 4024 Series Spectrum Analyzer. Any spurious response at the frequency offset should be avoided during marker reading in the test.

Table 12-3 Setting for Sideband Noise Measurement

Frequency offset Δf	Span	Resolution Bandwidth	VBW and Average
$\pm 10\text{kHz}$	30kHz	300Hz	VBW 30Hz Average <u>On</u>
$\pm 100\text{kHz}$	300kHz	3kHz	VBW 300Hz Average <u>On</u>
$\pm 1\text{MHz}$	2.2MHz	10kHz	VBW 1kHz Average <u>On</u>
$\pm 10\text{MHz}$	25MHz	100kHz	VBW 10kHz Average <u>On</u>

8. Display average noise level

Description: The display average noise level refer to the background noise observed on the spectrum analyzer with no external noise or signal.

Connect the input end of the spectrum analyzer to the 50 Ω adapter. Set the input attenuation as 0dB. In this case, the normalized noise is the test value of the display average noise level.

a) Test equipment

50 Ω adapter.....70508

b) Test procedure

1) Connect the 50 Ω adapter to the RF input port of the spectrum analyzer as shown in Fig. 12-8.



Fig. 12-8 Setting for Display Average Noise Level Test

Display average noise, pre-amplifier ON (2MHz-10MHz)

2) Finish spectrum analyzer settings as follows:

Starting frequency.....2MHz
Ending frequency.....10MHz
Reference level-50dBm
Marker..... [All Off]
Resolution bandwidth..... 100kHz
Video bandwidth..... 30kHz
Pre-amplifier On
Detector..... [Average]

3) Press **【Marker】** [Marker Noise Off On] and **【Peak】** [Max Search].

4) Press **【BW】** [Average On Off] 5 [OK], until the average 5/5 appears on the left side of the screen.

5) Read the marker peak, and record it as the display average noise level within 2MHz-10MHz (with the pre-amplifier ON) under the corresponding test item in the Schedule of Records of 4024 Series Spectrum Analyzer. Disable the noise marker and averaging function.

Display average noise, pre-amplifier ON (10MHz-4GHz)

- 6) Set the starting frequency of 4024 series spectrum analyzer as 10MHz and stop frequency as 4GHz, and keep other items unchanged.
- 7) Repeat Step 3 and 4.
- 8) Read the marker peak, and record it as the display average noise level within 10MHz-4GHz (with the pre-amplifier ON) under the corresponding test item in the Schedule of Records of 4024 Series Spectrum Analyzer. Disable the noise marker and averaging function.

Display average noise, pre-amplifier ON (4GHz-6GHz)

- 9) Set the starting frequency of 4024 series spectrum analyzer as 4GHz and stop frequency as 6GHz, and keep other items unchanged.
- 10) Repeat Step 3 and 4.
- 11) Read the marker peak, and record it as the display average noise level within 4GHz-6GHz (with the pre-amplifier ON) under the corresponding test item in the Schedule of Records of 4024 Series Spectrum Analyzer. Disable the noise marker and averaging function.

Display average noise, pre-amplifier ON (6GHz-20GHz)

- 12) Set the starting frequency of 4024 series spectrum analyzer as 6GHz and stop frequency as 20GHz, and keep other items unchanged.
- 13) Repeat Step 3 and 4.
- 14) Read the marker peak, and record it as the display average noise level within 6GHz-20GHz (with the pre-amplifier ON) under the corresponding test item in the Schedule of Records of 4024 Series Spectrum Analyzer. Disable the noise marker and averaging function.

Display average noise, pre-amplifier ON (20GHz-32GHz)

- 15) Set the starting frequency of 4024 series spectrum analyzer as 20GHz and stop frequency as 32GHz, and keep other items unchanged.
- 16) Repeat Step 3 and 4.
- 17) Read the marker peak, and record it as the display average noise level within 20GHz-32GHz (with the pre-amplifier ON) under the corresponding test item in the Schedule of Records of 4024 Series Spectrum Analyzer. Disable the noise marker and averaging function.

Display average noise, pre-amplifier ON (32GHz-40GHz)

- 18) Set the starting frequency of 4024 series spectrum analyzer as 32GHz and stop frequency as 40GHz, and keep other items unchanged.
- 19) Repeat Step 3 and 4.
- 20) Read the marker peak, and record it as the display average noise level within 32GHz-40GHz (with the pre-amplifier ON) under the corresponding test item in the Schedule of Records of 4024 Series Spectrum Analyzer. Disable the noise marker and averaging function.

Display average noise, pre-amplifier ON (40GHz-44GHz)

- 21) Set the starting frequency of 4024 series spectrum analyzer as 40GHz and stop frequency as 44GHz, and keep other items unchanged.
- 22) Repeat Step 3 and 4.

23) Read the marker peak, and record it as the display average noise level within 40GHz-44GHz (with the pre-amplifier ON) under the corresponding test item in the Schedule of Records of 4024 Series Spectrum Analyzer. Disable the noise marker and averaging function.

Display average noise, pre-amplifier OFF (2MHz-10MHz)

24) Set the starting frequency of 4024 series spectrum analyzer as 2MHz, stop frequency as 10MHz and reference level as -20dBm, enable the OFF state of the pre-amplifier, and keep other items unchanged.

25) Repeat Step 3 and 4.

26) Read the marker peak, and record it as the display average noise level within 2MHz-10MHz (with the pre-amplifier OFF) under the corresponding test item in the Schedule of Records of 4024 Series Spectrum Analyzer. Disable the noise marker and averaging function.

Display average noise, pre-amplifier OFF (10MHz-4GHz)

27) Set the starting frequency of 4024 series spectrum analyzer as 10MHz, stop frequency as 4GHz and reference level as -20dBm, enable the OFF state of the pre-amplifier, and keep other items unchanged.

28) Repeat Step 3 and 4.

29) Read the marker peak, and record it as the display average noise level within 10MHz-4GHz (with the pre-amplifier OFF) under the corresponding test item in the Schedule of Records of 4024 Series Spectrum Analyzer. Disable the noise marker and averaging function.

Display average noise, pre-amplifier OFF (4GHz-6GHz)

30) Set the starting frequency of 4024 series spectrum analyzer as 4GHz, stop frequency as 6GHz and reference level as -20dBm, enable the OFF state of the pre-amplifier, and keep other items unchanged.

31) Repeat Step 3 and 4.

32) Read the marker peak, and record it as the display average noise level within 4GHz-6GHz (with the pre-amplifier OFF) under the corresponding test item in the Schedule of Records of 4024 Series Spectrum Analyzer. Disable the noise marker and averaging function.

Display average noise, pre-amplifier OFF (6GHz-20GHz)

33) Set the starting frequency of 4024 series spectrum analyzer as 6GHz, stop frequency as 20GHz and reference level as -20dBm, enable the OFF state of the pre-amplifier, and keep other items unchanged.

34) Repeat Step 3 and 4.

35) Read the marker peak, and record it as the display average noise level within 6GHz-20GHz (with the pre-amplifier OFF) under the corresponding test item in the Schedule of Records of 4024 Series Spectrum Analyzer. Disable the noise marker and averaging function.

Display average noise, pre-amplifier OFF (20GHz-32GHz)

36) Set the starting frequency of 4024 series spectrum analyzer as 20GHz, stop frequency as 32GHz and reference level as -20dBm, enable the OFF state of the pre-amplifier, and keep other items unchanged.

37) Repeat Step 3 and 4.

38) Read the marker peak, and record it as the display average noise level within 20GHz-32GHz (with the pre-amplifier OFF) under the corresponding test item in the Schedule of Records of 4024 Series Spectrum Analyzer. Disable the noise marker and averaging function.

Display average noise, pre-amplifier OFF (32GHz-40GHz)

39) Set the starting frequency of 4024 series spectrum analyzer as 32GHz, stop frequency as 40GHz and

reference level as -20dBm, enable the OFF state of the pre-amplifier, and keep other items unchanged.

40) Repeat Step 3 and 4.

41) Read the marker peak, and record it as the display average noise level within 32GHz-40GHz (with the pre-amplifier OFF) under the corresponding test item in the Schedule of Records of 4024 Series Spectrum Analyzer. Disable the noise marker and averaging function.

Display average noise, pre-amplifier OFF (40GHz-44GHz)

42) Set the starting frequency of 4024 series spectrum analyzer as 40GHz, stop frequency as 44GHz and reference level as -20dBm, enable the OFF state of the pre-amplifier, and keep other items unchanged.

43) Repeat Step 3 and 4.

44) Read the marker peak, and record it as the display average noise level within 40GHz-44GHz (with the pre-amplifier OFF) under the corresponding test item in the Schedule of Records of 4024 Series Spectrum Analyzer. Disable the noise marker and averaging function.

9. Second harmonic distortion

Description: The nonlinear device (such as the mixer, amplifier, etc.) will generate various harmonics of the input signal if any. The useless second harmonic component of the signal is known as the second harmonic distortion.

The synthesized signal generator can provide signals through the low-pass filter for the spectrum analyzer to measure the second harmonic distortion. The low-pass filter is used for eliminating any harmonic distortion caused by the signal source. The synthesized signal generator is locked at the 10MHz reference of the spectrum analyzer.

a) Test equipment

Synthesized signal generator..... 1464C

1.0GHz low-pass filter: 1

6.8GHz low-pass filter: 1

18GHz low-pass filter: 1

b) Adapters

One 2.4mm(f)-3.5mm(f) adapter

One 2.4mm(f)-3.5mm(m) adapter

One 3.5mm(f)-3.5mm(f) adapter

c) Cables

One BNC(m-m) cable

One 3.5mm(m-m) cable

d) Test steps

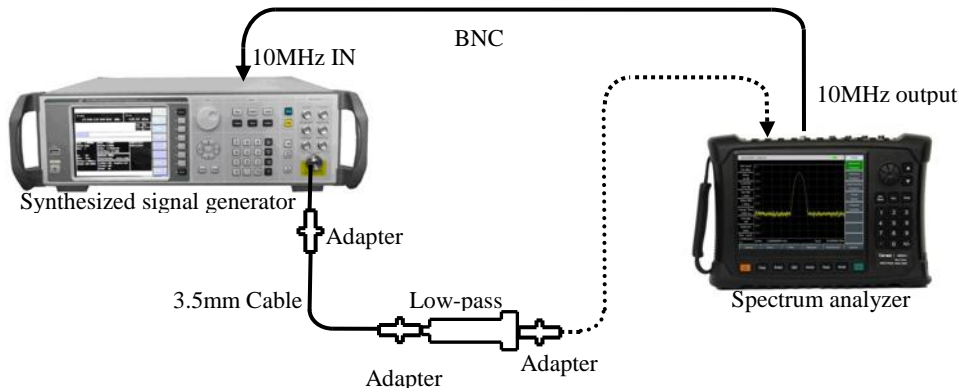

Fig. 12-9 Setting of Second Harmonic Distortion Test

Second harmonic distortion (<4GHz)

- 1) Connect the test instrument as shown in Fig. 12-9. The spectrum analyzer will provide the 10MHz frequency reference for the synthesized signal generator. Use the 1GHz low-pass filter.
- 2) Set the frequency of 1464C instrument as 900MHz and amplitude as -30dBm. Enable the RF output.
- 3) Finish spectrum analyzer settings as follows:

Center frequency	900MHz
Span	10kHz
Reference level	-30dBm
- 4) Press **【Peak】** on the spectrum analyzer. Adjust the power level of 1464C spectrum analyzer until its reading is $-30\text{dBm} \pm 0.1\text{dB}$.
- 5) Press **【Marker】** [Delta] and set the center frequency as 1.8GHz.
- 6) Finish one new sweeping on the spectrum analyzer and press **【Peak】**. Record the differential marker reading as the second harmonic distortion value (4GHz) under the corresponding test item in the Schedule of Records of 4024 Series Spectrum Analyzer.

Second harmonic distortion (4GHz-10GHz)

- 7) Connect the test instruments as shown in Fig. 12-9. Use the 6.8GHz low-pass filter.
- 8) Set the frequency of 1464C instrument as 6GHz and amplitude as -30dBm.
- 9) Finish spectrum analyzer settings as follows:

Center frequency	6GHz
Span	10kHz
Amplitude	-30dBm
Marker.....	[All Off]
- 10) Press **【Peak】** on the spectrum analyzer. Adjust the power level of 1464C spectrum analyzer until its reading is $-30\text{dBm} \pm 0.1\text{dB}$.
- 11) Press **【Marker】** [Delta], and set the center frequency as 12GHz.
- 12) Press **【Peak】** when sweeping is completed. Record the differential marker as the second harmonic distortion value (4GHz-10GHz) under the corresponding test item in the Schedule of Records of 4024

Series Spectrum Analyzer.

Second harmonic distortion (10GHz-22GHz)

- 13) Connect the test instruments as shown in Fig. 12-9. Use the 18GHz low-pass filter.
- 14) Set the frequency of 1464C instrument as 18GHz and amplitude as -30dBm.
- 15) Finish spectrum analyzer settings as follows:

Center frequency	18GHz
Span.....	10kHz
Amplitude.....	-30dBm
Marker.....	[All Off]
- 16) Press **【Peak】** on the spectrum analyzer. Adjust the power level of 1464C spectrum analyzer until its reading is $-30\text{dBm} \pm 0.1\text{dB}$.
- 17) Press **【Marker】** [Delta], and set the center frequency as 36GHz.
- 18) Press **【Peak】** when sweeping is completed. Record the differential marker as the second harmonic distortion value (10GHz-22GHz) under the corresponding test item in the Schedule of Records of 4024 Series Spectrum Analyzer.

10. 3-order intermodulation distortion

Description: 3-order intermodulation distortion because of device's nonlinear characteristic, it is the useless spectrum component caused by two or more input signals interaction.

The two synthesized signal generators provide signals for measuring the third-order intermodulation distortion, the two signals using sine wave and same power and the frequency space is 100kHz, using marker function can measure 3-order intermodulation distortion. Use the filter to filter the signal distortion product that is closest to the signal measured. The spectrum analyzer provides 10MHz reference for the synthesized signal generator.

Note: For different directional couplers, their isolations and standing waves are different, which may cause interference between the two signal generators. If necessary, isolators in associated frequency bands can be connected to the two input ports of the directional couplers.

a) Test equipment

Power meter	ML2437A
Power probe	MA2445D
Synthesized signal generator#1	1464C
Synthesized signal generator#2.....	1461
Directional Coupler.....	70603
RF Directional Coupler	70607
1.0GHz low-pass filter: 2	
6.8GHz low-pass filter: 2	
18GHz low-pass filter: 2	

b) Adapters

- Two 2.4mm(f)-2.4mm(f) adapter
- Two 3.5mm(m)-3.5mm(m) adapter

- Two 2.4mm(f)-3.5mm(f) adapter
- One 2.4mm(f)-3.5mm(m) adapter
- One BNC(T) type(m)(f)(f)

c) Cables

- Two BNC(m-m) cable
- Two 3.5mm(m-m) cable
- Two 2.4mm(m-m) cable

d) Test steps

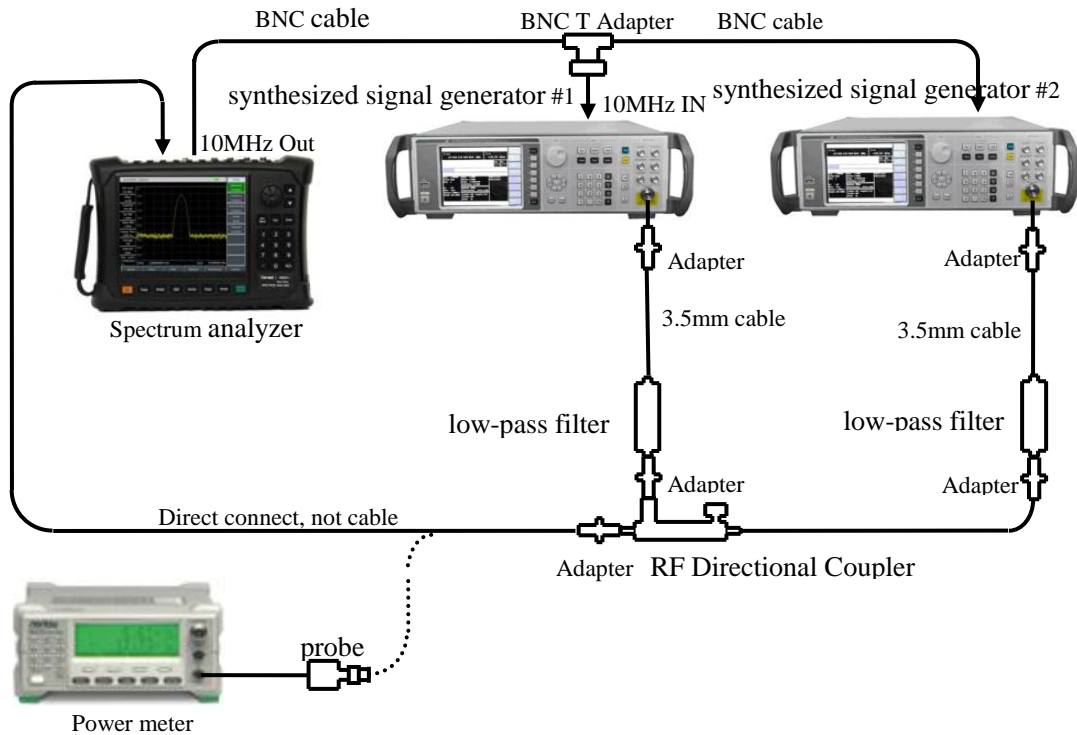

Fig.12-10 Setting for 3-order intermodulation distortion Test (50MHz~4GHz)

Third-order Intermodulation Distortion (50MHz~4GHz)

- 1) Connect the test instrument as shown in Fig. 12-10. Using RF Directional Coupler, do not connect the directional coupler to the spectrum analyzer.
- 2) Set the frequency of 1464C instrument as 900MHz and amplitude as 0dBm. Enable the RF output.
- 3) Set the frequency of 1461 instrument as 900.1MHz and amplitude as -110dBm. Turn off the RF output.
- 4) Connect ML2437A and MA2445D, and ZERO. Set the frequency of ML2437A as 900MHz.
- 5) Finish spectrum analyzer settings as follows:
 - Center frequency.....900MHz
 - Step frequency 100kHz
 - Span 1kHz
 - Reference level -10dBm
- 6) Using adapter to connect MA2445D and the output of the RF Directional Coupler, do not use cable.
- 7) Adjust the output amplitude of the synthesized signal generator 1464C to make the reading of the power meter MA2445D to be -15dBm±0.1dB.
- 8) Connect RF Directional Coupler to the spectrum analyzer.

- 9) Press **【Peak】** , until sweep done, press **【Marker】** [Detal], **【Freq】** **【↑】** .
- 10) Set 1461 amplitude as -15dBm, enable the RF output.
- 11) Press **【Peak】** .
- 12) Adjust the output amplitude of the synthesized signal generator 1461 to make the reading of the spectrum analyzer to be $0\text{dBm} \pm 0.1\text{dB}$.
- 13) Press **【Marker】**[Delta], **【Freq】** **【↓】** **【↓】**, until sweep done, press **【BW】**[Average Off On] 5 [Enter], until video average 5 times done, press **【Peak】** .
- 14) Record the delta marker reading of the spectrum analyzer as the high end product inhibition ΔA , then calculate the 3-order intercept point by following formula using ΔA , (L_0 mixer level) :

$$TOI = L_0 - \frac{\Delta A}{2} \quad (6)$$

- 15) Press **【Freq】** **【↑】** **【↑】** **【↑】** , until sweep done, press **【Peak】** .
- 16) Record the delta marker reading of the spectrum analyzer as the high end product inhibition, calculate the 3-order intercept point by formula (6), compare the high 3-order intercept point and low 3-order intercept point. Record the lower 3-order intercept point under the corresponding test item in the Schedule of Records of 4024 Series Spectrum Analyzer

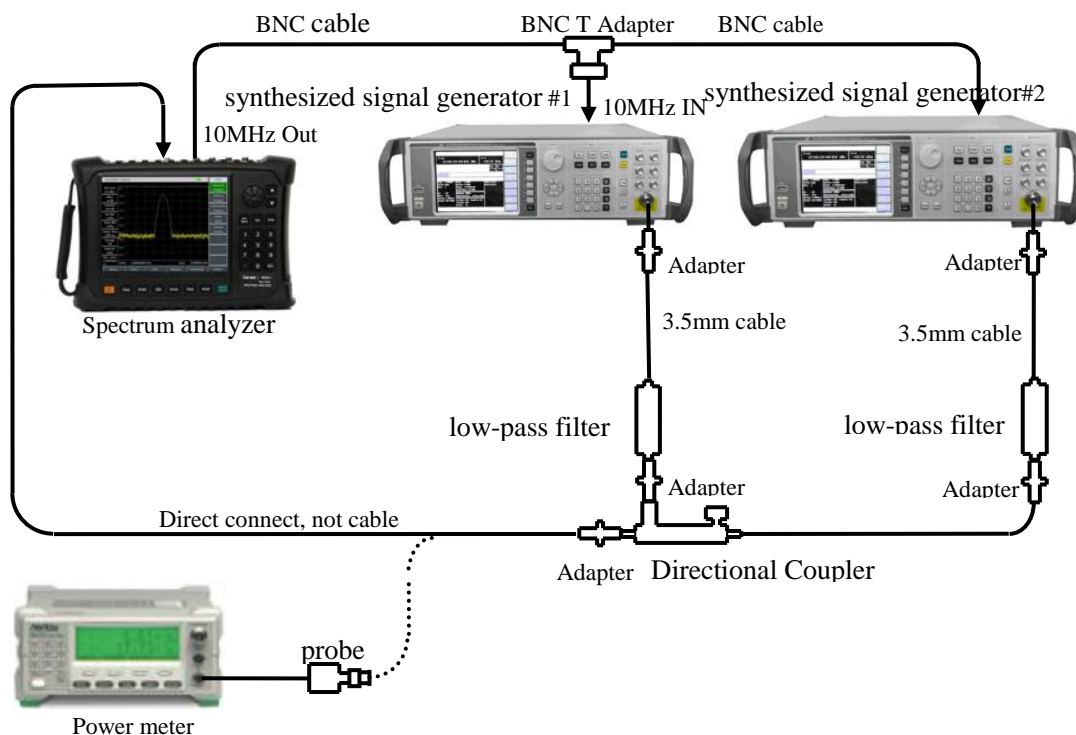

Fig.12-11 Setting for 3-order intermodulation distortion Test (4GHz~44GHz)

Third-order Intermodulation Distortion (4GHz~13GHz)

- 17) Connect the test instrument as shown in Fig. 12-11. Using Directional Coupler, do not connect the directional coupler to the spectrum analyzer.
- 18) Set the frequency of 1464C instrument as 6GHz and amplitude as 0dBm. Enable the RF output.
- 19) Set the frequency of 1461 instrument as 6.0001GHz and amplitude as -110dBm. Turn off the RF output.

- 20) Set the frequency of ML2437A as 6GHz.
 21) Press **【Marker】** [Normal], set center frequency to 6GHz.
 22) Repeat Step 6~16.

Third-order Intermodulation Distortion (13GHz~44GHz)

- 23) Connect the test instrument as shown in Fig. 12-11. Using Directional Coupler, do not connect the directional coupler to the spectrum analyzer.
 24) Set the frequency of 1464C instrument as 15GHz and amplitude as 0dBm. Enable the RF output.
 25) Set the frequency of 1461 instrument as 15.0001GHz and amplitude as -110dBm. Turn off the RF output.
 26) Set the frequency of ML2437A as 15GHz.
 27) Press **【Marker】** [Normal], set center frequency to 15GHz.
 28) Repeat Step 6~16.

11.1dB Gain Compression

Description: Increasing input signal level will make device (such as the mixer, amplifier, etc.) work on nearby saturation point, and the input signal level when output level under linear value 1dB as 1dB Gain Compression.

This test uses two signals with 10MHz interval to measure the gain compression of the spectrum analyzer. In the test, first input the low-level signal to the spectrum analyzer (lower than -10dBm). Then input the specified high amplitude signal to the spectrum analyzer. The amplitude decrease of the first signal caused by the second signal is the gain compression measured.

a) Test equipment

Power meter	ML2437A
Power probe	MA2445D
Synthesized signal generator#1.....	1464C
Synthesized signal generator#2.....	1461
Directional Coupler.....	70603
RF Directional Coupler.....	70607
1.0GHz low-pass filter: 2	
6.8GHz low-pass filter: 2	

b) Adapters

- Two 2.4mm(f)-2.4mm(f) adapter
- One 2.4mm(f)-3.5mm(m) adapter
- One BNC(T) type(m)(f)(f)

c) Cables

- Two BNC(m-m) cable
- Two 2.4mm(m-m) cable

d) Test steps

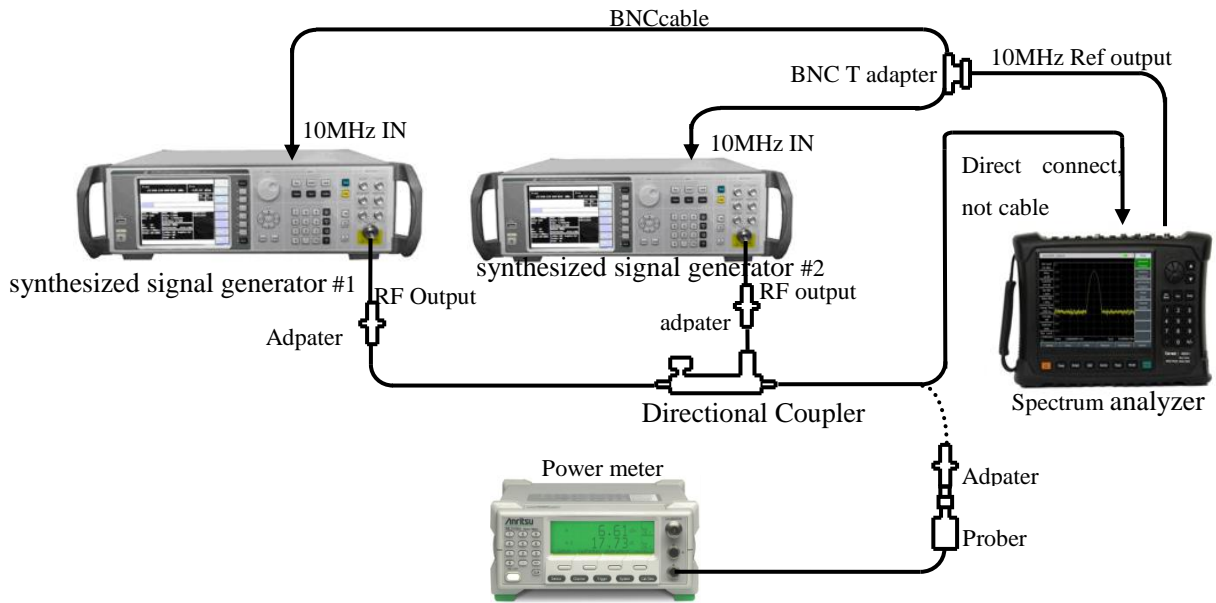

Fig. 12-12 1dB Gain Compression Test

1dB Gain Compression(50MHz~4GHz)

- 1) Connect ML2437A and MA2445D, and ZERO.
- 2) Connect the test instrument as shown in Fig. 12-12. Using RF Directional Coupler, the spectrum analyzer will provide the frequency reference for the synthesized signal generator.
- 3) Set the frequency of 1461 instrument as 2GHz and amplitude as 0dBm. Enable the RF output.
- 4) Set the frequency of 1464C instrument as 2.01GHz and amplitude as -10dBm. Turn off the RF output.
- 5) Finish spectrum analyzer settings as follows:

Center frequency	2GHz
Span.....	1kHz
Reference level	-10dBm
Scale/Div	1dB/Div
- 6) Adjust the power level of the 1461 to make the signal at 2dB to 3dB (2 to 3 grids) down from the reference level of the spectrum analyzer.
- 7) Press **【Peak】 【Marker】** [Delta] on 4024.
- 8) Enable the RF output of 1464C, Adjust the output power level of 1464C to make the spectrum analyzer display reading at -1dB, then turn off the RF output of 1461.
- 9) Remove the spectrum analyzer from the RF directional coupler. Use connectors but not cable to connect the RF directional coupler to the power probe. Set frequency of the power meter as 2GHz, Read the power meter display, and record it as the 1dB Gain Compression within 50MHz-4GHz under the corresponding test item in the Schedule of Records of 4024 Series Spectrum Analyzer. Disable the noise marker and averaging function.

1dB Gain Compression(4GHz~13GHz)

- 10) Connect the test instrument as shown in Fig. 12-12. Using Directional Coupler, the spectrum analyzer will provide the frequency reference for the synthesized signal generator, Set the frequency of 4024 instrument as 9GHz.

- 11) Set the frequency of 1461 instrument as 9GHz and amplitude as 0dBm. Enable the RF output.
- 12) Set the frequency of 1464C instrument as 9.01GHz and amplitude as -10dBm. Turn off the RF output.
- 13) Set the frequency of power meter as 9GHz.
- 14) Repeat steps 6~8.
- 15) Remove the spectrum analyzer from the RF directional coupler. Use connectors but not cable to connect the RF directional coupler to the power probe. Read the power meter display, and record it as the 1dB Gain Compression within 4GHz-13GHz under the corresponding test item in the Schedule of Records of 4024 Series Spectrum Analyzer. Disable the noise marker and averaging function.

1dB Gain Compression(13GHz~44GHz)

- 16) Connect the test instrument as shown in Fig. 12-12. Using Directional Coupler, the spectrum analyzer will provide the frequency reference for the synthesized signal generator, Set the frequency of 4024 instrument as 9GHz.
- 17) Set the frequency of 1461 instrument as 18GHz and amplitude as 0dBm. Enable the RF output.
- 18) Set the frequency of 1464C instrument as 18.01GHz and amplitude as -10dBm. Turn off the RF output.
- 19) Set the frequency of power meter as 18GHz.
- 20) Repeat steps 6~8.
- 21) Remove the spectrum analyzer from the RF directional coupler. Use connectors but not cable to connect the RF directional coupler to the power probe. Read the power meter display, and record it as the 1dB Gain Compression within 13GHz-44GHz under the corresponding test item in the Schedule of Records of 4024 Series Spectrum Analyzer. Disable the noise marker and averaging function.

12. Image, multiple and out-of-band response

Description: During frequency mixing, if two signals can mix with the LO signal with the same one to generate IF signals of the same frequency and if one original signal has a frequency one IF lower than the LO signal and the other original signal has a frequency one IF higher than the LO signal, then such two original signals can be referred to as the image of each other. The input signal of each frequency of the LO signal has an image and the frequency of the original signal and the image differs by two times of IF.

The image, multiple and out-of-band response should be tested within all bands. Apply the signal on the input port of the spectrum analyzer, and measure the reference amplitude. Adjust the frequency of the synthesized signal generator until the image, multiple or out-of-band response occurs. Measure and record the amplitude displayed on the spectrum analyzer.

a) Test equipment

Synthesized signal generator..... 1464C

b) Adapters

Two 2.4mm(f)-2.4mm(f) adapters

c) Cables

One BNC(m-m) cable

One 2.4mm(m-m) cable

d) Test steps

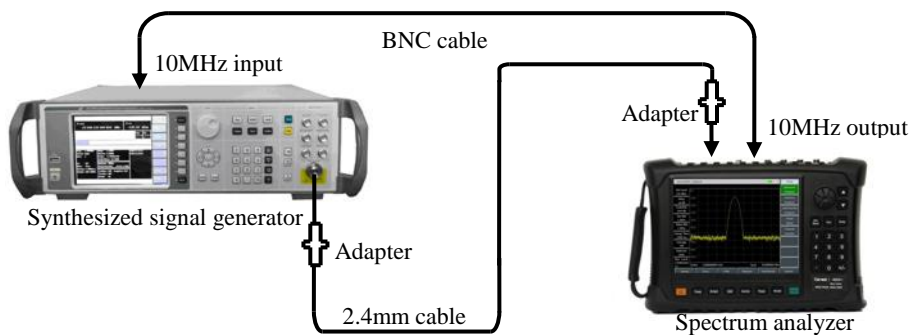

Fig. 12-13 Setting for Image, Multiple and Out-of-band Response Test

- 1) Connect the test instruments as shown in Fig. 12-13. The spectrum analyzer will provide the frequency reference for the synthesized signal source.
- 2) Set the frequency of 1464C instrument as 2GHz and power as -20dBm.
- 3) Finish spectrum analyzer settings as follows:

Center frequency	2GHz
Span.....	10kHz
Reference level.....	-10dBm
Resolution bandwidth	10Hz
Video bandwidth	10Hz
- 4) Adjust the output power level of the synthesized signal generator until the signal peak is close to the reference level of the spectrum analyzer.
- 5) Press **【Peak】** **【Marker】** [Delta] on the spectrum analyzer.
- 6) Set 1464C instrument at each frequency point where the image, multiple and out-of-band response may occur corresponding to 2GHz under the related test item in the Schedule of Records of 4024 Series Spectrum Analyzer. Set the reference level of the spectrum analyzer as -40dBm and resolution bandwidth as 10Hz. Press **【Peak】** and record the amplitude of the differential marker as the response amplitude under the corresponding test item in the Schedule of Records of 4024 Series Spectrum Analyzer.
- 7) Test the image, multiple and out-of-band response at all the other frequency points listed in the Schedule of Records of 4024 Series Spectrum Analyzer according to the steps 2-6.

13. Residual response

Description: The residual response refers to the discrete response observed on the display of the spectrum analyzer with no input signal.

- a) Test equipment.....50 matched loads
- b) Test steps

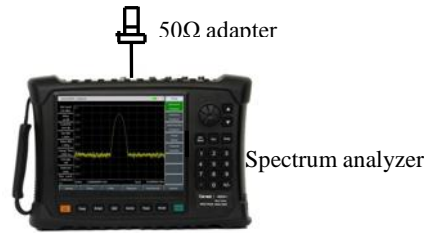

Fig. 12-14 Setting for Residual Response Test

Residual response, 10MHz~20GHz (with the pre-amplifier ON)

1) Connect the test instruments as shown in Fig. 12-14. Connect the 50Ω adapter top the signal input port of the spectrum analyzer and set the spectrum analyzer as follows:

Center frequency	65MHz
Frequency step	100MHz
Span	110MHz
Reference level	-50dBm
Pre-amplifier	On
Resolution bandwidth	10kHz
Video bandwidth.....	3kHz

2) Enable the limit function, set the limit as -100dBm. The noise level should be at least 5dB less than the limit. Otherwise, the noise level should be reduced by decreasing the resolution bandwidth and video bandwidth.

3) Observe whether the residual response signal exists on the noise baseline of the spectrum analyzer. If any, read the amplitude of residual response with the marker, and record the measurement result. The amplitude of the residual response signal should be at least 10dB more than the display average noise level in the test; otherwise, the display average noise level should be reduced by further decreasing the resolution bandwidth.

4) Press **【Freq】** [Center Freq] **【↑】** to change the center frequency. Repeat Step 3 to check the residual response under the frequency 20GHz. Record the measured maximum response into the measurement result column of the corresponding test item in the Schedule of Records of 4024 Series Spectrum Analyzer.

Residual response, 20GHz-44GHz (with the pre-amplifier ON)

5) Finish spectrum analyzer settings as follows:

Center frequency	20.055GHz
Frequency step	100MHz
Span	110MHz
Reference level	-50dBm
Pre-amplifier	On
Resolution bandwidth	10kHz
Video bandwidth.....	3kHz

6) Enable the limit function, set the limit as -95dBm. The noise level should be at least 5dB less than the

limit. Otherwise, the noise level should be reduced by decreasing the resolution bandwidth and video bandwidth.

7) Observe whether the residual response signal exists on the noise baseline of the spectrum analyzer. If any, read the amplitude of residual response with the marker, and record the measurement result. The amplitude of the residual response signal should be at least 10dB more than the display average noise level in the test; otherwise, the display average noise level should be reduced by further decreasing the resolution bandwidth.

8) Press **【Freq】** [Center Freq] **【↑】** to change the center frequency. Repeat Step 7 to check the residual response under the frequency 44GHz. Record the measured maximum response into the measurement result column of the corresponding test item in the Schedule of Records of 4024 Series Spectrum Analyzer.

Residual response, 10MHz-13GHz (with the pre-amplifier OFF)

9) Finish spectrum analyzer settings as follows:

Center frequency	65MHz
Frequency step	100MHz
Span.....	110MHz
Reference level	-20dBm
Pre-amplifier	Off
Resolution bandwidth	10kHz
Video bandwidth.....	3kHz

10) Enable the limit function, set the limit as -90dBm. The noise level should be at least 5dB less than the limit. Otherwise, the noise level should be reduced by decreasing the resolution bandwidth and video bandwidth.

11) Observe whether the residual response signal exists on the noise baseline of the spectrum analyzer. If any, read the amplitude of residual response with the marker, and record the measurement result. The amplitude of the residual response signal should be at least 10dB more than the display average noise level in the test; otherwise, the display average noise level should be reduced by further decreasing the resolution bandwidth.

12) Press **【Freq】** [Center Freq] **【↑】** to change the center frequency. Repeat Step 11 to check the residual response under the frequency 13GHz (with the pre-amplifier OFF). Record the measured maximum response into the measurement result column of the corresponding test item in the Schedule of Records of 4024 Series Spectrum Analyzer.

Residual response, 13GHz-20GHz (with the pre-amplifier OFF)

13) Finish spectrum analyzer settings as follows:

Center frequency	13.055GHz
Frequency step	100MHz
Span.....	110MHz
Reference level.....	-20dBm
Pre-amplifier	Off
Resolution bandwidth	10kHz

Video bandwidth..... 3kHz

14) Enable the limit function, set the limit as -85dBm. The noise level should be at least 5dB less than the limit. Otherwise, the noise level should be reduced by decreasing the resolution bandwidth and video bandwidth.

15) Observe whether the residual response signal exists on the noise baseline of the spectrum analyzer. If any, read the amplitude of residual response with the marker, and record the measurement result. The amplitude of the residual response signal should be at least 10dB more than the display average noise level in the test; otherwise, the display average noise level should be reduced by further decreasing the resolution bandwidth.

16) Press **【Freq】** [Center Freq] **【↑】** to change the center frequency. Repeat Step 15 to check the residual response under the frequency 20GHz (with the pre-amplifier OFF). Record the measured maximum response into the measurement result column of the corresponding test item in the Schedule of Records of 4024 Series Spectrum Analyzer.

Residual response, 20GHz-44GHz (with the pre-amplifier OFF)

17) Finish spectrum analyzer settings as follows:

Center frequency	20.055GHz
Frequency step.....	100MHz
Span.....	110MHz
Reference level	-20dBm
Pre-amplifier	Off
Resolution bandwidth.....	10kHz
Video bandwidth	3kHz

18) Enable the limit function, set the limit as -80dBm. The noise level should be at least 5dB less than the limit. Otherwise, the noise level should be reduced by decreasing the resolution bandwidth and video bandwidth.

19) Observe whether the residual response signal exists on the noise baseline of the spectrum analyzer. If any, read the amplitude of residual response with the marker, and record the measurement result. The amplitude of the residual response signal should be at least 10dB more than the display average noise level in the test; otherwise, the display average noise level should be reduced by further decreasing the resolution bandwidth.

20) Press **【Freq】** [Center Freq] **【↑】** to change the center frequency. Repeat Step 19 to check the residual response under the frequency 44GHz (with the pre-amplifier OFF). Record the measured maximum response into the measurement result column of the corresponding test item in the Schedule of Records of 4024 Series Spectrum Analyzer.

14. Reference level

Description: The location of the vertical scale calibrated on the screen of the spectrum analyzer is used for reference in amplitude measurement. The reference level generally refers to the top division of the scale. Switching of the reference level will cause the linkage of gain/attenuation. The reference level conversion error is applied to examine the error of the ON/OFF gain of the spectrum analyzer.

a) Test equipment

Signal generator	1464C
Power meter	ML2437A
Power probe	MA2445D
Power divider	81313

b) Adapters

One 2.4mm(f)-2.4mm(f) adapter

c) Cables

One BNC(m-m) cable

One 2.4mm(m-m) cable

d) Test steps

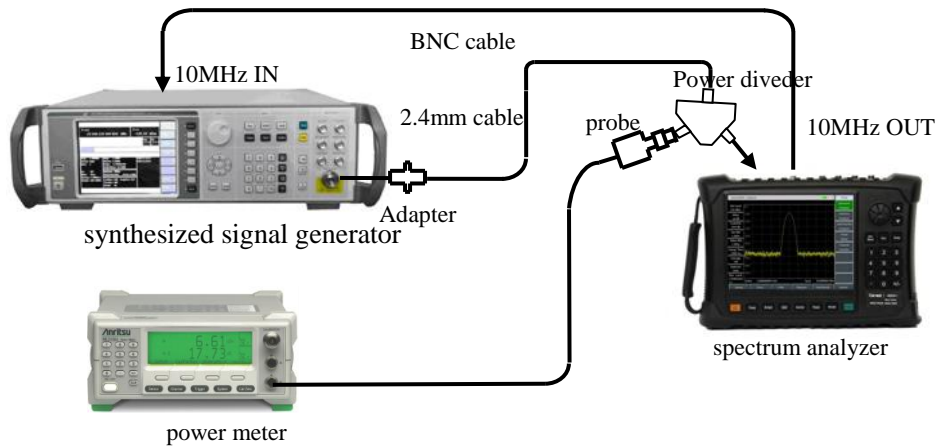

Fig. 12-15 Setting for Reference Level Uncertainty and Scale Fidelity Test

- 1) Connect ML2437A with MA2445D and ZERO, set calfactor frequency 50MHz.
- 2) Connect the test equipment as shown in Fig. 12-15. The spectrum analyzer will provide the frequency reference for 1464C synthesized signal generator, connect the spectrum analyzer and power meter with signal generator by power divider.
- 3) Set **【Ampt】** [Ref Level] with the knob or step keys **【↑】** and **【↓】** on 4024 series. The reference level can be set as max. +30dBm and min. -120dBm according to the requirements. Mark “√” in the corresponding result column in the Schedule of Records of 4024 Series Handheld Spectrum Analyzer if the reference level complies with the requirements; otherwise, mark “×”.
- 4) Set the output frequency of 1464C instrument as 50MHz and amplitude as -3dBm±0.05dB.
- 5) Set the spectrum analyzer as follows:

Center frequency	50MHz
Reference level.....	0dBm
Span.....	1kHz
Logarithmic scale dB/division	1 dB
Resolution bandwidth	10Hz
- 6) Adjust the output amplitude of 1464C instrument, until the signal level is 2-3 divisions below the

reference level of the spectrum analyzer.

- 7) Press **【Peak】【Marker】** [Delta] on the spectrum analyzer.
- 8) Press **【↓】** once on 1464C instrument.
- 9) Set the reference level of the spectrum analyzer as the value listed in the Schedule of Records of 4024 Series Spectrum Analyzer. Press **【Peak】** after sweeping is finished.
- 10) Record the amplitude reading of the differential marker of the spectrum analyzer, and perform the following calculation: (amplitude reading of the differential marker of the spectrum analyzer - set reference level). Record the calculated value as the uncertainty of the current reference level under the corresponding test item in the Schedule of Records of 4024 Series Spectrum Analyzer.
- 11) Repeat the steps 7-9 to the other reference levels of the spectrum analyzer in the Schedule of Records of 4024 Series Spectrum Analyzer.

15. Scale fidelity

Description: The scale fidelity refers to the error between the vertical scale on the screen of the spectrum analyzer and the theoretical value, and is applied to examine the linearity of the A/D converter of the spectrum analyzer.

Test the fidelity under 10dB/division. Set the resolution bandwidth as 10Hz and the starting amplitude of the input signal above the 0dBm reference level. When the signal amplitude is reduced, the displayed signal amplitude is compared with the reference level. The spectrum analyzer will provide the 10MHz reference for the signal generator.

a) Test equipment

Signal generator	1464C
Power meter	ML2437A
Power probe	MA2445D
Power divider	81313

b) Adapters

One 2.4mm(f)-2.4mm(f) adapter

c) Cables

- One BNC(m-m) cable
- One 2.4mm(m-m) cable

d) Test steps

- 1) Connect ML2437A with MA2445D and ZERO, set calfactor frequency 50MHz.
- 2) Connect the test equipment as shown in Fig. 12-15. The spectrum analyzer will provide the frequency reference for 1464C synthesized signal generator; connect the spectrum analyzer and power meter with signal generator by power divider.
- 3) Finish spectrum analyzer settings as follows:

Center frequency	50MHz
Reference level	0dBm
Marker	Off
Span	1kHz

- Resolution bandwidth 10Hz
- 4) Set the frequency of 1464C instrument as 50MHz, amplitude as 6dBm and amplitude step as 0.05dB.
 - 5) Press **【Peak】** on the spectrum analyzer.
 - 6) Press **【Ampt】** on 1464C instrument and adjust the amplitude with the **【↑】** and **【↓】** key until the accurate readout of the marker of the spectrum analyzer is $0\text{dBm} \pm 0.05\text{dB}$. Set the amplitude set as 10dB.
 - 7) Press **【Peak】 【Marker】** [Delta] on the spectrum analyzer.
 - 8) Adjust the output level of the 1464C, until the signal level reading from power meter decrease $10\text{dB} \pm 0.05\text{dB}$.
- Press **【↓】** on 1464C instrument and wait for new sweeping of the spectrum analyzer. Press **【Peak】** and read the amplitude of the differential marker.
- 9) Perform the following calculation: (amplitude of the differential marker of the spectrum analyzer - power change of the signal source), and record the calculated value under the corresponding test item in the Schedule of Records of 4024 Series Spectrum Analyzer. Repeat Step 8 and 9.

16. Total level uncertainty

Description: The total level uncertainty refers to the difference between the output power reading of the synthesized signal generator (tested with the power meter) and the output reading of the signal generator (tested with the spectrum analyzer).

a) Test equipment

Synthesized signal generator.....	1464C
Power meter	ML2437A
Power probe	MA2445D
Power divider.....	.81313

b) Adapters

Two 2.4mm(f)-2.4mm(f) adapters

c) Cables

One BNC(m-m) cable

One 2.4mm(m-m) cable

d) Test steps

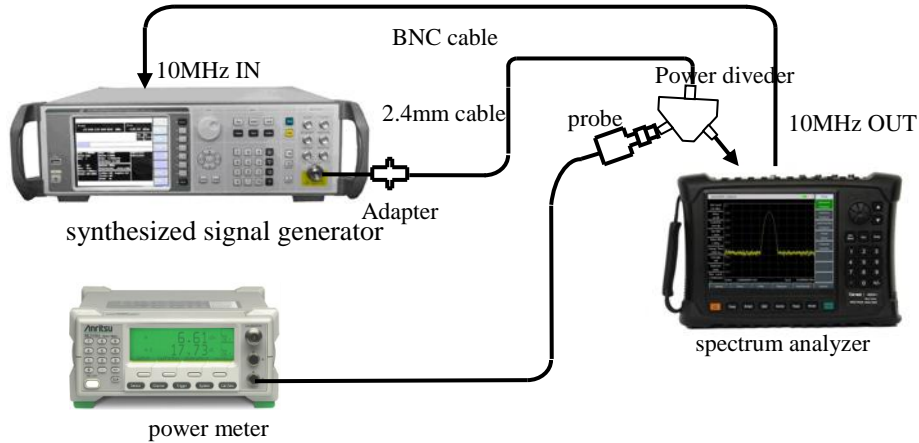

Fig. 12-16 Setting for Total Level Uncertainty Test

- 1) Connect the power meter and power probe and perform zero calibration.
- 2) Connect the test equipment as shown by the dotted line in Fig. 12-16. Connect the output of the signal generator to the SUM port of the power divider, and PORT1 and PORT2 connect to the power meter and spectrum analyzer.

Total level uncertainty (change attenuator)

- 3) Reset 1464C instrument and set the frequency as 50MHz and amplitude as -15dBm.
- 4) Finish spectrum analyzer settings as follows:

Center frequency	50MHz
Span	100kHz
Reference level	-10dBm
Resolution bandwidth	1kHz
Video bandwidth	100Hz
- 5) Adjust output level of the signal generator, until the level reading from power meter is -25dBm.
- 6) Press **【Peak】**, record the marker level L and the display level $L_{\text{power meter}}$ of the power meter, Calculate the total level uncertainty ΔL as follows:

$$\Delta L = L - L_{\text{power meter}} \quad (7)$$

Record the calculated ΔL as the test result of the total level uncertainty in the Schedule of Records of 4024 Series Spectrum Analyzer.

- 7) Repeat the steps 6, change the attenuator value of the spectrum analyzer to 10dB, 20dB, and Record the calculated ΔL .
- 8) Set the Ref Level of the spectrum analyzer to 20dBm, change the output level of the signal generator until the reading from the power meter is -5dBm.
- 9) Repeat the steps 6, change the attenuator value of the spectrum analyzer to 30dB, 40dB, 50dB, and Record the calculated ΔL .
- 10) Set frequency in the Schedule of Records of 4024 Series Spectrum Analyzer, and repeat step 5~9.

Total level uncertainty (Frequency Respond)

- 11) Reset 1464C instrument and set the frequency as 500MHz and amplitude as -15dBm.
- 12) Set factor frequency of the power meter 500MHz, adjust the output level of the signal generator until the level reading from the power meter is -25dBm.
- 13) Set the frequency of the spectrum analyzer as 500MHz, the ref level as -10dBm, attenor as 0dB, repeat stet 6.
- 14) Set frequency in the Schedule of Records of 4024 Series Spectrum Analyzer, and repeat step 5~9.

17. Input attenuator

Description: The attenuation switching uncertainty is measured within the range (50dB) of the input attenuator under the whole band in the test. The reference input of the synthesized signal generator is the 10MHz reference of the spectrum analyzer. Set the 0dB attenuator for switching uncertainty reference. The attenuator in the signal generator is used as the measurement standard.

a) Test equipment

Synthesized signal generator..... 1464C

b) Adapters

Two 2.4mm(f)-2.4mm(f) adapters

c) Cables

One BNC(m-m) cable (120cm)

One 2.4mm(m-m) cable (100cm)

d) Test steps

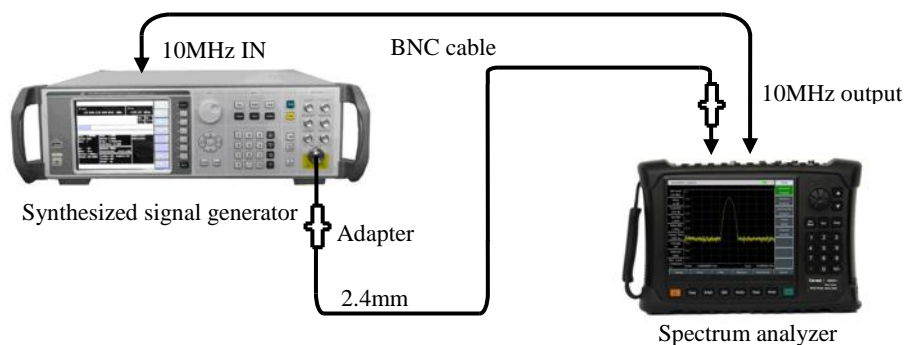

Fig. 12-17 Setting for Input Attenuator Switching Uncertainty Test

1) Connect the test equipment as shown in Fig. 12-17. The spectrum analyzer will provide the frequency reference for the synthesized signal generator 1464C.

2) Set the output power level of the signal generator as -13dBm, output power as 100MHz.

3) Press **【Preset】** on the spectrum analyzer and finish the following settings:

Center frequency 100MHz
 Span..... 100Hz
 Reference level..... -10dBm
 Attenuation 0dB
 Resolution bandwidth 10Hz

- 4) After sweeping is finished, press **【Peak】**, **【Marker】**, [Delta]. Use the 0dB attenuation of the attenuator as the reference.
- 5) Set the spectrum analyzer by pressing **【Ampt】** [Atten Auto Man]. Set the attenuation value of the attenuator.
- 6) After sweeping is finished, press **【Peak】** . Perform the following calculation: current input attenuator error = amplitude difference of the differential marker - attenuation value.
- 7) Repeat the steps 5-6 until all attenuation values of the attenuator in the table are tested. Record test results in the Schedule of Records of 4024 Series Spectrum Analyzer.

18. Input voltage standing wave ratio (VSWR) test

a) Test equipment

Network analyzerN5245A
 One 2.4mm calibration kit (including the open circuit, short circuit and load)
 One 2.4mm(m-m) calibrating cable

b) Test procedure



Fig. 12-18 Voltage Standing Wave Ratio Test of Input Port

- 1) Set the appropriate frequency range and source output power of the vector network analyzer, and enable the VSWR display mode.
- 2) Measure and calibrate the single port (including open circuit, short circuit and load calibration) of the vector network analyzer at the end of the calibration cable.
- 3) After calibration, remove the calibration kit from the end of the calibration cable and connect it to the RF input port of the spectrum analyzer, as shown in Fig. 12-18.
- 4) Press [Rest] on the spectrum analyzer. Wait for restart to enter the spectrum analyzer interface.
- 5) Read the maximum VSWR by the marker function of the vector network analyzer.
- 6) Record test results under the corresponding test item in the Schedule of Records of 4024 Series Spectrum Analyzer.

19. Maximum safety input level

Connect 4024 series spectrum analyzer with the power supply. After normal start-up, set [Ref Level] +30dBm. If the displayed reference level is +30dBm, no error prompt appear and the reference level displayed on the left side of the spectrum analyzer is +30dBm, it indicates that the maximum safety input level of the spectrum analyzer is normal.

The performance test item is guaranteed by the MMW DC block and program-controlled step attenuator in the spectrum analyzer.

20. Display scale

Connect 4024 series spectrum analyzer with the power supply. After normal start-up, manually set the scale as 0.1-10dB per divisions, with the step of 0.1dB (10-division). The display range of [Scale Type Log Lin] is 10 divisions. [Units] provides five options: dBm, dBW, dBV, dBmV, dB μ V, dBA, dBmA, dB μ A, Volts, Watts. This indicates that the display scale of the spectrum analyzer is normal.

21. Video bandwidth

Connect 4024 series spectrum analyzer with the power supply. After normal start-up, set the resolution bandwidth as 10MHz. In this case, the video bandwidth is 10MHz. Press **【↓】**. Once the resolution bandwidth is changed, the corresponding video bandwidth will change and be automatically coupled with the resolution bandwidth, with the minimum value of 1Hz and step of 1-3.

Article III Maintenance Instructions

Chapter XIII Troubleshooting and Repair

This chapter will introduce how to find out problems and receive the after-sales service. Interpretation of internal errors of the spectrum analyzer is also included.

If you have any problem in operation of 4024 series spectrum analyzer or want to purchase related components, options or accessories, we will provide complete after-sales services.

In general, the trouble is caused by failure of hardware/software or users' misuse. Please contact us immediately in case of any trouble. If the warranty is valid, we will provide maintenance services free of charge according to the commitment in the warranty; otherwise, we will charge costs.

Section 1 Fault Information Description

Description

This section will help you to simply judge and deal with faults of 4024 series spectrum analyzer. If necessary, report the problems to us as accurately as possible so that we can solve the problems as soon as possible.

You can check 4024 series instrument according to the following prompts in the case of any fault: Please contact us if the failure cannot be removed.

- ✧ If 4024 series cannot be started when the Power key is pressed, check whether the power supply is normal, whether the adapter indicator is ON and whether the power supply battery is normal. If the above items are normal, the instrument failure may occur. In this case, contact us for repair.
- ✧ If the system or applicable program fails after start-up of 4024 series instrument, press **【Preset】** to recover the known state. If 4024 still cannot work properly, an instrument failure may occur. In this case, contact us for repair.
- ✧ If the performance specifications of 4024 series are abnormal, check whether the test tools and test environment conform to the requirements, whether the connector of the test port is damaged and whether the performance specifications of the calibration kit are normal. If the above items are normal, instrument failure may occur. In this case, contact us for repair.
- ✧ If LAN communication of 4024 series fails. First check the IP address and the yellow indicator beside the LAN interface on the top panel. If the indicator does not flicker, check the LAN cable and connections. If all the above items are in good conditions, it indicates that the instrument may be faulty. Contact us for repair.

Section 2 Repair Method

If you cannot solve the problem of 4024 series, contact us by telephone or fax. If it is confirmed that repair is required, please pack the instrument by the following steps:

- 1) Prepare one copy of paper file describing the instrument failure, and place it into the packing box together with the tester.
- 2) Use the original packaging materials to pack the instrument properly to minimize damage.
- 3) Set pads in the four corners of the outer packing box, and place the instrument into the outer packing box.
- 4) Seal the opening of the packing box with sticky tape and strengthen the packing box with nylon straps.
- 5) Mark “Fragile! No touch! Handle with care” on the packing case.
- 6) Ship this instrument as a precision instrument, and keep a copy of all the shipping documents.

Appendix A Performance Characteristic Test Results

Schedule Performance Characteristic Test Results of 4024 Series Spectrum Analyzer

Instrument No.: _____

Tester: _____

Test conditions: _____

Testing date: _____MM/DD/YY

Table A.1 Schedule of Records of 4024 D/E/F/G Spectrum Analyzer

S/N	Inspection item	Unit	Standards	Test result
1	Design and structure	/	Structure type: Handheld	
		/	Appearance color: black	
		/	The instrument surface should be smooth with no burr, obvious mechanical damage or coating damage. The structure should be complete, with the controls installed properly and reliably and keys flexible to operate and connectors easy to plug in place.	
2	Function	/	Spectrum measurement	
		/	Power kit measurement	
		/	Audio demodulation	
		/	IQ capture	
3	Options	/	Interference Analyzer	
		/	Analog demodulation analysis	
		/	USB power measurement	
		/	Channel Scanner	
		/	Field strength measurement	
		/	GPS function	
		/	secure option	
4	Frequency range	/	Lower limit	9kHz±21Hz
		/	Upper limit	Upper limit of frequency±21Hz
5	Frequency reading accuracy	kHz	3.0GHz(frequency span 500kHz):	±12.70
		MHz	3.0GHz(frequency span 50MHz):	±1.03
		MHz	3.0GHz(frequency span 500MHz):	±10.30
		kHz	5.5GHz(frequency span 500kHz):	±14.70
		MHz	5.5GHz(frequency span 50MHz):	±1.03
		MHz	5.5GHz(frequency span 500MHz):	±10.30
		kHz	7.0GHz(frequency span 500kHz):	±15.90
		MHz	7.0GHz(frequency span 50MHz):	±1.03
		MHz	7.0GHz(frequency span 500MHz):	±10.30
		kHz	8.5GHz (frequency span 500kHz):	±17.10
		MHz	8.5GHz (frequency span 50MHz):	±1.03
		MHz	8.5GHz (frequency span 500MHz):	±10.30
	kHz	10.0GHz (frequency span 500kHz):	±18.30	

Note: This table applies to the normal temperature test of 4024D/E/F/G spectrum analyzer, and the contents may be modified depending on the specific model and option configuration, so as to adapt to actual test and inspection needs.

Table A.1 (continued 1) Schedule of Records of 4024D/E/F/G Spectrum Analyzer

S/N	Inspection item		Unit	Standards	Inspection result
5	Frequency reading accuracy		MHz	10.0GHz (frequency span 50MHz):	±1.03
			MHz	10.0GHz (frequency span 500MHz):	±10.30
			kHz	12.0GHz (frequency span 500kHz):	±19.90
			MHz	12.0GHz (frequency span 50MHz):	±1.03
			MHz	12.0GHz(frequency span 500MHz) :	±10.30
			kHz	15.0GHz(frequency span 500kHz) :	±22.30
			MHz	15.0GHz(frequency span 50MHz) :	±1.04
			MHz	15.0GHz(frequency span 500MHz) :	±10.31
			kHz	19.0GHz(frequency span 500kHz) :	±25.50
			MHz	19.0GHz(frequency span 50MHz) :	±1.04
			MHz	19.0GHz(frequency span 500MHz) :	±10.31
			kHz	24.0GHz(frequency span 500kHz) :	±29.50
			MHz	24.0GHz(frequency span 50MHz) :	±1.04
			MHz	24.0GHz(frequency span 500MHz) :	±10.31
			kHz	29.0GHz(frequency span 500kHz) :	±33.50
			MHz	29.0GHz(frequency span 50MHz) :	±1.05
			MHz	29.0GHz(frequency span 500MHz) :	±10.32
			kHz	34.0GHz(frequency span 500kHz) :	±37.50
			MHz	34.0GHz(frequency span 50MHz) :	±1.05
			MHz	34.0GHz(frequency span 500MHz) :	±10.32
kHz	43.0GHz(frequency span 500kHz) :	±44.70			
MHz	43.0GHz(frequency span 50MHz) :	±1.06			
MHz	43.0GHz(frequency span 500MHz) :	±10.33			
6	Span accuracy		/	1kHz	±2.0%
			/	10kHz	±2.0%
			/	100kHz	±2.0%
			/	1MHz	±2.0%
			/	10MHz	±2.0%
			/	100MHz	±2.0%
			/	1GHz	±2.0%
			/	10GHz	±2.0%
7	Sweep time	Range	/	10μs~600s (zero span)	
		Accuracy	/	1ms	±2.0%
	/		10ms	±2.0%	
	/		100ms	±2.0%	
	/		1s	±2.0%	
	/		10s	±2.0%	
8	Resolution bandwidth accuracy		/	10MHz	±20.0%
			/	3MHz	±10.0%
			/	1MHz	±10.0%
			/	300kHz	±10.0%

Table A.1 (continued 2) Schedule of Records of 4024D/E/F/G Spectrum Analyzer

S/N	Inspection item	Unit	Standards	Inspection result	
8	Resolution bandwidth accuracy	/	100kHz	$\pm 10.0\%$	
		/	30kHz	$\pm 10.0\%$	
		/	10kHz	$\pm 10.0\%$	
		/	3kHz	$\pm 10.0\%$	
		/	1kHz	$\pm 10.0\%$	
9	Resolution Bandwidth Conversion uncertainty	dB	10MHz	± 1.20	
		dB	3MHz	± 1.20	
		dB	1MHz	± 1.20	
		dB	300kHz	± 1.20	
		/	100kHz	Reference	
		dB	30kHz	± 1.20	
		dB	10kHz	± 1.20	
		dB	3kHz	± 1.20	
		dB	1kHz	± 1.20	
		dB	300Hz	± 1.20	
		dB	100Hz	± 1.20	
		dB	30Hz	± 1.20	
		dB	10Hz	± 1.20	
		dB	3Hz	± 1.20	
dB	1Hz	± 1.20			
10	Sideband noise (carrier 1GHz)	dBc/Hz	+10kHz	≤ -102	
		dBc/Hz	-10kHz	≤ -102	
		dBc/Hz	+100kHz	≤ -106	
		dBc/Hz	-100kHz	≤ -106	
		dBc/Hz	+1MHz	≤ -111	
		dBc/Hz	-1MHz	≤ -111	
		dBc/Hz	+10MHz	≤ -123	
		dBc/Hz	-10MHz	≤ -123	
11	Display average noise level	dBm	2MHz~10MHz (Pre-amplifier On)	≤ -150	
		dBm	10MHz~20GHz (Pre-amplifier On)	≤ -157	
		dBm	20GHz~32GHz (Pre-amplifier On)	≤ -154	
		dBm	32GHz~40GHz (Pre-amplifier On)	≤ -148	
		dBm	40GHz~44GHz (Pre-amplifier On)	≤ -140	
		dBm	2MHz~10MHz (Pre-amplifier Off)	≤ -135	
		dBm	10MHz~20GHz (Pre-amplifier Off)	≤ -138	
		dBm	20GHz~32GHz (Pre-amplifier Off)	≤ -135	
		dBm	32GHz~40GHz (Pre-amplifier Off)	≤ -127	
		dBm	40GHz~44GHz (Pre-amplifier Off)	≤ -120	
12	Second harmonic distortion	dBc	<4GHz	<-60	
		dBc	4GHz~10GHz	<-60	
		dBc	10GHz~22GHz	<-60	

Table A.1 (continued 3) Schedule of Records of 4024D/E/F/G Spectrum Analyzer

S/N	Inspection item		Unit	Standards	Inspection
13	3-order intermodulation		dBm	50MHz~4GHz	$\geq +7$
			dBm	4GHz~13GHz	$\geq +6$
			dBm	13GHz~44GHz	$\geq +6$
14	1dB gain compression		dBm	50MHz~4GHz	≥ -2
			dBm	4GHz~13GHz	≥ -3
			dBm	13GHz~44GHz	≥ -3
15	Image, multiple and out-of-b and response	2GHz	dBc	Image frequency 15080.5MHz	< -65
			dBc	Image frequency 2280.5MHz	< -65
			dBc	Image frequency 2062.5MHz	< -65
		8GHz	dBc	Image frequency 11480.5MHz	< -65
			dBc	Image frequency 8280.5MHz	< -65
			dBc	Image frequency 8062.5MHz	< -65
		15GHz	dBc	Image frequency 21680.5MHz	< -65
			dBc	Image frequency 15280.5MHz	< -65
			dBc	Image frequency 15062.5MHz	< -65
		24GHz	dBc	Image frequency 40800MHz	< -60
			dBc	Image frequency 20519.5MHz	< -60
			dBc	Image frequency 24280.5MHz	< -60
			dBc	Image frequency 24062.5MHz	< -60
		42GHz	dBc	Image frequency 21600MHz	< -60
			dBc	Image frequency 38519.5MHz	< -60
			dBc	Image frequency 42280.5MHz	< -60
dBc	Image frequency 42062.5MHz		< -60		
16	Residual response		dBm	10MHz~20GHz (Pre-amplifier On)	≤ -100
			dBm	20GHz~ upper limit (Pre-amplifier On)	≤ -95
			dBm	10MHz~13GHz (Pre-amplifier Off)	≤ -90
			dBm	13GHz~20GHz (Pre-amplifier Off)	≤ -85
			dBm	20GHz~ upper limit (Pre-amplifier Off)	≤ -80
17	Referen ce level	Range	/	Log type: -120dBm~+30dBm, 1dB step Linear scale: 22.36uV~7.07V, 0.1% step	
		Convers ion error	/	0dBm	Reference
	dB		-10dBm	± 1.20	
	dB		-20dBm	± 1.20	
	dB		-30dBm	± 1.20	
	dB		-40dBm	± 1.20	
	dB		-50dBm	± 1.20	
	dB	-60dBm	± 1.20		
18	Scale fidelity		dB	-10dBm	± 1.00
			dB	-20dBm	± 1.00

Table A.1 (continued 4) Schedule of Records of 4024D/E/F/G Spectrum Analyzer

S/N	Inspection item	Unit	Standards	Inspection result
18	Scale fidelity	dB	-30dBm ±1.00	
		dB	-40dBm ±1.00	
		dB	-50dBm ±1.00	
		dB	-60dBm ±1.00	
19	Total level uncertainty	dB	50MHz (Atten 0dB, Input power -25dBm) : ±1.80	
		dB	50MHz (Atten 10dB, Input power -25dBm) ±1.80	
		dB	50MHz (Atten 20dB, Input power -25dBm) : ±1.80	
		dB	50MHz (Atten 30dB, Input power -5dBm) : ±1.80	
		dB	50MHz (Atten 40dB, Input power -5dBm) : ±1.80	
		dB	50MHz (Atten 50dB, Input power -5dBm) : ±1.80	
		dB	6GHz (Atten 0dB, Input power -25dBm) : ±1.80	
		dB	6GHz (Atten 10dB, Input power -25dBm) : ±1.80	
		dB	6GHz (Atten 20dB, Input power -25dBm) : ±1.80	
		dB	6GHz (Atten 30dB, Input power -5dBm) : ±1.80	
		dB	6GHz (Atten 40dB, Input power -5dBm) : ±1.80	
		dB	6GHz (Atten 50dB, Input power -5dBm) : ±1.80	
		dB	10GHz (Atten 0dB, Input power -25dBm) : ±1.80	
		dB	10GHz (Atten 10dB, Input power -25dBm) : ±1.80	
		dB	10GHz (Atten 20dB, Input power -25dBm) : ±1.80	
		dB	10GHz (Atten 30dB, Input power -5dBm) : ±1.80	
		dB	10GHz (Atten 40dB, Input power -5dBm) : ±1.80	
		dB	10GHz (Atten 50dB, Input power -5dBm) : ±1.80	
		dB	15GHz (Atten 0dB, Input power -25dBm) : ±2.30	
		dB	15GHz (Atten 10dB, Input power -25dBm) : ±2.30	
		dB	15GHz (Atten 20dB, Input power -25dBm) : ±2.30	
		dB	15GHz (Atten 30dB, Input power -5dBm) : ±2.30	
		dB	15GHz (Atten 40dB, Input power -5dBm) : ±2.30	
		dB	15GHz (Atten 50dB, Input power -5dBm) : ±2.30	
		dB	20GHz (Atten 0dB, Input power -25dBm) : ±2.30	
		dB	20GHz (Atten 10dB, Input power -25dBm) : ±2.30	
		dB	20GHz (Atten 20dB, Input power -25dBm) : ±2.30	
		dB	20GHz (Atten 30dB, Input power -5dBm) : ±2.30	
		dB	20GHz (Atten 40dB, Input power -5dBm) : ±2.30	
		dB	20GHz (Atten 50dB, Input power -5dBm) : ±2.30	
		dB	25GHz (Atten 0dB, Input power -25dBm) : ±2.30	
		dB	25GHz (Atten 10dB, Input power -25dBm) : ±2.30	
dB	25GHz (Atten 20dB, Input power -25dBm) : ±2.30			
dB	25GHz (Atten 30dB, Input power -5dBm) : ±2.30			
dB	25GHz (Atten 40dB, Input power -5dBm) : ±2.30			
dB	25GHz (Atten 50dB, Input power -5dBm) : ±2.30			

Table A.1 (continued 5) Schedule of Records of 4024D/E/F/G Spectrum Analyzer

S/N	Inspection item	Unit	Standards	Inspection result
19	Total level uncertainty	dB	32GHz (Atten 0dB, Input power -25dBm) :	±2.30
		dB	32GHz (Atten 10dB, Input power -25dBm) :	±2.30
		dB	32GHz (Atten 20dB, Input power -25dBm) :	±2.30
		dB	32GHz (Atten 30dB, Input power -5dBm) :	±2.30
		dB	32GHz (Atten 40dB, Input power -5dBm) :	±2.30
		dB	32GHz (Atten 50dB, Input power -5dBm) :	±2.30
		dB	40GHz (Atten 0dB, Input power -25dBm) :	±2.30
		dB	40GHz (Atten 10dB, Input power -25dBm) :	±2.30
		dB	40GHz (Atten 20dB, Input power -25dBm) :	±2.30
		dB	40GHz (Atten 30dB, Input power -5dBm) :	±2.30
		dB	40GHz (Atten 40dB, Input power -5dBm) :	±2.30
		dB	40GHz (Atten 50dB, Input power -5dBm) :	±2.30
		dB	500MHz (Atten 0dB, Input power -25dBm) :	±1.80
		dB	1.5GHz (Atten 0dB, Input power -25dBm) :	±1.80
		dB	2.5GHz (Atten 0dB, Input power -25dBm) :	±1.80
		dB	3.5GHz (Atten 0dB, Input power -25dBm) :	±1.80
		dB	4.5GHz (Atten 0dB, Input power -25dBm) :	±1.80
		dB	5.5GHz (Atten 0dB, Input power -25dBm) :	±1.80
		dB	6.5GHz (Atten 0dB, Input power -25dBm) :	±1.80
		dB	7.5GHz (Atten 0dB, Input power -25dBm) :	±1.80
		dB	8.5GHz (Atten 0dB, Input power -25dBm) :	±1.80
		dB	9.5GHz (Atten 0dB, Input power -25dBm) :	±1.80
		dB	10.5GHz (Atten 0dB, Input power -25dBm) :	±1.80
		dB	11.5GHz (Atten 0dB, Input power -25dBm) :	±1.80
		dB	12.5GHz (Atten 0dB, Input power -25dBm) :	±1.80
		dB	13.5GHz (Atten 0dB, Input power -25dBm) :	±2.30
		dB	14.5GHz (Atten 0dB, Input power -25dBm) :	±2.30
		dB	15.5GHz (Atten 0dB, Input power -25dBm) :	±2.30
		dB	16.5GHz (Atten 0dB, Input power -25dBm) :	±2.30
		dB	17.5GHz (Atten 0dB, Input power -25dBm) :	±2.30
		dB	18.5GHz (Atten 0dB, Input power -25dBm) :	±2.30
		dB	19.5GHz (Atten 0dB, Input power -25dBm) :	±2.30
		dB	20.5GHz (Atten 0dB, Input power -25dBm) :	±2.30
dB	21.5GHz (Atten 0dB, Input power -25dBm) :	±2.30		
dB	22.5GHz (Atten 0dB, Input power -25dBm) :	±2.30		
dB	23.5GHz (Atten 0dB, Input power -25dBm) :	±2.30		
dB	24.5GHz (Atten 0dB, Input power -25dBm) :	±2.30		
dB	25.5GHz (Atten 0dB, Input power -25dBm) :	±2.30		
dB	26.5GHz (Atten 0dB, Input power -25dBm) :	±2.30		
dB	27.5GHz (Atten 0dB, Input power -25dBm) :	±2.30		
dB	28.5GHz (Atten 0dB, Input power -25dBm) :	±2.30		

Table A.1 (continued 6) Schedule of Records of 4024D/E/F/G Spectrum Analyzer

S/N	Inspection item	Unit	Standards	Inspection result	
19	Total level uncertainty	dB	29.5GHz (Atten 0dB, Input power -25dBm) :	±2.30	
		dB	30.5GHz) (Atten 0dB, Input power -25dBm) :	±2.30	
		dB	31.5GHz (Atten 0dB, Input power -25dBm) :	±2.30	
		dB	32.5GHz (Atten 0dB, Input power -25dBm) :	±2.30	
		dB	33.5GHz (Atten 0dB, Input power -25dBm) :	±2.30	
		dB	34.5GHz (Atten 0dB, Input power -25dBm) :	±2.30	
		dB	35.5GHz (Atten 0dB, Input power -25dBm) :	±2.30	
		dB	36.5GHz (Atten 0dB, Input power -25dBm) :	±2.30	
		dB	37.5GHz (Atten 0dB, Input power -25dBm) :	±2.30	
		dB	38.5GHz (Atten 0dB, Input power -25dBm) :	±2.30	
		dB	39.5GHz (Atten 0dB, Input power -25dBm) :	±2.30	
20	Attenuator	Range	/	0~50dB, 10dB Step	
		Switching uncertainty	/	0dB Attenuation	Reference
			dB	10dB Attenuation	±1.20
			dB	20dB Attenuation 0dB	±1.20
			dB	30dB Attenuation	±1.20
			dB	40dB Attenuation	±1.20
			dB	50dB Attenuation	±1.20
21	Input voltage Standing wave ratio	/	10MHz~20GHz	≤1.80: 1	
		/	20GHz~ upper limit	≤2.20: 1	
22	Maximum safety input level	/	+30dBm (automatic coupling of CW and input attenuator)		
23	Display scale	/	0.1-10dB per division, with the minimum step of 0.1dB(10 division display)		
24	Video Bandwidth	/	Bandwidth range: 1Hz~ 10MHz (step: 1-3-10)		
25	Interface	Test interface	/	RF input port (depending on the interface type of the specific model)	
		Communication Interface	/	USB interface: A type, two	
			/	USB interface: mini type, one	
			/	LAN interface: RJ45 type	
		Freq. Ref.	/	10MHz Input/Output port, BNC(f) type	
		others	/	GPS interface: BNC(f) type	
			/	Trig IN interface: BNC(f) type	
/	IF Output interface: BNC(f) type				
26	Safety	/	Anti-electric strength AC 1500V, 10mA/min; no breakdown, no flashover.		
		/	242V, leakage Current: ≤3.5mA, 1min.		
		/	Insulation resistance between power in port and case must not below 100MΩ in standard atmospheric pressure and below 2MΩ in wet environment.		
Description	1. “√” indicates that the function is normal or complies with the requirements, while “X” indicates that the function is abnormal or does not comply with the requirements 2. “/” indicates that the item is not tested.				
Comprehensive judgment: Qualified <input type="checkbox"/> Disqualified <input type="checkbox"/>					

Table A.2 Schedule of Records of 4024A/B/C Spectrum Analyzer

S/N	Inspection item	Unit	Standards	Test result	
1	Design and structure	/	Structure type: Handheld		
		/	Appearance color: black		
		/	The instrument surface should be smooth with no burr, obvious mechanical damage or coating damage. The structure should be complete, with the controls installed properly and reliably and keys flexible to operate and connectors easy to plug in place.		
2	Function	/	Spectrum measurement		
		/	Power kit measurement		
		/	Audio demodulation		
		/	IQ capture		
3	Options	/	Interference Analyzer		
		/	Analog demodulation analysis		
		/	USB power measurement		
		/	Channel Scanner		
		/	Field strength measurement		
		/	GPS function		
		/	secure option		
		/	tracking Generator		
4	Frequency range	/	Lower limit	9kHz±21Hz	
		/	Upper limit	Upper limit of frequency±21Hz	
5	Frequency reading accuracy	kHz	1.0GHz (frequency span 500kHz):	±11.10	
		MHz	1.0GHz (frequency span 50MHz):	±1.03	
		MHz	1.0GHz (frequency span 500MHz):	±10.30	
		kHz	3.0GHz (frequency span 500kHz):	±12.70	
		MHz	3.0GHz (frequency span 50MHz):	±1.03	
		MHz	3.0GHz (frequency span 500MHz):	±10.30	
		kHz	3.5GHz (frequency span 500kHz):	±13.10	
		MHz	3.5GHz (frequency span 50MHz):	±1.03	
		MHz	3.5GHz (frequency span 500MHz):	±10.30	
		kHz	4.5GHz (frequency span 500kHz):	±13.90	
		MHz	4.5GHz (frequency span 50MHz):	±1.03	
		MHz	4.5GHz (frequency span 500MHz):	±10.30	
		kHz	6.0GHz (frequency span 500kHz):	±15.10	
		MHz	6.0GHz (frequency span 50MHz):	±1.03	
MHz	6.0GHz (frequency span 500MHz):	±10.30			

Note: This table applies to the normal temperature test of 4024A/B/C spectrum analyzer, and the contents may be modified depending on the specific model and option configuration, so as to adapt to actual test and inspection needs.

Table A.2 (continued 1) Schedule of Records of 4024A/B/C Spectrum Analyzer

S/N	Inspection item		Unit	Standards	Test result
5	Frequency reading accuracy		kHz	7.0GHz (frequency span 500kHz) :	±15.90
			MHz	7.0GHz (frequency span 50MHz) :	±1.03
			MHz	7.0GHz (frequency span 500MHz):	±10.30
			kHz	8.0GHz (frequency span 500kHz) :	±16.70
			MHz	8.0GHz (frequency span 50MHz) :	±1.03
			MHz	8.0GHz frequency span 500MHz):	±10.30
6	Span accuracy		/	1kHz	±2.0%
			/	10kHz	±2.0%
			/	100kHz	±2.0%
			/	1MHz	±2.0%
			/	10MHz	±2.0%
			/	100MHz	±2.0%
			/	1GHz	±2.0%
7	Sweep time	Range	/	10µs~600s (zero span)	
		Accuracy	/	1ms	±2.0%
	/		10ms	±2.0%	
	/		100ms	±2.0%	
	/		1s	±2.0%	
	/		10s	±2.0%	
8	Resolution bandwidth accuracy		/	10MHz	±10.0%
			/	3MHz	±10.0%
			/	1MHz	±10.0%
			/	300kHz	±10.0%
			/	100kHz	±10.0%
			/	30kHz	±10.0%
			/	10kHz	±10.0%
			/	3kHz	±10.0%
			/	1kHz	±10.0%
9	Resolution Bandwidth Conversion uncertainty		dB	10MHz	±1.20
			dB	3MHz	±1.20
			dB	1MHz	±1.20
			dB	300kHz	±1.20
			/	100kHz	Reference
			dB	30kHz	±1.20
			dB	10kHz	±1.20
			dB	3kHz	±1.20
			dB	1kHz	±1.20
			dB	300Hz	±1.20

Table A.2 (continued 2) Schedule of Records of 4024A/B/C Spectrum Analyzer

S/N	Inspection item		Unit	Standards	Inspection	
9	Resolution BandwidthConversion uncertainty		dB	100Hz	±1.20	
			dB	30Hz	±1.20	
			dB	10Hz	±1.20	
			dB	3Hz	±1.20	
			dB	1Hz	±1.20	
10	Sideband noise (carrier 1GHz)		dBc/Hz	+10kHz	≤-108	
			dBc/Hz	-10kHz	≤-108	
			dBc/Hz	+100kHz	≤-112	
			dBc/Hz	-100kHz	≤-112	
			dBc/Hz	+1MHz	≤-118	
			dBc/Hz	-1MHz	≤-118	
			dBc/Hz	+10MHz	≤-129	
			dBc/Hz	-10MHz	≤-129	
11	Display average noise level		dBm	2MHz~10MHz (Pre-amplifier On)	≤-150	
			dBm	10MHz~3GHz (Pre-amplifier On)	≤-160	
			dBm	3GHz~9GHz (Pre-amplifier On)	≤-157	
			dBm	2MHz~10MHz(Pre-amplifier Off)	≤-135	
			dBm	10MHz~3GHz (Pre-amplifier Off)	≤-140	
			dBm	3GHz~9GHz (Pre-amplifier Off)	≤-138	
12	Second harmonic distortion		dBc	<1.2GHz	<-65	
			dBc	1.2GHz~2GHz	<-65	
			dBc	2GHz~2.6GHz	<-65	
			dBc	2.6GHz~4.5GHz	<-65	
13	3-order intermodulation		dBm	50MHz~2.4GHz	≥+10	
			dBm	2.4GHz~4GHz	≥+10	
			dBm	4GHz~5.2GHz	≥+10	
			dBm	5.2GHz~9GHz	≥+10	
14	1dB gain compression		dBm	50MHz~2.4GHz	≥+2	
			dBm	2.4GHz~4GHz	≥+2	
			dBm	4GHz~5.2GHz	≥+2	
			dBm	5.2GHz~9.0GHz	≥+2	
15	Image, multiple and out-of-band response	2GHz	dBc	Image frequency 8680.5MHz	<-65	
			dBc	Image frequency 2280.5MHz	<-65	
		3.5GHz	dBc	Image frequency 6980.5MHz	<-65	
			dBc	Image frequency 3780.5MHz	<-65	
		5GHz	dBc	Image frequency 5280.5MHz	<-65	
		7GHz	dBc	Image frequency 7280.5MHz	<-65	

Table A.2 (continued 3) Schedule of Records of 4024A/B/C Spectrum Analyzer

S/N	Inspection item	Unit	Standards	Inspection result	
16	Residual response	dBm	10MHz~9GHz (Pre-amplifier On) ≤ -95		
		dBm	10MHz~9GHz (Pre-amplifier Off) ≤ -82		
17	Range	/	Log type: -120dBm~+30dBm, 1dB step Linear scale: 22.36uV~7.07V, 0.1% step		
		/	0dBm Reference		
	Conversion error	dB	-10dBm	± 1.20	
		dB	-20dBm	± 1.20	
		dB	-30dBm	± 1.20	
		dB	-40dBm	± 1.20	
		dB	-50dBm	± 1.20	
		dB	-60dBm	± 1.20	
18	Scale fidelity	dB	-10dBm	± 1.00	
		dB	-20dBm	± 1.00	
		dB	-30dBm	± 1.00	
		dB	-40dBm	± 1.00	
		dB	-50dBm	± 1.00	
		dB	-60dBm	± 1.00	
19	Total level uncertainty	dB	50MHz (Atten 0dB, Input power -25dBm) : ± 1.80		
		dB	50MHz (Atten 10dB, Input power -25dBm) : ± 1.80		
		dB	50MHz (Atten 20dB, Input power -25dBm) : ± 1.80		
		dB	50MHz (Atten 30dB, Input power -5dBm) : ± 1.80		
		dB	2000MHz (Atten 0dB, Input power -25dBm) : ± 1.80		
		dB	2000MHz (Atten 10dB, Input power -25dBm) : ± 1.80		
		dB	2000MHz (Atten 20dB, Input power -25dBm) : ± 1.80		
		dB	2000MHz (Atten 30dB, Input power -5dBm) : ± 1.80		
		dB	3000MHz (Atten 0dB, Input power -25dBm) : ± 1.80		
		dB	3000MHz (Atten 10dB, Input power -25dBm) : ± 1.80		
		dB	3000MHz (Atten 20dB, Input power -25dBm) : ± 1.80		
		dB	3000MHz (Atten 30dB, Input power -5dBm) : ± 1.80		
		dB	4000MHz (Atten 0dB, Input power -25dBm) : ± 1.80		
		dB	4000MHz (Atten 10dB, Input power -25dBm) : ± 1.80		
		dB	4000MHz (Atten 20dB, Input power -25dBm) : ± 1.80		
		dB	4000MHz (Atten 30dB, Input power -5dBm) : ± 1.80		
		dB	5000MHz (Atten 0dB, Input power -25dBm) : ± 1.80		
		dB	5000MHz (Atten 10dB, Input power -25dBm) : ± 1.80		
		dB	5000MHz (Atten 20dB, Input power -25dBm) : ± 1.80		
		dB	5000MHz (Atten 30dB, Input power -5dBm) : ± 1.80		
dB	6000MHz (Atten 0dB, Input power -25dBm) : ± 1.80				

Table A.2 (continued 4) Schedule of Records of 4024A/B/C Spectrum Analyzer

S/N	Inspection item	Unit	Standards	Inspection result
19	Total level uncertainty	dB	6000MHz (Atten 10dB, Input power -25dBm) :	± 1.80
		dB	6000MHz (Atten 20dB, Input power -25dBm) :	± 1.80
		dB	6000MHz (Atten 30dB, Input power -5dBm) :	± 1.80
		dB	7000MHz (Atten 0dB, Input power -25dBm) :	± 1.80
		dB	7000MHz (Atten 10dB, Input power -25dBm) :	± 1.80
		dB	7000MHz (Atten 20dB, Input power -25dBm) :	± 1.80
		dB	7000MHz (Atten 30dB, Input power -5dBm) :	± 1.80
		dB	8500MHz (Atten 0dB, Input power -25dBm) :	± 1.80
		dB	8500MHz (Atten 10dB, Input power -25dBm) :	± 1.80
		dB	8500MHz (Atten 20dB, Input power -25dBm) :	± 1.80
		dB	8500MHz (Atten 30dB, Input power -5dBm) :	± 1.80
		dB	350MHz (Atten 0dB, Input power -25dBm) :	± 1.80
		dB	650MHz (Atten 0dB, Input power -25dBm) :	± 1.80
		dB	950MHz (Atten 0dB, Input power -25dBm) :	± 1.80
		dB	1250MHz (Atten 0dB, Input power -25dBm) :	± 1.80
		dB	1550MHz (Atten 0dB, Input power -25dBm) :	± 1.80
		dB	1850MHz (Atten 0dB, Input power -25dBm) :	± 1.80
		dB	2150MHz (Atten 0dB, Input power -25dBm) :	± 1.80
		dB	2450MHz (Atten 0dB, Input power -25dBm) :	± 1.80
		dB	2750MHz (Atten 0dB, Input power -25dBm) :	± 1.80
		dB	3050MHz (Atten 0dB, Input power -25dBm) :	± 1.80
		dB	3350MHz (Atten 0dB, Input power -25dBm) :	± 1.80
		dB	3650MHz (Atten 0dB, Input power -25dBm) :	± 1.80
		dB	3850MHz (Atten 0dB, Input power -25dBm) :	± 1.80
		dB	4150MHz (Atten 0dB, Input power -25dBm) :	± 1.80
		dB	4450MHz (Atten 0dB, Input power -25dBm) :	± 1.80
		dB	4750MHz (Atten 0dB, Input power -25dBm) :	± 1.80
		dB	5050MHz (Atten 0dB, Input power -25dBm) :	± 1.80
		dB	5350MHz (Atten 0dB, Input power -25dBm) :	± 1.80
		dB	5650MHz (Atten 0dB, Input power -25dBm) :	± 1.80
		dB	5850MHz (Atten 0dB, Input power -25dBm) :	± 1.80
		dB	6150MHz (Atten 0dB, Input power -25dBm) :	± 1.80
		dB	6450MHz (Atten 0dB, Input power -25dBm) :	± 1.80
		dB	6750MHz (Atten 0dB, Input power -25dBm) :	± 1.80
		dB	7050MHz (Atten 0dB, Input power -25dBm) :	± 1.80
		dB	7350MHz (Atten 0dB, Input power -25dBm) :	± 1.80
dB	7650MHz (Atten 0dB, Input power -25dBm) :	± 1.80		
dB	7850MHz (Atten 0dB, Input power -25dBm) :	± 1.80		
dB	8150MHz (Atten 0dB, Input power -25dBm) :	± 1.80		
dB	8450MHz (Atten 0dB, Input power -25dBm) :	± 1.80		
dB	8750MHz (Atten 0dB, Input power -25dBm) :	± 1.80		
dB	9000MHz (Atten 0dB, Input power -25dBm) :	± 1.80		

Table A.2 (continued 5) Schedule of Records of 4024A/B/C Spectrum Analyzer

S/N	Inspection item		Unit	Standards	Inspection result	
20	Attenuator	Range	/	0~30dB, 5dB Step		
		Switching uncertainty (50MHz)	/	0dB Attenuation	Reference	
			dB	5dB Attenuation	±1.20	
			dB	10dB Attenuation	±1.20	
			dB	15dB Attenuation	±1.20	
			dB	20dB Attenuation	±1.20	
			dB	25dB Attenuation	±1.20	
			dB	30dB Attenuation	±1.20	
		Switching uncertainty (6GHz)	/	0dB Attenuation	Reference	
			dB	5dB Attenuation	±1.20	
			dB	10dB Attenuation	±1.20	
			dB	15dB Attenuation	±1.20	
			dB	20dB Attenuation	±1.20	
			dB	25dB Attenuation	±1.20	
dB	30dB Attenuation		±1.20			
21	Input voltage		/	10MHz~5.2GHz	≤2.00: 1	
	Standing wave ratio		/	5.2GHz~9GHz	≤2.00: 1	
22	Maximum safety input level		/	+27dBm (automatic coupling of CW and input attenuator)		
23	Display scale		/	0.1-10dB per division, with the minimum step of 0.1dB(10 division display)		
24	Video Bandwidth		/	Bandwidth range: 1Hz~10MHz (step: 1-3-10)		
25	Interface	RF interface	/	type N (f)		
		Communication Interface	/	USB interface: A type, two		
			/	USB interface: mini type, one		
			/	LAN interface: RJ45 type		
		Freq. Ref.	/	10MHz Input/Output port, BNC(f) type		
		others	/	GPS interface: BNC(f) type		
			/	Trig IN interface: BNC(f) type		
/	IF Output interface: BNC(f) type					
26	Safety		/	Anti-electric strength AC 1500V, 10mA/min; no breakdown, no flashover.		
			/	242V, leakage Current: ≤3.5mA, 1min.		
			/	Insulation resistance between power in port and case must not below 100MΩ in standard atmospheric pressure and below 2MΩ in wet environment.		
Description	1. “√” indicates that the function is normal or complies with the requirements, while “X” indicates that the function is abnormal or does not comply with the requirements 2. “/” indicates that the item is not tested.					
Comprehensive judgment: Qualified <input type="checkbox"/> Disqualified <input type="checkbox"/>						

Table A.3 Schedule of Records of 4024 Spectrum Analyzer (tracking Generator option)

S/N	Inspection item	Unit	Standards	Inspection result
1	frequency Range	kHz	Lower limit 100kHz	
		GHz	Upper limit Upper limit of frequency	
2	frequency accuracy	Hz	100MHz ±80.00	
		kHz	1000MHz ±0.80	
		kHz	2000MHz ±1.60	
		kHz	4000MHz ±3.20	
		kHz	6000MHz ±4.80	
		kHz	9000MHz ±7.20	
3	Sideband noise (carrier 1GHz)	dBc/Hz	+10kHz ≤-90	
		dBc/Hz	-10kHz ≤-90	
		dBc/Hz	+100kHz ≤-95	
		dBc/Hz	-100kHz ≤-95	
		dBc/Hz	+1MHz ≤-110	
		dBc/Hz	-1MHz ≤-110	
4	amplitude Range	/	Range :0dBm~-40dBm, with the minimum resolution of 0.1dB	
5	Amplitude accuracy	dB	50MHz, 0dBm out ±2.50	
		dB	50MHz, -5dBm out ±2.50	
		dB	50MHz, -10dBm out ±2.50	
		dB	50MHz, -20dBm out ±2.50	
		dB	50MHz, -30dBm out ±2.50	
		dB	50MHz, -40dBm out ±2.50	
		dB	1200MHz, 0dBm out ±2.50	
		dB	1200MHz, -5dBm out ±2.50	
		dB	1200MHz, -10dBm out ±2.50	
		dB	1200MHz, -20dBm out ±2.50	
		dB	1200MHz, -30dBm out ±2.50	
		dB	1200MHz, -40dBm out ±2.50	
		dB	2000MHz, 0dBm out ±2.50	
		dB	2000MHz, -5dBm out ±2.50	
		dB	2000MHz, -10dBm out ±2.50	
		dB	2000MHz, -20dBm out ±2.50	
		dB	2000MHz, -30dBm out ±2.50	
		dB	2000MHz, -40dBm out ±2.50	
		dB	4000MHz, 0dBm out ±2.50	
		dB	4000MHz, -5dBm out ±2.50	
dB	4000MHz, -10dBm out ±2.50			

Table A.3 (continued 1) Schedule of Records of 4024 Spectrum Analyzer (tracking Generator option)

S/N	Inspection item	Unit	Standards	Inspection result
5	amplitude accuracy	dB	4000MHz, -20dBm out	±2.50
		dB	4000MHz, -30dBm out	±2.50
		dB	4000MHz, -40dBm out	±2.50
		dB	6000MHz, 0dBm out	±2.50
		dB	6000MHz, -5dBm out	±2.50
		dB	6000MHz, -10dBm out	±2.50
		dB	6000MHz, -20dBm out	±2.50
		dB	6000MHz, -30dBm out	±2.50
		dB	6000MHz, -40dBm out	±2.50
		dB	7500MHz, 0dBm out	±2.50
		dB	7500MHz, -5dBm out	±2.50
		dB	7500MHz, -10dBm out	±2.50
		dB	7500MHz, -20dBm out	±2.50
		dB	7500MHz, -30dBm out	±2.50
		dB	7500MHz, -40dBm out	±2.50
		dB	9000MHz, 0dBm out	±2.50
		dB	9000MHz, -5dBm out	±2.50
		dB	9000MHz, -10dBm out	±2.50
		dB	9000MHz, -20dBm out	±2.50
		dB	9000MHz, -30dBm out	±2.50
dB	9000MHz, -40dBm out	±2.50		
6	harmonic distortion	dBc	100MHz, 0dBm out	<-15
		dBc	900MHz, 0dBm out	<-15
		dBc	1500MHz, 0dBm out	<-25
		dBc	2000MHz, 0dBm out	<-25
		dBc	4000MHz, 0dBm out	<-25
		dBc	6000MHz, 0dBm out	<-15
		dBc	8000MHz, 0dBm out	<-15