

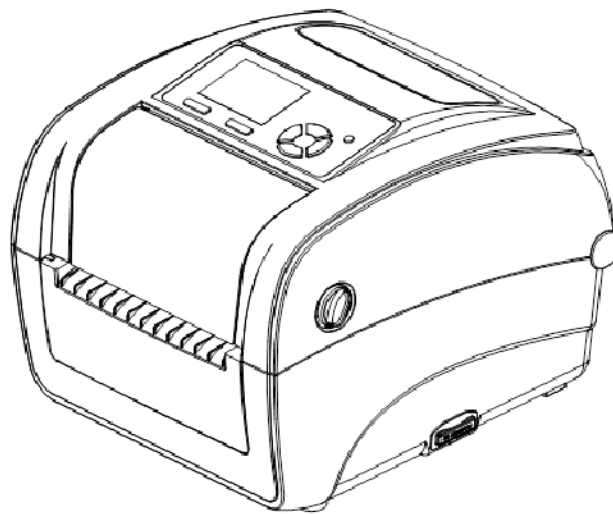

BBP12

Thermal Transfer Printer

User Guide



Contents

- CHAPTER 1 Introduction5**
 - Product Introduction.....5
 - Compliance5
- CHAPTER 2 Operations Overview.....6**
 - Unpacking and Inspection6
 - Printer Overview.....7
- CHAPTER 3 Setup10**
 - Setting Up the Printer10
 - Open / Close the Top Cover.....11
 - Loading the Ribbon.....12
 - Loading the Media15
 - Diagnostic Tool20
 - Install SD Memory Card.....21
- CHAPTER 4 LED and Button Functions.....26**
 - LED Indicator26
 - Regular Button Function26
 - Power on Utilities27
- CHAPTER 5 LCD Menu Function35**
 - Enter the Menu.....35
 - Main Menu Overview36
 - TSPL237
 - ZPL2.....39
 - Sensor42
 - Interface43
 - File Manager46
 - Diagnostics.....47
 - Advanced51
 - Service52
- CHAPTER 6 Troubleshooting53**
 - LED Status.....53
 - Print Quality.....54
- CHAPTER 7 Maintenance55**

Copyright

This manual is copyrighted with all rights reserved. No portion of this manual may be copied or reproduced by any means without the prior consent of **Brady Worldwide, Inc.**

While every precaution has been taken in preparation of this document, **Brady** assumes no liability to any party for any loss or damage caused by errors or omissions or by statements resulting from negligence, accident, or any other cause. **Brady** further assumes no liability arising out of the application or use of any product or system described, herein; nor any liability for incidental or consequential damages arising from the use of this document. **Brady** disclaims all warranties of merchantability or fitness for a particular purpose.

Brady reserves the right to make changes without further notice to any product or system herein to improve reliability, function, or design.

Reproduction of this material, in part or whole, is strictly prohibited without the written permission of **Brady Worldwide, Inc.** For more information, contact: **Brady Worldwide, Inc.** Signmark® Division, 2221 W. Camden Road, Milwaukee, WI 53209.

Disclaimer

Every effort has been made to make this guide as accurate and complete as possible. **Brady Worldwide, Inc.** is not responsible for inaccuracies and omissions occurring during the use of this guide.

This manual is proprietary to **Brady Worldwide, Inc.** and may be revised from time to time without notice. **Brady Worldwide, Inc.** disclaims any understanding to provide you with revisions, if any.

All brand or product names referenced in this manual are trademarks or registered trademarks of their respective companies or organizations.

© 2015 Brady Worldwide, Inc. All rights reserved.

www.bradycorp.com

Edition 05/15



Identification Solutions Division
PO Box 2131
Milwaukee, WI 53201 U.S.A.
Phone: 1-800-537-8791 Fax: 1-800-292-2289

Revision History

Date	Content

CHAPTER 1 Introduction

Product Introduction

Thank you for purchasing the **BRADY BBP12** series bar code printer. Although the printer is small, it delivers reliable, superior performance.

This printer provides both thermal transfer and direct thermal printing at user-selectable speeds of 2.0, 3.0 or 4.0 ips. It accepts roll feed, die-cut, and fan-fold labels for both thermal transfer and direct thermal printing. All common bar codes formats are available. Fonts and bar codes can be printed in 4 directions, 8 different alphanumeric bitmap fonts and built-in true type font capability. You will enjoy high throughput for printing labels with this printer.

Compliance

FCC Class B,
CE Class B,
C-Tick Class B,
UL, cUL,
TÜV/safety,
CCC,
EAC,
NOM

Note:

Continuous printing will cause printer motor overheat. Printer will stop printing automatically about 10~15 minutes until motor is cooled down. Do not turn off power when printer pauses or the data transferred to printer buffer will be lost.

Note:

The maximum printing ratio per dot line is 15% for this printer. To print the full web black line, the maximum black line height is limited to 40 dots, which is 3.3 mm for 300 dpi resolution printer.

CHAPTER 2 Operations Overview

Unpacking and Inspection

This printer has been specially packaged to withstand damage during shipping. Please carefully inspect the packaging and printer upon receiving the bar code printer. Retain the packaging materials in case you need to reship the printer.

Unpacking the Printer

The following items are included in the carton:

- (1) Printer unit
- (1) Product CD, including drivers
- (1) Quick installation guide
- (1) Power cord
- (1) Auto switching power supply
- (1) USB interface cable
- (1) Adapter (for narrow continuous sleeves)

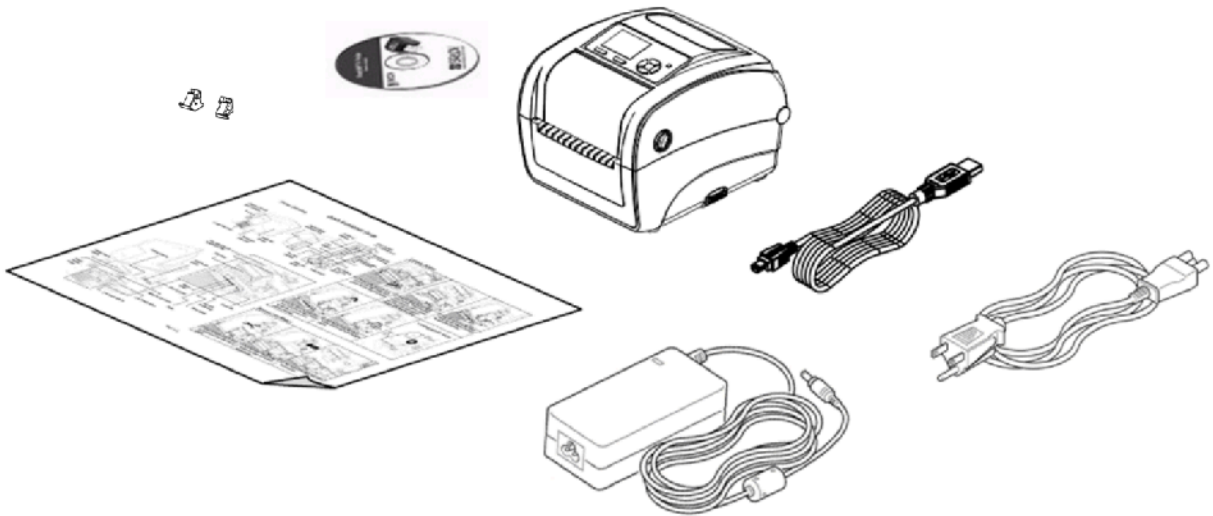

If any parts are missing, please contact customer service.

Printer Overview

Front View



1. LCD display
2. Menu button
3. Feed button
4. LED indicator
5. Navigation button
6. Ribbon access cover
7. Top cover open lever
8. SD card socket

Interior View

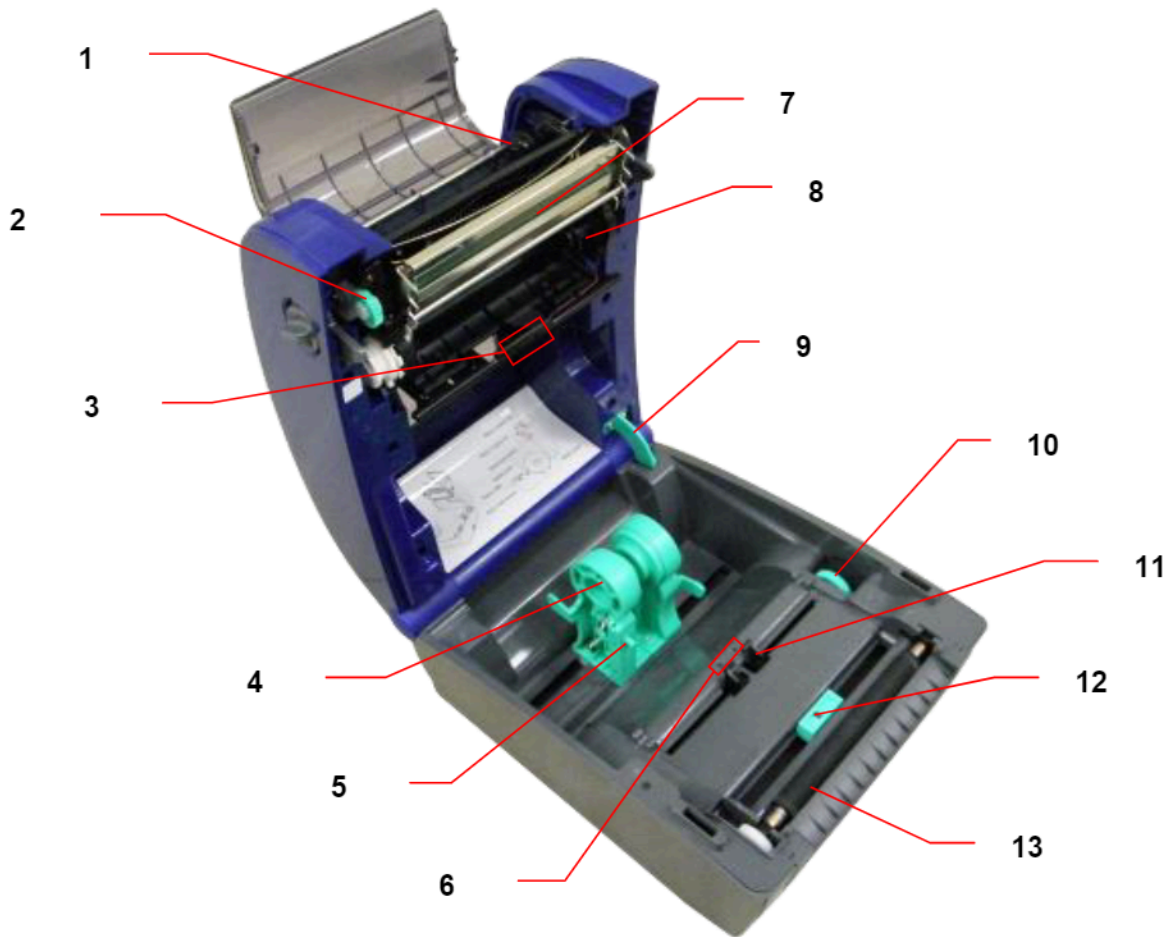

1. Ribbon rewind hub
2. Ribbon rewind gear
3. Gap sensor (receiver)
4. Media holder
5. Media holder lock switch
6. Gap sensor (transmitter)
7. Printhead
8. Ribbon supply hub
9. Top cover support
10. Media guide adjustment knob
11. Media guide
12. Black mark sensor
13. Platen roller

Rear View

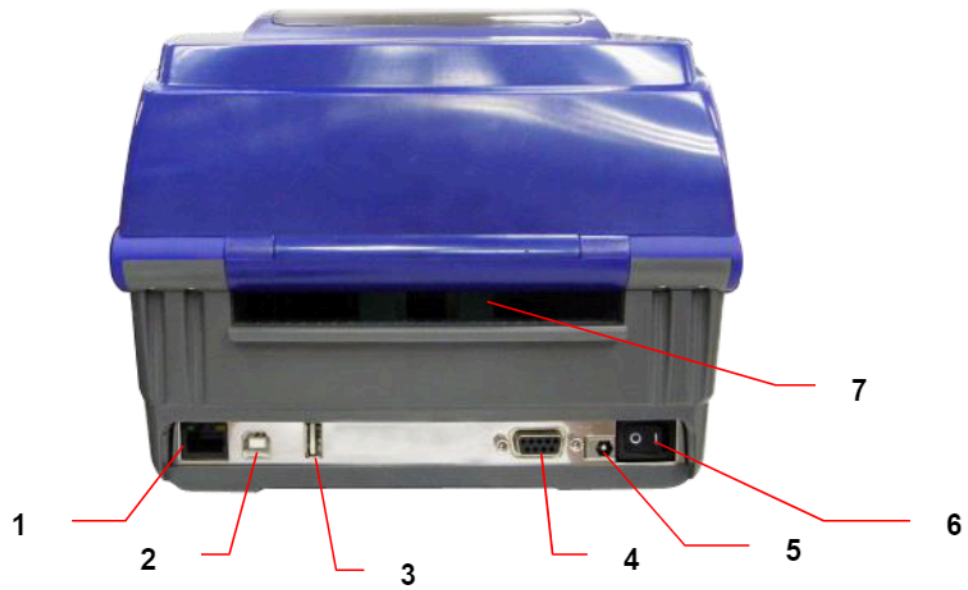

1. **Ethernet interface**
2. **USB interface**
3. **USB host interface**
4. **Serial/COM interface**
5. **Power jack socket**
6. **Power switch**
7. **Fan-fold paper entrance chute**

CHAPTER 3 Setup

Setting up the Printer

1. Place the printer on a flat, secure surface.
2. Make sure the power switch is off.
3. Connect the printer to the computer with the provided USB cable.
4. Plug the power cord into the AC power cord socket at the rear of the printer, and then plug the power cord into a properly grounded power outlet.

Note:

Please switch OFF printer power switch prior to plug in the power cord to printer power jack.

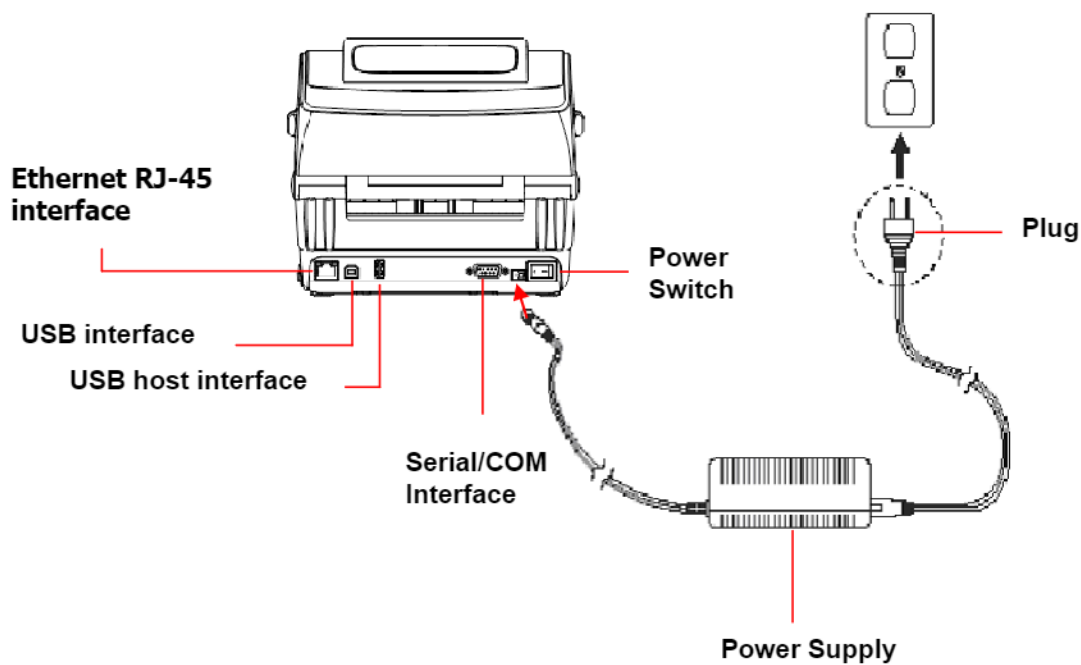

Open / Close the Top Cover

1. Open the printer top cover by pulling the grey tabs located on each side toward the front of the printer, then lift the top cover to the maximum open angle.



2. A top cover support at the rear of the printer will engage with lower inner cover to hold the printer top cover open.

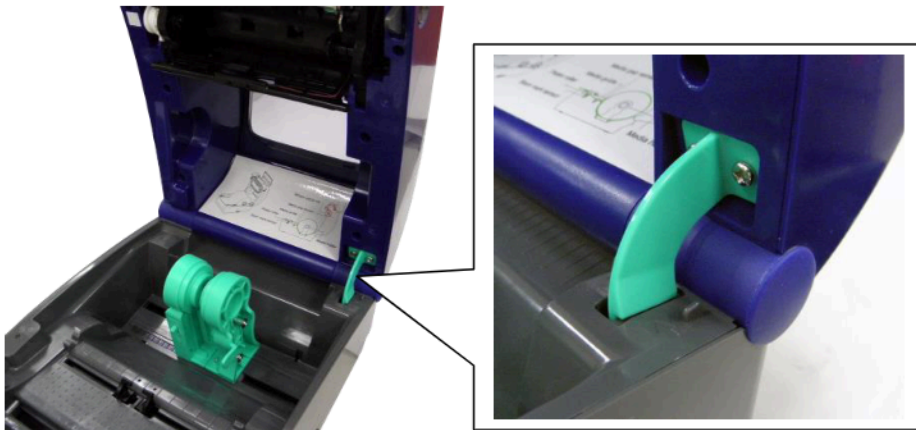

3. Hold the top cover and press the top cover support to disengage the top cover support with lower inner cover. Gently close the top cover.



Loading the Ribbon

1. Open the top cover on the printer by pulling the green open levers located on each side of the printer and lifting the top cover to the maximum open angle.
2. Open the ribbon access cover.



Note: In normal print mode, the ribbon access cover can be opened while opening the top cover. The ribbon access cover can be closed while the top cover is open or closed.

3. Insert the right side of the ribbon right onto the supply hub. Align the notches on the left side and mount onto the spokes.

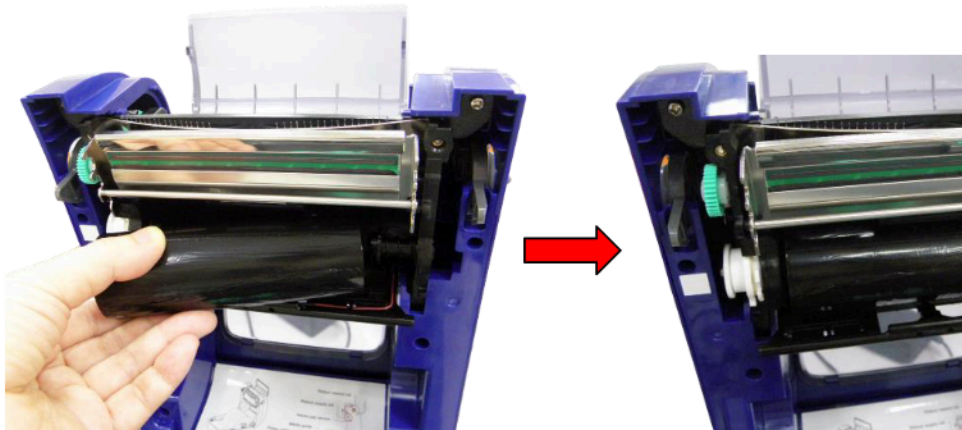

4. Insert the right side of the paper core onto the rewind hub. Align the notches on the left side and mount onto the spokes.

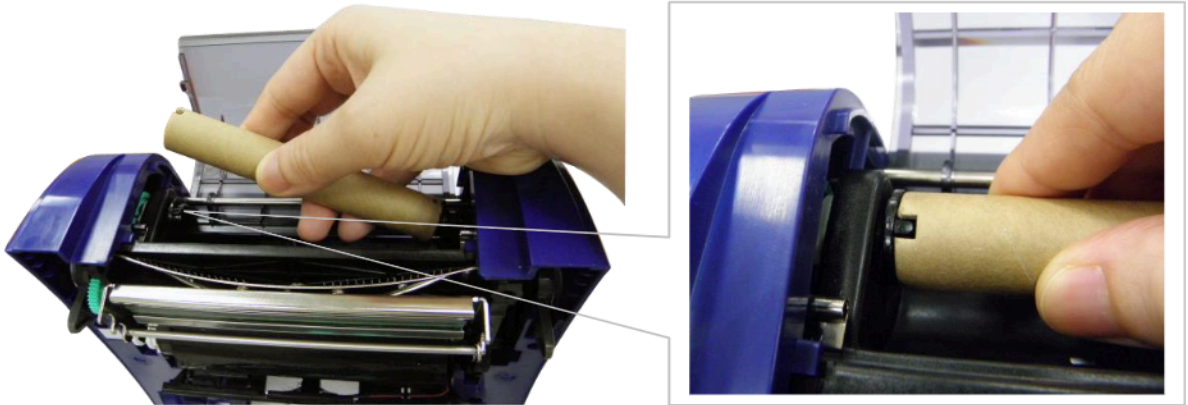

5. Attach the ribbon leader onto the ribbon rewind paper core.

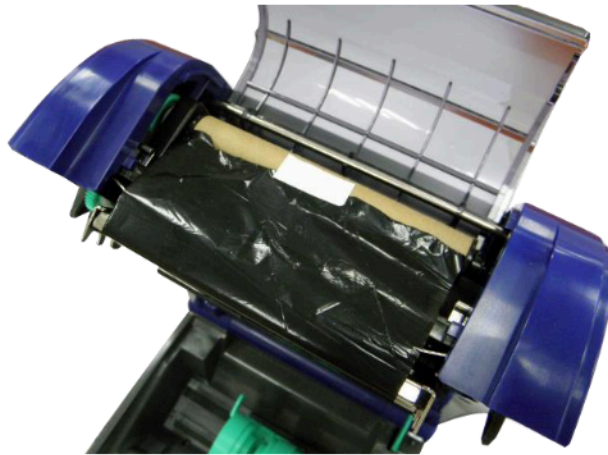

6. Turn the ribbon rewind gear until the plastic ribbon leader is thoroughly wound and the black section of the ribbon covers the print head.

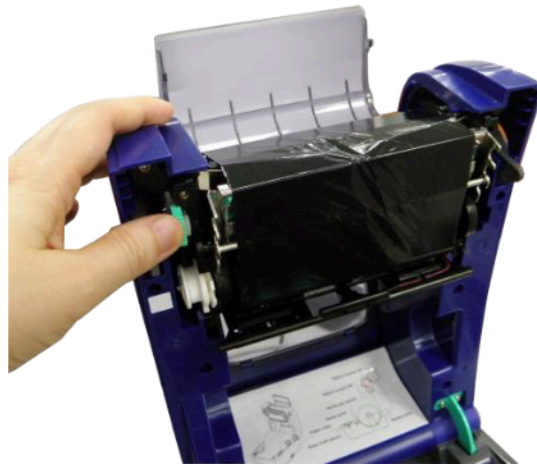

7. Close the ribbon access cover and the top cover.

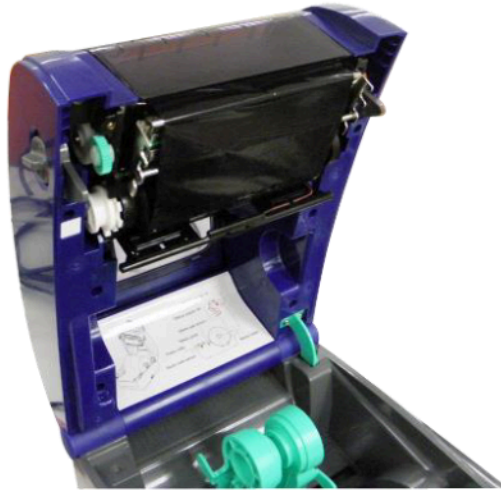

Ribbon Loading Path

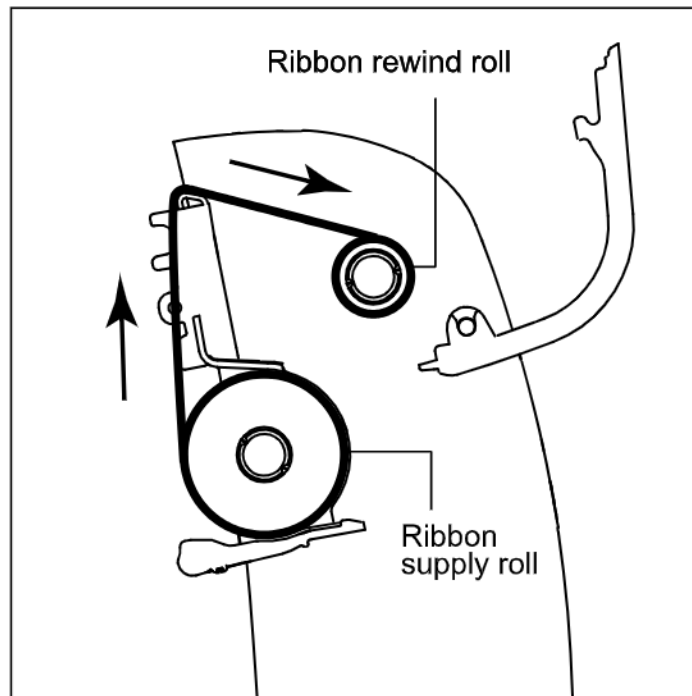

Loading the Media

Loading Media

1. Open the printer top cover by pulling the grey tabs, located on each side, toward the front of the printer, then lift the top cover to the maximum open angle.
2. Separate and hold open the media holders.

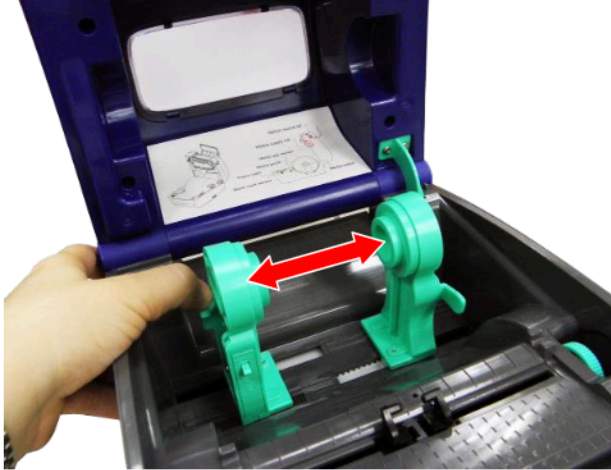

3. Place the roll between the holders and close them onto the core.

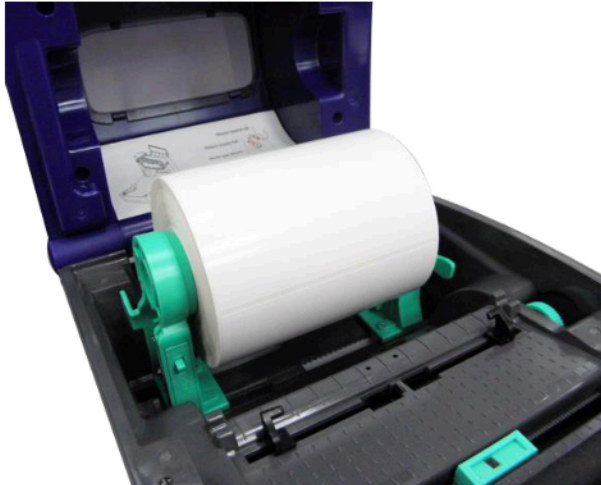

4. Set the media holder lock switch to **Lock** (down) to hold the label roll firmly.



5. **Optional:** If using either an external media holder or folded labels, feed the media through the rear external label entrance chute.
6. Place the paper, print side face up, through the media sensor.
7. Place the label leading edge onto the platen roller.
8. Move the media guides to fit the label width by turning the guide adjuster knob.



9. Disengage the top cover support and close the top cover gently.



10. Use the **Diagnostic Tool or LCD menu** to set the media sensor type and calibrate the selected sensor (see the diagnostic utility quick start guide for more information):
 - a. Start **Diagnostic tool**.

- b. Select sensor on **Calibration** tab.
- c. Click **Calibrate** button.

Note: Please calibrate the gap/black mark sensor when changing media.

Loading Path for Roll Labels

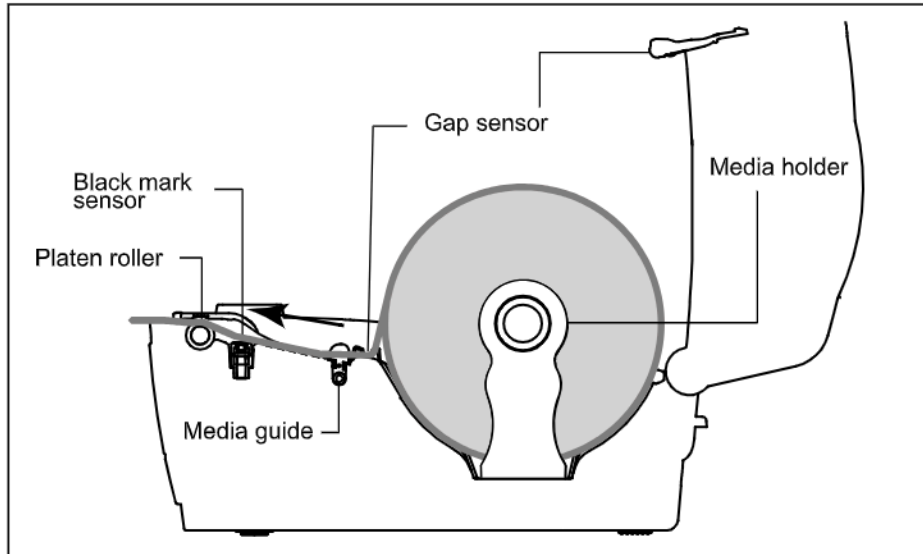

External Label Roll Mount Installation (Option)

1. Attach an external paper roll mount on the bottom of the printer.

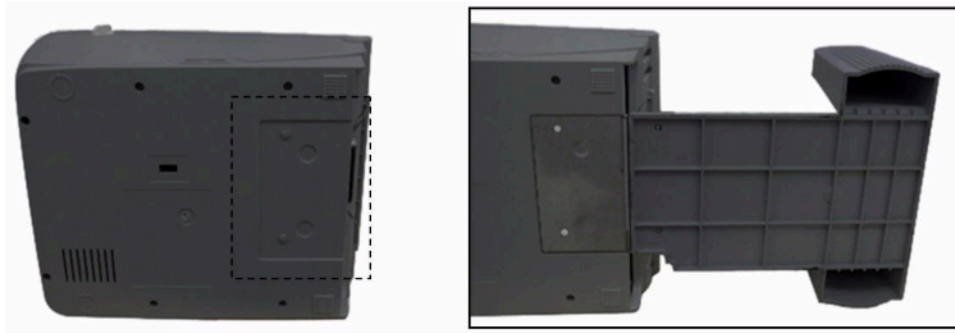

2. Insert a label spindle into a paper roll and install it on the external paper roll mount.
3. Open the top cover and separate the media holders to fit the media width.
4. Press down the media holder lock switch to fix the media holder.

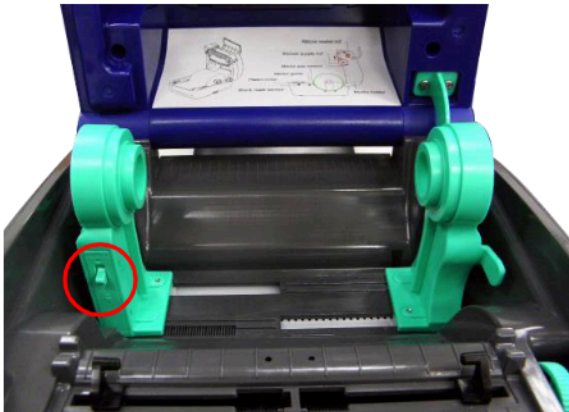

5. Feed the media through the rear external label entrance chute:
 - a. Place the paper, print side face up, through the media sensor.
 - b. Place the label leading edge onto the platen roller.



6. Move the media guides to fit the label width by turning the guide adjuster knob.
7. Disengage the top cover support and close the top cover gently.



8. Use the **Diagnostic Tool or LCD menu** to set the media sensor type and calibrate the selected sensor.
 - a. Start **Diagnostic tool**.
 - b. Select sensor on **Calibration** tab.
 - c. Click **Calibrate** button.

Diagnostic Tool

The Diagnostic Utility is a toolbox that lets users explore the printer's settings and status; change printer settings; download graphics, fonts, and firmware; create printer bitmap fonts; and to send additional commands to the printer. Using this convenient tool, you can explore the printer status and settings and troubleshoot the printer.

Start the Diagnostic Tool

1. To start the software, double click the **Diagnostic** tool icon.

Note: The diagnostic tool is located at **D:\DiagTool**.

2. Select the PC interface connected with bar code printer.

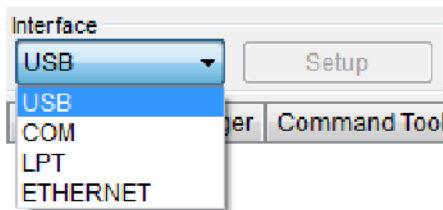

- Default setting is USB interface. No further setting is required.
- If RS-232 port is selected, further setup is required to select the serial port, baud rate, parity check, data bits, stop bit and flow control.

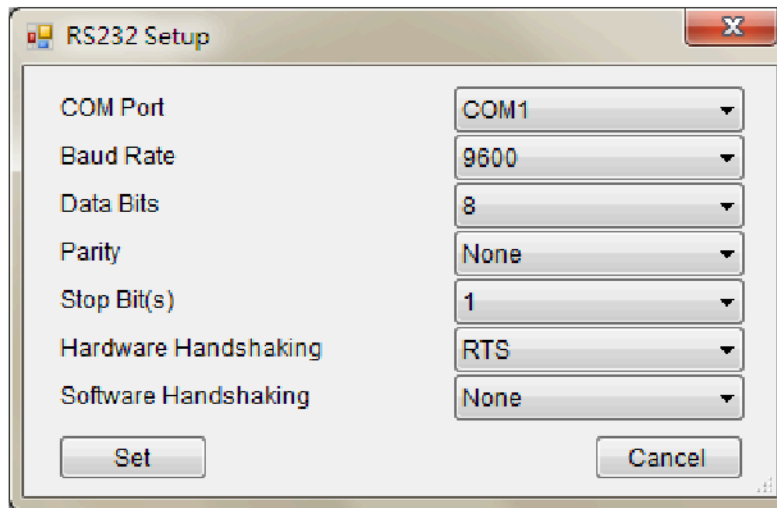

- If Ethernet is selected, need to select the bar code printer.

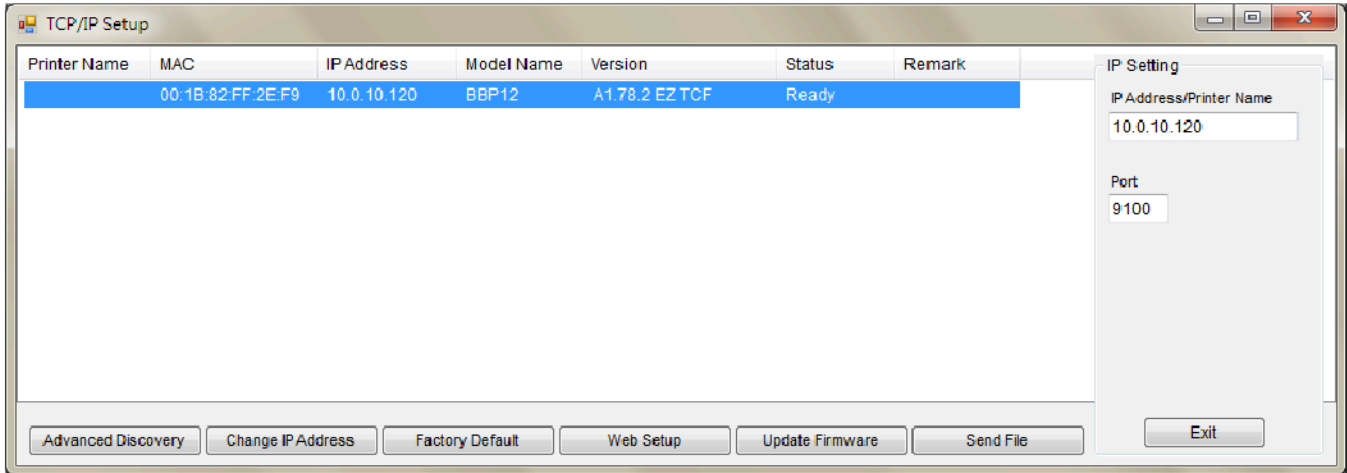

3. There are 7 features included in the *Diagnostic* utility.

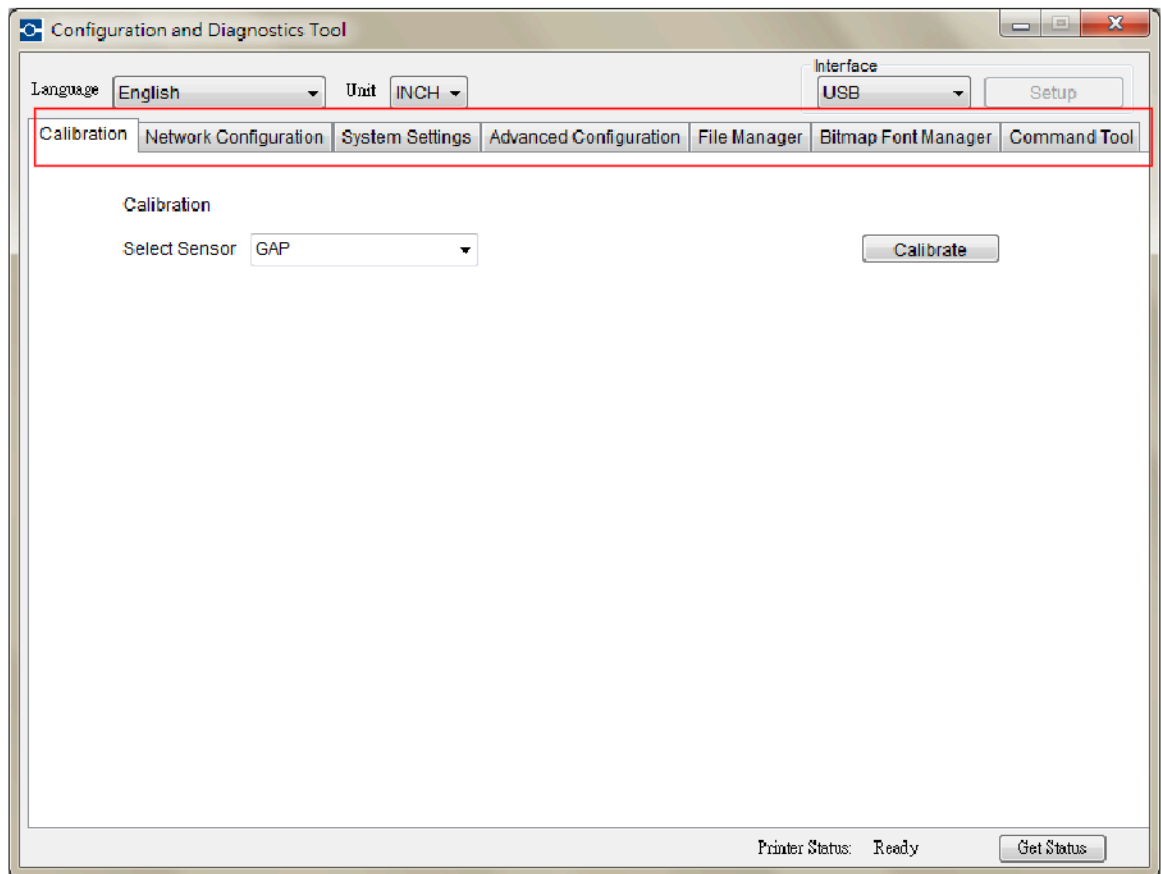

- Calibration:
This feature uses to calibrate the media sensor.

Calibration

Select Sensor GAP Calibrate

GAP

Black Mark

Continuous

Auto Selection

- Network Configuration:
This feature uses to setup the IP address, subnet mask, gateway for the on board Ethernet

Network Configuration

Static IP Address IP Address

Dynamic IP Address Subnet Mask

Gateway

Set

- System Settings:
This feature uses to setup the RTC, Initialize the printer, reboot printer, print a test page or print printer configuration.

Clock Configuration

YYYY
MM
DD
HH
MM
Set

General Options

Factory Default
Reset Printer
Print Test Page
Print Config Page

- Advanced configuration:
This feature uses to explore/configure the printer settings. The common setting tab includes the settings that commonly used for TSPL/EPL2/ZPL/DPL printer languages.

The screenshot shows a software interface for printer configuration. On the left, under 'Printer Function', there are buttons for 'Advanced Calibration', 'Dump Text', 'Ignore AUTO.BAS', 'Exit Line Mode', and 'Password Setup'. The main area is 'Printer Information', which includes fields for 'Version', 'Serial No', 'Check Sum', 'Cutting Counter', and 'Mileage'. Below this is a 'Common' section with tabs for 'Z' and 'D'. The 'Z' tab is active, showing various settings: Speed, Density, Paper Width (0.00 mm), Paper Height (0.00 mm), Media Sensor, Gap (0.00 mm), Gap Offset (0.00 mm), Post-Print Action, Cut Piece, Gap Inten., Bline Inten., Continuous Inten., and Threshold Detection. On the right side of the 'Z' tab, there are settings for Code Page, Maximum Length (0.00 mm), Reference, Direction, Offset, Shift X, Shift Y, Country Code, Head-up Sensor, Reprint After Error, Ribbon, Ribbon Sensor, and Ribbon Encoder Err. At the bottom, there are buttons for 'Clear', 'Load', 'Save', 'Set', and 'Get'.

- **File Manager:**

File manager feature is to help users to generate the file header, download the file into printer, explore what files are downloaded in printer memory and delete all files in the memory.

The screenshot shows the 'File Manager' interface, divided into three main sections: 'File Download', 'File Information', and 'File Format'. The 'File Download' section on the left includes a 'File Type' dropdown, a 'Browse' button, 'File Name' and 'File Size' (in Bytes) input fields, a 'Memory Device' dropdown set to 'FLASH', and a 'Download' button. The 'File Information' section in the middle shows 'Memory Device' options: 'DRAM', 'FLASH' (selected), and 'CARD'. It also displays 'Physical Space' and 'Free Space' in KB, along with 'Delete' and 'Get' buttons. The 'File Format' section on the right shows 'Memory Device' options: 'DRAM', 'FLASH' (selected), and 'CARD', with a 'Format' button.

- **Bitmap Font Manager:**

Bitmap font manager is used to convert the selected TTF font into printer format bitmap font. Both fixed pitch and variable pitch bitmap font are supported.

Font Select		Standard Encode	
Font Encode	Standard Encode	Font Mapping	Standard Mapping
Font Pitch	Variable Pitch	Character Start ASCII	32
Printer Device	FLASH	Character End ASCII	127
Windows Font Name	Arial	Asian Font Encode	
Font Size	10	<input checked="" type="radio"/> Traditional Chinese <input type="radio"/> Simplified Chinese <input type="radio"/> Korean <input type="radio"/> Japanese	
	<input type="button" value="Select Font"/>	Encode by Table	
	<input type="button" value="Preview Font"/>	<input type="checkbox"/> By File <div style="border: 1px solid gray; height: 100px; width: 100%;"></div>	
Printer Font Name	FONT001	<input type="button" value="Load"/>	<input type="button" value="Save"/>
Font Width	12	<input type="button" value="Save Font"/>	
Font Height	16	<input type="button" value="Download Font"/>	
Italic Width	0		
Pitch Fine Tuning	0		

■ **Command Tool:**

The additional features that are not yet supported in the Diagnostic Utility can be achieved by sending out printer commands to printer from the Command Tool.

Specify the editor and enter the commands in the editor. Please be reminded to hit the PC keyboard Enter key at the end of each command line. Click the "Send" button to send out the commands in the specified editor to printer. You can also send a command file by clicking "Send File" button.

Editor	
<input checked="" type="radio"/> 1 <input type="radio"/> 2 <input type="radio"/> 3 <input type="radio"/> 4 <input type="radio"/> 5 <input type="radio"/> 6 <input type="radio"/> 7 <input type="radio"/> 8 <input type="radio"/> 9 <input type="radio"/> 10 <input type="radio"/> 11 <input type="radio"/> 12	<div style="border: 1px solid gray; height: 250px; width: 100%;"></div>
<input type="button" value="Send File"/>	<input type="button" value="Send"/>
<input type="button" value="Load"/>	<input type="button" value="Save"/>

Install SD Memory Card

1. Open the SD memory card cover.



2. Insert the SD card until it is fully seated. Close the memory card cover.



CHAPTER 4 LED and Button Functions

This printer has six buttons and one three-color LED indicator. By the button when the LED indicates a different color, the printer can be set to feed labels, pause the printing job, select and calibrate the media sensor, print a printer self-test report, reset the printer to defaults (initialization). See the following button operation descriptions for functions.

LED Indicator

LED Color	Description
Green/ Solid	Illuminates when power is on and the device is ready to use.
Green/ Flash	Illuminates when the system is downloading data from PC to memory or the printer is paused.
Amber	Illuminates when the system is clearing data from printer.
Red / Solid	Illuminates when the printer head is open, or a cutter error.
Red / Flash	Illuminates when there is a printing error, such as head open, paper empty, paper jam, ribbon empty, or memory error etc.

Regular Button Function

- **Feed button**
 - Feed one label when the printer on ready mode
 - Pause/Resume the printing process
 - Press the button to enter/select cursor located item from a menu
- **Menu button**
 - Enter the menu
 - Exit from a menu or cancel a setting and return to the previous menu
- **Navigation button**
 - Scroll the menu list

Power on Utilities

There are six power-on utilities to set up and test printer hardware. These utilities are activated by pressing **FEED**, then turning on the printer power simultaneously and releasing the button at a different LED color.

Follow these steps for various power-on utilities:

1. Turn off the power switch.
2. Hold the **Feed** button down, then turn the power switch **ON**.
3. Release the button when LED indicates a color for a different function.

Power on Utilities	LED color changes as follows:						
LED Color	Amber	Red (5 blinks)	Amber (5 blinks)	Green (5 blinks)	Green/Amber (5 blinks)	Red/Amber (5 blinks)	Solid green
Functions							
1. Ribbon Sensor Calibration and Gap / black mark sensor calibration		Release					
2. Gap / black mark sensor calibration, Self-test and enter dump mode			Release				
3. Printer initialization				Release			
4. Set black mark sensor as media sensor and calibrate the black mark sensor					Release		
5. Set gap sensor as media sensor and calibrate the gap sensor						Release	
6. Skip AUTO.BAS							Release

Ribbon and Gap/Black Mark Sensor Calibration

Calibrate gap/black mark sensor sensitivity at the following conditions:

- New printer
- Change label stock
- Printer initialization

Follow these steps to calibrate the ribbon and gap/black mark sensor:

1. Turn off the power switch.
2. Hold the **Feed** button down, then turn the power switch **ON**.
3. Release the button when LED turns **red** and blinks. (Any time during the 5 blinks).
 - The ribbon sensor and gap/black mark sensor sensitivity will be calibrated.
 - The LED color will change in the following order:
 - **Amber** → **Red** (5 blinks) → **Amber** (5 blinks) → **Green** (5 blinks) → **Green/Amber** (5 blinks) → **Red/Amber** (5 blinks) → **Solid Green**

Note: Select gap or black mark sensor by sending GAP or BLINE command to the printer before calibrating the sensor.

Gap/Black Mark Calibration, Self-test and Dump Mode

While calibrating the gap/black mark sensor, the printer will measure the label length, print the internal configuration (self-test) on a label and then enter the dump mode. Calibrating the gap or black mark sensor depends on the sensor setting in the last print job.

To calibrate the sensor:

1. Turn off the power switch.
2. Hold the **Feed** button down, then turn the power switch **ON**.
3. Release the button when LED turns **amber** and blinks (any time during the 5 blinks).

The LED color will change in the following sequence:

- **Amber** → **Red** (5 blinks) → **Amber** (5 blinks) → **Green** (5 blinks) → **Green/Amber** (5 blinks) → **Red/Amber** (5 blinks) → **Solid Green**
4. The printer calibrates the sensor, measures the label length and prints internal settings then enters the dump mode.

Note: Select gap or black mark sensor by sending GAP or BLINE command to the printer before calibrating the sensor.

Self-Test

The printer will print the printer configuration after a gap/black mark sensor calibration. The self-test printout can be used to check if there is any dot damage on the heater element, printer configurations and available memory space.

Self-test printout	
----- SYSTEM INFORMATION -----	
MODEL: XXXXXX	Model name
FIRMWARE: X.XX	F/W version
CHECKSUM: XXXXXXXX	Firmware checksum
S/N: XXXXXXXXXXXX	Printer S/N
TCF: NO	Configuration file
DATE: 1970/01/01	System date
TIME: 00:04:18	System time
NON-RESET: 110 m (TPH) <input type="text"/>	Printed mileage (meter)
RESET: 110 m (TPH)	
NON-RESET: 0 (CUT) <input type="text"/>	Cutting counter
RESET: 0 (CUT)	

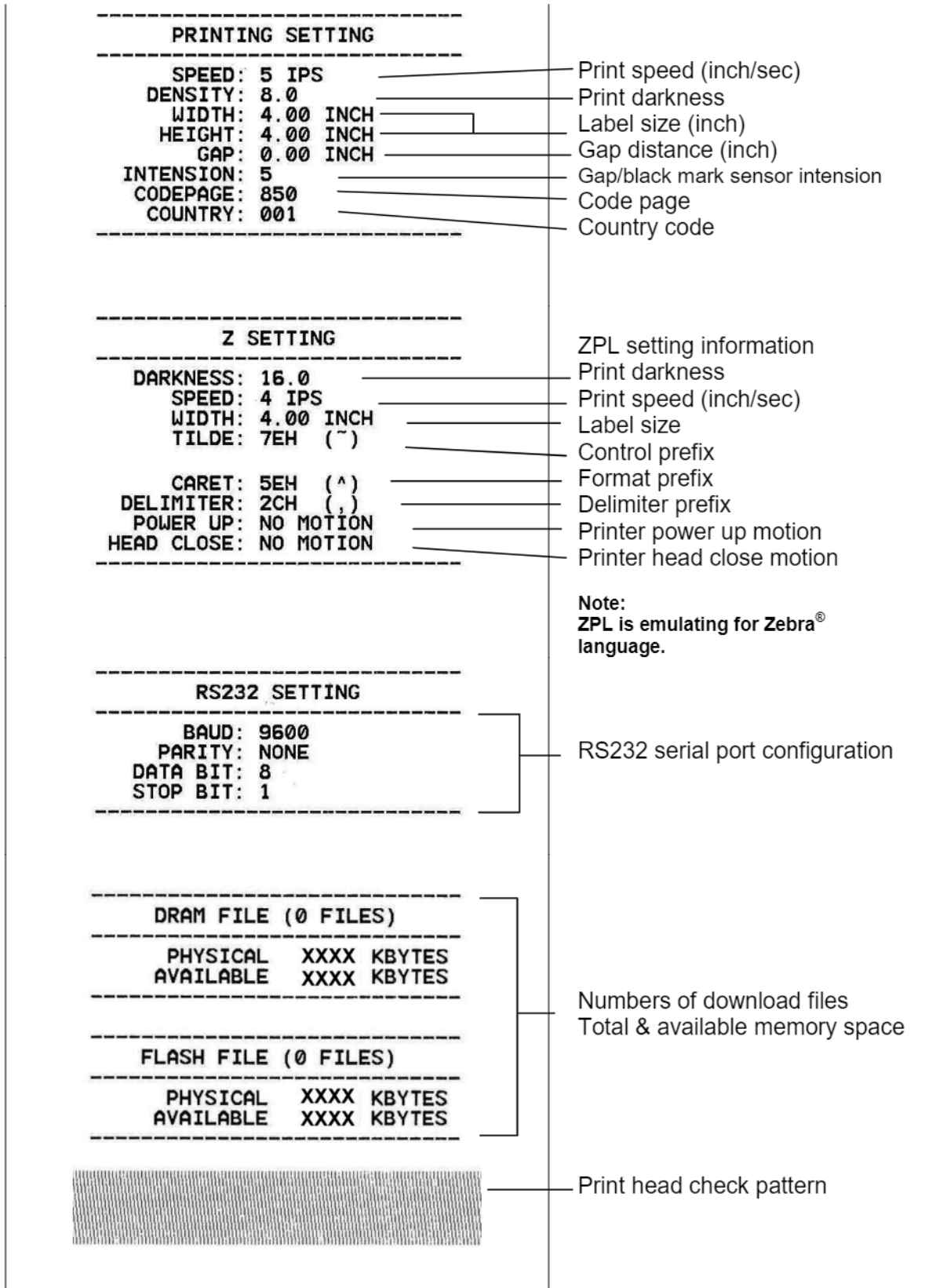

Note:
ZPL is emulating for Zebra® language.

Dump Mode

The printer enters dump mode after printing the printer configuration. In the dump mode, all characters are printed in 2 columns as shown. The ASCII characters are received from your system and right side data shows the corresponding hexadecimal value of the characters. It allows users or engineers to verify and debug the program.

ASCII Data

```

SPEED 2.0 53 50 46 45 44 20 32 2E 30 00
DENSITY 8 0A 44 45 4E 53 49 54 59 20 38
SET PEEL 0D 0A 53 45 54 20 50 45 45 4C
OFF DIRE 20 4F 46 45 0D 0A 44 19 52 45
CTION 0 0 43 54 49 4F 4E 20 30 00 0A 47
AP 3.00 mm 41 50 20 33 2E 30 30 20 0D 00
.0.00 mm 2C 30 2E 30 30 20 6D 6D 0D 0A
REFERENCE 52 45 46 45 52 45 4E 43 45 20
0.0 SET C 30 2C 30 0D 0A 53 45 54 20 43
UTTER OFF 55 54 54 45 52 20 4F 46 46 00
SIZE 100. 0A 53 49 5A 45 20 31 30 30 2E
02 mm, 02.0 30 32 20 6D 0D 2C 30 35 2E 30
1 mm CLS 34 20 6D 6D 0D 0A 43 4C 53 00
BARCODE 1 0A 42 41 52 43 4F 44 45 20 31
44.149."39 34 34 2C 31 34 39 2C 22 33 39
.120.1.0. 22 2C 31 32 30 2C 31 2C 30 2C
2.0."57114 32 2C 36 2C 22 35 37 31 31 34
3BT PRIN 33 38 54 22 0D 0A 50 52 49 4E
T 1.1 SPE 54 20 31 2C 31 0D 0A 53 50 46
ED 2.0 DE 45 44 20 32 2E 30 0D 0A 44 45
DENSITY 8 3 4E 53 49 54 09 20 36 0D 0A 53

ET PEEL OF 45 54 20 50 45 45 4C 20 4F 46
F DIRECTI 46 0D 0A 44 49 52 45 43 54 49
ON 0 GAP 4F 4E 20 30 0D 0A 47 41 50 20
3.00 mm, 0. 33 2E 30 30 20 0D 6D 20 30 2E
00 mm REF 30 30 20 6D 0D 0D 0A 52 45 46
ERENCE 0.0 45 52 45 4E 43 45 20 30 2C 30
SET CUTT 0D 0A 53 45 54 20 43 55 54 54
ER OFF SI 45 52 20 4F 46 46 0D 0A 53 49
ZE 100.02 5A 45 20 31 30 30 2E 30 32 20
mm, 05.04 m 6D 0D 2C 36 35 2E 30 34 20 6D
m CLS BA 6D 0D 0A 43 4C 53 0D 0A 42 41
RODE 144. 52 49 4F 44 45 20 31 34 34 2C
149."39".1 31 34 39 2C 22 33 39 22 2C 31
20.1.0.2.0 32 30 2C 31 2C 30 2C 32 2C 30
."571143BT 2C 22 35 37 31 31 34 33 38 64
PRINT 1 22 0D 0A 50 52 49 4E 54 20 31
.1 2C 31 0D 0A

```

Hex decimal data related to left column of ASCII data

Notes:

- 1. Dump mode requires 4" wide paper width.
- 2. Turn off / on the power to resume printer for normal printing.
- 3. Press FEED button to go back to the previous menu.

Printer Initialization

Printer initialization is used to clear DRAM and restore printer settings to defaults. The only exception is ribbon sensitivity, which will not be restored to default.

To activate Printer initialization:

1. Turn off the power switch.
2. Hold the **Feed** button down, then turn the power switch **ON**.
3. Release the button when the LED turns **green** after 5 amber blinks. (Any time during the 5 blinks).

The LED color changes as follows:

- **Amber** → **Red** (5 blinks) → **Amber** (5 blinks) → **Green** (5 blinks) → **Green/Amber** (5 blinks) → **Red/Amber** (5 blinks) → **Solid Green**

Set Black Mark Sensor as Media Sensor and Calibrate the Black Mark Sensor

To set Black Mark Sensor:

1. Turn off the power switch.
2. Hold the **Feed** button down, then turn the power switch **ON**.
3. Release the ONbutton when LED turns **green/amber** after 5 green blinks. (Any green/amber will do during the 5 blinks).

The LED color changes as follows:

- **Amber** → **Red** (5 blinks) → **Amber** (5 blinks) → **Green** (5 blinks) → **Green/Amber** (5 blinks) → **Red/Amber** (5 blinks) → **Solid Green**

Set Gap Sensor as Media Sensor and Calibrate the Gap Sensor

To set Gap Sensor:

1. Turn off the power switch.
2. Hold the **Feed** button down, then turn the power switch **ON**.
3. Release the button when LED turns **red/amber** after 5 green/amber blinks (any time during the 5 blinks).

The LED color changes as follows:

- **Amber** → **Red** (5 blinks) → **Amber** (5 blinks) → **Green** (5 blinks) → **Green/Amber** (5 blinks) → **Red/Amber** (5 blinks) → **Solid Green**

Skip AUTO.BAS

TSPL2 programming language lets users download an auto execution file to flash memory. The printer will run the AUTO.BAS program immediately when printer power is turned on. The AUTO.BAS program can be interrupted without using the power-on utility to run the program.

To skip an AUTO.BAS program:

1. Turn off printer power.
2. Press the FEED button and then turn on power.
3. Release the FEED button when LED turns **solid green**.

The LED color changes as follows:

- **Amber** → **Red** (5 blinks) → **Amber** (5 blinks) → **Green** (5 blinks) → **Green/Amber** (5 blinks) → **Red/Amber** (5 blinks) → **Solid Green**
4. Printer will be interrupted to run the AUTO.BAS program.

CHAPTER 5 LCD Menu Function

Enter the Menu

Press the “Menu” button to enter the main menu. Use the navigation button to scroll the item on main menu. The selected item will turn red. Press the “Feed” button to enter the setting list.

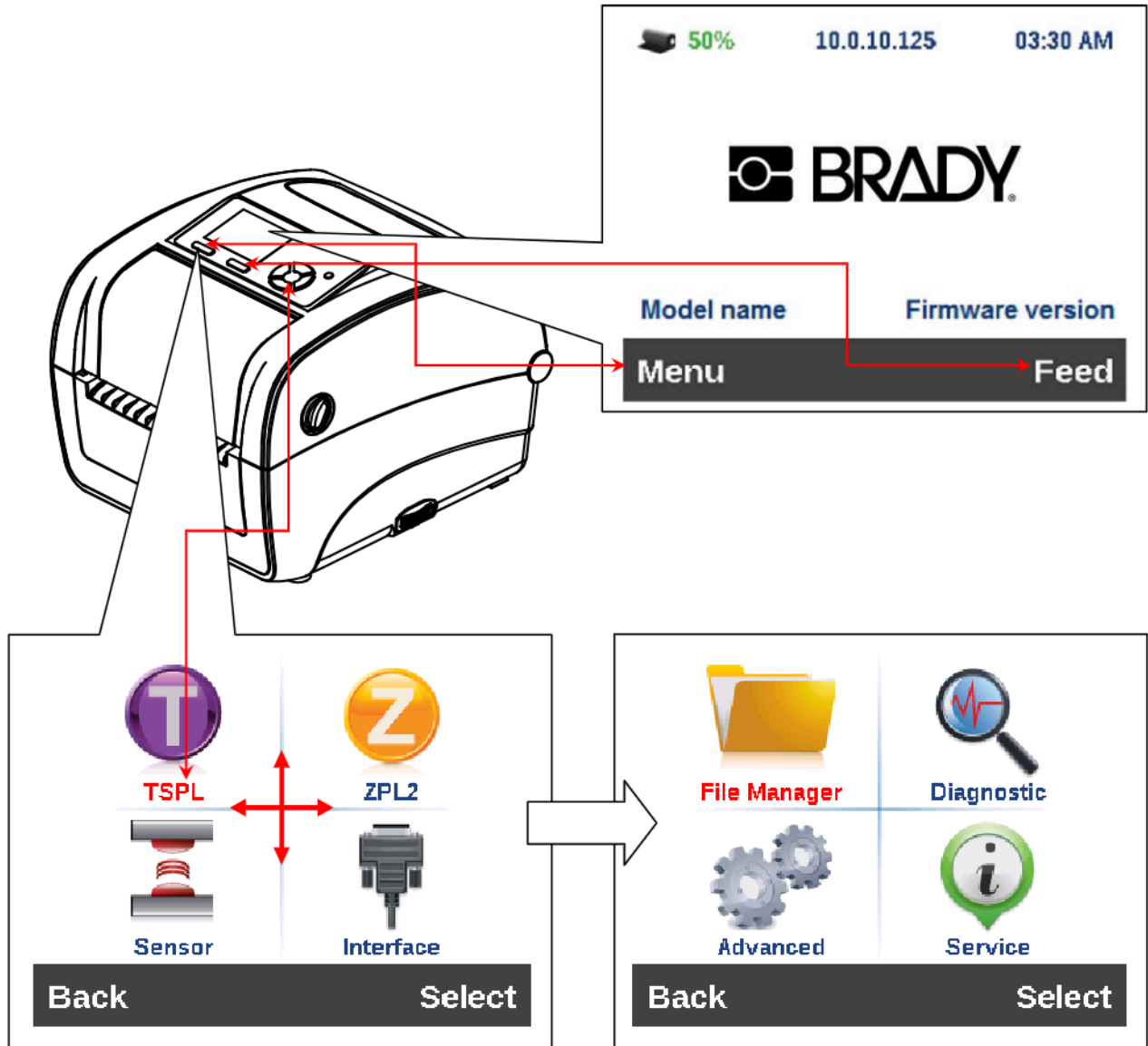

Main Menu Overview

There are 8 categories for the main menu. You can easily set the settings of printer without connecting the computer. Please refer to following sections for more details.

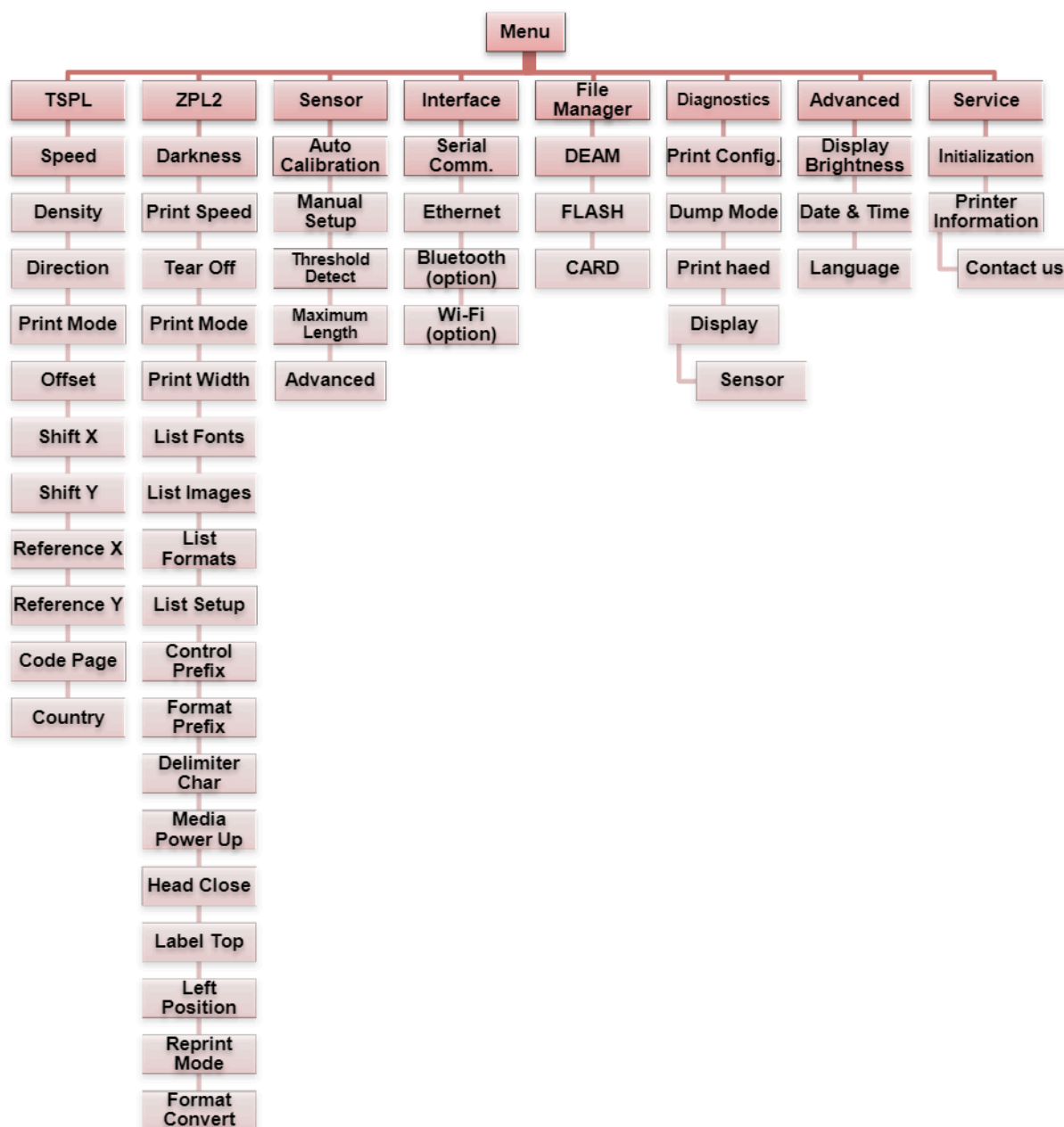

TSPL2

This “TSPL2” category can set up the printer settings for TSPL2.

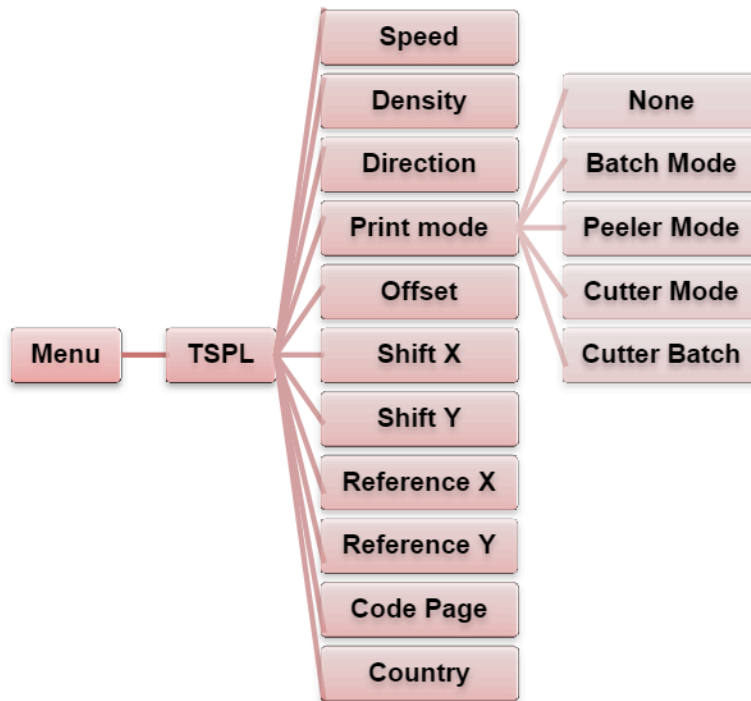

Item	Description	Default				
Speed	Use this item to setup print speed.	5				
Density	Use this option to setup printing darkness. The available setting is from 0 to 15, and the step is 1. You may need to adjust your density based on selected media.	8				
Direction	<p>The direction setting value is either 1 or 0. Use this item to setup the printout direction.</p> <table border="1" style="margin-left: auto; margin-right: auto;"> <thead> <tr> <th>DIRECTION 0</th> <th>DIRECTION 1</th> </tr> </thead> <tbody> <tr> <td style="text-align: center;">Direction</td> <td style="text-align: center;">Direction</td> </tr> </tbody> </table>	DIRECTION 0	DIRECTION 1	Direction	Direction	0
DIRECTION 0	DIRECTION 1					
Direction	Direction					
Print mode	<p>This item is used to set the print mode. There are 5 modes as below,</p> <table border="1" style="margin-left: auto; margin-right: auto;"> <thead> <tr> <th>Printer Mode</th> <th>Description</th> </tr> </thead> <tbody> <tr> <td>None</td> <td>Next label top of form is aligned to the print head burn line location. (Tear Off Mode)</td> </tr> </tbody> </table>	Printer Mode	Description	None	Next label top of form is aligned to the print head burn line location. (Tear Off Mode)	Batch Mode
Printer Mode	Description					
None	Next label top of form is aligned to the print head burn line location. (Tear Off Mode)					

	Batch Mode	Once image is printed completely, label gap/black mark will be fed to the tear plate location for tear away.	
	Peeler Mode	Enable the label peel off mode.	
	Cutter Mode	Enable the label cutter mode.	
	Cutter Batch	Cut the label once at the end of the printing job.	
Offset	This item is used to fine tune media stop location. Available setting value is from "+" to "-" or "0" to "9".		+000
Shift X	This item is used to fine tune print position. Available setting value is from "+" to "-" or "0" to "9".		+000
Shift Y			+000
Reference X	This item is used to set the origin of printer coordinate system horizontally and vertically. Available setting value is from "0" to "9".		000
Reference Y			000
Code page	Use this item to set the code page of international character set.		850
Country	Use this option to set the country code.		001

Note: If printing from enclosed software/driver, the software/driver will send out the commands, which will overwrite the settings set from the panel.

ZPL2

This “ZPL2” category can set up the printer settings for ZPL2.

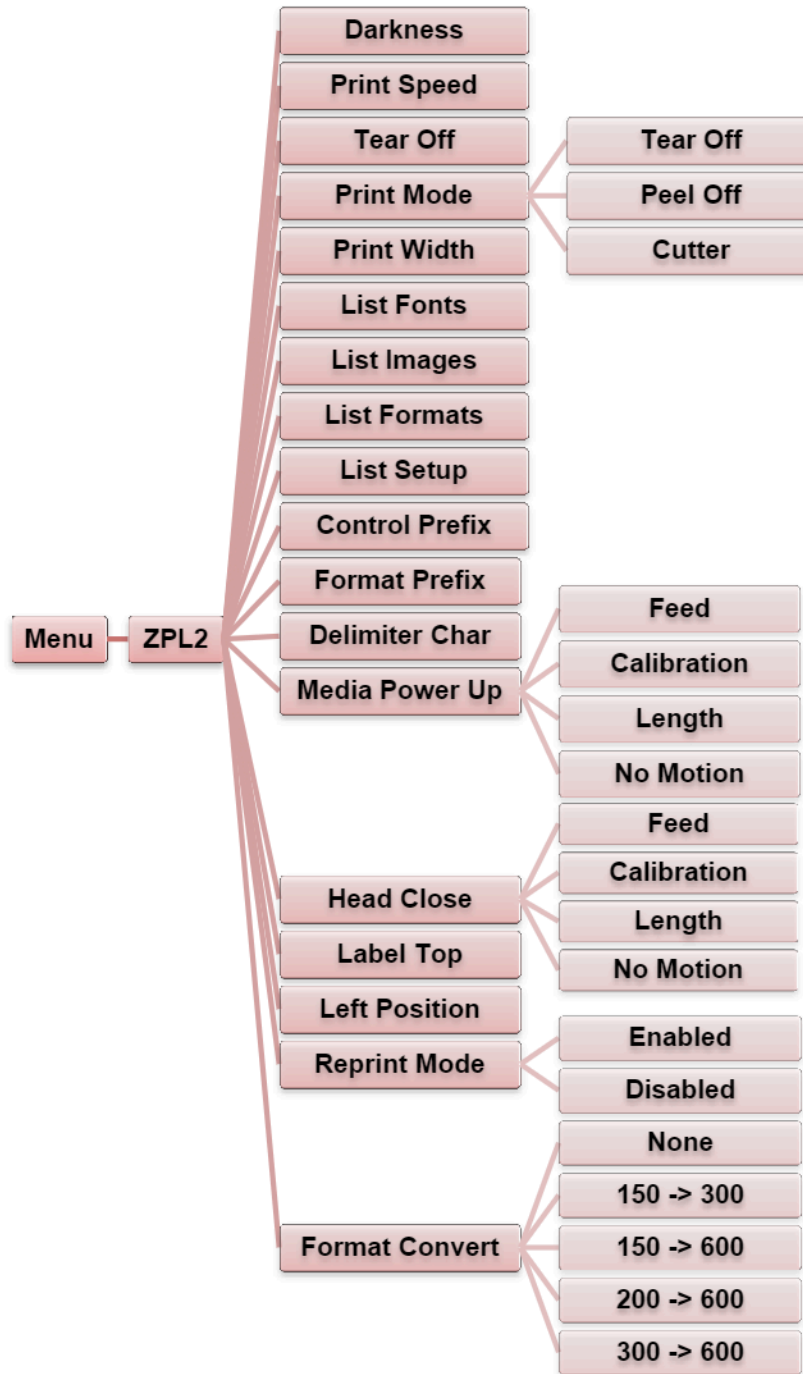

Item	Description	Default										
Darkness	Use this item to setup printing darkness. The available setting is from 0 to 30, and the step is 1. You may need to adjust your density based on selected media.	16										
Print Speed	Use this item to setup print speed. The increase or decrease is 1 ips. Available setting is from 2 to 6.	4 (300dpi)										
Tear Off	This item is used to fine tune media stop location. Available setting value is from "+" to "-" or "0" to "9".	+000										
Print mode	<p>This item is used to set the print mode. There are 3 modes as below,</p> <table border="1"> <thead> <tr> <th>Printer Mode</th> <th>Description</th> </tr> </thead> <tbody> <tr> <td>Tear Off</td> <td>Next label top of form is aligned to the print head burn line location.</td> </tr> <tr> <td>Peeler Off</td> <td>Enable the label peel off mode.</td> </tr> <tr> <td>Cutter</td> <td>Enable the label cutter mode</td> </tr> </tbody> </table>	Printer Mode	Description	Tear Off	Next label top of form is aligned to the print head burn line location.	Peeler Off	Enable the label peel off mode.	Cutter	Enable the label cutter mode	Tear Off		
Printer Mode	Description											
Tear Off	Next label top of form is aligned to the print head burn line location.											
Peeler Off	Enable the label peel off mode.											
Cutter	Enable the label cutter mode											
Print Width	This item is used to set print width. The available value is from "0" to "9".	812 dot										
List Fonts	This feature is used to print current printer available fonts list to the label. The fonts stored in the printer's DRAM, Flash or optional memory card.	N/A										
List Images	This feature is used to print current printer available images list to the label. The images stored in the printer's DRAM, Flash or optional memory card.	N/A										
List Formats	This feature is used to print current printer available formats list to the label. The formats stored in the printer's DRAM, Flash or optional memory card.	N/A										
List Setup	This feature is used to print current printer configuration to the label.	N/A										
Control Prefix	This feature is used to set control prefix character.	N/A										
Format Prefix	This feature is used to set format prefix character.	N/A										
Delimiter Char	This feature is used to set delimiter character.	N/A										
Media Power Up	<p>This option is used to set the action of the media when you turn on the printer.</p> <table border="1"> <thead> <tr> <th>Selections</th> <th>Description</th> </tr> </thead> <tbody> <tr> <td>Feed</td> <td>Printer will advance one label</td> </tr> <tr> <td>Calibration</td> <td>Printer will calibration the sensor levels, determine length and feed label</td> </tr> <tr> <td>Length</td> <td>Printer determine length and feed label</td> </tr> <tr> <td>No Motion</td> <td>Printer will not move media</td> </tr> </tbody> </table>	Selections	Description	Feed	Printer will advance one label	Calibration	Printer will calibration the sensor levels, determine length and feed label	Length	Printer determine length and feed label	No Motion	Printer will not move media	No Motion
Selections	Description											
Feed	Printer will advance one label											
Calibration	Printer will calibration the sensor levels, determine length and feed label											
Length	Printer determine length and feed label											
No Motion	Printer will not move media											

Head Close	This option is used to set the action of the media when you close the print head.		No Motion
	Selections	Description	
	Feed	Printer will advance one label	
	Calibration	Printer will calibration the sensor levels, determine length and feed label	
	Length	Printer determine length and feed label	
	No Motion	Printer will not move media	
Label Top	This option is used to adjust print position vertically on the label. The range is -120 to +120 dots.		0
Left Position	This option is used to adjust print position horizontally on the label. The range is -9999 to +9999 dots.		+0000
Reprint Mode	When reprint mode is enabled, you can reprint the last label printer by pressing "UP" button on printer's control panel.		Disabled
Format Convert	Selects the bitmap scaling factor. The first number is the original dots per inch (dpi) value; the second, the dpi to which you would like to scale.		None

Note: If printing from enclosed software/driver, the software/driver will send out the commands, which will overwrite the settings set from the panel.

Sensor

This option is used to calibrate the selected sensor. We recommend calibrate the sensor before printing when changing the media.

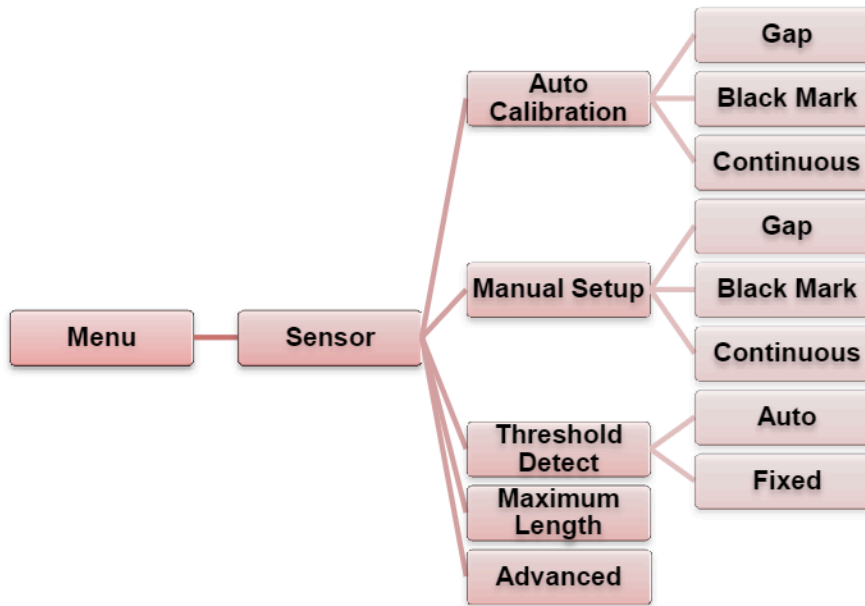

Item	Description	Default
Auto Calibration	Printer will feed 2 to 3 gap labels to calibrate the sensor sensitivity automatically.	N/A
Manual Setup	In case “Auto calibration” cannot apply to the media, please use “Manual setup” function to calibrate the sensor sensitivity.	N/A
Threshold Detect	This option is used to set sensor sensitivity in fixed or auto.	Auto
Maximum Length	This option is used to set the maximum length for label calibration.	253mm
Advanced	This function can set the minimum paper length and maximum gap/bline length for auto-calibrate the sensor sensitivity.	OFF

Interface

This option is used to set the printer interface settings.

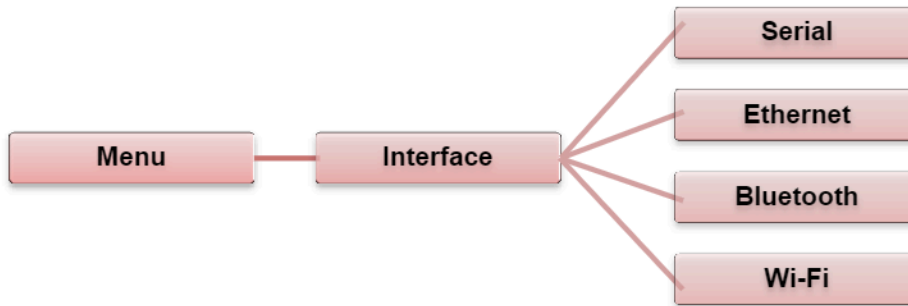

Serial Comm.

This option is used to set the printer RS-232 settings.

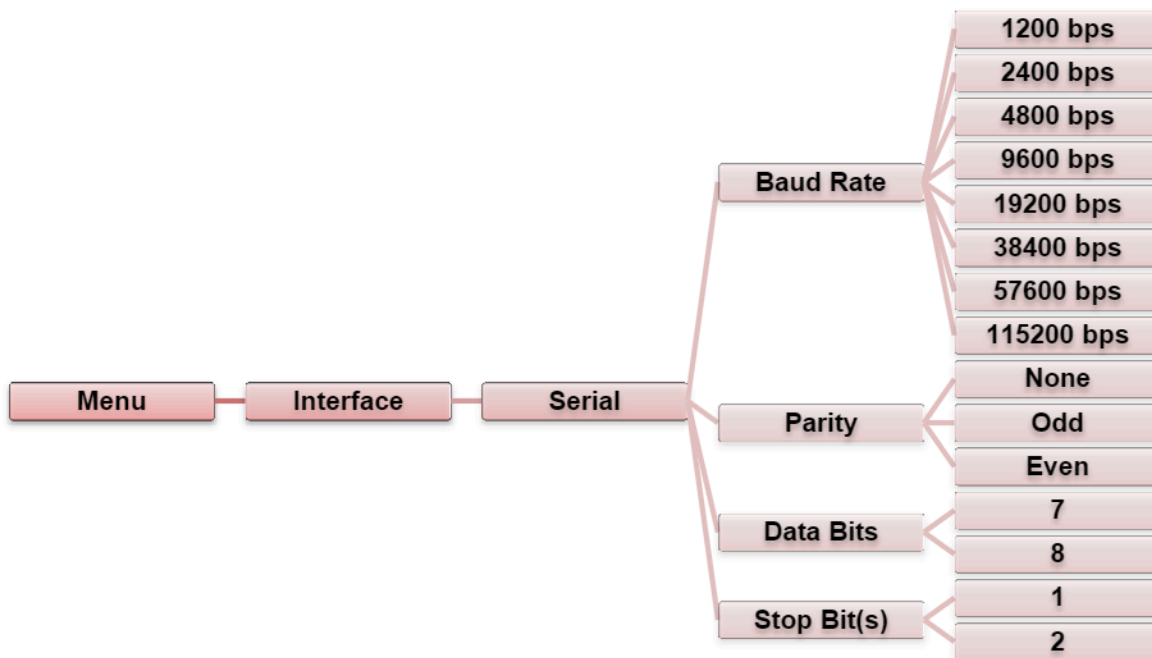

Item	Description	Default
Baud Rate	This item is used to set the RS-232 baud rate.	9600
Parity	This item is used to set the RS-232 parity.	None
Data Bits	This item is used to set the RS-232 Data Bits.	8
Stop Bit(s)	This item is used to set the RS-232 Stop Bits.	1

Ethernet

Use this menu to configure internal Ethernet configuration check the printer's Ethernet module status, and reset the Ethernet module.

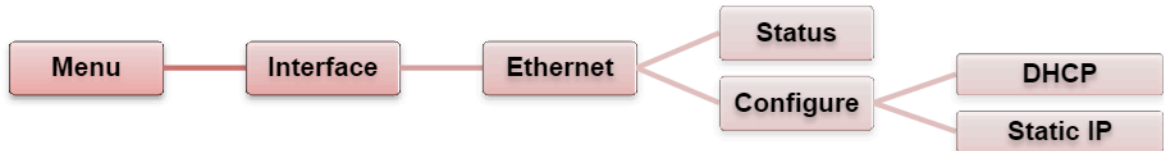

Item	Description	Default
Status	Use this menu to check the Ethernet IP address and MAC setting status.	N/A
DHCP	This item is used to ON or OFF the DHCP (Dynamic Host Configuration Protocol) network protocol.	N/A
Static IP	Use this menu to set the printer's IP address, subnet mask and gateway.	ON

Bluetooth (Option)

This option is used to set the printer bluetooth settings.

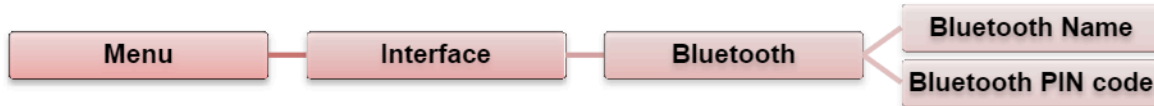

Item	Description	Default
Bluetooth Name	This item is used to set the local name for Bluetooth.	BT-SPP
Bluetooth PIN Code	This item is used to set the local PIN code for Bluetooth.	0000

Wi-Fi (Option)

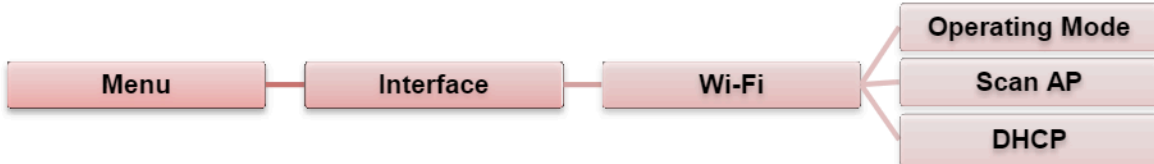

Item	Description	Default
Operating	This item is used to set the operating mode of wireless local area networks to connect devices to the networks. Note: Infrastructure mode requires the use of an access point for this communication to take place. Ad hoc mode involves connecting a computer directly to another computer.	Infrastructure
Scan AP	This item is used to scan the access point device	N/A
DHCP	This item is used to ON or OFF the DHCP (Dynamic Host Configuration Protocol) network protocol.	ON

File Manager

This feature is used to check the printer available memory and file list.

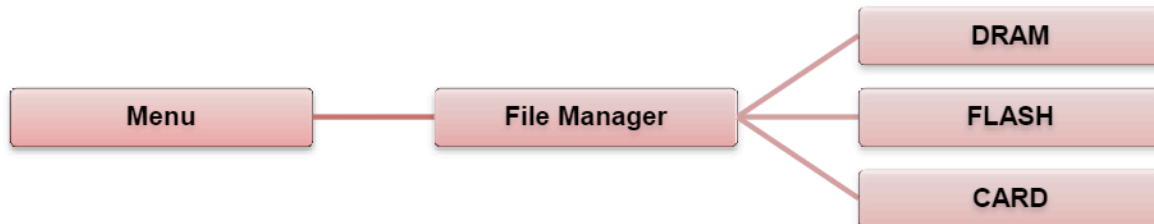

Item	Description
DRAM	Use this menu to show, delete and run (.BAS) the files saved in the printer DRAM memory.
FLASH	Use this menu to show, delete and run (.BAS) the files saved in the printer Flash memory.
CARD	Use this menu to show, delete and run (.BAS) the files saved in the printer Card memory.

Diagnostics

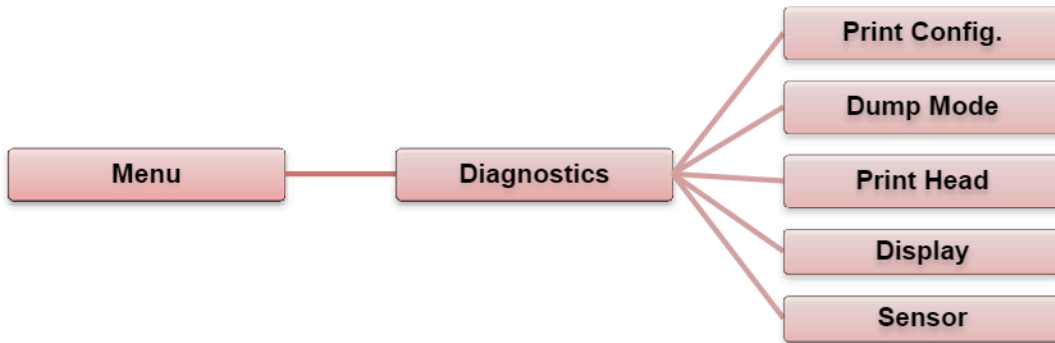

Print Config.

This feature is used to print current printer configuration to the label. On the configuration printout, there is a print head test pattern, which is useful for checking if there is any dot damage on the print head heater element.

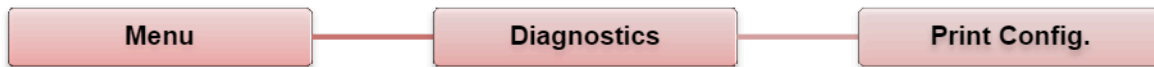

Self-test printout

<pre> ----- SYSTEM INFORMATION ----- MODEL: XXXXXX FIRMWARE: X.XX CHECKSUM: XXXXXXXX S/N: XXXXXXXXXXXX TCF: NO DATE: 1970/01/01 TIME: 00:04:18 NON-RESET: 110 m (TPH) RESET: 110 m (TPH) NON-RESET: 0 (CUT) RESET: 0 (CUT) ----- PRINTING SETTING ----- SPEED: 5 IPS DENSITY: 8.0 WIDTH: 4.00 INCH HEIGHT: 4.00 INCH GAP: 0.00 INCH INTENSION: 5 CODEPAGE: 850 COUNTRY: 001 ----- </pre>	<pre> Model name F/W version Firmware checksum Printer S/N Configuration file System date System time Printed mileage (meter) Cutting counter Print speed (inch/sec) Print darkness Label size (inch) Gap distance (inch) Gap/black mark sensor intension Code page Country code </pre>
---	--

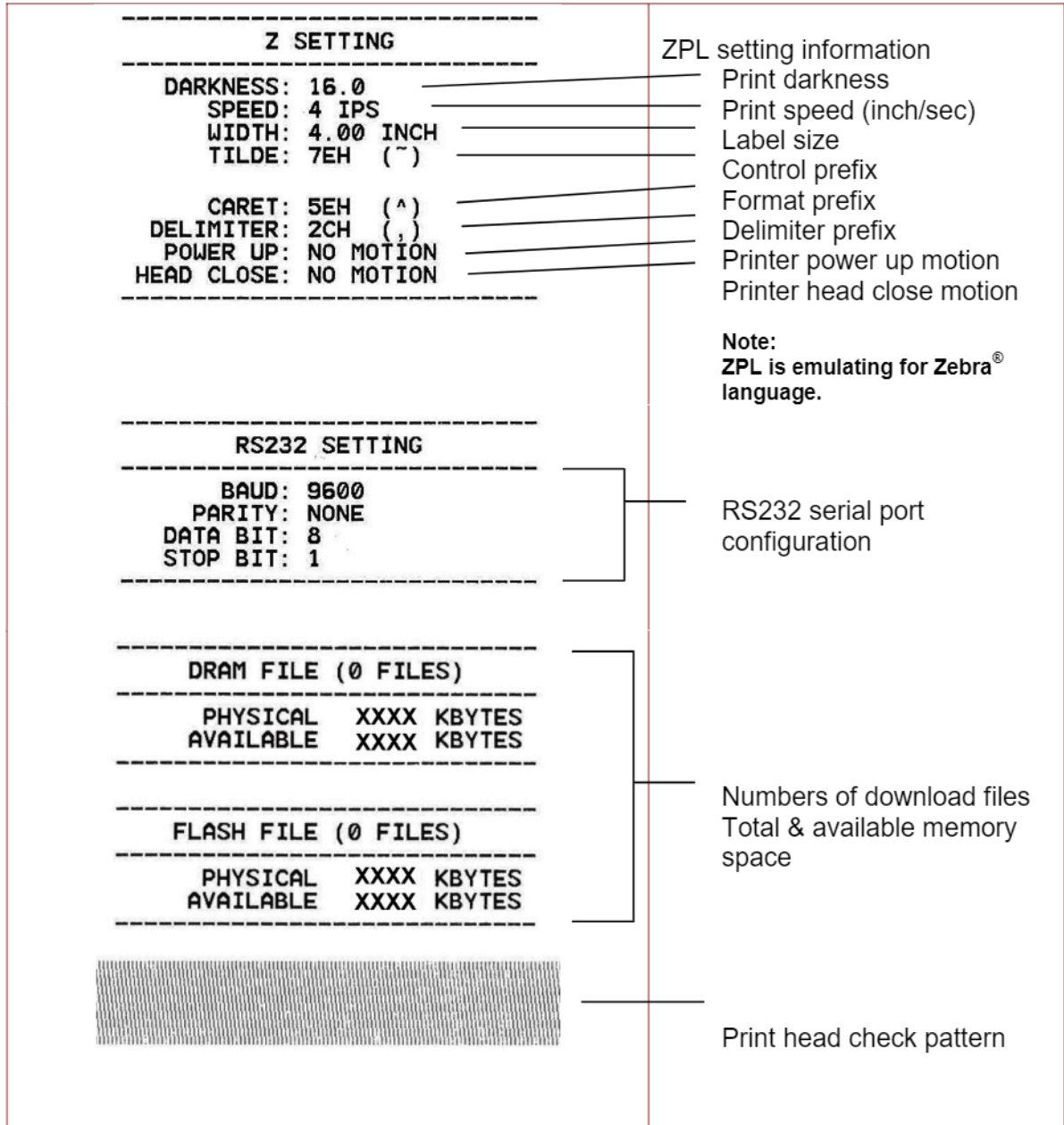

Note:
Checking dot damage requires 4" wide paper width.

Dump Mode

Captures the data from the communications port and prints out the data received by printer. In the dump mode, all characters will be printed in 2 columns. The left side characters are received from your system and right side data are the corresponding hexadecimal value of the characters. It allows users or engineers to verify and debug the program.

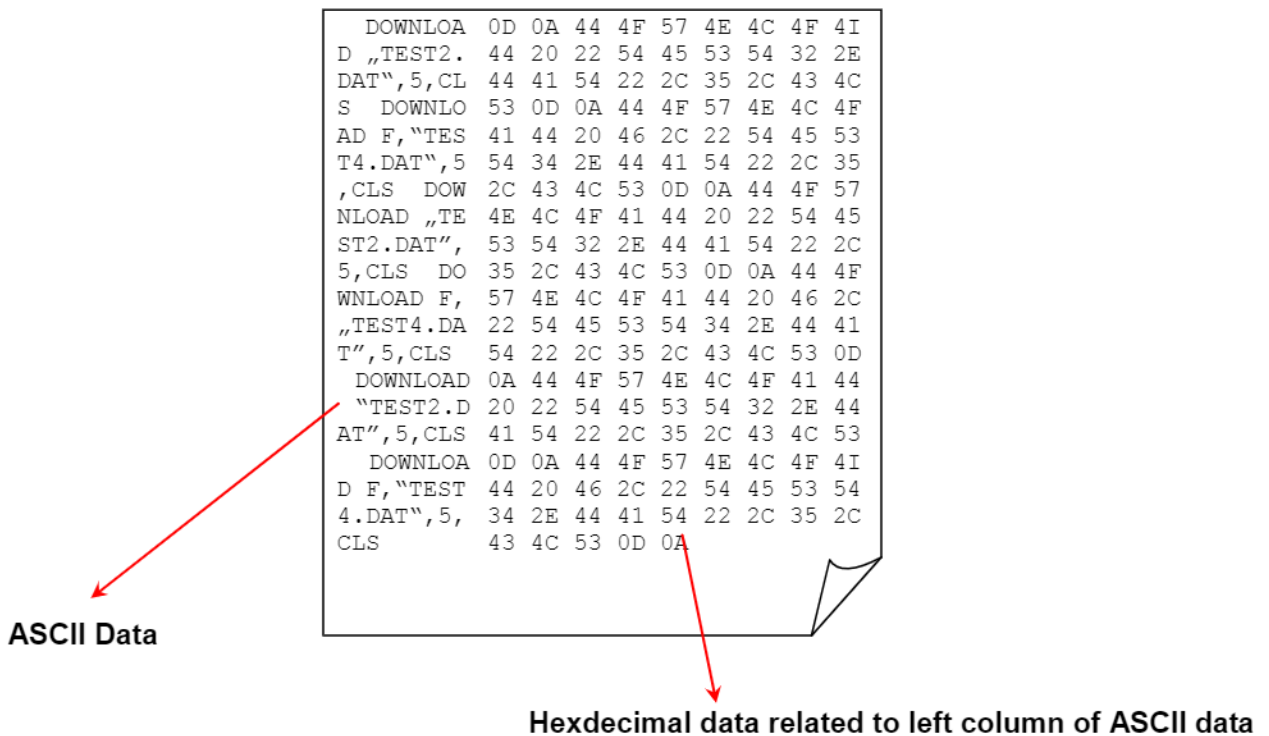
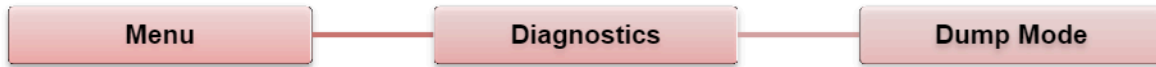

Note:
Dump mode requires 4" wide paper width.

Print Head

This feature is used to check print head's temperature, resistance and bad dots.



Display

This feature is used to check LCD's color state.



Advanced

This feature is used to set the printer LCD settings.



Item	Description
Display Brightness	This item is used to setup the brightness for display.
Date & Time (Option)	This item is used to setup the date and time on display. (RTC)
Language	This item is used to setup the language on display.

Service

This feature is used to restore printer settings to defaults and checking information for printer.

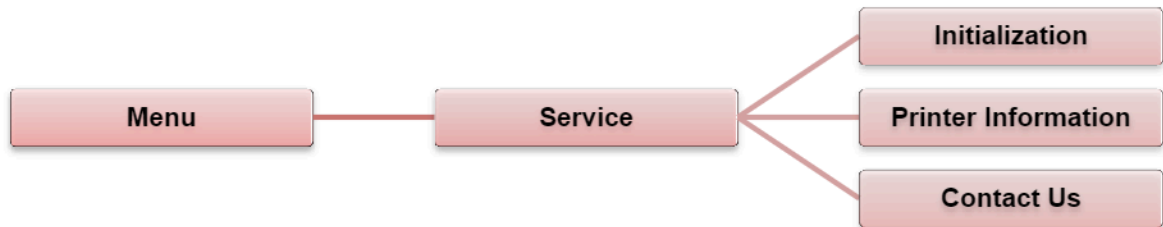

Item	Description
Initialization	This feature is used to restore printer settings to defaults.
Printer Information	This feature is used to check the printer's serial number, printed mileage (m), printed labels (pcs.) and cutting counter.
Contact Us	This feature is used to check the contact information for tech support service.

CHAPTER 6 Troubleshooting

The following guide lists the most common problems that may be encountered when operating this bar code printer. If the printer still does not function after all suggested solutions have been tried, please contact the Customer Service Department of your purchased reseller or distributor for assistance.

LED Status

This section provides solutions to common problems indicated by the LED status that you may encounter when operating the printer.

LED Status / Color	Printer	Possible Cause	Recovery Procedure
OFF	No response	No power	<ul style="list-style-type: none">• Turn on the power switch.• Check if the green LED is lit on power supply. If it is not lit, the power supply is broken.• Check if both the power connections from the power cord to the power supply and from the power supply to the printer power jack are connected securely.
Solid Green	ON	The printer is ready to use	<ul style="list-style-type: none">• No action necessary.
Green with blinking	Pause	The printer is paused	<ul style="list-style-type: none">• Press the FEED button to resume printing.
Red with blinking	Error	Out of label or ribbon. Printer setting is not correct	<ol style="list-style-type: none">1. Out of label or ribbon:<ul style="list-style-type: none">• Load a label roll following media loading instructions, then press FEED to resume printing.• Load a label roll following ribbon loading instructions, then press FEED to resume printing.2. Printer setting is not correct:<ul style="list-style-type: none">• Initialize the printer by following the instructions in "Power on Utility" or "Diagnostic Tool."

Note: Printer status can be viewed in the Diagnostic Tool. For more information about the Diagnostic Tool, see the instructions in the software CD disc located at **D:\DiagTool**.

Print Quality

Problem	Possible Cause	Recovery Procedure
Not Printing	Check if interface cable is properly connected to the interface connector.	Re-connect cable to interface.
	The serial port cable pin configuration is not a pin-to-pin connection.	Replace the cable with pin to pin connection.
	The serial port setting is not consistent between host and printer.	Reset the serial port setting.
	The port specified in the Windows driver is not correct.	Select the correct printer port in the driver.
	The Ethernet IP, subnet mask, gateway is not configured properly.	Configure the IP, subnet mask and gateway.
No print on the label	Label or ribbon loaded not correctly.	Follow the instructions in loading the media or loading the ribbon.
	Out of Ribbon.	Load new ribbon.
Continuous feeding labels	The printer setting may be wrong.	Perform the initialization and gap/black mark calibration.
Paper Jam	Gap/black mark sensor sensitivity is not set properly (sensor sensitivity is not enough).	Calibrate the gap/black mark sensor.
	Label size is not set properly.	Set label size exactly as installed paper in the labeling software or program.
	Labels are stuck inside the printer mechanism near the sensor area.	Remove the stuck label.
Poor Print Quality	Top cover is not closed properly.	Close the top cover completely and make sure the right- and left- side levers are latched properly.
	Supply is loaded incorrectly.	Reload the supply.
	Ribbon and media are incompatible.	Change the ribbon or label combination.
	Dust and/or adhesives are accumulated on the print head.	Check if dust or adhesives are accumulated on the print head. Clean the print head.
	Print density is not set properly.	Adjust the print density and print speed.
	Print head test pattern is incorrect.	Head element may be damaged. Run printer self-test and check the print head test pattern to see if there are missing dots in the pattern.

CHAPTER 7 Maintenance

This session presents the cleaning tools and methods to maintain your printer.

1. Use one of following materials to clean the printer:

- Cotton swab (Head cleaner pen)
- Lint-free cloth
- Vacuum / Blower brush
- 100% ethanol

2. Clean the printer using the following process:

Printer Part	Method	Interval
Print Head	<ol style="list-style-type: none"> 1. Always turn off the printer before cleaning the print head. 2. Allow the print head to cool for a minimum of one minute. 3. Use a cotton swab and 100% ethanol to clean the print head surface. 	Clean the print head when changing a new label roll
Platen Roller	<ol style="list-style-type: none"> 1. Turn the power off. 2. Rotate the platen roller and wipe it thoroughly with 100% ethanol and a cotton swab, or lint-free cloth. 	Clean the platen roller when changing a new label roll
Tear Bar/Peel Bar	Use the lint-free cloth with 100% ethanol to wipe it.	As needed
Sensor	Compressed air or vacuum	Monthly
Exterior	Wipe it with water-dampened cloth	As needed
Interior	Brush or vacuum	As needed

Notes:

- Do not touch the printer head. If you touch it, use ethanol to clean it.
 - Use 100% Acetone or Ethenol. DO NOT use medical alcohol, which may damage the printer head.
 - To maintain printer performance and extend printer life, clean the print head and supply sensors whenever you change a new ribbon.
 - Continuous printing will cause the printer motor to overheat. Printer will stop printing automatically about 10~15 minutes until motor is cooled down. Data transfered to printer buffer will be lost if power to the printer is turned off when the printer pauses.
-



Copyright 2015 Brady Worldwide, Inc.

All Rights Reserved
BRADY WORLDWIDE, INC.
2221 W. Camden Road, Milwaukee, WI 53209