

# User Manual

## DAQ3120

### Benchtop Data Acquisition System



# Contents

1	Compliance Information	8
1.1	EMC	8
1.2	IEC Measurement Category & Pollution Degree Definitions	9
1.3	Product End-of-Life Handling	10
1.4	Terms and Symbols	10
2	Safety Notices	12
3	Introduction	18
3.1	Package Contents	18
3.2	Features	19
3.3	Dimensions	20
3.4	Front Panel	21
3.5	Rear Panel	22
3.6	Model Descriptions	23
4	Installation	24
4.1	Preliminary Information	24
4.2	Module Slot Cover Removing	26
4.3	Module Installation	27
4.4	Module Revomal	29
4.4.1	Step	29
4.5	Fuse Replacement	30
5	Operation Menus	31
5.1	Home Menu	32
5.1.1	Alarm Mode Settings (F1 - AlarmOut Key)	33
5.1.2	Auto Gain Settings (F2 - Auto Gain Key)	33
5.1.3	DMM Function Control (F3 - DMM Key)	33
5.1.4	Digit Display Settings (F4 - Digit Key)	33
5.1.5	Strain Offset Configuration (F5 - Strain Key)	34
5.2	Monitor Mode	35
5.3	Number Display	36
5.4	Bar Meter Display	36
5.5	Trend Chart Display	36
5.5.1	Number Display (F1 - Display Key)	37
5.5.2	Bar Meter Display (F1 - Display Key)	37
5.5.3	Trend Chart Display (F1 - Display Key)	37
5.5.4	Histogram Display (F1 - Display Key)	38
5.6	Scan Mode	39

5.6.1	Initiating Scan Mode .....	39
5.6.2	Scan Course Execution .....	39
5.6.3	Data Storage .....	39
5.6.4	Stopping Scan Mode .....	39
5.6.5	Scan Mode Display .....	39
5.6.6	Alarm Clear .....	40
5.7	Scan Mode with Monitor Mode Simultaneously .....	41
6	Configuration Menus .....	42
6.1	Channel Menu .....	44
6.1.1	F1 (Channel) Key – Select a Channel .....	45
6.1.2	F2 (Label) Key – Assign a Channel Name .....	45
6.1.3	F3 (Measure) Key – Configure Measurement .....	46
6.2	Temperature Measurement .....	47
6.2.1	Thermocouple Setting .....	47
6.2.2	Function Keys in More 2/3 Page .....	48
6.2.3	Function Keys in More 3/3 Page .....	49
6.2.3.1	Open Check Feature .....	49
6.2.4	Thermocouple Sensor Type .....	50
6.2.5	Reference Junction Temperature (SIM Temperature) .....	50
6.2.6	SIM Temperature Parameters .....	50
6.2.7	Thermistor 2W/4W Setting .....	51
6.2.8	Function Keys .....	51
6.2.9	Auto Zero and Configuration .....	51
6.2.10	RTD 2W/4W Setting .....	51
6.2.11	RTD User Type Coefficients .....	52
6.2.12	Additional Functions .....	52
6.3	Strain Measurement .....	53
6.3.1	Full & Half Bending Bridge Setting .....	53
6.3.2	Configuration Menus (More 2/3) .....	54
6.3.3	Excitation Configuration (More 3/3) .....	55
6.3.4	Full & Half Poisson Bridge Setting .....	55
6.4	Full Bending Poisson Bridge Setting .....	56
6.4.1	Function Keys in More 2/3 Page .....	57
6.4.2	Function Keys in More 3/3 Page .....	58
6.5	Quarter Bridge Setting .....	59
6.5.1	Quarter Bridge Setting Page 1 .....	59
6.5.2	Quarter Bridge Setting Page 2 .....	60
6.5.3	Quarter Bridge Setting Page 3 .....	61
6.6	DC and AC Measurements 1/2 Page .....	62
6.6.1	Voltage Source and Module Terminal Connection .....	62
6.6.1.1	F1 (Auto Zero) Key – Enable Auto Zero (DCV Only) .....	62
6.6.1.2	F1 (Auto Zero) Key – Enable Auto Zero (DCV Only) .....	63

6.6.1.3	F1 (Auto Zero) Key – Enable Auto Zero (DCV Only)	63
6.6.2	DC and AC Measurements 2/2 Page	63
6.6.2.1	F1 (Auto Zero) Key – Enable Auto Zero (DCV Only)	63
6.6.2.2	F1 (Auto Zero) Key – Enable Auto Zero (DCV Only)	64
6.6.2.3	F1 (Auto Zero) Key – Enable Auto Zero (DCV Only)	64
6.7	2W & 4W Direct Setting	66
6.7.1	Function Keys in More 2/3 page	67
6.7.2	Function Keys in More 3/3 page	68
6.8	2-Wire & 4-Wire Resistance Measurement	69
6.8.1	2 and 4 Wire Resistance Measurement Range	70
6.9	Frequency/Period Measurement	72
6.9.1	Frequency Period Measurement Page 2	73
6.10	Diode Measurement	74
6.10.1	Diode Measurement 2/2 page	75
6.11	Capacitance Measurement	76
6.11.1	Function Keys in More 2/2 page	77
6.12	DCI/ACI Measurement	78
6.12.1	DCI/ACI Measurement Page 2	79
6.13	Scan 2-Wire & 4-Wire Measurement	80
6.14	Switch Mode for Multiplexer Modules	81
6.14.1	Display	82
6.15	Computer Channels	83
6.15.1	Types	83
6.16	Basic Math	84
6.16.1	Steps	84
6.17	Statistics	85
6.18	Polynomial 5TH	86
7	Trigger Menu	87
7.1	Additional Trigger Configuration	88
8	Edit Menu	89
8.1	Copy Channels	90
9	Alarm Menu	92
9.1	Alarm Configuration	93
9.2	Alarm in Monitor Mode	95
10	View Menu	96
10.1	View Data	96
10.1.1	List Display	97
10.1.2	Statistics Display	98
10.1.3	Trend Chart Display	99
10.1.4	VScale Settings	100

10.1.5	Knob Mode .....	101
10.2	Histogram Display .....	102
10.3	Alarm View .....	103
10.4	Error View .....	104
10.5	Relay Cycle View .....	105
11	Module Menu .....	106
12	Math Menu .....	108
12.1	Math Equations .....	108
12.2	dBm Measurement .....	109
12.2.1	Function Keys .....	109
12.3	Math Display Modes .....	109
12.3.1	Show STAT Result .....	109
12.3.2	Show Math Result .....	110
12.3.3	Show Alarm Result .....	110
12.3.4	Show ALR+STAT Result .....	110
12.4	dB Measurement .....	111
12.4.1	Function Keys .....	111
12.4.1.1	Show STAT Result .....	112
12.4.1.2	Show Math Result .....	112
12.4.1.3	Show Alarm Result .....	112
12.4.1.4	Show ALR+STAT Result .....	113
12.5	MX+B Measurement .....	114
12.5.1	Show STAT Result .....	114
12.5.2	Show Math Result .....	114
12.5.3	Show Alarm Result .....	115
12.5.4	Show ALR+STAT Result .....	115
12.5.5	Function Keys in More 2/2 page .....	115
12.6	1/X Measurement .....	116
12.6.1	Show STAT Result .....	116
12.6.2	Show Math Result .....	116
12.6.3	Show Alarm Result .....	116
12.6.4	Show ALR+STAT Result .....	117
12.7	Percent Measurement .....	118
12.7.1	Show STAT Result .....	118
12.7.2	Show Math Result .....	119
12.7.3	Show Alarm Result .....	119
12.7.4	Show ALR+STAT Result .....	119
13	Average Menu .....	120
13.1	Average Process .....	121
14	Log Menu .....	122

14.1	Capture Function .....	123
14.2	Scan Data Function .....	124
15	Digital I/O Overview .....	125
15.1	Pin Assignment .....	126
15.2	Application: Alarm Output .....	126
15.2.1	Alarm Output Connection .....	127
15.2.2	Activate Alarm Output .....	127
15.2.2.1	Alarm Limit Modes .....	127
15.2.2.2	Alarm Settings .....	127
15.3	Application: External Trigger .....	128
15.3.1	Signal Connection .....	128
15.3.2	Activate External Trigger .....	128
16	System and Firmware Menu .....	129
16.1	View System Info .....	129
16.2	Firmware Update .....	130
16.2.1	Update Process .....	130
16.2.1.1	Firmware File Naming .....	130
16.2.1.2	Firmware Update Steps .....	130
17	Menu Settings .....	131
17.1	Configure System .....	132
17.1.1	Beep Setting .....	132
17.1.2	Key Sound Setting .....	132
17.1.3	Date Setting .....	132
17.1.4	Time Setting .....	132
17.1.5	TimeSync Setting .....	133
17.1.5.1	Options .....	133
17.1.6	Save and Load Parameters .....	133
17.1.7	Copy Parameters To/From USB .....	133
17.1.8	Steps to Copy from USB .....	134
17.1.9	Calibration Setting .....	134
17.1.9.1	Frequency Calibration .....	134
17.1.9.2	DC Gain Calibration .....	134
17.1.10	Firmware Update .....	134
17.1.11	Security Settings .....	135
17.1.11.1	Options .....	135
17.1.12	View System Info .....	135
17.2	Display Settings .....	135
17.2.1	Brightness and Auto-Off Settings .....	135
17.2.2	Color and Theme Settings .....	135
17.2.3	Language Setting .....	135

18 Remote Interface	136
18.1 Configure Interface .....	137
18.1.1 Return to Local Control Mode .....	137
18.1.2 Configure SCPI ID Setting .....	137
18.2 Configure USB Interface .....	138
18.2.1 Set the USB Protocol .....	138
18.3 Configure GPIB Interface .....	139
18.4 Activate Ethernet Interface .....	140
18.5 Web Control Interface .....	141
19 Specifications	142
20 Service Information	146
21 LIMITED THREE-YEAR WARRANTY	147

# Compliance Information

## 1.1 EMC

### EC Declaration of Conformity - EMC

Compliance was demonstrated to the following specifications listed in the Official Journal of the European Communities: EMC Directive 2014/30/EU.

**EN IEC 61326-1:2021** Electrical equipment for measurement, control and laboratory use.  
EMC requirements - General requirements

**EN IEC 61326-2-2:2021** Electrical equipment for measurement, control and laboratory use  
- EMC requirements - Part 2-2

**EN IEC 61000-3-2:2019/A1:2021** Electromagnetic compatibility (EMC) - Limits. Limits for  
harmonic current emissions (equipment input current  $\leq 16$  A per phase)

**EN IEC 61000-3-3:2013/A2:2021** Electromagnetic compatibility (EMC) - Part 3-3: Limits -  
Limitation of voltage changes, voltage fluctuations and flicker in public low-voltage supply  
systems, for equipment with rated current  $\leq 16$  A per phase and not subject to conditional  
connection

---

## 1.2 IEC Measurement Category & Pollution Degree Definitions

---

**Measurement Category (CAT)** - classification of testing and measuring circuits according to the types of mains circuits to which they are intended to be connected.

**Measurement Category other than II, III, or IV** : circuits that are not directly connected to the mains supply.

**Measurement Category II (CAT II)** : test and measuring circuits connected directly to utilization points (socket outlets and similar prints) of the low-voltage mains installation.

**Measurement Category III (CAT III)** : test and measuring circuits connected to the distribution part of a building's low-voltage mains installation.

**Measurement Category IV (CAT IV)** : test and measuring circuits connected at the source of the building's low-voltage mains installation.

**Mains Isolated** : is for measurements performed on circuits not directly connected to a mains supply.

**Pollution** - addition of foreign matter, solid, liquid, or gaseous (ionized gases) that may produce a reduction of dielectric strength or surface resistivity.

**Pollution Degree 2 (P2)** - only non-conductive pollution occurs except that occasionally a temporary conductivity caused by condensation is expected

## 1.3 Product End-of-Life Handling

---

The equipment may contain substances that could be harmful to the environment or human health if improperly handled at the product's end of life. To avoid release of such substances into the environment and to reduce the use of natural resources, we encourage you to recycle this product to an appropriate system that will ensure that most of the materials are reused or recycled appropriately.



This product is subject to Directive 2012/19/EU of the European Parliament and the Council of the European Union on waste electrical and electronic equipment (WEEE), and in jurisdictions adopting that Directive, is marked as being put on the market after August 13, 2005, and should not be disposed of as unsorted municipal waste. Please utilize your local WEEE collection facilities in the disposition of this product.

## 1.4 Terms and Symbols

---

### Terms

---



**A caution statement calls attention to an operating procedure, practice, or condition, which, if not followed correctly, could result in damage to or destruction of parts or the entire product.**

---



**A warning statement calls attention to an operating procedure, practice, or condition, which, if not followed correctly, could result in injury or death to personnel.**

---



**A note statement calls attention to an operating procedure, practice, or condition, which, should be noted before proceeding.**

---

## Symbols



**WARNING - HIGH VOLTAGE - possibility of electric shock.**

---



**CAUTION – Statements or instructions that must be consulted in order to find out the nature of the potential hazard and any actions which must be taken.**

---



On (Supply). This is the AC mains connect/disconnect switch on the front of the instrument.

---

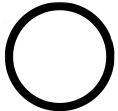

Off (Supply). This is the AC mains connect/disconnect switch on the front of the instrument.

---



Alternating current

---



Chassis (earth ground) symbol

---



**Earth (ground) TERMINAL** - Refer to the instructions accompanying this symbol in this manual.

---

# Safety Notices

The following safety precautions apply to both operating and maintenance personnel and must be followed during all phases of operation, service, and repair of this instrument.

Before applying power to this instrument:

- Read and understand the safety and operational information in this manual.
- Apply all the listed safety precautions.
- Verify that the voltage selector at the line power cord input is set to the correct line voltage. Operating the instrument at an incorrect line voltage will void the warranty.
- Make all connections to the instrument before applying power.
- Do not operate the instrument in ways not specified by this manual or by B&K Precision.

Failure to comply with these precautions or with warnings elsewhere in this manual violates the safety standards of design, manufacture, and intended use of the instrument. B&K Precision assumes no liability for a customer's failure to comply with these requirements.

## Electrical Power

This instrument is intended to be powered from a CATEGORY II mains power environment. The mains power should be 115 V RMS or 230 V RMS. Use only the power cord supplied with the instrument and ensure it is appropriate for your country of use.



**Do not use this instrument in an electrical environment with a higher category rating than what is specified in this manual for this instrument.**

---



**You must ensure that each accessory you use with this instrument has a category rating equal to or higher than the instrument's category rating to maintain the instrument's category rating. Failure to do so will lower the category rating of the measuring system.**

---

## Ground the Instrument

---

**⚠ WARNING**

To minimize shock hazard, the instrument chassis and cabinet must be connected to an electrical safety ground. This instrument is grounded through the ground conductor of the supplied, three-conductor AC line power cable. The power cable must be plugged into an approved three-conductor electrical outlet. The power jack and mating plug of the power cable meet IEC safety standards.

---

**⚠ WARNING**

Do not alter or defeat the ground connection. Without the safety ground connection, all accessible conductive parts (including control knobs) may provide an electric shock. Failure to use a properly-grounded approved outlet and the recommended three-conductor AC line power cable may result in injury or death.

---

**⚠ WARNING**

Unless otherwise stated, a ground connection on the instrument's front or rear panel is for a reference of potential only and is not to be used as a safety ground. Do not operate in an explosive or flammable atmosphere.

---

## **Environmental Conditions**

---

This instrument is intended to be used in an indoor pollution degree 2 environment. The operating temperature range is 0°C to 40°C and 20% to 80% relative humidity, with no condensation allowed.

Measurements made by this instrument may be outside specifications if the instrument is used in non-office-type environments. Such environments may include rapid temperature or humidity changes, sunlight, vibration and/or mechanical shocks, acoustic noise, electrical noise, strong electric fields, or strong magnetic fields.



**Do not operate the instrument in the presence of flammable gases or vapors, fumes, or finely-divided particulates.**

---

**The instrument is designed to be used in office-type indoor environments. Do not operate the instrument**

- **In the presence of noxious, corrosive, or flammable fumes, gases, vapors, chemicals, or finely-divided particulates.**
  - **In relative humidity conditions outside the instrument's specifications.**
  - **In environments where there is a danger of any liquid being spilled on the instrument or where any liquid can condense on the instrument.**
  - **In air temperatures exceeding the specified operating temperatures.**
  - **In atmospheric pressures outside the specified altitude limits or where the surrounding gas is not air.**
  - **In environments with restricted cooling air flow, even if the air temperatures are within specifications.**
  - **In direct sunlight.**
- 



### Do not operate instrument if damaged

**⚠ WARNING**

If the instrument is damaged, appears to be damaged, or if any liquid, chemical, or other material gets on or inside the instrument, remove the instrument's power cord, remove the instrument from service, label it as not to be operated, and return the instrument to B&K Precision for repair. Notify B&K Precision of the nature of any contamination of the instrument.

---

**⚠ WARNING**

Hazardous voltages may be present in unexpected locations in circuitry being tested when a fault condition in the circuit exists.

---

### Clean the instrument only as instructed

**⚠ WARNING**

Do not clean the instrument, its switches, or its terminals with contact cleaners, abrasives, lubricants, solvents, acids/bases, or other such chemicals. Clean the instrument only with a clean dry lint-free cloth or as instructed in this manual. Not for critical applications.

---

## **Do not touch live circuits**

---

### **⚠ WARNING**

**Instrument covers must not be removed by operating personnel. Component replacement and internal adjustments must be made by qualified service-trained maintenance personnel who are aware of the hazards involved when the instrument's covers and shields are removed. Under certain conditions, even with the power cord removed, dangerous voltages may exist when the covers are removed.**

---

To avoid injuries, always disconnect the power cord from the instrument, disconnect all other connections (for example, test leads, computer interface cables, etc.), discharge all circuits, and verify there are no hazardous voltages present on any conductors by measurements with a properly-operating voltage-sensing device before touching any internal parts. Verify the voltage-sensing device is working properly before and after making the measurements by testing with known-operating voltage sources and test for both DC and AC voltages.

Do not attempt any service or adjustment unless another person capable of rendering first aid and resuscitation is present.

## **General Safety**

---

### **⚠ WARNING**

**Do not insert any object into an instrument's ventilation openings or other openings.**

---

### **⚠ WARNING**

**This instrument is not authorized for use in contact with the human body or for use as a component in a life-support device or system.**

---

## Servicing

**⚠ WARNING**

Do not substitute parts that are not approved by B&K Precision or modify this instrument. Return the instrument to B&K Precision for service and repair to ensure that safety and performance features are maintained.

---

**⚠ WARNING**

Fuse replacement must be done by qualified service-trained maintenance personnel who are aware of the instrument's fuse requirements and safe replacement procedures. Disconnect the instrument from the power line before replacing fuses. Replace fuses only with new fuses of the fuse types, voltage ratings, and current ratings specified in this manual or on the back of the instrument. Failure to do so may damage the instrument, lead to a safety hazard, or cause a fire. Failure to use the specified fuses will void the warranty.

---

## For continued safe use of the instrument

- Do not place heavy objects on the instrument.
- Do not obstruct cooling air flow to the instrument.
- Do not place a hot soldering iron on the instrument.
- Do not pull the instrument with the power cord, connected probe, or connected test lead.
- Do not move the instrument when a probe is connected to a circuit being tested.

# Introduction

The DAQ3120 benchtop data acquisition system combines a 6½-digit DMM with a modular design for versatile measurement and analysis.

The 3-slot mainframe and built-in DMM offer flexibility and high-resolution (0.0035% basic DCV accuracy). It measures 14 signal types including; temperature, voltage, current, resistance, frequency, capacitance, and strain. Five switch modules customize functionality, with the DM309 extending voltage range and the DM300 enabling scan rates up to 450 channels/s.

The system captures high-speed data (38.4 kSa/s sample rate), stores 100 kpts internally, and logs data via USB. Connectivity includes LAN, USB, and optional micro GPIB. Included DAQ-Data logger software simplifies test configuration and control.

---

## 3.1 Package Contents

---

Please inspect the instrument mechanically and electrically upon receiving it. Unpack all items from the shipping carton, and check for any obvious signs of physical damage that may have occurred during transportation. Report any damage to the shipping agent immediately. Save the original packing carton for possible future reshipment. Every electronic load is shipped with the following contents:

### Mainframe Box

---

- 1 x DAQ3120 Mainframe
- 1 x AC Power Cord
- 1 x Certificate of Calibration

### Module Box

---

- 1 x DAQ Module

## NOTICE

Verify that all items above are included in the shipping container. If anything is missing, please contact B&K Precision.

---

## **3.2 Features**

1. 3-slot base unit with built-in 6 ½ digit DMM
2. Basic 0.0035% DCV accuracy
3. 7 modules available to customize with
  - DM300 20-CH Solid-State Mux
  - DM301 20-CH Mux with 2 Current CH
  - DM303 40-CH Single-ended Mux
  - DM304 4 x 8 Matrix
  - DM307 Multifunction Module
  - DM308 Actuator/General Purpose Switch
  - DM309 High Voltage and Current Mux
4. Measures up to 600 V DC / 400 V AC
5. Up to 450 channels/s scan rate
6. Up to 120 channels per system
7. 100 kpts internal memory
8. Measures and converts 14 different input signals:
  - Temperature with thermocouples, RTDs, and thermistors
  - DC/AC voltage and current
  - Resistance with 2-wire and 4-wire
  - Direct strain and bridge strain
  - Frequency and period
  - Capacitance
9. Large 4.3" TFT color display
10. Copy or log data directly to a USB drive
11. Includes digital I/O, LAN, USB host, USB device, and micro GPIB (-GPIB model only) interfaces
12. Supports remote operation through free PC software or the built-in web interface

### 3.3 Dimensions

The MPS mainframe dimensions are approximately:  
 266.9 mm (10.5 in) x 107 (4.2 in) x 357.8 mm (14.1 in)(W x H x D)

Configuration	Dimensions (W x H x D)	Weight
Rack	8.7 x 3.5 x 13.7 in (220 x 88 x 348.6 mm)	9.92 lbs (4.5 kg)
Bench	10.5 x 4.2 x 14.1 in (266.9 x 107 x 357.8 mm)	9.92 lbs (4.5 kg)

**Table 3.1** Dimmensions



**Figure 3.1** Dimensions

### 3.4 Front Panel

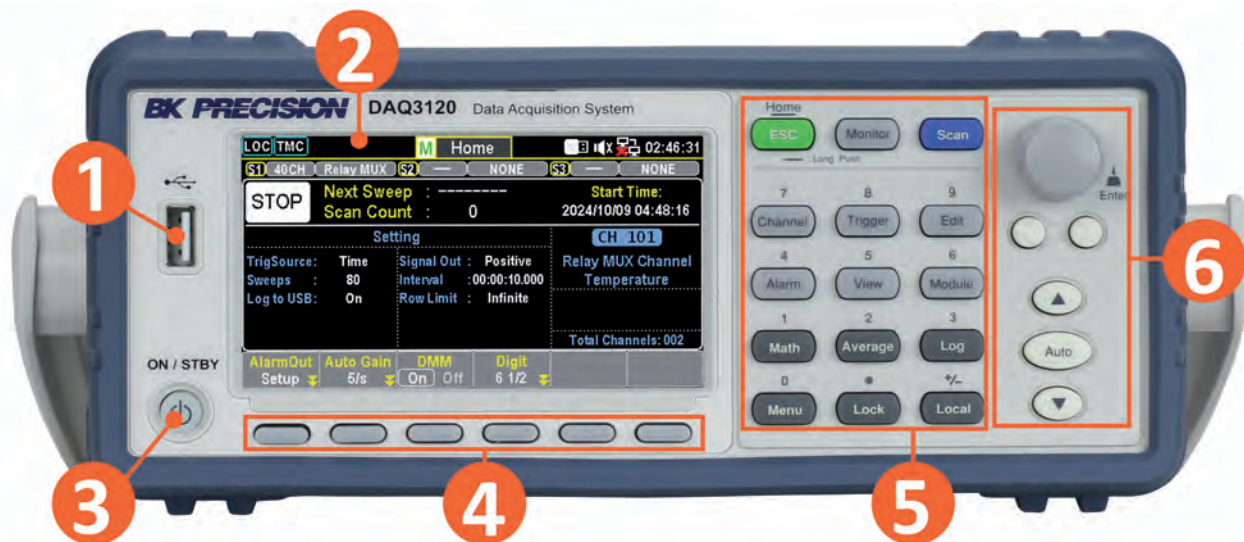

**Figure 3.2** Front Panel

Item	Name	Description
1	USB Host Port	USB port used to connect flash drives.
2	Display	Visual presentation of the device function and measurements.
3	Power Button and LED	Switch the instrument between normal operation mode and screen-saver mode. The LED indicates power is on. Green indicates normal operation. Amber indicates display is in screen-saver mode.
4	Soft Keys	Used to select the current function displayed in the bottom of the menu.
5	Numeric Keypad	Used to enter precise values.
6	Navigation Keys	Used to navigate menus or configure parameters.

**Table 3.2** Front Panel

**3.5 Rear Panel**



**Figure 3.3** Rear Panel

Item	Name	Description
1	Module Slots	Three plug-in module installation slots.
2	GPIB Interface	GPIB interface connector.
3	AC power input & fuse box	Houses the IEC 320 connector and the fuse.
4	Digital I/O	Send or receive a signal to or from an external device.
5	LAN interface	LAN interface connector Left LED indicates activity. Right LED indicates link integrity.
6	USB interface	Connect a USB type B to type A to remotely control the unit. (USBTMC and USBVCP connector)

**Table 3.3** Rear Panel

### 3.6 Model Descriptions

DAQ3120 Modules Overview								
Module	Input Type	No. of Channels	Speed (CH/s)	Max. Voltage	Max. Current	Bandwidth	Thermal Offset	Internal DMM
<b>DM300</b> Solid-State Multiplexer	2-wire solid-state (4-wire selectable)	20	450	120 V	-	10 MHz	<4 $\mu$ V	✓
<b>DM301</b> Multiplexer with Current CH	2-wire armature (4-wire selectable)	20 + 2 <sup>(1)</sup>	80	300 V	1 A	10 MHz	<4 $\mu$ V	✓
<b>DM303</b> Single-Ended Multiplexer	1-wire armature (common low)	40	80	300 V	-	10 MHz	<1 $\mu$ V	✓
<b>DM304</b> 4 x 8 Matrix	2-wire armature	32	-	300 V	-	10 MHz	<1 $\mu$ V	-
<b>DM307</b> Multifunction Module	16-bit Digital I/O	16 <sup>(2)</sup>	-	42 V	-	-	-	-
	100 kHz Totalizer input	1	-	42 V	-	10 MHz		
	18-bit DAC output	2	-	$\pm$ 12 V	$\pm$ 24 mA	-		
<b>DM308</b> Actuator/General Purpose Switch	Single Pole Double Throw (Form C relay)	20	-	300 V	-	-	<4 $\mu$ V	-
<b>DM309</b> High Voltage and Current	2-wire armature (4-wire selectable)	8 + 2 <sup>(1)</sup>	60	600 V DC 400 V AC	2 A	10 MHz	<4 $\mu$ V	✓

Supported DMM Functions										
Modules	AC/DC Voltage	AC/DC Current	Frequency & Period	2-Wire Resistance	4-wire Resistance	Thermocouple	2-Wire RTD	4-Wire RTD	Thermistor	Capacitance
<b>DM300</b> Solid-State Multiplexer	✓	-	✓	✓	✓	✓	-	-	-	-
<b>DM301</b> Multiplexer with Current CH	✓	✓	✓	✓	✓	✓	✓	✓	✓	✓
<b>DM303</b> Single-Ended Multiplexer	✓	-	✓	✓	-	-	✓	-	✓	✓
<b>DM309</b> High Voltage and Current	✓	✓	✓	✓	✓	✓ <sup>(3)</sup>	✓	✓	✓	✓

(1) The additional two channels are dedicated current inputs  
 (2) Channels are split into two 8-bit digital input/output registers  
 (3) Requires external cold junction and manual reference setting

**Table 3.4** Modules Description

# Installation

4.1	Preliminary Information .....	24
4.2	Module Slot Cover Removing .....	26
4.3	Module Installation .....	27
4.4	Module Revomal .....	29
4.4.1	Step .....	29
4.5	Fuse Replacement .....	30

---

## 4.1 Preliminary Information

---

Before getting started, please inspect the instrument mechanically and electrically upon receiving it. Unpack all items from the shipping carton, and check for any obvious signs of physical damage that may have occurred during transportation. Report any damage to the shipping agent immediately.

Save the original packing carton for possible future reshipment.

### Review Safety Information

---

This power system is a Safety Class 1 instrument, which means it has a protective earth terminal. That terminal must be connected to earth ground through a power source equipped with a ground receptacle.

Refer to the Safety Summary page at the beginning of this guide for general safety information. Before installation or operation, check the power system and review this guide for safety warnings and instructions. Safety warnings for specific procedures are located at appropriate places throughout this manual.



**Ensure the correct line voltage is clearly shown on the fuse socket .  
If not, refer to [Fuse Replacement](#) to proper set line voltage and fuse.**

---

### NOTICE

Ensure the ground connector on the power cord is connected to a safety ground.  
This will affect the measurement accuracy.

---

## **Observe Environmental Conditions**

---

The environmental conditions of the instrument are documented under Environmental Characteristics. The unit should only be operated indoors in a controlled environment.

The dimensions of your instrument as well as an outline diagram are also documented under Specifications. A fan cools the power system by drawing air through the sides and exhausting it out the back. The instrument must be installed in a location that allows sufficient space at the sides and back of the unit for adequate air circulation

## 4.2 Module Slot Cover Removing

Prior to module installation, follow the steps below for how to remove a module slot cover from the DAQ3120 unit.

**Step 1.** First, release the inner hook by pressing on the curved area from either the right or left side of the slot cover. Use your finger to subtly shake the curved area to unleash the inner hook from the DAQ3120 unit.

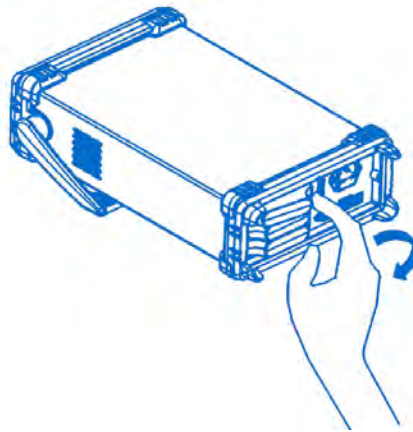

**Figure 4.1** Unleash Cover

**Step 2.** Use two fingers to grip the curved areas on both the right and left sides of the slot cover and gently pull outward to remove the slot cover from the DAQ3120 unit.

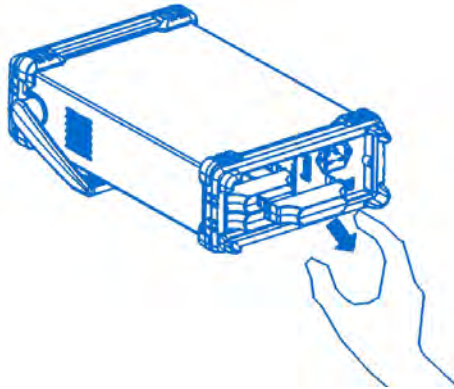

**Figure 4.2** Remove Cover

### NOTICE

Press and shake the curved area from either the right or left side alternately when it is difficult to release the inner hook on one side.

### **4.3 Module Installation**

Follow the steps below for how to connect a wire to a module and install it into a slot on the rear panel of the DAQ3120 unit.

- Step 1.** Use a Phillips-head screwdriver to loosen the screw from the top of the module, then remove the upper cover from the module.

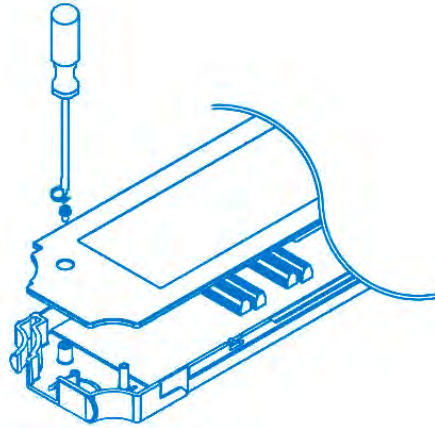

**Figure 4.3** Remove Module Cover

- Step 2.** With the help of a Phillips-head screwdriver, connect the wire to the terminal and route the wire to the end port of the module.

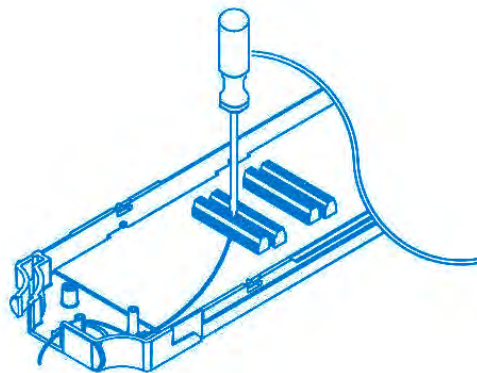

**Figure 4.4** Connect Wire to Module

**Step 3.** Restore the upper cover back onto the module and fasten the screw using a Phillips-head screwdriver.

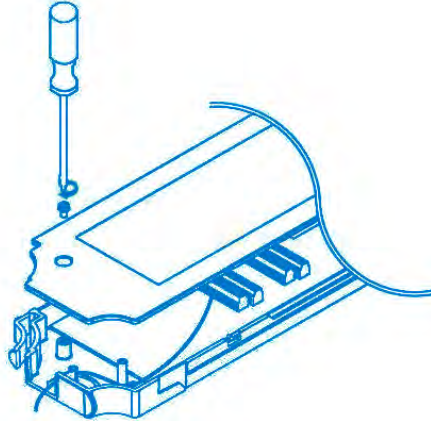

**Figure 4.5** Screw Module Cover

**Step 4.** Insert the module into one of the module slots on the rear panel of the DAQ3120 unit.

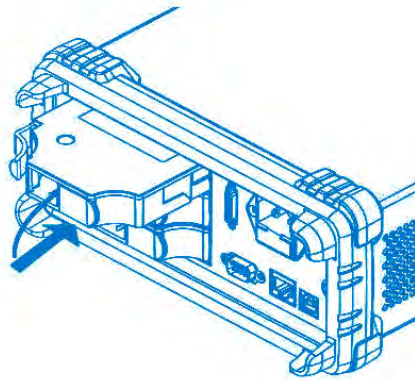

**Figure 4.6** Insert Module

## 4.4 Module Removal

Follow the step below for how to uninstall a module from a slot on the rear panel of the DAQ3120 unit.

### 4.4.1 Step

**Step 1.** First, push inward the clip at the rear-left corner of the module, then pull the module out from a slot on the rear panel of the DAQ3120 unit.

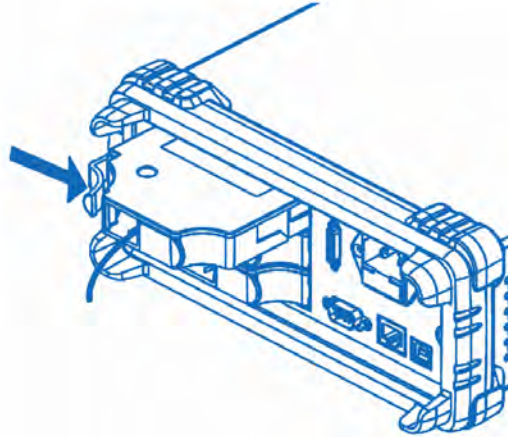

**Figure 4.7** Remove Module

### **NOTICE**

Installing or uninstalling the modules from the slots on the rear panel while the device is powered on will reboot the DAQ3120 unit.

---

## 4.5 Fuse Replacement

The fuse is accessible through the rear panel beneath the IEC 320 connector.

Table 4.1 shows the fuse requirements.

Model	Fuse Specification
MPS1000	T10AL 250V
MPS1001	T10AL 250V

Table 4.1 Fuse Specification



**No power should be applied to the instrument while replacing the fuse. Disconnect all cables connected to the instrument before proceeding.**

---

### Fuse Replacement Procedure

- Step 1.** Locate the fuse box in the rear panel beneath the IEC 320 connector. (See [figure 3.3](#))
- Step 2.** Insert a small flathead screwdriver into the fuse box slit to slide out the fuse box as illustrated in [figure 4.8](#).
- Step 3.** Check the fuse to determine if it must be replaced.

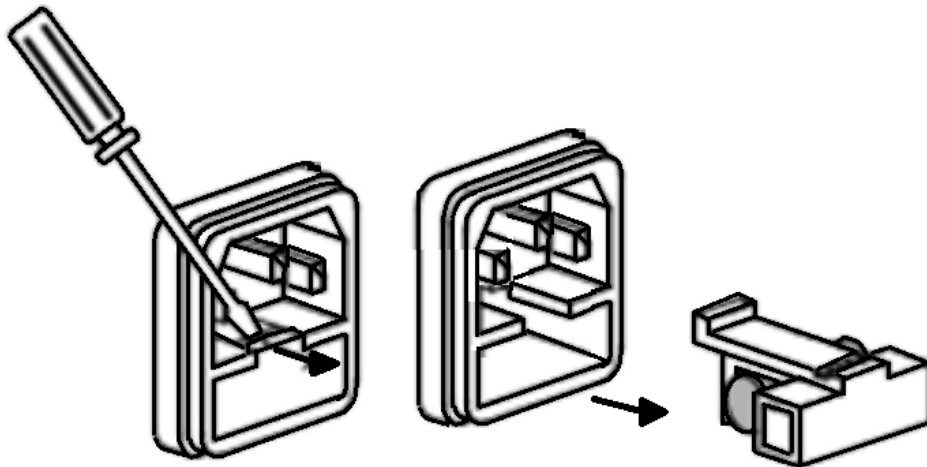

Figure 4.8 Fuse Removal

# Operation Menus

The DAQ3120 Series offers three operation menus; Home, Monitor, and Scan.

5.1	Home Menu	32
5.1.1	Alarm Mode Settings (F1 - AlarmOut Key)	33
5.1.2	Auto Gain Settings (F2 - Auto Gain Key)	33
5.1.3	DMM Function Control (F3 - DMM Key)	33
5.1.4	Digit Display Settings (F4 - Digit Key)	33
5.1.5	Strain Offset Configuration (F5 - Strain Key)	34
5.2	Monitor Mode	35
5.3	Number Display	36
5.4	Bar Meter Display	36
5.5	Trend Chart Display	36
5.5.1	Number Display (F1 - Display Key)	37
5.5.2	Bar Meter Display (F1 - Display Key)	37
5.5.3	Trend Chart Display (F1 - Display Key)	37
5.5.4	Histogram Display (F1 - Display Key)	38
5.6	Scan Mode	39
5.6.1	Initiating Scan Mode	39
5.6.2	Scan Course Execution	39
5.6.3	Data Storage	39
5.6.4	Stopping Scan Mode	39
5.6.5	Scan Mode Display	39
5.6.6	Alarm Clear	40
5.7	Scan Mode with Monitor Mode Simultaneously	41

## 5.1 Home Menu

Press and hold the Home key on the front panel for one second to access the Home menu, where various basic settings are displayed.

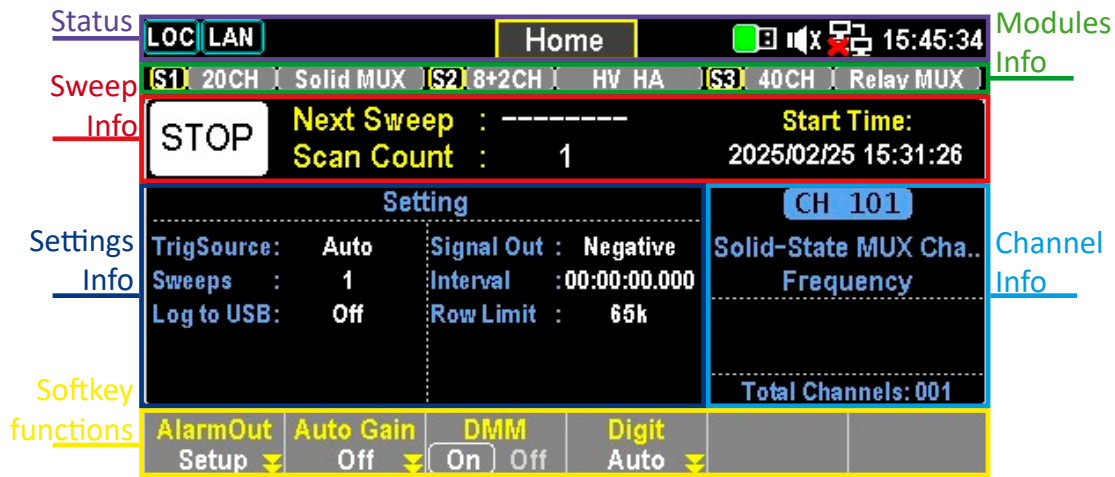

**Figure 5.1** Home Menu

Section	Description
Status	Displays the instruments remote, alarm, LAN, sound, USB and time status.
Module Info	Displays the module slot number, module name, and the total number of channels for each module. Up to three installed modules can be displayed.
Scan Info	Indicates the status and relevant information of Scan mode.
Channel & Alarm	The upper section displays the current channel number, module name, and measurement type. Use the knob key or arrow keys to navigate channels. The lower section shows alarm-related information, displaying up to four triggered alarms in red. Each alarm output is split into upper and lower halves to indicate high and low limit triggers. The total number of activated channels is also displayed in this section.
Settings Info	Displays a few basic settings such as trigger source, sweep count, log status, signal out, interval, and row limit.
Softkey Functions	Displays the current function of the softkeys for configuring various functions.

**Table 5.1** Home Menu

### 5.1.1 Alarm Mode Settings (F1 - AlarmOut Key)

---

- Alarm Mode
  - **Latch:** The triggered alarm output remains active until manually cleared by the user.
  - **Track:** The alarm output is automatically cleared when the measured value returns within limits.
- Alarm Output Configuration
  - **Pos:** All four alarm output lines indicate an alarm at 3.3V.
  - **Neg:** All four alarm output lines indicate an alarm at 0V.
- Alarm Clear Options
  - **Alarm 1 to 4:** Clears the alarm state of a selected alarm output line.
  - **All:** Clears alarm states of all four alarm output lines.

### 5.1.2 Auto Gain Settings (F2 - Auto Gain Key)

---

In Scan Mode, where multiple channel sweeps occur over an extended period, activating **Auto Gain** helps maintain the reference voltage, which may drift over time. Enabling Auto Gain slightly extends the total scan time due to an additional gain adjustment before each sweep.

### 5.1.3 DMM Function Control (F3 - DMM Key)

---

The DAQ3120 includes an internal **DMM (Digital Multimeter)** function, allowing up to three modules to measure multiple DUTs (Devices Under Test). However, in some applications, an external DMM may be needed while still utilizing DAQ3120's multi-channel switching capabilities.

- **DMM Enabled:** The internal DMM is active.
- **DMM Disabled:** DAQ3120 functions as a switching hub, routing DUT signals to an external DMM for measurement. When disabled, the DMM icon appears in the status bar, and measurement settings for each channel become limited.

### 5.1.4 Digit Display Settings (F4 - Digit Key)

---

Defines the maximum number of digits displayed for measurement readings.

- **Auto:** The digit count adjusts automatically based on the measurement function and refresh rate.
- **6 ½ Digits:** Fixed at 6 ½ digits for maximum precision.
- **5 ½ Digits:** Fixed at 5 ½ digits for standard precision.
- **4 ½ Digits:** Fixed at 4 ½ digits for faster readings with lower precision.

### 5.1.5 Strain Offset Configuration (F5 - Strain Key)

When measuring strain, Strain Offset can be applied for compensation.

- **Select:** Opens a list of strain-measurement channels. Use the knob or arrow keys to navigate and press Select or SelectAll to confirm. Use Cancel or ClearAll to deselect. Press OK to confirm or Exit to leave without saving.
- **Get Offset:** Instantly retrieves and displays offset values for selected channels.
- **Clear:** Resets offset values to 0 for selected channels.

## 5.2 Monitor Mode

Press the **Monitor** key on the front panel to activate the monitor function and view real-time measurements for a selected channel. If **Scan Mode** is running simultaneously, the displayed reading updates only when the selected channel is scanned during a sweep. Press the **Monitor** key again to exit monitor mode. Refer to the diagram below for details.



**Figure 5.2** Monitor Display

Section	Description
Monitor Icon	Displays the status icon and menu identification, indicating that Monitor mode is active.
Select Channel	Use the knob or arrow keys to navigate channels. The selected channel number and its configurations are shown here.
Measured Reading	Displays the real-time measured reading of the selected channel.
Softkey Functions	Provides access to function keys for configuring various display modes. Refer to the following subchapters for more details.

**Table 5.2** Monitor Display

## 5.3 Number Display

Displays measured readings in numerical format. The maximum digit count depends on the **Digit** configuration.

- **Restart:** When **STAT** in **MathDisp** is enabled, pressing **Restart** remeasures STAT values.

## 5.4 Bar Meter Display

Shows a bar meter in the lower section with a numerical display on top. The number display digit limit depends on the Digit configuration.

- **Scale Options:**
  - **Normal:** The bar meter scale is symmetric with the selected measurement range.
  - **Manual:** Customizable scale with two methods:
    - **LowHigh:** Set specific high and low values.
    - **Center:** Define the center value and span scale.

## 5.5 Trend Chart Display

Displays a trend chart in the lower section with a numerical display on top. The number display digit limit depends on the Digit configuration.

- **Vertical Scale (VScale) Options:**
  - **Normal:** Symmetric vertical scale based on the measurement range.
  - **Manual:** Customizable vertical scale:
    - **L & H:** Set upper and lower limit values.
    - **Auto(Once):** Automatically adjusts based on the latest 400 measurement counts.
- **Horizontal Scale (HScale) Options:**
  - **Count:** Adjusts the trend speed based on measurement speed (e.g., 50/s for fast updates, 1/s for slow updates).
- **Stop & View Mode:** Pause measurement and examine details using the Knob Key.

### NOTICE

Sections highlight different data points, including total counts, min/max values, delta, and scrolling range.

- **Cursor 1 & Cursor 2:** View the lowest and highest values per count.
- **Start/Restart:** Resume real-time measurement.

### 5.5.1 Number Display (F1 - Display Key)

---

- **Number Mode:** Displays readings in numerical format. The maximum digit count is determined by the *Digit* configuration.
- **Restart:** Functions like the *Restart* key in *Trend Chart* and *Histogram* displays. When *STAT* in *MathDisp* is enabled, pressing *Restart* remeasures *STAT* values. See page 115 for details.

### 5.5.2 Bar Meter Display (F1 - Display Key)

---

- **Bar Meter Mode:** The screen shows a *Bar Meter* in the lower section along with a *Number Display* on top. The digit count for the *Number Display* follows the *Digit* configuration.
- **Scale Options:**
  - **Normal:** The bar meter scale is symmetric with the measurement range.
  - **Manual:** Allows custom scaling:
    - a. **LowHigh Method:** Set high and low scale values manually.
    - b. **Center Method:** Define a *center value* and a *span scale* .

### 5.5.3 Trend Chart Display (F1 - Display Key)

---

- **Trend Chart Mode:** The screen shows a *Trend Chart* in the lower section along with a *Number Display* on top. The maximum digit count follows the *Digit* configuration.
- **Vertical Scale (VScale) Options:**
  - **Normal:** The vertical scale is symmetric with the measurement range.
  - **Manual:** Customize the vertical scale:
    - a. **L & H Method:** Set upper (H) and lower (L) values.
    - b. **Auto(Once) Method:** Adjusts automatically based on the last 400 measurement counts.
- **Horizontal Scale (HScale) Options:**
  - **Count Method:** Adjusts trend speed based on measurement speed. Higher speeds (e.g., 50/s) result in faster updates.
- **Stop & View Mode:** Pause measurement and analyze details using the *Knob Key* .
  - **Measurement Sections:**
    - a. **Green:** Total count before *Stop & View* activation.
    - b. **Yellow:** Scroll with the *Knob Key* to change movement range.
    - c. **Orange:** Lowest value within the selected count, including serial number and timestamp.
    - d. **Blue:** Highest value within the selected count, including serial number and timestamp.
    - e. **White:** Difference between highest and lowest values within the selected count.
    - f. **Purple:** Displays measurements in a fixed 400-count range.
    - g. **Red:** Indicates the moving range count when scrolling.
  - **Cursor 1 & Cursor 2:** Used for analyzing lowest and highest values within each count.
  - **Start/Restart:** Resumes measurement after pausing in *Stop & View* mode.

### 5.5.4 Histogram Display (F1 - Display Key)

- **Histogram Mode:** The screen shows a *Histogram Display* in the lower section along with a *Number Display* on top. The maximum digit count follows the *Digit* configuration.
- **Bins:** Displays up to **100 bins**, representing measured counts.
  - **Green:** Total measured bins accumulated.
  - **Red:** Highest section of measured values with its percentage of total counts.
  - **Yellow:** Currently measured reading in Number Display.
  - **Purple:** The histogram graph of measured bins.
  - **Blue:** Maximum bin numbers within the purple histogram section.
  - **Orange:** Horizontal scale range of the histogram.
- **Horizontal Scale (HScale) Options:**
  - **Auto:** The scale is symmetric with the set measurement speed.
  - **Manual:** Allows scale customization:
    - a. **L & H Method:** Set left and right scale limits.
    - b. **Auto(Once) Method:** Automatically adjusts based on the latest bin measurements.
- **Stop & View Mode:** Pause measurement and analyze histogram details using the *Knob Key*.
  - **Measurement Sections:**
    - a. **Green:** Displays the selected bin number. Scroll to change bins.
    - b. **Yellow:** Total accumulated measurement counts.
    - c. **Orange:** Exact percentage of total counts from the selected bin.
    - d. **Purple:** Lowest value measured within the selected bin.
    - e. **Blue:** Highest value measured within the selected bin.
    - f. **White:** Difference between the highest and lowest values in the bin.
  - **Start/Restart:** Resumes real-time measurement after pausing in *Stop & View* mode.

## 5.6 Scan Mode

### 5.6.1 Initiating Scan Mode

Press the *Scan* key on the front panel to start the scan function. During a scan course, the DAQ3120 scans all available channels with pre-configured measurement functions. Additionally, *Computer Channels* (401–420), whose computed formulas are pre-configured, are also included in the scan course. Refer to page 89 for more details on Computer Channels.

### 5.6.2 Scan Course Execution

- Channels without pre-configured measurement functions are automatically skipped.
- The DAQ3120 scans available channels sequentially from *Slot 1* to *Slot 3*, followed by *Computer Channels* (401–420).
- A *scan course* consists of user-defined sweeps.
- Each *sweep* represents one complete pass through all available channels.

### 5.6.3 Data Storage

- Up to **100,000 readings** with timestamps can be stored in memory during a scan course.
- Starting a new scan course *automatically clears* all readings from the previous scan.

### 5.6.4 Stopping Scan Mode

To halt an ongoing scan course, *press and hold* the *Scan* key for **1 second**. The scan process will stop instantly.

### 5.6.5 Scan Mode Display

The *Scan Mode* display closely resembles the *Home Mode* display. Refer to page 34 for details on the Home Mode diagram. The following section highlights information specific to the Scan Mode display.

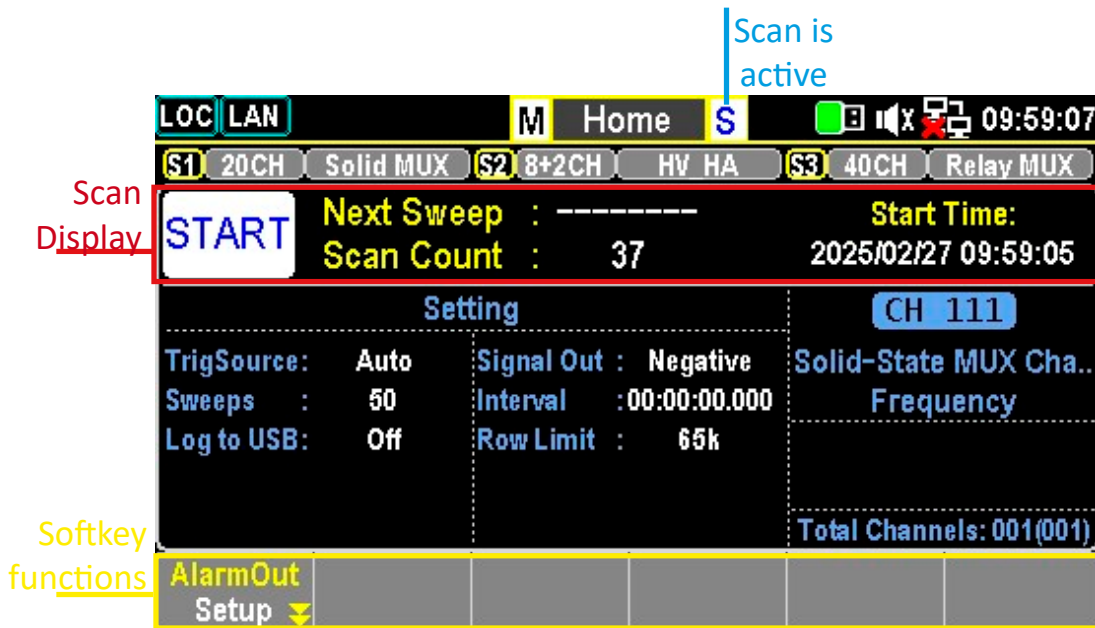

Figure 5.3 Scan Display

Section	Description
Start/Stop	The status becomes START after user presses Scan key. And it turns STOP after a scan course is completed or after user presses and holds Scan key for 1 second.
Next Sweep	It indicates the interval actions between each sweep. The actions vary in accordance with the Trig Source setting.
Scan Count	It indicates the completed counts of sweeps for a scan course. Scan counts of sweeps is based on Sweeps setting.
Start Time	The latest start date and time of a scan course is displayed here.
Softkey Functions	Provides access to function keys for configuring various display modes. Refer to the following subchapters for more details.

Table 5.3 Monitor Display

### 5.6.6 Alarm Clear

- **Alarm1 ~ 4:** Clears alarm state of a selected alarm output line.
- **All:** Clears alarm states of all 4 alarm output lines.

## 5.7 Scan Mode with Monitor Mode Simultaneously

Users can activate both *Scan Mode* and *Monitor Mode* simultaneously. When both modes are enabled, the measured reading of a selected channel is updated *only* when that channel is scanned during a sweep within a scan course.

Similar to *Monitor Mode*, users can navigate through channels using the knob or arrow keys to view the most recent measured reading for each channel.

- If the selected channel *has not* been scanned yet in the first sweep, no measured reading is displayed.
- Once the selected channel *is scanned* during a sweep, the measured reading appears on the display.
- The measured reading is updated *only* when the selected channel is scanned again in the next sweep.

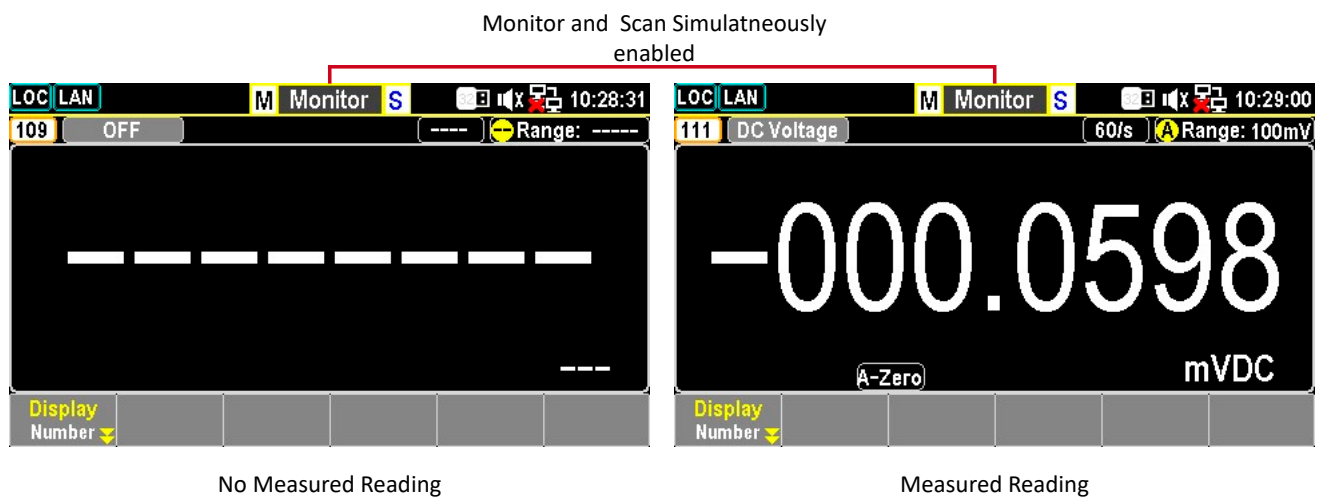

**Figure 5.4** Scan and Monitor

# Configuration Menus

6.1	Channel Menu	44
6.1.1	F1 (Channel) Key – Select a Channel	45
6.1.2	F2 (Label) Key – Assign a Channel Name	45
6.1.3	F3 (Measure) Key – Configure Measurement	46
6.2	Temperature Measurement	47
6.2.1	Thermocouple Setting	47
6.2.2	Function Keys in More 2/3 Page	48
6.2.3	Function Keys in More 3/3 Page	49
6.2.3.1	Open Check Feature	49
6.2.4	Thermocouple Sensor Type	50
6.2.5	Reference Junction Temperature (SIM Temperature)	50
6.2.6	SIM Temperature Parameters	50
6.2.7	Thermistor 2W/4W Setting	51
6.2.8	Function Keys	51
6.2.9	Auto Zero and Configuration	51
6.2.10	RTD 2W/4W Setting	51
6.2.11	RTD User Type Coefficients	52
6.2.12	Additional Functions	52
6.3	Strain Measurement	53
6.3.1	Full & Half Bending Bridge Setting	53
6.3.2	Configuration Menus (More 2/3)	54
6.3.3	Excitation Configuration (More 3/3)	55
6.3.4	Full & Half Poisson Bridge Setting	55
6.4	Full Bending Poisson Bridge Setting	56
6.4.1	Function Keys in More 2/3 Page	57
6.4.2	Function Keys in More 3/3 Page	58
6.5	Quarter Bridge Setting	59
6.5.1	Quarter Bridge Setting Page 1	59
6.5.2	Quarter Bridge Setting Page 2	60
6.5.3	Quarter Bridge Setting Page 3	61
6.6	DC and AC Measurements 1/2 Page	62
6.6.1	Voltage Source and Module Terminal Connection	62
6.6.1.1	F1 (Auto Zero) Key – Enable Auto Zero (DCV Only)	62
6.6.1.2	F1 (Auto Zero) Key – Enable Auto Zero (DCV Only)	63
6.6.1.3	F1 (Auto Zero) Key – Enable Auto Zero (DCV Only)	63
6.6.2	DC and AC Measurements 2/2 Page	63
6.6.2.1	F1 (Auto Zero) Key – Enable Auto Zero (DCV Only)	63
6.6.2.2	F1 (Auto Zero) Key – Enable Auto Zero (DCV Only)	64

6.6.2.3	F1 (Auto Zero) Key – Enable Auto Zero (DCV Only)	64
6.7	2W & 4W Direct Setting	66
6.7.1	Function Keys in More 2/3 page	67
6.7.2	Function Keys in More 3/3 page	68
6.8	2-Wire & 4-Wire Resistance Measurement	69
6.8.1	2 and 4 Wire Resistance Measurement Range	70
6.9	Frequency/Period Measurement	72
6.9.1	Frequency Period Measurement Page 2	73
6.10	Diode Measurement	74
6.10.1	Diode Measurement 2/2 page	75
6.11	Capacitance Measurement	76
6.11.1	Function Keys in More 2/2 page	77
6.12	DCI/ACI Measurement	78
6.12.1	DCI/ACI Measurement Page 2	79
6.13	Scan 2-Wire & 4-Wire Measurement	80
6.14	Switch Mode for Multiplexer Modules	81
6.14.1	Display	82
6.15	Computer Channels	83
6.15.1	Types	83
6.16	Basic Math	84
6.16.1	Steps	84
6.17	Statistics	85
6.18	Polynomial 5TH	86

## 6.1 Channel Menu

Press the *Channel* key on the front panel to enter the *Channel Menu*, where various measurements can be selected for each channel from the installed module slots. Refer to the diagram below for details.

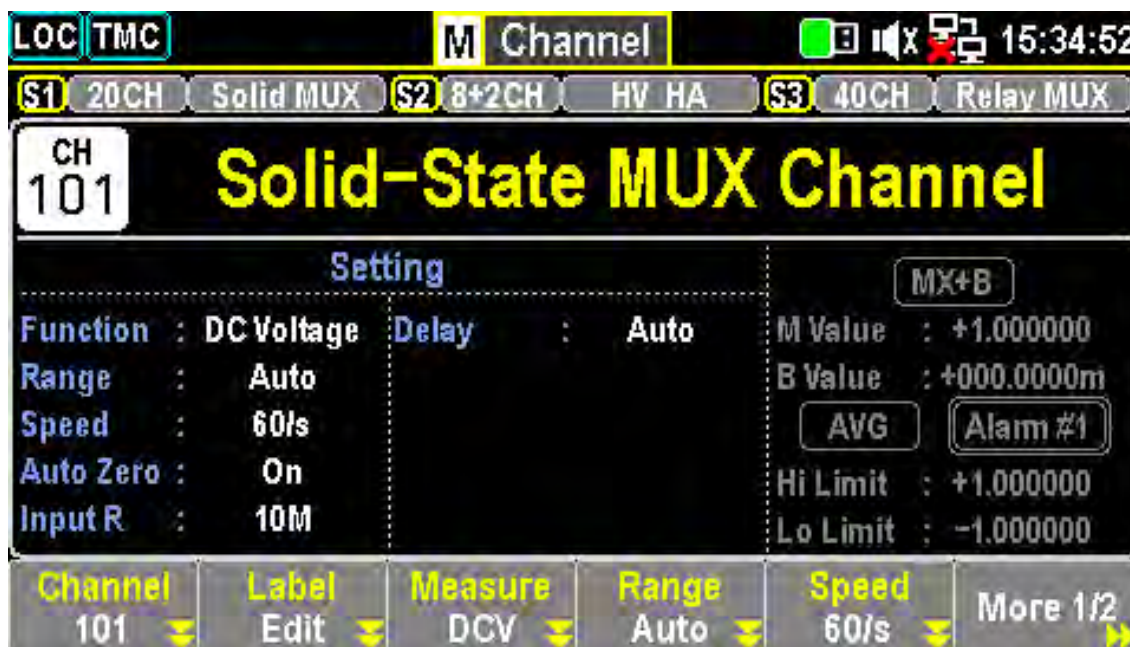

**Figure 6.1** Channel Menu Page 1

Section	Description
Module Display	Displays the module slot number, module name, and total channels available for each installed module. Supports up to three installed modules.
Channel Display	Shows the selected channel number along with its corresponding channel name.
Measurement Setting	Displays parameter settings for the measurement function of the selected channel. Available settings vary depending on the selected measurement type.
Math, Average & Alarm	<ul style="list-style-type: none"> <li>a. Math function settings for the selected channel.</li> <li>b. Average Count &amp; Window settings.</li> <li>c. Alarm high and low limit settings.</li> </ul> Press the knob key to toggle between <i>Average</i> and <i>Alarm</i>
Softkey Functions	Provides access to function keys for configuring various display modes. Refer to the following subchapters for more details.

**Table 6.1** Monitor Display

### 6.1.1 F1 (Channel) Key – Select a Channel

Press the **F1** key to select a channel. Use either the numerical keypad or the knob key to confirm selection. Alternatively, users can directly rotate the knob key in the *Channel Display* to navigate between channels.

### 6.1.2 F2 (Label) Key – Assign a Channel Name

Press the **F2** key to open the on-screen keyboard. Rotate the knob key to select characters, then press *Input* to confirm.



Figure 6.2 Edit Channel Label

- Press *OK* to save the channel name.
- Press *Exit KeyB* to close the keyboard without saving.
- Use *Caps Lock* to toggle between uppercase and lowercase letters.
- Press *Backspace* to delete characters and move the cursor backward.

**6.1.3 F3 (Measure) Key – Configure Measurement**

Measurement settings contain multiple measurement types with various configuration options. These settings will be introduced in detail in the following subchapters.

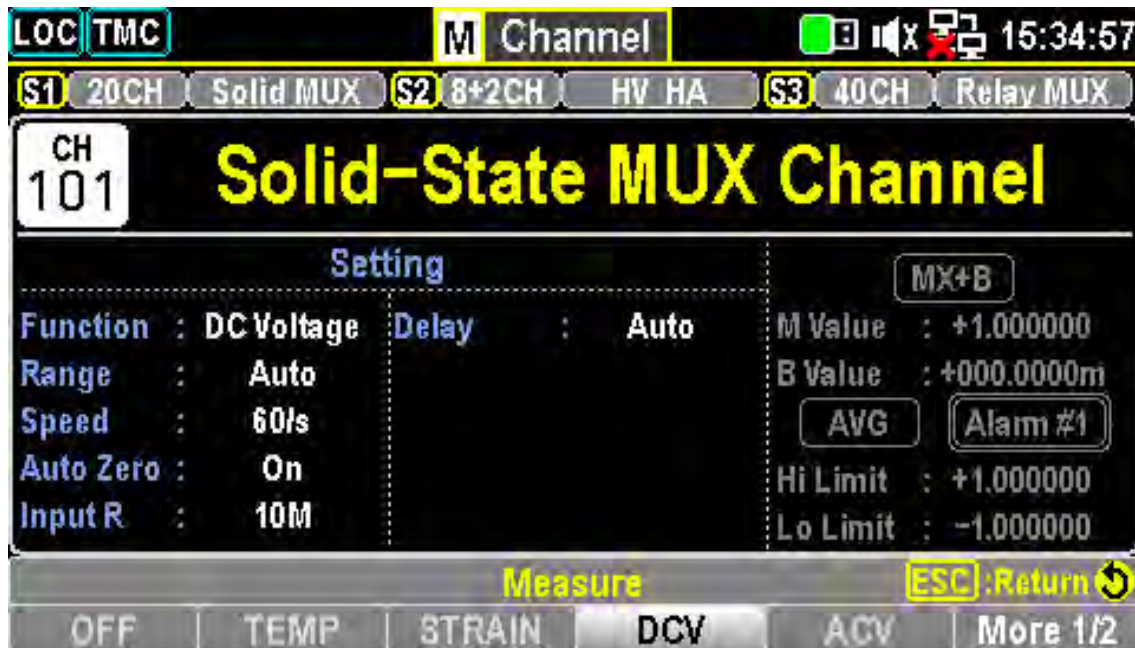

Figure 6.3 Channel Measurement

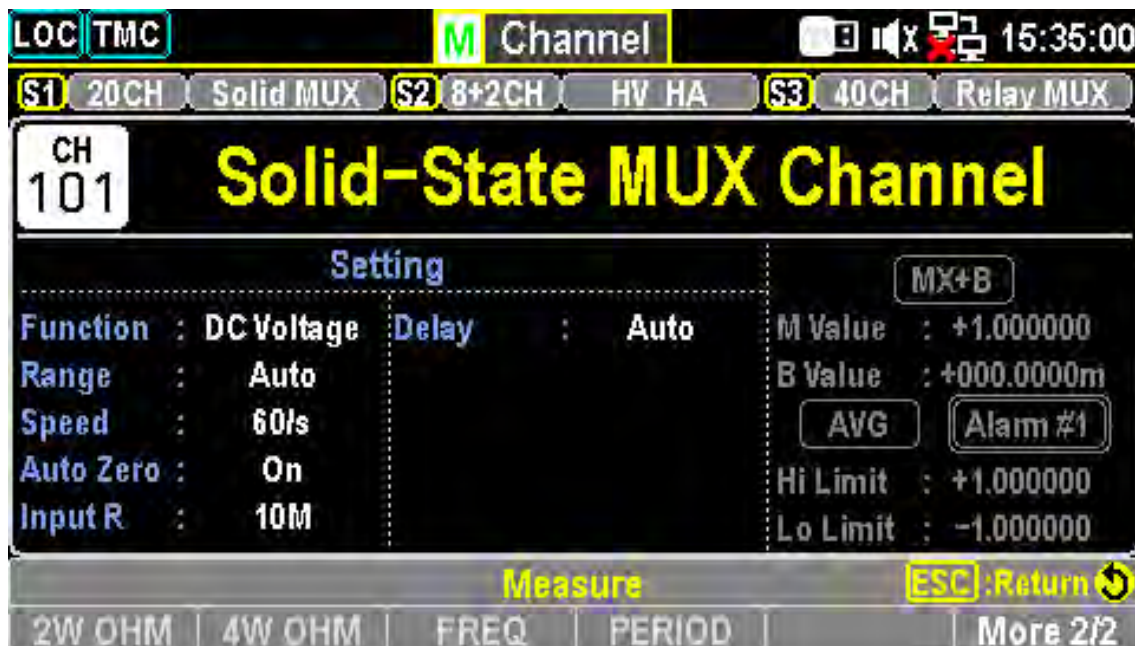

Figure 6.4 Channel Measurement 2

## 6.2 Temperature Measurement

The temperature measurements require a temperature transducer with supported probes: Thermocouple, Thermistor, and Resistance Temperature Detector (RTD).

Probe Type	Measurement Range
Thermocouple	-200°C to+1820°C (varies by sensor type)
RTD	-200°C to+630°C
Thermistor	-80°C to+150°C

**Table 6.2** Temperature Range

### NOTICE

Depending on the installed modules, some temperature measurements (Thermistor, RTD) may not be available.

### 6.2.1 Thermocouple Setting

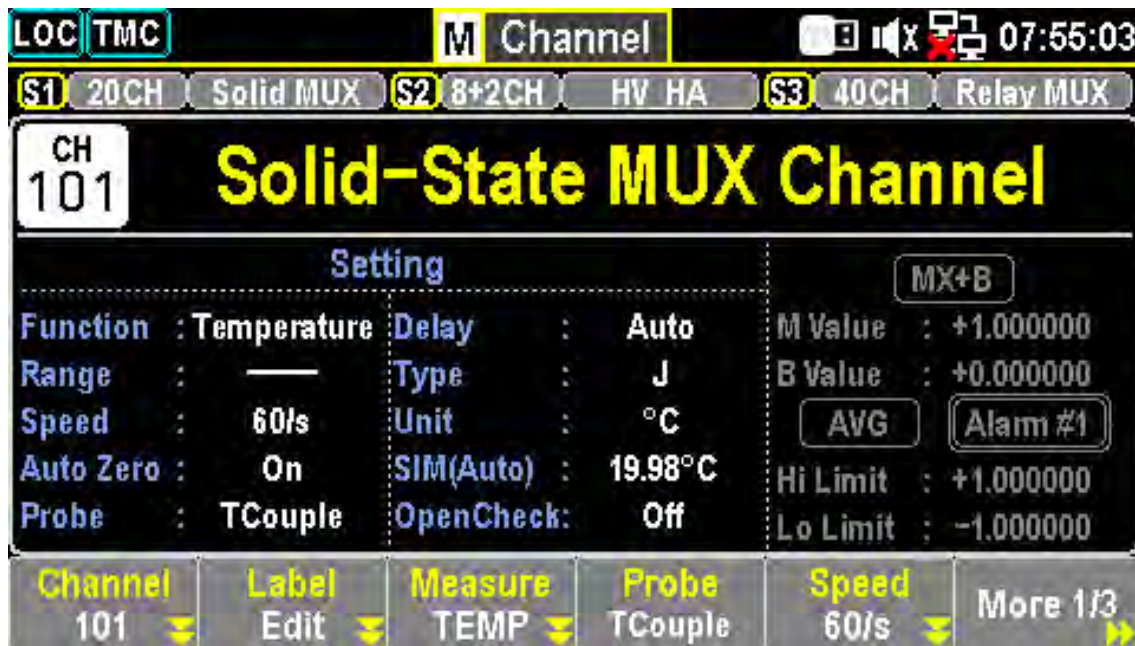
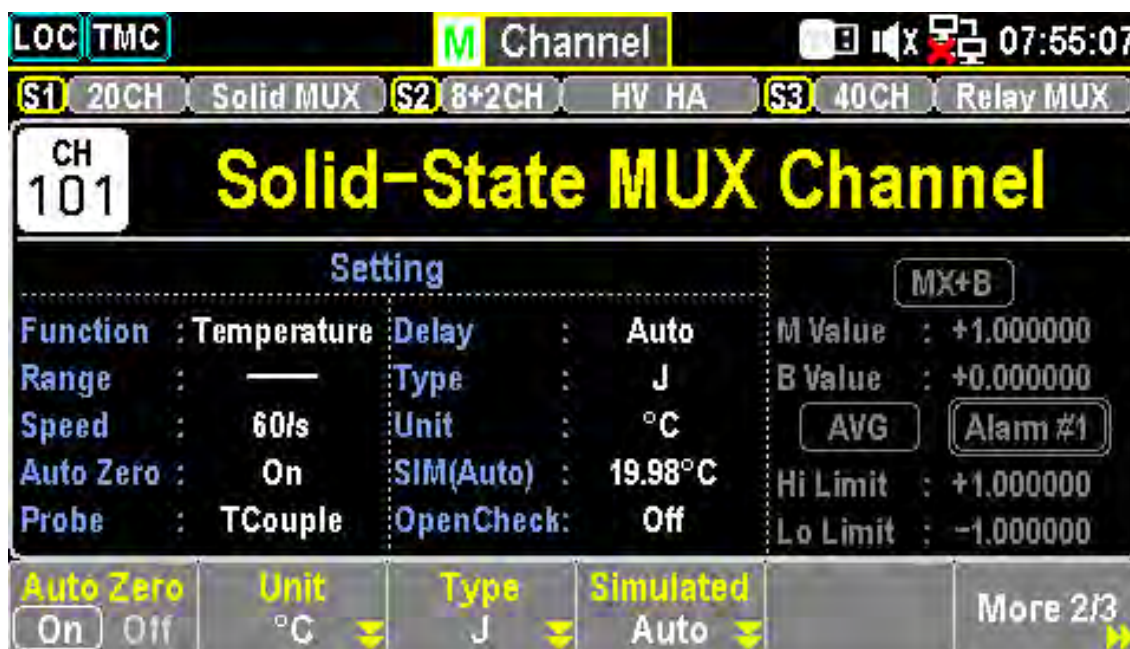

**Figure 6.5** Thermocouple Page 1

Function Key	Description
F3 (Measure )	Select TEMP measurement mode.
F4 (Probe)	Select TCouple (Thermocouple).
F5 (Speed)	Enter speed menu to select measurement speed. Use Arrow keys for quick selection.
F6 (More 1/3)	Navigate to the next function keys page.

**Table 6.3** Thermocouple Configuration Options

**6.2.2 Function Keys in More 2/3 Page**

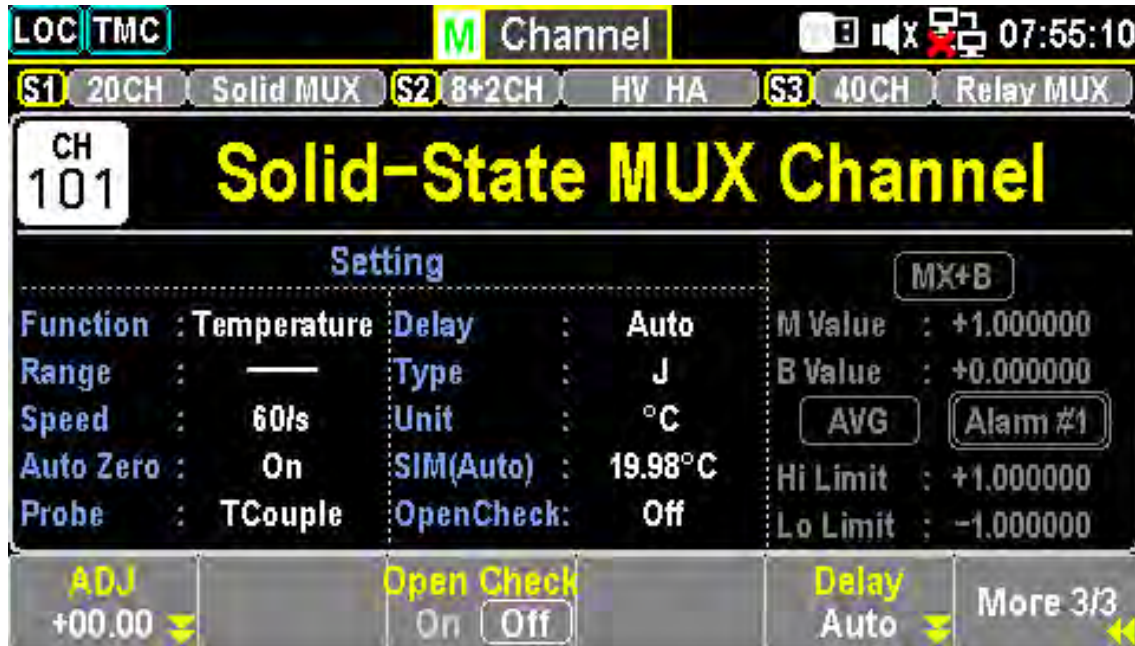

**Figure 6.6** Thermocouple Page 2

Function Key	Description
F1 (Auto Zero)	Enables Auto Zero for accurate measurements, but increases processing time.
F2 (Unit)	Set temperature unit to °C, °F, or K.
F3 (Type)	Select sensor type (J, K, N, R, S, T, B, or E).
F4 (Simulated)	Set reference junction temperature method: Auto, Fixed, or External.
F5 (Fix Value)	Configure a fixed value for simulated reference junction.
F5 (Ref CH)	Select a reference channel when External mode is chosen.
F6 (More 2/3)	Navigate to the next function keys page.

**Table 6.4** Additional Configuration Functions

**6.2.3 Function Keys in More 3/3 Page**



**Figure 6.7** Thermocouple Page 3

Function Key	Description
F1 (ADJ)	Define an offset value for Auto SIM.
F3 (Open Check)	Enables open circuit authentication to ensure proper thermocouple connection.
F5 (Delay)	Set a delay time between actual measurements in a scan course.

**Table 6.5** Advanced Configuration Options

**6.2.3.1 Open Check Feature**

When enabled, DAQ3120 performs a resistance measurement alongside each temperature assessment to detect open circuits. If an open circuit is found, the display shows +Overload. This feature increases measurement time but prevents inaccurate readings.

## 6.2.4 Thermocouple Sensor Type

The instrument accepts thermocouple inputs and calculates the temperature from the voltage difference between two dissimilar metals. The thermocouple sensor type is one of the main factors to be considered.

Sensor Type	Measurement Range (°C)	Resolution (°C)
J	-210 to +1200	0.002
K	-200 to +1372	0.002
N	-200 to +1300	0.003
R	-50 to +1768	0.01
S	-50 to +1768	0.01
T	-200 to +400	0.002
B	+250 to +1820	0.01
E	-200 to +1000	0.002

**Table 6.6** Thermocouple Sensor Specifications

## 6.2.5 Reference Junction Temperature (SIM Temperature)

When a thermocouple is connected to the DAQ3120, the temperature difference between the thermocouple lead and the DAQ3120 input terminal should be taken into account and be canceled out; otherwise, an erroneous temperature might be added. The value of the reference junction temperature should be determined by the user.

## 6.2.6 SIM Temperature Parameters

Type	Range (°C)	Resolution (°C)
SIM (simulated)	-20 to +80	0.01

**Table 6.7** SIM Temperature Specifications

The terminal temperature is manually defined by the user.

**Default value: Auto**

**6.2.7 Thermistor 2W/4W Setting**

Resolution (°C) 0.001

Parameter	Type	Range (°C)
All	-	-80 to +150

**Table 6.8** Thermistor Specifications

**6.2.8 Function Keys**

- **F3 Measure** - Select TEMP
- **F4 Probe** - Select Them2W or Them4W
- **F5 Speed** - Set measurement speed
- **F6 More 1/3** - Enter next function keys page

**6.2.9 Auto Zero and Configuration**

- **Auto Zero (F1)** - Enables auto-zero for accurate measurements.
- **Unit (F2)** - Set temperature unit (°C, °F, °K).
- **Type (F3)** - Specify a sensor type (2.2kΩ, 5kΩ, 10kΩ, User).
- **User Type (F4)** - Configure user-defined Steinhart–Hart coefficients.

Type	A	B	C
2.2k	0.0014733	0.0002372	1.07E-07
5k	0.0012880	0.0002356	9.56E-08
10k	0.0010295	0.0002391	1.57E-07

**Table 6.9** Steinhart–Hart Coefficients

**6.2.10 RTD 2W/4W Setting**

Parameter	RTD Type	Range (°C)	Resolution (°C)
All	PT100-based	-200 to +630	0.001

**Table 6.10** RTD Sensor Specifications

### 6.2.11 RTD User Type Coefficients

Type	Alpha ( $\alpha$ )	Beta ( $\beta$ )	Delta ( $\delta$ )
PT100	0.00385	0.10863	1.49990
D100	0.00392	0.10630	1.49710
F100	0.00390	0.11000	1.49589
PT385	0.00385	0.11100	1.50700
PT3916	0.00392	0.11600	1.50594

**Table 6.11** Callendar–Van Dusen Coefficients

### 6.2.12 Additional Functions

- **Use as Ref (F5)** - Enables reference channel for thermocouple measurements.
- **Power Low (F3)** - Enables low-power resistance measurement to minimize self-heating.
- **Delay (F5)** - User-defined delay time between channel measurements.

## 6.3 Strain Measurement

The strain measurement configurations determine how strain is measured. When a force is applied to a body, it deforms, and the deformation per unit length is known as strain. Strain can be either compressive (-) or tensile (+). The DAQ3120 supports two strain measurement methods: Bridge and Direct Resistive.

After configuring the strain measurement function for channels, navigate to the Home menu to obtain the unstrained offset value. This value is subtracted from strain measurements before performing strain conversion. Refer to page 37 for details on obtaining the unstrained offset value.

### 6.3.1 Full & Half Bending Bridge Setting

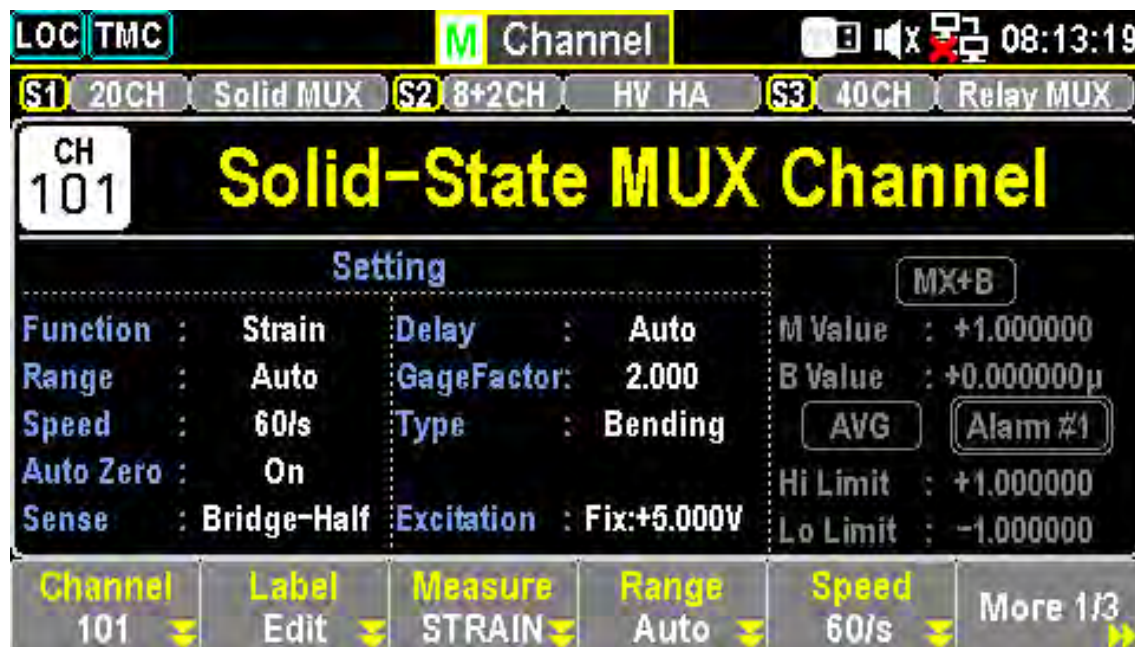

Figure 6.8 Strain Half & Full Bridge Settings Page 1

1. Press **F3** (Measure) to select **STRAIN**.
2. Configure the bridge source and module terminal connections for either:
  - a. Full Bending Bridge
  - b. Half Bending Bridge
3. Press **F4** (Range) to enter the Range menu and select a measurement range.
4. Press **F5** (Speed) to enter the Speed menu and set the measurement speed.
5. Press **F6** (More 1/3) to access additional configuration functions.

## 6.3.2 Configuration Menus (More 2/3)

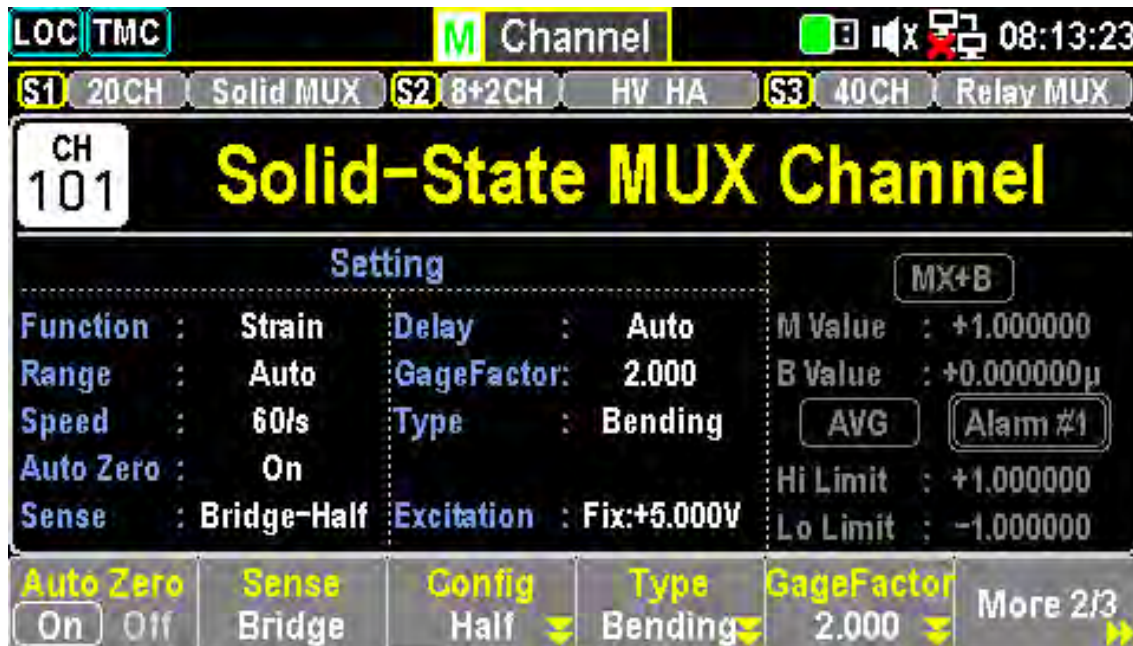

Figure 6.9 Strain Half &amp; Full Bridge Settings Page 2

1. **F1** (Auto Zero): Enables Auto Zero for more accurate measurements at the cost of additional measurement time.
2. **F2** (Sense): Opens the Sense menu to select Bridge.
3. **F3** (Config): Opens the Config menu to specify Full or Half.
4. **F4** (Type): Opens the Type menu to select Bending.
5. **F5** (Gage Factor): Specifies the gage factor, a dimensionless quantity with a default value of approximately 2.
6. **F6** (More 2/3): Advances to the next configuration menu.

### 6.3.3 Excitation Configuration (More 3/3)

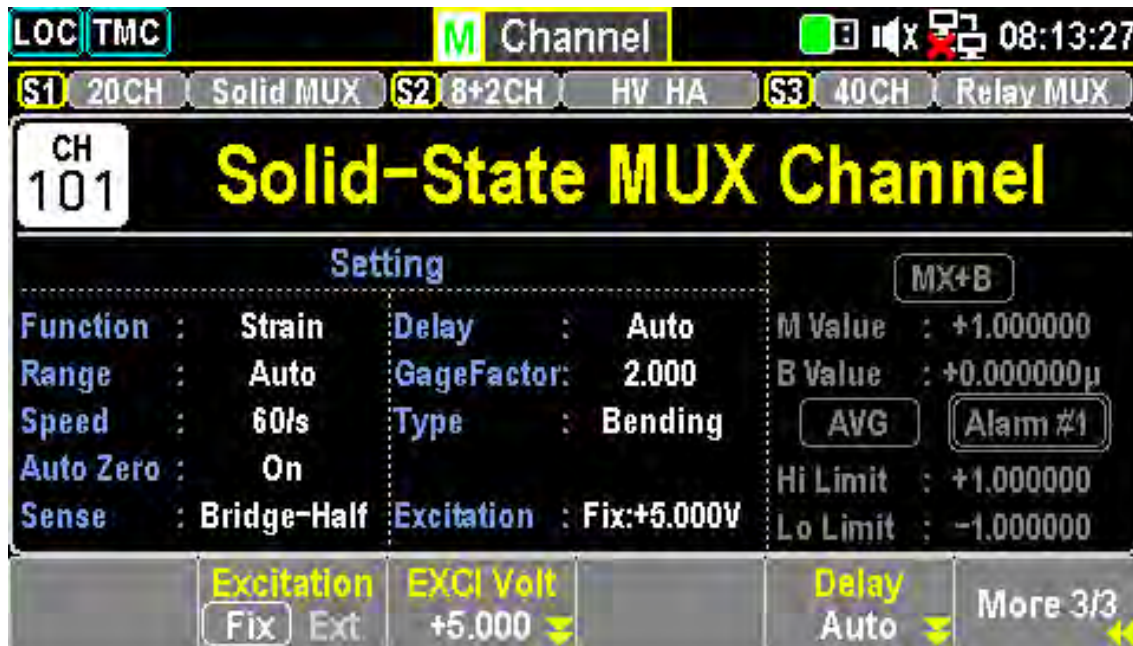

Figure 6.10 Strain Half & Full Bridge Settings Page 3

1. **F2 (Excitation)**: Defines the external bridge excitation voltage. Options include:
  - a. **Fixed (Fix)**: Uses a specified fixed voltage.
  - b. **External (Ext)**: Uses a DCV measurement from a reference channel (must be a lower-numbered channel than the strain channel).
2. **F3 (EXCI Volt)**: Configures the excitation voltage when using a fixed voltage source.
3. **F3 (Ext Chan.)**: Selects a reference channel when using an external excitation source.
4. **F5 (Delay)**: Defines the delay time between consecutive measurements.

### 6.3.4 Full & Half Poisson Bridge Setting

Similar steps apply to the Poisson Bridge setting, with **F4 (Type)** set to **Poisson** and an additional **F1 (PoisRatio)** key to define the Poisson ratio.

## 6.4 Full Bending Poisson Bridge Setting

Function Key	Description
F3 (Measure) key	Select <b>STRAIN</b> . Bridge source and module terminals connection for Full Bending Poisson Bridge.
F4 (Range) key	Opens the <b>Range</b> menu to select a target range for strain measurement. If <b>Auto</b> is selected, the range is determined automatically based on the input source, which may result in slower measurement. Manual selection allows for prompt range adjustments.
F5 (Speed) key	Opens the <b>Speed</b> menu to select measurement speed. The Arrow keys can also be used for quick selection.
F6 (More 1/3) key	Navigates to the next function keys page ( <b>More 2/3</b> ) for further configurations.

**Table 6.12** Full Bending Poisson Bridge Settings

**6.4.1 Function Keys in More 2/3 Page**

Function Key	Description
Auto Zero (F1) key	Enables <b>Auto Zero</b> for accurate measurements by compensating for offset voltages. When enabled, DAQ3120 measures offset after each reading and subtracts it, preventing inaccuracies. When disabled, offset is measured once and applied to all subsequent readings.
Sense (F2) key	Opens the <b>Sense</b> menu and allows selection of <b>Bridge</b> mode for sensing.
Config (F3)	Specify Full: Press the key to enter the Config menu followed by selecting Full.
Type (F4)	Select BendPois: Press the key to enter the Type menu followed by selecting BendPois for type, which is a combination ratio of Bending and Poisson.
GageFactor (F5)	Specify a ratio: Gage factor indicates the ratio of fractional change in resistance to, along the axis of the gage, the fractional change in length (strain). The more sensitive strain gage, the larger the value. Gage factor itself is a dimensionless quantity with the default value of approximately 2.
F6 (More 2/3)	Enter next function keys page: Press the key to enter the next page (More 3/3) of more function configurations for measurement.

**Table 6.13** Full Bending Poisson Bridge Settings Page 2

**6.4.2 Function Keys in More 3/3 Page**

Function Key	Description
PoisRatio (F1)	Specify Poisson ratio: User specifies a Poisson ratio, which is defined as the negative ratio of the strain in the transverse direction to the strain in the longitudinal direction, of the strain gage.
Excitation (F2)	Strain bridge conversions: Strain bridge conversions require the voltage of the external bridge excitation, for which user can designate a multiplexer channel to measure the excitation voltage or can specify a known fixed voltage value.
Fixed (Fix)	Fixed value specified by excitation voltage: The fixed value specified by the excitation voltage will be used for the strain conversion.
External (Ext)	DCV measurements: DCV measurements on the enabled reference channel will be used for subsequent strain bridge measurements that specify an external excitation voltage source. The external DCV reference channel must be a lower-numbered channel than the strain channel
EXCI Volt (F3)	Configure excitation voltage: When “Fix” is selected for Excitation, press F3 key to further configure an excitation voltage applied to the bridge by an external voltage source. This value will be used to convert strain bridge measurements on the selected channel.
Ext Chan. (F3)	Select reference channel: When “Ext” is selected for Excitation, press F3 key to further select a reference channel from the list.
Delay (F5)	Select a delay time: User defines a delay time to be inserted between the actual measurement on each channel from a scan course.

**Table 6.14** Full Bending Poisson Bridge Settings Page 3

## 6.5 Quarter Bridge Setting

### 6.5.1 Quarter Bridge Setting Page 1

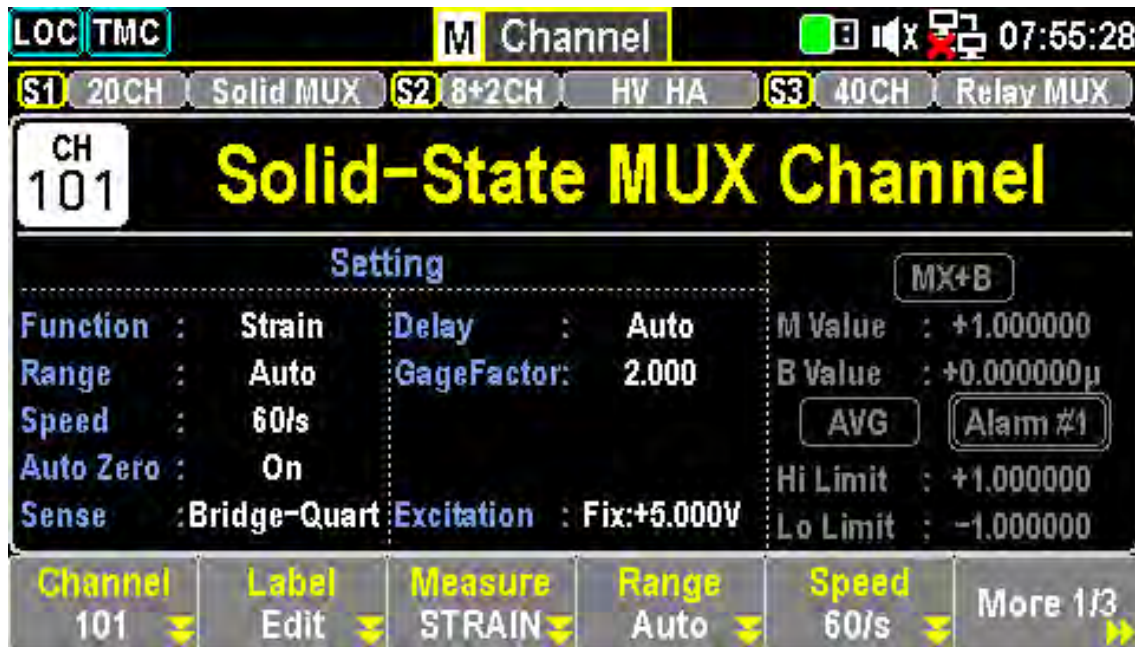

**Figure 6.11** Quarter Bridge Settings Page 1

Function Key	Description
F3 (Measure)	Select STRAIN: Press the key to select STRAIN measurement.
STRAIN	Bridge source and module terminals connection: Connect the bridge source and module terminals for the quarter bridge configuration.
F4 (Range)	Select Range: Press the key to enter the Range menu and select a target range for strain measurement. The Auto option automatically selects the range based on the source input, but it may result in slower measurements compared to manual range selection. Using the Range keys allows for quicker range selection.
F5 (Speed)	Select Speed: Press the key to enter the Speed menu and select a target speed for temperature measurements. Arrow keys can also be used to select speed promptly.
F6 (More 1/3)	Enter Next Function Keys Page: Press the key to enter the next page (More 2/3) for additional function configurations for measurement.

**Table 6.15** Quarter Bridge Setting

6.5.2 Quarter Bridge Setting Page 2



Figure 6.12 Quarter Bridge Settings Page 2

Function Key	Description
Auto Zero (F1)	Set Auto Zero: Turning On Auto Zero ensures the most accurate measurements by executing a zero measurement, though it requires extra time. With Auto Zero On, the DAQ3120 internally measures the offset after each measurement and subtracts it from the preceding reading, preventing offset voltages from affecting measurement accuracy. With Auto Zero Off, the DAQ3120 measures the offset once and subtracts it from all subsequent measurements.
Sense (F2)	Select Bridge: Press the key to enter the Sense menu followed by selecting Bridge for sense.
Config (F3)	Specify Quarter: Press the key to enter the Config menu followed by selecting Quarter.
GageFactor (F5)	Specify a Ratio: Gage factor indicates the ratio of fractional change in resistance to, along the axis of the gage, the fractional change in length (strain). The more sensitive the strain gage, the larger the value. Gage factor itself is a dimensionless quantity, with the default value approximately 2.
F6 (More 2/3)	Enter Next Function Keys Page: Press the key to enter the next page (More 3/3) for additional function configurations for measurement.

Table 6.16 Quarter Bridge Setting

6.5.3 Quarter Bridge Setting Page 3

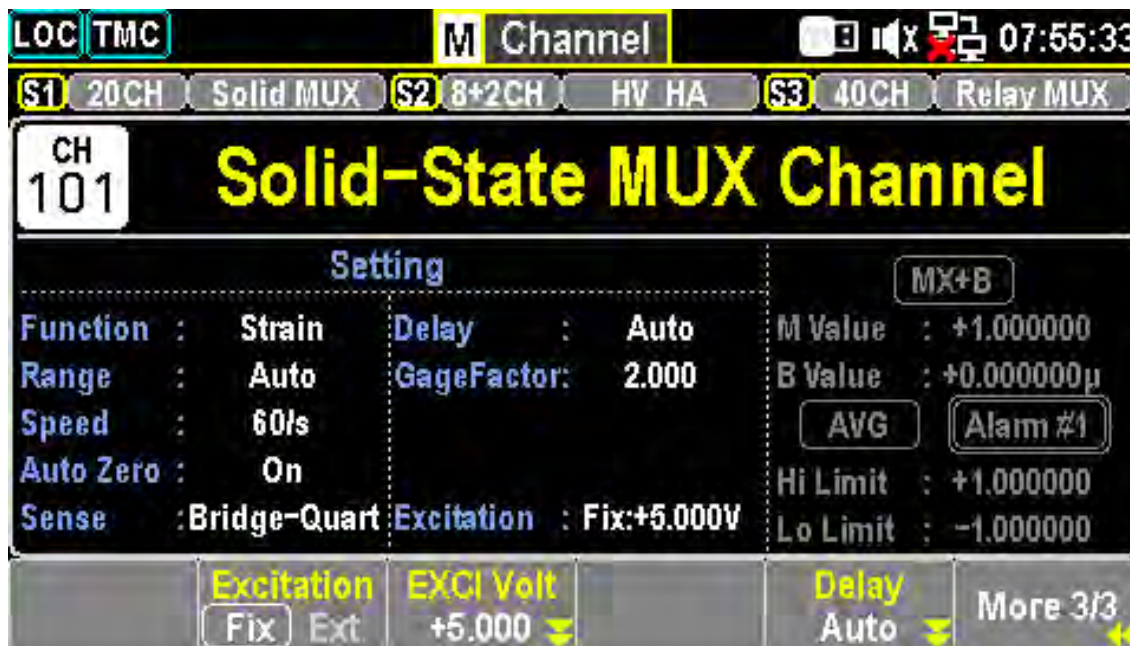

Figure 6.13 Quarter Bridge Settings Page 3

Function Key	Description
Excitation (F2)	Strain Bridge Conversions: Strain bridge conversions require the voltage of the external bridge excitation. The user can designate a multiplexer channel to measure the excitation voltage or specify a known fixed voltage value.
Fixed (Fix)	Fixed Excitation Voltage: The fixed value specified by the excitation voltage will be used for strain conversion.
External (Ext)	External DCV Measurements: DCV measurements on the enabled reference channel will be used for subsequent strain bridge measurements that specify an external excitation voltage source. Note that the external DCV reference channel must be a lower-numbered channel than the strain channel.
EXCI Volt (F3)	Configure Excitation Voltage: When “Fix” is selected for Excitation, press F3 to further configure an excitation voltage applied to the bridge by an external voltage source. This value will be used to convert strain bridge measurements on the selected channel.
Ext Chan. (F3)	Select Reference Channel: When “Ext” is selected for Excitation, press F3 to select a reference channel from the list.
Delay (F5)	Select a Delay Time: The user defines a delay time to be inserted between the actual measurement on each channel from a scan course.

Table 6.17 Quarter Bridge Setting

## 6.6 DC and AC Measurements 1/2 Page

### 6.6.1 Voltage Source and Module Terminal Connection

Ensure proper connection of the voltage source to the module terminals before measurement.

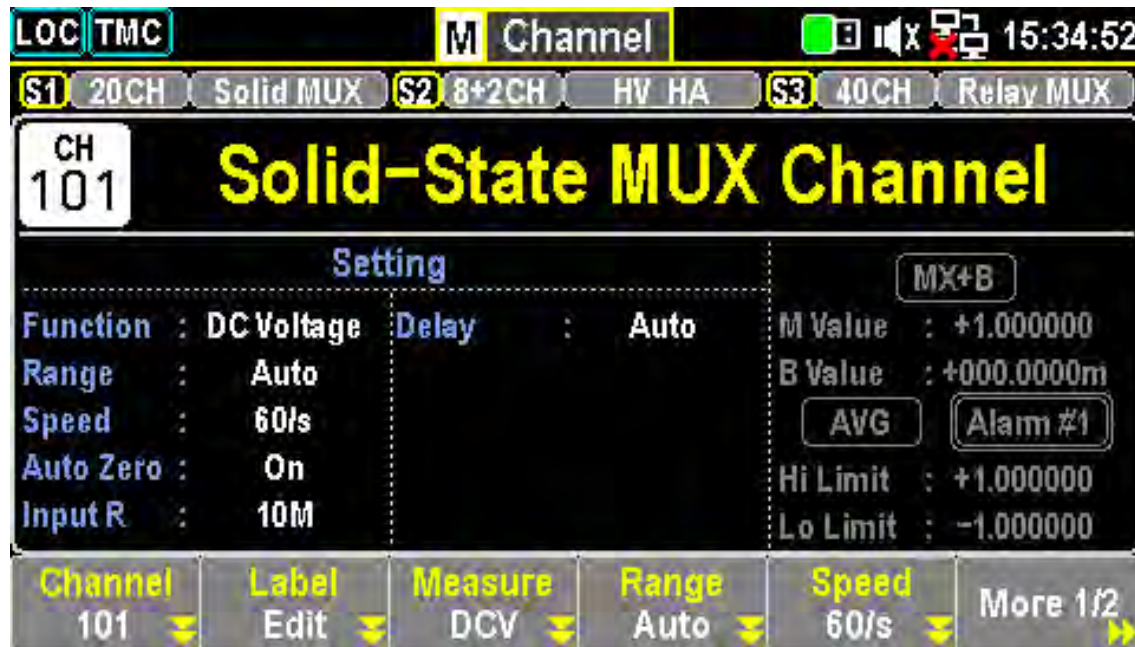

Figure 6.14 DCV & ACV Measurement Page 1

#### 6.6.1.1 F1 (Auto Zero) Key – Enable Auto Zero (DCV Only)

F4 (Range) Key – Select Range for ACV and DCV Press the **F4** key to enter the *Range Menu* and select a target range for ACV and DCV measurements individually.

- *Auto*: Automatically selects the appropriate range based on the input source. However, auto-ranging may result in slower measurement compared to manual selection.
- *Manual*: Users can promptly select a range using the **Range** keys.

### 6.6.1.2 F1 (Auto Zero) Key – Enable Auto Zero (DCV Only)

F5 (Speed) Key – Select Speed for ACV and DCV Press the **F5** key to enter the *Speed Menu* and select a desired measurement speed for ACV and DCV.

- Speed selection can also be done quickly using the *Arrow Keys*.

### 6.6.1.3 F1 (Auto Zero) Key – Enable Auto Zero (DCV Only)

F6 (More 1/2) Key – Next Page of Function Keys Press the **F6** key to navigate to the next page (*More 2/2*) for additional measurement functions.

## 6.6.2 DC and AC Measurements 2/2 Page

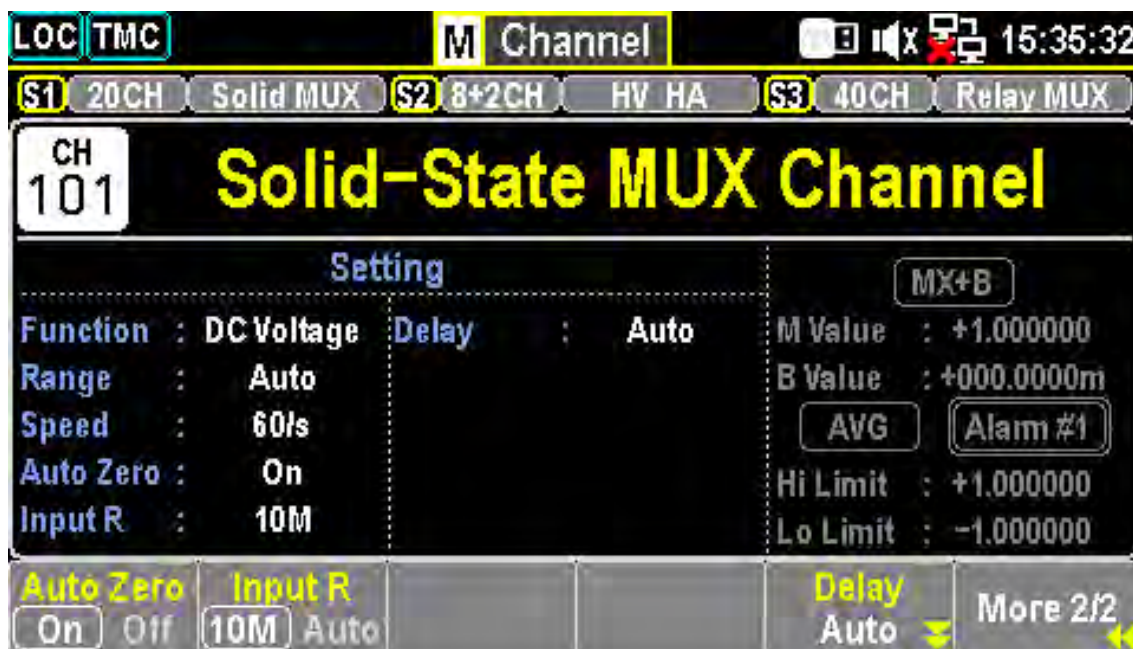

Figure 6.15 DCV & ACV Measurement Page 2

### 6.6.2.1 F1 (Auto Zero) Key – Enable Auto Zero (DCV Only)

Turning *Auto Zero On* provides the most accurate measurements but requires extra processing time.

- With *Auto Zero On*, the DAQ3120 internally measures the offset after each reading and subtracts it from subsequent readings, improving accuracy.
- With *Auto Zero Off*, the offset is measured once and applied to all subsequent readings, reducing processing time.

### **6.6.2.2 F1 (Auto Zero) Key – Enable Auto Zero (DCV Only)**

---





F2 (Input R) Key – Select Input Resistance (DCV Only) Defines the measurement terminal input impedance. Options include:

- **10 M $\Omega$** : A general-purpose setting suitable for most circuits, reducing noise in readings.
- **Auto**: Selects high impedance (*Hi-Z*) for 100 mV, 1 V, and 10 V ranges, while using 10 M $\Omega$  for 100 V and 600 V ranges. The *Hi-Z* mode is recommended when the 10 M $\Omega$  load significantly affects the circuit.

### **6.6.2.3 F1 (Auto Zero) Key – Enable Auto Zero (DCV Only)**

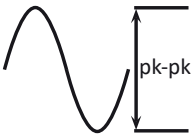
---

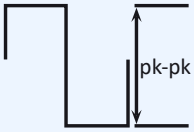
F5 (Delay) Key – Set Measurement Delay Time Users can define a delay time to be inserted between measurements on each channel within a scan course.

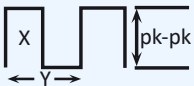
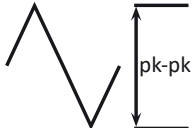
Waveform	Peak-to-Peak	AC (True RMS)	DC
<p>Sine</p> 	2.828	1.000	0.000
<p>Rectified Sine (full wave)</p> 	1.414	0.435	0.900
<p>Rectified Sine (half wave)</p> 	2.000	0.771	0.636
<p>Square</p> 	2.000	1.000	0.000
<p>Rectified Square</p> 	1.414	0.707	0.707
<p>Rectangular Pulse</p> 	2.000	$2K$ $K = \frac{2}{(D-D^2)}$ $D = X/Y$	$2D$ $D = X/Y$
<p>Triangle / Sawtooth</p> 	3.464	1.000	0.000

**Table 6.18** Relationship between AC and DC readings in different waveforms

6.7 2W & 4W Direct Setting

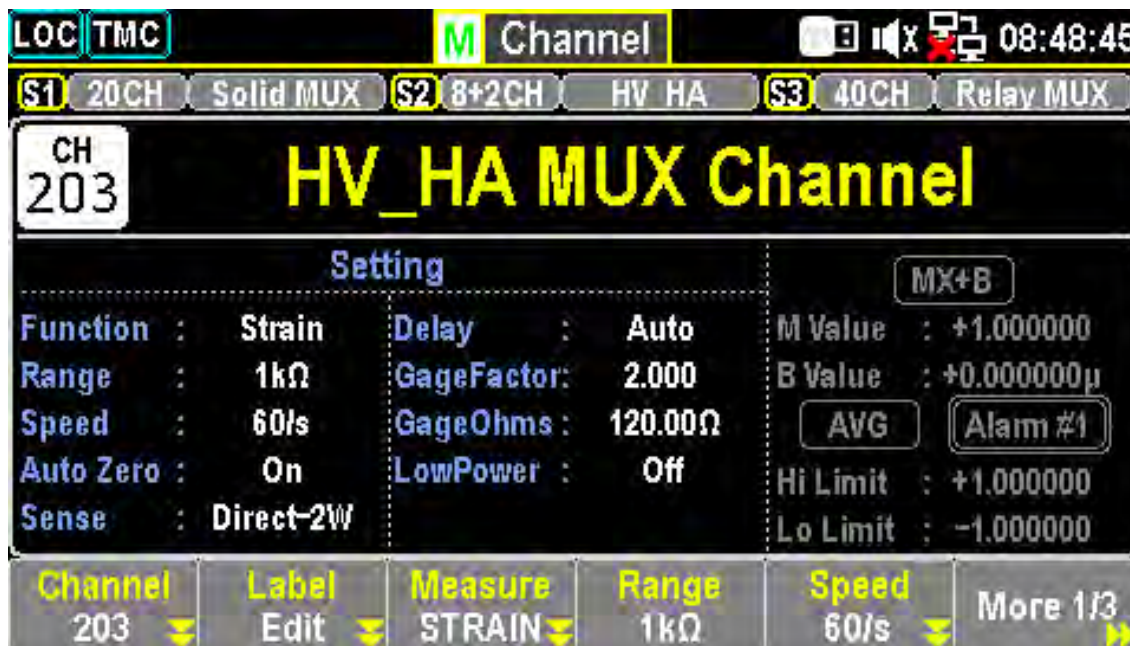

Figure 6.16 2W & 4W Direct Setting Page 1

Function Key	Description
F3 (Measure)	Select STRAIN: Press the key to select STRAIN measurement.
STRAIN	Direct Source and Module Terminals Connection: Connect the source and module terminals for 2W or 4W Direct configuration.
F4 (Range)	Fixed in Fix 1kΩ: Under either the 2W or 4W Direct setting, the Range is fixed in Fix 1kΩ by default.
F5 (Speed)	Select Speed: Press the key to enter the Speed menu and select a target speed for temperature measurements. Arrow keys can be used to select speed promptly.
F6 (More 1/3)	Enter Next Function Keys Page: Press the key to enter the next page (More 2/3) of additional function configurations for measurement.

Table 6.19 Quarter Bridge Setting

6.7.1 Function Keys in More 2/3 page

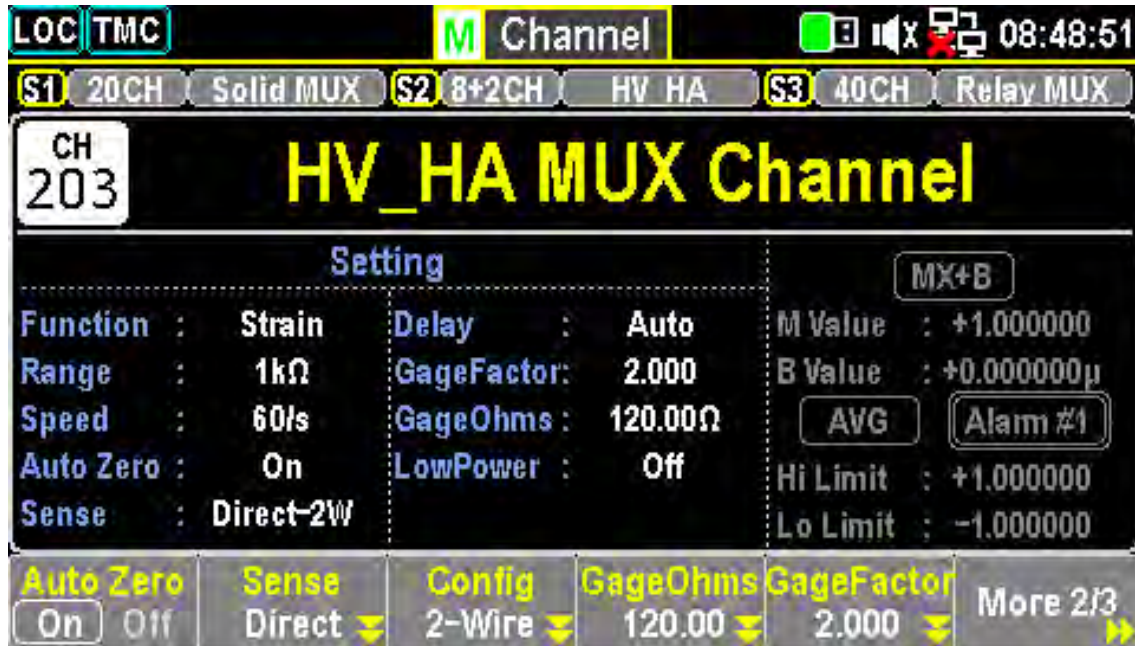

Figure 6.17 2W & 4W Direct Setting Page 2

Auto Zero (F1)	Set Auto Zero: Turning on Auto Zero provides the most
Sense (F2)	Select Direct: Press the key to enter the Sense menu and select Direct for sense.
Config (F3)	Specify 2-Wire or 4-Wire: Press the key to enter the Config menu and select either 2-Wire or 4-Wire.
GageOhms (F4)	Specify Resistance: Press the key to specify Gage resistance, which is used to convert direct strain measurements on the selected channel.
GageFactor (F5)	Specify a Ratio: Gage factor indicates the ratio of fractional change in resistance to, along the axis of the gage, the fractional change in length (strain). The more sensitive the strain gage, the larger the value. Gage factor is dimensionless, with a default value of approximately 2.
F6 (More 2/3)	Enter Next Function Keys Page: Press the key to enter the next page (More 3/3) of more function configurations for measurement.

Table 6.20 Quarter Bridge Setting

6.7.2 Function Keys in More 3/3 page



Figure 6.18 2W & 4W Direct Setting Page 3

Function Key	Description
PowerLow (F3)	Select Low-Power Resistance Measurement: This selects a low-power resistance measurement that uses less current, resulting in lower power dissipation and less self-heating in the resistance under test. Typically, this is about 1/10th the current used for standard resistance measurements and is only applicable for resistances equal to or less than 100k.
Delay (F5)	Select a Delay Time: User defines a delay time to be inserted between the actual measurement on each channel during a scan course.

Table 6.21 Quarter Bridge Setting

## 6.8 2-Wire & 4-Wire Resistance Measurement

The resistance measurements configurations. Generally, the 2-Wire resistance indicates using the standard Input HI-LO terminals and is recommended for measuring resistances larger than 1kΩ. The 4-Wire resistance compensates for the test lead effect using the 4W compensation terminals, in addition to the standard Input HI-LO terminals. It is recommended for measuring sensitive resistances smaller than 1kΩ.

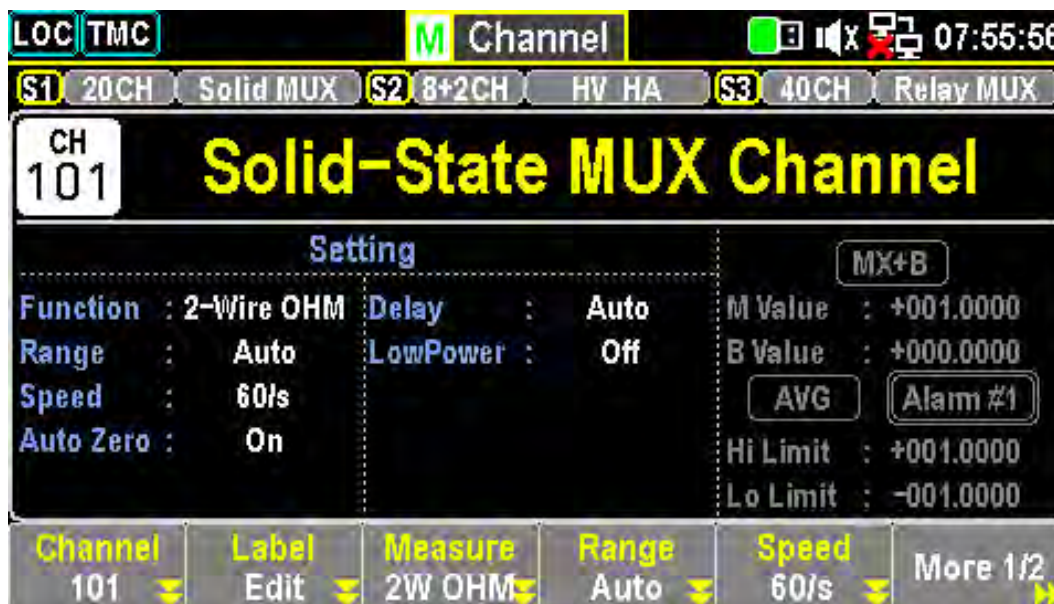

Figure 6.19 2W & 4W Setting Page 1

Function Key	Description
F3 (Measure)	Select 2W OHM or 4W OHM: Press the key to select either 2W OHM or 4W OHM measurement.
2W OHM & 4W OHM	Resistance Source and Module Terminals Connection: Connect the appropriate source and module terminals for 2W OHM or 4W OHM configuration.
F4 (Range)	Specify Range: Press the key to enter the Range menu and select a target range for 2W OHM and 4W OHM measurements individually. The Auto option selects the range based on the source input automatically, which may result in slower measurements compared to manual range selection. Using the Range keys allows for quicker range selection.
F5 (Speed)	Select Speed: Press the key to enter the Speed menu and select a target speed for temperature measurements. Arrow keys can be used to select speed promptly.
F6 (More 1/2)	Enter Next Function Keys Page: Press the key to enter the next page (More 2/2) for additional function configurations for measurement.

Table 6.22 Quarter Bridge Setting

6.8.1 2 and 4 Wire Resistance Measurement Range

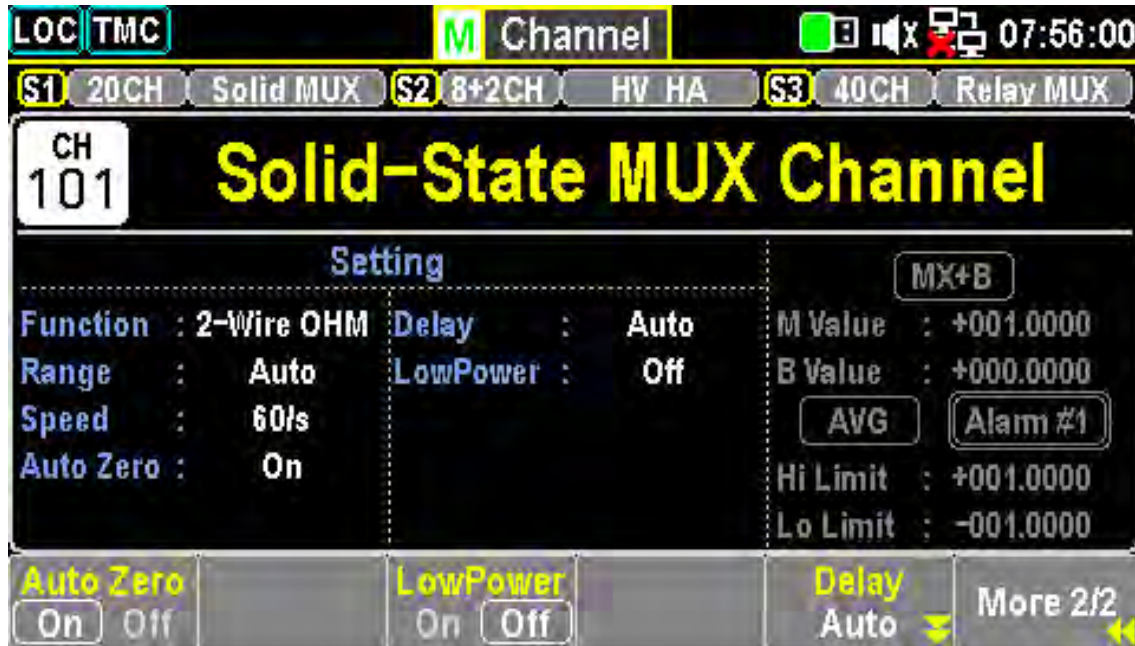

Figure 6.20 2W & 4W Setting Page 2

Function Key	Description
Auto Zero (F1)	Set Auto Zero: Turning on Auto Zero provides the most accurate measurements but requires extra time. With Auto Zero on, the DAQ3120 internally measures the offset after each measurement and subtracts it from the preceding reading, preventing offset voltages from affecting accuracy. With Auto Zero off, the offset is measured once and subtracted from all subsequent measurements.
PowerLow (F3)	Select Low-Power Resistance Measurement: Selects a low-power resistance measurement, using less current and resulting in lower power dissipation and less self-heating in the resistance under test. Typically, this is about 1/10th the current used for standard resistance measurements and is applicable only for resistances equal to or less than 100kΩ.
Delay (F5)	Select a Delay Time: User defines a delay time to be inserted between the actual measurement on each channel during a scan course.

Table 6.23 2 and 4 Wire Resistance Measurement Range

Range	Resolution	Full scale
100Ω	0.1mΩ	119.9999Ω
1kΩ	1mΩ	1.199999kΩ
10kΩ	10mΩ	11.99999kΩ
100kΩ	100mΩ	119.9999kΩ
1MΩ	1Ω	1.199999MΩ
10MΩ	10Ω	11.99999MΩ
100MΩ	100Ω	119.9999MΩ
1GΩ	XXX	XXXX

**Table 6.24** 2 and 4 Wire Resistance Measurement Range

## 6.9 Frequency/Period Measurement

The frequency/period measurements configurations.

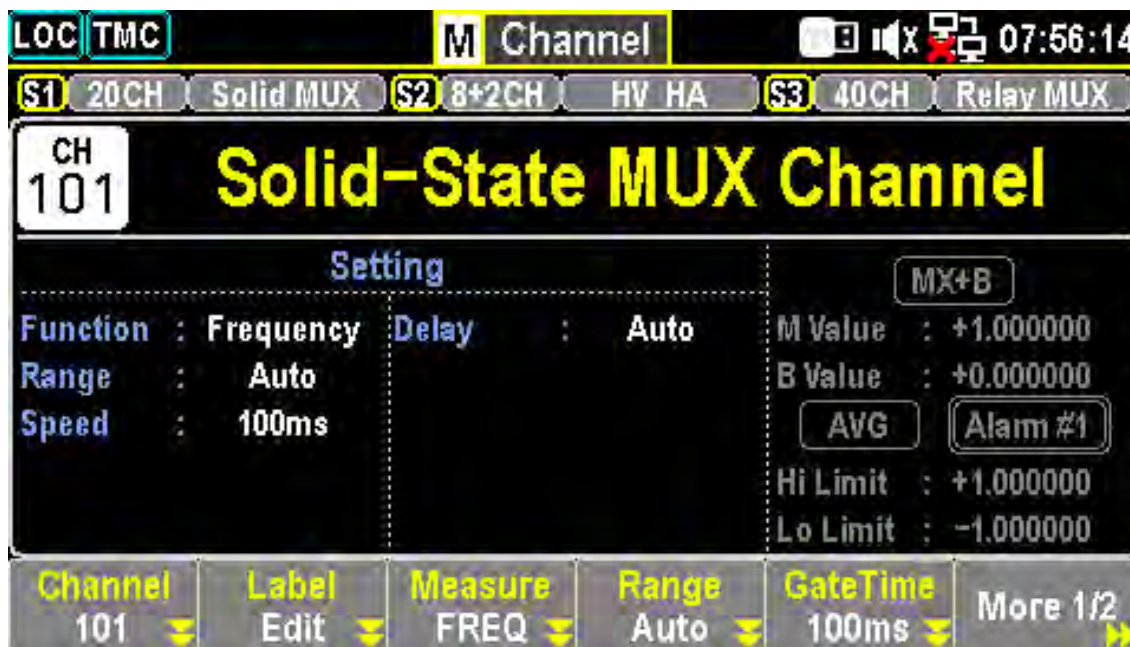

**Figure 6.21** Frequency & Period Settings Page 1

Function Key	Description
F3 (Measure)	Select Frequency or Period: Press the key to select either Frequency or Period measurement.
FREQ & PERIOD	Input Source and Module Terminals Connection: Connect the appropriate input source and module terminals for Frequency or Period measurement.
F4 (Range)	Specify Range: Press the key to enter the Range menu and select a target range for Frequency/Period measurements individually. The Auto option selects the range based on the source input automatically, which may result in slower measurements compared to manual range selection. Using the Range keys allows for quicker range selection.
F5 (GateTime)	Select Speed: Press the key to specify the threshold to recalculate Frequency/Period. The slower the gate time (e.g., 1s), the more accurate the reading value.
F6 (More 1/2)	Enter Next Function Keys Page: Press the key to enter the next page (More 2/2) for additional function configurations for measurement.

**Table 6.25** Frequency/Period Measurement

6.9.1 Frequency Period Measurement Page 2

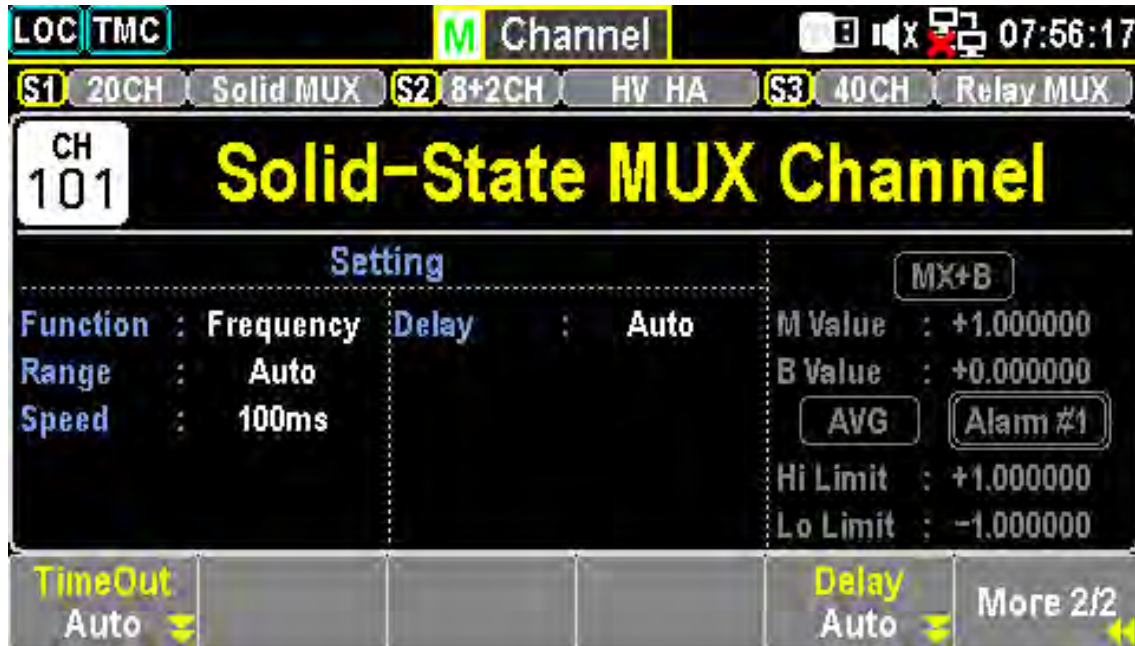

Figure 6.22 Frequency & Period Settings Page 2

Function Key	Description
TimeOut (F1)	Define Value: It defines the exact value for timeout, meaning the measurement will be suspended after reaching the set timeout value when no input is detected. Note that when selecting "Auto," the timeout setting will sync with the Gate Time value.
Delay (F5)	Select a Delay Time: The user defines a delay time to be inserted between the actual measurement on each channel during a scan course.

Table 6.26 Frequency Period Measurement Page 2

## 6.10 Diode Measurement

The diode measurement configurations.



**Figure 6.23** Diode Settings Page 1

Function Key	Description
F3 (Measure)	Select Diode: Press the key to select Diode measurement.
DIODE	Diode Source and Module Terminals Connection: Connect the appropriate source and module terminals for Diode measurement.
F4 (Range)	Range Fixed at 5V: The range selection is fixed at 5V for Diode measurement.
F5 (Speed)	Select Speed: Press the key to enter the Speed menu and select a target speed for Diode measurement. Arrow keys can be used to select speed promptly.
F6 (More 1/2)	Enter Next Function Keys Page: Press the key to enter the next page (More 2/2) for additional function configurations for measurement.

**Table 6.27** Diode Measurement

6.10.1 Diode Measurement 2/2 page



Figure 6.24 Diode Settings Page 2

Function Key	Description
Auto Zero (F1)	Set Auto Zero: Turning on Auto Zero provides the most accurate measurements but requires extra time. With Auto Zero on, the DAQ3120 internally measures the offset after each measurement and subtracts it from the preceding reading, preventing offset voltages from affecting accuracy. With Auto Zero off, the offset is measured once and subtracted from all subsequent measurements.
Delay (F5)	Select a Delay Time: The user defines a delay time to be inserted between the actual measurement on each channel during a scan course.

Table 6.28 Diode Measurement Page 2

## 6.11 Capacitance Measurement

The capacitance measurement configurations.

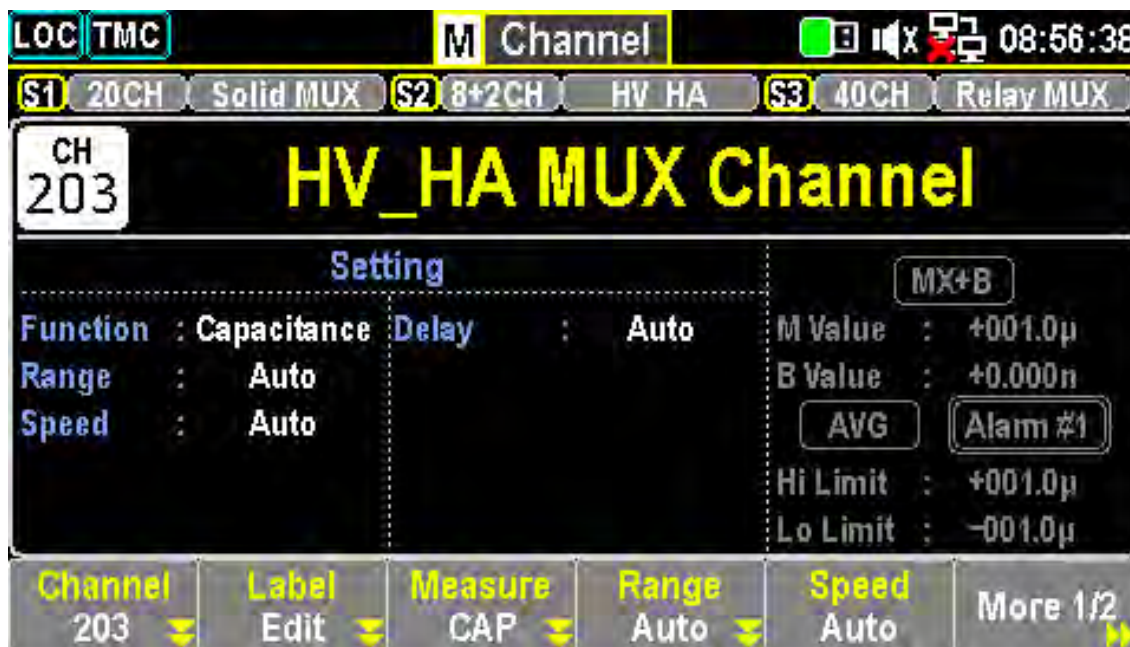

**Figure 6.25** Capacitance Settings Page 1

Function Key	Description
F3 (Measure)	Select Capacitance: Press the key to select Capacitance measurement.
CAP	Capacitance Source and Module Terminals Connection: Connect the appropriate source and module terminals for capacitance measurement.
F4 (Range)	Specify Range: Press the key to enter the Range menu and select a target range for capacitance measurement. The Auto option selects the range based on the source input automatically, which may result in slower measurements compared to manual range selection. Using the Range keys allows for quicker range selection.
F5 (Speed)	Speed Fixed in Auto: The Speed selection is fixed in Auto for capacitance measurement.
F6 (More 1/2)	Enter Next Function Keys Page: Press the key to enter the next page (More 2/2) for additional function configurations for measurement.

**Table 6.29** Caspacitance Measurement

6.11.1 Function Keys in More 2/2 page



Figure 6.26 Capacitance Settings Page 2

Function Key	Description
Delay (F5)	Select a Delay Time: The user defines a delay time to be inserted between the actual measurement on each channel during a scan course.

Table 6.30 Capacitance Measurement Page 2

## 6.12 DCI/ACI Measurement

The DCI and ACI current measurements configurations. Note: Both DC and AC current measurements are available on channels 21 and 22 of the DM301 module only.

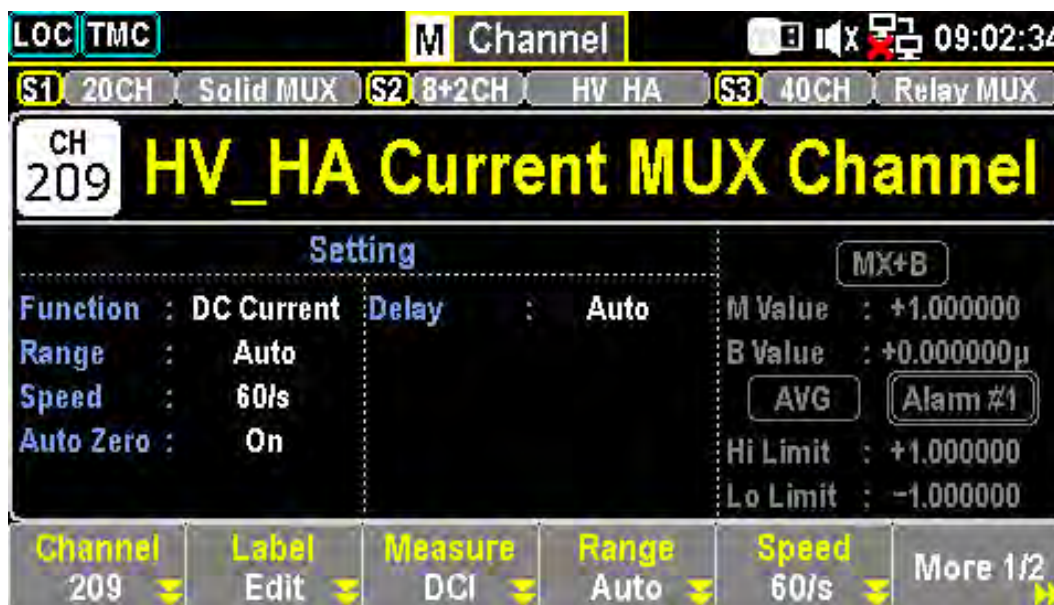

**Figure 6.27** DCI & ACI Settings Page 1

Function Key	Description
F3 (Measure)	Select either ACI or DCI: Press the key to select either DC (DCI) or AC (ACI) current measurement.
DCI	Current Sources and Module Terminals Connection: Connect the appropriate source and module terminals for DCI or ACI measurement.
ACI	Current Sources and Module Terminals Connection: Connect the appropriate source and module terminals for DCI or ACI measurement.
F4 (Range)	Select Range for ACI and DCI: Press the key to enter the Range menu and select a target range for ACI and DCI measurements individually. The Auto option selects the range based on the source input, which may result in slower measurements compared to manual range selection. The Range keys allow for faster range selection.
F5 (Speed)	Select Speed for ACI and DCI: Press the key to enter the Speed menu and select a target speed for ACI and DCI measurements individually. Arrow keys can be used for quick speed selection.
F6 (More 1/2)	Enter Next Function Keys Page: Press the key to enter the next page (More 2/2) of additional function configurations for measurement.

**Table 6.31** DCI/ACI Measurement

6.12.1 DCI/ACI Measurement Page 2

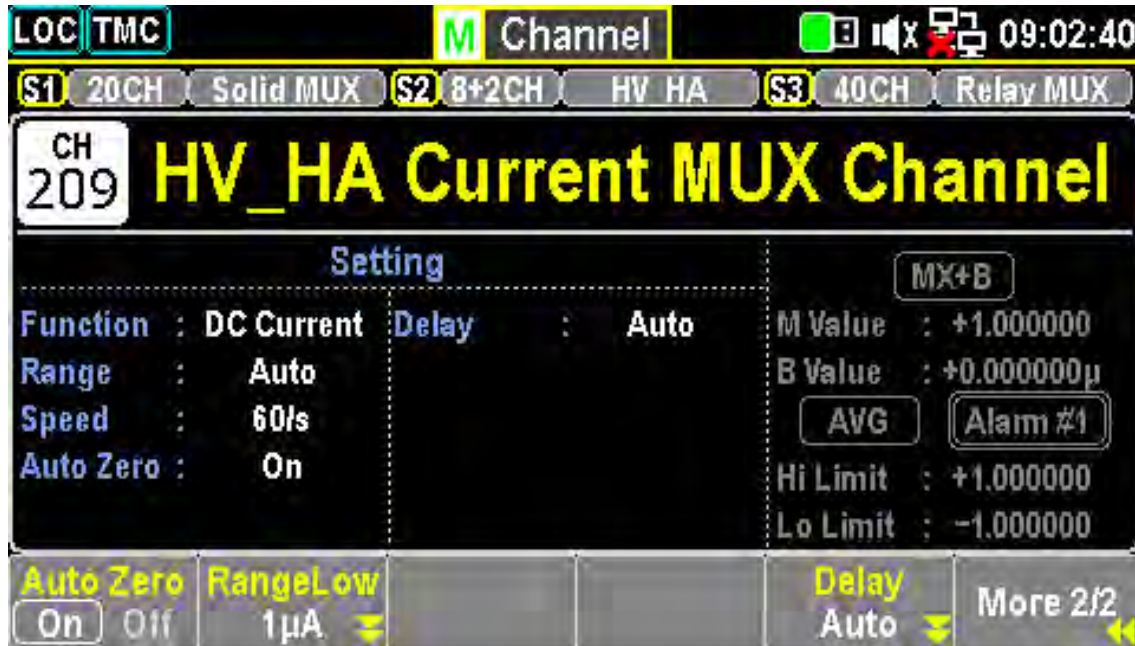

Figure 6.28 DCI & ACI Settings Page 2

Function Key	Description
Auto Zero (F1)	Set Auto Zero (DCI only): By turning on Auto Zero, the most accurate measurements are provided, but it requires extra time to execute the zero measurement. With Auto Zero on, the DAQ3120 internally measures the offset after each measurement and subtracts it from the preceding reading, preventing offset voltages from affecting measurement accuracy. With Auto Zero off, the DAQ3120 measures the offset once and subtracts it from all subsequent measurements.
Range Low (F2)	Select Rate: The current range is limited within the selected low ranges when Auto Range is activated. This function helps to reduce errors caused by shunt when the current range changes excessively.
Delay (F5)	Select a Delay Time: The user defines a delay time to be inserted between the actual measurements on each channel during a scan course.

Table 6.32 DCI/ACI Measurement Page 2

## 6.13 Scan 2-Wire & 4-Wire Measurement

The 2-wire and 4-wire connections are available for diversified measurements when connected with an external DMM unit, provided the internal DMM function is disabled. For different DUTs, select and physically wire the applicable 2W or 4W connections.

Function Key	Description
F3 (Measure)	Select either Scan 2W or Scan 4W: Press the key to select Scan 2-Wire or Scan 4-Wire for the measurement.
Scan 2W	2-Wire connection selection: Physically wire the device for 2-wire connection when selected.
Scan 4W	4-Wire connection selection: Physically wire the device for 4-wire connection when selected.
F6 (More 1/2)	Enter Next Function Keys Page: Press the key to enter the next page (More 2/2) of additional function configurations for measurement.
Function Keys in More 2/2 page	
Delay (F5)	Select a Delay Time: User defines a delay time to be inserted between the actual measurements on each channel during a scan course.

**Table 6.33** Scan 2-Wire & 4-Wire Measurement

### NOTICE

Only when the DMM function is deactivated can both “Scan 2W” and “Scan 4W” options for Measure be available.

## 6.14 Switch Mode for Multiplexer Modules

The Switch mode from multiplexer modules empowers the user to open and close channels individually. We will introduce how to turn on and configure channels to the Switch mode in detail.

**NOTICE** Switch mode is available on the multiplexer DM300, DM301, and DM303 modules only.

**Step 1.** From the instance below in the Channel menu, the channel 101 is configured to measure mode STRAIN.

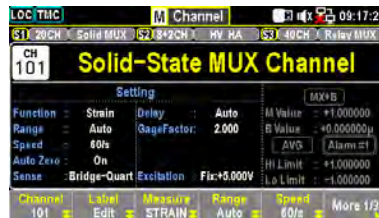

**Figure 6.29** CH101  
Set to Strain

**Step 2.** Press the **Module** key from the front panel followed by clicking the **ViewMode** key and then **CH List** key.

**Step 3.** Use the **Knob** key to navigate through pages of a module (Slot 1 in the instance). It is seen that only channel 101 is turned **ON** in Scan Status (measurement). Press the **Remove All (F3)** key to **OFF** all channels on the Slot 1 module from Scan Status, which indicates that measurements of all channels on the module can now be configured to the Switch mode.



**Figure 6.30** Remove All

**Step 4.** Press the **Channel** key from the front panel. It is seen that the **Measure** is **OFF** for channel 101 and the **Switch** key and **JoinBank** key are available for On or Off by the user.

- **Switch:** To enable or disable the switch for each channel.
- **JoinBank:** To enable or disable multiple banks join of a module.

**Step 5.** If the user reselects a measurement from the **Measure** key (TEMP in the instance), the channel 101 will return to Scan Status **ON** and both the **Switch** key and **JoinBank** key are no longer available.

### 6.14.1 Display

The figure below shows both Switch and JoinBank are turned ON for channel 101 of the Slot 1 module.

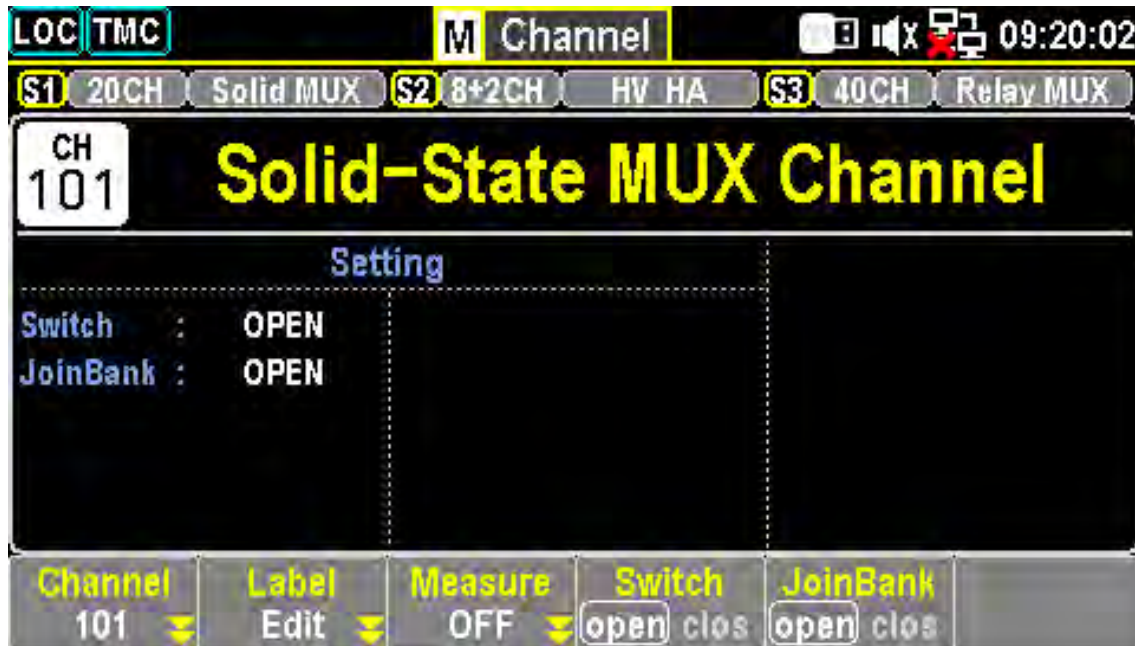

**Figure 6.31** Switch and Join On

**NOTICE**

When enabling the JoinBank function on any of the channels, the JoinBank of all channels from the same module will be turned ON simultaneously.

## 6.15 Computer Channels

Computer channels (401 – 420) can execute various mathematical operations from readings of measurement channels or other computer channels.

### NOTICE

- To execute mathematical operations in computer channels, it is required to set up measurement channels beforehand.
- Computer channels are not able to be monitored for readings in the Monitor mode. However, it is possible to monitor readings of computer channels when the Scan mode is performed.

### 6.15.1 Types

The mathematical operations of computer channels can be divided into mainly three types as follows:

Type	Soft Key	Description
Basic Math	A + B	Addition
	A - B	Subtraction
	A * B	Multiplication
	A / B	Division
	1 / A	Reciprocal
	A * A	Power
	Sqrt(A)	Square root
Statistics	AVG(List)	Calculates the average readings from a list of selected channels, where average reading = total sum of all the readings / number of selected channels
	MIN(List)	Calculates the minimum reading from a list of selected channels
	MAX(List)	Calculates the maximum reading from a list of selected channels
	SDEV(List)	Calculates the standard deviation readings from a list of selected channels
Polynomial	5TH(A)	Polynomial 5TH

**Table 6.34** Math Types

## 6.16 Basic Math

An example of a mathematical operation ( A + B ) on channel 401 will be illustrated below.

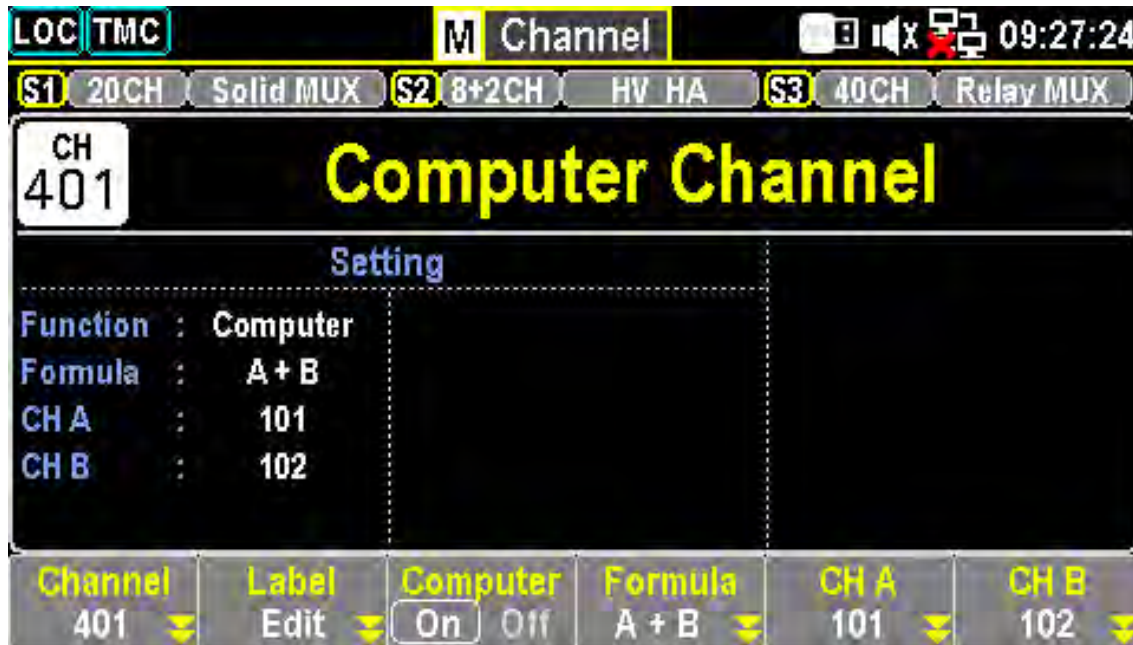

Figure 6.32 Basic Math

### 6.16.1 Steps

- From the example below in the Channel menu, the **Computer** (F3) key is turned On, and the **Formula** (F4) key is configured to ( A + B ).
- Also, press the **CH A** (F5) and the **CH B** (F6) keys to specify source channels as 101 and 102, individually.

#### NOTICE

The source channels of **CH A** and **CH B** can be identical. For instance, it is available to specify both as channel 101.

- Launch a scan course by pressing the **Scan** key from the front panel, followed by clicking the **View** key from the front panel. The scan result is displayed here:

“CH401 (+0.154744) = CH101 (077.1446) + CH102 (077.6001)”

## 6.17 Statistics

An example of a mathematical operation AVF(List) on channel 401 is illustrated below.

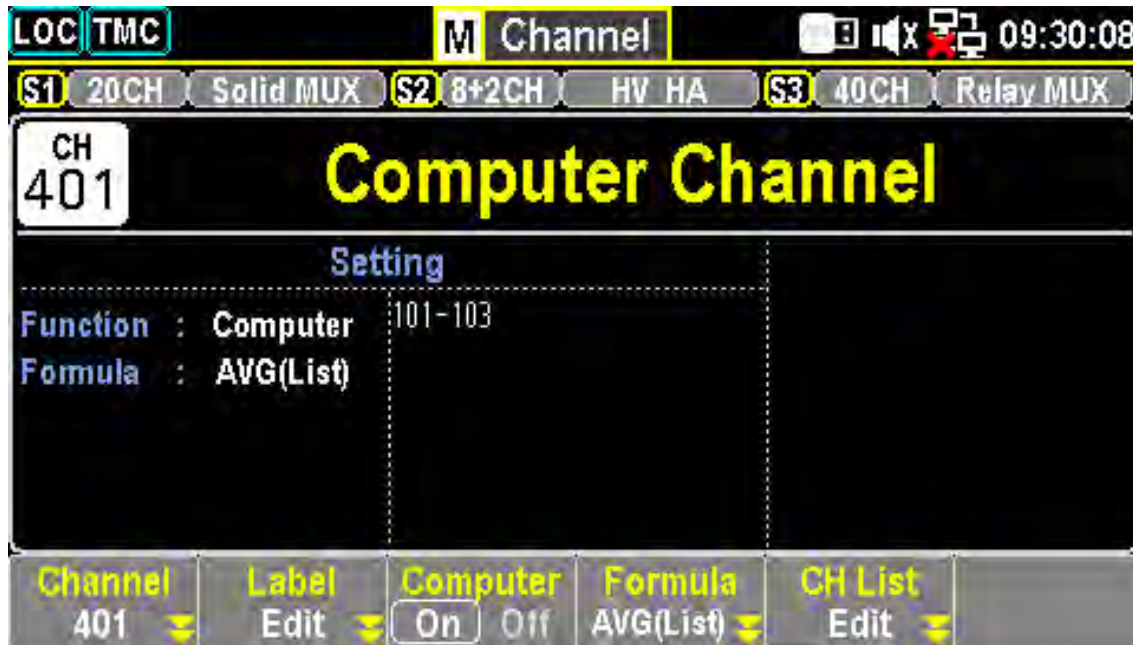

Figure 6.33 AVF(List) on channel 401

**Step 1.** From the example below in the **Channel** menu:

- The **Computer (F3)** key is turned On.
- The **Formula (F4)** key is configured to AVG(List).
- Press the **CH List (F5)** key to enter the channel list edit mode.

**Step 2.** Use the knob key to navigate channels.

- Press the **Select (F5)** key to select a channel.
- Press the **OK (F4)** key to confirm all selections.
- If a channel is selected:
  - i. Press the **Cancel (F5)** key to deselect a channel.
  - ii. Press the **ClearAll (F3)** key to deselect all channels.
  - iii. Press the **Exit (F6)** key to leave without saving.

**Step 3.** Launch a scan process by:

- Pressing the **Scan** key from the front panel.
- Clicking the **View** key from the front panel.
- The scan result is displayed as follows:

$$CH401(+078.2949) = \frac{CH101(078.0570) + CH102(078.4820) + CH103(078.3456)}{3}$$

## 6.18 Polynomial 5TH

An example of a mathematical operation 5TH(A) on channel 401 is illustrated below.

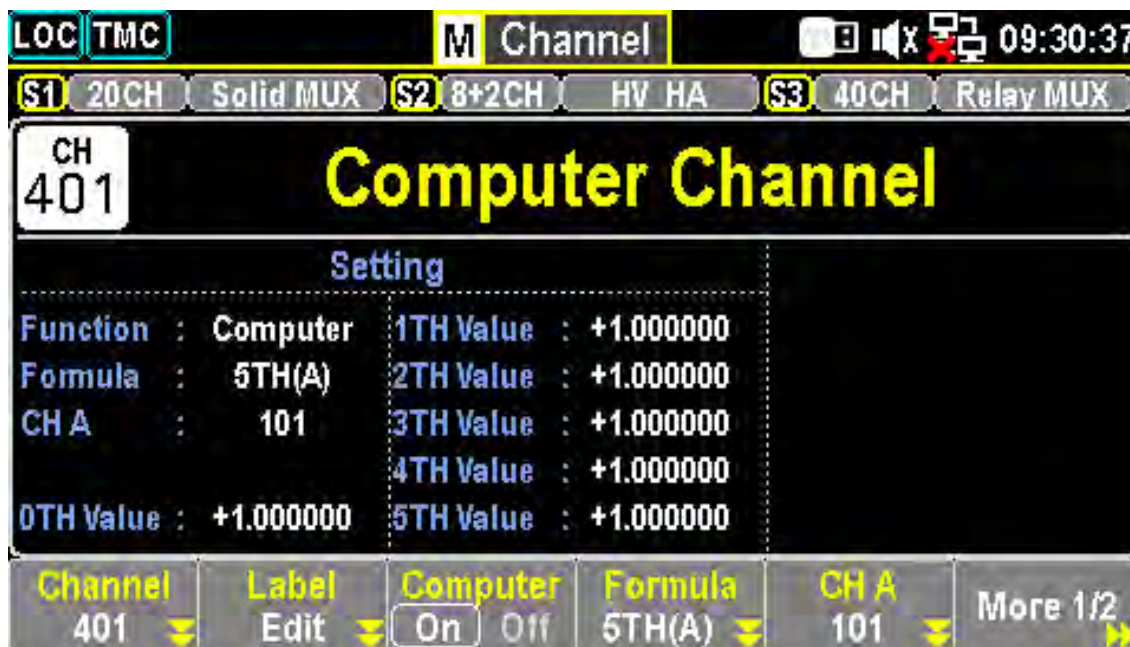

Figure 6.34 5TH(A)

**Step 1.** In the **Channel** menu:

- The **Computer (F3)** key is turned On.
- The **Formula (F4)** key is configured to 5TH(A).
- Press the **CH A (F5)** key to specify source channels as 201.
- Press the **More 1/2 (F6)** key to enter the next page.

**Step 2.** Configure the polynomial order:

- Press the **(x)TH (F1)** key to select a coefficient order (0TH, 1TH, 2TH, 3TH, 4TH, 5TH).
- Press the **TH Value (F2)** key to configure parameters for each coefficient order.

**Step 3.** Launch a scan process by:

- Pressing the **Scan** key from the front panel.
- Clicking the **View** key from the front panel.
- The scan result is displayed as follows:

$CH401(+1.085099) = \text{The polynomial 5TH order from } CH101(078.8081)$

# Trigger Menu

Press the Trigger key on the front panel to enter the Trigger menu to configure the method to start each sweep and the total number of sweeps for a scan course. The screen layout of the Trigger menu is almost identical to that of the Home screen, differing only in function keys.

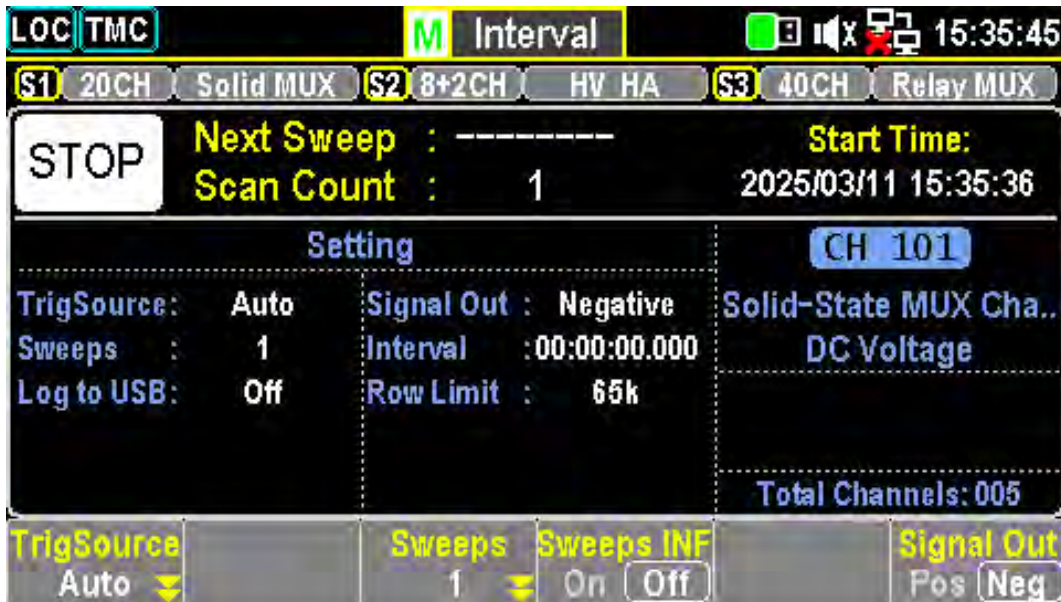

Figure 7.1 Trigger Menu

Key	Description
F1 (TrigSource)	Select a trigger source method.
<b>Auto</b>	Immediate trigger: each sweep starts automatically when a scan course begins.
<b>Time</b>	Timer trigger: each sweep starts at a designated interval. Press F2 (Time) to configure the interval. Next sweep waits until countdown by set timer.
<b>Manual</b>	Manual trigger: user must press the Scan key on the front panel to start each sweep. Next sweep waits until Scan key is pressed.
<b>External</b>	External signal trigger: received from the rear panel to start each sweep. Press F2 (TrigSignal) to configure the polarity (Pos or Neg). Next sweep waits until an external signal is received.
<b>On Alarm</b>	Trigger starts when an alarm is detected on the set channel. Press F2 (On Alarm) to specify which alarm (1-4) to use. Next sweep waits until the designated alarm is detected.

Table 7.1 Trigger Source

## 7.1 Additional Trigger Configuration

Key	Description
F2 (Time)	When <i>Time</i> of TrigSource is selected, press this key to specify a time interval.
F2 (TrigSignal)	When <i>External</i> of TrigSource is selected, press this key to configure polarity (Pos or Neg).
F2 (On Alarm)	When <i>On Alarm</i> of TrigSource is selected, press this key to specify which alarm (1-4) to use.
F3 (Sweeps)	Specify the total number of sweeps in a scan course.
F4 (Sweeps INF)	Configure DAQ3120 to execute a scan course indefinitely until stopped by long pressing the Scan key.
F6 (Signal Out)	Configure signal out polarity (Pos or Neg) on the rear panel.

**Table 7.2** Additional Trigger Configurations

# Edit Menu

Press the Edit key on the front panel to enter the Edit menu, allowing the user to copy measurement functions, alarm settings, and more between channels with ease.



**Figure 8.1** Edit Menu

Section	Description
<b>Source Channel</b>	The selected source channels are displayed in detail in the lower section, while the upper section indicates the total number of selected source channels.
<b>Destination Channel</b>	The selected destination channels are displayed in detail in the lower section, while the upper section indicates the total number of selected destination channels.
Softkey Functions	<p>Provides access to function keys for configuring various display modes.</p> <ul style="list-style-type: none"> <li>• Press F1 (Source CH) to select source channel(s),</li> <li>• Press F2 (Dest. CH) to select destination channel(s),</li> <li>• Press F6 (Copy) to perform the copying action.</li> </ul>

**Table 8.1** Edit Menu

## 8.1 Copy Channels

Channel copying can be performed in various ways: one-to-one, one-to-many, and many-to-many. The following steps illustrate an example of many-to-many channel copying.

**Step 1.** Press the **Edit** key on the front panel to enter the Edit menu.

**Step 2.** Press F1 (Source CH) to edit the Source Channel Select list.



**Figure 8.2** Edit Source Channel

**Step 3.** Use the knob key to navigate channels, then press **Select** or **SelectAll** to select source channels. Press **Cancel** or **ClearAll** to deselect channels. Press **OK** to confirm selection or **Exit** to leave without saving.

### NOTICE

Only channels configured with measurement functions are displayed in the Source Channel Select list.

**Step 4.** After confirming, the selected source channels are displayed on the left (e.g., channels 201–203). Press F2 (Dest. CH) to edit the Destination Channel Select list.



**Figure 8.3** Edit Destination Channel

**Step 5.** Use the knob key to navigate channels, then press **Select** or **SelectAll** to select destination channels. Press **Cancel** or **ClearAll** to deselect channels. Press **OK** to confirm selection or **Exit** to leave without saving.

**NOTICE**

Previously selected source channels will not appear in the Destination Channel Select list.

---

**Step 6.** After confirming, the selected destination channels are displayed on the right (e.g., channels 206–208). Press F6 (Copy) to execute the copying action.

**Step 7.** The configurations of channels 201–203 are copied to channels 209–211. A prompt message ‘3 channels copied’ is displayed.

**NOTICE**

Computer channels (401–420) are not available for copying operations.

---

# Alarm Menu

Press the **Alarm** key on the front panel to enter the Alarm menu to configure the conditions of triggered alarms for selected channels. The screen layout of the Alarm menu is almost identical to that of the Channel menu, differing only in function keys.

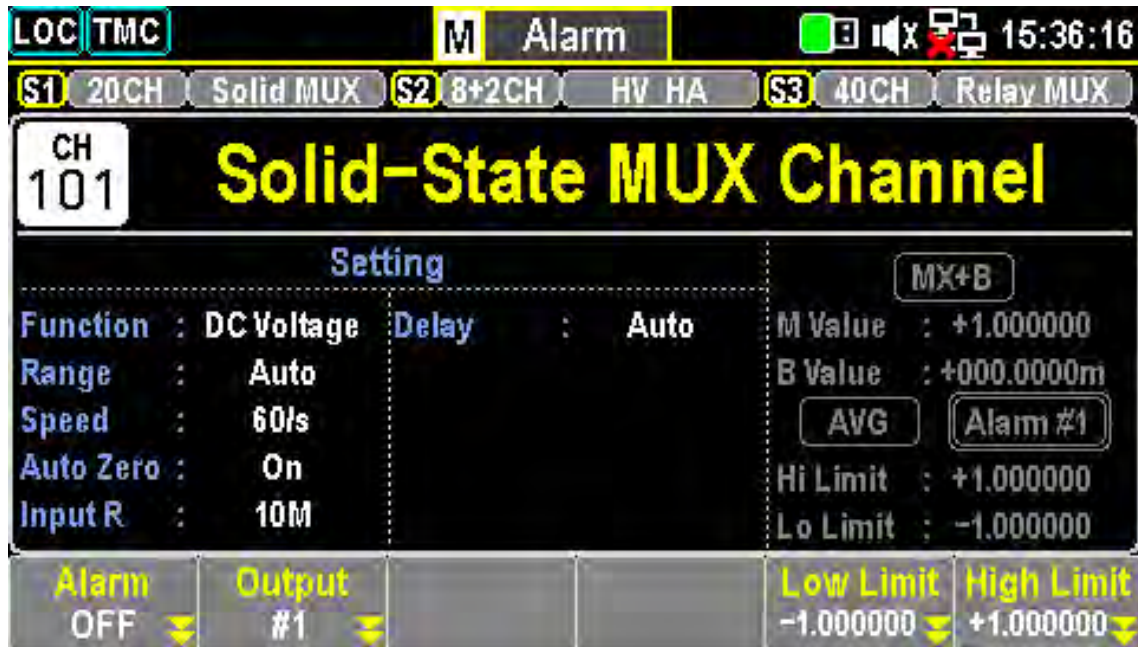

Figure 9.1 Alarm Menu

Section	Description
<b>Select Channel</b>	Indicates the currently selected channel.
<b>Measure Setting Display</b>	Shows the parameter settings of the selected channel.
<b>Alarm Display</b>	Displays the high and low alarm limit settings for the selected channel. Press the knob key to toggle between AVG and Alarm setting display.
<b>Function Keys</b>	The operable function keys in the Alarm menu.

Table 9.1 Alarm Display

## 9.1 Alarm Configuration

This section demonstrates how to configure alarm conditions for each selected channel.

**Step 1.** Press the **Alarm** key on the front panel to enter the Alarm menu.

**Step 2.** Use the knob key to navigate channels and select a target one (e.g., channel 201).

**Step 3.** Press **F1 (Alarm)** to select an alarm limit mode for the selected channel.

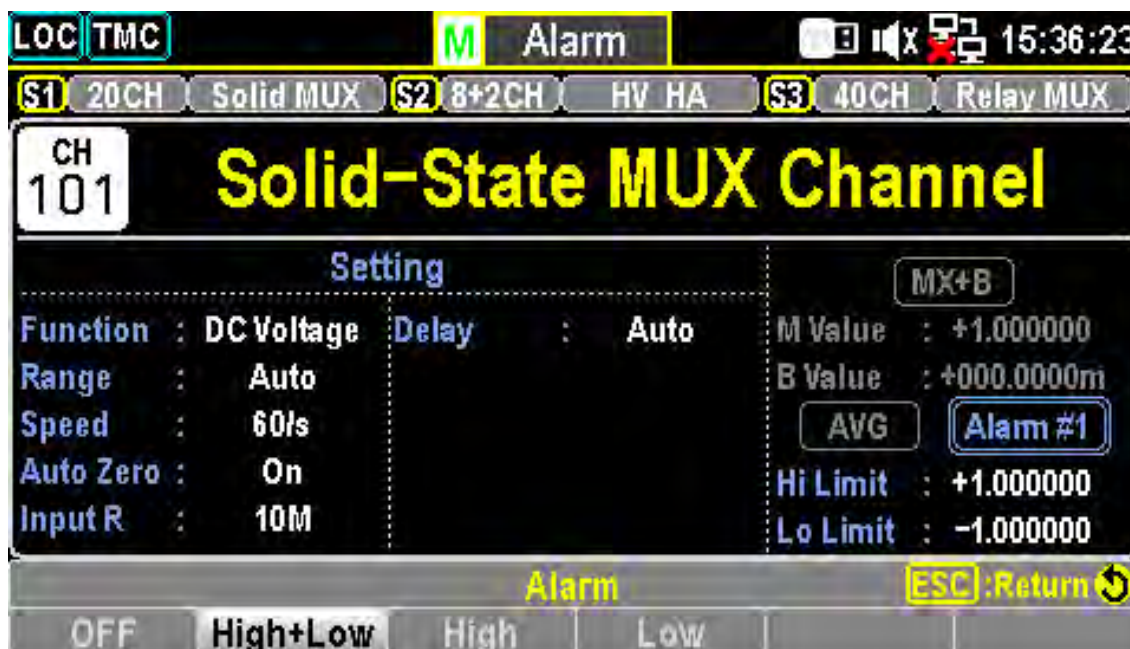

**Figure 9.2** Alarm Modes

Mode	Description
OFF	Alarm condition is disabled for the selected channel.
High + Low	Both high and low alarm limits are activated.
High	Only the high alarm limit is activated.
Low	Only the low alarm limit is activated.

**Table 9.2** Alarm Modes

**Step 4.** Press **F2 (Output)** to select which of the four alarms will be used to report alarm conditions for the selected channel.

**Step 5.** Press **F5 (Low Limit)** and **F6 (High Limit)** to specify alarm limits individually for the selected channel.

**Step 6.** Press the **Scan** key on the front panel to initiate a scan course. When the set alarm occurs for the selected channel during the scan course, the alarm status will be displayed as follows:

The set low limit of alarm #2 is triggered.

**Step 7.** The alarm details will be saved in memory when an alarm occurs for the selected channel during the scan course. Press the **View** key on the front panel to view details of the triggered alarm. (Refer to page 102 for details on the View menu.)

The details of alarm #2 for channel 201 are displayed.

## 9.2 Alarm in Monitor Mode

Under Monitor mode, if the set alarm limit is exceeded, the color of the reading turns warning red in different display modes.

Display Mode	Alarm Indication
Number Display	Reading turns red when alarm is triggered.
Bar Display	Bar color changes to red on alarm trigger.
Trend Display	Trend line changes color on alarm event.
Histogram Display	Histogram bars turn red on exceeding limits.

**Table 9.3** Alarm Monitor Mode

# View Menu

Press the **View** key on the front panel to enter the View menu where several relevant information after scanned measurement, including Data, Alarm, Error, and Relay Cycle, are displayed. This allows the user to gain a better understanding of measured information from a scan course.

---

## 10.1 View Data

This section introduces the view menu for measured scan Data, which can be viewed in various display formats, including:

- **List Display**
- **Statistics Display**
- **Trend Chart Display**
- **Histogram Display**

### 10.1.1 List Display

Date	Time	CH	CH Label	Reading
2025/03/11	15:35:36.699	101	Solid-State MUX Chann.	+004.8839 mVDC
2025/03/11	15:35:36.820	102	Solid-State MUX Chann.	+005.4408 mVDC
2025/03/11	15:35:36.954	201	HV_HA MUX Channel	+000.5261 mVDC
2025/03/11	15:35:37.092	301	Relay MUX Channel	+001.4049 mVDC
2025/03/11	15:35:37.220	302	Relay MUX Channel	+000.4132 mVDC

Figure 10.1 View Data List

- Step 1.** Press the **View (F1)** key followed by pressing the **Data (F1)** key.
- Step 2.** Press the **Display (F2)** key and select the **List (F1)** key to enter the scanned data page in List display.
- Step 3.** Press the **Page (F3)** key to jump between pages of measured data, or use the knob key to navigate through pages conveniently.
- Step 4.** The list mode displays:
- Date
  - Time
  - Channel
  - Channel Label (user-defined name)
  - Reading of each measured data from a scan course

## 10.1.2 Statistics Display

CH	Min	Max	Pk-Pk	Average	STDEV
201	+000.8250m	+000.8250m	+000.0000m	+000.8250m	+0.000000n
203	OverLoad	OverLoad	OverLoad	OverLoad	OverLoad
301	+000.8854m	+000.8854m	+000.0000m	+000.8854m	+0.000000n
302	+001.0614m	+001.0614m	+000.0000m	+001.0614m	+0.000000n

Figure 10.2 View Data Statistics

- Step 1.** Press the **View (F1)** key followed by pressing the **Data (F1)** key.
- Step 2.** Press the **Display (F2)** key and select the **Statistics (F2)** key to enter the Statistics display page.
- Step 3.** Use the knob key to navigate through pages conveniently.
- Step 4.** The statistics mode displays:
- Channel
  - Minimum
  - Maximum
  - Pk-Pk (Peak-to-Peak)
  - Average
  - STDEV (Standard Deviation) of readings from a scan course
- Step 5.** Press the **Mode (F3)** key to toggle between **STAT** (Statistics) and **TIM** (Time Stamp) displays.
- Step 6.** The **TIM** mode displays the Date & Time of Minimum and Maximum readings for each channel from a scan course.

## 10.1.3 Trend Chart Display

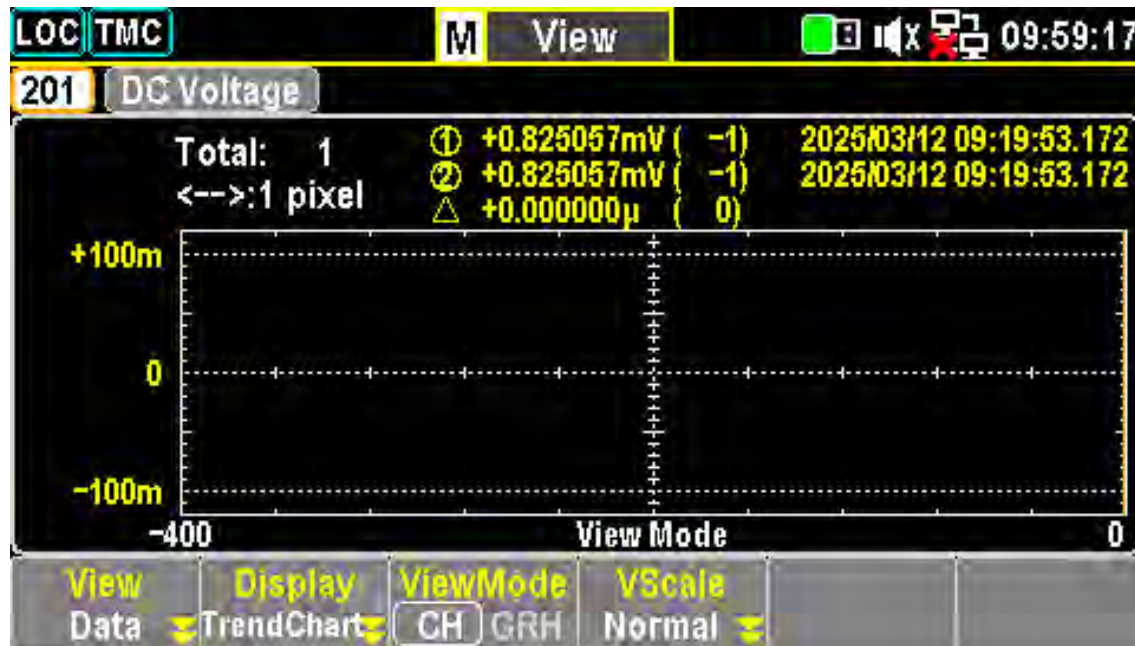

Figure 10.3 View Data Trend Chart

1. Press the **View (F1)** key followed by pressing the **Data (F1)** key. Then press the **Display (F2)** key followed by selecting the **TrendChart (F3)** key to enter the page of scanned data in Trend Chart display.
2. When the "CH" is selected for **ViewMode (F3)** key, scroll the knob key to navigate through channels.
3. When the "GRH" is selected for **ViewMode (F3)** key, scroll the knob key to navigate through scanned counts. If pressing knob key, the maximum counts moving by scrolling knob key per time will be changed.
  - Pixels options: 1 pixel – 40 pixels – 400 pixels

### 10.1.4 VScale Settings

**VScale - Normal** It allows the vertical scale of the trend chart to be symmetric with the set range for the channel.

**VScale - Manual** It allows the vertical scale of the trend chart to be customized in the following two ways:

- a. **L & H for Manual:** After **L** and **H** are set individually, the vertical upper and lower ranges are set accordingly.
  - High: +79.000m
  - Low: +77.000m
- b. **Auto(Once) for Manual:** After **Auto(Once)** is pressed, the vertical upper and lower ranges are automatically defined according to the latest 400 counts of scanned data.
  - High: +78.969m
  - Low: +77.644m

### 10.1.5 Knob Mode

**KnobMode** It allows the user to view detailed information on the trend chart. Press **Range** followed by scrolling the knob key rightward or leftward to move cursors on different sections.

Color Section	Description
Green	The total counts of scanned measurements.
Yellow	Change the maximum counts moving per knob scroll. Options: 1 pixel – 40 pixels – 400 pixels.
Orange	The lowest value of the selected count with its serial number and time stamp.
Blue	The highest value of the selected count with its serial number and time stamp.
White	The delta between the highest and lowest values of the selected count.
Purple	The horizontal scale of measurements displayed is fixed at 400 counts.
Red	Indicates the counts of moving range per knob scroll.

**Table 10.1** Color Selection

**KnobMode – Cursor 1 & Cursor 2** It allows the user to view the lowest and highest readings of each count on the trend chart.

Cursor	Description
Cursor 1 (Green)	Check the lowest value of each count.
Cursor 2 (Blue)	Check the highest value of each count.
Red	Displays the lowest value of the selected count with its serial number and time stamp.
Purple	Displays the highest value of the selected count with its serial number and time stamp.
Yellow	Change the maximum counts moving per knob scroll. Options: 1 pixel – 10 pixels – 20 pixels.
Orange	Delta between the highest and lowest values of the selected count.

**Table 10.2** Cursors

## 10.2 Histogram Display



Figure 10.4 View Data Histogram

- Step 1.** Press the **View (F1)** key followed by pressing the **Data (F1)** key. Then press the **Display (F2)** key and select the **Histogram (F4)** key to enter the Histogram display page.
- Step 2.** When the “CH” option is selected in **ViewMode (F3)**, use the knob key to navigate through channels.
- Step 3.** When the “GRH” option is selected in **ViewMode (F3)**, use the knob key to navigate through each scanned count.
- Step 4.** Since readings are not updated live in histogram display, press the **Refresh (F4)** key to update live readings when a scan course is ongoing.



## 10.4 Error View

This section introduces the **View** menu for Errors. The Error list displays the **Code** and **String** of the latest 20 errors. After the user reads the Error list, the **ERR** icon on the top status bar will be erased, and the entire Error list will be cleared.



Figure 10.6 View Error Menu

- Step 1.** Press the **View (F1)** key followed by pressing the **Error (F3)** key. The Error list page displays the latest errors in detail.
- Step 2.** Use the knob key to navigate through pages and view more errors from different pages.

## 10.5 Relay Cycle View

CH	CH Description	User Cycles
101	Solid-State MUX Channel	1802
102	Solid-State MUX Channel	547
103	Solid-State MUX Channel	18
104	Solid-State MUX Channel	15
105	Solid-State MUX Channel	13
106	Solid-State MUX Channel	10
107	Solid-State MUX Channel	9
108	Solid-State MUX Channel	9

Figure 10.7 View Relay Cycle Menu

This section introduces the **View** menu for Relay Cycle of each channel from the installed module. It enables users to track potential relay failures or determine maintenance requirements.

- Step 1.** Press the **View (F1)** key followed by pressing the **RelayCycle (F4)** key. The Relay Cycles list page displays the number of cycles on each relay from the installed modules.
- Step 2.** Use the knob key to navigate through pages and view the number of cycles for each relay from different channels.

# Module Menu

Press the **Module** key on the front panel to enter the **Module Menu**, where users can:

- View circuit diagrams of installed modules.
- Check both **Scan Status** and **Switch Status** of channels from installed modules.
- Proceed with firmware updates for installed modules.

**Step 1.** After pressing the **Module** key on the front panel, the circuit diagram of the installed module is displayed.

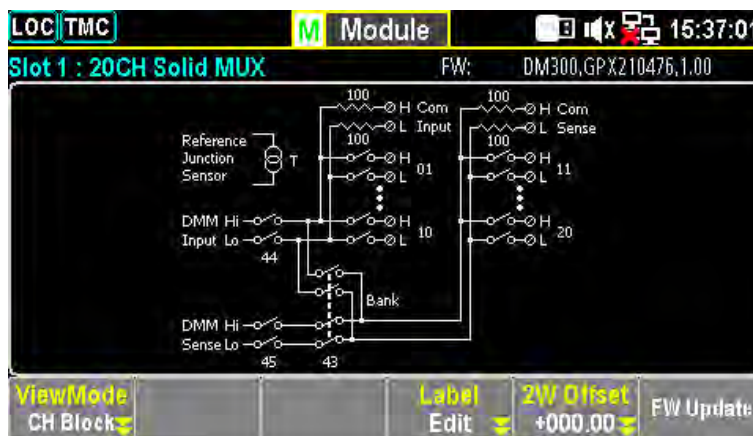

**Figure 11.1** Module Channel Block Diagram

Scroll the knob key to navigate through installed modules and select a target module.

**Step 2.** Press the **ViewMode (F1)** key followed by pressing the **CH List (F2)** key. The **Scan Status** of all channels from the selected module will be shown. Scroll the knob key to navigate through pages of different channels. Press **Remove All (F3)** to remove the set measurements of all channels at once.

CH	CH Description	Channel Status
101	Solid-State MUX Channel	ON
102	Solid-State MUX Channel	ON
103	Solid-State MUX Channel	OFF
104	Solid-State MUX Channel	OFF
105	Solid-State MUX Channel	OFF
106	Solid-State MUX Channel	OFF
107	Solid-State MUX Channel	OFF
108	Solid-State MUX Channel	OFF

**Figure 11.2** Module Channel List Diagram

**Step 3.** If any channel is set to **Switch Mode**, press the **Status (F2)** key to select **SW**, then press the **Card Reset (F3)** key to reset the selected module. All channels on the module will be opened.

**Step 4.** To carry out a firmware update for the installed module, press the **FW Update (F6)** key to initiate the update process. A prompt message will appear, and the user can press **Yes (F1)** to proceed with the update.

- Connect a USB disk containing a compatible module firmware file to the USB host port on the front panel of the **DAQ3120** before proceeding with the **FW Update**.
- Before updating, rename and confirm the downloaded firmware files as follows:

**NOTICE**

C\_IMAGE.bin

# Math Menu

Press the **Math** key on the front panel to enter the **Math Menu**. The Math measurement performs five types of mathematical equations based on measurement results of each channel:

- a. dB
- b. dBm
- c. MX+B
- d. 1/X
- e. Percent

## 12.1 Math Equations

Equation	Description
dBm	$10 \times \log_{10} \left( \frac{1000 \times V_{reading}^2}{R_{ref}} \right)$
dB	$dBm - dBm_{ref}$
MX+B	Multiplies the reading (X) by the factor (M) and adds/subtracts offset (B).
1/X	Divides 1 by the reading (X).
Percent	$\frac{(Reading_x - Reference)}{Reference} \times 100\%$

**Table 12.1** Math Equations

- Users need to configure channel measurement before setting up the Math equations.
- If the measurement of a channel is changed (e.g., from ACV to DCV), the Math function will be turned off. Reconfigure the Math function after changing the measurement.
- dBm and dB equations are available only on channels set to DCV and ACV measurements.

**NOTICE**

## 12.2 dBm Measurement

---

$$10 \times \log_{10} \left( \frac{1000 \times V_{reading}^2}{R_{ref}} \right)$$

### 12.2.1 Function Keys

---

- **F1 (Function)** – Selects the dBm equation.
- **F3 (REF Ω)** – Press to enter the menu to change the reference resistance, which simulates an output load.
- **F2 (MathDisp)** – Press to show the **MathDisp** menu for four different display modes.

#### NOTICE

Only when Alarm configuration is enabled can the **Alarm** and **ALR+STAT** options in Math Display be activated.

---

## 12.3 Math Display Modes

---

### 12.3.1 Show STAT Result

---

- **Description:** The **STAT** page in **MathDisp** allows users to make statistical calculations for measurements including: Minimum, Maximum, Average, Peak-to-Peak, Standard Deviation, and Count.
- **Values:**
  - Latest dBm value: **-059.9306 dBm**
  - Minimum value
  - Maximum value
  - Average value
  - Peak-to-Peak value
  - Standard Deviation (STDEV)
  - Count of dBm measurements

### 12.3.2 Show Math Result

---

- **Description:** The **Math** page in **MathDisp** allows users to view mathematical calculations for various parameters.
- **Values:**
  - **Latest dBm value:** -074.9923 dBm
  - **Measure:** The originally measured Voltage value
  - **Ref $\Omega$ :** The defined reference resistance value

### 12.3.3 Show Alarm Result

---

- **Description:** The **Alarm** page in **MathDisp** allows users to track whether measured data exceeds the set High and Low limits.
- **Values:**
  - **Low Limit:** The set low limit of the channel
  - **High Limit:** The set high limit of the channel
  - **Low Fail:** The number of occurrences where the low limit was exceeded
  - **High Fail:** The number of occurrences where the high limit was exceeded

### 12.3.4 Show ALR+STAT Result

---

- **Description:** The **ALR+STAT** page in **MathDisp** allows users to view information from both the **STAT** and **Alarm** pages simultaneously.
- **Values:**
  - **Left Section:** Displays the number of times High and Low limits were exceeded individually.
  - **Right Section:** Displays dBm-based values identical to those in the **STAT** page.

**NOTICE**

Only when Alarm configuration is enabled can the **Alarm** and **ALR+STAT** options in **Math Display** be activated. Refer to page 99 for details on **Alarm**.

---

## 12.4 dB Measurement

$$\text{dB} = \text{dBm} - \text{dBm}_{ref}$$

### 12.4.1 Function Keys

- **F1 (Function)** – Selects the dB equation.
- **F3 (REF  $\Omega$ )** – Press to enter the menu to change the reference resistance, simulating an output load.
- **F4 (Ref Method)** – Press to enter the **Reference Method** menu, which provides two ways to calculate the dB value:
  - If the **dBm** option is selected, the user can specify a definite dBm value for dB calculation.
  - If the **Voltage** option is selected, the system regards the defined voltage value as the  $V_{reading}$  parameter for dBm calculation, yielding a different dB value.
- **F5 (Ref Value)** – Press to enter the **Ref Value** menu and configure either voltage or dBm reference values, corresponding to the previous **F4 (Ref Method)** option.
- **F6 (Ref Value)** – Press to instantly set the current dBm value, calculated from the current input voltage, as the **Ref dBm**.
- **F2 (MathDisp)** – Press to show the **MathDisp** menu for four different display modes (see descriptions below).

### NOTICE

Only when Alarm configuration is enabled can the **Alarm** and **ALR+STAT** options in **Math Display** be activated.

---

### 12.4.1.1 Show STAT Result

- **Description:** The **STAT** page in **MathDisp** allows users to perform statistical calculations for measurements, including: Minimum, Maximum, Average, Peak-to-Peak, Standard Deviation, and Count.
- **Values:**
  - Latest dB value: **+03.01737 dB**
  - Minimum value
  - Maximum value
  - Average value
  - Peak-to-Peak value
  - Standard Deviation (STDEV)
  - Count of dB measurements

### 12.4.1.2 Show Math Result

- **Description:** The **Math** page in **MathDisp** allows users to view mathematical calculations for various parameters.
- **Values:**
  - **Latest dB value: -039.6161 dB**
  - **Measure: The originally measured Voltage value**
  - **Ref $\Omega$ : The defined reference resistance value**
  - **Ref Voltage: The measured reference voltage value**
  - **Ref dBm: The measured reference dBm value**

### 12.4.1.3 Show Alarm Result

- **Description:** The **Alarm** page in **MathDisp** allows users to track whether measured data exceeds the set High and Low limits.
- **Values:**
  - **Low Limit: The set low limit of the channel**
  - **High Limit: The set high limit of the channel**
  - **Low Fail: The number of occurrences where the low limit was exceeded**
  - **High Fail: The number of occurrences where the high limit was exceeded**

#### **12.4.1.4 Show ALR+STAT Result**

---

The **ALR+STAT** page in **MathDisp** allows users to view information from both the **STAT** and **Alarm** pages simultaneously.

- **Left Section:** Displays the number of times High and Low limits were exceeded individually.
- **Right Section:** Displays dB-based values identical to those in the **STAT** page.

**NOTICE**

Only when Alarm configuration is enabled can the **Alarm** and **ALR+STAT** options in **Math Display** be activated. Refer to page 99 for details on **Alarm**.

---

## 12.5 MX+B Measurement

The Math Equation multiplies the reading ( X ) by the factor ( M ) and adds/subtracts the offset ( B ).

- **F1 (Function):** Select MX+B equation
- **F3 (M Value):** Set the gain ( M ) value. Press to enter the menu and configure the ( M ) (Gain) value for the MX+B equation.
- **F4 (B Value):** Set the offset ( B ) value. Press to enter the menu and configure the ( B ) (Offset) value for the MX+B equation.
- **F5 (B (Offset)):** Instantly perform an offset current measurement for the ( B ) (Offset) value.
- **F2 (MathDisp):** Show the MathDisp menu with 4 different displays. See the following descriptions for details.

### NOTICE

Only when Alarm configuration is enabled can the "Alarm" and "ALR+STAT" of Math Display be activated.

### 12.5.1 Show STAT Result

The STAT page in MathDisp allows the user to perform statistical calculations including Minimum, Maximum, Average, Peak-Peak, Standard Deviation, and Count.

- +074.26 mVAC Latest MX+B value
- Minimum Minimum value
- Maximum Maximum value
- Average Average value
- Peak-Peak Peak to peak value
- STDEV Standard deviation value
- Count Latest counts of MX+B

### 12.5.2 Show Math Result

The Math page in MathDisp allows the user to view mathematical calculations for several parameters.

- Latest MX+B value
- Originally measured Voltage value
- Defined ( M ) value
- Defined ( B ) value

### **12.5.3 Show Alarm Result**

---

The Alarm page in MathDisp allows the user to track if measured data exceeds the set High and Low limits.

- Low Limit Set low limit of channel
- High Limit Set high limit of channel
- Low Fail Number of low limit exceedances
- High Fail Number of high limit exceedances

### **12.5.4 Show ALR+STAT Result**

---

The ALR+STAT page in MathDisp allows the user to view information from both STAT and Alarm pages simultaneously.

- Left Sec. Number of High and Low limit exceedances shown individually.
- Right Sec. Values, based on MX+B calculation, identical to those on the STAT page.

### **12.5.5 Function Keys in More 2/2 page**

---

- **F1** (*B (Offset)*): Clear ( B ) value. Press to clear the ( B ) value to zero.
- **F2** (*User Units*): Turn On or Off user-defined units. Choosing On will display user-defined units on measurement, selecting Off will display default units (VDC).
- **F3** (*Units*): Edit User Units. Press to specify a user-defined string, which consists of up to 3 characters and is shown in the Monitor mode display.
- **F5** (*Decimal PT*): Configure the Decimal Point menu to select either Auto or Range mode for Monitor display.
  - Auto The measured reading fluctuates with the actual condition.
  - Range The measured reading is fixed according to the set range.

## 12.6 1/X Measurement

The Math Equation divides 1 by the reading ( X ).

- **F1 (Function):** Select 1/X equation.
- **F2 (MathDisp):** Show the MathDisp menu with 4 different displays. See the following descriptions for details.

### NOTICE

Only when Alarm configuration is enabled can the "Alarm" and "ALR+STAT" of Math Display be activated.

### 12.6.1 Show STAT Result

The STAT page in MathDisp allows the user to perform statistical calculations for measurements, including Minimum, Maximum, Average, Peak-Peak, Standard Deviation, and Count.

- +0.141745 k Indicates the 1/X calculation.
- Minimum Minimum value.
- Maximum Maximum value.
- Average Average value.
- Peak-Peak Peak to peak value.
- STDEV Standard deviation value.
- Count Latest counts of 1/X.

### 12.6.2 Show Math Result

The Math page in MathDisp allows the user to view mathematical calculations for several parameters.

- +029.8452 Indicates the 1/X calculation.
- Measure Originally measured Voltage value.

### 12.6.3 Show Alarm Result

The Alarm page in MathDisp allows the user to track if measured data exceeds the set High and Low limits.

- Low Limit Set low limit of channel.
- High Limit Set high limit of channel.
- Low Fail Number of low limit exceedances.
- High Fail Number of high limit exceedances.

### **12.6.4 Show ALR+STAT Result**

---

The ALR+STAT page in MathDisp allows the user to view information from both STAT and Alarm pages simultaneously.

- Left Sec. Number of High and Low limit exceedances shown individually.
- Right Sec. Values, based on 1/X calculation, identical to those on the STAT page.

**NOTICE**

Only when Alarm configuration is enabled can the "Alarm" and "ALR+STAT" of Math Display be activated.

---

## 12.7 Percent Measurement

The Math Equation is calculated as:

$$\text{Percent} = \frac{(\text{ReadingX} - \text{Reference}) \times 100\%}{\text{Reference}}$$

- **F1** (*Function*): Select Percent equation.
- **F3** (*REF %*): Set the Reference value. Press the key to enter the menu to configure a Reference value for the Percent equation.
- **F4** (*REF %*): Get Reference value at once. Press the key to instantly perform a reference measurement for the REF % value.
- **F2** (*MathDisp*): Show the MathDisp menu with 4 different displays. See the following descriptions for details.

### NOTICE

Only when Alarm configuration is enabled can the "Alarm" and "ALR+STAT" of Math Display be activated.

### 12.7.1 Show STAT Result

The STAT page in MathDisp allows the user to perform statistical calculations for measurements, including Minimum, Maximum, Average, Peak-Peak, Standard Deviation, and Count.

- -30.2959 Indicates the Percent calculation.
- Minimum Minimum value.
- Maximum Maximum value.
- Average Average value.
- Peak-Peak Peak to peak value.
- STDEV Standard deviation value.
- Count Latest counts of Percent.

### **12.7.2 Show Math Result**

---

The Math page in MathDisp allows the user to view mathematical calculations for several parameters.

- -0.199167 k Indicates the Percent calculation.
- Measure Originally measured Voltage value.
- REF % Defined reference % value.

### **12.7.3 Show Alarm Result**

---

The Alarm page in MathDisp allows the user to track if measured data exceeds the set High and Low limits.

- Low Limit Set low limit of channel.
- High Limit Set high limit of channel.
- Low Fail Number of low limit exceedances.
- High Fail Number of high limit exceedances.

### **12.7.4 Show ALR+STAT Result**

---

The ALR+STAT page in MathDisp allows the user to view information from both STAT and Alarm pages simultaneously.

- Left Sec. The numbers of High and Low limit exceedances are shown individually.
- Right Sec. Values based on Percent measurement, identical to those on the STAT page, are displayed.

**NOTICE**

Only when Alarm configuration is enabled can the "Alarm" and "ALR+STAT" of Math Display be activated.

---

# Average Menu

Press the **Average** key on the front panel to enter the Average menu. The digital average function averages a specified number of input signal samples to generate one reading. The following diagram demonstrates the method of Average using 4 samples per reading.

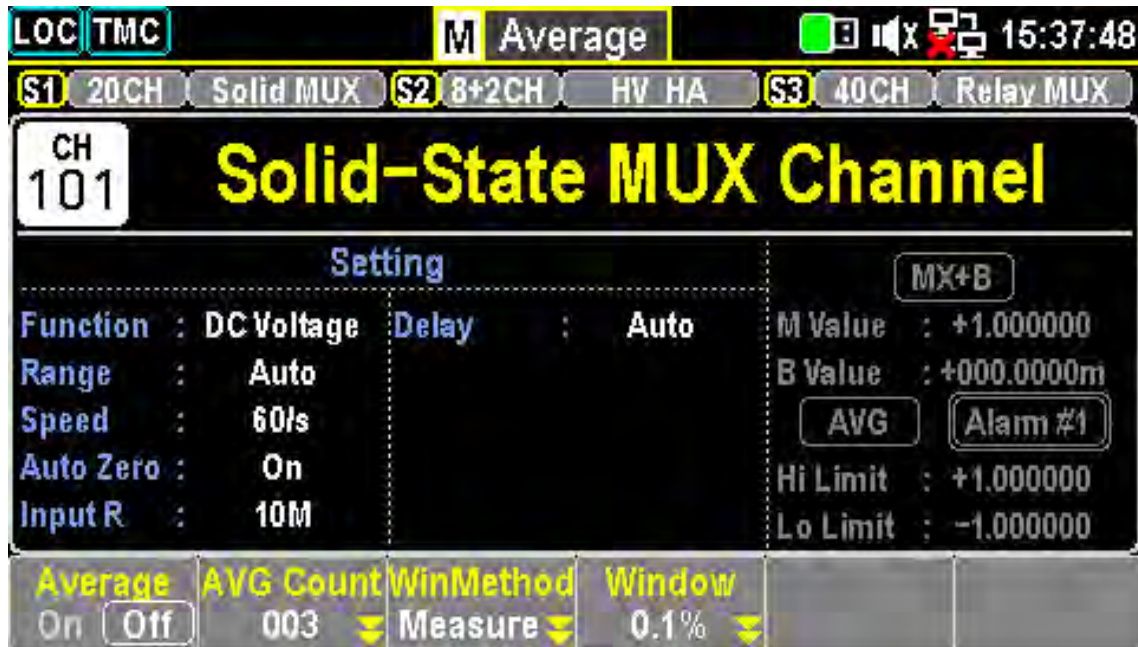

Figure 13.1 Average Menu

### 13.1 Average Process

The digital average renews a whole group of samples per reading. This method is recommended when using the optional scanner.

- **Sample #1:** 1st reading → Sample 1 - 4
- **Sample #2:** 2nd reading → Sample 5 - 8
- **Sample #3:** 3rd reading → Sample 9 - 12

Key Function	Description
F1 (Average)	Press the key to enable or disable the Average function.
F2 (Count)	Press the key to enter the menu to specify the count of average, which defines the number of samples to be averaged per reading.
	<b>More samples:</b> Low noise but longer delay.
	<b>Fewer samples:</b> High noise but shorter delay.
F3 (WinMethod)	Press the key to enter the Average Window Method menu.
	The average window defines the threshold for when the digital average data is updated again.
	<b>Condition 1:</b> When data falls within the range between ( TH ) and ( TL ), the Average keeps processing.
	<b>Condition 2:</b> When data falls outside the range between ( TH ) and ( TL ), the Average restarts.
	<b>Note:</b> Appropriately setting the average window can improve measurement speed for unstable signals.
F4 (Window)	Press the key to specify the Average Window range.
	<b>Measure:</b> $\text{Previous Meas} \times (1 - \text{window}) < \text{threshold} < \text{Previous Meas} \times (1 + \text{window})$
	<b>Range:</b> $\text{Previous Measure} + (\text{Range} \times \text{window}) < \text{threshold} < \text{Previous Measure} + (\text{Range} \times \text{window})$

**Table 13.1** Average Menu

# Log Menu

Press the Log key on the front panel to enter the Log menu, which allows the user to perform the Capture function, capturing a screenshot of a hardcopy, or operate ScanData, which saves a data log of scanned readings onto an installed USB disk.

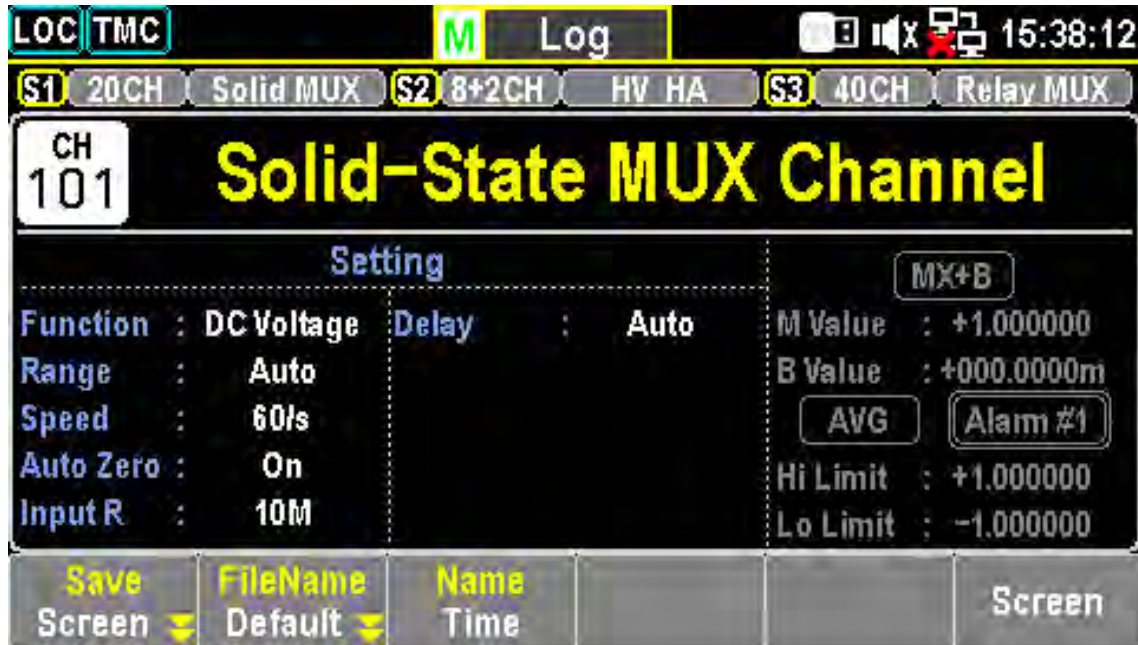

Figure 14.1 Log Menu

Before performing Log functions, ensure the USB disk meets the following requirements:

- **USB Disk Type:** Flash Disk Only.
- **FAT Format:** FAT16 or FAT32 (Recommended).
- **Maximum Memory Size:** 128GB.
- **Not Recommended:** USB disks requiring a card adapter.

**NOTICE**

## 14.1 Capture Function

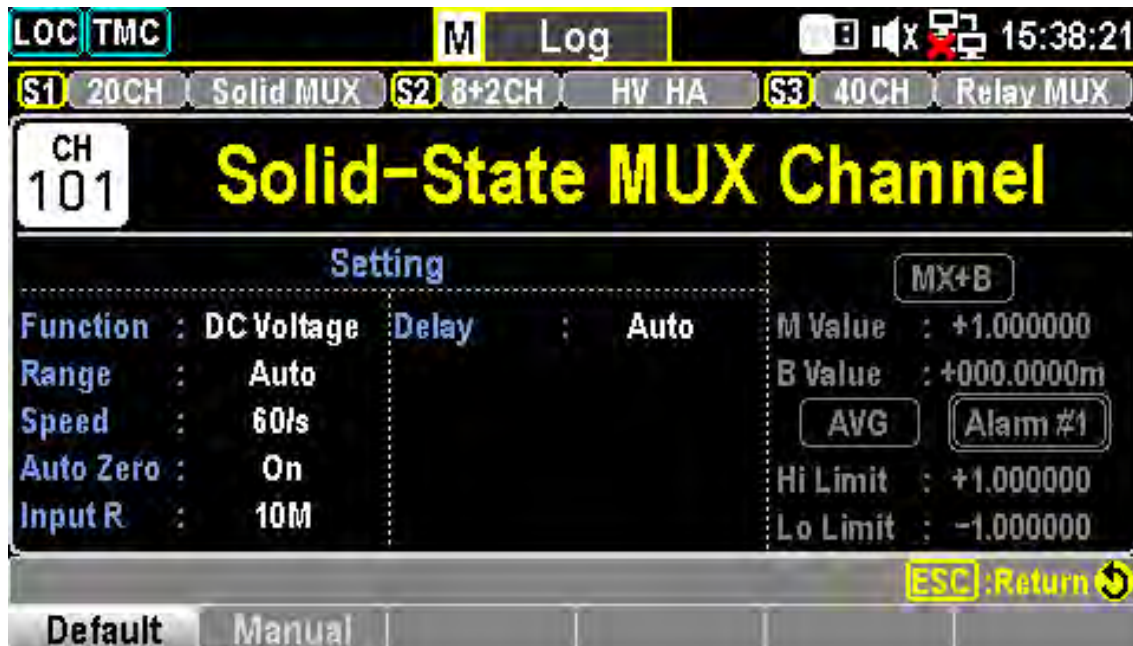

Figure 14.2 Log File Name

- Step 1.** Press the **Log PARA (F1)** key to select Capture.
- Step 2.** Press the **FileName (F2)** key to determine the filename of captured screenshots. The “Default” option keeps the filename in date & time format (e.g., SCREEN\_20220909 13-20-25).
- Step 3.** If selecting the “Manual” option, press the **EditName (F3)** key to enter the keyboard page and edit a user-defined filename.
- Step 4.** Press the **Capture (F4)** key to perform screenshot capturing. A prompt message appears upon completion.

## 14.2 Scan Data Function

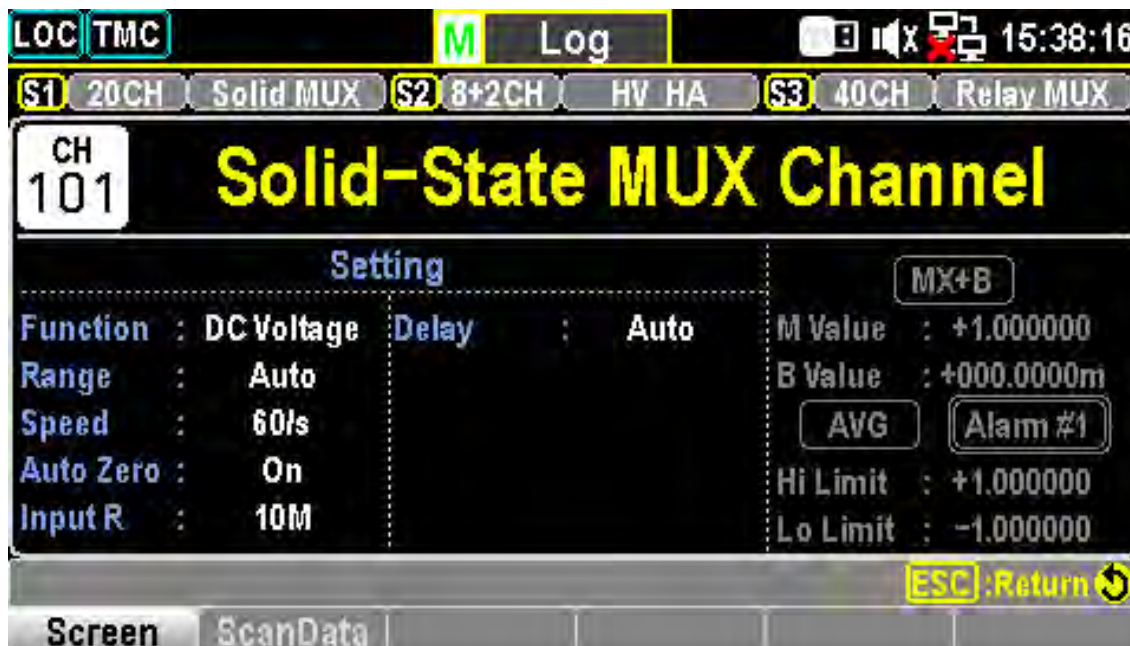

Figure 14.3 Log Scan Data

- Step 1.** Press the **Log PARA (F1)** key to select ScanData.
- Step 2.** Press the **Logging (F2)** key to enable auto-saving of scanned readings to the inserted USB disk. Selecting “Off” disables automatic saving, requiring manual operation to save data.
  - If auto-Logging is enabled, the Home screen will display **Log to USB: On**. See page 34 for Home screen details.
- Step 3.** Press the **# Rows (F3)** key to specify the row limit for each data logging file:
  - **65k:** Limits to 65,536 rows per file.
  - **1M:** Limits to 1,048,576 rows per file.
  - **Infinite:** Limit varies based on the number of bytes permitted by the file system.
- Step 4.** Press the **Separation (F4)** key to choose a separation symbol (Comma, Semicolon, or TAB) for delimiting readings in the exported scanned data.
- Step 5.** Press the **SaveRead (F6)** key to manually save scanned readings to the installed USB disk.

# Digital I/O Overview

The Digital I/O port contains:

- **1 pin** for External Trigger Input.
- **4 pins** for Alarm Output.

When an external trigger pulse is received by the external trigger input pin, the designated channel will be triggered accordingly. The 4 alarm output pins can be assigned to any of the input channels to:

- Trigger an external LED light.
- Control a relay.
- Send a TTL-compatible pulse to a control system.

## 15.1 Pin Assignment

- **Connector Type:** DB-9 female.

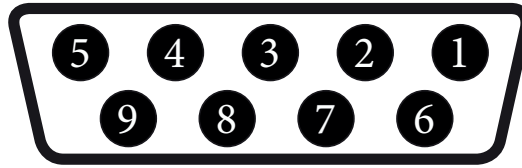

**Figure 15.1** DB-9 Female

Pin No	Pin Definition	Description
1	Alarm_OUT1	TTL-compatible pin. Selectable for TTL logic Hi or Lo alarm outputs.
2	Alarm_OUT2	TTL-compatible pin. Selectable for TTL logic Hi or Lo alarm outputs.
3	Alarm_OUT3	TTL-compatible pin. Selectable for TTL logic Hi or Lo alarm outputs.
4	Alarm_OUT4	TTL-compatible pin. Selectable for TTL logic Hi or Lo alarm outputs.
5	EOM (End of Measurement) Out	Activates when a compare measurement is completed. Also available in other measurements.
6	External Trigger In	Accepts external trigger signals. Used for external signal triggering.
7	Digital Ground	Chassis ground for digital circuits.
8	NC (Not Connected)	
9	NC (Not Connected)	

**Table 15.1** Pin Assignment

## 15.2 Application: Alarm Output

The alarm output pins of the Digital I/O port, located on the rear panel, send a TTL-compatible alarm output that can trigger external alarm devices such as sirens and LED lights. Any of the four alarm output pins can be assigned to any of the input channels to:

- Trigger external devices.
- Send a TTL-compatible pulse to a control system.

### 15.2.1 Alarm Output Connection

Connect external alarm output devices to the designated pins of the Digital I/O port on the rear panel.

Pin No	Function
1-4	Alarm Output Pins

**Table 15.2** Alarm Output Pins

### 15.2.2 Activate Alarm Output

- Press the **Alarm** key on the front panel to enter the Alarm menu.
- Use the knob to navigate channels and select a target channel (e.g., channel 101).

#### 15.2.2.1 Alarm Limit Modes

Mode	Description
OFF	Alarm condition is disabled for the selected channel.
High+Low	Both High and Low limits of the alarm condition are activated.
High	Only the High limit is activated.
Low	Only the Low limit is activated.

**Table 15.3** Alarm Limit Modes

#### 15.2.2.2 Alarm Settings

- Press the **Output (F2)** key to select which of the 4 alarm output lines will be used.
- Press the **Low Limit (F5)** and **High Limit (F6)** keys to specify alarm limits for the selected channel.
- Press the **Scan** key on the front panel to start a scan. If the set alarm is triggered during scanning, the alarm status will be displayed.

## 15.3 Application: External Trigger

The external trigger uses a digital I/O pin for manual triggering of the DAQ3120. A pulse of at least 10 $\mu$ s is required to trigger the system.

### 15.3.1 Signal Connection

Connect the external trigger signal to the specified pin on the Digital I/O port.

Pin No	Function
6	External Trigger Input

**Table 15.4** External Trigger Pin

### 15.3.2 Activate External Trigger

- Press the **Interval** key on the front panel to enter the Interval menu.
- Press the **TrigSource (F1)** key to access the trigger source menu.
- Press the **External (F4)** key to select External Trigger mode.
- During a scan, each sweep starts only when an external trigger signal is received.
- The next sweep waits until an external signal is received.

# System and Firmware Menu

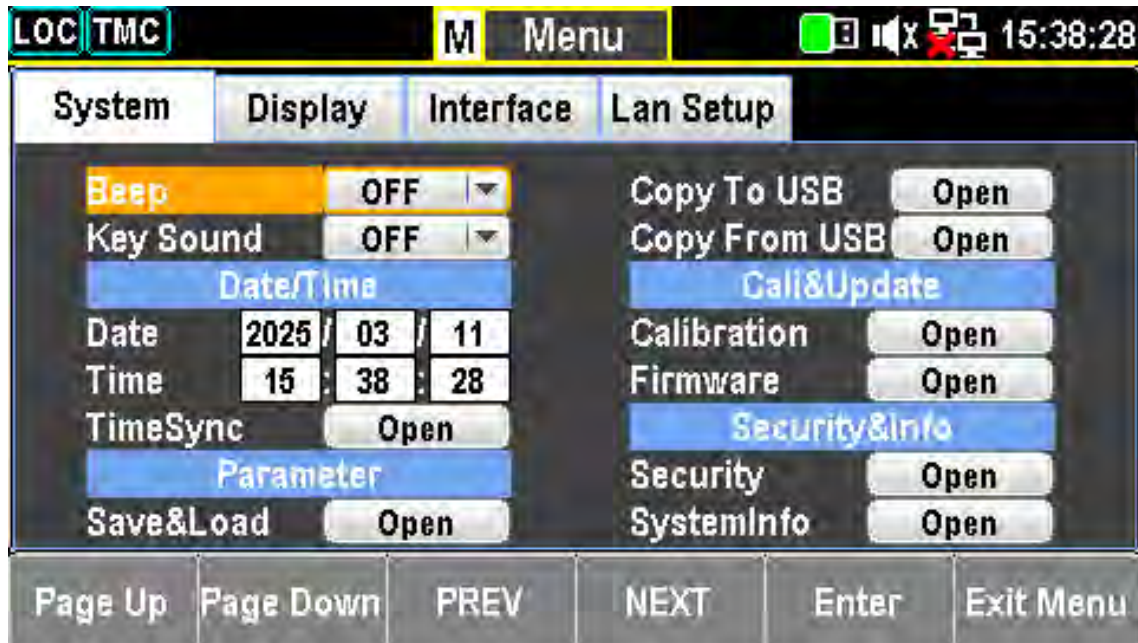

Figure 16.1 System Menu

## 16.1 View System Info

View system information, including:

- Vendor
- Model Name
- Serial Number
- Master Firmware
- Slave Firmware

**Step 1.** Press the **Menu** key to access the System Configuration menu.

**Step 2.** Press the **NEXT** key repeatedly or scroll the **Knob** key to navigate to the **Security&Info – SystemInfo** field.

**Step 3.** Press the **F5 (Enter)** key or **Knob** key to enter the System Information screen, where all critical information is displayed.

## **16.2 Firmware Update**

---

This section describes how to update the firmware to the latest version.

**Step 1.** Press the **Menu** key to open the System Configuration menu.

**Step 2.** Press the **NEXT** key repeatedly or scroll the **Knob** key to navigate to the **Cali&Update – Firmware** field.

**Step 3.** Press the **F5 (Enter)** key or **Knob** key to enter the Firmware Update menu.

### **16.2.1 Update Process**

---

Before starting the update:

- Ensure the required firmware file is stored on a flash drive inserted into the USB port on the front panel.
- Check the current Master and Slave firmware versions in the Firmware Update menu.

#### **16.2.1.1 Firmware File Naming**

---

Before updating, rename the downloaded firmware files as follows:

- **Master file:** M\_IMAGE.bin
- **Slave file:** S\_IMAGE.bin

#### **16.2.1.2 Firmware Update Steps**

---

**Step 1.** Press the **F5 (Enter)** key or **Knob** key to display the qualified firmware version.

#### **NOTICE**

If the flash drive does not contain update files, an error message will appear.

---

**Step 2.** Press the **NEXT** key or scroll the **Knob** key to navigate to the **Update** option.

**Step 3.** Press the **F5 (Enter)** key or **Knob** key to start the update process.

# Menu Settings

17.1	Configure System	132
17.1.1	Beep Setting	132
17.1.2	Key Sound Setting	132
17.1.3	Date Setting	132
17.1.4	Time Setting	132
17.1.5	TimeSync Setting	133
17.1.5.1	Options	133
17.1.6	Save and Load Parameters	133
17.1.7	Copy Parameters To/From USB	133
17.1.8	Steps to Copy from USB	134
17.1.9	Calibration Setting	134
17.1.9.1	Frequency Calibration	134
17.1.9.2	DC Gain Calibration	134
17.1.10	Firmware Update	134
17.1.11	Security Settings	135
17.1.11.1	Options	135
17.1.12	View System Info	135
17.2	Display Settings	135
17.2.1	Brightness and Auto-Off Settings	135
17.2.2	Color and Theme Settings	135
17.2.3	Language Setting	135

## 17.1 Configure System

### 17.1.1 Beep Setting

Enable or disable beep sound.

**Step 1.** Press the MENU key, the system configuration menu appears.

**Step 2.** Press the F5 (ENTER) key or KNOB key, then scroll the KNOB key or press +/- keys to select the ON option.

**Step 3.** Press the F5 (ENTER) key or KNOB key to confirm selection.

### 17.1.2 Key Sound Setting

Enable or disable key sound.

**Step 1.** Press the MENU key, the system configuration menu appears. Press the NEXT key repeatedly or scroll the KNOB key to move to the KEY SOUND field.

**Step 2.** Press the F5 (ENTER) key or KNOB key, then scroll the KNOB key or press +/- keys to select the ON option.

**Step 3.** Press the F5 (ENTER) key or KNOB key to confirm selection.

### 17.1.3 Date Setting

Manually adjust the system date or set automatically via TIMESYNC.

**Step 1.** Press the MENU key, the system configuration menu appears. Press the NEXT key repeatedly or scroll the KNOB key to move to the DATE/TIME - DATE field.

**Step 2.** Use the LEFT/RIGHT keys to move the cursor, then scroll the KNOB key or press +/- keys to set the year. Alternatively, use the NUMBER keys to input a specific digit.

**Step 3.** Press the F5 (ENTER) key or KNOB key to confirm the year.

**Step 4.** Repeat steps 2 and 3 for month and day.

### 17.1.4 Time Setting

Manually adjust the system time or set automatically via TIMESYNC.

- Step 1.** Press the MENU key, the system configuration menu appears. Press the NEXT key repeatedly or scroll the KNOB key to move to the DATE/TIME - TIME field.
- Step 2.** Use the LEFT/RIGHT keys to move the cursor, then scroll the KNOB key or press +/- keys to set the hour. Alternatively, use the NUMBER keys to input a specific digit.
- Step 3.** Press the F5 (ENTER) key or KNOB key to confirm the hour.
- Step 4.** Repeat steps 2 and 3 for minute and second.

### 17.1.5 TimeSync Setting

TIMESYNC is available when connected to the internet with proper network settings.

- Step 1.** Press the MENU key, the system configuration menu appears. Press the NEXT key repeatedly or scroll the KNOB key to move to the DATE/TIME - TIMESYNC field.
- Step 2.** Press the F5 (ENTER) key or KNOB key to enter the INTERNET TIME SYNC menu.

#### 17.1.5.1 Options

- SYNCHRONIZE ENABLE: Enable or disable time synchronization.
- SYNCHRONIZE SERVER: Select a remote time server (e.g., `time.nist.gov` or `time-nw.nist.gov`).
- SYNCHRONIZE NOW: Retrieve the current standard time from the remote server.
- SYNCHRONIZE TIME: Define the synchronization interval (7 DAYS, 14 DAYS, 30 DAYS).
- SET TIME ZONE: Adjust UTC offset (hour/minute).
- LAST UPDATE TIME: Displays the last synchronization timestamp.

### 17.1.6 Save and Load Parameters

Save and recall instrument settings, including state, function, I/O, and range settings.

- Step 1.** Press the MENU key, then use the NEXT key or KNOB key to move to PARAMETER – SAVE&LOAD.
- Step 2.** Press the F5 (ENTER) key or KNOB key to enter the SAVE&LOAD menu.

### 17.1.7 Copy Parameters To/From USB

Copy or recall saved settings via a connected USB drive.

- Step 1.** Navigate to the COPY TO USB field.
- Step 2.** Press the F5 (ENTER) key to bring up the KEYBOARD page.
- Step 3.** Input a file name and press F4 (OK) to save to USB.

### **17.1.8 Steps to Copy from USB**

- Step 1.** Navigate to the COPY FROM USB field.
- Step 2.** Press the F5 (ENTER) key to open the file selection menu.
- Step 3.** Select the desired file and confirm loading.

### **17.1.9 Calibration Setting**

Calibration functions for frequency, DC gain, and DMM. Only certified technicians should perform calibrations.

#### **17.1.9.1 Frequency Calibration**

- Enable or disable frequency compensation.
- Adjust compensation values.

#### **17.1.9.2 DC Gain Calibration**

- Execute DC GAIN CALIBRATION via the START button.

#### **17.1.10 Firmware Update**

Update firmware using a flash drive.

- Step 1.** Insert a USB drive with the firmware file.
- Step 2.** Navigate to FIRMWARE UPDATE.
- Step 3.** Confirm update.

### **17.1.11 Security Settings**

Change password and enable or disable LAN password protection.

#### **17.1.11.1 Options**

- Enable/Disable LAN PASSWORD.
- Change password.

### **17.1.12 View System Info**

1. Navigate to SYSTEM INFO to view details such as vendor, model, serial number, and firmware version.

## **17.2 Display Settings**

### **1 Brightness and Auto-Off Settings**

Adjust display brightness, enable auto-off, and set time for dimming.

### **2 Color and Theme Settings**

Customize MATH and 1ST display colors.

### **3 Language Setting**

Select user interface language.

- ENGLISH
- (Traditional Chinese)
- (Simplified Chinese)

# Remote Interface

18.1	Configure Interface .....	137
18.1.1	Return to Local Control Mode .....	137
18.1.2	Configure SCPI ID Setting .....	137
18.2	Configure USB Interface .....	138
18.2.1	Set the USB Protocol .....	138
18.3	Configure GPIB Interface .....	139
18.4	Activate Ethernet Interface .....	140
18.5	Web Control Interface .....	141

## 18.1 Configure Interface

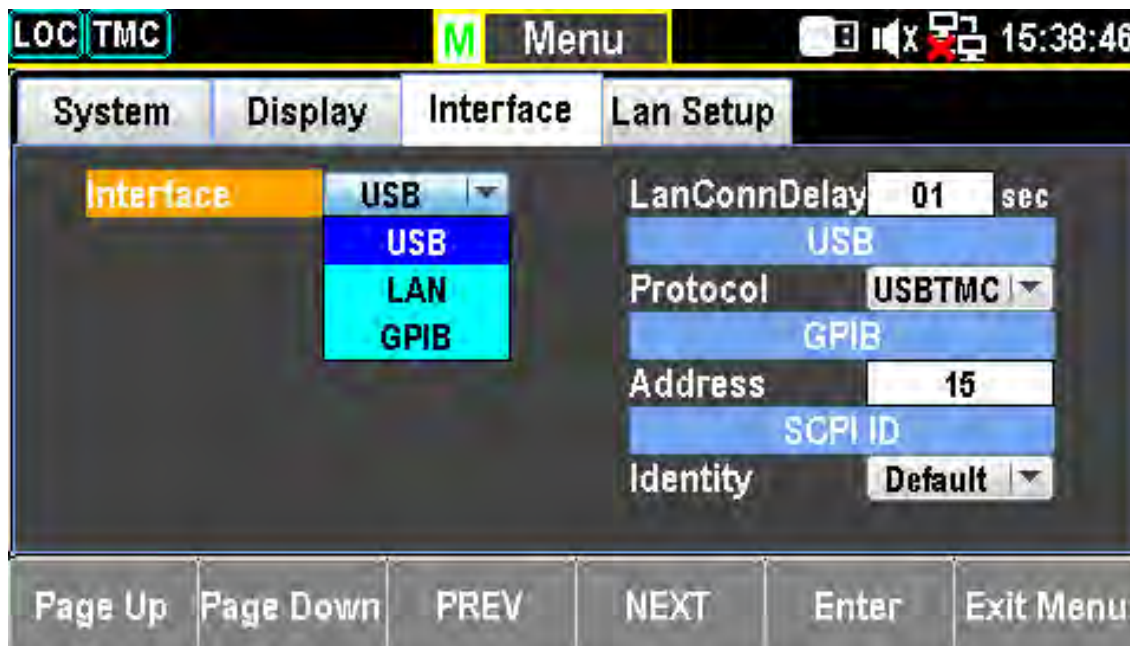

Figure 18.1 Interface Menu

### 18.1.1 Return to Local Control Mode

When the unit is in remote control mode, the RMT icon above the main display can be seen. When this icon is not displayed, it indicates that the unit is in local control mode. To switch back to Local control mode (front panel operation), press the SHIFT key.

### 18.1.2 Configure SCPI ID Setting

The \*IDN? query returns the manufacturer, model number, serial number, and system firmware version number. When SCPI ID is set to USER, a user-defined manufacturer and model number is returned with the \*IDN? query. Please see the SYSTem:IDNStx command on page 330 for details.

- Step 1.** Press the MENU key, and then the PAGE DOWN key repeatedly until the INTERFACE CONFIGURATION menu appears.
- Step 2.** Press the F4 (NEXT) key repeatedly or scroll the KNOB key to move to the SCPI ID field.
- Step 3.** Press the F5 (ENTER) key or KNOB key followed by scrolling KNOB key or pressing +/- keys to land on the desired SCPI ID IDENTITY option.
- Step 4.** Press the F5 (ENTER) key or KNOB key again to confirm the desired SCPI ID IDENTITY option.

## 18.2 Configure USB Interface

Description	Specification
PC Side Connector	Front panel, Type A, host
Unit Side Connector	Rear panel, Type B, device
USB Speed	2.0 (Full speed)

**Table 18.1** PC Connector

- Step 1.** Press the MENU key, and then the PAGE DOWN key repeatedly until the INTERFACE CONFIGURATION menu appears.
- Step 2.** Press the F5 (ENTER) key or KNOB key followed by scrolling KNOB key or pressing +/- keys to land on the USB option.
- Step 3.** Press the F5 (ENTER) key or KNOB key to select the USB option.
- Step 4.** Press the F4 (NEXT) key repeatedly or scroll the KNOB key to move to the USB - PROTOCOL field.
- Step 5.** Press the F5 (ENTER) key or KNOB key followed by scrolling KNOB key or pressing +/- keys to land on the desired USB PROTOCOL option.
- Step 6.** Press the F5 (ENTER) key or KNOB key again to confirm the USB PROTOCOL option.
- Step 7.** Connect the USB cable to the rear panel terminal (upper port).

### 18.2.1 Set the USB Protocol

The USB device port on the rear panel is used for remote control. The USB port can be configured as either a TMC or CDC interface.

Before the DAQ3120 can be used for remote control utilizing the CDC or TMC USB class, install the appropriate CDC or TMC USB driver included on the USER MANUAL CD.

- USBCDC: The USB port on the DAQ3120 will appear as a virtual COM port to a connected PC.
- USBTMC: The DAQ3120 can be controlled using National Instruments NI-VISA software.

## 18.3 Configure GPIB Interface

Description	Specification
Connector	24 Pin female GPIB port
Address	0-30 (default 15)

**Table 18.2** GPIB Interface

- Step 1.** Press the MENU key, and then the PAGE DOWN key repeatedly until the INTERFACE CONFIGURATION menu appears.
- Step 2.** Press the F5 (ENTER) key or KNOB key followed by scrolling KNOB key or pressing +/- keys to land on the GPIB option.
- Step 3.** Press the F5 (ENTER) key or KNOB key to select the GPIB option.
- Step 4.** Press the F4 (NEXT) key repeatedly or scroll the KNOB key to move to the GPIB - ADDRESS field.
- Step 5.** Use the LEFT/RIGHT keys to move the cursor followed by scrolling KNOB key or pressing +/- keys to define GPIB ADDRESS. Alternatively, press NUMBER keys to directly input a specific digit.
- Step 6.** Press the F5 (ENTER) key or KNOB key again to confirm the input digit for GPIB ADDRESS.
- Step 7.** Connect the GPIB cable to the mini GPIB port on the rear panel of DAQ3120.

## 18.4 Activate Ethernet Interface

Description	Specification
Speed	10BaseT/100BaseTx

**Table 18.3** Ethernet Interface

- Step 1.** Press the MENU key, and then the PAGE DOWN key repeatedly until the INTERFACE CONFIGURATION menu appears.
- Step 2.** Press the F5 (ENTER) key or KNOB key followed by scrolling KNOB key or pressing +/- keys to land on the LAN option.
- Step 3.** Press the F5 (ENTER) key or KNOB key to select the LAN option.
- Step 4.** Connect the Ethernet cable to the rear panel Ethernet port.

---

## 18.5 Web Control Interface

---

The web control interface allows remote access over LAN using a Java-enabled web browser. Before accessing the web browser control interface, ensure JavaScript is enabled.

**Step 1.** Configure the LAN interface and connect the DAQ3120 to the network.

**Step 2.** Enter the IP address of the DAQ3120 in the web browser address field.

**Step 3.** The WEB CONTROL WELCOME PAGE appears.

**Step 4.** Click on the WEB CONTROL icon to begin remote operation.

# Specifications

Note: All specifications apply to the unit after a temperature stabilization time of 1 hour over an ambient temperature range of 23 °C ± 5 °C. Increment of one coefficient per one degree Celsius when the range is beyond TCAL ± 5 °C. Accuracy Specifications: ± (% of reading + % of range)

DC Characteristics <sup>(1)</sup>						
<b>DC Voltage</b>						
Input Protection	600 V on all ranges					
Input Bias	< 30 pA (Typical, 25 °C)					
Measure Method	Sigma-delta A/D Converter					
Range <sup>(2)</sup>	Input Resistance	24 Hour TCAL ± 1 °C	90 Day TCAL ± 5 °C	1 Year TCAL ± 5 °C	Temperature Coefficient/°C	
100.0000 mV	10 MΩ or Auto (> 10 GΩ)	0.0030 + 0.0050	0.0040 + 0.0060	0.0050 + 0.0060	0.0005 + 0.0005	
1.000000 V		0.0020 + 0.0006	0.0035 + 0.0007	0.0048 + 0.0007	0.0005 + 0.0001	
10.00000 V		0.0015 + 0.0004	0.0020 + 0.0005	0.0035 + 0.0005	0.0005 + 0.0001	
100.0000 V	10 MΩ ± 1%	0.0020 + 0.0006	0.0035 + 0.0006	0.0050 + 0.0006	0.0005 + 0.0001	
600.000 V		0.0025 + 0.0020	0.0040 + 0.0020	0.0050 + 0.0020	0.0005 + 0.0001	
<b>Resistance <sup>(3)</sup></b>						
Input Protection	600 V on all ranges					
Max lead Resistance	10% of range per lead for 100 Ω, 1 kΩ ranges. 1 kΩ per lead on all other ranges					
Measure Method	Selectable 4-wire or 2-wire					
Range <sup>(2)</sup>	Test Current	24 Hour TCAL ± 1 °C	90 Day TCAL ± 5 °C	1 Year TCAL ± 5 °C	Temperature Coefficient/°C	
100.0000 Ω	1 mA	0.003 + 0.0030	0.008 + 0.004	0.010 + 0.004	0.0008 + 0.0005	
1.000000 kΩ	1 mA	0.002 + 0.0005	0.008 + 0.001	0.010 + 0.001	0.0008 + 0.0001	
10.00000 kΩ	100 μA	0.002 + 0.0005	0.008 + 0.001	0.010 + 0.001	0.0008 + 0.0001	
100.0000 kΩ	10 μA	0.002 + 0.0005	0.008 + 0.001	0.010 + 0.001	0.0008 + 0.0001	
1.000000 MΩ	5 μA	0.002 + 0.0010	0.008 + 0.001	0.010 + 0.001	0.0010 + 0.0002	
10.00000 MΩ	500 nA	0.015 + 0.0010	0.020 + 0.001	0.040 + 0.001	0.0030 + 0.0004	
100.0000 MΩ	500 nA    10 MΩ	0.300 + 0.0100	0.800 + 0.010	0.800 + 0.001	0.1500 + 0.0004	
1.000000 GΩ	500 nA    10 MΩ	2.50 + 0.0500	3.50 + 0.0500	3.50 + 0.0500	1.0000 + 0.0040	
<b>DC Current</b>						
Input Protection	Internal, 250 V fuse for 2 A					
Range <sup>(2)</sup>	Burden Voltage	Shunt	24 Hour TCAL ± 1 °C	90 Day TCAL ± 5 °C	1 Year TCAL ± 5 °C	Temperature Coefficient/°C
<b>Characteristics – typical: DC current</b>						
1.000000 μA	< 0.015 V	10 kΩ	0.025 + 0.050	0.050 + 0.050	0.050 + 0.050	0.002 + 0.003
10.00000 μA	< 0.15 V	10 kΩ	0.020 + 0.010	0.040 + 0.025	0.050 + 0.025	0.002 + 0.003
100.0000 μA	< 0.020 V	100 Ω	0.010 + 0.020	0.040 + 0.025	0.050 + 0.025	0.002 + 0.003
<b>Specification: DC current</b>						
1.000000 mA	< 0.20 V	100 Ω	0.007 + 0.006	0.030 + 0.006	0.050 + 0.006	0.002 + 0.001
10.00000 mA	< 0.15 V	10 Ω	0.007 + 0.020	0.030 + 0.020	0.050 + 0.020	0.002 + 0.001
100.0000 mA	< 0.7 V	1 Ω	0.010 + 0.004	0.030 + 0.005	0.050 + 0.005	0.002 + 0.002
2.000000 A	< 0.8 V	0.1 Ω	0.180 + 0.020	0.200 + 0.020	0.200 + 0.020	0.005 + 0.001
<b>Diode Test <sup>(4)</sup></b>						
Range <sup>(2)</sup>	24 Hour TCAL ± 1 °C	90 Day TCAL ± 5 °C	1 Year TCAL ± 5 °C	Temperature Coefficient/°C		
5 V	0.002 + 0.030	0.008 + 0.030	0.01 + 0.03	0.001 + 0.002		
<b>Reading Rates</b>						
Measurement	Speed (readings per second)				Digits	
DCV DCI 2W/4W Resistance	5 readings/s, 20 readings/s, 60 readings/s, 100 readings/s				6 ½	
	400 readings/s, 1200 readings/s, 2400 readings/s				5 ½	
	4800 readings/s, 7500 readings/s, 14400 readings/s, 19200 readings/s, 38400 readings/s				4 ½	
Diode	400 readings/s				6 ½	

(1) DC Specification: In addition to the warm-up time, measurement settings must be set at 5 /s speed and A-Zero

(2) The range of measurement exceeds the set range by 20% except in 600 V DC, 2 A DC, and diode

(3) These specifications apply to 4-wire Ω function or 2-wire Ω using math null for offset. Without math null, add an additional 2 Ω error. 100 MΩ and 1 GΩ ranges are only available in 2-wire

(4) This applies to the voltage measured from the input terminal. 1 mA test current is the typical value. A change of current source leads to variation in the buck of diode junction

Specifications (cont.)

AC Characteristics <sup>(5)</sup>								
True RMS AC Voltage <sup>(6)</sup> <sup>(7)</sup> <sup>(8)</sup>								
Measurement Method	AC-coupled True RMS – measures the AC component of input with up to 400 Vdc of bias on any range							
Crest factor	Maximum 5:1 at full scale							
Frequency	24 Hour TCAL ± 1 °C		90 Day TCAL ± 5 °C		1 Year TCAL ± 5 °C		Temperature Coefficient/°C	
	100 mV	1 V to 400 V	100 mV	1 V to 400 V	100 mV	1 V to 400 V	100 mV	1 V to 400 V
3 Hz to 5 Hz	1.00 + 0.03	1.00 + 0.02	1.00 + 0.04	1.00 + 0.03	1.00 + 0.04	1.00 + 0.03	0.100 + 0.004	0.100 + 0.004
5 Hz to 10 Hz	0.35 + 0.03	0.35 + 0.02	0.35 + 0.04	0.35 + 0.03	0.35 + 0.04	0.35 + 0.03	0.035 + 0.004	0.035 + 0.004
10 Hz to 20 kHz	0.04 + 0.03	0.04 + 0.02	0.05 + 0.04	0.05 + 0.03	0.06 + 0.04	0.06 + 0.03	0.005 + 0.003	0.005 + 0.003
20 kHz to 50 kHz	0.10 + 0.05	0.10 + 0.04	0.11 + 0.05	0.11 + 0.05	0.12 + 0.05	0.12 + 0.05	0.011 + 0.005	0.011 + 0.005
50 kHz to 100 kHz	0.55 + 0.08	0.55 + 0.08	0.60 + 0.08	0.60 + 0.08	0.60 + 0.08	0.60 + 0.08	0.060 + 0.008	0.060 + 0.008
100 kHz to 300 kHz	4.00 + 0.50	4.00 + 0.50	4.00 + 0.50	4.00 + 0.50	4.00 + 0.50	4.00 + 0.50	0.200 + 0.020	0.200 + 0.020
True RMS AC Current <sup>(6)</sup> <sup>(8)</sup> <sup>(9)</sup>								
Input Protection			Internal, 250 V fuse for 2 A					
Range <sup>(6)</sup>	Burden Voltage	Shunt	Frequency	24 Hour TCAL ± 1 °C	90 Day TCAL ± 5 °C	1 Year TCAL ± 5 °C	Temperature Coefficient/°C	
100 μA	< 0.020 V	100 Ω	3 Hz to 5 Hz	1.00 + 0.04	1.00 + 0.06	1.00 + 0.06	0.100 + 0.006	
			5 Hz to 10 Hz	0.35 + 0.04	0.35 + 0.06	0.35 + 0.06	0.035 + 0.006	
			10 Hz to 5 kHz	0.10 + 0.04	0.10 + 0.06	0.10 + 0.06	0.015 + 0.006	
			5 kHz to 10 kHz	0.18 + 0.04	0.18 + 0.10	0.18 + 0.10	0.035 + 0.006	
1 mA	< 0.20 V	100 Ω	3 Hz to 5 Hz	1.00 + 0.04	1.00 + 0.04	1.00 + 0.04	0.100 + 0.006	
			5 Hz to 10 Hz	0.30 + 0.04	0.30 + 0.04	0.30 + 0.04	0.035 + 0.006	
			10 Hz to 5 kHz	0.10 + 0.04	0.10 + 0.04	0.10 + 0.04	0.015 + 0.006	
			5 kHz to 10 kHz	0.15 + 0.04	0.15 + 0.04	0.15 + 0.04	0.030 + 0.006	
10 mA	< 0.15 V	10 Ω	3 Hz to 5 Hz	1.00 + 0.04	1.00 + 0.04	1.00 + 0.04	0.100 + 0.006	
			5 Hz to 10 Hz	0.35 + 0.04	0.35 + 0.04	0.35 + 0.04	0.035 + 0.006	
			10 Hz to 5 kHz	0.10 + 0.04	0.10 + 0.04	0.10 + 0.04	0.015 + 0.006	
			5 kHz to 10 kHz	0.18 + 0.04	0.18 + 0.04	0.18 + 0.04	0.030 + 0.006	
100 mA	< 0.7 V	1 Ω	3 Hz to 5 Hz	1.00 + 0.04	1.00 + 0.04	1.00 + 0.04	0.100 + 0.006	
			5 Hz to 10 Hz	0.30 + 0.04	0.30 + 0.04	0.30 + 0.04	0.035 + 0.006	
			10 Hz to 5 kHz	0.10 + 0.04	0.10 + 0.04	0.10 + 0.04	0.015 + 0.006	
			5 kHz to 10 kHz	0.15 + 0.04	0.15 + 0.04	0.15 + 0.04	0.030 + 0.006	
2 A	< 0.8 V	0.1 Ω	3 Hz to 5 Hz	1.00 + 0.04	1.00 + 0.04	1.00 + 0.04	0.100 + 0.006	
			5 Hz to 10 Hz	0.35 + 0.04	0.35 + 0.04	0.35 + 0.04	0.035 + 0.006	
			10 Hz to 5 kHz	0.23 + 0.04	0.23 + 0.04	0.23 + 0.04	0.015 + 0.006	
			5 kHz to 10 kHz	0.23 + 0.04	0.23 + 0.04	0.23 + 0.04	0.030 + 0.006	
AC Bandwidth								
Input Impedance	1 MΩ ± 2%, in parallel with 100 pF							
Input Protection	400 Vrms on all ranges							
Speed	Bandwidth (ACV)			Bandwidth (ACI)			Digits	
1/s (> 3 Hz)	3 Hz to 300 kHz			3 Hz to 10 kHz			6 ½	
5/s (> 20 Hz)	20 Hz to 300 kHz			20 Hz to 10 kHz			5 ½	
20/s (> 200 Hz)	200 Hz to 300 kHz			200 Hz to 10 kHz			4 ½	

(5) AC Specification: Specified after 60 minutes of warm-up time on a sine wave  
 (6) The range of measurements exceeds the set range by 20% except in 400 V AC and 2 A AC  
 (7) Specifications are for sine wave input > 5% of range. For 1% to 5% of range and < 50 kHz, add 0.1% of range additional error. For 50 kHz to 100 kHz, add 0.13% of range. The measurement range of 400 VAC is limited within the range of 7.5 x 10<sup>-7</sup> Volt-Hz  
 (8) Three speed settings provided for low-frequency performance: 1/s (3 Hz), 5/s (20 Hz), 20/s (200 Hz). No errors for frequencies greater than the filter settings  
 (9) Specifications are for sine wave input > 5% of range, and is beyond 10 μA AC. For inputs from 1% to 5% of range, add 0.1% of range additional error

**Specifications (cont.)**

Crest Factor Errors (non-sine wave)	
Crest Factor	Error (% of reading)
1 to 2	0.05%
2 to 3	0.15%
3 to 4	0.30%
4 to 5	0.40%

Low Frequency Errors (% of reading)			
Frequency	1/s (> 3 Hz)	5/s (> 20 Hz)	20/s (> 200 Hz)
10 Hz to 20 Hz	0	0.74	-
20 Hz to 40 Hz	0	0.22	-
40 Hz to 100 Hz	0	0.06	0.73
100 Hz to 200 Hz	0	0.01	0.22
200 Hz to 1 kHz	0	0	0.18
> 1 kHz	0	0	0

**Frequency and Period Characteristics**

Frequency / Period <sup>(10)</sup> <sup>(11)</sup>					
Range	Frequency	24 Hour TCAL ± 1 °C	90 Day TCAL ± 5 °C	1 Year TCAL ± 5 °C	Temperature Coefficient/°C
100 mV to 400 V <sup>(12)</sup>	3 Hz to 5 Hz	0.100	0.100	0.100	0.100
	5 Hz to 10 Hz	0.050	0.050	0.050	0.035
	10 Hz to 40 Hz	0.030	0.030	0.030	0.015
	40 Hz to 1 MHz <sup>(13)</sup>	0.006	0.006	0.006	0.015
Function		Gate Time		Digits	
Frequency, Period		1 s, 100 ms		6 ½	
		10 ms		5 ½	
		1 ms		4 ½	

**Temperature Characteristics <sup>(14)</sup>**

RTD (Accuracy based on Pt100)				
Range	Resolution	1 Year (23°C ± 5°C)	Temperature Coefficient 0° to 18°C and 28° to 55°C	
-200 °C to -100 °C	0.001 °C	0.09 °C	0.004 °C / °C	
-100 °C to -20 °C	0.001 °C	0.08 °C	0.005 °C / °C	
-20 °C to 20 °C	0.001 °C	0.06 °C	0.005 °C / °C	
20 °C to 100 °C	0.001 °C	0.08 °C	0.005 °C / °C	
100 °C to 300 °C	0.001 °C	0.12 °C	0.007 °C / °C	
300 °C to 600 °C	0.001 °C	0.22 °C	0.009 °C / °C	

Thermocouples (Accuracy based on ITS-90)				
Range	Range	Frequency	90 Day/1 Year (23°C ± 5°C)	Temperature Coefficient 0° to 18°C and 28° to 55°C
E	-200 °C to 1000 °C	0.002 °C	0.2 °C	0.03 °C / °C
J	-210 °C to 1200 °C	0.002 °C	0.2 °C	0.03 °C / °C
T	-200 °C to 400 °C	0.002 °C	0.3 °C	0.04 °C / °C
K	-200 °C to 1372 °C	0.002 °C	0.3 °C	0.04 °C / °C
N	-200 °C to 1300 °C	0.003 °C	0.4 °C	0.05 °C / °C
R	-50 °C to 1768 °C	0.01 °C	1 °C	0.14 °C / °C
S	-50 °C to 1768 °C	0.01 °C	1 °C	0.14 °C / °C
B	350 °C to 1820 °C	0.01 °C	1 °C	0.14 °C / °C

Thermistor (2.2 kΩ, 5 kΩ, 10 kΩ or User Type)			
Range	Resolution	90 Day/1 Year (23°C ± 5°C)	Temperature Coefficient 0° to 18°C and 28° to 55°C
-80 ° to 150 °C	0.001 °C	0.1 °C	0.003 °C / °C

(10) This specification will be available after 60 minutes of warm-up and sine wave input, unless stated otherwise. This specification applies to 1s gate time.

(11) This specification is available when both sine wave and square wave input ≥ 100 mV. For the input of 10 mV to 100 mV, the % of reading error needs to be multiplied by 10 times.

(12) The amplitude range is from 10% to 120% and is lower than 400 VAC.

(13) The input ≥ 60 mV, for 300 k ~ 1 MHz, within 100 mV range.

(14) The actual measurement range and test lead error will be constrained by the adopted test lead. The test lead accuracy adder covers all errors of measurements and ITS-90 temperature change.

**Specifications (cont.)**

Capacitance <sup>(15)</sup>				
Range	24 Hour TCAL ± 1 °C	90 Day TCAL ± 5 °C	1 Year TCAL ± 5 °C	Temperature Coefficient/°C
1.000 nF	2.00 + 2.00	2.00 + 2.00	2.00 + 2.00	0.05 + 0.01
10.00 nF	2.00 + 1.00	2.00 + 1.00	2.00 + 1.00	0.05 + 0.01
100.0 nF	2.00 + 0.40	2.00 + 0.40	2.00 + 0.40	0.05 + 0.01
1.000 µF	2.00 + 0.40	2.00 + 0.40	2.00 + 0.40	0.05 + 0.01
10.00 µF	2.00 + 0.40	2.00 + 0.40	2.00 + 0.40	0.05 + 0.01
100.0 µF	2.00 + 0.40	2.00 + 0.40	2.00 + 0.40	0.05 + 0.01

(15) Specifications are for film Capacitance inputs that are greater than 10% range.

General	
Display Resolution	4.3" color WQVGA (480x272) with LED backlight
Slot	3 module slots
Internal Memory	100 kSa (nonvolatile)
Interface	USB host port, USBTMC-compliant device port, LAN, 9-pin D-sub Digital I/O, and optional micro GPIB
AC Line Input	100 VAC to 240 VAC ± 10%, 50/60 Hz Max power consumption 50 VA
Environment	80% R.H. at 40 °C non-condensing Operating altitude up to 2,000 m
Weight	9.92 lbs (4.5 kg)
Warranty	3 Years
Safety and EMC	Refer to <a href="https://www.bkprecision.com/support/downloads/ce-declarations">https://www.bkprecision.com/support/downloads/ce-declarations</a> for the latest revision of the declaration of conformity
Standard Accessories	Power cord, certificate of calibration, USB cable, and screwdriver
Optional Accessories	Rackmount kit for DAQ3120 (RKDAQ)
Temperature	
Operation	32 °F to 141 °F (0 °C to 55 °C)
Storage	-40 °F to 158 °F (-40 °C to 70 °C)
Dimension (W x H x D)	
Rack (without rubber boot)	8.7" x 3.5" x 13.7" (220 x 88 x 348.6 mm)
Bench (with rubber boot)	10.5" x 4.2" x 14.1" (266.9 x 107 x 357.8 mm)

**Ordering Information**

① Start with the DAQ3120 or DAQ3120-GPIB base unit to control the modules' relay system.



DAQ3120



DAQ3120-GPIB



② Populate the base unit with any combination of up to 3 modules.

\*These modules do not connect to the built-in DMM

Model	Description
DM300	20-CH Solid-state Multiplexer
DM301	20-CH Multiplexer with 2 Current CH
DM303	40-CH Single-Ended Multiplexer
DM304*	4 x 8 Matrix
DM307*	Multifunction Module
DM308*	20-CH Actuator/General Purpose
DM309	High Voltage and Current Multiplexer

# Service Information

**Warranty Service:** Please go to the support and service section on our website at [bkprecision.com](http://bkprecision.com) to obtain an RMA #. Return the product in the original packaging with proof of purchase to the address below. Clearly state on the RMA the performance problem and return any leads, probes, connectors and accessories that you are using with the device.

**Non-Warranty Service:** Please go to the support and service section on our website at [bkprecision.com](http://bkprecision.com) to obtain an RMA #. Return the product in the original packaging to the address below. Clearly state on the RMA the performance problem and return any leads, probes, connectors and accessories that you are using with the device. Customers not on an open account must include payment in the form of a money order or credit card. For the most current repair charges please refer to the service and support section on our website.

Return all merchandise to B&K Precision Corp. with prepaid shipping. The flat-rate repair charge for Non-Warranty Service does not include return shipping. Return shipping to locations in North America is included for Warranty Service. For overnight shipments and non-North American shipping fees please contact B&K Precision Corp.

Include with the returned instrument your complete return shipping address, contact name, phone number and description of problem.

B&K Precision Corp.  
22820 Savi Ranch Parkway  
Yorba Linda, CA 92887  
[bkprecision.com](http://bkprecision.com)  
714-921-9095

# LIMITED THREE-YEAR WARRANTY

B&K Precision Corp. warrants to the original purchaser that its products and the component parts thereof, will be free from defects in workmanship and materials for a period of **three years** from date of purchase. B&K Precision Corp. will, without charge, repair or replace, at its option, defective product or component parts. Returned product must be accompanied by proof of the purchase date in the form of a sales receipt.

To help us better serve you, please complete the warranty registration for your new instrument via our website [www.bkprecision.com](http://www.bkprecision.com)

**Exclusions: This warranty does not apply in the event of misuse or abuse of the product or as a result of unauthorized alterations or repairs. The warranty is void if the serial number is altered, defaced or removed.**

B&K Precision Corp. shall not be liable for any consequential damages, including without limitation damages resulting from loss of use. Some states do not allow limitations of incidental or consequential damages. So the above limitation or exclusion may not apply to you.

This warranty gives you specific rights and you may have other rights, which vary from state-to-state.

B&K Precision Corp.  
22820 Savi Ranch Parkway  
Yorba Linda, CA 92887  
[www.bkprecision.com](http://www.bkprecision.com)  
714-921-9095

**Version: October 30, 2025**