

BK PRECISION®

Model 2831E , 5491B

4 ½ Digit and 50,000 Count Bench Multimeters

USER MANUAL



Notice

The information contained in this document is subject to change without notice.

Safety Notice Supplement

As described in the International Electrotechnical Commission (IEC) Standard IEC 664, digital multimeter measuring circuits (e.g., B&K Models 2831E and 5491B) and the USB terminal are Installation Category II (CATII). The AC input terminal is rated CAT I.

This equipment is POLLUTION DEGREE 2, INDOOR USE product.

Safety Summary

The following safety precautions apply to both operating and maintenance personnel and must be observed during all phases of operation, service, and repair of this instrument. Before applying power, follow the installation instructions and become familiar with the operating instructions for this instrument.

GROUND THE INSTRUMENT

To minimize shock hazard, the instrument chassis and cabinet must be connected to an electrical ground. This instrument is grounded through the ground conductor of the supplied, three-conductor ac power cable. The power cable must be plugged into an approved three-conductor electrical outlet. Do not alter the ground connection. Without the protective ground connection, all accessible conductive parts (including control knobs) can render an electric shock. The power jack and mating plug of the power cable meet IEC safety standards.

DO NOT OPERATE IN AN EXPLOSIVE ATMOSPHERE

Do not operate the instrument in the presence of flammable gases or fumes. Operation of any electrical instrument in such an environment constitutes a definite safety hazard.

KEEP AWAY FROM LIVE CIRCUITS

Instrument covers must not be removed by operating personnel. Component replacement and internal adjustments must be made by qualified maintenance personnel. Disconnect the power cord before removing the instrument covers and replacing components. Under certain

conditions, even with the power cable removed, dangerous voltages may exist. To avoid injuries, always disconnect power and discharge circuits before touching them.

DO NOT SERVICE OR ADJUST ALONE

Do not attempt any internal service or adjustment unless another person, capable of rendering first aid and resuscitation, is present.

DO NOT SUBSTITUTE PARTS OR MODIFY THE INSTRUMENT

Do not install substitute parts or perform any unauthorized modifications to this instrument. Return the instrument to B&K Precision for service and repair to ensure that safety features are maintained.

WARNINGS AND CAUTIONS

WARNING and **CAUTION** statements, such as the following examples, denote a hazard and appear throughout this manual. Follow all instructions contained in these statements.

A **WARNING** statement calls attention to an operating procedure, practice, or condition, which, if not followed correctly, could result in injury or death to personnel.

A **CAUTION** statement calls attention to an operating procedure, practice, or condition, which, if not followed correctly, could result in damage to or destruction of parts or the entire product.

WARNING: Do not alter the ground connection. Without the protective ground connection, all accessible conductive parts (including control knobs) can render an electric shock. The power jack and mating plug of the power cable meet IEC safety standards.

WARNING: To avoid electrical shock hazard, disconnect power cord before removing covers. Refer servicing to qualified personnel.

CAUTION: Before connecting the line cord to the AC mains, check the rear panel AC line voltage indicator. Applying a line voltage other than the indicated voltage can destroy the AC line fuses. For continued fire protection, replace fuses only with those of the specified voltage and current ratings.

CAUTION: This product uses components which can be damaged by electro-static discharge (ESD). To avoid damage, be sure to follow proper procedures for handling, storing and transporting parts and subassemblies which contain ESD-sensitive components.

SAFETY SYMBOL



This symbol on an instrument indicates that the user should refer to the operating instructions located in the manual.



Electrical Shock hazard.



Chassis ground symbol.

**CAT I
(1000V)** IEC Measurement Category II.
Inputs may be connected to
mains (up to 300 VAC) under
Category II overvoltage conditions.

**CAT II
(300V)** IEC Measurement Category II.
Inputs may be connected to
mains (up to 300 VAC) under
Category II overvoltage conditions.

Compliance Statements

Disposal of Old Electrical & Electronic Equipment (Applicable in the European Union and other European countries with separate collection systems)



This product is subject to Directive 2002/96/EC of the European Parliament and the Council of the European Union on waste electrical and electronic equipment (WEEE) , and in jurisdictions adopting that Directive, is marked as being put on the market after August 13, 2005, and should not be disposed of as unsorted municipal waste. Please utilize your local WEEE collection facilities in the disposition of this product and otherwise observe all applicable requirements.

Table of Contents

Notice	2
Safety Notice Supplement.....	2
Safety Summary	2
Chapter 1 General Information.....	8
1.1 Feature Overview.....	8
1.2 Incoming Inspection	8
Chapter 2 Overview	9
2.1 Front Panel Overview	9
2.2 Annunciators on Screen	10
2.3 Front Panel Menu Reference	11
2.4 Front Panel Menu Overview.....	12
2.5 Rear Panel Summary	13
2.6 Power up.....	14
2.6.1 Power Line Connection	14
2.6.2 Input Terminals	14
2.6.3 Power-up Sequence	16
2.6.4 High Energy Circuit Safety Precautions	16
2.6.5 Power-on Defaults.....	17
2.6.6 Warm-up time	17
2.7 Display.....	17
Chapter 3 Basic Measurements.....	18
3.1 Preparation.....	18
3.2 Measuring Voltage	18
3.2.1 Connections.....	18
3.3 Measuring Current	19
3.3.1 Connections	20
3.3.2 Front Panel Fuse Replacement	22
3.4 Measuring Resistance	23
3.4.1 Connections.....	23
3.5 Measuring Frequency and Period	24
3.5.1 Trigger Level and Measurement Errors	24
3.5.2 Gate Time	24
3.5.3 Connections	24
3.6 Measuring Continuity	25
3.6.1 Connections	26
3.7 Testing Diode.....	26
3.7.1 Connections	26
3.8 Measuring True RMS AC+DC	27
3.8.1 Connections.....	27
3.8.2 Using the 2 nd parameter display	28
3.9 Math Functions	29
3.9.1 Percent	29

3.9.2 dB Calculation.....	30
3.9.3 dBm Calculation	31
Chapter 4 Measurement Options.....	33
4.1 Measurement configuration	33
4.1.1 Range	33
4.1.2 Relative.....	34
4.1.3 Rate.....	34
4.2 Trigger Operations	35
4.2.1 Trigger procedure.....	35
4.2.2 Reading Hold	36
4.3 MAX / MIN	36
4.4 Limit Operations	36
4.4.1 Enabling limits.....	37
4.4.2 Setting Limit Values	37
4.5 System Operations	37
4.5.1 Beeper Control	38
4.5.2 Baud rate	38
4.5.3 Selecting the Terminal Character.....	39
4.5.4 Key Sound.....	40
Chapter 5 Remote Operation	41
5.1 USB & RS232	41
5.2 Serial Interface Operation.....	41
5.2.1 USB interface configured as virtual COM RS232 interface.....	41
5.2.2 Sending and receiving data	41
5.2.3 Selecting Baud Rate	41
5.2.4 Software Protocol.....	42
5.3 Data Format	42
Chapter 6 SCPI Command Reference	43
6.1 Command structure.....	43
6.2 Command Syntax.....	43
6.2.1 Commands and command parameters	43
6.2.2 Short-form Rules	45
6.2.3 Basic Rules of Command Structure	45
6.2.4 Multiple Command Rules.....	46
6.2.5 Command Path Rules	46
6.3 Command Reference	46
6.3.1 DISPlay subsystem.....	46
6.3.2 FUNCtion subsystem.....	48
6.3.3 VOLTage subsystem.....	49
6.3.4 CURRent subsystem	53
6.3.5 RESistance subsystem	57
6.3.6 FREQuency and PERiod subsystem	60
6.3.7 TRIGger subsystem.....	62
6.3.8 FETCh Subsystem	63

6.3.9 SYSTEM Subsystem	63
6.3.10 Common Commands	64
Chapter 7 Specifications	65
SERVICE INFORMATION.....	73
LIMITED WARRANTY.....	74

Chapter 1 General Information

1.1 Feature Overview

The 2831E 4½ digit and 5491B 50,000 count multimeters provide measurements with high accuracy, great stability and fast measurement rates. The meters provide a maximum measurement rate of 25 readings/sec and a 0.02% and 0.03% DC voltage basic accuracy for model 5491B and 2831E respectively. Both meters have broad measurement ranges:

- DC voltage from 50 μ V to 1000 V
- AC (RMS) voltage from 1 mV to 750 V
- DC current from 100 nA to 20 A
- AC (RMS) current from 100n A to 20 A
- Two -wire resistance from 10 m Ω to 20 M Ω (50 M Ω for model 5491B)
- Frequency from 5 Hz to 1 MHz

Some additional capabilities:

- Full range of functions: In addition to those listed above, the meter functions include period, dB, dBm, continuity, diode testing, max, min and percent.

Programming languages and remote control interfaces: The meters are programmable via USB (Virtual COM) interface using SCPI commands

1.2 Incoming Inspection

Please inspect the instrument mechanically and electrically upon receiving it. Unpack all items from the shipping carton, and check for any obvious signs of physical damage that may have occurred during transportation. Report any damage to the shipping agent immediately. Save the original packing carton for possible future reshipment. The following items are included with every order:

- Multimeter
- Test leads
- Power cord
- Spare fuse
- Operation Manual
- Calibration certificate and test report

Verify that all items above are included in the shipping container. If anything is missing, please contact B&K Precision.

Chapter 2 Overview

2.1 Front Panel Overview

The front panel of the multimeter is shown in Figure 2-1. This figure includes some important abbreviated information that should be reviewed before operating the instrument.

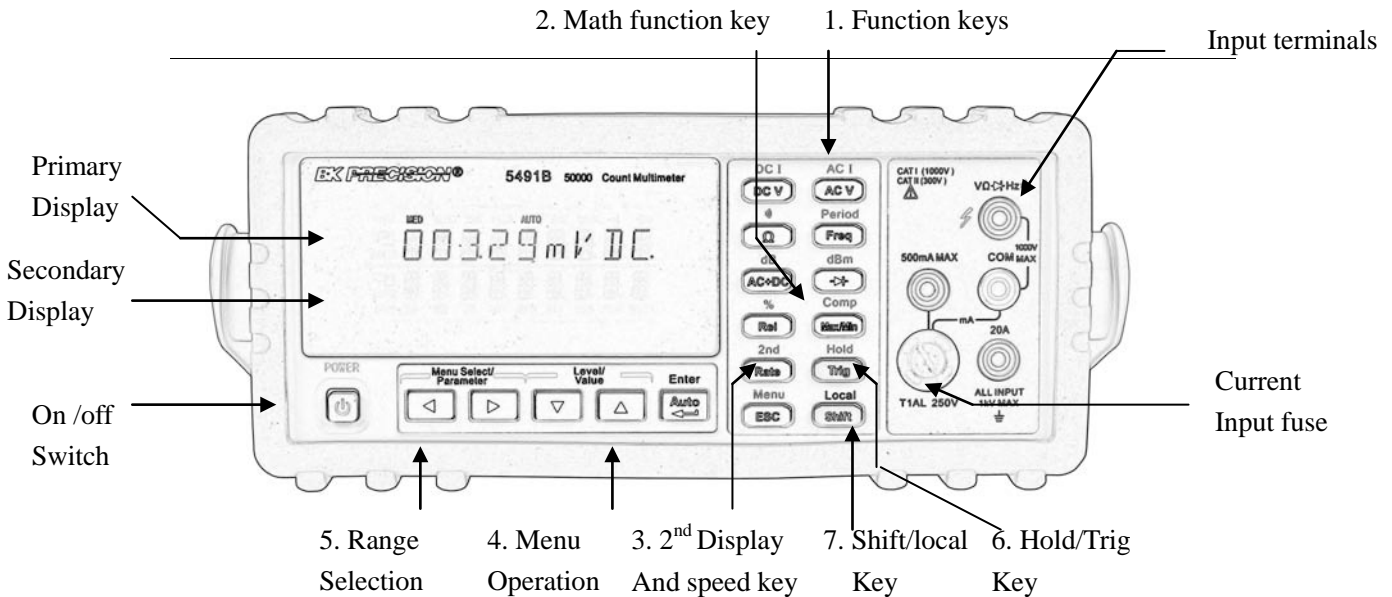





Figure 2-1 Front Panel

- 1. Measurement Function keys (shifted and unshifted)**
 Select measurement function: DC voltage and current, AC voltage and current, resistance, continuity, frequency, period, dB, dBm, True RMS AC+DC and diode test.
- 2. Math function keys**
 Select the math function: Rel, %, Max/Min, Comp and Hold.
- 3. 2nd Display and speed key**
 [Rate] Changes reading rate: Fast, Medium and Slow.
 [Shift] → [Rate] turns on/ off the 2nd parameter display.
- 4. Menu operation keys**
 [Shift] → [Esc] Open/Close menu
 [Left Arrow] Move through selections within menu level, command level or parameter level
 [Right Arrow] Move through selections within menu level, command level or parameter level.
 [Up Arrow] Move up a level.
 [Down Arrow] Move down a level.
 [Auto] (ENTER) Save the change made on “parameter” level, and return to the “command” level.
 [Esc] Cancel the change made on “parameter” level, and return to the “command” level.

5. Range and Combination function selecting keys

 Select a 2nd display parameter

 Select a 2nd display parameter



 Select a higher range and disable auto ranging.

 Select a lower range and disable auto ranging.

 Toggle between auto ranging and manual ranging.

6. Trig/Hold Key

 Trigger a measurement from the front panel.

 →  Hold a reading on the display.

7. Shift/Local keys

 Used to access shifted keys.

 (LOCAL) Cancel remote control mode and back to the LOCAL mode.

2.2 Annunciators on Screen

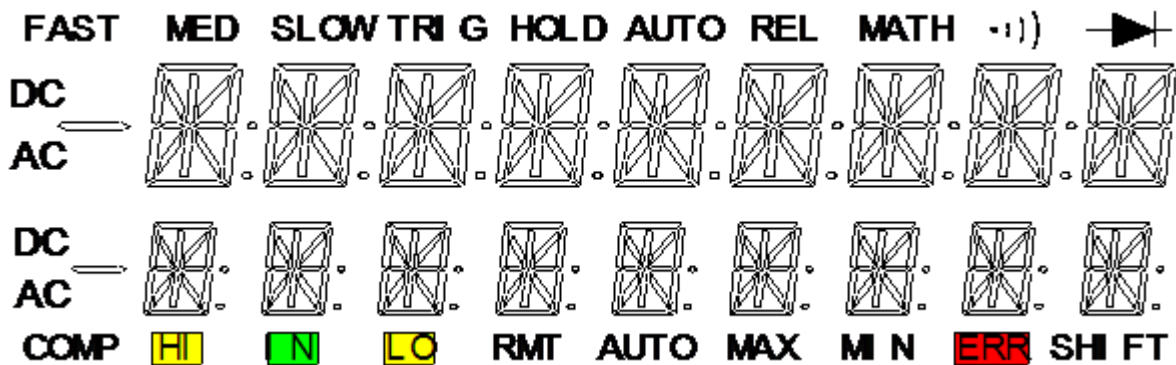

Figure 2-2 Display Annunciators

FAST	Fast reading rate
MED	Medium reading rate
SLOW	Slow reading rate
TRIG	Indicates trigger (front panel, bus) selected.
HOLD	Reading HOLD function is enabled
REL	Relative reading displayed
MATH	A math operation is enabled (% , dB , dBm).
»» (Speaker)	Beeper on for continuity testing function
➔ (Diode)	Instrument is in diode testing function
DC	DC operation is enabled
AC	AC operation is enabled
COMP	Limit testing function is enabled

HI/IN/LO	Indicates the limit testing results
RMT	Multimeter is in remote control mode
AUTO	Auto ranging enabled
Max/Min	MAX / MIN operation is enabled
ERR	Hardware or remote control error detected
SHIFT	Accessing shifted keys

2.3 Front Panel Menu Reference

A: MATH MENU

1: HI LIMIT → 2: LO LIMIT → 3: PERC REF → 4: dB REF → 5: dBm REF

- | | |
|-------------|--|
| 1. HI LIMIT | Set the high limit for limit testing. |
| 2. LO LIMIT | Set the low limit for limit testing. |
| 3. PERC REF | Set the reference value for PERCENT function |
| 4. dB REF | Set the dB reference voltage value. |
| 5. dBm REF | Set the dBm reference impedance value. |

B: TRIGGER MENU

1: TRIG MOD





- | | |
|-------------|--|
| 1. TRIG MOD | Select IMMEDIATE, Manual or Bus trigger source mode. |
|-------------|--|

C: SYSTEM MENU

1: BEEP STA → 2: BAUD RAT → 3: TX TERM → 4: RETURN → 5: KEY SONG → 6: REVISION

- | | |
|-------------|---|
| 1. BEEP STA | Enable or disable the beeper function |
| 2. BAUD RAT | Select the baud rate for USB (virtual COM) or RS232 (Model 5491B only) operation. |
| 3. TX TERM | Set the terminal character for USB (virtual COM) or RS232 (Model 5491B only) operation, which identifies the end of a command string |
| 4. RETURN | Sets whether to enable Echo of the "sent" SCPI commands in return string. (i.e. if ON, sending *IDN? will return with *IDN? and model information on two separate lines). |
| 5. KEY SONG | Enable or disable the key sound when you press a key. |
| 6. REVISION | Shows the model number and firmware version of the instrument. |

2.4 Front Panel Menu Overview

The menu is organized in a top-down tree structure with three levels (menus, commands and parameters) as shown in Figure 2-3. You can use down () or up () to move menu tree from one level to another. Each of the three levels has several horizontal choices which you can view by using left () or right ()

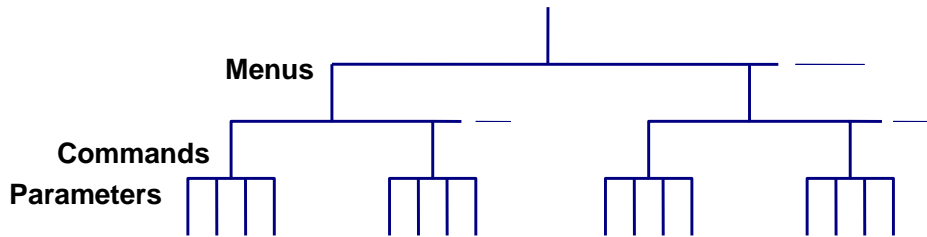









Figure 2-3 Menu Tree

- To turn on the menu, press  →  (Menu).
- To turn off the menu, press  →  (Menu), or press any of the function or math keys on the front panel.
- To confirm a change on the “parameter” level, press  (ENTER).
- To cancel a change on the “parameter” level, press  (Menu).

Note: If you press  on the “menu” level, this is the top level of the menu and you cannot go any higher; similarly if you press  on the “parameter” level, this is the bottom level of the menu and you cannot go any lower.

2.5 Rear Panel Summary

The rear panel of the multimeter is shown in Figure 2-4. This section includes important information that should be reviewed before operating the instrument.

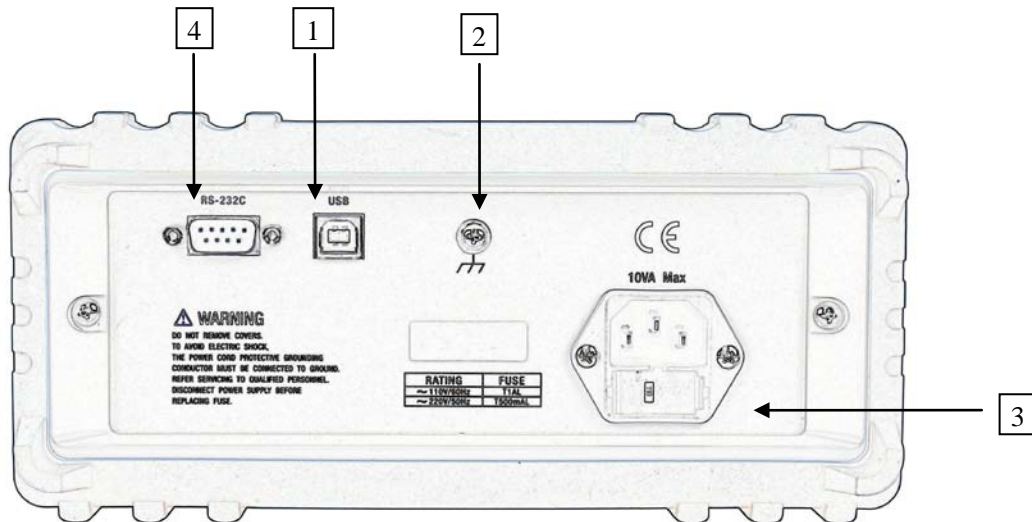

Figure 2-4 Rear Panel

1. USB Device Port
Connection port for USB remote control.
2. Grounding
Chassis Grounding terminal
3. Power-Line Fuse-Holder Assembly
The multimeter can be configured for line voltage of 110/220 V \pm 10% AC at line frequency of 50/60 Hz \pm 5%.
Power-line fuse is used for instrument protection. (220 V/500 mA or 110 V/1 A)
Note: Please use the same-type fuse. To verify and replace the fuse, remove the power cable and pull out the fuse holder. To select between line voltage operations of 110 V or 220 V, turn the grey colored fuse holder until the correct line voltage label is shown on the outer window of the fuse holder. It should say “110” or “220” depending which way you turn it.
4. RS232 Communication Port (**Model 5491B only**)
Connection port for remote control via RS232.

2.6 Power up

2.6.1 Power Line Connection

Follow the procedure below to connect the multimeter to line power and turn on the instrument.

1. Check to make sure that the line voltage is in the correct range of 110 V or 220 V \pm 10% (198 V to 242 V) and line frequency is in the range of 60 Hz or 50 Hz \pm 5% (or 47.5 to 52.5 Hz) and that the line voltage switch is in the correct position before connecting the power cord. To check, first look at the label on the fuse compartment to verify if it is shown as “110” or “220”. If it is not switched to the correct one, open up the fuse compartment and turn the grey fuse holder until it shows the correct voltage label (110 or 220) on the outer part of the fuse compartment. Then, check to make sure correct fuse value is used for the selected voltage operation.

CAUTION: *Operating the instrument on an incorrect voltage may cause damage to the instrument, possibly voiding the warranty.*

2. Before plugging in the power cord, make sure that the front panel power switch is in the off position.
3. Connect the female end of the supplied power cord to the AC receptacle on the rear panel. Connect the other end of the power cord to a grounded AC outlet.

WARNING: *The power cord supplied with the multimeter contains a separate ground wire for use with grounded outlets. When proper connections are made, instrument chassis is connected to power line ground through the ground wire in the power cord. Failure to use a grounded outlet may result in personal injury or death due to electric shock.*

4. Turn on the instrument by pressing the front panel power switch and instrument is ready for measuring.

2.6.2 Input Terminals

The input terminals are shown in Figure 2-5. The multimeter is protected against overloads up to the limits as shown in table 2-1. Exceeding these limits may result in a hazard to both the multimeter and operator.

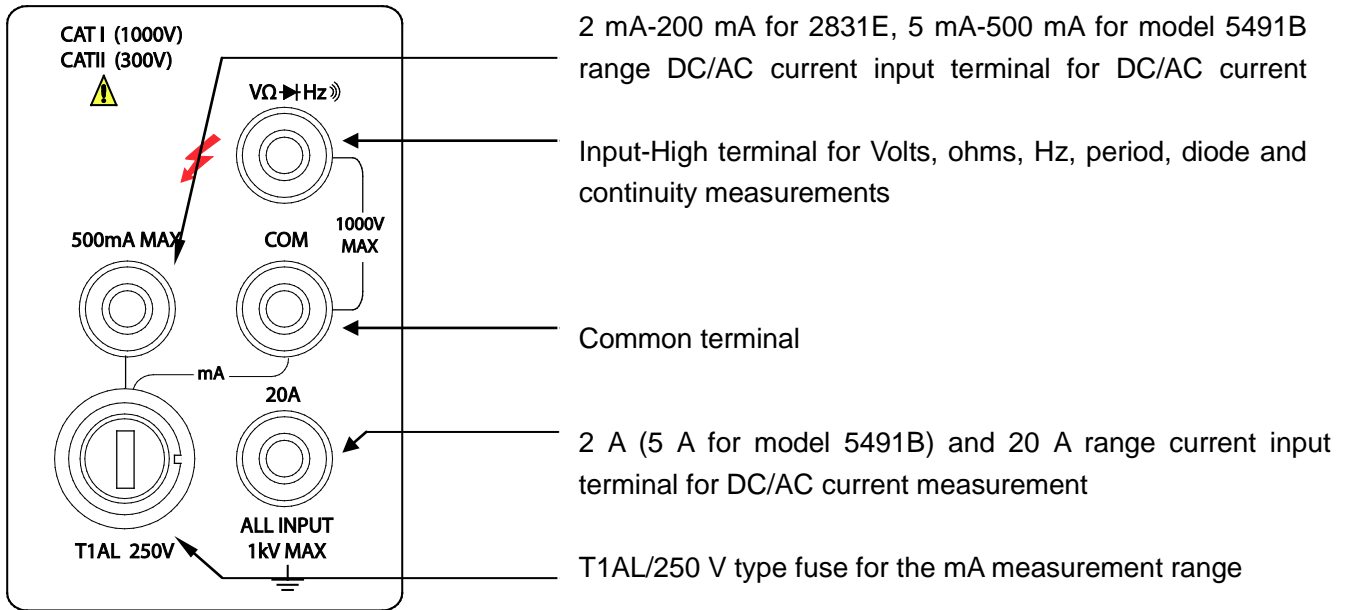

Figure 2-5 Input terminals

Table 2-1 Input protection Limits

Function	Input Terminals	Maximum Allowable Input
DCV	V Ω \rightarrow to COM	1010V DC
ACV,HZ	V Ω \rightarrow to COM	757.5V AC RMS,1000V Peak
mA, HZ	500mA to COM	200mA (Model 5491B: 500 mA) DC or AC RMS
20A,HZ	20A to COM	20A DC or AC RMS
Ω	V Ω \rightarrow to COM	500V DC or AC RMS
\rightarrow , \gg	V Ω \rightarrow to COM	500V DC or AC RMS
All functions	Any terminals to earth	1000V DC or 1000V peak AC

2.6.3 Power-up Sequence

On power-up, the multimeter performs self-tests on its EPROM and RAM and lights all segments and annunciators for about 1 second. If a failure is detected, the instrument momentarily displays an error message and the ERR annunciator turns on.

If the instrument passes self-tests, the firmware revision will be displayed momentarily.

2.6.4 High Energy Circuit Safety Precautions

To optimize safety when measuring voltage in high energy distribution circuits, read and use the directions in the following.

When making measurements in high energy circuits, use test leads and accessories that meet the following requirements:

- Test leads and accessories must be fully insulated.
- Only use test leads that can be connected to the circuit (e.g., alligator clips, spade lugs, etc.) for hands-off measurements.
- Do not use test leads or accessories that decrease voltage spacing. This diminishes arc protection and creates a hazardous condition.

Use the following sequence when measuring high energy circuits:

1. De-energize the circuit using a regular installed connect-disconnect device, such as a circuit breaker, main switch, etc.
2. Attach the test leads to the circuit under test. Use appropriate safety rated test leads.
3. Set the multimeter to the proper measurement function and range.
4. Energize the circuit using the installed connect-disconnect device and make measurements without disconnecting the multimeter.
5. De-energize the circuit using the installed connect-disconnect device.
6. Disconnect the test leads from the circuit under test.

WARNING: *The maximum common-mode voltage (voltage between COM and the chassis ground) is 500V peak. Exceeding this value may cause a breakdown in insulation, creating a shock hazard.*

2.6.5 Power-on Defaults

2831E and 5491B have a factory default setting for the power-on setting.

Since the basic measurement procedures in this manual assume the factory defaults, reset the instrument to the factory settings when following step-by-step procedures. Table 2-2 lists the factory default settings.

Table 2-2 Factory Default Settings

Setting	Factory Default
Function	DCV
Range	AUTO
Rate	Medium
Remote/Local	Local
Trigger Mode	Immediate
Relative Mode	OFF
Compare Mode	OFF
HI Limit	+1
Lo Limit	-1
Percent Mode	OFF
Reference	+1
Max/Min Mode	OFF
Reading Hold	OFF
Secondary Display Mode	OFF
Cal Mode	OFF

2.6.6 Warm-up time

The multimeter is ready for use as soon as the power-up sequence has completed. However, to achieve rated accuracy and stability, allow the instrument to warm up for half an hour. If the instrument has been subjected to extreme temperatures, allow additional time for internal temperatures to stabilize.



2.7 Display

The display of the multimeter is primarily used to display readings, along with the units and type of measurement. Annunciators located on the left, right and bottom indicate various states of operation. See section 2.2 for a complete listing of annunciators.

Chapter 3 Basic Measurements

3.1 Preparation

One of the first things you would like to do with your multimeter is to become acquainted with its front panel. We have provided some exercises in foregoing chapters about preparations for use and operations of front panel.

The front panel has six rows of keys to select various functions and operations. Most keys have a shifted function printed in blue above the key. To perform a shifted function, press  (the **Shift** annunciator will turn on). Then, press the key that has the desired label above it. For example, to select the AC current function, press  then press  (ACI).

If you accidentally press , just press it again to turn off the **Shift** annunciator.

3.2 Measuring Voltage







Voltage ranges: 200 mV, 2 V, 20 V, 200 V, 1000 V (750 VAC) (model 5491B: 500 mV, 5 V, 50 V, 500 V, 1000 V (750 VAC))

Maximum resolution: 50 μ V for DC and 1 mV for AC (on 200 mV range (model 2831E) and on 500 mV range (model 5491B))







AC technique: true RMS, AC-coupled, 1000 V Peak AC

3.2.1 Connections

Assuming the multimeter is under factory default conditions, the basic procedure is as follows:

1. Connect test leads to $V\Omega$  and COM terminals.
2. Select DC or AC voltage measurement by pressing  or  .
3. Press  to toggle between auto and manual ranging. Notice that the **AUTO** annunciator is displayed when in auto ranging mode. If you want manual ranging, use the RANGE  and  keys to select a measurement range consistent with expected voltage.
4. Connect test leads to the sources as shown in Figure 3-1.

CAUTION: Do not apply more than 1000V peak to the input or instrument damages may occur.

5. In manual range, if the “OVL.D” message is displayed, press the up  key to select a higher range until a desired reading is displayed (or press  key for auto ranging). Use the lowest possible range for the best resolution.
6. Press + to turn on the secondary display, Use  or  key to choose the

function for secondary display.

7. Take readings from the display.

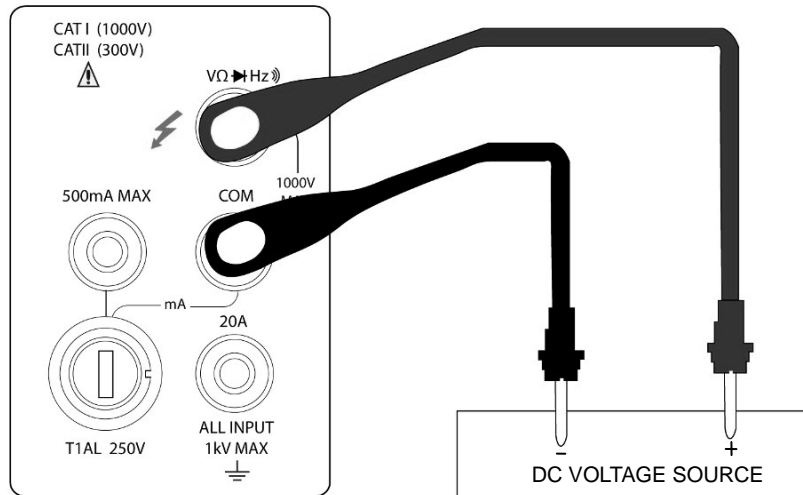

Input Resistance = 10 M Ω

CAUTION: Maximum Input = 1010 V peak

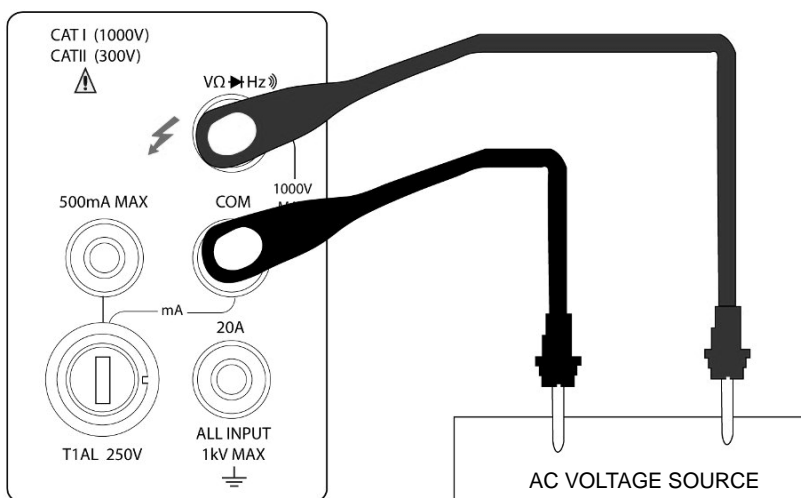

Input Impedance = 1.1 M Ω and 100 pF

CAUTION: Maximum Input = 750 V RMS or 1000 V peak, 3×10^7 V-Hz

Figure 3-1 DC and AC Voltage Measurement Connections

3.3 Measuring Current

Model 2831E current measurement range: 2 mA, 20 mA, 200 mA, *2 A, *20 A

Model 5491B current measurement range: 5 mA, 50 mA, 500 mA, *5 A, *20 A

*Indicates range is available for manual range only. Auto range will not work when reading requires

setting to this range.

Maximum resolution: 100nA (on 2 mA range (on 5 mA range for model 5491B))

Current measurement is available in Auto range for the lower current measurements only.



Note:

For 2831E, readings that are below 200 mA using the low current measurement input can be set in auto range. This means it will auto range between 2 mA, 20 mA, and 200 mA range. For readings above 200 mA, auto range is not available. Manual range must be used to read any readings higher than 200 mA. This means, for ranges 2 A and 20 A, only manual range is available. Additionally, the high current measurement input must be used to obtain measurements in these two higher ranges.

For 5491B, readings that are below 500 mA using the low current measurement input (fuse protected up to 500 mA max.) can be set in auto range. This means it will auto range between 5 mA, 50 mA, and 500 mA range. For readings above 500 mA, auto range is not available. Manual range must be used to read any readings higher than 500 mA. This means, for ranges 5 A and 20 A, only manual range is available. Additionally, the high current measurement input must be used to obtain measurements in these two higher ranges.

3.3.1 Connections

Assuming the multimeter is under factory default conditions, the basic procedure to measure current is as follows (users must use manual range for measurement, following step 3):

1. Connect test leads between 500 mA terminal (for lower current measurements) and COM terminal or between 20 A terminal (for higher current measurements) and COM terminal.
2. Select DCI or ACI measurement function by pressing **Shift** → **DCV** or **Shift** → **ACV**.
3. Press **Auto** toggles auto ranging. Note that auto range is only available for readings that are below 200 mA (for 2831E) and 500 mA (for 5491B) and when using the 500 mA max. terminal and COM terminal connections. For readings above these limits, only manual range is available and the 20 A terminal and COM terminal must be used to obtain measurement results. If instrument shows the **AUTO** annunciator on display, press again to turn off auto ranging mode and go into manual range mode. Use the RANGE  and  keys to select a measurement range consistent with expected current.
4. Connect test leads to the source as shown in Figure 3-2.

CAUTION: Do not apply more than 1 A, 250 V to the 500 mA input terminal or the fuse will be blown. For measuring current higher than 500 mA (or 200 mA for model 2831E), use the 20 A terminal instead.

5. In manual range, if the “OVL.D” message is displayed, press up  key to select a higher range until a desired reading is displayed. Use the lowest possible range for the best resolution. Press

Shift+**Rate** to turn on the 2nd parameter display, Use **◀** or **▶** key to select function for 2nd display.

6. Take readings from the display.

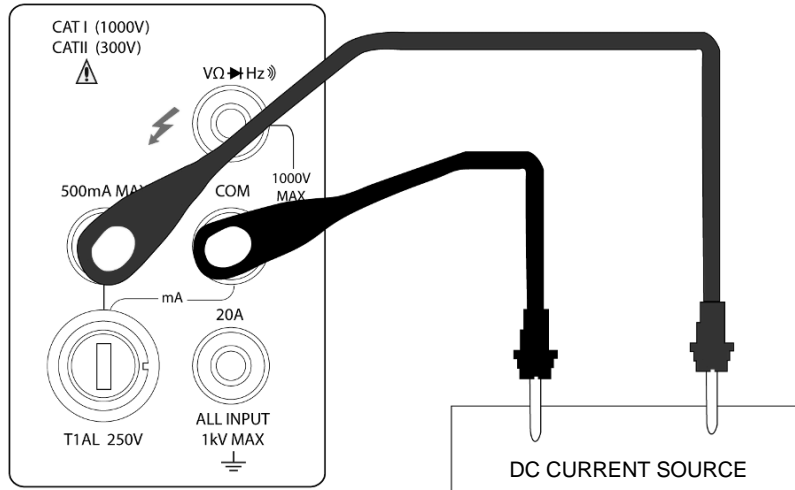

(Model 2831E) DC Current measurement on Range: 2 mA, 20 mA, 200 mA

(Model 5491B) DC Current measurement on Range: 5 mA, 50 mA, 500 mA

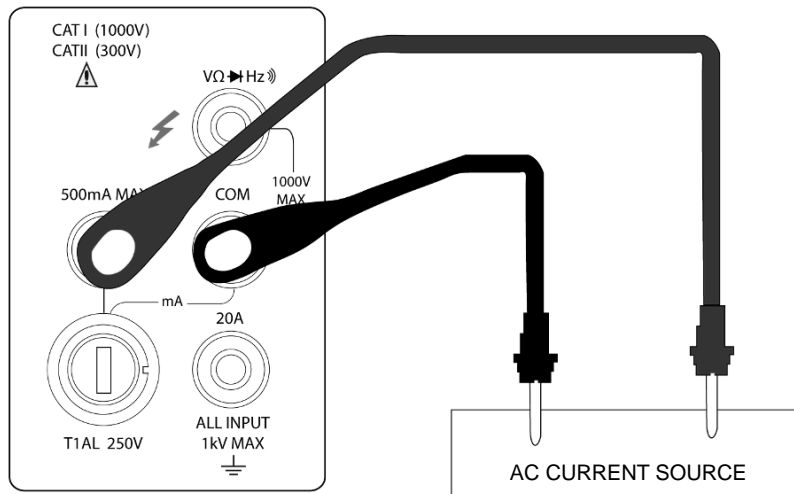

(Model 2831E) AC Current measurement on Range: 2 mA, 20 mA, 200 mA

(Model 5491B) AC Current measurement on Range: 5 mA, 50 mA, 500 mA

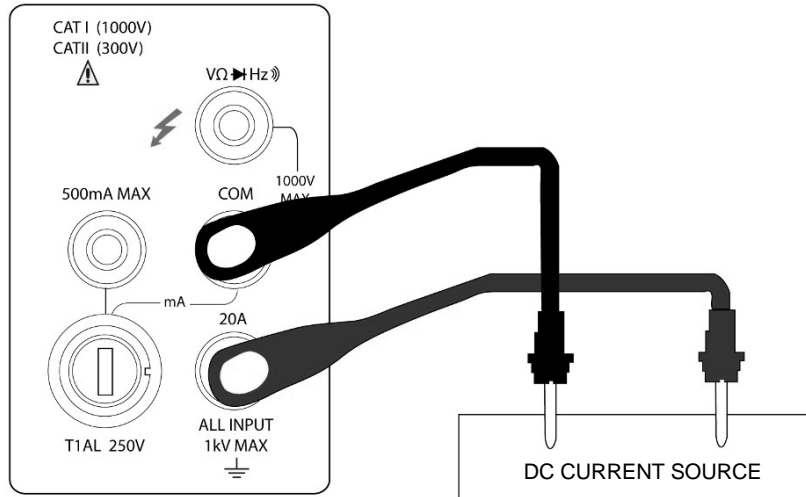

(Model 2831E) DC Current measurement on Range: 2 A, 20 A
(Model 5491B) DC Current measurement on Range: 5 A, 20 A

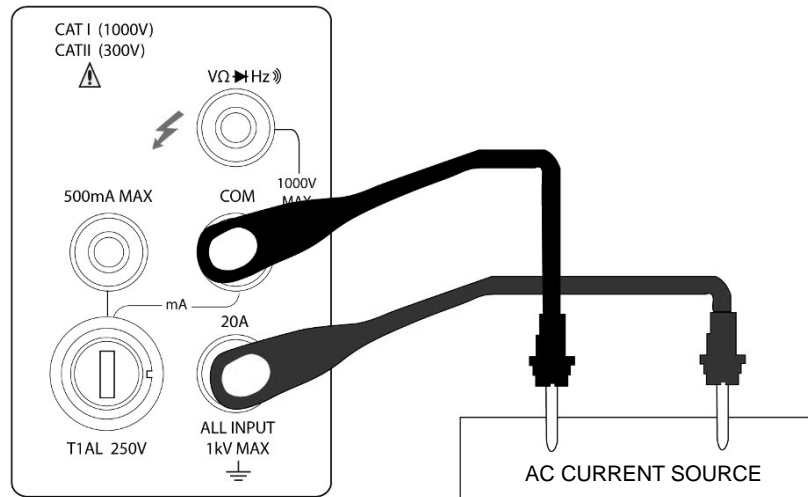

(Model 2831E) AC Current measurement on Range: 2 A, 20 A
(Model 5491B) AC Current measurement on Range: 5 A, 20 A

CAUTION: Maximum Input = 20 A DC or RMS Maximum test times : < 20 s

Figure 3-2 DC and AC Current Measurements

3.3.2 Front Panel Fuse Replacement

WARNING: Make sure the instrument is disconnected from the power line and other equipment before replacing the AMPS fuse.

1. Turn off the power and disconnect the power line and test leads.
2. From the front panel, use a screwdriver to rotate the fuse carrier several turns counter-clockwise. Take the fuse carrier out of the socket.
3. Remove the fuse and replace it with the same type (T1AL, 250V, 5x20mm) .

CAUTION: *Do not use a fuse with a higher current rating than specified or instrument may be damaged. If the instrument repeatedly blows fuses, try to find out the reason before replacing the fuse.*

4. Install the new fuse by reversing the procedure above.





3.4 Measuring Resistance

Model 2831E Resistance measurement range: 200 Ω , 2 k Ω , 20 k Ω , 200 k Ω , 2 M Ω , 20 M Ω ; Maximum resolution: 10 m Ω (on 200 Ω range)



Model 5491B Resistance measurement range: 500 Ω , 5 k Ω , 50 k Ω , 500 k Ω , 5 M Ω , 50 M Ω ; Maximum resolution: 10 m Ω (on 500 Ω range)

3.4.1 Connections

Assuming the multimeter is under factory default conditions, the basic procedure for measuring resistance is as follows:

1. Connect the test leads between $V\Omega \rightarrow$ and COM.
2. Select resistance measurement function by pressing 
3. Press  toggles auto ranging. Notice the **AUTO** annunciator is displayed with auto ranging. If you want manual ranging, use the RANGE  and  keys to select a measurement range consistent with expected resistance.
4. Connect test leads to the resistance as shown in Figure 3-3:

CAUTION: *Do not apply more than 1000 V peak between $V\Omega \rightarrow$ and COM or instrument damage may occur.*

5. In manual range, if the “OVL.D” message is displayed, press up  key to select a higher range until a normal reading is displayed (or press  key for auto ranging). Use the lowest possible range for the best resolution.
6. Take readings from the display.

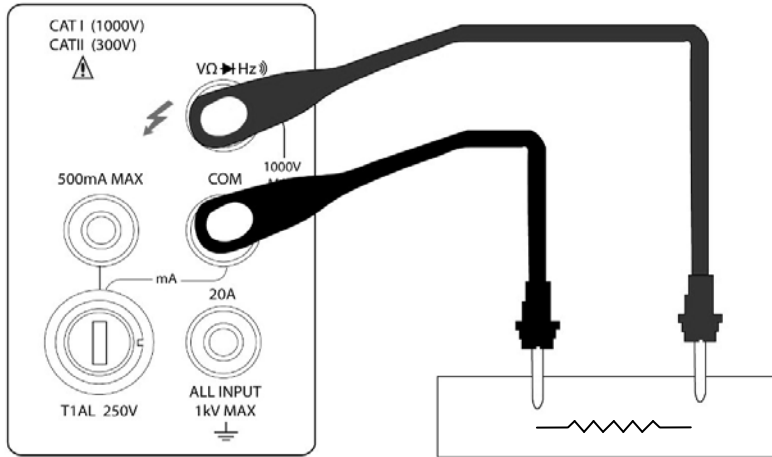

Note: Source current flows from the VΩHz to COM terminals



Figure 3-3 Resistance Measurements

3.5 Measuring Frequency and Period

Frequency measurement range: 5 Hz to more than 1 MHz.

Period measurement range: 0.2 s to less than 1 μ s.

Input signal range: 200 mV AC to 750V AC.

The instrument uses the volts input terminals to measure frequency. The AC voltage range can be changed with the RANGE  and  keys. However, the signal voltage must be greater than 10% of the full-scale range.

3.5.1 Trigger Level and Measurement Errors



The multimeter uses a technique which maintains a constant resolution for any input frequency to measure frequency and period. The gate time is always a multiple of the measured signal period rather than a fixed time. The error will be no more than +/-1 from the total gate counts, which assures an equivalent accuracy over the whole frequency range.

3.5.2 Gate Time

Gate time is the amount of time the meter uses to sample frequency or period readings. The measurement speed rate and the measuring frequency change the gate time.

3.5.3 Connections

Assuming the multimeter is under factory default conditions, the basic procedure for measuring frequency and period is as follows:

1. Connect test leads to VΩHz and COM terminals.
2. Select frequency or period measurement functions by pressing  or  → 
3. Connect test leads to the source as shown in Figure 3-4:

CAUTION: Do not exceed 1000 V peak between VΩHz and COM, or instrument may be

damaged.

4. Take reading from the display

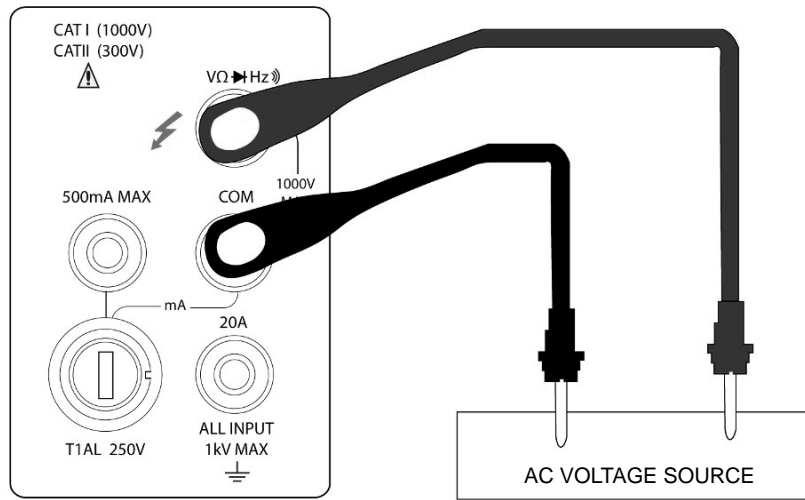

Figure 3-4 Frequency and Period Measurements

Input Impedance = 1.1 MΩ in parallel with 100 pF

CAUTION: Maximum Input = 750 V RMS or 1000 V peak, 3×10^7 V-Hz

3.6 Measuring Continuity

Under continuity test, when 200 Ω range is selected, the multimeter alerts you with a beep when a reading is below a threshold resistance level of 10 Ω. For other ranges, the beeper will sound if a reading is below a threshold resistance level listed in table 3-1. This beep will sound within less than half a second when reading measured is below the threshold.

Table 3-1 Threshold resistance levels in Continuity Test

Model 2831E	
Measuring range	Beeper on
200.00 Ω	<10 Ω
2.0000 kΩ	<100 Ω
20.000 kΩ	<1 kΩ
200.00 kΩ	<10 kΩ
2.0000 MΩ	<100 kΩ
20.000 MΩ	<1 MΩ
Model 5491B	
Measuring range	Beeper on
500.00 Ω	<10 Ω
5.0000 kΩ	<100 Ω
50.000 kΩ	<1 kΩ
500.00 kΩ	<10 kΩ
5.0000 MΩ	<100 kΩ
50.000 MΩ	<1 MΩ

3.6.1 Connections

Assuming the multimeter is under factory default conditions, the basic procedure to measure continuity is as follows:

1. Connect test leads to $V\Omega \rightarrow \rightarrow$ and COM terminals.
2. Select Continuity measurement function by pressing $\text{Shift} \rightarrow \Omega$.
3. Connect test leads to the resistance under test as shown in Figure 3-5.
4. Take reading from the display

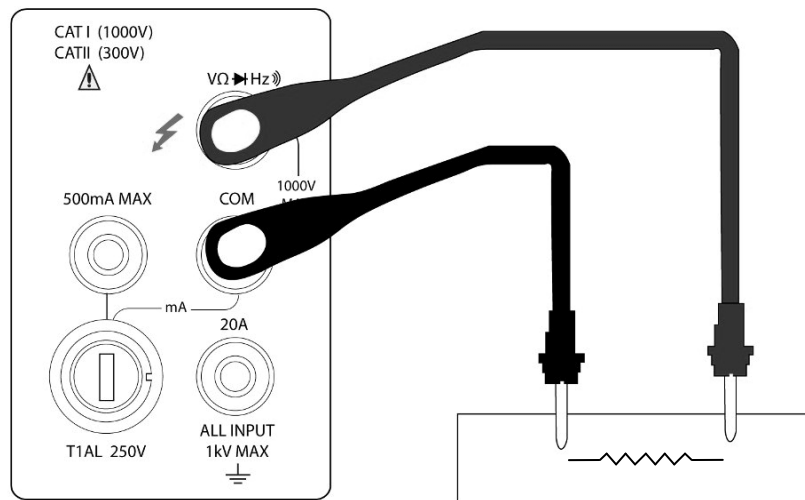

Figure 3-5 Continuity Measurement

Note: Source current flows from the $V\Omega \rightarrow \rightarrow$ to COM terminals.

3.7 Testing Diode

The multimeter can also be used to measure the forward voltage drop of general-purpose diodes and the zener voltage of zener diodes. A current range of 0.5 mA will be selected for diode measurement.

Note: Diode test uses medium reading rate and is fixed.

3.7.1 Connections

Assuming the multimeter is under factory default conditions, the basic procedure to test a diode is as follows:

1. Connect test leads to $V\Omega \rightarrow \rightarrow$ and COM terminals.
2. Press \rightarrow for diode measurement function.
3. Connect test leads to the diode under test as shown in Figure 3-6.
4. Take a reading from the display.

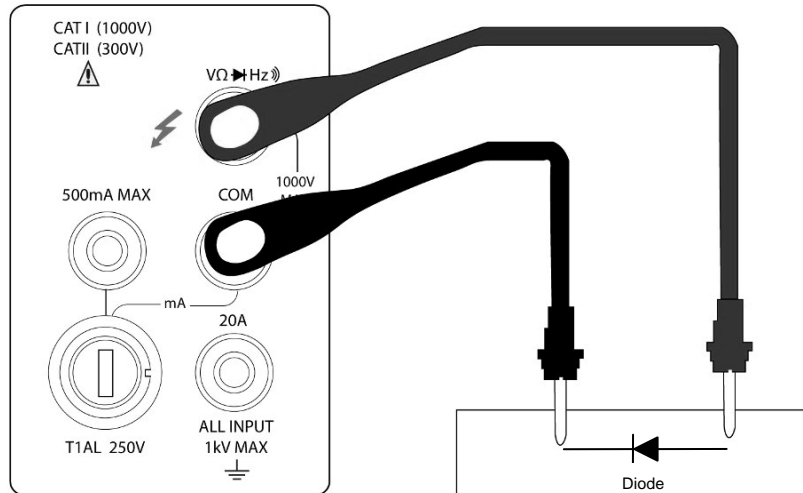

Figure 3-6 Diode Measurement

Note: Source current flows from the $V\Omega Hz$ to COM terminals

3.8 Measuring True RMS AC+DC

The multimeter can measure the True RMS value of AC+DC voltages or currents (**available in manual range mode only**).

When $\overline{AC+DC}$ is pressed, the multimeter will measure the dc and ac signals respectively and then calculate and display the AC+DC RMS value by using the following formula:

$$(AC + DC)RMS = \sqrt{dc^2 + ac^2}$$

3.8.1 Connections

Assuming the multimeter is under factory default conditions, the basic procedure to measure true RMA AC+DC is as follows:

1. Connect test leads to $V\Omega Hz$ and COM terminals, as shown in Figure 3-7.
2. Press \overline{DCV} , \overline{ACV} , $\overline{Shift} \rightarrow \overline{DCV}$ or $\overline{Shift} \rightarrow \overline{ACV}$ to select a voltage or current measurement
3. Press $\overline{AC+DC}$ for true RMS measurement function.
4. Press $\overline{Shift} + \overline{Rate}$ to turn on a 2nd display
5. Press $\overline{\leftarrow}$ or $\overline{\rightarrow}$ to select a 2nd parameter available.
6. Take a reading from the display.

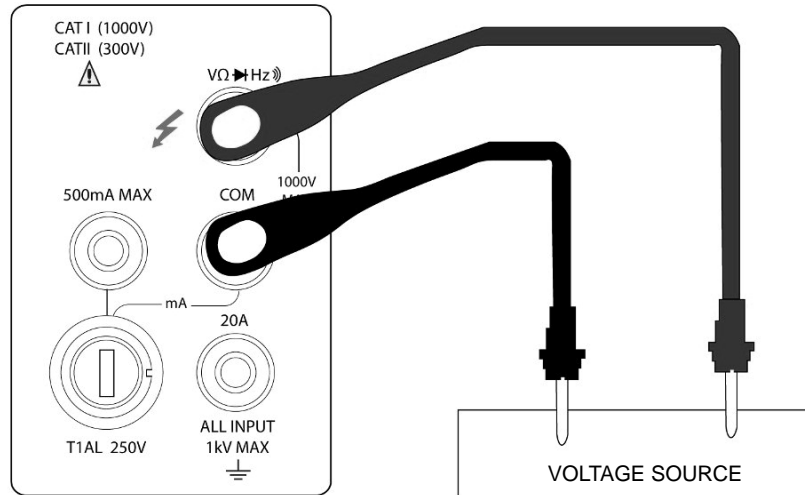

DC+AC RMS volt measurement

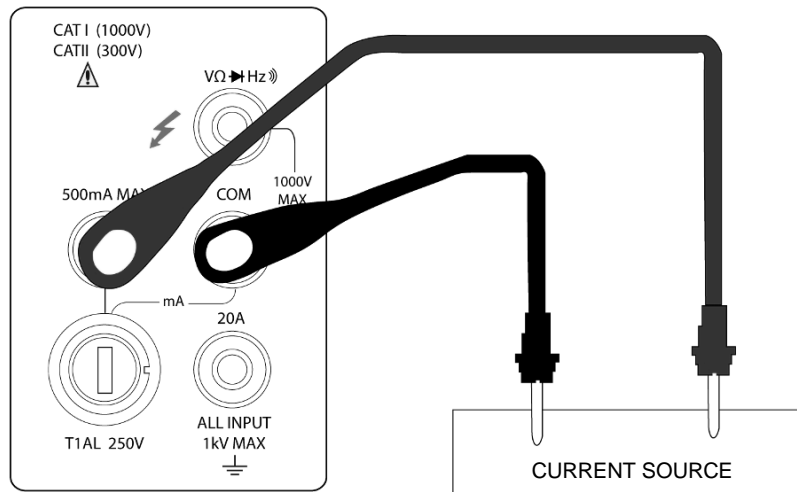

DC+AC RMS current measurement

Figure 3-7 True RMS value of AC+DC voltages and currents Measurement

3.8.2 Using the 2nd parameter display

The 2nd display is one of the most useful features designed in to the multimeter. Users may read two different parameters at the same time.

The available 2nd display parameters under different main measurement functions are listed in Table 3-2.

Table 3-2 Available 2nd display parameters for different measurement functions

Primary Display	Secondary Display				
	<div style="display: flex; justify-content: space-between; align-items: center;"> ▶ ◀ </div>				
DC V	AC V	dBm	dB	Hz	
AC V	DC V	dBm	dB	Hz	
DC V+AC V	dBm	dB	Hz	AC V	DC V
DC I	AC I	Hz			
AC I	DC I	Hz			
DC I+AC I	Hz	AC I	DC I		
Hz	AC V/AC I	AC I/AC V			
Percentage (%) (Measuring value)	%				
Comp (Measuring value)	HI, IN, LO, PASS, FAIL				
Max/Min (Measuring value)	Max		Min		

Note: When a 2nd parameter is displayed, the measurement range for that measurement is based on the main measurement function (primary display).

3.9 Math Functions

The multimeter math operations are divided into three categories:

- Percent
- dB and dBm calculations
- Limit testing

The first two categories are discussed here; reading limit testing will be described in the following chapter – “Measurement Options”.

3.9.1 Percent

If the percent calculation is selected, a reference value must be specified. The displayed reading will be expressed as percent deviation from the reference value. The percentage calculation is performed using the following formula:





$$Percent = \frac{Input - reference}{reference}$$

Where:













- Input is the normal display reading
- Reference is the user-entered constant
- Percent is the displayed result

To configure the percent calculation, perform the following steps:

1. Press **Shift** → **Rel** for percent math operation and the present reference value displays:
+1.00000λ

2. Use  and  keys to choose a numerical place and use  and  keys to increment or decrement the digits. Enter a value and units prefix.
3. Press  (ENTER) to confirm the reference value. The message “**SAVED**” will be displayed for a moment.
4. The meter will then display the result of the percent calculation.

If you want to change the parameter values when the percent math function is enabled, besides the above method you can do the following:

1. Press  →  to enter the menu. On the menu level, “**A: MATH MEU**” will be displayed.
2. Press  to move down to the command level within the MATH MEU, “**3: PERC REF**” will be displayed.
3. Press  to enter the parameter level, and the present reference value will be displayed:
+1.00000λ.
4. Use  and  keys to choose a numerical place and use  and  keys to increment or decrement the digits. Enter a value and units prefix.
5. Press  (ENTER) to confirm the reference value, “**SAVED**” will be displayed for a moment, and the meter will return to the command level. Press  to cancel the reference value input, and the meter will return back to the command level without changing the reference value.
6. Press  →  key to exit the menu and return to the percent math operation status.

The meter will display measurement result based on calculation using the above formula. If the value of “Input” is larger than that of “Reference”, displayed result will be positive; contrarily, it will be negative if the value of “Input” is smaller than that of “Reference”.

3.9.2 dB Calculation

Expressing DC and AC voltage in dB makes it possible to compress a large range of measurements into a much smaller scope. The relationship between dB and voltage is defined by the following equation:

$$dB = 20 \log \frac{V_{IN}}{V_{REF}}$$

Where: V_{IN} is the DC or AC input signal.

V_{REF} is the specified voltage reference level

The instrument will read 0dB when the reference voltage level is applied to the input.

If a relative value is in effect when dB is selected, the value is converted to dB then REL is applied to dB. If REL is applied after dB has been selected, dB has REL applied to it.

To set the reference voltage, perform the following steps:

1. Press **Shift** + **AC+DC** for dB math operation and the present reference value is displayed:
R.F: +0.00000
2. Use **◀** and **▶** keys to choose a numerical place and use **▲** and **▼** keys to increment or decrement the digits. Enter a value and units prefix.
3. Press **Auto** (ENTER) to confirm the reference voltage, the message “**SAVED**” will be displayed for a moment. Then the meter will return back to the measurement status.
4. The display will now show result of the dB calculation.

If you want to change the parameter values when dB function is in effect, you can do the following:

1. Press **Shift** → **Esc** to enter the menu on the menu level, “**A: MATH MEU**” will be displayed.
2. Press **▼** to move down to the command level within the MATH MEU, “**4: dB REF**” will be displayed.
3. Press **▼** to enter the parameter level, and the present reference value will be displayed:
R.F: +1.00000λ.
4. Use **◀** and **▶** keys to choose a numerical place and use **▲** and **▼** keys to increment or decrement the digits. Enter a value and units prefix.
5. Press **Auto** (ENTER) to confirm the reference value, the message “**SAVED**” will be displayed for a moment, and the meter will return to the command level. Press **Esc** to cancel the reference value input, and the meter will return back to the command level without changing the reference value.
6. Press **Shift** → **Esc** key to exit the menu and return to the dB math operation status.

Note: *The dB calculation takes the absolute value of the ratio V_{IN}/V_{REF} . The largest negative value of dB is -160 dB. This will accommodate a ratio of $V_{IN} = 1 \mu V$, $V_{REF} = 1000 V$.*

3.9.3 dBm Calculation

dBm is defined as decibels above or below a 1 mW reference. With user-programmable reference impedance, the meter reads 0 dBm when the voltage needed to dissipate 1 mW through the reference impedance is applied. The relationship between dBm, reference impedance, and the voltage is defined by the following equation:

$$dBm = 10 \log \frac{(V_{IN}^2 / Z_{REF})}{1mW}$$

Where: V_{IN} is the DC or AC input signal.

Z_{REF} is the specified reference impedance.

If a relative value is in effect when dBm is selected, the value is converted to dBm then REL is applied to dBm. If REL is applied after dBm has been selected, dBm has REL applied to it.

To set the reference impedance, perform the following steps:

1. Press **Shift** → **dBm** for dBm math operation and the present reference value is displayed:
REF: 0000
2. Use **Left Arrow** and **Right Arrow** keys to choose a numerical place and use **Up Arrow** and **Down Arrow** keys to increment or decrement the digits. Enter a value from 1 Ω to 9999 Ω .
3. Press **Auto** (ENTER) to confirm the reference impedance, the message “**SAVED**” will be displayed for a moment. The meter will then return back to the measurement status.
4. The display will show the result of the dBm calculation.

If you want to change the impedance reference value after the dBm function is enabled, you can do the following:

1. Press **Shift** → **Esc** to enter the menu on the menu level. “**A: MATH MEU**” will be displayed.
2. Press **Down Arrow** to move down to the command level within the MATH MEU, “**5: dBm REF**” will be displayed.
3. Press **Down Arrow** to enter the parameter level and the present impedance reference value will be displayed: REF: 0000.
4. Use **Left Arrow** and **Right Arrow** keys to choose a numerical place and use **Up Arrow** and **Down Arrow** keys to increment or decrement the digits. Enter a value from 1 Ω to 9999 Ω .
5. Press **Auto** (ENTER) to confirm the reference value, the message “**SAVED**” will be displayed for a moment, and the meter will return to the command level. Press **Esc** to cancel the reference value input, and the meter will return back to the command level without changing the reference value.
6. Press **Shift** → **Esc** key to exit the menu and return to the dB math operation status.

NOTE: *The reference impedance and input impedance mentioned in this chapter are completely different. The Input impedance is inherent to the instrument and cannot be changed.*

NOTE: *dBm is valid for both positive and negative DC voltage.*

NOTE: *The percent math operations are applied after the dBm or dB math calculation.*

Chapter 4 Measurement Options

This chapter provides description of the front panel features of the multimeter. For those measurement options accessible only by a remote interface, refer to Chapter 5 and 6. This chapter is organized as follows:

- **Measurement Configuration** – Describes Ranging, Relative readings, Digits of Resolution and Measurement rate
- **Triggering operations** – Explains trigger sources
- **MAX and MIN operations** – Records the minimum and the maximum input signals
- **Limit operations** – Defines how to set reading limits
- **System Operations** – Provides details on Beep setup, Baud rate setup, Terminal character setup and key sound setup up

4.1 Measurement configuration

The following paragraphs discuss configuring multimeter for making measurement.



4.1.1 Range

You can let the multimeter automatically select the range using auto ranging or you can select a fixed range using manual ranging. Auto ranging is convenient because the multimeter automatically selects the appropriate range for each measurement. However, you can use manual ranging for faster measurements since the multimeter does not have to determine which range to use for each measurement. The multimeter returns back to auto ranging when power has been off or after a remote interface reset.

Maximum readings

The full scale readings for every range on each function are 5% over range except for the 1000 VDC, 750 VAC and diode test ranges.

Manual ranging





To select a range, simply press  or  key. The instrument changes one range per key press. The selected range is displayed for a moment.

If the instrument displays the “OVL.D” message on a particular range, select a higher range until a reading is displayed. Use the lowest range possible that can display a reading to ensure best accuracy and resolution.

Auto ranging

To enable auto ranging, press  key. The **AUTO** annunciator turns on when auto ranging is selected. While auto ranging is selected, the instrument automatically chooses the best range to measure the

applied signal. However, auto ranging should not be used when optimum speed is required. Note that up-ranging and down-ranging occurs at 5% of normal range.

To cancel auto ranging, press  or  or  key. Pressing  to cancel auto ranging leaves the instrument in its present manual range.

The  key has no effect on the continuity and diode test functions.

4.1.2 Relative



The relative operation could be used to null offsets or subtract a baseline reading from present and future readings. When relative function is enabled, the multimeter uses the present reading as a relative value. Subsequent readings will be the difference between the actual input value and the relative value.

You can define a relative value for each function. Once a relative value is set for a measurement function, the value is the same for all ranges. For example, if 2 V is set as a relative value on the 20 V range, the relative is also 2 V on the 1000 V, 100 V, 1 V or 100 mV ranges. For model 5491B, if 2 V is set as relative value on the 50 V range, the relative is also 2 V on the 1000 V, 500 V, 5 V or 500 mV ranges.

Additionally, when you perform a zero correction for DCV, Ω measurements by enabling REL, the displayed offset becomes the reference value. Subtracting the offset from the actual input zeroes the display, as follows:

$$\text{Displayed reading} = \text{Actual Input} - \text{Reference}$$

Select a range that cannot accommodate the relative value does not cause an overflow condition, but it also does not increase the maximum allowable input for that range. For example: on the 2 V range, model 2831E still overflows for a 2.1 V input. For model 5491B, on the 5 V range it will still overflow for a 5.1 V input.

To set a REL value, press  when the display shows the value you want as the relative value. The REL annunciator turns on. Press  a second time to disable REL.

4.1.3 Rate

The RATE operation sets the integration time of the A/D converter, the period of time the input signal is measured. The integration time affects the usable digits, the amount of reading noise, as well as the reading rate of the instrument.

In general, the fastest integration time (FAST set from the front panel or remote interface) results in increased reading noise and fewer usable digits (resolution), while the slowest integration time provides the best common-mode and normal-mode rejection and more usable digits. Depending on the selected rate, user will have to compromise between speed or noise, as well as resolution.

The RATE parameters are explained as follows:

Fast

FAST sets speed to 25 readings per second. Use FAST, if speed is of primary importance, however it is at the expense of increased reading noise and fewer usable digits (resolution).

Medium

Medium sets speed to 10 readings per second. Use Medium to achieve a balance between noise performance and speed.

Slow

Slow sets speed to 5 readings per second. SLOW provides better noise performance and resolution at the expense of speed.

Note: *The integration time can be set for any measurement function except frequency, period, continuity (fixed at FAST rate) and diode test (fixed at Medium rate). For frequency and period, this value is little excess a gate time.*

4.2 Trigger Operations

The multimeter's triggering system allows you to generate triggers either manually, automatically or externally, and take multiple readings per trigger. The following paragraphs discuss front panel triggering, and the reading hold feature.

4.2.1 Trigger procedure

Wait for Trigger



The control source holds up operation until the programmable event occurs and is detected. See description below for trigger sources:

- Immediate





With this trigger source, event detection is immediately satisfied allowing operation to continue.







- External

Event detection is satisfied for both kinds of triggers as below:

1. A bus trigger (*TRG) command is received.
2. The front panel  key is pressed (The multimeter must be taken out of remote before it will respond to  key).





Take steps below for trigger settings:

1. Press  →  to enter the menu on the menu level. "A: MATH MEU" will be displayed.
2. Use  or  key to move across to the TRIG MEU on the menu level. "B: TRIG MEU" will be displayed.
3. Press  to move down to the command level within the TRIG MEU.

4. Use  or  key to move across to the TRIG MODE command on the command level. "1: TRIG MOD" will be displayed.
5. Press  to move down a level to select a trigger source.
6. Using  or  to select between IMM, MAN or BUS trigger source.
7. Press  (ENTER) to confirm the selection. The message "SAVED" will be displayed to show that the change is now in effect. The multimeter automatically exits the parameter level and moves up a level to the command level.

4.2.2 Reading Hold





Reading hold function is used to hold a reading on the display indefinitely. To hold a reading, do the following:

1. Press  +  to hold the reading on the display at any time. To un-hold the reading and return to normal operation, press  +  again.

4.3 MAX / MIN

"MAX / MIN" function enables the multimeter to record the minimum and the maximum readings. If "MAX / MIN" function is enabled, the 2nd parameter indicates the latest maximum or minimum reading.

Use the following procedure to turn on the **MAX / MIN** operation:

1. Press  to enable the **MAX / MIN** function
2. Use  or  key to switch between MAX and MIN.
3. Press  key again to disable the MAX/MIN function.

4.4 Limit Operations

Limit operations set and control the values that determine the HI / IN / LO status of subsequent measurements. Limits can be applied to all measurement functions except continuity. Unit prefixes are applied before the limit test, for example:

Low Limit = -1.0, High Limit = 1.0
 A 150 mV reading equals 0.15 V (IN).

Low Limit = -1.0, High Limit = 1.0
 A 0.6 kΩ reading equals 600 Ω (HI)

You can configure the multimeter to beep or not when readings are outside of the limit range.

4.4.1 Enabling limits

Use the following procedure to turn on the limit operation:

1. Press **Shift** → **Max/Min** to enable or disable LIMIT TEST function.

4.4.2 Setting Limit Values

Use the following steps to enter high and low limit values:

1. Press **Shift** → **Esc** to enter the menu on the menu level.
2. Use **←** or **→** key to move across to the MATH MEU on the menu level, "**A: MATH MEU**" will be displayed.
3. Press **▼** to move down to the command level within the MATH MEU.
4. Use **←** or **→** key to move across to the HIGH LIMIT command, "**1: HI LIMIT**" will be displayed.
5. Press **▼** to move down a level to input the high limit value. The present high limit value will be displayed:
HI: +1.00000λ
6. Use **←** and **→** keys to choose a numerical place and use **▲** and **▼** keys to increment or decrement the digits. Enter an expected value for high limit.
7. Press **Auto** (ENTER) to confirm the value of high limit. The message "**SAVED**" will be displayed to show that the change is now in effect. The multimeter will exit the parameter level and move up a level to the command level.
8. Use **←** or **→** key to move across to the LOW LIMIT command, "**2: LO LIMIT**" will be displayed.
9. Press **▼** to move down a level to input the low limit value. The present low limit value will be displayed:
LO: -1.00000λ
10. Use **←** and **→** keys to choose a numerical place and use **▲** and **▼** keys to increment or decrement the digits. Enter an expected value for low limit.
11. Press **Auto** (ENTER) to confirm the value of low limit. The message "**SAVED**" will be displayed to show that the change is now in effect. The meter will exit the parameter level and move up a level to the command level.
12. Press **Shift** → **Esc** key to exit from the menu and return to the measurement status.

4.5 System Operations

The multimeter has some other operations: Beeper control, key sound control, Baud rate control and

Terminal character setup. The information is not directly related to making measurements but is an important part of operating the multimeter.

4.5.1 Beeper Control

Normally, the multimeter will emit a tone whenever certain conditions are met. For example: the multimeter will beep when a stable reading is captured in reading hold. You may want to disable the beeper for certain applications.

- When you disable the beeper, the multimeter will not emit a tone when:
 1. A limit is exceeded in a limit test
 2. A stable reading is captured in reading hold.
- Disabling the beeper has no effect on the tone generated when:
 1. An internal error is generated.
 2. The continuity threshold is exceeded.
 3. A front panel key is pressed.
- The beeper state is stored in non-volatile memory and does not change when power has been off or after a reset. The beeper is enabled when the multimeter is shipped from the factory.

Use the following steps to change the beeper's state:

1. Press **Shift** → **Esc** to enter the menu on the menu level, "**A: MATH MEU**" will be displayed.
2. Use **Left Arrow** or **Right Arrow** key to move across to the SYS MEU on the menu level, "**C: SYS MEU**" will be displayed.
3. Press **Down Arrow** to move down to the command level within the SYS MEU.
4. Use **Left Arrow** or **Right Arrow** key to move across to the BEEP command, "**1: BEEP STA**" will be displayed.
5. Press **Down Arrow** to move down a level to set the beeper control.
6. Use **Left Arrow** or **Right Arrow** key to select ON or OFF.
7. Press **Auto** (ENTER) to confirm the beeper control. The message "SAVED" will be displayed to show that the change is now in effect. The multimeter will exit the parameter level and move up a level to the command level.
8. Press **Shift** → **Esc** key to exit from the menu and return to the measurement status.

4.5.2 Baud rate

The baud rate is the rate at which the digital multimeter and the computer communicate. Choose one of these available rates:

- 38.4k
- 19.2k
- 9600
- 4800
- 2400

- 1200
- 600

Note: *Factory default baud rate is 9600.*

Before you choose a baud rate, make sure the programming terminal on a computer that will be used to connect to the instrument supports the baud rate you selected. Both the digital multimeter and the computer must be configured for the same baud rate.

Perform the following steps to select a baud rate



1. Press **Shift** → **Esc** to enter the menu on the menu level, "**A: MATH MEU**" will be displayed.
2. Use **Left Arrow** or **Right Arrow** key to move across to the SYS MEU on the menu level, "**C: SYS MEU**" will be displayed.
3. Press **Down Arrow** to move down to the command level within the SYS MEU, "**1: BEEP STR**" will be displayed.
4. Use **Left Arrow** or **Right Arrow** key to move across to the baud rate command, "**2: BAUD RAT**" will be displayed.
5. Press **Down Arrow** to move down a level to set the baud rate.
6. Use **Left Arrow** or **Right Arrow** key to select a baud rate.
7. Press **Auto** (ENTER) to confirm the selection. The message "**SAVED**" will be displayed to show that the change is now in effect. The multimeter will exit the parameter level and move up a level to the command level.
8. Press **Shift** → **Esc** key to exit from the menu and return to the measurement status.

4.5.3 Selecting the Terminal Character

The instrument has two kinds of terminal characters: <LF> (Line Feed) and <CR> (Carriage Return).

Perform the following steps to select the terminal characters:

1. Press **Shift** → **Esc** to enter the menu on the menu level, "**A: MATH MEU**" will be displayed.
2. Use **Left Arrow** or **Right Arrow** key to move across to the SYS MENU on the menu level, "**C: SYS MEU**" will be displayed.
3. Press **Down Arrow** to move down to the command level within the SYS MEU, "**1: BEEP STA**" will be displayed.
4. Use **Left Arrow** or **Right Arrow** key to move across to the terminal character command, "**3: TX TERM**" will be displayed.
5. Press **Down Arrow** to move down a level to set the terminal character.
6. Use **Left Arrow** or **Right Arrow** key to select a terminal character.













7. Press  (ENTER) to confirm the selection. The message “**SAVED**” will be displayed to show that the change is now in effect. The multimeter will exit the parameter level and move up a level to the command level.
8. Press  →  key to exit from the menu and return to the measurement status.

4.5.4 Key Sound

The multimeter has a key sound function and you can enable or disable it. The key sound state is stored in non-volatile memory and does not change when power has been off after a reset.

Note: *Factory default key sound is enabled.*

Use the following steps to change key sound setting:

1. Press  →  to enter the menu on the menu level, “**A: MATH MEU**” will be displayed.
2. Use  or  key to move across to the SYS MEU on the menu level, “**C: SYS MEU**” will be displayed.
3. Press  to move down to the command level within the SYS MEU, “**1: BEEP STA**” will be displayed.
4. Use  or  key to move across to the KEY SONG command, “**5: KEY SONG**” will be displayed.
5. Press  to move down a level to enable or disable the key sound.
6. Use  or  key to turn ON or turn OFF the key sound.
7. Press  (ENTER) to confirm the selection. The message “**SAVED**” will be displayed to show that the change is now in effect. The multimeter will exit the parameter level and move up a level to the command level.
8. Press  →  key to exit from the menu and return to the measurement status.

Chapter 5 Remote Operation

Besides the front panel control, the multimeter provides a USB interface and RS232 interface (model 5491B only) for remote control. Standard Commands for Programmable Instruments (SCPI) is fully supported to communicate with computer via the serial interface.

5.1 USB & RS232

You can connect the USB interface or RS232 interface (Model 5491B only) to a computer. To do so, please note the following:

- You must define the baud rate, parity, start bit, and stop bit (the USB interface is a virtual COM, therefore it behaves like a RS232 serial port). Settings automatically will apply for RS232 port also.
- You must use the SCPI programming language

5.2 Serial Interface Operation

The instrument provides various remote commands. All operations from the front panel can be performed by a computer via the USB interface.

5.2.1 USB interface configured as virtual COM RS232 interface

The USB interface in the rear panel of the instrument is a virtual COM port and behaves like a RS232 interface. This means that it can be connected to a USB port on a PC, and with the USB drivers installed the PC will detect it as a serial COM port just like a RS232 serial port. In Windows, the PC will automatically assign a COM port to the USB connection upon successful USB driver installation. Use this COM port and configure the Baudrate, Parity, Start bit, and Stop bit settings as you would for RS232 communication. The settings will also apply to the RS232 port on model 5491B.

5.2.2 Sending and receiving data

The multimeter transfers data using 8 data bits, 1 stop bit, and no parity. Each program message that is transmitted to the controller is terminated with <LF> or <CR>. Refer to section 4.5.3 for details on configuring the termination character setting.

5.2.3 Selecting Baud Rate

The baud rate is the rate at which the multimeter and the computer communicate. Choose one of these available rates:

- 38.4k
- 19.2k
- 9600
- 4800
- 2400
- 1200

■ 600

Note: *Factory default baud rate is 9600.*

Refer to section 4.5.2 for details on configuring baud rate settings on the multimeter.

5.2.4 Software Protocol

Please refer to the content below before programming application software.

1. For command syntax and format, refer to Chapter 6 Command Reference.
2. The controller transmits the command using the ASCII code with <LF> or <CR> as the termination character. The multimeter executes the command after the termination character is received.
3. The character received by the multimeter will be sent back to the controller again. The controller will not send the next character until the last returned character is received correctly from the meter. If the controller fails to receive the character sent back from the meter, the possible reasons are listed as follows:
 - The serial interface is not connected correctly.
 - Check if the same baud rate is selected for both the meter and the controller.
 - When the meter is busy with executing a bus command, it will not accept any character from the serial interface at the same time. So the character sent by controller will be ignored. In order to make sure the whole command is sent and received correctly, the character without a return character should be sent again by the controller.
4. The multimeter only sends information under following two conditions. The first is when a character is received normally; the meter will send the character back as a handshake. The second is when a query command is received; the meter will send the query response information.
5. Once a query command is received, the meter will send the query response information immediately even if the rest of the commands have not been finished. So if the command includes two queries, the controller should read the query responses twice. One query is recommended to be included in a single command.
6. A query response is sent out in ASCII codes with the preset termination character.
7. For some commands that will take longer time to execute, for example reset command, the controller should keep waiting to avoid the next command being lost when the meter is executing the former command.

Please refer to Chapter 8 for serial interface programming examples.

5.3 Data Format

The meter outputs the measurement results using the ASCII character string format via the RS232 serial interface. The data format is described in the following Figure 5-3.

<p>SD.DDDDDDESDDD<NL> S: +/- D: number 0 to 9 E: exponent sign (“+”is omitted) <NL>: New Line, ASCII code is 10</p>

Figure 5-3 Data Format

Chapter 6 SCPI Command Reference

This chapter provides descriptions of all available remote communication commands which correspond to Standard Commands for Programmable Instruments (SCPI) command sets. Use this chapter as a reference.

6.1 Command structure

Commands are divided into two types: common commands and SCPI commands. The common commands are defined in IEEE std. 488.2-1987, and these commands are common for all devices. Not all commands are supported by the multimeter. The SCPI commands are used to control all of the meter's functions. They are tree structured with three levels of depth. (The highest level commands are called the subsystem commands in this manual.) So the lower level commands are legal only when the subsystem commands have been selected. A colon (:) is used to separate the higher level commands and the lower level commands. See Figure 6-1 as an example.

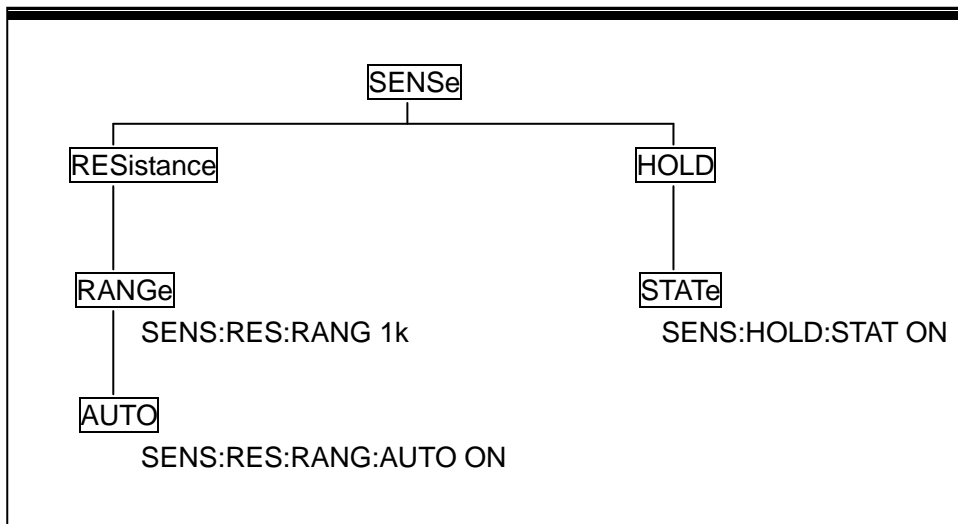

Figure 6-1 Command Tree Example

6.2 Command Syntax

The information in this section covers the syntax for both common commands and SCPI commands.

6.2.1 Commands and command parameters

Common commands and SCPI commands may or may not require specifying a parameter. The following are some examples:

*RST	No parameter used
:FORMat <name>	Parameter<name> required
:IMMediate	No parameter used

Commands that require a parameter input must have a space in between the command and the parameter.

- Brackets []: Some command words are enclosed in brackets. These brackets are used to denote an optional command word that does not need to be included in the program message. For example:

:RANGe[:UPPer] <n>

These brackets indicate that :UPPer is optional and does not have to be used. Thus, the above command can be sent in one of the two ways below:

:RANGe <n>
or :RANGe:UPPer <n>

NOTICE: When using optional command words in your program, do not include the brackets.

- Angle brackets <>: Angle brackets are used to denote a parameter type. Do not include the brackets in the program message. For example:

:HOLD:STATe

The indicates that a Boolean-type parameter is required. Thus, to enable the HOLD feature, you must send the command with ON or 1 parameter as below:

:HOLD:STATe ON
or :HOLD:STATe 1

- Parameter types: The following are some of the common parameter types:
 Boolean: Used to enable or disable an instrument operation. 0 or OFF disables the operation and 1 or ON enables the operation. Example:

:CURRent:AC:RANGe:AUTO ON Enables auto ranging

<name> Name parameter: Select a parameter name from a listed group. Example:

<name> = MOVing
REPeat

:RESistance:AVERage:TCONtrol MOVing

<NRf> Numeric Representation format: This parameter is a number that can be expressed as an integer (e.g., 6), a real number (e.g., 25.3) or an exponent (e.g., 5.6E2). Example:

:MMFactor 5

<n> Numeric value: A numeric value parameter can consist of a NRf number or one of the following name parameters: DEFault, MINimum, MAXimum. When DEFault parameter is used, the instrument is programmed to the *RST default value. When the MINimum parameter is used, the instrument is programmed to the lowest allowable value. When the MAXimum parameter is used, the instrument is programmed to the largest allowable value. Examples:

```
:CURRent[:DC]:NPLCycles 1
:CURRent[:DC]:NPLCycles DEFault
:CURRent[:DC]:NPLCycles MINimum
:CURRent[:DC]:NPLCycles MAXimum
```

6.2.2 Short-form Rules

Use the following rules to determine the short-form version of any SCPI command:

- If the length of the command word is four letters or less, no short form version exists. Example:
:AUTO =:AUTO
- These rules apply to command words that exceed four letters:
- If the fourth letter of the command word is a vowel, delete it and all the letters after it. Example:
:immediate =:imm
- Rule exception – The short form version of the following command uses only the first two letters of the word.
:TCouple = :tc
- If the fourth letter of the command word is a consonant, retain it but drop all the letters after it. Example:
:format = :form
- If the command contains a question mark (? for query) or a non-optional number included in the command word, you must include it in the short-form version. Example:
:delay? = :del?
- Command words or characters that are enclosed in brackets ([]) are optional and need not be included in the program message.

6.2.3 Basic Rules of Command Structure

- Letter case (upper and low) is ignored.
For example:
FUNC:VOLT:DC = func:volt:dc = Func:Volt:Dc
- Spaces (“_” is used to indicate a space) must not be placed before and/or after the colon (:).
For example:
(wrong) FUNC:_VOLT:DC
(right) FUNC:VOLT:DC
- The command can be completely spelled out or in abbreviated type. (In the following description, short form will be printed in upper case.)
For example:
FUNCTION: VOLTAGE:DC = FUNC:VOLT:DC

- The command header should be followed by a question mark (?) to generate a query for that command.
For example:
FUNC?

6.2.4 Multiple Command Rules

The semicolon (;) can be used as a separator to execute multiple commands on a single line. The multiple command rules are as follows.

- Commands at the same level and in the same subsystem command group can be separated by a semicolon (;) on a multiple command line.
For example:
:RESistance:NPLCycle <n>;NPLCycles ?
- To restart commands from the highest level, a semicolon (;) must be used as the separator, and then a leading colon (:), which shows that the restarted command is a command at the top of the command tree, must follow.
For example:
:RESistance:NPLCycle <n>; :RESistance:NPLCycles ?
- The common commands can restart only after a semicolon on a multiple command line.
For example,
:RESistance:NPLCycles<n>*IDN?

6.2.5 Command Path Rules

- Each new program message must begin with the root command, unless it is optional (e.g., FUNCTION). If the root is optional, simply treat a command word on the next level as the root.
- The colon at the beginning of a program message is optional and need not be used. Example:
:DISPlay:ENABle = DISPlay:ENABle
- When the path pointer detects a colon(;), it moves down to the next command level.
- When the path pointer detects a colon (:) after a semicolon (;), it resets back to the root level.
- The path pointer can only move down. It cannot be moved up a level. Executing a command at a higher level requires that you start over at the root command.

6.3 Command Reference

The multimeter provides the following subsystem commands:

◆ DISPlay ◆ FUNCtion ◆ VOLTage ◆ CURRent ◆ RESIstance ◆ FREQuency
◆ PERiod ◆ HOLD ◆ TRIGer ◆ FETCh ◆ SYSTem

The meter also supports following common commands:

◆ *RST ◆ *TRG ◆ *IDN

6.3.1 DISPlay subsystem

The DISPlay subsystem commands are mainly used to control the display of the multimeter and are summarized in Table 6-2.

Table 6-1 DISPlay Subsystem Commands Summary

Command	Function Description
:DISPlay :ENABle :ENABle?	Enable or disable front panel display Query state of the display

**:ENABle **

Command syntax:

:DISPlay:ENABle

Command Parameter:

 = 0 or OFF Disable front panel display
 1 or ON Enable front panel display

Query:

:ENABle? Query state of the display

Description:

This command is used to enable or disable front panel display circuitry. When disabled, the instrument operates at a higher speed. While disabled, the display is frozen. All front panel controls except LOCAL are disabled. Normal display operation can be resumed by using:ENABle command or pressing LOCAL key to enable the display.

6.3.2 FUNCTION subsystem

The commands in this subsystem are used to configure the measurement function subsystems and are summarized in Table 6-2.

Table 6-2 FUNCTION Subsystem Commands Summary

Commands	Selectable Functions
:FUNCTION <name>	Select measurement function: VOLTage:AC, VOLTage:DC, RESistance, CURRent:AC, CURRent:DC, FREQuency, PERiod, DIODE, CONTInuity.
:FUNCTION?	Query Function

:FUNCTION Command

:FUNCTION <name>

Command syntax:

:FUNCTION <name>

Command Parameter:

<name> =	VOLTage:AC	Select AC Voltage
	VOLTage:DC	Select DC Voltage
	CURRent:AC	Select AC Current
	CURRent:DC	Select DC Current
	RESistance	Select 2-wire Resistance
	FREQuency	Select Frequency
	PERiod	Select Period
	DIODE	Select Diode Testing
	CONTInuity	Select Continuity Testing

Query:

:FUNCTION? Query currently selected function

Description:

This command is used to select the measurement function of the instrument.

Each measurement function “remembers” its own unique setup configuration, such as range, speed, filter and rel. This eliminates the need to re-program setup conditions every time you switch from one function to another.

6.3.3 VOLTage subsystem

The commands in this subsystem are used to configure and control voltage measurement function and are summarized in Table 6-3.

Table 6-3 VOLTage Subsystem Commands Summary

Command	Function Description	Default
:VOLTage:DC :NPLCycles <n> :NPLCycles? :RANGe [:UPPer] <n> [:UPPer]? :AUTO <n> :AUTO? :REFerence <n> :STATe :STATe? :ACQuire :REFerence?	Path to configure DC voltage Set integration rate (*power line cycle: 0.1,1, or 10) Query power line cycle integration rate Path to configure measurement range Select range (0 to 1000) Query range Enable or disable auto range Query auto range (0 = OFF, 1 = ON) Specify reference (-1010 to 1010) Enable or disable reference Query state of reference (0,1) Use input signal as reference. Query reference value (Note: Prior to using this command, a reference must be enabled and reference must be specified. Otherwise, an error may occur)	1 1000 ON 1 0 OFF
:VOLTage:AC :NPLCycles <n> :NPLCycles? :RANGe [:UPPer] <n> [:UPPer]? :AUTO :AUTO? :REFerence <n> :STATe :STATe? :ACQuire :REFerence?	Path to configure AC voltage Set integration rate (*power line cycles: 0.1,1, or 10) Query line cycle integration rate Path to set measurement range Select range (0 to 750) Query range Enable or disable auto range Query auto range specify reference (-757.5 to 757.5) Enable or disable reference Query state of reference Use input signal as reference Query reference value (Note: Prior to using this command, a reference must be enabled and reference must be specified. Otherwise, an error may occur)	1 750 ON 0 OFF

*Fast = 0.1, Medium = 1, Slow = 10

Speed Commands

: NPLCycles <n>

Command Syntax:

- :VOLTage:AC:NPLCycles <n> Set NPLC for ACV
- :VOLTage:DC:NPLCycles <n> Set NPLC for DCV

Command Parameter:

<n> =	0.1, 1, 10	Set power line cycles per integration
DEFault	1	
MINimum	10	
MAXimum	0.1	

Query:

:NPLCycles? Query programmed NPLC value

Description:

The integration period (measurement speed) for the basic measurement functions (except Frequency and Period) is set using the:NPLCycles command. NPLC (Number of Power Line Cycles) expresses the integration period based on the power line frequency. For example, for a PLC of 1, the integration period in seconds would be 1/60 (for 60Hz line power) which is 16.67 ms.

:RANGe Commands

:[UPPer] <n>

Command syntax:

:VOLTage:AC:RANGe:[UPPer] <n> Set measurement range for ACV
:VOLTage:DC:RANGe:[UPPer] <n> Set measurement range for DCV

Command Parameter:

<n> =	0.2, 2, 20, 200, 750	Expected reading is AC volts (ACV)
	0.2, 2, 20, 200, 1000	Expected reading is DC volts (DCV)
DEFault	750 (ACV)	
	1000 (DCV)	
MINimum	0 (All functions)	
MAXimum	Same as DEFault	

Query:

:RANGe:[UPPer]? Query measurement range of the current function.

Description:

This command is used to manually select the measurement range for the specified measurement function. The range is selected by specifying the expected reading as an absolute value. Select the appropriate range to get the optimal reading of the measured device.

**:AUTO **

Command syntax:

:VOLTage:AC:RANGe:AUTO Set auto range for ACV
:VOLTage:DC:RANGe:AUTO Set auto range for DCV

Command parameter:

 =	1 or ON	Enable auto range
	0 or OFF	Disable auto range

Query:

:AUTO?	Query auto range (ON or OFF)
--------	------------------------------

Description:

These commands are used to control auto ranging. With auto ranging enabled, the instrument automatically goes to the most ideal range to perform the measurement.

The auto range command (:RANGe:AUTO) is coupled to the command that manually selects the measurement range (:RANGe <n>). When auto range is enabled, the parameter value for :RANGe <n> changes to the automatically selected range value. Thus, when auto range is disabled, the instrument remains at the automatically selected range. When a valid :RANGe <n> command is sent, auto ranging disables.

:REFerence <n> Commands

:REFerence <n>

Command syntax:

:VOLTage:AC:REFerence <n>	Specify reference for ACV
:VOLTage:DC:REFerence <n>	Specify reference for DCV

Command parameter:

<n> =	-757.5 to 757.5	Reference for ACV
	-1010 to 1010	Reference for DCV
	DEFault	0 (All measurement functions)
	MINimum	Minimum value for specified function
	MAXimum	Maximum value for specified function

Query:

:REFerence?	Query reference for relative function
-------------	---------------------------------------

Description:

These commands are used to establish a reference value for the specified function. When reference is enabled (:REFerence:STATe), the result will be the algebraic difference between the input signal and the reference value:

Reading = Input signal – Reference

From the front panel, reference is called relative (REL).

The :REFerence <n> command is coupled to the :ACQUIRE command. The last command sent (:REFerence <n> or :ACQUIRE) establishes the reference. When a reference is set using the :REFerence <n> command, the REFerence? query command returns the programmed value. Conversely, when a reference is set using the :ACQUIRE command, the :REFerence? query command returns the acquired reference value.

(Note: In order to send a REFerence? query, the reference value must be set either

by :REFerence <n> or :ACQuire command. If not, an error will occur in the return string.)

**:STATe **

Command syntax:

:VOLTage:AC:REFerence:STATe 	Control reference for ACV
:VOLTage:DC:REFerence:STATe 	Control reference for DCV

Command parameter:

 = 1 or ON	Enable reference
0 or OFF	Disable reference

Query:

:STATe? Query state of reference.

Description:

These commands are used to enable or disable “reference” for the specified function. When enabled, the displayed reading will include the programmed reference value. When disabled, the displayed reading will not include the reference value.

:ACQuire

Command syntax:

:VOLTage:AC:REFerence:ACQuire	Acquire reference for ACV
:VOLTage:DC:REFerence:ACQuire	Acquire reference for DCV

Description:

When one of these commands is sent, the measurement input signal is acquired and established as the reference value. This command is typically used to zero the display. For example, if the instrument is displaying a 1 μ V offset, sending this command and enabling reference zeroes the display.

This command is functional only if the instrument is on the specified measurement function. Sending this command while in any other function causes an error. Also, if the latest reading caused an overflow condition or a reading has not been triggered, an error occurs when this command is sent.

6.3.4 CURRent subsystem

The commands in this subsystem are used to configure and control current measurement function and are summarized in Table 6-4.

Table 6-4 CURRent Subsystem Commands Summary

Command	Function Description	Default
:CURRent:DC	Path to configure DC current	
:NPLCycles <n>	Set integration rate(*power line cycles: 0.1, 1, 10)	1
:NPLCycles?	Query line cycle integration rate	
:RANGe	Path to configure measurement range	
[:UPPer] <n>	Select range (0 to 20)	20
[:UPPer]?	Query range	
:AUTO 	Enable or disable auto range	ON
:AUTO?	Query auto range	
:REFerence <n>	Specify reference (-20 to 20)	0
:STATe 	Enable or disable reference	OFF
:STATe?	Query state of reference	
:ACQuire	Use input signal as reference	
:REFerence?	Query reference value	
:CURRent:AC	Path to configure AC voltage	
:NPLCycles <n>	Set integration rate (*power line cycles: 0.1, 1, 10)	1
:NPLCycles?	Query line cycle integration rate	
:RANGe	Path to set measurement range	
[:UPPer] <n>	Select range (0 to 20)	20
[:UPPer]?	Query range	
:AUTO 	Enable or disable auto range	ON
:AUTO?	Query auto range	
:REFerence <n>	specify reference (0 to 20)	0
:STATe 	Enable or disable reference	OFF
:STATe?	Query state of reference	
:ACQuire	Use input signal as reference	
:REFerence?	Query reference value	

*Fast = 0.1, Medium = 1, Slow = 10

Speed Commands

: NPLCycles <n>

Command Syntax:

- : CURRent:AC:NPLCycles <n> Set NPLC for ACI
- : CURRent:DC:NPLCycles <n> Set NPLC for DCI

Command Parameter:

<n> =	0.1, 1, 10	Set power line cycles per integration
	DEFault	1
	MINimum	10
	MAXimum	0.1

Query:

:NPLCycles? Query programmed NPLC value

Description:

The integration period (measurement speed) for the basic measurement functions (except Frequency and Period) is set using the :NPLCycles command. NPLC (Number of Power Line Cycles) expresses the integration period by basing it on the power line frequency. For example, for a PLC of 1, the integration period in seconds would be 1/60 (for 60Hz line power) which is 16.67 ms.

:RANGe Commands

:[UPPer] <n>

Command syntax:

: CURRent:AC:RANGe[:UPPer] <n>	Set measurement range for ACI
: CURRent:DC:RANGe[:UPPer] <n>	Set measurement range for DCI

Command Parameter:

<n> =	0 to 20	Expected reading is AC volts (ACI)
	-20 to 20	Expected reading is DC volts (DCI)
	DEFault	20 (ACI, DCI)
	MINimum	0 (All functions)
	MAXimum	Same as DEFault

Query:

:RANGe[:UPPer]? Query measurement range of the current function.

Description:

This command is used to manually select the measurement range for the specified measurement function. The range is selected by specifying the expected reading as an absolute value. The instrument will then go to the most sensitive range that will accommodate that expected reading. For example, if you expect a reading of approximately 10 mA, simply let the parameter <n> = 0.01 (or 10e-3) in order to select the 20 mA range.

**:AUTO **

Command syntax:

: CURRent:AC:RANGe:AUTO 	Set auto range for ACI
: CURRent:DC:RANGe:AUTO 	Set auto range for DCI

Command parameter:

 = 1 or ON	Enable auto range
0 or OFF	Disable auto range

Query:

:AUTO? Query auto range (ON or OFF)

Description:

These commands are used to control auto ranging. With auto ranging enabled, the instrument automatically goes to the most ideal range to perform the measurement.

The auto range command (:RANGe:AUTO) is coupled to the command that manually selects the measurement range (:RANGe <n>). When auto range is enabled, the parameter value for :RANGe <n> changes to the automatically selected range value. Thus, when auto range is disabled, the instrument remains at the automatically selected range. When a valid :RANGe <n> command is sent, auto ranging disables.

:REFerence <n> Commands

:REFerence <n>

Command syntax:

: CURRent:AC:REFerence <n>	Specify reference for ACI
: CURRent:DC:REFerence <n>	Specify reference for DCI

Command parameter:

<n> = -20 to 20	Reference for ACI
0 to 20	Reference for DCI
DEFault	0 (All measurement functions)
MINimum	Minimum value for specified function
MAXimum	Maximum value for specified function

Query:

:REFerence? Query reference for relative function

Description:

These commands are used to establish a reference value for the specified function. When reference is enabled (:REFerence:STATe), the result will be the algebraic difference between the input signal and the reference value:

Reading = Input signal – Reference

From the front panel, reference is called relative (REL).

The:REFerence <n> command is coupled to the :ACQuire command. The last command sent (:REFerence <n> or :ACQuire) establishes the reference. When a reference is set using the :REFerence <n> command, the REFerence? query command returns the programmed value.

Conversely, when a reference is set using the :ACQUIRE command, the :REFERENCE? query command returns the acquired reference value.

**:STATe **

Command syntax:

:CURRent:AC:REFEreNce:STATe Control reference for ACI

:CURRent:DC:REFEreNce:STATe Control reference for DCI

Command parameter:

 =	1 or ON	Enable reference
	0 or OFF	Disable reference

Query:

:STATe? Query state of reference.

Description:

These commands are used to enable or disable :reference” for the specified function. When enabled, the displayed reading will include the programmed reference value. When disabled, the displayed reading will not include the reference value.

:ACQUIRE

Command syntax:

:CURRent:AC:REFEreNce:ACQUIRE Acquire reference for ACI

:CURRent:DC:REFEreNce:ACQUIRE Acquire reference for DCI

Description:

When one of these commands is sent, the measurement input signal is acquired and established as the reference value. This command is typically used to zero the display. For example, if the instrument is displaying a 50 µA offset, sending this command and enabling reference zeroes the display.

This command is functional only if the instrument is on the specified measurement function. Sending this command while in any other function causes an error. Also, if the latest reading caused an overflow condition or a reading has not been triggered, an error occurs when this command is sent.

6.3.5 RESistance subsystem

The commands in this subsystem are used to configure and control resistance measurement function and are summarized in Table 6-5.

Table 6-5 RESistance Subsystem Commands Summary

Command	Function Description	Default
:RESistance	Path to configure resistance	
:NPLCycles <n>	Set integration rate (*power line cycles: 0.1, 1, 10)	1
:NPLCycles?	Query line cycle integration rate	
:RANGe	Path to configure measurement range	
[:UPPer] <n>	Select range (0 to 20e6)	20e6
[:UPPer]?	Query range	
:AUTO 	Enable or disable auto range	ON
:AUTO?	Query auto range	
:REFerence <n>	Specify reference (0 to 20e6)	0
:STATe 	Enable or disable reference	OFF
:STATe?	Query state of reference	
:ACQuire	Use input signal as reference	
:REFerence?	Query reference value	

*Fast = 0.1, Medium = 1, Slow = 10

Speed Commands

: NPLCycles <n>

Command System:

:RESistance:NPLCycles <n> Set NPLC for Ω

Command Parameter:

<n> =	0.1, 1, 10	Set power line cycles per integration
	DEFault	1
	MINimum	10
	MAXimum	0.1

Query:

:NPLCycles? Query programmed NPLC value

Description:

The integration period (measurement speed) for the basic measurement functions (except Frequency and Period) is set using the :NPLCycles command. NPLC (Number of Power Line Cycles) expresses the integration period by basing it on the power line frequency. For example, for a PLC of 1, the integration period in seconds would be 1/60 (for 60Hz line power) which is 16.67 ms.

:RANGe Commands

:[UPPer] <n>

Command syntax:

:RESistance:RANGe[:UPPer] <n> Set measurement range for Ω

Command Parameter:

<n> =	0 to 20e6	Expected reading is ohms
	DEFault	20e6 (Ω)
	MINimum	0 (All functions)
	MAXimum	Same as DEFault

Query:

:RANGe[:UPPer]? Query measurement range of the current function.

Description:

This command is used to manually select the measurement range for the specified measurement function. The range is selected by specifying the expected reading as an absolute value. The instrument will then go to the most ideal range that will accommodate the expected reading. For example, if you expect a reading of approximately 20 Ω , simply let the parameter **<n> = 20** in order to select the 200 Ω range (for model 2831E). If you expect a reading of approximately 50 Ω , simply let the parameter **<n> = 50** in order to select the 500 Ω range (for model 5491B).

**:AUTO **

Command syntax:

**:RESistance:RANGe:AUTO ** Set auto range for Ω

Command parameter:

 =	1 or ON	Enable auto range
	0 or OFF	Disable auto range

Query:

:AUTO? Query auto range (ON or OFF)

Description:

These commands are used to control auto ranging. With auto ranging enabled, the instrument automatically goes to the most ideal range to perform the measurement.

The auto range command (**:RANGe:AUTO**) is coupled to the command that manually selects the measurement range (**:RANGe <n>**). When auto range is enabled, the parameter value for **:RANGe <n>** changes to the automatically selected range value. Thus, when auto range is disabled, the instrument remains at the automatically selected range. When a valid **:RANGe <n>** command is sent, auto ranging disables.

:REFerence <n> Commands

:REFerence <n>

Command syntax:

:RESistance:REFerence <n> Specify reference for Ω

Command parameter:

<n> =	0 to 20e6	Reference for Ω
	DEFault	0 (All measurement functions)
	MINimum	Minimum value for specified function
	MAXimum	Maximum value for specified function

Query:

:REFerence? Query reference for relative function

Description:

These commands are used to establish a reference value for the specified function. When reference is enabled (:REFerence:STATe), the result will be the algebraic difference between the input signal and the reference value:

Reading = Input signal – Reference

From the front panel, reference is called relative (REL).

The :REFerence <n> command is coupled to the :ACQuire command. The last command sent (:REFerence <n> or :ACQuire) establishes the reference. When a reference is set using the :REFerence <n> command, the REFerence? query command returns the programmed value. Conversely, when a reference is set using the :ACQuire command, the :REFerence? query command returns the acquired reference value.

**:STATe **

Command syntax:

:RESistance:REFerence:STATe Control reference for Ω

Command parameter:

 =	1 or ON	Enable reference
	0 or OFF	Disable reference

Query:

:STATe? Query state of reference.

Description:

These commands are used to enable or disable “reference” for the specified function. When enabled, the displayed reading will include the programmed reference value. When disabled, the displayed reading will not include the reference value.

:ACQuire

Command syntax:

:RESistance:REFerence:ACQuire

Acquire reference for Ω

Description:

When one of these commands is sent, the measurement input signal is acquired and established as the reference value. This command is typically used to zero the display. For example, if the instrument is displaying a 0.1 Ω offset, sending this command and enabling reference zeroes the display.

This command is functional only if the instrument is on the specified measurement function. Sending this command while in any other function causes an error. Also, if the latest reading caused an overflow condition or a reading has not been triggered, an error occurs when this command is sent.

6.3.6 FREQUENCY and PERIOD subsystem

The commands in this subsystem are used to configure and control frequency as well as period measurement function and are summarized in Table 6-6.

Table 6-6 FREQUENCY and PERIOD Subsystem Commands Summary

Command	Function Description	Default
:FREQUENCY :THRESHOLD :VOLTAGE :RANGE <n> :RANGE? :REFERENCE <n> :STATE :STATE? :ACQUIRE :REFERENCE?	Path to configure frequency Path to select the threshold voltage range: Select threshold range (0 to 750). Query threshold range Specify reference (0 to 1.0e6) Enable or disable reference Query state of reference Use input signal as reference Query reference value	20 0 OFF
:PERIOD :THRESHOLD :VOLTAGE :RANGE <n> :RANGE? :REFERENCE <n> :STATE :STATE? :ACQUIRE :REFERENCE?	Path to configure period Path to select the threshold voltage range: Select threshold range (0 to 750). Query threshold range Specify reference Enable or disable reference Query state of reference Use input signal as reference Query reference value	20 0 OFF

:RANGe <n>

Command syntax:

:FREQuency:THReshold:VOLTage:RANGe <n> Set voltage threshold range.
:PERiod:THReshold:VOLTage:RANGe <n> Set voltage threshold range.

Command parameter:

<n> = 0 to 1010 Specify signal levels in volts (voltage threshold)

Query:

:RANGe? Query maximum signal level.

Description:

These commands are used to specify the expected input level. The instrument will then automatically select the most ideal current or voltage threshold range.

:REFerence <n> Commands

:REFerence <n>

Command syntax:

:FREQuency:REFerence <n> Specify reference for FREQ
:PERiod:REFerence <n> Specify reference for PER

Command parameter:

<n> =	
0 to 1.0e6	Reference for FREQ
0 to 1	Reference for PER
DEFault	0 (All measurement functions)
MINimum	Minimum value for specified function
MAXimum	Maximum value for specified function

Query:

:REFerence? Query reference for relative function

Description:

These commands are used to establish a reference value for the specified function. When reference is enabled (:REFerence:STATe), the result will be the algebraic difference between the input signal and the reference value:

Reading = Input signal – Reference

From the front panel, reference is called relative (REL).

The :REFerence <n> command is coupled to the :ACQuire command. The last command sent (:REFerence <n> or :ACQuire) establishes the reference. When a reference is set using the :REFerence <n> command, the REFerence? query command returns the programmed value. Conversely, when a reference is set using the :ACQuire command, the :REFerence? query

command returns the acquired reference value.

**:STATe **

Command syntax:

:FREQuency:REFerence:STATe 	Control reference for FREQ
:PERiod:REFerence:STATe 	Control reference for PER

Command parameter:

 = 1 or ON	Enable reference
0 or OFF	Disable reference

Query:

:STATe? Query state of reference.

Description:

These commands are used to enable or disable “reference” for the specified function. When enabled, the displayed reading will include the programmed reference value. When disabled, the displayed reading will not include the reference value.

:ACQuire

Command syntax:

:FREQuency:REFerence:ACQuire	Acquire reference for FREQ
:PERiod:REFerence:ACQuire	Acquire reference for PER

Description:

When one of these commands is sent, the measurement input signal is acquired and established as the reference value. This command is typically used to zero the display. For example, if the instrument is displaying a 10 Hz offset, sending this command and enabling reference zeroes the display.

This command is functional only if the instrument is on the specified measurement function. Sending this command while in any other function causes an error. Also, if the latest reading caused an overflow condition or a reading has not been triggered, an error occurs when this command is sent.

6.3.7 TRIGger subsystem

These commands in this subsystem are used to configure and control trigger measurement function and are summarized in Table 6-8.

Table 6-8 TRIGger Subsystem Commands Summary

Command	Function Description	Default
:TRIGger :SOURce <name> :SOURce?	Select control source Query control source	IMMEDIATE

:TRIGger

TRIGger subsystem commands are used for the instrument settings of trigger mode, trigger delay and triggering a measurement.

:SOURce <name>

Command Syntax:

TRIGger:SOURce <name>

Command parameter:

<name> = IMMEDIATE instrument default setting is internal trigger
 BUS Triggered via USB/RS232 interface
 MANual (EXternal) (Press in the front panel for Trigger)

Query:

:SOURce? Query control source

Description:

These are used to select the event control source.

6.3.8 FETCH Subsystem

FETCh? Command

Command syntax:

:FETCh?

Description:

This query command is used to obtain the last available reading. This command does not affect the configuration of the instrument.

This command does not trigger a measurement. The command simply requests the last available reading. It will continue to return the same last reading until there is a new reading.

This command will be automatically asserted when :READ? or :MEASure? command is sent.

6.3.9 SYSTEM Subsystem

SYSTem:ERRor Command

Command syntax:

:SYSTem:ERRor?

Description:

This query command is used to query error messages from the error queue. From front display, if a wrong command has been sent, the display will show an error message for approximately one second. That error can be queried from the error queue by sending this command.

Error Messages:

“NO ERROR!” – This means no error(s) have occurred.

“BUS:BAD COMMAND.” – This means either a wrong command was sent to the instrument or there may be misspelling in the command.

6.3.10 Common Commands

Common commands can be used to all equipment. We provide some common commands as shown below:

***RST**

Command Syntax:

*RST

Description:

Reset the instrument

***TRG**

Command Syntax:

*TRG

Description:

Trigger the instrument for measurement

***IDN?**

Query Syntax:

*IDN?

Query return:

<product>,<version><LF^END>

Here:

<product> 2831E Multimeter

<version> Ver1.0.09.12.03

Description:

Query information of the instrument

Chapter 7 Specifications

A-1 Introduction

Chapter 7 describes the complete specifications of the multimeter.

A-2 Technical Specifications

Specifications are based on the following conditions:

- One year calibration cycle.
- Operating temperature at 18 °C to 28 °C
- Accuracy is expressed as: \pm (% of reading + % of range) after 30 minutes warm-up.
- Temperature Coefficient: add \pm [0.1% \times (the applicable accuracy)/°C] for 0 °C to 18 °C and 28 °C to 40 °C
- Relative Humidity: Up to 80% RH for 0 °C to 28 °C (75% RH for 10 M Ω and above ranges for resistance measurement). Up to 70% RH for 28 °C to 40 °C

Displayed Readings and Reading rates

Reading rates on front panel (approximate reading/sec)

Measurement Function	Slow	Med	Fast
DCV	5	10	25
DCA	5	10	25
ACV	5	10	25
ACA	5	10	25
Ω (Ranges below 2M)	5	10	25
Ω (20M range and above)	1.3	2.6	5.6
Freq/ Period	1	2	3.9
Using dual display	0.9	0.9	0.8
True RMS DC+AC	1.2	1.4	1.5
Diode	————	10	————
Continuity	————	————	25

MODEL 2831E SPECIFICATIONS

DC Voltage

Resolution, Full Scale reading and Accuracy: \pm (% of reading + % of range), 23 °C \pm 5 °C

Rate	Range	Resolution	Full Scale Reading	Accuracy (1 year)	Typical Input Impedance
Slow	200.00 mV	10 μ V	210.00	0.03%+0.08% ⁽¹⁾	>10 M Ω
	2.0000 V	100 μ V	2.1000	0.03%+0.05% ⁽¹⁾	>11.1 M Ω
	20.000 V	1 mV	21.000	0.03%+0.06%	>10.1 M Ω
	200.00 V	10 mV	210.00	0.03%+0.06%	10 M Ω
	1000.0 V	100 mV	1010.0 ⁽²⁾	0.03%+0.06%	10 M Ω
⁽¹⁾ under REL status					
⁽²⁾ 1% over-range (1010 V) is readable at 1000 V range					

Maximum input voltage: 1000 VDC or peak ac for all ranges.

AC Voltage

Resolution, Full Scale reading and Accuracy

Range	Resolution	Full Scale Reading
200.00 mV	10 μ V	210.00
2.0000 V	100 μ V	2.1000
20.000 V	1 mV	21.000
200.00 V	10 mV	210.00
750.0 V	100 mV	757.5 ⁽¹⁾
⁽¹⁾ 1% over-range (757.50V) is readable at 750V range		

ACCURACY: \pm (% of reading + % of range), 23 °C \pm 5 °C

Rate	Range	Accuracy(1 year) ⁽¹⁾ 23 °C \pm 5 °C			
		20-50 Hz	50-20 kHz	20-50 kHz	50-100 kHz
Slow	200.00 mV	1.0%+0.2%	0.5%+0.15%	1.8%+0.25%	3.0%+0.75%
	2.0000 V	1.0%+0.2%	0.4%+0.05%	1.5%+0.1%	3.0%+0.25%
	20.000 V	1.0%+0.2%	0.4%+0.05%	1.5%+0.1%	3.0%+0.25%
	200.00 V	-----	0.8%+0.075%	1.5%+0.1%	3.0%+0.25%
	750.0 V	-----	0.8%+0.075%	1.5%+0.1% ⁽²⁾	3.0%+0.25% ⁽²⁾
⁽¹⁾ Specifications are for sine wave inputs >5% of range.					
⁽²⁾ Limit at 40 kHz or $\leq 3 \times 10^7$ Volt-Hz for 750 V range					

Measurement method: True RMS measurement

Maximum Crest factor: 3.0 at full scale

Maximum input voltage: 750 Vrms

$\leq 3 \times 10^7$ Volt-Hz for all ranges

Input impedance: 1 M Ω \pm 2% in parallel with capacitance <100 pF

Maximum DCV: 500 V for all AC ranges

DC Current: \pm (% of reading + % of range), 23 °C \pm 5 °C

Rate	Range	Resolution	Full Scale Reading	Accuracy (1 year)	Burden Voltage ⁽¹⁾ & Shunt Resistor
Slow	2.0000 mA	0.1 μ A	2.1000	0.08%+0.025% ⁽²⁾	<0.3 V / 100 Ω
	20.000 mA	1 μ A	21.000	0.08%+0.02% ⁽²⁾	<0.04 V / 1 Ω
	200.00 mA	10 μ A	210.00	0.08%+0.02%	<0.3 V / 1 Ω
	2.0000 A	100 μ A	2.1000	0.3%+0.025%	<0.05 V / 10 m Ω
	20.000 A	1 mA	21.000 ⁽³⁾	0.3%+0.025%	<0.6 V / 10 m Ω
⁽¹⁾ Typical voltage across the input terminals at full scale reading. ⁽²⁾ Use REL function ⁽³⁾ In 20 A range, >10-20 ADC is readable for 20 seconds maximum					

Maximum Input and Overload Current Protection: 1 A/ 250 V fuse.

AC Current (True RMS, AC Coupling)

Rate	Range	Resolution	Full Scale Reading	Burden Voltage ⁽¹⁾ /shunt Resistor
Slow	2.0000 mA	0.1 μ A	2.1000	<0.3 V / 100 Ω
	20.000 mA	10 μ A	21.000	<0.04 V / 1 Ω
	200.00 mA	100 μ A	210.00	<0.3 V / 1 Ω
	2.0000 A	1 mA	2.1000	<0.05 V / 10 m Ω
	20.000 A	10 mA	21.000 ⁽²⁾	<0.6 V / 10 m Ω
⁽¹⁾ Typical voltage across the input terminals at full scale reading. ⁽²⁾ In 20 A range, >10-20 A AC is readable for 20 seconds maximum				

ACCURACY: \pm (% of reading + % of range), 23 °C \pm 5 °C

Rate	Range	Accuracy(1 year) ⁽¹⁾ 23 °C \pm 5 °C		
		20-50 Hz	50-2 kHz	2-20 kHz
Slow	2.0000 mA	1.5%+0.5%	0.5%+0.3%	2%+0.5%
	20.000 mA	1.5%+0.5%	0.5%+0.3%	2%+0.38%
	200.00 mA	1.5%+0.5%	0.5%+0.3%	2%+0.38%
	2.0000 A	2.0%+0.5%	0.5%+0.5%	-----
	20.000 A	2.0%+0.5%	0.5%+0.5%	-----
⁽¹⁾ Specifications are for sine wave inputs >5% of range.				

Measurement method: True RMS measurement

Maximum Crest factor: 3.0 at full scale

Maximum Input and Overload Current Protection: 1 A/ 250 V fuse.

Resistance: ± (% of reading + % of range), 23 °C ± 5 °C

Rate	Range ⁽¹⁾	Resolution	Full Scale Reading	Test Current	Accuracy (1 year)
Slow	200.00 Ω	10 mΩ	210.00	0.5 mA	0.10%+0.05% ⁽²⁾
	2.0000 kΩ	100 mΩ	2.1000	0.45 mA	0.10%+0.025% ⁽²⁾
	20.000 kΩ	1 Ω	21.000	45 μA	0.10%+0.025% ⁽²⁾
	200.00 kΩ	10 Ω	210.00	4.5 μA	0.10%+0.025%
	2.0000 MΩ	100 Ω	2.1000	450 nA	0.15%+0.025%
	20.000 MΩ	1 kΩ	21.000	45 nA	0.3%+0.05%

⁽¹⁾ In order to eliminate the noise interference, which might be induced to the test leads, it is recommended to use a shielded test cable for measuring resistance above 100 kΩ.

⁽²⁾ Using REL function

Maximum Input Protection: 1000 VDC or 750 VAC for all ranges.

Open circuit voltage: Maximum voltage is 5.5 V dc

Continuity: ± (% of reading + % of range), 23 °C ± 5 °C

Range	Resolution	Full Scale Reading	Test Current	Accuracy (1 year) 23 °C ± 5 °C
200 Ω	100 mΩ	999.9	0.5 mA	0.1%+0.1%

Maximum Input Protection: 1000 VDC or 750 VAC for all ranges.

Open circuit voltage: < 5.5 V DC

Test Current: around 0.5 mA DC

Threshold value: 5% of range

MODEL 5491B SPECIFICATIONS

DC Voltage

Resolution, Full Scale reading and Accuracy: ± (% of reading + % of range), 23 °C ± 5 °C

Rate	Range	Resolution	Full Scale Reading	Accuracy (1 year)	Typical Input Impedance
Slow	500.00 mV	10 μV	510.00	0.02%+0.016% ⁽¹⁾	>10 MΩ
	5.0000 V	100 μV	5.1000	0.02%+0.008% ⁽¹⁾	>11.1 MΩ
	50.000 V	1 mV	51.000	0.02%+0.008%	>10.1 MΩ
	500.00 V	10 mV	510.00	0.02%+0.008%	10 MΩ
	1000.0 V	100 mV	1010.0 ⁽²⁾	0.02%+0.008%	10 MΩ

⁽¹⁾ under REL status

⁽²⁾ 1% over-range (1010 V) is readable at 1000 V range

Maximum input voltage: 1000 VDC or peak ac for all ranges.

AC Voltage

Resolution, Full Scale reading and Accuracy

Range	Resolution	Full Scale Reading
500.00 mV	10 μ V	510.00
5.0000 V	100 μ V	5.1000
50.000 V	1 mV	51.000
500.00 V	10 mV	510.00
750.0 V	100 mV	757.5 ⁽¹⁾

⁽¹⁾ 1% over-range (757.50 V) is readable at 750 V range

ACCURACY: \pm (% of reading + % of range), 23 °C \pm 5 °C

Rate	Range	Accuracy(1 year) ⁽¹⁾ 23 °C \pm 5 °C			
		20-50 Hz	50-20 kHz	20-50 kHz	50-100 kHz
Slow	500.00 mV	1.0%+0.08%	0.5%+0.06%	1.5%+0.1%	3.0%+0.3%
	5.0000 V	1.0%+0.08%	0.35%+0.02%	1%+0.04%	3.0%+0.1%
	50.000 V	1.0%+0.08%	0.35%+0.02%	1%+0.04%	3.0%+0.1%
	500.00 V	-----	0.5%+0.03%	1%+0.04%	3.0%+0.1%
	750.0 V	-----	0.5%+0.03%	1%+0.04% ⁽²⁾	3.0%+0.1% ⁽²⁾

⁽¹⁾ Specifications are for sine wave inputs >5% of range.
⁽²⁾ Limit at 40 kHz or $\leq 3 \times 10^7$ Volt-Hz for 750 V range

Measurement method: True RMS measurement

Maximum Crest factor: 3.0 at full scale

Maximum input voltage: 750 Vrms

$\leq 3 \times 10^7$ Volt-Hz for all ranges

Input impedance: 1 M Ω \pm 2% in parallel with capacitance <100 pF

Maximum DCV: 500 V for all AC ranges

DC Current: ± (% of reading + % of range), 23 °C ± 5 °C

Rate	Range	Resolution	Full Scale Reading	Accuracy (1 year)	Burden Voltage ⁽¹⁾ & Shunt Resistor
Slow	5.0000 mA	0.1 µA	5.1000	0.05%+0.01% ⁽²⁾	<0.6 V / 100 Ω
	50.000 mA	1 µA	51.000	0.05%+0.008% ⁽²⁾	<0.06 V / 1 Ω
	500.00 m A	10 µA	510.00	0.05%+0.008%	<0.6 V / 1 Ω
	5.0000 A	100 µA	5.1000	0.25%+0.01%	<0.1 V / 10 mΩ
	20.000 A	1 mA	21.000 ⁽³⁾	0.25%+0.01%	<0.6 V / 10 mΩ

⁽¹⁾ Typical voltage across the input terminals at full scale reading.

⁽²⁾ Use REL function

⁽³⁾ In 20 A range,>10-20ADC is readable for 20 seconds maximum

Maximum Input and Overload Current Protection: 1A/ 250V fuse.

AC Current (True RMS, AC Coupling)

Rate	Range	Resolution	Full Scale Reading	Burden Voltage ⁽¹⁾ /shunt Resistor
Slow	5.0000 mA	0.1 µA	5.1000	<0.6 V / 100 Ω
	50.000 mA	10 µA	51.000	<0.06 V / 1 Ω
	500.00 m A	100 µA	510.00	<0.6 V / 1 Ω
	5.0000 A	1 mA	5.1000	<0.1 V / 10 mΩ
	20.000 A	10 mA	21.000 ⁽²⁾	<0.6 V / 10 mΩ

⁽¹⁾ Typical voltage across the input terminals at full scale reading.

⁽²⁾ In 20A range,>10-20Aac is readable for 20 seconds maximum

ACCURACY: ± (% of reading + % of range), 23 °C ± 5 °C

Rate	Range	Accuracy(1 year) ⁽¹⁾ 23 °C ± 5 °C		
		20-50 Hz	50-2 kHz	2-20 kHz
Slow	5.0000 mA	1.5%+0.16%	0.5%+0.08%	2%+0.16%
	50.000 mA	1.5%+0.16%	0.5%+0.08%	2%+0.12%
	500.00 m A	1.5%+0.16%	0.5%+0.08%	2%+0.12%
	5.0000 A	2.0%+0.16%	0.5%+0.1%	-----
	20.000 A	2.0%+0.16%	0.5%+0.1%	-----

⁽¹⁾ Specifications are for sine wave inputs >5% of range.

In 20 A range,>10-20Aac is readable for 20 seconds maximum

Measurement method: True RMS measurement

Maximum Crest factor: 3.0 at full scale

Maximum Input and Overload Current Protection: 1 A/ 250 V fuse.

Resistance: ± (% of reading + % of range), 23 °C ± 5 °C

Rate	Range ⁽¹⁾	Resolution	Full Scale Reading	Test Current	Accuracy (1 year)
Slow	500.00 Ω	10 mΩ	510.00	0.5 mA	0.10%+0.01% ⁽²⁾
	5.0000 kΩ	100 mΩ	5.1000	0.45 mA	0.10%+0.008% ⁽²⁾
	50.000 kΩ	1 Ω	51.000	45 μA	0.10%+0.008% ⁽²⁾
	500.00 kΩ	10 Ω	510.00	4.5 μA	0.10%+0.008%
	5.0000 MΩ	100 Ω	5.1000	450 nA	0.15%+0.008%
	50.000 MΩ	1 kΩ	51.000	45 nA	0.3%+0.01%

⁽¹⁾ In order to eliminate the noise interference, which might be induced to the test leads, it is recommended to use a shielded test cable for measuring resistance above 100 kΩ.

⁽²⁾ Using REL function

Maximum Input Protection: 1000 VDC or 750 VAC for all ranges.

Open circuit voltage: Maximum voltage is 5.5 VDC

Continuity: ± (% of reading + % of range), 23 °C ± 5 °C

Range	Resolution	Full Scale Reading	Test Current	Accuracy (1 year) 23 °C ± 5 °C
500 Ω	100 mΩ	999.9	0.5 mA	0.1%+0.04%

Maximum Input Protection: 1000 VDC or 750 VAC for all ranges.

Open circuit voltage: <5.5 VDC

Test Current: around 0.5 mA DC

Threshold value: 2% of range

SPECIFICATIONS FOR MODEL 2831E AND 5491B

Diode

Rate	Range	Resolution	Full Scale Reading	Test Current
Med	2.0000 V	100 μV	2.3000 V	0.5 mA (approx.)

Frequency: ± (% of reading + % of range), 23 °C ± 5 °C

ACV Range	Frequency Range	Best Resolution	Full Scale Reading	Accuracy	Input Sensitivity (Sine Wave)
200 mV (*500 mV) to 750 V	10 Hz	100 μHz	9.9999	0.05%+0.02%	200 mV rms
	10-100 Hz	1 mHz	99.999	0.01%+0.02%	300 mV rms
	100-100 kHz	10 mHz	999.99	0.01%+0.008%	300 mV rms
	100k-1 MHz	10 Hz	999.99	0.01%+0.008%	500 mV rms

Period: \pm (% of reading + % of range), 23 °C \pm 5 °C

ACV Range	Frequency Range	Best Resolution	Full Scale Reading	Accuracy	Input Sensitivity (Sine Wave)
200 mV	1-10 μ s	0.1 ns	9.9999	0.01%+0.008%	500 mV rms
(*500 mV)	10 μ s-10 ms	1 ns	9.9999	0.01%+0.008%	300 mV rms
to	10 ms-100 ms	1 μ s	99.999	0.01%+0.02%	300 mV rms
750 V	100 ms	10 μ s	199.99	0.05%+0.02%	200 mV rms

**Applies to model 5491B*

Maximum Crest factor: 3.0 at full scale

Maximum input voltage: 750 Vrms

$\leq 3 \times 10^7$ Volt-Hz for all ranges

Input impedance: 1 M Ω \pm 2% in parallel with capacitance < 100 pF

Maximum DCV: 500 V for all AC ranges

Math Functions

Rel, Max/Min, dBm, dB, Compare Limit Test and %

dBm Reference Resistance: 1 Ω to 9999 Ω (1 Ω step size), default is 75 Ω

Standard Programming Languages

SCPI (Standard Commands for Programmable Instruments)

Remote Interface

USB (Virtual COM)

RS232 (5491B only)

General Specifications

Power Supply: 110/220 V \pm 10%

Power Line Frequency: 50/60 Hz \pm 5%

Power Consumption: \leq 10VA

Operating Environment: 0 °C to 40 °C, \leq 90 %RH,

Storage Environment: -40 °C to 70 °C

Warm-up: more than 30 mins

Dimensions (WxHxD): 225 mmx100 mmx355 mm

Net Weight: Around 2.5 kg

Warranty: 1 year (Model 2831E), 3 years (Model 5491B)

*Specifications are subject to change without notice.

SERVICE INFORMATION

Warranty Service: Please go the support and service section on our website www.bkprecision.com to obtain a RMA #. Return the product in the original packaging with proof of purchase to the address below. Clearly state on the RMA the performance problem and return any leads, probes, connectors and accessories that you are using with the device.

Non-Warranty Service: Please go the support and service section on our website www.bkprecision.com to obtain a RMA #. Return the product in the original packaging to the address below. Clearly state on the RMA the performance problem and return any leads, probes, connectors and accessories that you are using with the device. Customers not on an open account must include payment in the form of a money order or credit card. For the most current repair charges please refer to the service and support section on our website.

Return all merchandise to B&K Precision Corp. with pre-paid shipping. The flat-rate repair charge for Non-Warranty Service does not include return shipping. Return shipping to locations in North America is included for Warranty Service. For overnight shipments and non-North American shipping fees please contact B&K Precision Corp.

B&K Precision Corp.
22820 Savi Ranch Parkway
Yorba Linda, CA 92887
www.bkprecision.com
714-921-9095

Include with the returned instrument your complete return shipping address, contact name, phone number and description of problem.

LIMITED WARRANTY

B&K Precision Corp. warrants to the original purchaser that its products and the component parts thereof, will be free from defects in workmanship and materials for a period of **one year for model 2831E only and three years for model 5491B only** from date of purchase.

B&K Precision Corp. will, without charge, repair or replace, at its option, defective product or component parts. Returned product must be accompanied by proof of the purchase date in the form of a sales receipt.

To obtain warranty coverage in the U.S.A., this product must be registered by completing a warranty registration form on our website www.bkprecision.com within fifteen (15) days of purchase.

Exclusions: This warranty does not apply in the event of misuse or abuse of the product or as a result of unauthorized alterations or repairs. The warranty is void if the serial number is altered, defaced or removed.

B&K Precision Corp. shall not be liable for any consequential damages, including without limitation damages resulting from loss of use. Some states do not allow limitations of incidental or consequential damages. So the above limitation or exclusion may not apply to you.

This warranty gives you specific rights and you may have other rights, which vary from state-to-state.

B&K Precision Corp.
22820 Savi Ranch Parkway
Yorba Linda, CA 92887
www.bkprecision.com
714-921-9095

Page intentionally left blank

Page intentionally left blank

BK PRECISION[®]

22820 Savi Ranch Parkway

Yorba Linda, CA 92887

www.bkprecision.com

© 2010 B&K Precision Corp.