



POWER METER

442 I A

OPERATION MANUAL



## Safety Precautions

The following are general safety precautions that are not necessarily related to any specific part or procedure, and do not necessarily appear elsewhere in this publication. These precautions must be thoroughly understood and apply to all phases of operation and maintenance.

**WARNING**

**Keep Away From Live Circuits**

Operating Personnel must at all times observe general safety precautions. Do not replace components or make adjustments to the inside of the test equipment with the high voltage supply turned on. To avoid casualties, always remove power.

**WARNING**

**Do Not Service Or Adjust Alone**

Under no circumstances should any person reach into an enclosure for the purpose of service or adjustment of equipment except in the presence of someone who is capable of rendering aid.

**WARNING**

**Safety Earth Ground**

An uninterruptible earth safety ground must be supplied from the main power source to test instruments. Grounding one conductor of a two conductor power cable is not sufficient protection. Serious injury or death can occur if this grounding is not properly supplied.

**WARNING**

**Resuscitation**

Personnel working with or near high voltages should be familiar with modern methods of resuscitation.

**WARNING**

**Remove Power**

Observe general safety precautions. Do not open the instrument with the power on.

## Safety Symbols

---

**WARNING**

Warning notes call attention to a procedure, which if not correctly performed, could result in personal injury.

**CAUTION**

Caution notes call attention to a procedure, which if not correctly performed, could result in damage to the instrument.

**Note:** *Calls attention to supplemental information.*

## Warning Statements

---

The following safety warnings appear in the text where there is danger to operating and maintenance personnel and are repeated here for emphasis.

**WARNING**

Never attempt to connect or disconnect RF equipment from the transmission line while RF power is applied.  
Leaking RF energy is a potential health hazard.

See page 17 and 19

**WARNING**

To avoid personal injury, disconnect the power cord from the AC line before performing any maintenance.

See page 34

**WARNING**

The Bird 4421A contains no user-serviceable parts.  
Do not open the cover.

See page 34

## Caution Statements

---

The following equipment cautions appear in the text and are repeated here for emphasis.

**CAUTION**

Do not exceed the RF Power or RF frequency specifications of the RF Power Sensor.

See page 17

**CAUTION**

Do not store the 4421A outside the following temperature ranges

- 10° to 50°C, ≤ 1 month
- 10° to 35°C, ≤ 6 months
- 10° to 25°C, > 6 months

Storage outside these temperature ranges may degrade battery capacity.

See page 44

## **Safety Statements**

---

### **USAGE**

ANY USE OF THIS INSTRUMENT IN A MANNER NOT SPECIFIED BY THE MANUFACTURER MAY IMPAIR THE INSTRUMENT'S SAFETY PROTECTION.

### **USO**

EL USO DE ESTE INSTRUMENTO DE MANERA NO ESPECIFICADA POR EL FABRICANTE, PUEDE ANULAR LA PROTECCIÓN DE SEGURIDAD DEL INSTRUMENTO.

### **BENUTZUNG**

WIRD DAS GERÄT AUF ANDERE WEISE VERWENDET ALS VOM HERSTELLER BESCHRIEBEN, KANN DIE GERÄTESICHERHEIT BEEINTRÄCHTIGT WERDEN.

### **UTILISATION**

TOUTE UTILISATION DE CET INSTRUMENT QUI N'EST PAS EXPLICITEMENT PRÉVUE PAR LE FABRICANT PEUT ENDOMMAGER LE DISPOSITIF DE PROTECTION DE L'INSTRUMENT.

### **IMPIEGO**

QUALORA QUESTO STRUMENTO VENISSE UTILIZZATO IN MODO DIVERSO DA COME SPECIFICATO DAL PRODUTTORE LA PROZIONE DI SICUREZZA POTREBBE VENIRNE COMPROMESSA.

## **SERVICE**

SERVICING INSTRUCTIONS ARE FOR USE BY SERVICE - TRAINED PERSONNEL ONLY. TO AVOID DANGEROUS ELECTRIC SHOCK, DO NOT PERFORM ANY SERVICING UNLESS QUALIFIED TO DO SO.

## **SERVICIO**

LAS INSTRUCCIONES DE SERVICIO SON PARA USO EXCLUSIVO DEL PERSONAL DE SERVICIO CAPACITADO. PARA EVITAR EL PELIGRO DE DESCARGAS ELÉCTRICAS, NO REALICE NINGÚN SERVICIO A MENOS QUE ESTÉ CAPACITADO PARA HACERLO.

## **WARTUNG**

ANWEISUNGEN FÜR DIE WARTUNG DES GERÄTES GELTEN NUR FÜR GESCHULTES FACHPERSONAL.

ZUR VERMEIDUNG GEFÄHRLICHE, ELEKTRISCHE SCHOCKS, SIND WARTUNGSARBEITEN AUSSCHLIEßLICH VON QUALIFIZIERTEM SERVICEPERSONAL DURCHZUFÜHREN.

## **ENTRETIEN**

L'EMPLOI DES INSTRUCTIONS D'ENTRETIEN DOIT ÊTRE RÉSERVÉ AU PERSONNEL FORMÉ AUX OPÉRATIONS D'ENTRETIEN. POUR PRÉVENIR UN CHOC ÉLECTRIQUE DANGEREUX, NE PAS EFFECTUER D'ENTRETIEN SI L'ON N'A PAS ÉTÉ QUALIFIÉ POUR CE FAIRE.

## **ASSISTENZA TECNICA**

LE ISTRUZIONI RELATIVE ALL'ASSISTENZA SONO PREVISTE ESCLUSIVAMENTE PER IL PERSONALE OPPORTUNAMENTE ADDESTRATO. PER EVITARE PERICOLOSE SCOSSE ELETTRICHE NON EFFETTUARE ALCUNA RIPARAZIONE A MENO CHE QUALIFICATI A FARLA.

## About This Manual

---

This manual covers the operating & maintenance instructions for the following models:

4421A

## Changes to this Manual

---

We have made every effort to ensure this manual is accurate. If you discover any errors, or if you have suggestions for improving this manual, please send your comments to our Solon, Ohio factory. This manual may be periodically updated. When inquiring about updates to this manual refer to the part number and revision on the title page.

## Chapter Layout

---

**Introduction** — Describes the features of the RF Power Meter.

**Setup** — Includes unpacking and equipment setup.

**Operating Instructions** — Identifies steps required to power on, use, and power off the Power Meter.

**Troubleshooting** — Provides limited troubleshooting instructions for commonly encountered problems.

**Maintenance** — Lists routine maintenance tasks as well as storage and shipping instructions.

**Specifications** — Provides the specifications for the Bird RF Power Meter.



# TABLE OF CONTENTS

<b>Safety Precautions</b> .....	<b>i</b>
Safety Symbols .....	ii
Warning Statements .....	ii
Caution Statements .....	iii
Safety Statements .....	iv
<b>About This Manual</b> .....	<b>vi</b>
Changes to this Manual .....	vi
Chapter Layout .....	vi
<b>Chapter 1 Introduction</b> .....	<b>1</b>
General Description .....	1
4421A Options .....	2
Optional Rack Mount Kit .....	2
Controls and Indicators .....	3
Display Features .....	5
Display Controls and Indicators .....	6
Settings Menu .....	10
Graph Settings Menu .....	11
Remote Interfaces .....	13
Ethernet Interface .....	13
RS-232 Serial Interface .....	14
RS-232 Cable Connector .....	15
<b>Chapter 2 Setup</b> .....	<b>16</b>
Unpacking and Inspection .....	16
Preparation for Use .....	16
Charge the Battery .....	16
Setup .....	17
VESA Mount .....	18
Mounting Hardware .....	18
Installation .....	18
<b>Chapter 3 Operating Instructions</b> .....	<b>19</b>
Normal Operation .....	19
Power On .....	19
Power Off .....	19
<b>Chapter 4 4421A SCPI Commands</b> .....	<b>20</b>
4421A SCPI Command Syntax .....	20

4421A SCPI Commands .....	22
Common Commands .....	22
Measure Commands .....	22
System Commands .....	23
<b>Chapter 5 Legacy RS-232 Commands .....</b>	<b>25</b>
Legacy Command Syntax .....	25
General Bus Commands .....	26
Device Dependent Commands .....	27
<b>Chapter 6 Troubleshooting .....</b>	<b>33</b>
<b>Chapter 7 Maintenance .....</b>	<b>34</b>
Routine Maintenance .....	34
AC Power Cable .....	34
Web User Interface .....	35
Configure Static IP Address .....	36
Configure DHCP .....	37
Web UI Description .....	38
Status Displays .....	38
Maintenance Displays .....	38
Touchscreen Calibration .....	39
Configuring PC Network Settings to 4421A Subnet .....	41
Restoring PC Network Connection to DHCP .....	41
Firmware Update .....	42
Obtain Firmware .....	42
Install Firmware .....	42
Storage and Shipment .....	44
Customer Service .....	44
<b>Chapter 8 Specifications .....</b>	<b>45</b>
Bird 4421A Power Meter Specifications .....	45
<b>Appendix 1 Optional Rack Mount .....</b>	<b>47</b>
4421A Rack Mounting Kit .....	47
Rack Mount Kit Assembly .....	48
Rack Mount Kit Contents .....	48
Assembly Instructions .....	48
Attach 4421A to Rack Mount .....	52
<b>Limited Warranty .....</b>	<b>53</b>

The Bird 4421A Power Meter is used with Bird power sensors to measure RF power.

## General Description

---

The 4421A Power Meter is designed to be used with the Bird Power Sensors as shown in [Table 1](#). The 4421A is equipped with a touchscreen interface. There are several models of the 4421A that feature extended capabilities and enhancements beyond the base model, see "[4421A Options](#)" on [page 2](#).

**Figure 1 Bird 4421A Power Meter Assembly**



**Table 1 Compatible Power Sensors**

Sensor Type	Bird RF Sensor Model Number	4421A Model
Directional Power Sensors (DPS)	4021, 4022, 4023, 4024, 4025, 4027, 4028	All Models
Pulse Sensors	7027-series, 7037-series	4421A-12-11-1

## 4421A Options

---

There are several 4421A models, as shown in [Table 2](#). The models are enabled by the installation of a firmware license, thus a base model can be enhanced with additional features by the factory installation of a new license. The following options are available for the 4421A.

**One Sensor Operation** — One Sensor models, will display the RF power measurements of a single RF Power Sensor connected to one of the Sensor connectors, see "[Controls and Indicators](#)" on [page 3](#).

**Two Sensor Operation** — Two Sensor models, will display the RF power measurements of two RF Power Sensor simultaneously when both sensors are connected to the Sensor connectors.

**Remote Operation** — Models which include the remote interfaces allow the 4421A's operation to be controlled from a remote computer/controller and RF Sensor measurements from sensor(s) connected to the 4421A may be received on the remote computer. This option is available as shown in [Table 2](#).

**Note:** *There are two protocols supported by the 4421A for remote operation, the legacy 4421 protocol and the new SCPI protocol. Either command protocol may be used to remotely access a single sensor. To remotely access two sensors, you must use the SCPI protocol.*

**Table 2 4421A Model List**

<b>Model Number</b>	<b>Number of Sensors</b>	<b>Remote Interfaces</b>
4421A-10-00-0	One Serial Sensor	None
4421A-20-00-0	Two Serial Sensors	None
4421A-10-11-0	One Serial Sensor	RS-232, Ethernet
4421A-20-11-0	Two Serial Sensors	RS-232, Ethernet
4421A-12-11-1 <sup>†</sup>	One Serial Sensor or Two USB Sensors	RS-232, Ethernet

<sup>†</sup> Measurement data will only be displayed for the first two sensors connected to the unit.

**Note:** *Licenses may be purchased to implement increased capabilities of higher level models.*

## Optional Rack Mount Kit

---

A rack mounting kit (Bird Part Number 4421A-RM1) is available for the 4421A, see [Appendix 1, Optional Rack Mount on page 47](#).

## Controls and Indicators

**Figure 2** Models 4421A-10-00-0, 4421A-20-00-0, 4421A-10-11-0, 4421A-20-11-0



**Figure 3** Model 4421A-12-11-1

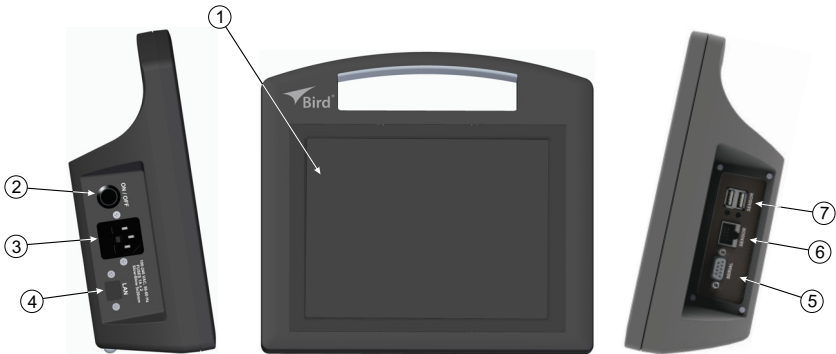

Item	Indicator	Description
1	Display/Touch Screen	Displays Power Sensor information and acts as the user interface.
2	Power Switch	Used to apply and remove power from the unit. Illuminated ring indicates power is applied to the unit. <ul style="list-style-type: none"> <li>• Normal Power ON/OFF - Press and release (short press) the power button.</li> <li>• Forced Power Down - Press and hold (long press) the power button for 3 seconds.</li> </ul>

3	AC Power Input Connector	Power input connector (C-14, male), 100-240 VAC, 50/60 Hz, with integrated fuse holder, requires 1A, 5x20mm, slow-blow fuses.
4	Ethernet Connector	Ethernet connector provides access to the device's web UI and firmware update capability.
5	RS-232 Serial Port	<p>The serial port allows computer interface capability with the 4421A using either the <a href="#">"4421A SCPI Commands" on page 20</a> or the <a href="#">"Legacy RS-232 Commands" on page 25</a> .</p> <p>Either command protocol may be used to remotely access a single sensor.</p> <p>On systems capable of two sensor operation the <a href="#">"4421A SCPI Commands" on page 20</a> must be used to remotely access two sensors.</p>
6	Sensor Connectors, 402X Model Sensors	<p><b>4421A-10-00-0, 4421A-20-00-0, 4421A-10-11-0, 4421A-20-11-0</b></p> <p>Two serial sensor cable connectors.</p> <p>Either connector may be used on one sensor models. One or both may be used on two sensor models.</p> <p><b>4421A-12-11-1</b></p> <p>One serial sensor cable connector.</p> <p>See <a href="#">"4421A Options" on page 2</a>.</p>
7	Sensor Connectors, 702X Model Sensors	<p><b>4421A-12-11-1</b></p> <p>Two USB sensor cable connectors.</p>

## Display Features

The 4421A display is capable of displaying the measurement information from one or two sensors simultaneously (model dependent), see [Figure 4](#). The display may be configured to display the following measurements from a sensor:

- Forward Power
- Reflected Power
- VSWR
- Return Loss
- Reflection Coefficient

**Figure 4** *Sensor Measurements Display*

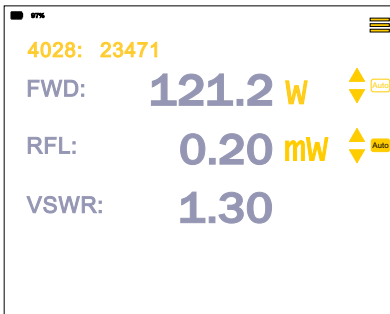

One Sensor Connected

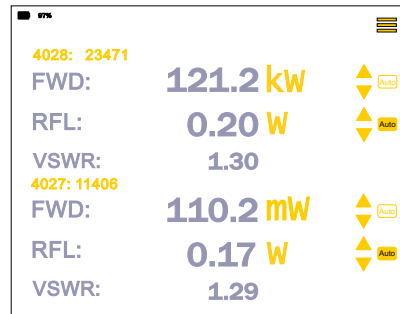

Two Sensors Connected

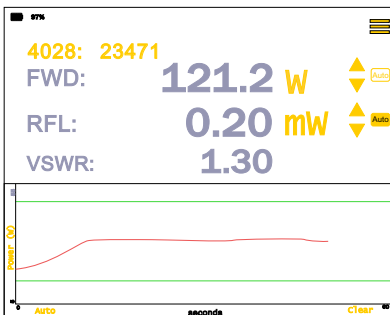

One Sensor with Graph

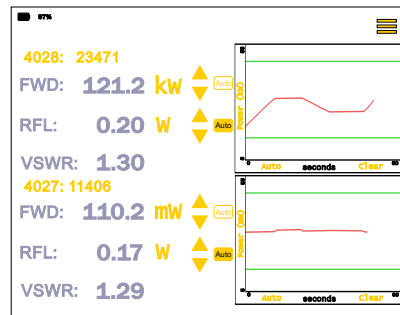

Two Sensors with Graphs



**Note:** Dual-sensor display is only available if the dual-sensor license has been purchased and activated. See ["4421A Options" on page 2](#).

## Display Controls and Indicators

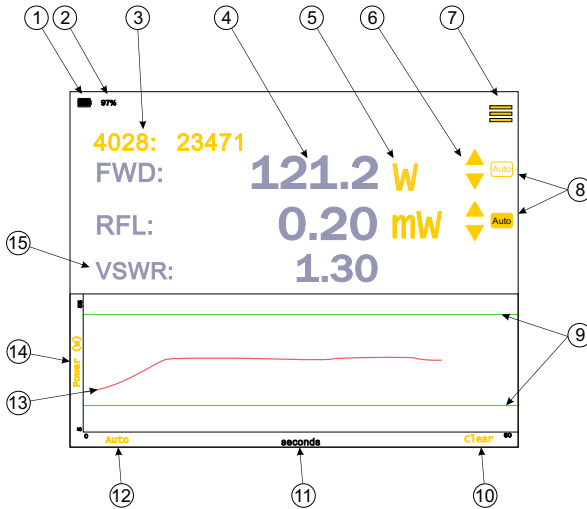

The display is used for presenting information and controlling the behavior of the 4421A. The controls are those items displayed on the screen, that, when tapped cause a change in the 4421A's behavior. Controls can be identified by their color, on screen controls are yellow. The table in [Figure 5](#) describes the on screen controls and indicators.

**Figure 5 Display Controls**



Item	Indicator	Description
1	Battery/AC Power indicator	When connected to AC power, and battery is below 100%, the charge indicator is displayed.  When connected to AC power and battery is fully charged, a facsimile of an AC Power Plug is displayed.  When on battery power, the charge level of the battery is displayed. 
2	Battery Remaining	Indicates the remaining charge of the internal battery.

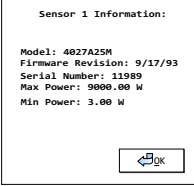
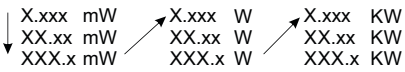

3	Sensor model/SN	<p>Displays <b>Connecting...</b> for several seconds after initially connecting a sensor.</p> <p>The sensor model number and serial number are displayed above the sensor's measurement data.</p> <p>When tapped, opens a sensor information window.</p> 
4	Forward and Reflected Power	<p>The sensor readings for Forward and Reflected power may be displayed in milliwatts, Watts, Kilowatts, or dBm.</p> <p>In overrange situations, the 4421A will display the word "<b>RANGE</b>" in place of the actual power reading.</p> <p>When Reflected power measurement is dBm, <b>-inf</b> dBm means the reflected power was 0 W (exactly).</p>
5	Measurement Unit	<p>The 4421A will display the signal measurements in <b>Watts</b> or <b>dBm</b>.</p>
6	Manual Range Controls	<p>Up and Down arrows are used to change the scale of the displayed power readings.</p>  <p><b>Note:</b> Stops automatic scaling. Auto indicator (item 7) turns off.</p> <p><b>Note:</b> Manual Range not available when measurement unit is dBm.</p>
7	Settings Menu	<p>The settings menu is used to configure what measurement information is displayed, and to configure LAN and Serial Port settings. See "<a href="#">Settings Menu</a>" on page 10.</p>
8	Auto Range	<p> - When button is on, indicates range scale is set to auto.</p> <p> - When button is off, indicates range scale is in manual control, see item 6.</p> <p><b>Note:</b> Auto Range not available when measurement unit is dBm.</p>

9	Limit Lines	<p>Min and max limit lines (green horizontal lines) may be set to display in the graph's display area.</p> <p>The position of the two lines are set in the <a href="#">"Graph Settings Menu" on page 11</a>.</p>
10	Clear	<p>Tapping Clear discards the graph's accumulated data and resets time scale to 60 seconds.</p>
11	Time Scale	<p>The graph's time scale auto expands as data accumulates with the following scales:</p> <ul style="list-style-type: none"> <li>• 60, 120, 240, 480 seconds</li> <li>• 15, 30, 60, 120, 240 minutes</li> <li>• 8, 16, 24 hours</li> </ul> <p>Data accumulation stops at 24 hours.</p> <p>When graph is turned off then back on the accumulated data is discarded and time scale resets to 60 second span.</p>
12	Auto	<p>Tap Auto to adjust the graph's power scale to fit accumulated data.</p>
13	Measurement Trace	<p>Forward Power is plotted on the graph in watts on the vertical axis (y) versus time in the horizontal axis (x). The trace is displayed as a red line.</p> <p>The graph accumulates data at 1 sample/sec as long as a sensor is connected.</p> <ul style="list-style-type: none"> <li>• If no sensor is connected, accumulation pauses until a sensor is connected.</li> <li>• The graph does not account for any gap while a sensor is disconnected. That is accumulation will resume as if only 1 second has elapsed since the last sample.</li> <li>• The graph does not account for mixing sensors (i.e. switching sensors in the middle of accumulation).</li> <li>• Plotted data is either raw data or averaged data. Mode is set in the <a href="#">"Graph Settings Menu" on page 11</a></li> </ul>
14	Power	<p>Power scale defaults to the min/max power specification for a connected sensor.</p> <p>The measurement unit will match that selected by the measurement unit selection (see item 4).</p> <ul style="list-style-type: none"> <li>• Power scale may be adjusted automatically (see item 11, Auto) or via the <a href="#">Graph Settings Menu</a></li> <li>• Tap to open power dialog.</li> </ul>

15	VSWR / Return Loss/ Reflection Coefficient	<p>This line on the display can be set to display one of three measurements: VSWR, Return Loss, or Reflection Coefficient. The <a href="#">Settings Menu</a> is used to select which measurement is displayed. <b>+inf</b> will be displayed if Reflected power = Forward power (an uncommon scenario, but could occur with an open circuit).</p>
----	---	---

## Settings Menu

The setting menu is used to select what information will appear on the 4421A's display as well as configuration of the LAN and Serial Ports. [Figure 6](#) describes the options available via the setting menu.

**Figure 6 Settings Menu**

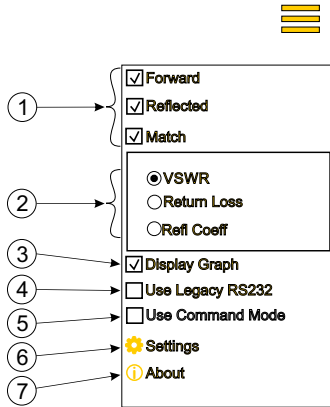

Item	Title	Description
1	Measurements	Check boxes used to select which measurements are displayed for the attached sensor(s).
2	Match Format	Radio buttons used to select the format for the match measurement.
3	Display Graph	When check box is selected, a graph is displayed on the screen with the associated measurements.
4	Use Legacy RS232	When check box is selected, the 4421A will accept the RS-232 command set used with legacy 4421 power meters. See <a href="#">Chapter 5, Legacy RS-232 Commands on page 25</a> .
5	Use Command Mode	Command mode emulates the command mode dip switch setting from the legacy 4421 power meters RS-232 command set.
6	Settings Icon	When tapped, a menu is displayed for selecting the LAN or Serial configuration menus. <ul style="list-style-type: none"> <li>When LAN is tapped, the 4421A's IP address configuration menu is displayed. See <a href="#">"IP Address Settings Display" on page 13</a>.</li> <li>When Serial is tapped, the 4421A's serial port settings dialog box is displayed. See <a href="#">"Serial Port Setup" on page 14</a>.</li> </ul>

7	About	Displays the units Model Number, Serial Number, and Firmware ID. Compliance and software licensing information may also be viewed from the About menu.
---	-------	--

## Graph Settings Menu

The Graph Settings menu is accessed by tapping the power scale on the graph. [Figure 7](#) describes the options in the Graph Settings menu.

**Figure 7 Graph Settings Menu**

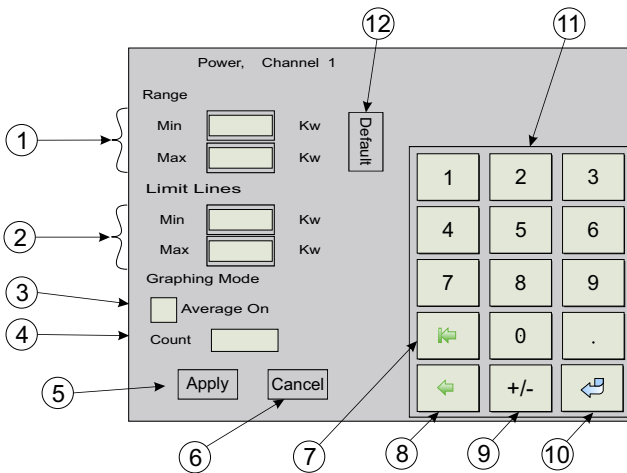

Item	Title	Description
1	Range	Text entry boxes for the entry of Min and Max range for the Power Scale on the Graph. Min and Max values specify the upper and lower limit of the power scale of the graph.
2	Limit Lines	Text entry boxes for the entry of Min and Max value for the limit lines displayed on the Graph. Two horizontal limit lines may be set to user specified levels on the power scale. The Min value sets the location of the lower limit line, while the Max value sets the location of the upper limit line.
3	Average On, Graphing Mode	Graphing Mode allows the measurement results to be displayed either raw or averaged. When Average On is checked, each point plotted on the graph is the arithmetic mean of several raw graph samples.

4	Count, Graphing Mode	Numeric entry for specifying the number of samples used for the moving average. Applied when Average On is selected.
5	Apply	When tapped, applies all menu changes and closes the dialog box.
6	Cancel	When tapped, cancels all menu changes and closes the dialog box.
7	Clear Text	When tapped, clears all characters in a selected text box.
8	Backspace	When tapped, while entering a new value in a text box, deletes the character at the end of the entry. Deletes entire value when highlighted.
9	Plus/Minus	If power on power graph is in dBm units, it can be used to make power values on the power graph positive or negative. If power units on the graph is W, kW, or mW, this button is disabled.
10	Enter	Advances cursor to next text entry box without effecting entered values.
11	Keypad	Numerical keypad used to enter values into the varies text boxes within the dialog box.
12	Default	When tapped, sets all text entry boxes in the dialog box to Default values.

## Remote Interfaces

Models with the remote interface capabilities have the option for control and measurement reporting over those interfaces.

### Ethernet Interface

The Ethernet interface uses a standard RJ-45 connector. The Bird 4421A's Ethernet interface serves two purposes.

**Webpage User Interface** — the webpage user interface provides for firmware updates and touchscreen calibration reset. Features available for this interface are provided in "[Web User Interface](#)" on page 35.

**Remote Measurement Control** — The Ethernet interface allows a remote computer to control the 4421A. Standard Commands for Programmable Instruments (SCPI) commands are used to control the 4421A, see "[4421A SCPI Commands](#)" on page 20 or "[Legacy RS-232 Commands](#)" on page 25.

The remote measurement control is only operational on models with the appropriate license installed and activated, see "[4421A Options](#)" on page 2.

### IP Address Settings Display

The LAN option on the  **Settings** menu is used to access the IP Address configuration menu. This menu displays the current IP Addresses for the 4421A.

The 4421A has a dual IP Address configuration.

- Fixed IP Address: 192.168.44.21 (this address cannot be changed)
- Configurable IP Address: DHCP or Static

**Figure 8** *IP Address Settings Display*

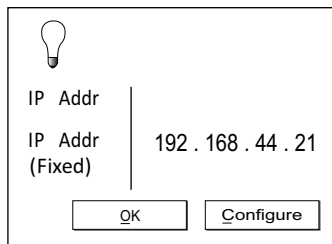

See "[Configure Static IP Address](#)" on page 36 or "[Configure DHCP](#)" on page 37 for procedures to configure IP Address settings.

## RS-232 Serial Interface

The Bird 4421A’s RS-232 interface feature is provided to allow remote measurement control. The RS-232 is only operational on models with the appropriate license installed and activated, see "[4421A Options](#)" on [page 2](#).

The RS-232 interface uses a standard 9-pin connector. The commands available for this interface are provided in [Chapter 4, 4421A SCPI Commands on page 20](#).

### Serial Port Setup

The Serial option on the  **Settings** menu is used to access the serial port settings menu.

The Serial Settings Menu is used to define serial connection settings. See "[4421A SCPI Commands](#)" on [page 20](#) for details on serial commands.

**Figure 9 Serial Settings Menu**

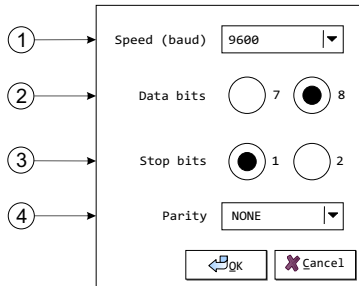

Item	Indicator	Description
1	Baud Rate	The Baud rate may be set to one of the following options: 300 600 1200 2400 4800 9600
2	Data Bits (word length)	Select either 7 or 8 bit data.
3	Stop Bits	Select 1 or 2 stop bits sent at the end of every character,
4	Parity	Options are: <b>NONE</b> - no parity bit is sent <b>EVEN</b> - parity bit is set so the number of “logical ones” is even. <b>ODD</b> - parity bit is set so the number of “logical ones” is odd.



## RS-232 Cable Connector

The interface uses a standard 9 pin connector. Pin assignments are listed in [Table 3](#). The 4421A serial port is wired as a “null modem” with all the handshaking signals looped back. The only active pins are 2 and 3, referenced to ground on pin 5.

**Table 3 RS-232 Pin Assignments**

Pin	Designation	Notes
1	Carrier Detected	Looped back to pins 4 & 6
2	Transmit Data	Transmit data from 4421A
3	Receive Data	Receive data from host
4	Data Terminal Ready	Looped back to pins 1 & 6
5	Ground	Ground
6	Data Set Ready	Looped back to pins 1 & 4
7	Clear to Send	Looped back to pin 8
8	Request to Send	Looped back to pin 7
9	Ring Indicator	Not connected

The 4421A supports legacy RS-232 commands used by Bird’s legacy 4421 Power Meter, and SCPI compliant commands over RS-232 or Ethernet.

- [4421A SCPI Commands](#) - 4421A SCPI commands used RS-232 or Ethernet interfaces. See "[4421A SCPI Commands](#)" on [page 20](#).
- [Legacy RS-232 Commands](#) - these commands are used by Bird’s legacy 4421 Power Meter, these commands will also work for the 4421A, if the [Use Legacy RS232](#) check box on the settings menu is selected, see "[Settings Menu](#)" on [page 10](#). See "[Legacy RS-232 Commands](#)" on [page 25](#) for available commands.

This chapter provides information for unpacking, inspection, and preparing the Bird Power Meter for use.

## Unpacking and Inspection

---

1. Carefully inspect shipping container for signs of damage.
2. Do one of the following:
  - If the shipping container is damaged, do not unpack the unit. Immediately notify the shipping carrier and Bird Electronic Corporation.
  - If the shipping container is not damaged, unpack the unit. Save shipping materials for repackaging.
3. Inspect unit for visual signs of damage.

**Note:** *If there is damage, immediately notify the shipping carrier and Bird Electronic Corporation.*

## Preparation for Use

---



**Note:** *The 4421A Power Meter is intended for indoor use only.*

## Charge the Battery

---

**Note:** *The internal batteries have built-in protection against overcharging.*

It is recommended that the batteries be charged before initial use.

- The AC power source required is 100 - 240 V @ 50/60 Hz, 1 $\phi$ , 30 W
1. Place the 4421A Power Meter on a stable work area.
  2. Connect Power Cord to AC power input connector on the 4421A.
  3. Plug the cable into the AC power source.
  4. Turn on the 4421A and make sure the charge icon is displayed. 
  5. Leave the 4421A on and connected to AC until the first full charge has been reached and the plug icon is displayed. 

**Note:** *This will ensure that the battery remaining % is accurate going forward.*

## Setup

Setup consists of ensuring the 4421A has a power source, internal batteries or AC power source, and attaching a Bird Power Sensor.

- Use the 4421A in a dry, dust-free environment.
  - AC power source, if used, is 100 - 240 V @ 50/60 Hz, 1 $\phi$ , 30 W.
1. Press the power button on the left side of the 4421A.
  2. Connect the sensor cable to one of the sensor cable connectors on the right side of the 4421A. See [Figure 10](#).
  3. Connect the remaining end of the sensor cable to a power sensor.

**Note:** *The 4421A's display should indicate a sensor has been connected.*

## Sensor RF Connections

### WARNING

Never attempt to connect or disconnect RF equipment from the transmission line while RF power is applied.  
Leaking RF energy is a potential health hazard.

### CAUTION

Do not exceed the RF Power or RF frequency specifications of the RF Power Sensor.

1. Connect the RF Power Sensor's output connector to the load.
2. Connect the RF Power Sensor's input connector to the RF source.

**Figure 10** 4421A Connections

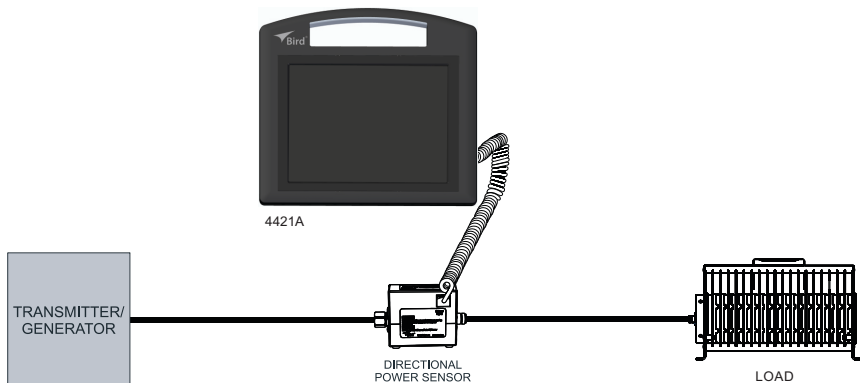

## VESA Mount

---

The 4421A is designed to attach a VESA mount with two 75mm spacing holes. There are two screw locations located on the rear of the 4421A enclosure, see [Figure 11](#).

## Mounting Hardware

---

The following hardware is required (not supplied) to mount the 4421A.

- Two screws, thread-Forming, for thin plastic, M2.5 size, 10 mm long
- Two oversized washers, M2.5 screw size, 2.7 mm ID, 8 mm OD
- VESA Mount with 75mm hole spacing

## Installation

---

1. Position the VESA mount on the rear of the 4421A enclosure.
2. Insert the recommended screws into the washers, then drive screws into the indented holes on the rear of the 4421A. The screw will break through a thin plastic barrier.

**CAUTION**

Do not over tighten the screws. Over tightening will strip the plastic and the screw will not hold the 4421A to the VESA mount.

3. Lightly hand tighten until snug.

**Figure 11 VESA Mount**

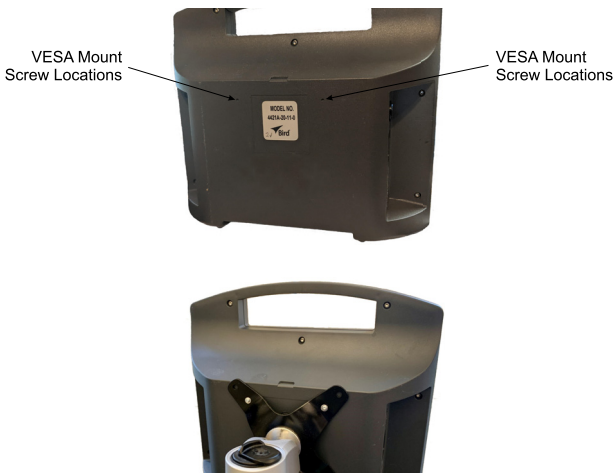

## Normal Operation

---

### WARNING

Never attempt to connect or disconnect RF equipment from the transmission line while RF power is applied.  
Leaking RF energy is a potential health hazard.

**Note:** *The 4421A Power Meter is intended for indoor use only.*

## Power On

---

**Note:** *This procedure assumes the RF Power Sensor is already installed in the RF transmission line. See ["Setup" on page 17](#) for additional information regarding setup of the 4421A.*

1. Press Power button on the Bird 4421A power meter side panel.
2. The 4421A takes approximately 30 seconds to complete the boot-up sequence.
3. If required, connect the AC power cable to the 4421A.
4. Connect the sensor cable to one of the sensor cable connectors on the right side of the 4421A.
5. Connect the remaining end of the sensor cable to a power sensor.

**Note:** *The 4421A's display should indicate a sensor has been connected.*

6. Repeat [step 4](#) and [step 5](#) to connect a second RF sensor to the 4421A.

## Power Off

---

1. Press and release the power button for normal power down.
2. If required, disconnect the AC power supply cable.
3. If required, disconnect the sensor cable(s) from the sensor cable connector(s) on the right side of the 4421A.

4421A Standard Commands for Programmable Instruments (SCPI) commands are used to control the 4421A over Ethernet or RS-232 interface.

## 4421A SCPI Command Syntax

---

A command is made up of one or more keywords. Consecutive keywords are separated with colons (:). The keywords are followed by a parameter.

**Table 4** *Optional Keywords and Parameters*

Characters	Meaning	Example
[ ]	Square brackets indicate that the enclosed keywords or parameters are optional when composing the command. These implied keywords or parameters will be executed even if they are omitted.	MEASure[:SCALar][:POWer][:FORWard]:AVERage?

**Table 5** *Command Syntax*

Characters, Keywords, and Syntax	Example
Upper- case lettering indicates the minimum set of characters required to execute the command. But, each mode of the command must be in either short form or the complete long form (no in between). Example: Correct: :IDEN :IDENtity Incorrect: :IDENti	SYSTem:IDENtity:FWRev?  SYST:IDEN:FWR? is the minimum requirement.

Lower- case lettering indicates the portion of the command that is optional; it can either be included with the upper- case portion of the command or omitted. This is the flexible format principle called forgiving listening. See " <a href="#">4421A SCPI Commands</a> " on page 22 for more information.	:IDENtity  Either :IDEN, :IDENtity, or :IDENtITY is correct.
A colon must be placed between two command mnemonics.	SYSTem:IDENtity:FWRev?
White space characters, such as <tab> and <space>, are generally ignored as long as they do not occur within or between keywords. However, you <u>must</u> use white space to separate the command from the parameter.	:POW er or MEASure :POW er :AVERAge? are not allowed.  A <space> between :AVERAge? and 1 is mandatory. MEASure :POW er :AVERAge? 1

**Table 6 Data Types**

Data Type	Description	Maps to Internal
<NR1>	Signed integer numeric response data. Examples: 123, +456, -789	PARAM_TYPE_SIGNED_INTEGER
<NR2>	Floating point numeric response data without exponent. Examples: 1.23, +4.56, -0.789	PARAM_TYPE_FLOAT
<arbitrary_ascii>	Arbitrary 7-bit ASCII response data. Not enclosed in quotes.	PARAM_TYPE_ARB_ASCII

## 4421A SCPI Commands

---

### Common Commands

---

\*IDN?

**Description** — Identification Query

**Parameter Type** — <arbitrary\_ascii>

**Parameter Minimum** —

**Parameter Maximum** —

**Parameter Default** —

**Parameter Values** —

**Parameter Units** —

**Response** — Returns device identification in the following format:

BIRD-TECHNOLOGIES,{model},{serial number},{firmware revision}

---

### Measure Commands

---

MEASure[:SCALar][:POWER][:FORWARD]:AVERAge? [1 or 2]

**Description** — initiate, and retrieve a forward average power measurement. The sensor channel to read (1 or 2) is omitted, channel 1 is returned.

**Parameter Type** — <NR1>

**Parameter Minimum** — 1

**Parameter Maximum** — 2

**Parameter Default** — 1

**Parameter Values** —

**Parameter Units** —

**Response** — Returns the forward average power in W from the specified sensor channel. Parameter Type: <NR2>, Parameter Units: W.



MEASure[:SCALar][:POWER]:REFlected:AVERage? [1 or 2]

**Description** — initiate, and retrieve a reflected average power measurement.

**Parameter Type** — <NR1>

**Parameter Minimum** — 1

**Parameter Maximum** — 2

**Parameter Default** — 1

**Parameter Values** —

**Parameter Units** —

**Response** — Returns the Reflected average power in W from the specified sensor channel. Parameter Type: <NR2>, Parameter Units: W.

---

## System Commands

---

SYSTem:IDENtity:FWRev?

**Description** — Get the firmware revision(s).

**Parameter Type** — <arbitrary\_ascii>

**Parameter Minimum** —

**Parameter Maximum** —

**Parameter Default** —

**Parameter Values** —

**Parameter Units** —

**Response** — Reads the MCU firmware revision.

SYSTem:IDENtity:MODEl?

**Description** — Get the device model name.

**Parameter Type** — <arbitrary\_ascii>

**Parameter Minimum** —

**Parameter Maximum** —

**Parameter Default** —

**Parameter Values** —

**Parameter Units** —

**Response** — Returns the model number as given in the [\\*IDN?](#) response.

### SYSTem:IDENtity:SN?

**Description** — Get the device serial number.

**Parameter Type** — <arbitrary\_ascii>

**Parameter Minimum** —

**Parameter Maximum** —

**Parameter Default** —

**Parameter Values** —

**Parameter Units** —

**Response** — Returns the serial number as given in the [\\*IDN?](#) response.

### SYSTem:PRESet

**Description** — Restores factory settings without changing the RS232 or LAN settings.

**Parameter Type** —

**Parameter Minimum** —

**Parameter Maximum** —

**Parameter Default** —

**Parameter Values** —

**Parameter Units** —

**Response** — Restore factory default values for all operating parameters with the exception of the RS232 and LAN parameters.

### SYSTem:VERSion?

**Description** — Get the SCPI version.

**Parameter Type** — <NR2>

**Parameter Minimum** —

**Parameter Maximum** —

**Parameter Default** —

**Parameter Values** —

**Parameter Units** —

**Response** — Returns the SCPI version.

The legacy commands are those commands that are original to the predecessor 4421. To use these commands the [Use Legacy RS232](#) check box on the settings menu is selected, see "[Settings Menu](#)" on page 10.

**Note:** *Measurement commands in the legacy protocol only support one sensor. If two sensors are connected to the 4421A, the measurements will come exclusively from channel 1 (Sensor 1).*

## Legacy Command Syntax

---

The Bird 4421A accepts two types of commands. General bus commands are commands, such as Enter (ENT), that apply to any RS-232 interfaced device. Device-dependent commands are specific to the 4421A.

A group of device-dependent commands can be sent as a single string as long as like command categories are not repeated. For example: "FCT1ENT". This string sets up the 4421A to read forward carrier wave, make one reading on "T1", and triggers (ENT) a measurement.

**Note:** *Commands can be entered in either upper or lower case.*

**Note:** *Only the last command entered of each category will be executed. As a command string is processed by the 4421, each category of command is stored in a separate location. Two commands of the same category will be stored in the same location, so that the second will overwrite and erase the first one.*

## General Bus Commands

---

The general bus commands supported by the RS-232 interface module are listed in [Table 7](#).

**Table 7 RS-232 General Bus Commands**

Command	Effect on Bird 4421
INT	Returns to default conditions
ENT	Sends a reading to the controller

### INiTialize (INT)

**Function** Resets the Bird 4421 and returns it to the factory defaults.

**Remarks** If INT is linked with any other command within a string, it must be separated from that command by a space.

### ENTer (ENT)

**Function** Makes the power meter transmit a reading to the controller.

**Remarks** A measurement must have already been triggered, placing a reading in the output buffer.

To send a reading whenever a measurement is triggered, deselect the **Use Command Mode** check box on the settings menu. The ENT command will not need to be sent.

## Device Dependent Commands

The device-dependent commands used by the 4421 Power Meter are listed in [Table 8](#), organized by category.

**Table 8 RS-232 Device Dependent Command Summary**

Category	Command	Description
Measurement	FC	Forward carrier wave
	RC	Reflected carrier wave
Range	RYY	Auto range on <sup>1</sup>
	RNN	Auto range off, stay at present range
	R00 to R17	Set auto range to one of 18 manual ranges.
Terminators	YT	Two terminators: CR, LF <sup>1</sup>
Prefixes	PY	Prefix YES <sup>1</sup>
Triggers	T1	One shot on ENT
	T5	One shot on measurement command
Status	U0	
	U1	
	U2	
Self-Test	J0	
Production	UA	

1 dummy command, the setting they control has only one option.

**Forward Carrier Wave** (FC)

**Reflected Carrier Wave** (RC)

**Function** Selects forward or reflected RF power measurement mode.

**Remarks** Measurement results are returned in Watts.

**Range (Rxx)**

**Function** Selects a measurement range listed in [Table 9](#).

**Remarks** If the selected range is outside the range of the connected power sensor, the command is ignored.

**Table 9 Measurement Ranges**

Command	Power Range
RYY	Turn auto range on
RNN	Turn auto range off. Keep present range
R17	18.0 – 199.9 MW
R16	1.80 – 19.99 MW
R15	0.180 – 1.999 MW
R14	18.0 – 199.9 kW
R13	1.80 – 19.99 kW
R12	0.180 – 1.999 kW
R11	18.0 – 199.9 W
R10	1.80 – 19.99 W
R09	0.180 – 1.999 W
R08	18.0 – 199.9 mW
R07	1.80 – 19.99 mW
R06	0.180 – 1.999 mW
R05	18.0 – 199.9 $\mu$ W
R04	1.80 – 19.99 $\mu$ W
R03	0.180 – 1.999 $\mu$ W
R02	18.0 – 199.9 nW
R01	1.80 – 19.99 nW
R00	0.180 – 1.999 nW

**Terminators (YT)**

**Function** Selects the characters that follow the end of a data string. YT indicates for two terminators; a carriage return (CR) and a line feed (LF).

**Remarks** Many controllers use the terminator sequence to recognize the end of an input string. Using incorrect terminators can lock the bus.

**Prefixes (PY)**

**Function** Turns the prefix mode on.

**Remarks** Prefixes are sent over the bus with the measurement, and indicate the status of the current measurement (see [Table 10](#) for examples):

- “FC”, “RC” indicates the measurement type.
- “U” indicates underflow; the value sent is “.000”.
- “O” indicates overflow; the value sent is “199.9”.
- “N” indicates normal; the value sent is a normal on-scale reading.
- “4421” indicates the Bird model number.

**Table 10 Prefix Examples**

Data String	Description
NFC . 0 . 123W (CR) (LF)	Normal (N) forward carrier wave (FC), prefixes on
OFC 199 . 9W (CR) (LF)	Overflowed (O) forward carrier wave (FC), prefixes on
199 . 9W (CR) (LF)	Overflowed forward carrier wave, prefixes off
URC . 000W (CR) (LF)	Underflowed (U) reflected carrier wave (RC), prefixes on

**Triggers (Tx)**

**Function** Selects the condition which will trigger a reading (see [Table 11](#)).

**Remarks** Failure to trigger device before requesting a reading will lock the bus.

Fastest reading rate is 2.4 readings/second; slowest is 1 reading/sec.

**Table 11 Trigger Conditions**

Command	Trigger Condition
T1	One shot on ENT
T5	One shot on measurement command (FC, FD, RC, RD, SW, RL, MN, MX)

Status (Ux)

**Function** Reads a status word and returns the information as a string. Set x to:

- "0" for machine status.
- "1" for error status.
- "2" for revision history.

**Remarks** After sending the status command, a status word is sent the next time the unit is addressed to talk. To ensure the correct status is transmitted, the status word should be requested as soon as possible after the command is sent.

**Machine Status Word (U0)** — The format of the machine status word is shown in [Figure 12](#). The default values are also shown.

**Figure 12 Machine Status Word Format**

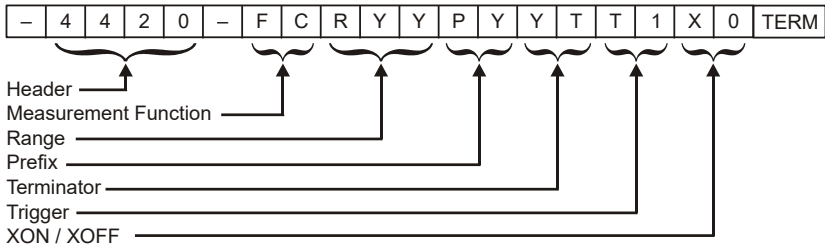

**Note:** *This command sets the unit to the settings that were last issued remotely. Therefore, it will over ride any manual changes selected at the front panel of the unit.*

**Error Status Word (U1)** — The format of the error status word and the possible error messages are shown in [Figure 13](#). All flags will revert to their non-error states after the U1 command is sent.

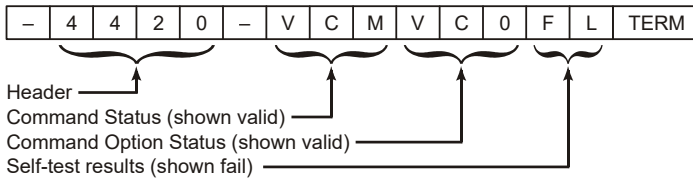
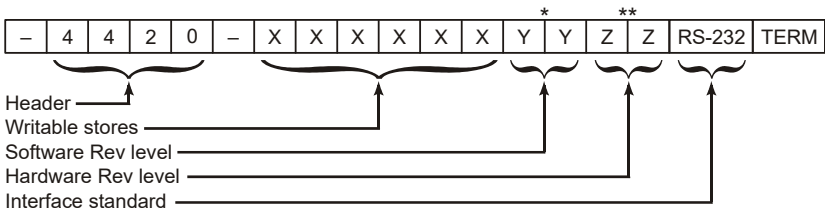

**Figure 13 Error Status Word Format**

Status	Meaning	Description
ICM	Invalid Command	Set when an illegal device-dependent command (IDDC) such as V2 is received. (V is illegal)
VCM	Valid Command	Set when no IDDC is received.
ICO	Invalid Command Option	Set when an illegal device-dependent command option (IDDCO) such as T6 is received. (6 is illegal)
VCO	Valid Command Option	Set when no IDDCO is received.
PS	Self-test Pass	Set when a self-test has been initiated by the J0 command and the test result is acceptable.
FL	Self-test Fail	Set when the self-test has failed. (This is the default condition.)

**Revision History Word (U2)** — The format of the revision history word is shown in [Figure 14](#).

**Note:** *This command is provided for legacy compatibility. The response is fixed.*

**Figure 14 Revision History Word Format**

\* YY is replaced with current software revision level.

\*\* ZZ is replaced with current hardware revision level.

Self Test (J0)

**Function** Initiates a hardware and software test.

**Remarks** Results are stored in the U1 status word (see "[Status \(Ux\)](#)" [on page 30](#)).

"J0" must be sent each time before reading the result.

**Note:** *Provided for legacy communications compatibility. The test always passes, results are presented in the U1 status response.*

Production Information (UA)

**Function** Returns production information string

**Remarks** UA <mac addr>;<dhcp ip addr>;<misc text><firmware rev date & time in UTC format> <uuid - a unique 36 character hex string><eol>

Ex: "UA f4:e1:1e:8f:46:7d;10.128.1.49;birdeng-VirtualBox  
2020-04-29T18:27:04-04:00 b7fe75e4-3aa9-48c2-a163-  
c4ceacbec8a2<CR><LF>"

PROBLEM	POSSIBLE CAUSE	CORRECTION
Power meter has no power	Are the batteries charged?	Connect the AC power cord to an AC outlet.
	Is the power meter’s AC power cord connected to an AC outlet?	Connect the power cord.
Power sensor is not automatically detected by the 4421A.	Is the sensor cable connected to both the power meter and power sensor?	Connect sensor cable.
	Is the sensor cable defective?	Replace sensor cable.
Battery remaining % does not agree with what is expected.	Battery fuel gauge has lost sync with the battery.	<p>Connect the AC power cord while the 4421A is running and wait for the battery indicator to display the plug icon .</p>  <p>This indicates that the charge cycle is complete and the fuel gauge has reestablished sync with the battery.</p>

This chapter describes routine maintenance. Service beyond this level, or that in [Chapter 6, Troubleshooting, page 33](#), return the unit to a qualified service center.

**WARNING**

To avoid personal injury, disconnect the power cord from the AC line before performing any maintenance.

**WARNING**

The Bird 4421A contains no user-serviceable parts.  
Do not open the cover.

## Routine Maintenance

---

The Bird 4421A Power Meter requires only simple, routine maintenance.

- Wipe off dust and dirt regularly. Disconnect this equipment from any AC outlet before cleaning. Use a damp cloth. Do not use liquid or spray detergents for cleaning.
- Check the connectors and cables for damage.

### Storing the 4421A

- If the 4421A is stored, charge the batteries every 6 months. See ["Charge the Battery" on page 16](#).

## AC Power Cable

---

Only replace the A/C input power supply cable with a cable of equivalent rating, and capable of supporting the 4421A power specifications, see ["Specifications" on page 45](#).

## Web User Interface

The Web UI is accessed by entering the 4421A's IP address in the web browser on a PC connected to the 4421A.

4421A's Fixed IP Address: 192.168.44.21

To access the WEB UI the PC connected to the 4421A must be on the same subnet as the 4421A. See "[Configuring PC Network Settings to 4421A Subnet](#)" on page 41.

### Figure 15 4421A Ethernet Connection

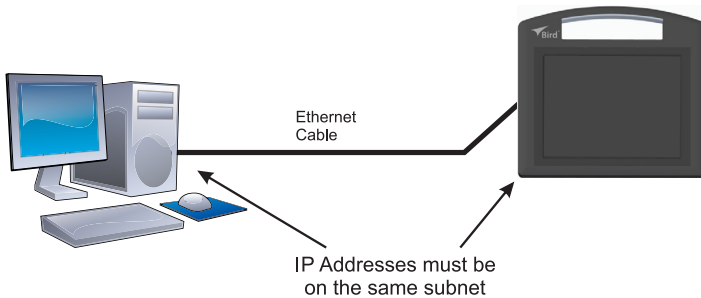

**Static IP Address Configuration** — The 4421A has a dual IP Address configuration. A Fixed IP Address (this address cannot be changed) and a configurable IP Address that can be set for DHCP or be set to a static IP Address.

- Static IP Address, see "[Configure Static IP Address](#)" on page 36.
- DHCP, see "[Configure DHCP](#)" on page 37.

**Web UI Description** — Provides a description of the screens that make up the Web User Interface, see "[Web UI Description](#)" on page 38.



**Touchscreen Calibration** — The touchscreen may need to be calibrated from time to time, the calibration must be reset using the web UI to initiate the calibration process.

See "[Touchscreen Calibration](#)" on page 39.

**Firmware Update** — The web user interface may be used to install any updates to the 4421A firmware released by Bird. See "[Firmware Update](#)" on page 42.

## Configure Static IP Address

**Note:** *NetMask and Gateway are optional.*

1. Tap the menu  ICON.
2. Tap the  **Settings** menu option, and select **LAN**.
3. Tap the Configure button. See [Figure 16](#).

**Figure 16** IP Address Display

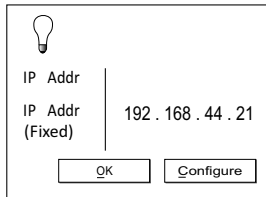

4. Select the manual radio button. See [Figure 17](#).

**Figure 17** IP Address Configuration Screens

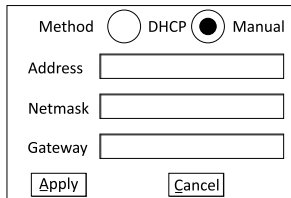

5. Tap in the Address Text area.
6. Enter the static IP Address using the keypad. See [Figure 18](#).

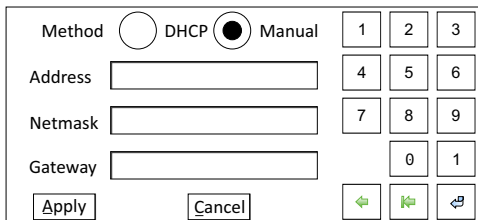

**Figure 18** IP Address Entry





7. Tap .

**Note:** *Netmask and Gateway are optional.*

8. Tap the Netmask text area, and enter the netmask.
9. Tap .

10. Tap the Gateway text area, and enter the Gateway IP Address.
11. Tap .
12. Tap Apply to save and exit.
13. Tap the menu  ICON.
14. Tap the  **Settings** menu option, and select **LAN**.
15. Verify the IP Address was saved.

## Configure DHCP

1. Tap the menu  ICON.
2. Tap the  **Settings** menu option, and select **LAN**.
3. Tap the Configure button. See [Figure 19](#).

**Figure 19** IP Address Display

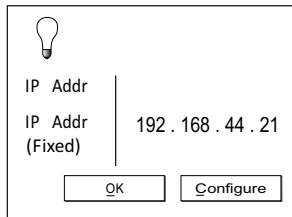

4. Select the DHCP radio button. See [Figure 20](#).

**Figure 20** DHCP Selection

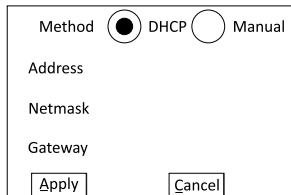

5. Tap Apply to save and exit.

## Web UI Description

The Web UI provides the user with several unit status displays and unit maintenance functions.

### Status Displays

There are three Status displays that provide information about the 4421A.

**Module Status** — Provides an overview of the 4421As current status including firmware version, time meter, Ethernet status, and file system details.

**Ethernet Status** — This screen provides detailed Ethernet, LO, and USB status information.

**Network Statistics** — Provides detail network packet statistics.

Figure 21 Status Displays

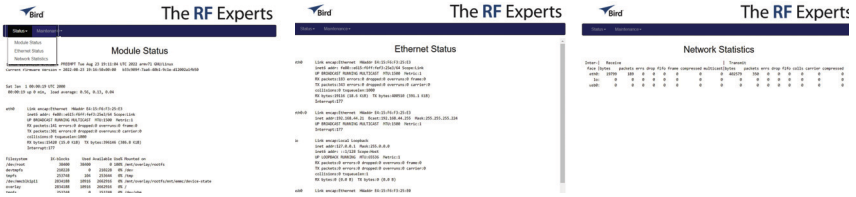

### Maintenance Displays

There are four maintenance screens which are used while performing procedures in this chapter of the manual.

**Upload Firmware** — Upload utility for updating 4421As firmware.

**Upload Bootloader** — Upload utility for updating 4421As bootloader.

**Restart** — Used for firmware/bootloader updates, to restart 4421A firmware.

**Touchscreen Calibration** — Used to reset touchscreen calibration and force a re-calibration at the next boot-up.

Figure 22 Maintenance Displays





## Touchscreen Calibration

1. Connect Ethernet cable between the PC and the Ethernet Port on the 4421A side panel.
2. Open a web browser on the PC.
 

**Note:** *The PC and 4421A must be on the same network subnet.*
3. Enter the 4421A's IP Address into the browser's address bar.
4. Wait for the WebUI to open.
5. On web UI's Maintenance menu select **Reset Touchscreen Calibration to Factory Defaults**. See [Figure 23](#).

**Figure 23** Maintenance Menu



6. Click **Yes** on the Reset the Touchscreen Calibration to Factory Defaults screen. See [Figure 24](#).

**Figure 24** Reset Touchscreen Calibration

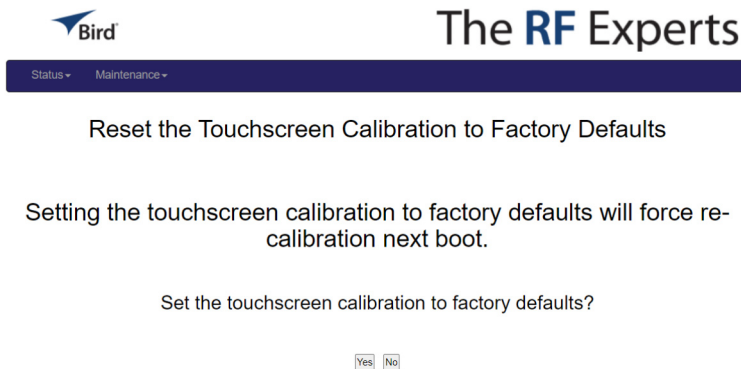

**Note:** *A popup confirmation message will be displayed.*

7. Click OK on the confirmation message to complete reset.
8. Wait for "Successfully Reset ...." message to be displayed.
9. Press power button on the side of the 4421A to remove power.

10. Power on the 4421A.
11. During the power up routine the calibration dialog will be displayed, see [Figure 25](#).

**Figure 25 Calibration Screen**



12. Tap each calibration point  as they are displayed, beginning in the upper left of the screen.

**Note:** *After tapping each calibration point in each corner of the display the 4421A will complete power up and display the RF measurement screen.*

## Configuring PC Network Settings to 4421A Subnet

---

Use this procedure to configure a PC to communicate via an Ethernet connection with the 4421A.

**Note:** *These instructions apply to a Windows 7/10 PC.*

1. Select **Start->Control Panel->Network and Sharing Center** on the PC.
2. Double-click the local area connection and
3. Click the **Properties** button.
4. Scroll to Internet Protocol Version 4 (TCP/IPv4) and double click.
5. Select Use the following IP address.
6. Enter the following settings:
  - ✓ IP address: 192.168.44.20
  - ✓ Subnet mask: 255.255.255.0
  - ✓ (Gateway is ignored)

**Note:** *These settings will allow the PC to communicate with the 4421A's Fixed IP address.*

7. Click the **OK** button for the Internet Protocol Version 4 (TCP/IPv4) Properties dialog.
8. Click the **OK** button to apply the connection properties.

## Restoring PC Network Connection to DHCP

---

1. Select **Start->Control Panel->Network and Sharing Center** on the PC.
2. Double-click the local area connection and
3. Click the **Properties** button.
4. Scroll to Internet Protocol Version 4 (TCP/IPv4) and double click.
5. Select "Obtain an IP Address Automatically".
6. Click the **OK** button for the Internet Protocol (TCP/IP) Properties dialog.
7. Click the **OK** button to apply the connection properties.

## Firmware Update

---

### Obtain Firmware

---

1. Firmware files for the 4421A may be downloaded from the product page on Birdrf.com.
2. Download the firmware file (.zip file).
3. Save the firmware file on the PC you will use to install the firmware on the 4421A.

### Install Firmware

---

**Note:** *The 4421A has dual IP Address capability, it has a fixed IP address of 192.168.44.21, and may have a second DHCP assigned, or static, IP address. See "[Configuring PC Network Settings to 4421A Subnet](#)" on page 41.*

1. Connect Ethernet cable between the PC and the Ethernet Port on the 4421A side panel.
2. Open a web browser on the PC.

**Note:** *The PC and 4421A must be on the same network subnet.*

3. Enter the 4421A's IP Address into the browser's address bar.
4. Wait for the WebUI to open.
5. Select **Update Module Firmware** from Maintenance menu. See [Figure 26](#).

**Figure 26** Maintenance Menu Selection



**Note:** *The firmware file will have the following characteristics: XXXXXXXX.tar.gz*

6. Click **Choose File**.
7. Navigate to the location of the firmware file on the PC.

Figure 27 Choose Firmware File

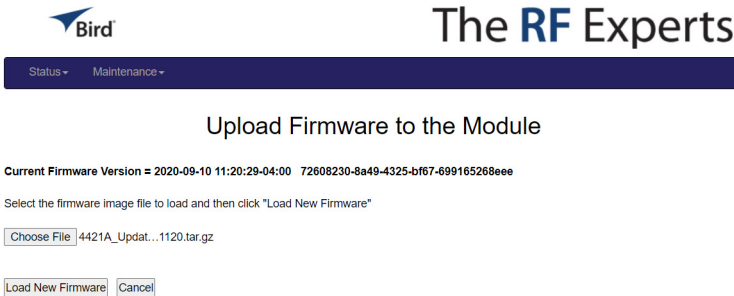

- Click the **Load New Firmware** button.

Figure 28 Load Firmware

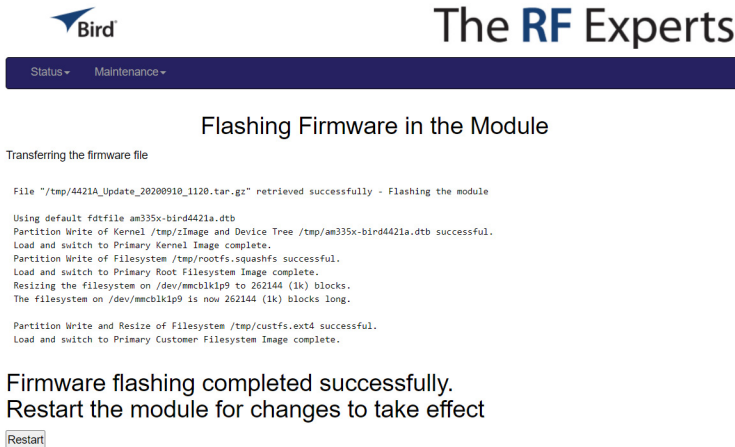

- Wait for "Firmware flashing completed successfully" message
- Click **Restart** button.
- Once restart is complete, verify the firmware update is complete.

## Storage and Shipment

---

### Storage

**CAUTION**

Do not store the 4421A outside the following temperature ranges

-10° to 50°C, ≤ 1 month

-10° to 35°C, ≤ 6 months

-10° to 25°C, > 6 months

Storage outside these temperature ranges may degrade battery capacity.

1. Cover Bird 4421A Power Meter before storing to keep out dust and dirt.
2. Store in a dry, dust-free environment where the ambient temperature will remain between those specified in "[Specifications](#)" on page 45 for the intended period of storage.
3. Disconnect Power Meter from the power source to avoid damage by transient over-voltage.
4. If storage will last longer than 6 months, or below 0°C, charge the batteries as specified in "[Routine Maintenance](#)" on page 34.

### Shipment

Package instrument using the original shipping container. If the original shipping container is not available, use a corrugated box. Place shock absorbing material around all sides of the instrument to prevent movement during handling or shipment. Equipment packaging shall be in accordance with best commercial practices.

## Customer Service

---

Any maintenance or service procedure beyond the scope of those in this chapter should be referred to a qualified service center.

If the unit needs to be returned for any reason, request an Return Material Authorization (RMA) through the Bird Technologies website. All instruments returned must be shipped prepaid and to the attention of the RMA number.

### Bird Service Center

30303 Aurora Road  
Cleveland (Solon), Ohio 44139-2794  
Fax: (440) 248-5426  
E-mail: [bsc@birdrf.com](mailto:bsc@birdrf.com)

For the location of the Sales Office nearest you, visit our Web site at:

<http://www.birdrf.com>

## Bird 4421A Power Meter Specifications

**Note:** *The 4421A Power Meter is intended for indoor use only.*

Compatible Bird Power Sensors All Models: 4421A-12-11-1:	Model Dependent: 4021, 4022, 4023, 4024, 4025, 4027, 4028 7027-series, 7037-series
Sensor Detection	Automatic Sensor detection
Dual sensor support	Two sensors may be connected and measurements displayed simultaneously. <b>Note:</b> <i>Dual-sensor support requires dual-sensor license is purchased and activated.</i>
Connection to sensor	Wired
Display	
Type	9.7" TFT full color LCD (LED back light), touch screen
Resolution	1024x768
Calibration interval	Not required
I/O Connectors RS-485 (Sensor) Ethernet Serial, RS-232	2 1 1
Environment	
Operating Temperature	0° to 40° C (32° to 104° F)
Storage Temperature	-10° to 50°C, ≤ 1 month -10° to 35°C, ≤ 6 months -10° to 25°C, > 6 months <b>Note:</b> <i>Storage temperature limited by battery specification. Storage outside this range may degrade battery capacity. For best performance, a full recharge is recommended every 6 months or if stored below 0°C.</i>
Operating Relative Humidity	95% Max (non condensing)
Max Operating Altitude	6400 m

## 4421A Power Meter

---

AC/DC Power Supply	
Input Voltage	100 - 240 V @ 50/60 Hz, 1 $\phi$ , 30 W.
Main Supply Voltage Fluctuations	$\pm 10 \%$
Over-voltage Category	Category II
Pollution Degree	2
Certifications	MIL28800 CLASS 4; SGS
Physical Characteristics	
Dimensions, nominal:	H x W x D 9 11/16 in. x 10 5/8 in. x 3 37/64 in. (246 mm x 270 mm x 91 mm)
EMC	Directive 2014/30/EU EN 61326-1
UL & CAN/CSA	Directive 2014/35/EU EN 61010-1 EN 61010-2-030



## 4421A Rack Mounting Kit

---

The Bird 4421A Rack Mounting Kit (Bird Part Number 4421A-RM1) lets you mount the 4421A into any EIA standard 19" rack. The pan/tilt feature allows four direction movement of the 4421A, making it easy to find the perfect viewing angle.

The 4421A can be mounted anywhere from 1/2" up to 9-1/2" depth in a rack in increments of 1/4".

All Rack Mount assembly hardware and rack mounting hardware is included.

**Figure 29** *Rack Mount Kit*

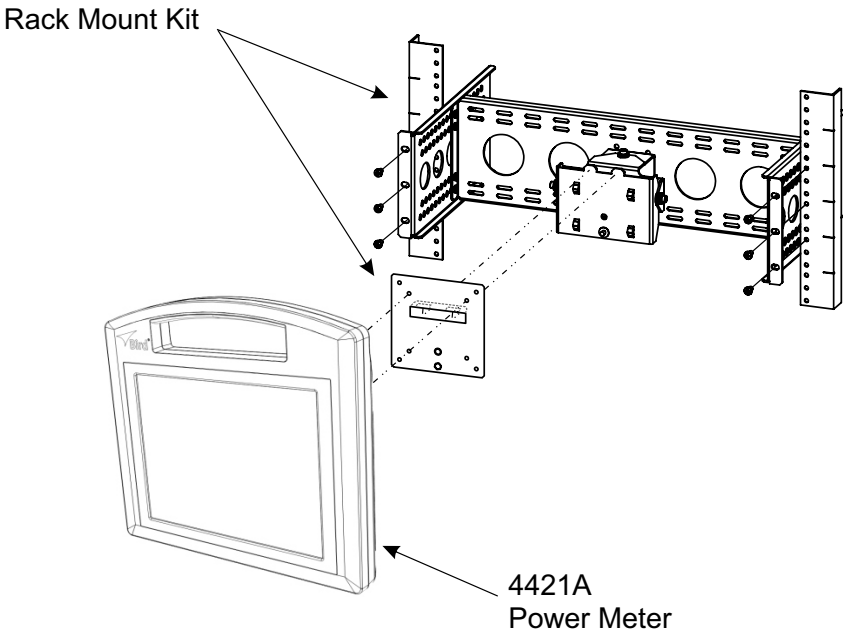

After the Rack Mounting kit is installed in a rack, the 4421A can be removed and reinstalled without the use of any tools.

## Rack Mount Kit Assembly

This section provides unpacking, inspection, and assembly instructions for the 4421A Rack Mount Kit.

### Rack Mount Kit Contents

The Rack mount kit includes the brackets and sub-assembly shown in [Figure 30](#) and attaching hardware listed below.

**Figure 30** Rack Kit Contents

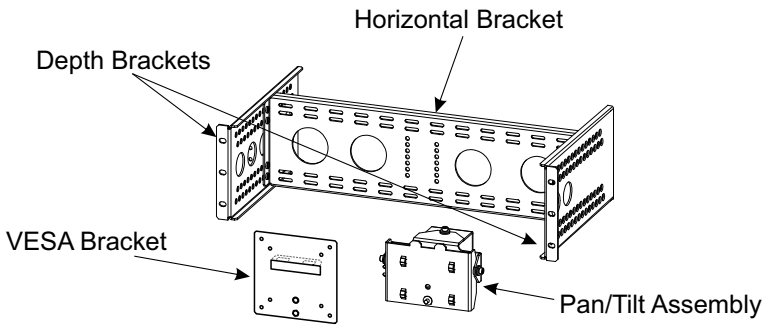

### Assembly Instructions

Attaching Hardware	Quantity	Description
VESA Bracket Hardware	3	#4 flat washers
	3	8mm Torx Screws
Assembly Hardware	2	10-32 Pan Head Screws
	4	10-32 Flat Head Screws
Rack Mount Hardware	8	12-24 Square Nuts
	8	12-24 Cage Nuts (Black)
	8	12-24 Pan Head Screws
	8	10-32 Pan Head Screws

## Attach VESA Bracket to the 4421A

1. Lay the 4421A face down on a flat work surface.
2. Position the VESA bracket on the rear panel of the 4421A enclosure. See [Figure 31](#).

**Figure 31 Attach VESA Bracket**

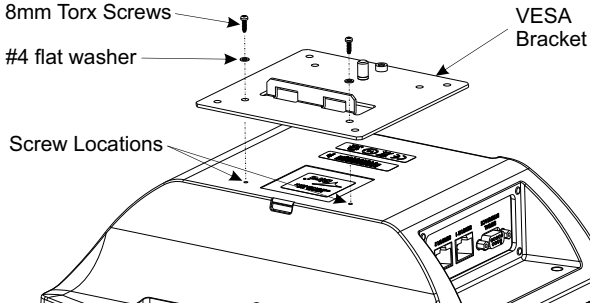

3. Insert the screws into the washers, then drive screws into the indented holes on the rear of the 4421A. The screw will break through a thin plastic barrier.

### CAUTION

Do not over tighten the screws. Over tightening will strip the plastic and the screw will not hold the 4421A to the VESA bracket.

4. Lightly hand tighten until snug.

## Rack Kit Assembly

### Pan/Tilt Assembly Attachment

1. Lay the Pan/Tilt Assembly face down on a flat work surface, see [Figure 32](#).

**Figure 32 Pan/Tilt Assembly Attachment**

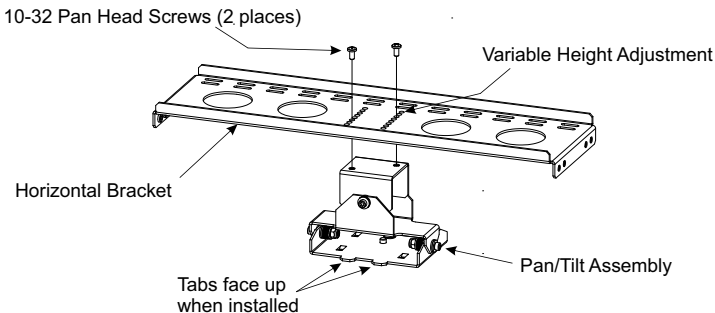

2. Position the Horizontal Bracket over the Pan/Tilt Assembly.

**Note:** Multiple holes in the Horizontal Bracket allow for the vertical adjustment of the 4421A position when installed in the rack.

3. Align holes in the Horizontal Bracket, at the desired vertical height, with the threaded holes in the Pan/Tilt Assembly.
4. Install two 10-32 Pan Head Screws.

### Depth Bracket Attachment

**Note:** The holes in the Depth Brackets determine how far into the rack the 4421A will be when mounted to the Rack Mount Assembly.

1. Secure one of the Depth Brackets to the Horizontal Bracket using two 10-32 Flat Head Screws.
  2. Secure remaining Depth Bracket to the Horizontal Bracket using two 10-32 Flat Head Screws.
- Ensure same depth measurement is used for both Depth Brackets.

**Figure 33** Depth Bracket Attachment

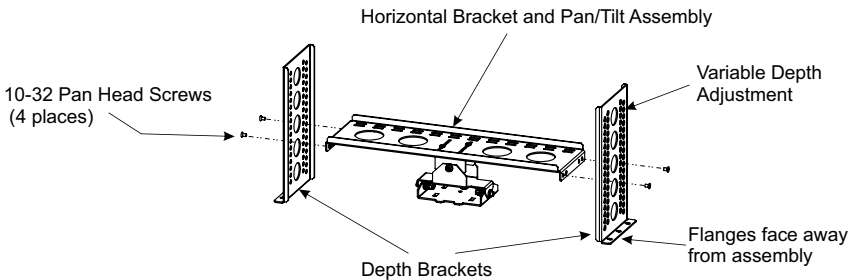

## Rack Installation

Attach the Assembly to the Rack using six (6) of the appropriate Rack Mounting Hardware.

**Figure 34** *Rack Installation*

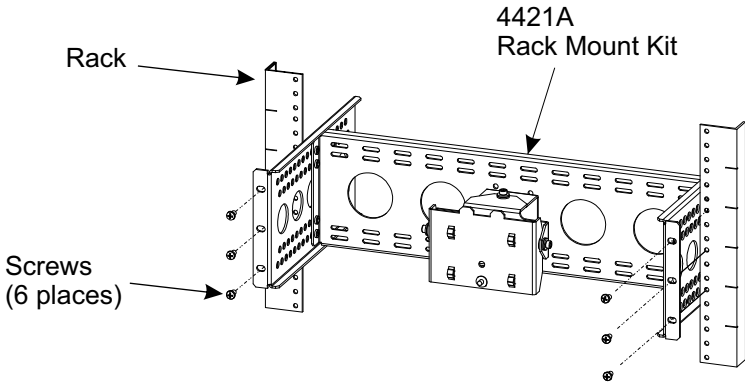

The Rack Hardware Kit provides various screws and nuts for the four most common types of racks.

- Square Hole Racks: Install Cage Nuts in appropriate positions. Attach with the larger 12-24 Screws.
- Round Hole Racks (non-threaded): Attach with the larger 12-24 Screws and the square nuts.
- 12-24 Threaded Racks: Attach with the larger 12-24 Screws.
- 10-32 Threaded Racks: Attach with the smaller 10-32 Screws.

## Attach 4421A to Rack Mount

---

The VESA bracket attached to the 4421A allows the unit to easily connect and disconnect with the rack mount.

1. Position the slots on the 4421A VESA Mount over the tabs on the top of the Pan/Tilt Assembly.

**Figure 35 Attach 4421A to Rack Mount**

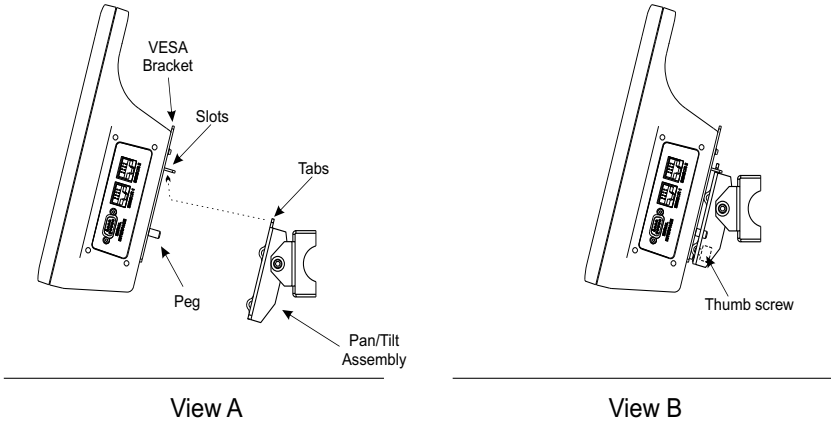

2. Insert the peg on the VESA Mount into the hole on the Pan/Tilt Assembly.
3. Tighten the Thumb Screw on the back of the Pan/Tilt Assembly to secure the 4421A to the Rack Mount Assembly.

# Limited Warranty

All products manufactured by Seller are warranted to be free from defects in material and workmanship for a period of one (1) year, unless otherwise specified, from date of shipment and to conform to applicable specifications, drawings, blueprints and/or samples. Seller's sole obligation under these warranties shall be to issue credit, repair or replace any item or part thereof which is proved to be other than as warranted; no allowance shall be made for any labor charges of Buyer for replacement of parts, adjustment or repairs, or any other work, unless such charges are authorized in advance by Seller.

If Seller's products are claimed to be defective in material or workmanship or not to conform to specifications, drawings, blueprints and/or samples, Seller shall, upon prompt notice thereof, either examine the products where they are located or issue shipping instructions for return to Seller (transportation-charges prepaid by Buyer). In the event any of our products are proved to be other than as warranted, transportation costs (cheapest way) to and from Seller's plant, will be borne by Seller and reimbursement or credit will be made for amounts so expended by Buyer. Every such claim for breach of these warranties shall be deemed to be waived by Buyer unless made in writing within ten (10) days from the date of discovery of the defect.

The above warranties shall not extend to any products or parts thereof which have been subjected to any misuse or neglect, damaged by accident, rendered defective by reason of improper installation or by the performance of repairs or alterations outside of our plant, and shall not apply to any goods or parts thereof furnished by Buyer or acquired from others at Buyer's request and/or to Buyer's specifications. Routine (regularly required) calibration is not covered under this limited warranty. In addition, Seller's warranties do not extend to the failure of tubes, transistors, fuses and batteries, or to other equipment and parts manufactured by others except to the extent of the original manufacturer's warranty to Seller.

The obligations under the foregoing warranties are limited to the precise terms thereof. These warranties provide exclusive remedies, expressly in lieu of all other remedies including claims for special or consequential damages. SELLER NEITHER MAKES NOR ASSUMES ANY OTHER WARRANTY WHATSOEVER, WHETHER EXPRESS, STATUTORY, OR IMPLIED, INCLUDING WARRANTIES OF MERCHANTABILITY AND FITNESS, AND NO PERSON IS AUTHORIZED TO ASSUME FOR SELLER ANY OBLIGATION OR LIABILITY NOT STRICTLY IN ACCORDANCE WITH THE FOREGOING.

