

Avery Dennison Cable Tie & Engineered Fastener Guide

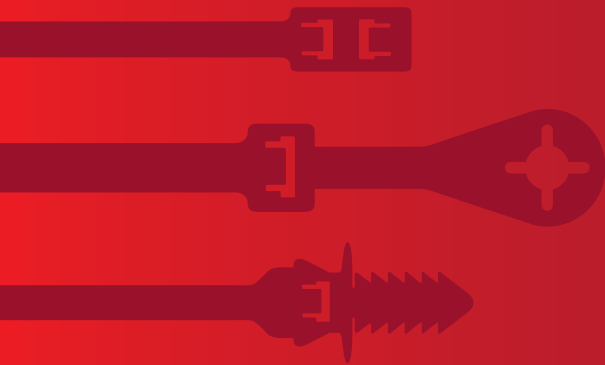
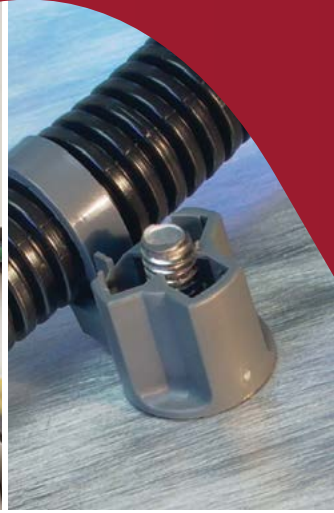

TABLE OF CONTENTS

PAGE	CATEGORY
------	----------

9	Standard Ties
----------	----------------------

Miniature Ties

Intermediate Ties

Standard Ties

11	Heavy Duty & Extra Heavy Duty Ties
-----------	---

Heavy Duty Ties

Extra Heavy Duty Ties

12	Super Bar-Lok® Ties
-----------	----------------------------

Super Bar-Lok® Ties

Super Bar-Lok® Cable Ties Are Superior to Most Conventional Cable Ties

13	Ladder Ties
-----------	--------------------

Ladder Style Ties

Eco Friendly 6/6 Nylon Ladder Ties

14	Security Ties
-----------	----------------------

Secur-A-Tie®

Secur-A-Seal®

Security Ties

16	Slim Line Ties
-----------	-----------------------

Slim Line Ties

17	Specialty Ties
-----------	-----------------------

Stopper Ties

Merchandise Pairing Ties

Double Headed Cable Ties

Releasable Cable Ties

19	PUSH Mount Ties
-----------	------------------------

Push Mount Ties

Winged Push Mount Ties

20	Screw Mount Ties
-----------	-------------------------

Screw Mount Ties

PAGE	CATEGORY
------	----------

21	Identification Ties
-----------	----------------------------

Identification Cable Ties

22	Accessories
-----------	--------------------

Adhesive Mount

Anchor Base

Screw Mount

Screw Cradle Mount

IDENTIFICATION PLATE

25	Cable Tie Installation Tools
-----------	-------------------------------------

Manual Cable Tie Tool

Pneumatic Cable Tie Tool

Cable Tie Tool Recommended Tension Settings

28	Automotive
-----------	-------------------

30	Engineered Fasteners
-----------	-----------------------------

Low Insertion Fir Tree (LIFT™) Ties

High Heat Resistant Ties

32	Hole Ties
-----------	------------------

Round Hole Fir Tree

Offset Round Hole Fir Tree

Oval Hole Fir Tree

Offset Oval Hole Fir Tree

Round Hole Arrow

Oval Hole Arrow

Offset Arrow

36	Stud Ties
-----------	------------------

Stud Mount

36	Connector Ties
-----------	-----------------------

Connector Ties

37	Gasketed Ties
-----------	----------------------

Gasketed Ties

37 Specialty Ties

Convoluted Tubing Tie

Double Strap

Stopper Ties

38 Contractor Grade Cable Ties

Small Part Numbering

CT 0190 N 050 N M

3-1/8" MINIATURE

4" MINIATURE

5.5" MINIATURE

8" MINIATURE

7.5" STANDARD

11" STANDARD

14.5" STANDARD

17" STANDARD

17.75" STANDARD

19.6875" STANDARD

13.5" HEAVY DUTY

15" HEAVY DUTY

21.6875" HEAVY DUTY

24" EXTRA HEAVY DUTY

28" EXTRA HEAVY DUTY

36" EXTRA HEAVY DUTY

48" EXTRA HEAVY DUTY

SLIM LINE

PUSH MOUNT

SCREW MOUNT

RELEASABLE (FLAT IN-LINE RELEASE)

IDENTIFICATION

MOUNT

INSTALLATION TOOL

43 Military Specifications Cross Reference

EVERY DENNISON CABLE TIES

Applications

Clockwise from top left:
Wire and Cable Bundling (Harnessing); Weld Stud; Securing Items in Packages; Mounting Applications; Security Tagging

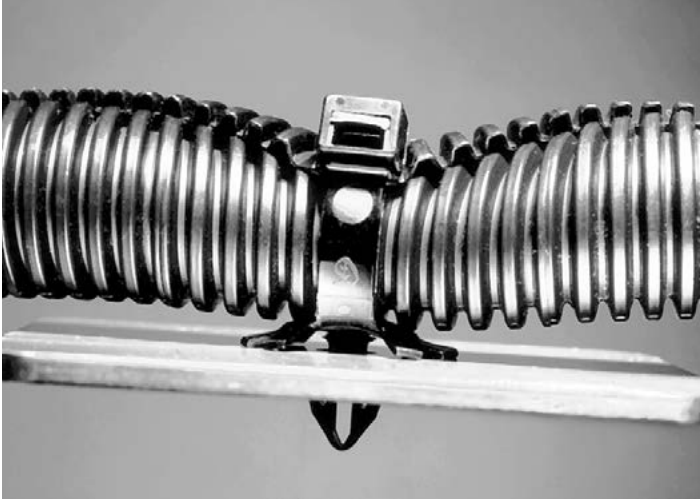
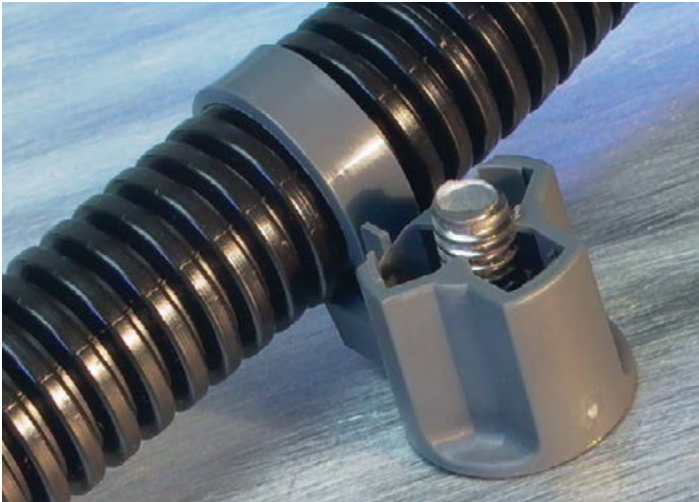
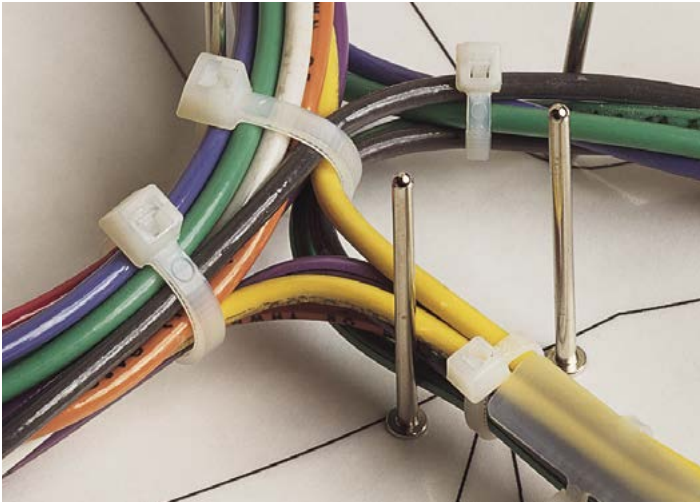

CABLE TIE PRODUCT CERTIFICATIONS

Avery Dennison® Cable Tie Products Meet Specifications Where Applicable

Avery Dennison Fastener Solutions Cable Ties and Engineered Fasteners products contain no prohibited, restricted, or reportable substance of concern including;

Bisphenol A • PBBs • PBBEs • OBDEs • PBDEs • Phthalates • Butylated hydroxytoluene BHT

DECLARATION OF COMPLIANCE FROM AVERY DENNISON

Avery Dennison hereby declares that our products and raw materials comply with 2005/84/EC and the most updated QSOP 3610 non-phthalates requirement.

RoHS Recast



RoHS Recast
Compliant with
CPSIA—HR4040

Avery Dennison Fastener Solutions Division certifies that all plastic products, including: Cable Ties and Engineered Fasteners are in compliance with Directive 2011/65/EU of the European Parliament on the restriction of the use of certain hazardous substances in electrical and electronic equipment (also known as “RoHS Recast”).

ECHA



Avery Dennison Fastener Solutions Division plastic products, including: Cable Ties and Engineered Fasteners do not contain any of the Substances of Very High Concern (SVHC) according to Regulation (EC) No 1907/2006 of the European Parliament and of the Council of 18 December 2006 concerning the Registration, Evaluation, Authorization and Restriction of Chemicals (REACH).

Military Specification



Department
of the Navy
AS23190

Avery Dennison cable ties comply with AS23190 on the continuation of supplying Avery Dennison Cable Tie Fasteners to the Department of the Navy.

Underwriter Laboratories for UL Certification



Avery Dennison Cable Tie products comply with UL 62275 for non-metallic cable ties and their associated fixing devices used for the management and support of wiring systems in electrical installations.

Conflict Materials

Avery Dennison Fastener Division's plastic products do not contain any of the conflict minerals (tin, tungsten, tantalum, and gold) as defined by the United States Frank Dodd Act of 2010 and the associated SEC Conflict Materials regulation. None of these substances are in any of our Cable Tie products.

CPSIA

Our products are also in compliance with the Consumer Product Safety Improvement Act of 2008 (CPSIA – HR4040).

FACILITY CERTIFICATIONS

Fitchburg, Massachusetts, USA

ISO 9001:2015



Certification Body of TUV SUD AMERICA INC. certifies Avery Dennison implemented QMS in accordance with ISO 9001:2015 for Design and Manufacture of Plastic Cable Tie Fastener Products.

ISO: 14001:2015



**ISO 14001:2015
CERTIFIED**

Avery Dennison Fastener Solutions has been assessed by Orion Registrar and found to be in compliance with the Environmental Management System ISO 14001 applicable to the manufacture of plastic injection molded fasteners.

ISO 45001:2018



**ISO 45001:2018
CERTIFIED**

Avery Dennison Fastener Solutions has been assessed by Orion Registrar and found to be in compliance with the Occupational Health and Safety Standard ISO 45001 applicable to the manufacture of plastic injection molded fasteners.

IATF 16949:2016



Certification Body of TUV SUD Management Service GmbH certifies Avery Dennison has established a QMS for Design and Manufacture of Plastic Cable Tie Fastener Products for the Automotive Industry (with Product Design as per Chapter 8.3).

CABLE TIE BASICS AND KEY PERFORMANCE CRITERIA

Cable Ties Criteria

Polypropylene Resin

Used for applications requiring lower tensile strength.

NYLON RESINS

Natural

Used for outdoor applications because it has greater resistance to ultraviolet light. These cables ties contain 2% carbon black and the temperature range is -40° F (-40° C) to 176° F (80° C).

Weather Resistant (WR)

Used for for outdoor applications because it has greater resistance to ultraviolet light. These cables ties contain 2% carbon black and the temperature range is -40° F (-40° C) to 176° F (80° C).

Heat Stablized (HS)

Used for higher temperature applications and the temperature range for these ties is -40° F (-40° C) to 221° F (105° C).

Impact Modified, Heat Stabilized (IMHS)

Typically used for our automotive cable ties. These cable ties can withstand wide temperature fluctuations. The temperature range for these cable ties is -40° F (-40° C) to 239° F (115° C).

Impact Modified, High Heat (HHBN)

High Heat fastener solutions are a PA66 family of automotive ties that are formulated to withstand operating temperatures of up to 150°C. The physical characteristics of these high heat ties are identical to our current automotive fasteners made with PA66IMHS resin. These ties have been heat age tested for 1,000 hours at 150 degrees Celsius, and for more than 4,000 hours at 135 degrees Celsius, without any compromise to performance.

COLORS

Our 4" and 8" cable ties, security ties as well as Secur-a-Tie® and Secure-a-Seal® are available in colors. Other colors are available by special request.

The Bag

- Packaged at a specific moisture content
- Bags should not be opened prior to actual application
- Bags should be resealed between use
- Once applied, moisture changes will not affect performance

The Bag Label

Cable ties are packaged "Standard" and "Bulk"

- Standard—100 packs
- Bulk—1,000 packs

Avery Dennison Cable Tie Bags include:

- Maximum bundle diameter
- Military Specification number if applicable
- Strap ID code
 - Miniature
 - Intermediate
 - Standard
 - Heavy-duty
 - Extra heavy-duty

OVER 50 YEARS OF INNOVATIVE PRODUCT DEVELOPMENT

Unique Stretching Process

- SUPER BAR-LOK®
- LADDER TIE
- SECUR-A-TIE®

Avery Dennison has set the toughest standards in the industry. Cable ties meet almost all appropriate qualifications for military specifications and UL.

CABLE TIE BASICS AND KEY PERFORMANCE CRITERIA

Basic Components of a Standard Avery Dennison Cable Tie

HOW TO USE

1. Insert fastener tail into head
2. Form loop with teeth to inside
3. Rails guide strap through strap channel and over pawl
4. Tighten by hand or with installation tool

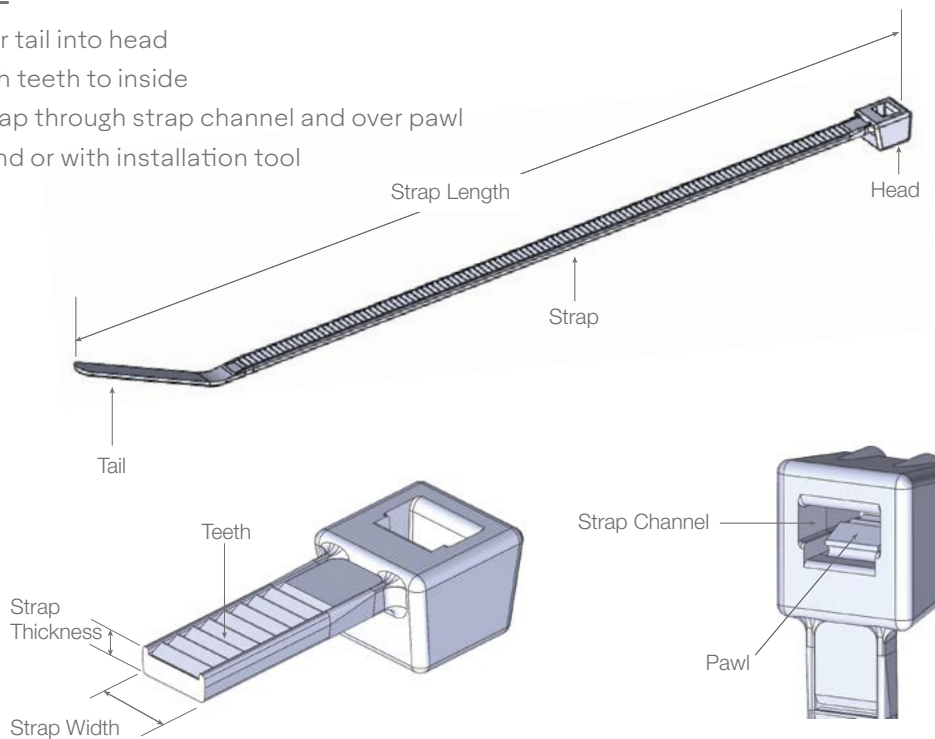

Cable Tie Key Performance Criteria

Minimum Loop Tensile Strength

Performance characteristic. The minimum amount of force expressed in Newtons that cause the assembled tie to fail. Higher tensile strength – big or heavy loads, lower tensile—small to medium and light loads.

Material

Avery Dennison cable ties are manufactured from Type 6/6 Nylon—noted for toughness, impact strength, resistance to abrasion and chemicals. Material of choice per military specifications.

Bundle Diameter

Maximum and minimum bundle diameters are size extremes in which the tie will function properly. They are set according to industry standards established by military specifications.

Cable ties are used in a variety of applications in many industries including: Electrical, electronics, CATV, HVAC, transportation, telecommunications, packaging, retail, beverage, automotive etc.

Avery Dennison cable ties are available in sizes from 4" to 34" and in three different materials with tensile strength ratings up to 175 lbf.

STANDARD TIES



Miniature Ties

4" / 101.6mm			PART #	MATERIAL	MILITARY SPEC.	BAG QTY.	CASE QTY.
Width	.95"	2.41mm	08432	Natural	MS-3367-4-9	1,000	25M
Thickness	.041"	1.04mm	08434	Natural	MS-3367-4-9	100	5M
Bundle Diameter (min. – max.)	1/16"–7/8"	1.59–22.23mm	08433	Black weather resistant	MS-3367-4-0	1,000	25M
Min. Loop Tensile Strength	18 lbf	8.17kgf / 80N	08435	Black weather resistant	MS-3367-4-0	100	5M
			08404	Black heat stabilized		1,000	1M
			08508	Red	MS-3367-4-2	1,000	10M
			08582	Orange	MS-3367-4-3	1,000	10M
			08583	Yellow	MS-3367-4-4	1,000	10M
			08584	Green	MS-3367-4-5	1,000	10M
			08587	Blue	MS-3667-4-6	1,000	10M



Intermediate Ties

5.5" / 139.7mm			PART #	MATERIAL	MILITARY SPEC.	BAG QTY.	CASE QTY.
Width	.140"	3.56mm	08376	Natural	MS-3367-4-9	1,000	5M
Thickness	.050"	1.27mm	08383	Natural	MS-3367-4-9	100	5M
Bundle Diameter (min. – max.)	1/16"–1-1/4"	1.59–22.23mm	08431	Black weather resistant	MS-3367-4-0	1,000	5M
Min. Loop Tensile Strength	40 lbf	18.14kgf / 178N	08384	Black weather resistant	MS-3367-4-0	100	5M
			08400	Black heat stabilized		1,000	5M

8" / 203.2mm			PART #	MATERIAL	MILITARY SPEC.	BAG QTY.	CASE QTY.
Width	.140"	3.56mm	08377	Natural	MS-3367-5-9	1,000	5M
Thickness	.050"	1.27mm	08385	Natural	MS-3367-5-9	100	5M
Bundle Diameter (min. – max.)	1/16"–2-1/8"	1.59–53.98mm	08380	Black weather resistant	MS-3367-5-0	1,000	5M
Min. Loop Tensile Strength	40 lbf	18.14kgf / 178N	08386	Black weather resistant	MS-3367-5-0	100	5M
			08401	Black heat stabilized		1,000	5M
			08690	Red	MS-3367-5-2	1,000	5M
			08671	Blue	MS-3367-5-6	1,000	5M
			08782	Yellow	MS-3367-5-4	1,000	5M
			08664	Green	MS-3367-5-5	1,000	5M

STANDARD TIES

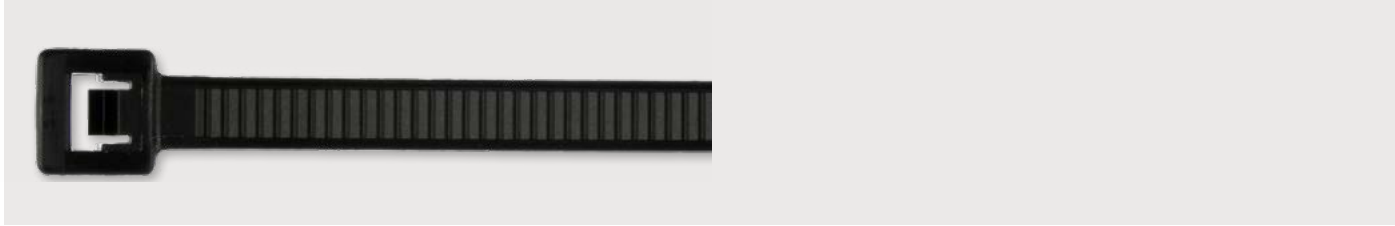

Standard Ties

7.5" / 190.5mm			PART #	MATERIAL	MILITARY SPEC.	BAG QTY.	CASE QTY.
Width	.177"	4.50mm	08387	Natural	MS-3367-1-9	1,000	5M
Thickness	.050"	1.27mm	08436	Natural	MS-3367-1-9	100	5M
Bundle Diameter (min. – max.)	1/16"–1-3/4"	1.59–44.45mm	08388	Black weather resistant	MS-3367-1-0	1,000	5M
Min. Loop Tensile Strength	50 lbf	22.68kgf / 222N	08437	Black weather resistant	MS-3367-1-0	100	5M
			08402	Black heat stabilized		1,000	5M

11" / 279.4mm			PART #	MATERIAL	MILITARY SPEC.	BAG QTY.	CASE QTY.
Width	.177"	4.50mm	08600	Natural	MS-3367-7-9	1,000	5M
Thickness	.053"	1.35mm	08859	Natural	MS-3367-7-9	100	5M
Bundle Diameter (min. – max.)	1/16"–3"	1.59–76.2mm	08286	Black weather resistant	MS-3367-7-0	1,000	5M
Min. Loop Tensile Strength	50 lbf	22.68kgf / 222N	08930	Black weather resistant	MS-3367-7-0	100	5M
			08056	Black heat stabilized		1,000	5M

15" / 381mm			PART #	MATERIAL	MILITARY SPEC.	BAG QTY.	CASE QTY.
Width	.177"	4.50mm	10036	Natural	MS-3367-2-9	500	5M
Thickness	.053"	1.35mm	08427	Natural	MS-3367-2-9	100	1M
Bundle Diameter (min. – max.)	1/16"–4"	1.59–101.6mm	10037	Black weather resistant	MS-3367-2-0	500	5M
Min. Loop Tensile Strength	50 lbf	22.68kgf / 222N	08428	Black weather resistant	MS-3367-2-0	100	1M
			10408	Black heat stabilized		500	5M
			08416	Black heat stabilized		100	1M

HEAVY DUTY AND EXTRA HEAVY DUTY TIES



Heavy Duty Ties

14.5" / 368.3mm			PART #	MATERIAL	MILITARY SPEC.	BAG QTY.	CASE QTY.
Width	.251"	6.38mm	10038	Natural	MS-3367-3-9	100	1M
Thickness	.074"	1.88mm	08378	Natural	MS-3367-3-9	50	1M
Bundle Diameter (min. – max.)	3/16"–4"	4.76–101.6mm	10039	Black weather resistant	MS-3367-3-0	100	1M
Min. Loop Tensile Strength	120 lbf	54.43kgf / 534N	08382	Black weather resistant	MS-3367-3-0	50	1M
			08403	Black heat stabilized		100	1M

21" / 533.4mm			PART #	MATERIAL	MILITARY SPEC.	BAG QTY.	CASE QTY.
Width	.303"	7.70mm	10606	Natural	MS-3367-3-9	50	1M
Thickness	.075"	1.91mm	10608	Black weather resistant	MS-3367-3-0	50	1M
Bundle Diameter (min. – max.)	1/4"–6"	4.76–152.4mm	10607	Black heat stabilized		50	1M
Min. Loop Tensile Strength	120 lbf	54.43kgf / 534N					

24" / 609.6mm			PART #	MATERIAL	MILITARY SPEC.	BAG QTY.	CASE QTY.
Width	.303"	7.70mm	10612	Natural	MS-3367-3-9	50	1M
Thickness	.075"	1.91mm	10614	Black weather resistant	MS-3367-3-0	50	1M
Bundle Diameter (min. – max.)	1/4"–7"	4.76–177.8mm	10613	Black heat stabilized		50	1M
Min. Loop Tensile Strength	120 lbf	54.43kgf / 534N					

28" / 711.2mm			PART #	MATERIAL	MILITARY SPEC.	BAG QTY.	CASE QTY.
Width	.303"	7.70mm	10618	Natural	MS-3367-6-9	50	1M
Thickness	.075"	1.91mm	10620	Black weather resistant	MS-3367-6-0	50	1M
Bundle Diameter (min. – max.)	1/4"–8"	4.76–203.2mm	10619	Black heat stabilized		50	1M
Min. Loop Tensile Strength	120 lbf	54.43kgf / 534N					

Extra Heavy Duty Ties

34" / 863.6mm			PART #	MATERIAL	MILITARY SPEC.	BAG QTY.	CASE QTY.
Width	.350"	8.89mm	10049	Natural		50	500
Thickness	.086"	2.18mm	10050	Black weather resistant		50	500
Bundle Diameter (min. – max.)	1/4"–10"	4.76–254mm					
Min. Loop Tensile Strength	175 lbf	79kgf / 778N					

SUPER BAR-LOK® TIES



Super Bar-Lok® Ties

Won't loosen or relax... even under most conditions of high heat, humidity or vibration

7.5" / 190.5mm			PART #	MATERIAL	MILITARY SPEC.	BAG QTY.	CASE QTY.
Width	.195"	4.95mm	10001	Natural	MS-3367-1-9	1,000	5M
Thickness	.038"	.97mm	10003	Black heat stabilized	MS-3367-1-0	1,000	5M
Bundle Diameter (min. – max.)	1/16"–1-3/4"	1.59–44.45mm					
Min. Loop Tensile Strength	50 lbf	22.68kgf / 222N					

15" / 381mm			PART #	MATERIAL	MILITARY SPEC.	BAG QTY.	CASE QTY.
Width	.195"	4.95mm	10344	Natural	MS-3367-2-9	500	5M
Thickness	.038"	.97mm	10006	Natural	MS-3367-2-9	100	1M
Bundle Diameter (min. – max.)	1/16"–4"	1.59–101.6mm	10345	Black heat stabilized	MS-3367-2-0	500	5M
Min. Loop Tensile Strength	50 lbf	22.68kgf / 222N	10008	Black heat stabilized	MS-3367-2-0	100	1M

Super Bar-Lok® Cable Ties Are Superior to Most Conventional Cable Ties

- **Highest Tensile Strength per Cross Section**
 - Exceeds military specification tensile strength test of 50 lbf. Applications where extra strength is needed with minimum cross section.
- **More Resistant to Cyclic Shock Fatigue**
 - Survives up to 70% longer than conventional solid ties when cyclically loaded in a looped configuration from 0 to 60 lbf. and back to 0 lbf. at a frequency of 1 cycle per second.
- **Virtually No Creep**
 - Does not loosen or relax even under high heat, humidity or vibration.
- **Lighter and More Flexible**
 - Natural fit for aerospace, marine, aviation and automotive industries
- **Highest Petrochemical Resistance**
 - Remains unaffected in applications where grease, oil and fuels are present.
- **More Resistant to Environmental Extremes**
 - Resistant to extreme temperatures, ultraviolet light and salt water spray.
- **Mil Spec and UL Approved**

LADDER TIES

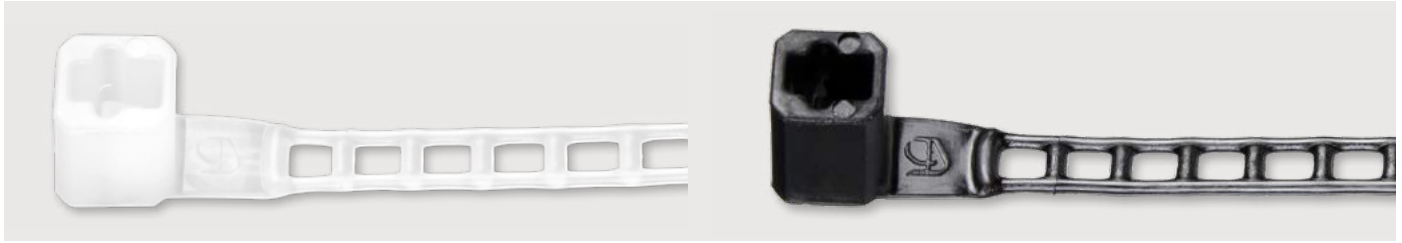

Ladder Style Ties

7" / 177.8mm			PART #	MATERIAL	MILITARY SPEC.	BAG QTY.	CASE QTY.
Width	.140"	3.56mm	08470	Natural		1,000	5M
Thickness	.040"	1.02mm	08476	Natural		100	5M
Bundle Diameter (min. – max.)	1/16"–1-3/4"	1.59–44.45mm	08472	Black heat stabilized		1,000	5M
Min. Loop Tensile Strength	40 lbf	18.14kgf / 178N	08478	Black heat stabilized		100	5M

11" / 279.4mm			PART #	MATERIAL	MILITARY SPEC.	BAG QTY.	CASE QTY.
Width	.140"	3.56mm	08471	Natural		1,000	5M
Thickness	.040"	1.02mm	08477	Natural		100	5M
Bundle Diameter (min. – max.)	1/16"–3"	1.59–76.2mm	08473	Black heat stabilized		1,000	5M
Min. Loop Tensile Strength	40 lbf	18.14kgf / 178N	08479	Black heat stabilized		100	5M

Eco Friendly 6/6 Nylon Ladder Ties

- Uses 60% less material when compared to a solid standard tie
- Weighs as much as 60% less when compared to a solid standard tie equivalent
- Save on shipping. The case of Ladder Ties are as much as 17% lighter. The individual bags as much as 5% lighter
- Forty percent of previously used nylon 6/6 material is used in the manufacturing process
- Consistently performs higher than the 40lb. tensile strength specification

When compared to its standard equivalent, the Ladder Tie is both friendly to our environment and cost effective.

The Ladder Tie has been accepted in the Automotive, Electronics and Industrial industries.

SECURITY TIES



Secur-A-Tie®

Permanent locking beaded loop fastener that adjusts for a custom fit. Commonly used in the retail market for tagging and securing merchandise for economical bundling and attaching solutions.

Secur-A-Tie®

5" / 127mm			PART #	MATERIAL	BAG QTY.	CASE QTY.
Width	n/a	n/a	08350	Natural	5,000	50M
Thickness	.070"	1.78mm	08354	Red	5,000	20M
Bundle Diameter (min. – max.)	1/16"–1-3/16"	1.59–30.16mm	08355	Yellow	5,000	20M
Min. Loop Tensile Strength	15 lbf	6.80kgf / 66.6N	08356	Blue	5,000	20M
			08358	Orange	5,000	20M
			08359	Black	5,000	20M
			08357	Green	5,000	20M
			08362*	Natural Polypropylene	5,000	50M
			10673	Natural	1,000	20M

* 08362 is 8 lb. tensile strength

8" / 203.2mm			PART #	MATERIAL	BAG QTY.	CASE QTY.
Width	n/a	n/a	08320	Natural	2,000	20M
Thickness	.070"	1.78mm				
Bundle Diameter (min. – max.)	1/16"–2"	1.59–50.8mm				
Min. Loop Tensile Strength	18 lbf	8.16kgf / 80N				



Secur-A-Seal®

Economical bundling along with a tamper evident head design. UL listed. Used for applications requiring lower tensile strength where tamper evident is required.

Secur-A-Seal®

8" / 203.2mm			PART #	MATERIAL	BAG QTY.	CASE QTY.
Width	n/a	n/a	08319	Natural	2,000	20M
Thickness	.070"	1.78mm	10146	Red	2,000	20M
Bundle Diameter (min. – max.)	1/16"–2"	1.59–50.8mm	10147	Orange	2,000	20M
Min. Loop Tensile Strength	8 lbf	3.63kgf / 35N	10148	Yellow	2,000	20M
			10149	Green	2,000	20M
			10150	Blue	2,000	20M
			10154	Black	2,000	20M
			10155	White	2,000	20M

SECURITY TIES

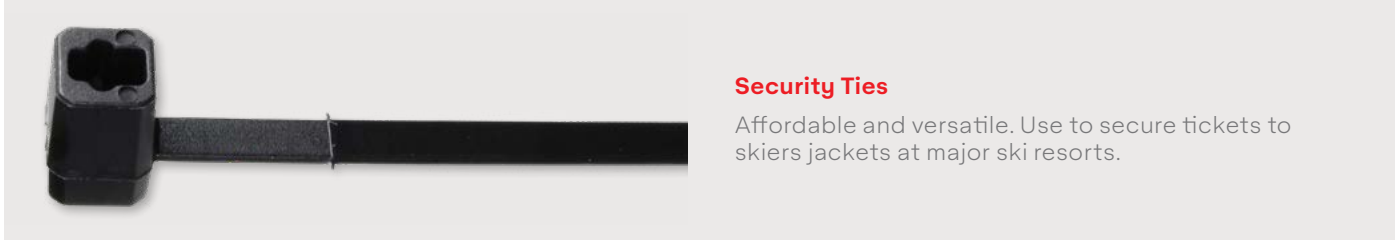

Security Ties

Affordable and versatile. Use to secure tickets to skiers jackets at major ski resorts.

Security Ties

5" / 127mm			PART #	MATERIAL	BAG QTY.	CASE QTY.
Width	.151"	2.8mm	20064-0	Black	1,000	5M
Thickness	.040"	1.1mm	20064-B	Blue	1,000	5M
Bundle Diameter (max.)		38.1mm	20064-G	Green	1,000	5M
Min. Loop Tensile Strength	30 lbf	13.6kgf / 133N	20064-R	Red	1,000	5M
			20064-P	Purple	1,000	5M
			20064-Y	Yellow	1,000	5M
			20064-ORG	Orange	1,000	5M

7" / 181mm			PART #	MATERIAL	BAG QTY.	CASE QTY.
Width	.151"	2.8mm	20004-N	Black	1,000	5M
Thickness	.040"	1.1mm				
Bundle Diameter (max.)		53.3mm				
Min. Loop Tensile Strength	30 lbf	13.6kgf / 133N				



Visit our [Cable Tie Product Selector](#) to find more fasteners, view all specifications & submit sample requests.

fastener.averydennison.com

SLIM LINE TIES



Slim Line Ties

With smaller head and narrower cross section is a good choice where space is limited.

Slim Line Ties

6" / 152.4mm			PART #	MATERIAL	MILITARY SPEC.	BAG QTY.	CASE QTY.
Width	.094"	2.39mm	10391	Natural	MS-3367-4-9	1,000	5M
Thickness	.044"	1.18mm	10394	Natural	MS-3367-4-9	100	5M
Bundle Diameter (min. – max.)	1/16"–1-1/2"	1.59–38.1mm	10393	Black weather resistant	MS-3367-4-0	1,000	5M
Min. Loop Tensile Strength	18 lbf	8.16kgf / 80N	10396	Black weather resistant	MS-3367-4-0	100	5M
			10392	Black heat stabilized		1,000	5M

8" / 203.2mm			PART #	MATERIAL	MILITARY SPEC.	BAG QTY.	CASE QTY.
Width	.099"	2.52mm	10325	Natural	MS-3367-4-9	1,000	5M
Thickness	.044"	1.12mm	10328	Natural	MS-3367-4-9	100	5M
Bundle Diameter (min. – max.)	1/16"–2-1/8"	1.59–53.98mm	10327	Black weather resistant	MS-3367-4-0	1,000	5M
Min. Loop Tensile Strength	18 lbf	8.16kgf / 80N	10330	Black weather resistant	MS-3367-4-0	100	5M
			10326	Black heat stabilized		1,000	5M

15" / 381mm			PART #	MATERIAL	MILITARY SPEC.	BAG QTY.	CASE QTY.
Width	.140"	3.56mm	10338	Natural		100	5M
Thickness	.055"	1.40mm	10336	Black heat stabilized		1,000	5M
Bundle Diameter (min. – max.)	1/16"–4"	1.59–101.6mm	10339	Black heat stabilized		100	1M
Min. Loop Tensile Strength	40 lbf	18.14kgf / 178N	10335	Natural		100	1M

SPECIALTY TIES

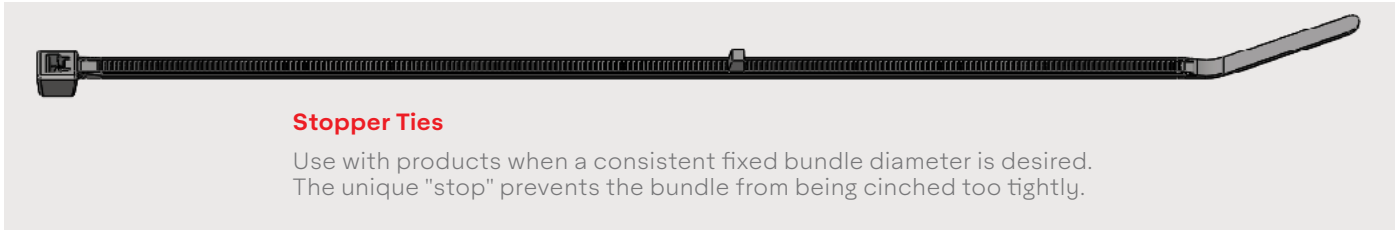

Stopper Ties

Use with products when a consistent fixed bundle diameter is desired. The unique "stop" prevents the bundle from being cinched too tightly.

Stopper Ties

8" / 203.2mm			PART #	MATERIAL	BAG QTY.	CASE QTY.
Width	.130"	2.8mm	10406	Black heat stabilized	1,000	5M
Thickness	.054"	1.1mm				
Bundle Diameter (min. – max.)	1.3"	33.02mm				
Min. Loop Tensile Strength	40 lbf	18.14kgf / 178N				

11" / 279.4mm			PART #	MATERIAL	BAG QTY.	CASE QTY.
Width	.130"	3.80mm	10660	Black heat stabilized	1,000	5M
Thickness	.054"	1.37mm				
Bundle Diameter (min. – max.)	2.0"	50.8mm				
Min. Loop Tensile Strength	50 lbf	22.68kgf / 222N				

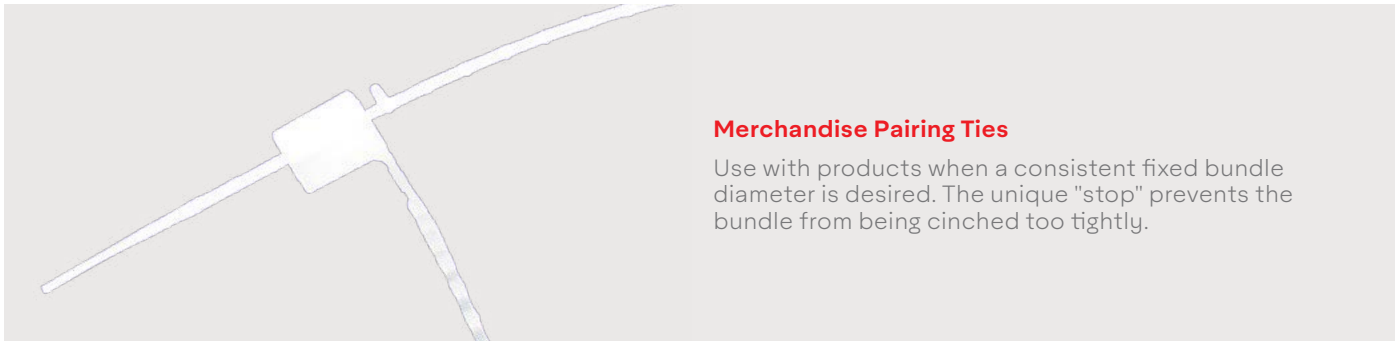

Merchandise Pairing Ties

Use with products when a consistent fixed bundle diameter is desired. The unique "stop" prevents the bundle from being cinched too tightly.

Merchandise Pairing Ties

11" / 279.4mm			PART #	MATERIAL	BAG QTY.	CASE QTY.
Width	.140"	3.56mm	10700	Natural	1,000	5M
Thickness	.040"	1.02mm				
Bundle Diameter (min. – max.)	3.25"	82.55mm				
Min. Loop Tensile Strength	40 lbf	18.14kgf / 178N				

SPECIALTY TIES



Double Headed Cable Ties

Double headed ties also make a great insulator to stop vibration.

Double Headed Cable Ties

7.5" / 190.5mm			PART #	MATERIAL	BAG QTY.	CASE QTY.
Width	.177"	4.50mm	10424	Natural	1,000	5M
Thickness	.055"	1.40mm	10425	Black heat stabilized	1,000	5M
Bundle Diameter (min. – max.)	1/16"–1-3/4"	1.559–44.45mm	10428	Black heat stabilized	100	5M
Min. Loop Tensile Strength	50/50 lbf	22.68kgf / 222N	10426	Black weather resistant	1,000	5M

11" / 279.4mm			PART #	MATERIAL	BAG QTY.	CASE QTY.
Width	.177"	4.50mm	10430	Natural	1,000	5M
Thickness	.055"	1.40mm	10431	Black heat stabilized	1,000	5M
Bundle Diameter (min. – max.)	1/16"–3"	1.59–76.2mm	10432	Black weather resistant	1,000	5M
Min. Loop Tensile Strength	50/50 lbf	22.68kgf / 222N				

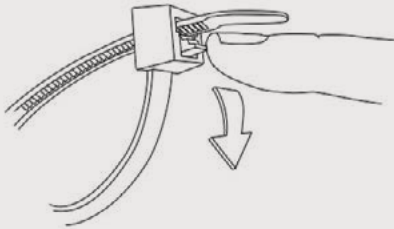

Releasable Cable Ties

Releasable Cable Ties are used for prototype installations or for equipment requiring frequent modifications or service. Simply press the tab to remove the tie. Releasable Cable Ties are easy to use and can be used again and again.

Releasable Cable Ties

7.5" / 190.5mm			PART #	MATERIAL	BAG QTY.	CASE QTY.
Width	.177"	4.50mm	10361	Natural	1,000	5M
Thickness	.060"	1.27mm	10364	Natural	100	5M
Bundle Diameter (min. – max.)	1/16"–1-3/4"	1.59–44.45mm	10362	Black heat stabilized	1,000	5M
Min. Loop Tensile Strength	50 lbf	22.68kgf / 222N	10363	Black weather resistant	1,000	5M
			10366	Black weather resistant	100	5M

PUSH MOUNT TIES



Push Mount Ties

Easily pushes into pre-drilled hole for simple, secure one piece harness. Winged Push Mount ties fit variable panel thickness up to 1/8" — hole diameter of 1/4".

Push Mount Ties

7.5" / 190.5mm			PART #	MATERIAL	BAG QTY.	CASE QTY.
Width	.177"	4.50mm	08414	Natural	1,000	5M
Thickness	.060"	1.27mm	08445	Black heat stabilized	1,000	5M
Bundle Diameter (min. — max.)	1/16"—1-3/4"	1.59—44.45mm	08446	Black weather resistant	1,000	5M
Min. Loop Tensile Strength	50 lbf	22.68kgf / 222N				



Winged Push Mount Ties

Our Winged Push Mount Ties feature an overall strap length of 4" (101.6mm) and are easily push into pre-drilled holes for a simple, secure one piece harness. Winged Push Mount Ties fit variable panel thickness up to 0.125" (3.175mm) and a hole diameter of 0.25" (6.35mm).

Winged Push Mount Ties

4" / 101.6mm			PART #	MATERIAL	BAG QTY.	CASE QTY.
Width	.095"	2.41mm	10691	Black heat stabilized	1,000	5M
Thickness	.039"	.99mm				
Bundle Diameter (min. — max.)	1/16"—7/8"	1.59—22.23mm				
Min. Loop Tensile Strength	18lbf	8.16kgf / 80N				

SCREW MOUNT TIES

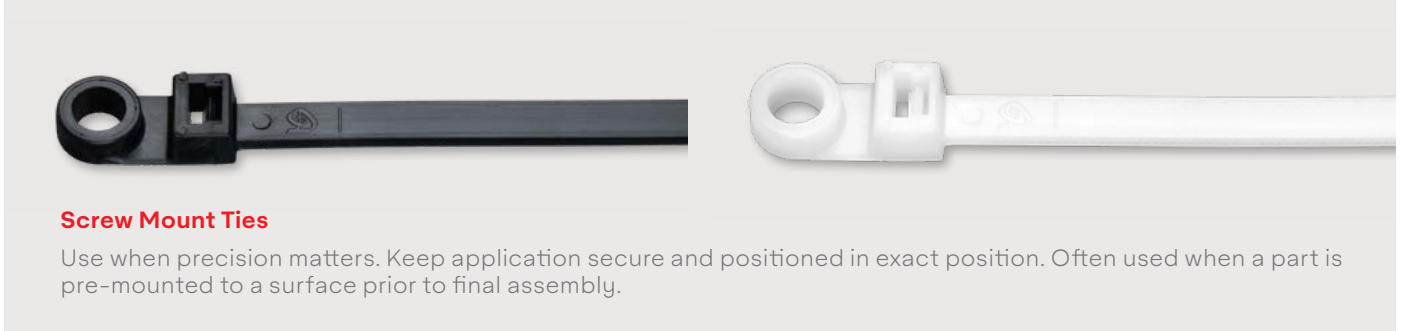

Screw Mount Ties

Use when precision matters. Keep application secure and positioned in exact position. Often used when a part is pre-mounted to a surface prior to final assembly.

Screw Mount Ties

7.5" / 190.5mm			PART #	MATERIAL	BAG QTY.	CASE QTY.
Width	.177"	4.50mm	08415	Natural	1,000	5M
Thickness	.055"	1.40mm	08484	Natural	100	5M
Bundle Diameter (min. – max.)	1/16"–1-3/4"	1.59–44.45mm	08443	Black heat stabilized	1,000	5M
Min. Loop Tensile Strength	50 lbf	22.68kgf / 222N	08444	Black weather resistant	1,000	5M
			08318	Black weather resistant	100	5M

11" / 279.4mm			PART #	MATERIAL	BAG QTY.	CASE QTY.
Width	.177"	4.50mm	10350	Natural	1,000	5M
Thickness	.050"	1.27mm	10351	Black heat stabilized	1,000	5M
Bundle Diameter (min. – max.)	1/16"–3"	1.59–76.2mm	10352	Black weather resistant	1,000	5M
Min. Loop Tensile Strength	50 lbf	22.68kgf / 222N	10354	Black weather resistant	100	1M

14.5" / 368.3mm			PART #	MATERIAL	BAG QTY.	CASE QTY.
Width	.250"	6.35mm	10355	Natural	100	1M
Thickness	.075"	1.91mm	08426	Natural	50	1M
Bundle Diameter (min. – max.)	3/16"–3.5"	4.76–101.6mm	08441	Black heat stabilizedt	100	1M
Min. Loop Tensile Strength	120 lbf	54.34kgf / 534N	10040	Black weather resistant	100	1M

IDENTIFICATION TIES



Identification Cable Ties

Our Identification Tie features an overall strap length of 4" (101.6mm). The custom tie imprinting lasts longer than heat stamping, has easy to read characters, resists fading, is water and scratch resistant and is still highly customizable with a wide range of characters, sizes, and styles. It has many imprinting capabilities such as sequential/non-sequential numbering and letters, serial numbers, and logos. Each tie can fit up to 34 characters, depending on cable tie width and length.

Identification Cable Ties

4" / 101.6mm			PART #	MATERIAL	MILITARY SPEC.	BAG QTY.	CASE QTY.
Width	.095"	2.41mm	08412	Natural	MS-3368-5-9E	1,000	5M
Thickness	.041"	1.04mm	08417	Natural	MS-3368-5-9E	100	5M
Bundle Diameter (min. – max.)	3/16"–7/8"	4.77–22.23mm	10031	White		1,000	5M
Min. Loop Tensile Strength	18 lbf	8.16kgf / 80N					

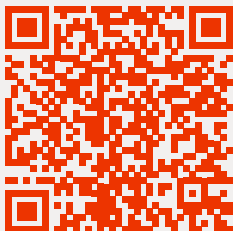

Visit our [Cable Tie Product Selector](#) to find more fasteners, view all specifications & submit sample requests.

fastener.averydennison.com

ACCESSORIES



Adhesive Mounts

Adhesive mounts are able to conform to minor surface irregularities and are available in both rubber and acrylic. Rubber is quick setting and has a modern strength, and acrylic takes longer to set and is stronger. Adhesive mounts have four-way positioning, making it so cable ties can easily slide into the mounts from any 4 sides, which speeds up the assembly process.

Adhesive Mount

			PART #	MATERIAL	BAG QTY.	CASE QTY.
Length	3/4"	19.05mm	08461	3/4" / 19.05mm acrylic adhesive mount for miniature ties and intermediate ties	100	5M
	.835"	21.21mm				
Width	.835"	21.21mm				
Thickness	.190"	4.83mm	10029	3/4" / 19.05mm rubber based adhesive mount for miniature ties and intermediate ties	100	5M
	1.000"	25.4mm				
	1.090"	27.69mm				
			08462	1" / 25.4mm acrylic adhesive mount for intermediate and standard ties	100	5M
			10030	1" / 25.4mm rubber based adhesive mount for intermediate and standard ties	100	5M

3/4" and 1" Mounts

- High impact and tensile strength Nylon
- Operating temperatures from -40°F to 185°F (-40°C to 85°C)

Four-Way Positioning

- Speeds assembly—Cable ties slide easily into mounts from any of four sides

Adhesive-Backed Mounts

- Conform to minor surface irregularities
- Available materials:
 - Rubber: quick set, modern strength
 - Acrylic: longer set, higher strength
- Load carrying capability:
 - 1" adhesive-backed mounts – 0.5 lbf. 3/4" – 0.25 lbf.

MOUNT APPLICATION	ADHESIVE SELECTION	
Paper / Cardboard	x	
Steel / Aluminium	x	x
Glass / Ceramics		x
Rubber	x	
Painted Surfaces	x	x
Cloth	x	
Rigid Vinyl	x	x
Plasticized Vinyl		x
Polypropylene / Polyethylene	x	
ABS Acrylics	x	
Polystyrene	x	x
Urethane	x	

PAINTED SURFACES	SURFACE SELECTION	
Polene	x	
Urethane	x	
Silicone	x	
Latex	x	
Enamel		x
Acrylic		x

REL. SOLVENT RESISTANCE		TEMP. PERFORMANCE			REL. SHEAR STRENGTH	PEEL STRENGTH	
		Low	High			Initial	Ultimate
			Contin.	Intermit.			
Rubber	Medium	-20F / 28.9C	150F / 65.6C	200F / 93.3C	High	High	High
Acrylic	High	-20F / 28.9C	180F / 82.2C	375F / 190.6C	Very High	Medium	High

ACCESSORIES



Anchor Base

Avery Dennison offers this anchor base as a cable tie accessory. Cable tie mounts stabilize and secure wiring bundles in a variety of cable & wire management applications. These base mounts fit a range of cable sizes all securely tied up with a cable tie. Each base is designed for screw mounting only & can be used with miniature, intermediate, and standard size cable ties.

Anchor Base

			PART #	MATERIAL	BAG QTY.	CASE QTY.
Length	.750"	19.05mm	10027	#8 screw	100	1M
Width	.380"	9.65mm	10028	#10 screw	100	1M
Thickness	.210"	5.33mm				



Screw Mount

Screw Mounts are ideal when extra strength is needed and adhesive mounts are not strong enough. They are a plain backed screw mount for use with intermediate and standard ties.

Screw Mount

			PART #	MATERIAL	BAG QTY.	CASE QTY.
Length	1.080"	27.43mm	08463	1" / 4mm - plain backed screw mount for intermediate and standard ties	100	5M
Width	1.080"	27.43mm				
Thickness	.260"	6.60mm				

ACCESSORIES



Screw Cradle Mount

The Screw Cradle Mount design provides support and is secured with a screw mounted into a recessed screw hole, enabling cable ties to pass over the head of the screws. Screw Cradle Mounts are available in #4, #8, #10 and 1/4".

Screw Cradle Mount

				PART #	MATERIAL	BAG QTY.	CASE QTY.
Length	#4	.540"	13.72mm	10044	Small #4 screw	100	5M
	#8	.720"	18.29mm	10045	Medium #8 screw	100	5M
	#10	1.040"	26.42mm	10046	Large #10 screw	100	1M
	1/4"	1.040"	26.42mm				
Width	#4	.340"	8.64mm	10079	Large 1/4" / 6.35mm screw black heat stabilized	100	1M
	#8	.520"	13.21mm				
	#10	.640"	16.26mm				
	1/4"	.640"	16.26mm				
Width	#4	.230"	5.84mm				
	#8	.330"	8.38mm				
	#10	.420"	10.67mm				
	1/4"	.420"	10.67mm				



Identification Plate

The cable tie Identification Plate features a large, flat surface where information can be printed or written with a marker. Each plate can be secured to wire bundles of virtually any size.

Identification Plate

				PART #	MATERIAL	BAG QTY.	CASE QTY.
Length		1.500"	38.1mm	08457	1-1/2"-3/4" / 38.1mm - 19.05mm	100	1M
Width		.755"	19.18mm				
Thickness		.030"	.76mm				

CABLE TIE INSTALLATION TOOLS



Bundle Wires Efficiently While Reducing Operator Fatigue

Avery Dennison Cable Tie Installation Tools make cable tie installation fast and efficient. These versatile tools can be used in a variety of cable bundling and wire assembly applications. Our tools are engineered so that the distance between the trigger and handle is minimized to lower the trigger force necessary for operation, lessening fatigue and increasing comfort for smaller hands.

An easy-to-read tension setting indicator and a non-slip tension adjustment knob ensures consistency from one operator to another.

Built to Last

- Improved internal mechanism design increases long-term tool reliability
- Rugged, lightweight cast aluminum body
- Optimal blade and tool geometry improves cutting capability for smoother, more precise cuts

Application Versatility

- Available in manual or pneumatic styles
- These tools will accommodate all miniature (18 lbf), intermediate (40 lbf) and standard ties (50 lbf) or 0.3"/ 7.6mm wide ties
- Barrel of the tool allows easy access for miniature, intermediate and standard ties (0.3"/ 7.6mm maximum width)
- Available with a curved or a straight blade

CABLE TIE INSTALLATION TOOLS

Manual Cable Tie Tool

Innovative tail jam detector

Narrow barrel for tight spaces

Lightweight cast aluminum body

Ergonomically shaped handle

Easy to read tension settings

Non-slip tension knob

Comfortable distance between trigger and handle

Durable, reinforced trigger

Adaptable opening accommodates ties up to 50 lbf

ITEM #
12001
DESCRIPTION
Manual Cable Tie Tool
TOOLS PER BOX
1 Tool
TOOLS PER CASE
30 Tools
MINIMUM ORDER
1 Tool

Pneumatic Cable Tie Tool

Indented blade cover for flush cut

Easy to replace blade

Durable, reinforced trigger

Easy access air intake port

Innovative tail jam detector

Narrow barrel for tight spaces

Lightweight cast aluminum body

Ergonomically shaped handle

Easy to read tension settings

Non-slip tension knob

Noise reduction muffler

Reliable air cylinder

Rugged Counter Balance Hanger

ITEM #
12500
DESCRIPTION
Pneumatic Cable Tie Tool
TOOLS PER BOX
1 Tool
TOOLS PER CASE
30 Tools
MINIMUM ORDER
1 Tool

CABLE TIE INSTALLATION TOOLS

Technical Information

BLADE TYPE	PART #	DESCRIPTION	TOOLS / BOX	TOOLS / CASE
Straight	12001-1	Manual Tool	1	30
Straight	12010-0	Manual Tool + 3mm Extension	1	30
Straight	12011-0	Manual Tool + 3mm Extension + Tension Lock	1	30
Straight	12008-0	Manual Tool + 5mm Blade Cover Extension	1	30
Straight	12009-0	Manual Tool + 5mm Blade Cover Extension + Tension Knob Adjustment Lock	1	30
Straight	12500-1	Pneumatic Tool	1	15
Straight	12510-0	Pneumatic Tool + Straight Blade + 3mm Extension	1	15
Straight	12511-0	Pneumatic Tool + Straight Blade + 3mm Extension + Tension Lock	1	15
Straight	12508-0	Pneumatic Tool + 5mm Blade Cover Extension	1	15
Straight	12509-0	Pneumatic Tool + 5mm Blade Cover Extension + Tension Knob Adjustment Lock	1	15
Curved	12012-0	Manual Tool + Curved Blade + 3mm Extension	1	30
Curved	12013-0	Manual Tool + Curved Blade + 3mm Extension + Tension Lock	1	30
Curved	12014-0	Manual Tool + Curved Blade + 5mm Extension	1	30
Curved	12015-0	Manual Tool + Curved Blade + 5mm Extension + Tension Lock	1	30
Curved	12512-0	Pneumatic Tool + Curved Blade + 3mm Extension	1	15
Curved	12513-0	Pneumatic Tool + Curved Blade + 3mm Extension + Tension Lock	1	15
Curved	12514-0	Pneumatic Tool + Curved Blade + 5mm Extension	1	15
Curved	12515-0	Pneumatic Tool + Curved Blade + 5mm Extension + Tension Lock	1	15

Accessories & Replacement Parts

PART #	DESCRIPTION	KIT CONTENTS
12002-1	Straight Blade Replacement	1 Blade, 1 Screw
12501-0	Trigger Replacement Kit (for 12500-1 only)	1 Trigger, 1 Trigger Pin
12003-1	Trigger Replacement Kit (for 12001-0 only)	1 Trigger, 1 Trigger Pin
12004-1	Blade Cover Replacement Kit (No Extension)	1 Cover, 1 Cover Screw
12017-0	Straight Blade 3mm Extension Kit	1 Cover Extension, 1 Cover Screw
12005-1	Straight Blade 5mm Extension Kit	1 Cover Extension, 1 Cover Screw
12016-0	Curved Blade Replacement	1 Blade, 1 Screw
12018-0	Curved Blade 3mm Extension Kit	1 Cover Extension, 1 Cover Screw
12019-0	Curved Blade 5mm Extension Kit	1 Cover Extension, 1 Cover Screw
12006-0	Tension Knob Adjustment Lock Kit	1 Tension Lock, 1 Screw, 1 Washer
12007-0	Tension Knob Replacement Kit	1 Knob, 1 Screw, 1 Washer, 1 Spring

Cable Tie Tool Recommended Tension Settings

TENSION SETTING	CLASSIFICATION	MAX. TIE WIDTH (IN.)	MAX. TIE WIDTH (MM)
1-3	Miniature	0.10	2.54
3-6	Intermediate	0.15	3.71
6-8	Standard	0.19	4.83

ENGINEERED FASTENERS FOR AUTOMOTIVE

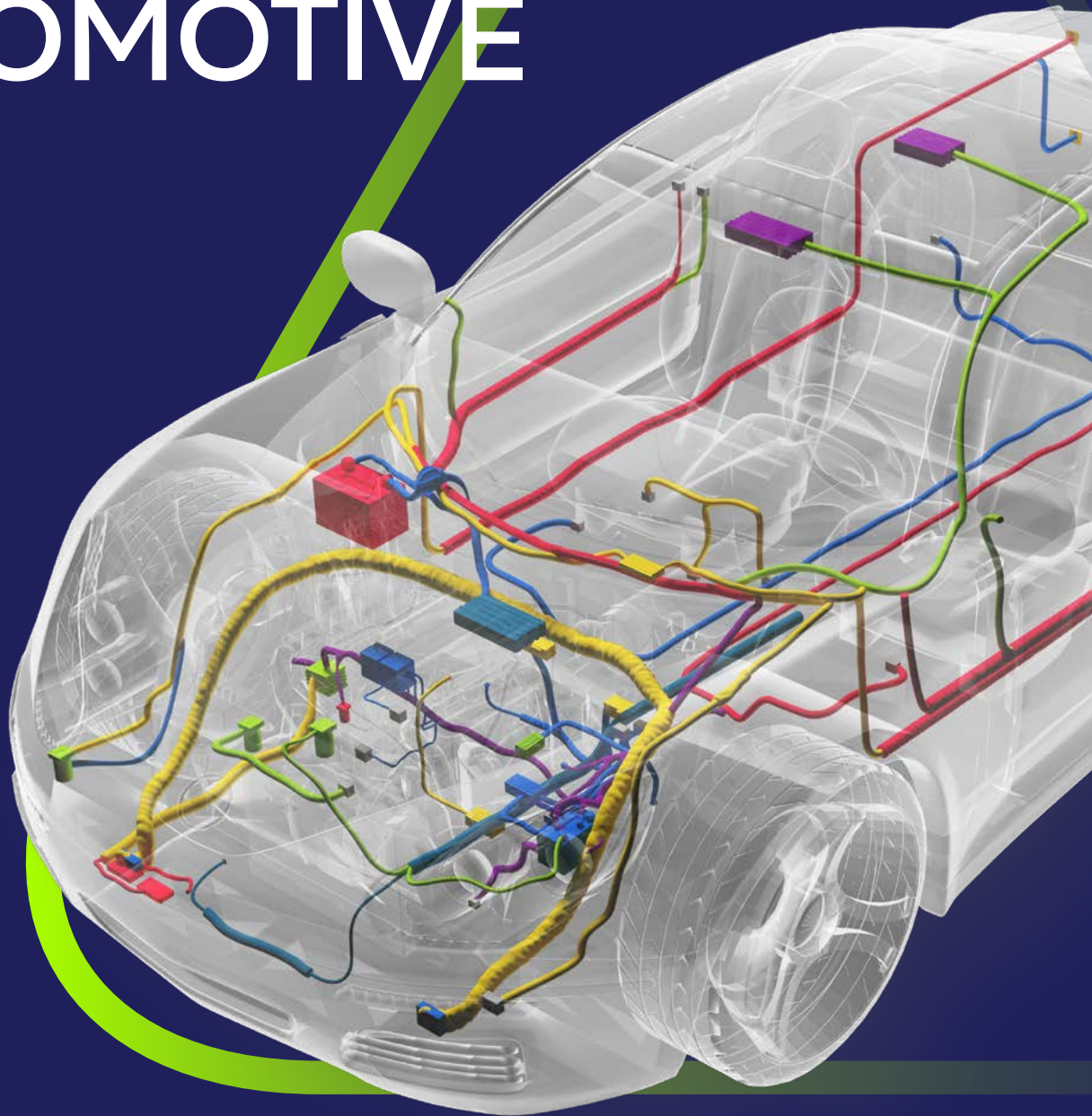

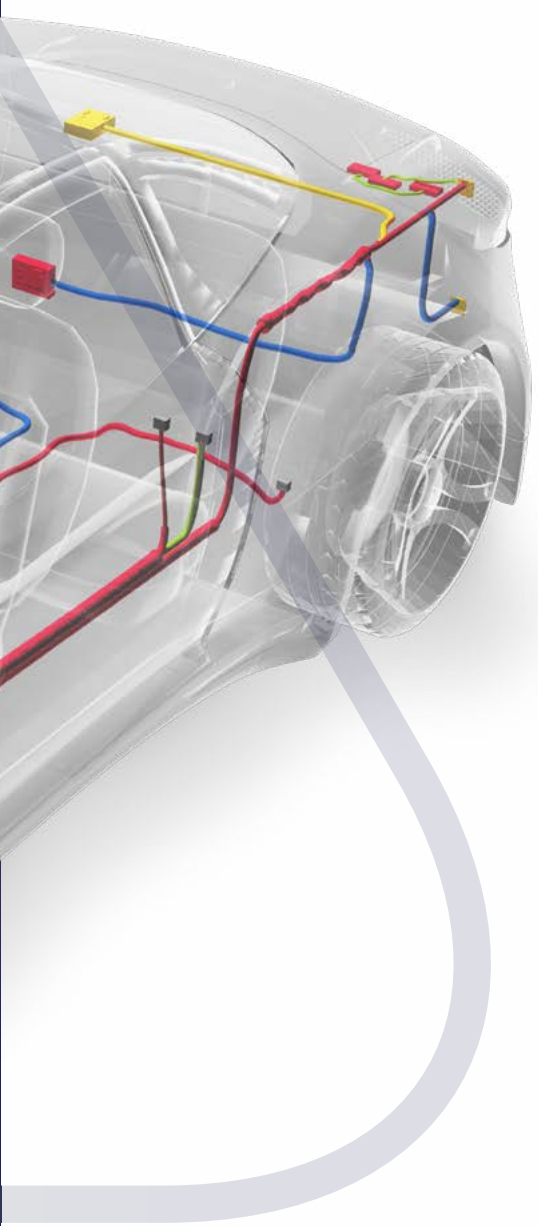

Avery Dennison engineered fasteners are designed to be the premier fastening, guiding and locating solutions for your wire harness, hose or cable assemblies.

Our engineered solutions focus on the following areas:

• **EASE OF ASSEMBLY**

- Low insertion forces
- Small form factors

• **RELIABILITY**

- Choice of materials for temperature cycling and long term use

• **PROFILE OPTIONS**

- We don't have **ALL** the solutions, but we have the **RIGHT** solutions to meet today's automotive needs



Visit our Engineered Fastener Product Selector to find more fasteners, view all specifications & submit sample requests.

fastener.averydennison.com

ENGINEERED FASTENERS

Low Insertion Fir Tree (LIFT™) Ties

The Low Insertion Fir Tree or LIFT™ family of cable ties, offer an ergonomically advanced solution that provides a low insertion force while maintaining high retention characteristics. The unique LIFT flute geometry is designed specifically to meet automotive wire harnessing requirements. LIFT cable ties help minimize line worker fatigue. By combining our low insertion fir tree technology with high extraction force characteristics, LIFT ties outperform alternative fir tree and arrow style fasteners.

Features:

- Ergonomically friendly
- Low insertion force (<10 lbf/44 N)
- High retention force (>40 lbf/178 N)
- Fit a nominal hole range from 6.2mm to 13.0mm, including M6 and M8 threaded holes
- Available in straight 15mm offset and 25mm offset tie styles
- Available with foam gasket

Benefits:

- Effective in a range of panel thicknesses for round, oval, threaded and hex holes
- Fit small wire bundles while maintaining antislip and rotation requirements
- Reduce line worker fatigue
- Proven reliability in the field
- More durable, cleaner alternative to offset tape-on fasteners



ENGINEERED FASTENERS



High Heat Resistant Ties

The Avery Dennison High Heat fastener solutions are a PA66 family of automotive ties that are formulated to withstand operating temperatures of up to 150°C. The physical characteristics of these high heat ties are identical to our current automotive fasteners made with PA66IMHS resin. These ties have been heat age tested for 1,000 hours at 150°C, and for more than 4,000 hours at 135°C, without any compromise to performance.

Several trends in the automotive industry are driving engine compartment temperatures higher:

- Proliferation of turbo chargers
- Proliferation of electric vehicles
- More electronics under the hood
- Engine downsizing and shrinking space in the engine compartment

Currently, the only plastic solutions (PA46 and PEEK) for fastening in high heat areas are expensive and require different processing methods than PA66 fasteners. PA46 can become brittle at temperatures close to 150°C. PA46 is also more hygroscopic than PA66, making it more prone to failures. PA46 based fasteners have been known to cost almost three times that of PA66IMHS fasteners. Metal fasteners are also expensive and are typically not offered in the variety of profiles that plastic fasteners are.

Avery Dennison also supplies the automotive industry with a wide selection of standard and specialty cable ties in heat resistant Nylon 6/6.

HOLE TIES



Round Hole Fir Tree

PART #	DESCRIPTION	COLOR	TYPICAL MOUNT SIZE	MAX. PANEL THICKNESS	BUNDLE DIAMETER	MATERIAL	HS PART #	HHBN 150° C PART #
20154-0	M6 Threaded LIFT	Black	M6	≤ 7.0 mm	1.6 - 38.1mm	PA66 IMHS	20195-0	20154-HHBN
10710-0	Fir Tree Small	Black	M6	≤ 7.0 mm	1.6 - 44.5mm	PA66 IMHS		
20106-0	Fir Tree Standoff	Black	Ø 6.35 mm	≤ 7.0 mm	1.6 - 44.5mm	PA66 IMHS		20106-HHBN
20120-0	4 Flute LIFT	Black	Ø 6.35 - 6.85 mm	≤ 3.0 mm	1.6 - 38.1mm	PA66 IMHS	20173-0	20120-HHBN
20042-0	4 Flute Curved Tie	Black	Ø 6.35 - 6.85 mm	≤ 3.0 mm	1.6 - 44.5mm	PA66 IMHS		20242-HHBN
20002-0	4 Flute Curved Tie	Gray	Ø 6.35 - 6.85 mm	≤ 3.0 mm	1.6 - 44.5mm	PA66 IMHS		
20171-0	4.5" LIFT	Black	Ø 6.35 - 6.85 mm	≤ 7.0 mm	1.6 - 30.0mm	PA66 IMHS	20172-0	20171-HHBN
20140-0	5.5" LIFT	Black	Ø 6.35 - 6.85 mm	≤ 7.0 mm	1.6 - 35.0mm	PA66 IMHS	20168-0	20140-HHBN
20098-0	7.5" LIFT	Black	Ø 6.35 - 6.85 mm	≤ 7.0 mm	1.6 - 44.5mm	PA66 IMHS	20169-0	20098-HHBN
20105-0	7.5" LIFT	Gray	Ø 6.35 - 6.85 mm	≤ 7.0 mm	1.6 - 44.5mm	PA66 IMHS		
20038-0	7 Flute Curved Tie	Black	Ø 6.35 - 6.85 mm	≤ 7.0 mm	1.6 - 44.5mm	PA66 IMHS		
20091-0	7 Flute Curved Tie	Gray	Ø 6.35 - 6.85 mm	≤ 7.0 mm	1.6 - 44.5mm	PA66 IMHS		
10711-0	7.5" Fir Tree On Strap	Black	Ø 6.35 - 6.85 mm	≤ 7.0 mm	6.35 - 47.6mm	PA66 IMHS		
10719-0	7.5" Fir Tree On Strap	Gray	Ø 6.35 - 6.85 mm	≤ 7.0 mm	6.35 - 47.6mm	PA66 IMHS		
10709-0	7.5" Fir Tree Std	Black	Ø 6.35 - 6.85 mm	≤ 6.0 mm	1.6 - 44.5mm	PA66 IMHS		
20094-0	8mm Curved Tie	Black	Ø 7.75 - 8.25 mm / M10	≤ 7.0 mm	1.6 - 44.5mm	PA66 IMHS		
20049-0	M10 Fir Tree	Black	Ø 7.75 - 8.25 mm / M10	≤ 3.0 mm	1.6 - 44.5mm	PA66 IMHS		
20050-0	8mm Fir Tree	Gray	Ø 7.75 - 8.25 mm / M10	≤ 3.0 mm	1.6 - 44.5mm	PA66 IMHS		
20086-0	Fir Tree Stopper Tie	Brown	Ø 7.75 - 8.25 mm / M10	≤ 3.0 mm	22.3 - 44.5mm	PA66 IMHS		
20117-0	7.5" Long 8mm Fir Tree	Black	Ø 7.75 - 8.25 mm / M10	≤ 7.0 mm	1.6 - 44.5mm	PA66 IMHS	20194-0	20117-HHBN
20127-0	7.5" Long 8mm Fir Tree	Natural	Ø 7.75 - 8.25 mm / M10	≤ 7.0 mm	1.6 - 44.5mm	PA66 IMHS		20103-HHBN
20103-0	Fir Tree	Black	Ø 9.75 - 10.25 mm	≤ 5.0 mm	1.6 - 44.5mm	PA66 IMHS		
20110-0	11.5mm LIFT	Black	Ø 11.25 - 11.75 mm	≤ 8.5 mm	1.6 - 44.5mm	PA66 IMHS		

HOLE TIES

0709-0
20094-0
004

CLICK PART# TO VIEW ONLINE



Offset Round Hole Fir Tree

PART #	DESCRIPTION	COLOR	TYPICAL MOUNT SIZE	MAX. PANEL THICKNESS	BUNDLE DIAMETER	MATERIAL	HS PART #	HHBN 150° C PART #
20136-0	M6 15mm Offset Std	Black	M6	≤ 7.0 mm	6.3 - 47.6mm	PA66 IMHS		
20137-0	M6 15mm Offset Rev	Gray	M6	≤ 7.0 mm	6.3 - 47.6mm	PA66 IMHS		
20058-0	6mm Offset Std	Black	M6	≤ 6.0 mm	1.6 - 44.5mm	PA66 IMHS		
20066-0	6mm Offset Rev	Gray	M6	≤ 6.0 mm	1.6 - 44.5mm	PA66 IMHS		
20159-0	15mm Offset Std	Black	Ø 6.35 - 6.85 mm	≤ 7.0 mm	1.6 - 38.1mm	PA66 IMHS		
20161-0	15mm Offset Rev	Gray	Ø 6.35 - 6.85 mm	≤ 7.0 mm	1.6 - 38.1mm	PA66 IMHS		20161-HHBN
20135-0	15mm Offset Std	Black	Ø 6.35 - 6.85 mm	≤ 7.0 mm	1.6 - 47.6mm	PA66 IMHS		
20129-0	15mm Offset Rev	Gray	Ø 6.35 - 6.85 mm	≤ 7.0 mm	1.6 - 47.6mm	PA66 IMHS		
20005-0	25mm Offset Blk	Black	Ø 6.35 - 6.85 mm	≤ 7.0 mm	1.6 - 44.5mm	PA66 IMHS		
20027-0	25mm Offset Rev	Gray	Ø 6.35 - 6.85 mm	≤ 7.0 mm	1.6 - 44.5mm	PA66 IMHS		
20160-0	25mm LIFT Offset Std	Black	Ø 6.35 - 6.85 mm	≤ 7.0 mm	1.6 - 38.1mm	PA66 IMHS	20193-0	
20162-0	25mm LIFT Offset Rev	Gray	Ø 6.35 - 6.85 mm	≤ 7.0 mm	1.6 - 38.1mm	PA66 IMHS		20162-HHBN
20132-0	25mm LIFT Offset Std	Black	Ø 6.35 - 6.85 mm	≤ 7.0 mm	1.6 - 47.6mm	PA66 IMHS		20132-HHBN
20133-0	25mm LIFT Offset Rev	Gray	Ø 6.35 - 6.85 mm	≤ 7.0 mm	1.6 - 47.6mm	PA66 IMHS		20133-HHBN
20121-0	25mm Offset Std	Black	Ø 7.75 - 8.25 mm / M10	≤ 7.0 mm	6.3 - 44.5mm	PA66 IMHS		
20122-0	25mm Offset Rev	Gray	Ø 7.75 - 8.25 mm / M10	≤ 7.0 mm	6.3 - 44.5mm	PA66 IMHS		20122-HHBN
20032-0	25mm Offset Std	Black	Ø 9.25 - 9.75 mm	≤ 7.0 mm	1.6 - 47.6mm	PA66 IMHS		
20073-0	25mm Offset Rev	Gray	Ø 9.25 - 9.75 mm	≤ 7.0 mm	1.6 - 47.6mm	PA66 IMHS		

HOLE TIES

0709-0
20094-0
004

CLICK PART# TO VIEW ONLINE

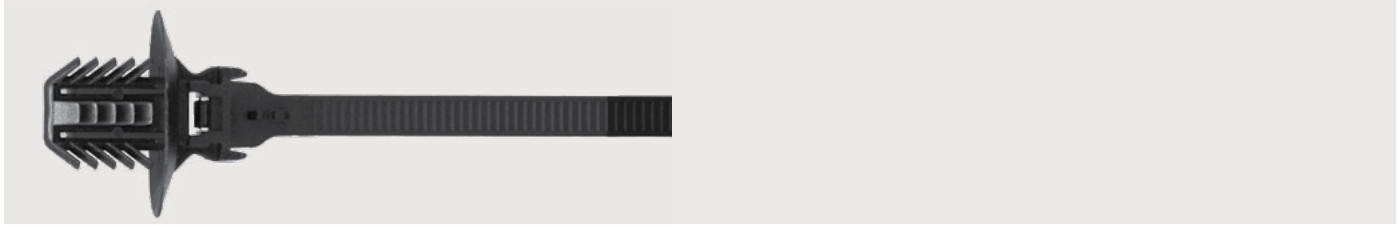

Oval Hole Fir Tree

PART #	DESCRIPTION	COLOR	TYPICAL MOUNT SIZE	MAX. PANEL THICKNESS	BUNDLE DIAMETER	MATERIAL	HS PART #	HHBN 150° C PART #
20185-0	Oval Fir Tree 38mm Max Bundle	Black	6.2 x 12.2 mm 6.5 x 12.5 mm 6.5 x 13.0 mm 7 x 12.0 mm	≤ 7.0 mm	1.6 - 38.1mm	PA66 IMHS	20196-0	20185-HHBN
20276-0	Oval Fir Tree 50mm Max Bundle	Black	6.2 x 12.2 mm 6.5 x 12.5 mm 6.5 x 13.0 mm 7 x 12.0 mm	≤ 7.0 mm	1.6 - 50.0mm	PA66 IMHS	20277-0	20276-HHBN
20297-0	2 Piece Oval Fir Tree HD	Black	6.2 x 12.2 mm 6.5 x 12.5 mm 6.5 x 13.0 mm 7 x 12.0 mm	≤ 7.0 mm	4.7-101.6mm	PA66 IMHS	20298-0	20297-HHBN
20299-0	2 Piece Oval Fir Tree Std	Black	6.2 x 12.2 mm 6.5 x 12.5 mm 6.5 x 13.0 mm 7 x 12.0 mm	≤ 7.0 mm	1.6 - 44.5mm	PA66 IMHS	20300-0	20299-HHBN
20317-0	Long 2 Piece Oval Fir Tree HD	Black	6.2 x 12.2 mm 6.5 x 12.5 mm 6.5 x 13.0 mm 7 x 12.0 mm	≤ 16mm	4.7-101.6mm	PA66 IMHS		
20318-0	Long 2 Piece Oval Fir Tree Std. No HS	Black	6.2 x 12.2 mm 6.5 x 12.5 mm 6.5 x 13.0 mm 7 x 12.0 mm	≤ 16mm	1.6 - 44.5mm	PA66 IMHS		

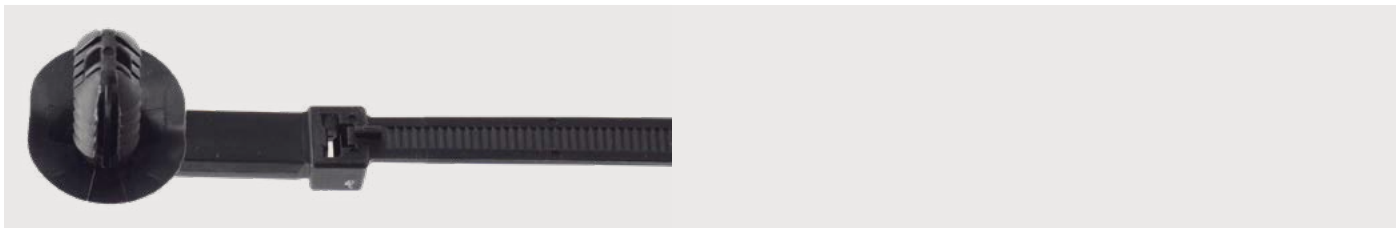

Offset Oval Hole Fir Tree

PART #	DESCRIPTION	COLOR	TYPICAL MOUNT SIZE	MAX. PANEL THICKNESS	BUNDLE DIAMETER	MATERIAL	HS PART #	HHBN 150° C PART #
20289-0	12.5mm Offset Oval Std	Black	6.2 x 12.2 mm 6.5 x 12.5 mm 6.5 x 13.0 mm 7 x 12.0 mm	≤ 7.0 mm	1.6 - 50.0mm	PA66 IMHS	20290-0	20289-HHBN
20291-0	25mm Offset Oval Std	Black	6.2 x 12.2 mm 6.5 x 12.5 mm 6.5 x 13.0 mm 7 x 12.0 mm	≤ 7.0 mm	1.6 - 50.0mm	PA66 IMHS	20292-0	20291-HHBN
20293-0	12.5mm Offset Oval Rev	Gray	6.2 x 12.2 mm 6.5 x 12.5 mm 6.5 x 13.0 mm 7 x 12.0 mm	≤ 7.0 mm	1.6 - 50.0mm	PA66 IMHS	20294-0	20293-HHBN
20295-0	25mm Offset Oval Rev	Gray	6.2 x 12.2 mm 6.5 x 12.5 mm 6.5 x 13.0 mm 7 x 12.0 mm	≤ 7.0 mm	1.6 - 50.0mm	PA66 IMHS	20296-0	20295-HHBN

HOLE TIES

0709-0
20094-0
004

CLICK PART# TO VIEW ONLINE

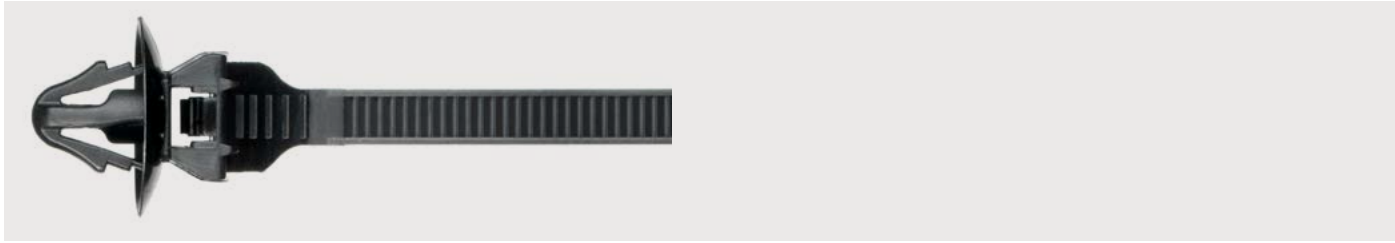

Round Hole Arrow

PART #	DESCRIPTION	COLOR	TYPICAL MOUNT SIZE	MAX. PANEL THICKNESS	BUNDLE DIAMETER	MATERIAL	HS PART #	HHBN 150° C PART #
20131-0	6.6mm Arrow Tie	Black	Ø 6.35 - 7.00 mm	≤ 3.6 mm	1.6 - 38.1mm	PA66 IMHS	20174-0	20131-HHBN
20087-0	90 Deg Arrow Tie	Black	Ø 6.35 - 6.85 mm	3.5 - 5.5 mm	6.3 - 44.5mm	PA66 IMHS		
20060-0	9.5mm Arrow PM4"L	Black	Ø 9.25 - 10.0 mm	≤ 10.0 mm	6.4 - 19.1mm	PA66 IMHS		

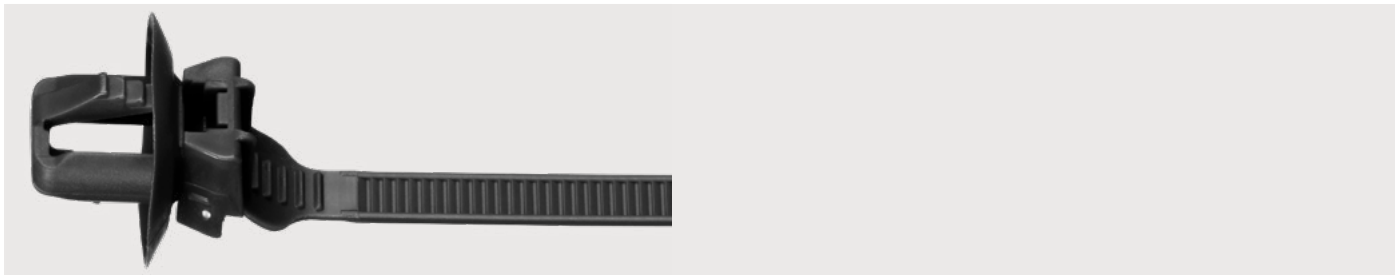

Oval Hole Arrow

PART #	DESCRIPTION	COLOR	TYPICAL MOUNT SIZE	MAX. PANEL THICKNESS	BUNDLE DIAMETER	MATERIAL	HS PART #	HHBN 150° C PART #
20179-0	Oval Arrow Tie	Black	6.2 x 12.2 mm 7 x 12.0 mm	≤ 3.6 mm	1.6 - 38.1mm	PA66 IMHS	20198-0	20179-HHBN
20115-0	6" Directional Slot	Black	7 x 12.0 mm	≤ 3.6 mm	1.6 - 38.1mm	PA66 IMHS	20178-0	20115-HHBN
20123-0	6" Directional Slot	Gray	7 x 12.0 mm	≤ 3.6 mm	1.6 - 38.1mm	PA66 IMHS		

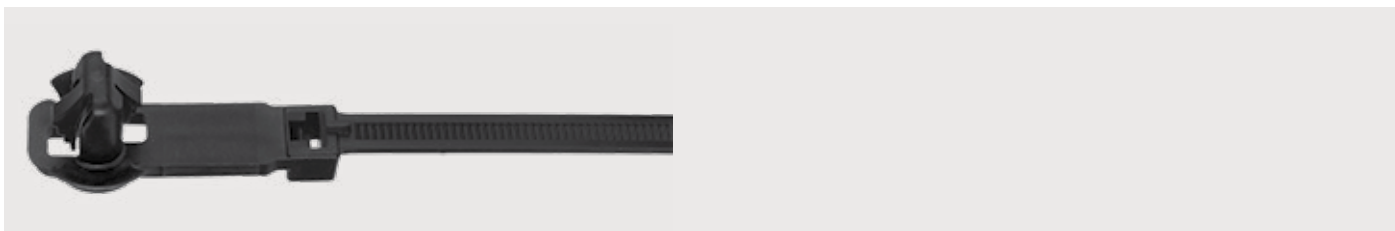

Offset Arrow

PART #	DESCRIPTION	COLOR	TYPICAL MOUNT SIZE	MAX. PANEL THICKNESS	BUNDLE DIAMETER	MATERIAL	HS PART #	HHBN 150° C PART #
20142-0	15mm Offset Slot Std	Black	7 x 12.0 mm	≤ 3.0 mm	1.6mm - 38.1mm	PA66 IMHS		
20143-0	15mm Offset Slot Rev	Gray	7 x 12.0 mm	≤ 3.0 mm	1.6mm - 38.1mm	PA66 IMHS		
20144-0	25mm Offset Slot Std	Black	7 x 12.0 mm	≤ 3.0 mm	1.6mm - 38.1mm	PA66 IMHS		
20147-0	25mm Offset Slot Rev	Gray	7 x 12.0 mm	≤ 3.0 mm	1.6mm - 38.1mm	PA66 IMHS		
20148-0	35mm Offset Slot Std	Black	7 x 12.0 mm	≤ 3.0 mm	1.6mm - 38.1mm	PA66 IMHS		
20149-0	35mm Offset Slot Rev	Gray	7 x 12.0 mm	≤ 3.0 mm	1.6mm - 38.1mm	PA66 IMHS		20149-HHBN

STUD TIES

0709-0
20094-0
004

CLICK PART# TO VIEW ONLINE

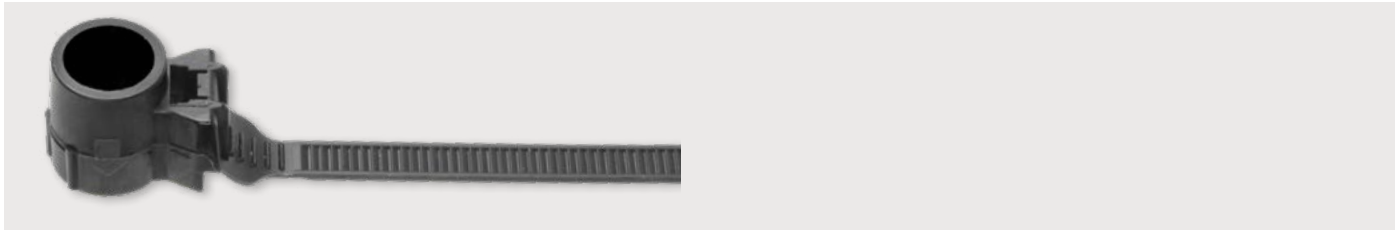

Stud Mount

PART #	DESCRIPTION	COLOR	TYPICAL MOUNT SIZE	MAX. PANEL THICKNESS	BUNDLE DIAMETER	MATERIAL	HS PART #	HHBN 150° C PART #
20145-0	T5/M5 Compact Weld	Gray	M5/T5		1.6mm - 38.1mm	PA66 IMHS		
20146-0	M6 Compact Weld Stud	Black	M6		1.6mm - 38.1mm	PA66 IMHS	20176-0	20146-HHBN
10708-0	T5/M5/M6 Weld Stud	Black	M5/T5/M6		1.6mm - 44.5mm	PA66 IMHS	20192-0	10708-HHBN
20015-0	T5/M5/M6 Weld Stud	Natural	M5/T5/M6		1.6mm - 44.5mm	PA66 IMHS		
20152-0	M8 Compact Weld Stud	Black	M8		1.6mm - 38.1mm	PA66 IMHS		20152-HHBN
20011-0	M8 Weld Stud	Black	M8		1.6mm - 44.5mm	PA66 IMHS		
20013-0	M8 Weld Stud	Gray	M8		1.6mm - 44.5mm	PA66 IMHS		
20153-0	M10 Compact Weld Stud	Black	M10		1.6mm - 38.1mm	PA66 IMHS		20153-HHBN
20014-0	M10 Weld Stud	Brown	M10		1.6mm - 44.5mm	PA66 IMHS		
20116-0	M12 Weld Stud	Black	M12		1.6mm - 44.5mm	PA66 IMHS		
20085-0	6.35mm Screw Mount	Natural	6.35mm		6.3mm -44.5mm	PA66 IMHS		
20051-0	M5/M6 Screw Mount	Black	M5/M6		1.6mm - 44.5mm	PA66 IMHS		
20062-0	M5/M6 Mount Tie	Natural	M5/M6		1.6mm - 44.5mm	PA66 IMHS		
20065-0	25mm Offset Screw Mount	Black	M5/M6		1.6mm - 44.5mm	PA66 IMHS		
20045-0	M6 Screw Mount	Black	M6		6.3mm -44.5mm	PA66 IMHS		
20044-0	M8 Screw Mount	Gray	M8		6.3mm -44.5mm	PA66 IMHS		
20139-0	M10 Screw Mount	Black	M10		6.3mm -44.5mm	PA66 IMHS		
20360-0	M6 Threaded Mount	Black	M6		1.6mm - 44.5mm	PA66 IMHS		

CONNECTOR TIES

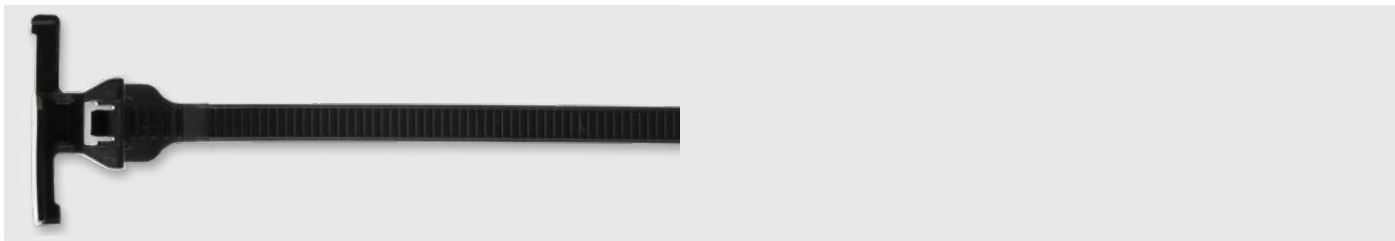

Connector Ties

PART #	DESCRIPTION	COLOR	TYPICAL MOUNT SIZE	MAX. PANEL THICKNESS	BUNDLE DIAMETER	MATERIAL	HS PART #	HHBN 150° C PART #
20101-0	T-Slot Connector	Black	Connector		1.6mm - 44.5mm	PA66 IMHS		
20111-0	ADAPEX Connector	Black	Connector		1.6mm - 44.5mm	PA66 IMHS		
20113-0	ADGT Connector	Black	Connector		1.6mm - 44.5mm	PA66 IMHS		
20124-0	ADFM Connector	Black	Connector		1.6mm - 44.5mm	PA66 IMHS		

GASKETED TIES



Gasketed Ties

PART #	DESCRIPTION	COLOR	TYPICAL MOUNT SIZE	MAX. PANEL THICKNESS	BUNDLE DIAMETER	MATERIAL	HS PART #	HHBN 150° C PART #
20042-GSK	4 Flute Gsk	Black	Ø 6.35 - 6.85 mm	≤ 1.8 mm	1.6mm - 44.5mm	PA66 IMHS		
20098-GSK	7.5" LIFT Gsk	Black	Ø 6.35 - 6.85 mm	≤ 5.0 mm	1.6mm - 44.5mm	PA66 IMHS		

SPECIALTY TIES

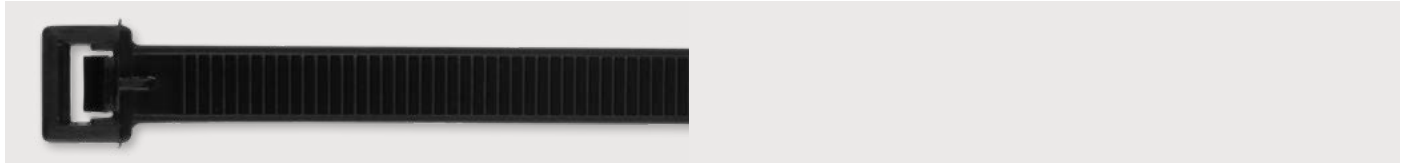

Convoluted Tubing Tie

7.5" / 190.5mm	PART #	DESCRIPTION	COLOR	BUNDLE DIAMETER
	20093-0	Convoluted Tubing Tie	Black	Min. 1/16" (1.59mm) Max. 1-3/4" (44.45mm)

Tensile minimum 50 lbf. (222N)

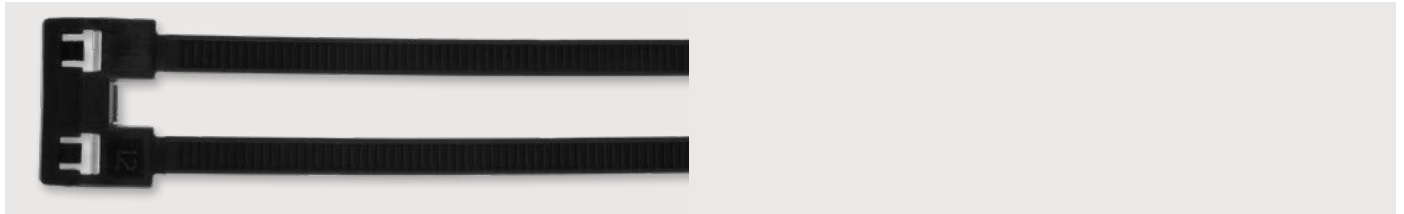

Double Strap

6" / 152.4mm	PART #	DESCRIPTION	COLOR	BUNDLE DIAMETER
	20040-0	Double Strap-Black, HS	Black	Min. 1/4" (6.36mm) Max. 1-5/8" (41.3mm)

Tensile minimum 20 lbf. (9.1kgf)

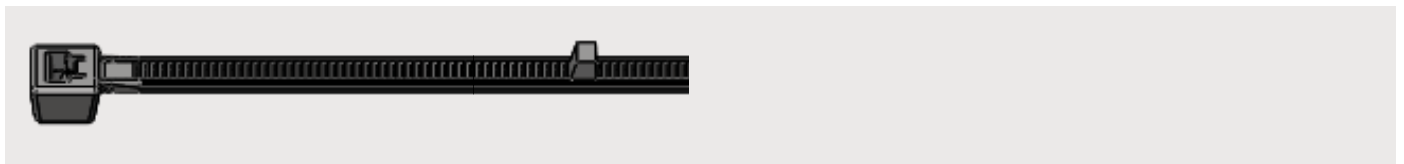

Stopper Ties

5.5" / 140mm	PART #	DESCRIPTION	COLOR	BUNDLE DIAMETER
	20097-0	5.5" Stopper GHS	Black	Min. 1/4" (6.36mm) Max. 1-5/8" (41.3mm)

Tensile minimum 20 lbf. (9.1kgf)

8" / 203mm	PART #	DESCRIPTION	COLOR	BUNDLE DIAMETER
	20128-0	85mm Stopper	Black	Min. 1/4" (6.36mm) Max. 1-5/8" (41.3mm)

Tensile minimum 40 lbf. (18kgf)

CONTRACTOR GRADE CABLE TIES

Small Part Numbering

CT 0190 N 050 N M

CABLE TIE IDENTIFIER

CABLE TIE NOMINAL LENGTH
in mm

MATERIAL

TENSILE STRENGTH
in lbf.

COLOR

BAG QTY.

CT	Cable Tie	SM	Saddle Mount
SM	Screw Mount	MP	Merchandising Pairing
PM	Push Mount	IL	In-Line
WM	Wriged Push Mount	ST	Stopper
DH	Double Headed	IDP	Identifier (Perpendicular)
DL	Double Locking	IDI	Identifier (In-Line)
RT	Releaseable	IDF	Identifier (Flag)
RR	Releaseable Regular	IDL	Identifier (Large Flag)
CS	Slim Line (when b does not distinguish from regular ties)		

N	Nylon 6/6
W	Weather Resistant
H	Heat Stabilized
L	Low Temperature (Nylon 12)
P	Polypropylene

N	Natural	X	10
K	Black	Q	25
R	Red	L	50
G	Green	C	100
B	Blue	D	500
Y	Yellow	M	1,000
O	Orange		
S	Special or Specified PMS Color		

3-1/8" MINIATURE

PART #	LENGTH	COLOR	STRENGTH	BAG QTY.	CASE QTY.
CT0080N018NM	3.125"	Natural	18	1,000	25,000

4" MINIATURE

PART #	LENGTH	COLOR	STRENGTH	BAG QTY.	CASE QTY.
CT0100N018NM	4"	Natural	18	1,000	25,000
CT0100N018NC	4"	Natural	18	100	5,000
CT0100N018KM	4"	Black	18	100	5,000
CT0100N018KC	4"	Black	18	1,000	25,000
CT0100W018KM	4"	Weather Resistant	18	1,000	25,000
CT0100W018KC	4"	Weather Resistant	18	100	5,000

5.5" MINIATURE

PART #	LENGTH	COLOR	STRENGTH	BAG QTY.	CASE QTY.
CT0140N040NM	5.5"	Natural	40	1,000	5,000
CT0140N040NC	5.5"	Natural	40	100	5,000
CT0140N040KC	5.5"	Black	40	100	5,000
CT0140N040KM	5.5"	Black	40	1,000	5,000
CT0140W040KM	5.5"	Weather Resistant	40	1,000	5,000
CT0140W040KC	5.5"	Weather Resistant	40	100	5,000
CT0140N0400M	5.5"	Natural	40	1,000	5,000
CT0140N040BM	5.5"	Blue	40	1,000	5,000
CT0140N040GC	5.5"	Green	40	100	5,000

8" MINIATURE

PART #	LENGTH	COLOR	STRENGTH	BAG QTY.	CASE QTY.
CT0200N040NM	8"	Natural	40	1,000	5,000
CT0200N040NC	8"	Natural	40	100	5,000
CT0200N040KM	8"	Black	40	1,000	5,000
CT0200N040KC	8"	Black	40	100	5,000
CT0200W040KM	8"	Weather Resistant	40	1,000	5,000
CT0200W040KC	8"	Weather Resistant	40	100	5,000
CT0200N040BC	8"	Intermediate (Blue)	40	100	5,000
CT0200N040GC	8"	Intermediate (Green)	40	100	5,000
CT0200N040RC	8"	Intermediate (Red)	40	100	5,000

CONTRACTOR GRADE CABLE TIES

7.5" STANDARD

PART #	LENGTH	COLOR	STRENGTH	BAG QTY.	CASE QTY.
CT0190N050NM	7.5"	Natural	50	1,000	5,000
CT0190N050NC	7.5"	Natural	50	100	5,000
CT0190N050KM	7.5"	Black	50	1,000	5,000
CT0190N050KC	7.5"	Black	50	100	5,000
CT0190W050KM	7.5"	Weather Resistant	50	1,000	5,000
CT0190W050KC	7.5"	Weather Resistant	50	100	5,000

11" STANDARD

PART #	LENGTH	COLOR	STRENGTH	BAG QTY.	CASE QTY.
CT0280N050NM	11"	Natural	50	1,000	5,000
CT0280N050NC	11"	Natural	50	100	5,000
CT0280N050KM	11"	Black	50	1,000	5,000
CT0280N050KC	11"	Black	50	100	5,000
CT0280W050KM	11"	Weather Resistant	50	1,000	5,000
CT0280W050KC	11"	Weather Resistant	50	100	5,000

14.5" STANDARD

PART #	LENGTH	COLOR	STRENGTH	BAG QTY.	CASE QTY.
CT0370N050NM	14.5"	Natural	50	1,000	5,000
CT0370N050ND	14.5"	Natural	50	500	5,000
CT0370N050NC	14.5"	Natural	50	100	1,000
CT0370N050KC	14.5"	Black	50	100	1,000
CT0370W050KM	14.5"	Weather Resistant	50	1,000	5,000
CT0370W050KD	14.5"	Weather Resistant	50	500	5,000
CT0370W050KC	14.5"	Weather Resistant	50	100	1,000

17" STANDARD

PART #	LENGTH	COLOR	STRENGTH	BAG QTY.	CASE QTY.
CT0430N050NC	17"	Natural	50	100	5,000
CT0430W050KC	17"	Weather Resistant	50	100	5,000

17.75" STANDARD

PART #	LENGTH	COLOR	STRENGTH	BAG QTY.	CASE QTY.
CT0450N050NC	17.75"	Natural	50	100	5,000

19.6875" STANDARD

PART #	LENGTH	COLOR	STRENGTH	BAG QTY.	CASE QTY.
CT0530N050NC	19.6875"	Natural	50	100	1,000

CONTRACTOR GRADE CABLE TIES

13.5" HEAVY DUTY

PART #	LENGTH	COLOR	STRENGTH	BAG QTY.	CASE QTY.
CT0340N120NC	13.5"	Natural	120	100	1,000
CT0340W120KC	13.5"	Weather Resistant	120	100	1,000

15" HEAVY DUTY

PART #	LENGTH	COLOR	STRENGTH	BAG QTY.	CASE QTY.
CT0380N120NC	15"	Natural	120	100	1,000
CT0380N120KC	15"	Black	120	100	1,000
CT0380W120KC	15"	Weather Resistant	120	100	1,000

21.6875" HEAVY DUTY

PART #	LENGTH	COLOR	STRENGTH	BAG QTY.	CASE QTY.
CT0530N175NC	21.6875"	Natural	175	100	1,000
CT0530W175KC	21.6875"	Weather Resistant	175	100	1,000

24" EXTRA HEAVY DUTY

PART #	LENGTH	COLOR	STRENGTH	BAG QTY.	CASE QTY.
CT0610N175NC	24"	Natural	175	100	1,000
CT0610W175KC	24"	Weather Resistant	175	100	1,000

28" EXTRA HEAVY DUTY

PART #	LENGTH	COLOR	STRENGTH	BAG QTY.	CASE QTY.
CT0710N175NC	28"	Natural	175	100	1,000
CT0710W175KC	28"	Weather Resistant	175	100	1,000

36" EXTRA HEAVY DUTY

PART #	LENGTH	COLOR	STRENGTH	BAG QTY.	CASE QTY.
CT0915N175NL	36"	Natural	175	50	500
CT0915W175KL	36"	Weather Resistant	175	50	500

48" EXTRA HEAVY DUTY

PART #	LENGTH	COLOR	STRENGTH	BAG QTY.	CASE QTY.
CT1220N175NL	48"	Natural	175	50	500
CT1220W175KL	48"	Weather Resistant	175	50	500

CONTRACTOR GRADE CABLE TIES

SLIM LINE

PART #	LENGTH	COLOR	STRENGTH	BAG QTY.	CASE QTY.
CT0140N018NM	5.5"	Natural	18	1,000	5,000
CT0165N018NC	6.5"	Natural	18	100	5,000
CT0165N018NM	6.5"	Natural	18	1,000	5,000
CT0165W018KC	6.5"	Weather Resistant	18	100	5,000
CT0165N018BC	6.5"	Blue	18	100	5,000
CT0165N018GC	6.5"	Green	18	100	5,000
CT0165N018YC	6.5"	Yellow	18	100	5,000
CT0200N018NC	8"	Natural	18	100	5,000
CT0200N018KM	8"	Black	18	1,000	5,000
CT0200N018KC	8"	Black	18	100	5,000
CT0200N018BC	8"	Blue	18	100	5,000
CT0200N018NM	8"	Natural	18	100	5,000
CT0200W018KC	8"	Weather Resistant	18	100	5,000
CT0200W018KM	8"	Weather Resistant	18	1,000	5,000

PUSH MOUNT

PART #	LENGTH	COLOR	STRENGTH	BAG QTY.	CASE QTY.
PM0200N050NM	8"	Natural	50	1,000	5,000

SCREW MOUNT

PART #	LENGTH	COLOR	STRENGTH	BAG QTY.	CASE QTY.
SM0150N040NC	6"	Natural	40	100	1,000
SM0150W040KC	6"	Weather Resistant	40	100	5,000
SM0200N050NC	8"	Natural	50	100	1,000
SM0200W050KC	8"	Weather Resistant	50	100	1,000
SM0370N050NC	14.5"	Natural	50	100	1,000
SM0370W050KC	14.5"	Weather Resistant	50	100	1,000
SM0380N120NC	15"	Natural	120	100	1,000
SM0380W120KC	15"	Weather Resistant	120	100	1,000

CONTRACTOR GRADE CABLE TIES

RELEASABLE (FLAT IN-LINE RELEASE)

PART #	LENGTH	COLOR	STRENGTH	BAG QTY.	CASE QTY.
RT0150N050KC	6"	Flat (Black)	50	100	5,000
RT0300N050KC	11.875"	Flat (Black)	50	100	5,000

IDENTIFICATION

PART #	LENGTH	COLOR	STRENGTH	BAG QTY.	CASE QTY.
IDP100N018NC	4"	Natural, Ext.-Perpendicular Flag	18	100	1,000
IDF110N018NM	4"	Natural, Flag (ext. beyond head)	18	1,000	5,000
IDI200N050NC	8"	Natural In-line Flag	50	100	1,000

MOUNT

PART #	LENGTH	COLOR	STRENGTH	BAG QTY.	CASE QTY.
CM1510N	3/5" x 2/5"	Saddle Mount	n/a	100	1,000
CM2316N	7/8" x 5/8"	Saddle Mount	n/a	100	1,000
CM1919N	3/4" x 3/4"	Acrylic Adhesive Mount (Natural)	n/a	100	1,000
CM2121K	13/16" x 13/16"	Acrylic Adhesive Mount (Black)	n/a	100	1,000
CM2828N	1" x 1"	Acrylic Adhesive Mount (Natural)	n/a	100	1,000
CM2828K	1" x 1"	Acrylic Adhesive Mount (Black)	n/a	100	1,000
CM3838N	1-1/2" x 1-1/2"	Acrylic Adhesive Mount (Natural)	n/a	100	1,000
CM3838K	1-1/2" x 1-1/2"	Acrylic Adhesive Mount (Black)	n/a	100	1,000

INSTALLATION TOOL

PART #	LENGTH	COLOR	STRENGTH	BAG QTY.	CASE QTY.
FTG6	n/a	Disposable Tool	18-50lb ties	1	1

MILITARY SPECIFICATIONS CROSS REFERENCE

MILITARY SPECIFICATIONS	DESCRIPTION	COLOR	PART#
MS-3367-1-0	7.5" /190.5mm	Black weather resistant	08388, 08437
	7.5" /190.5mm	Black heat stabilized (Super Bar-Lok®)	10003, 10005
MS-3367-1-9	7.5" /190.5mm	Natural	08387, 08436
	7.5" /190.5mm	Natural (Super Bar-Lok®)	10001, 10004
MS-3367-2-0	15" /381mm	Black weather resistant	10037, 08428
	15" /381mm	Black heat stabilized (Super Bar-Lok®)	10008, 10345
MS-3367-2-9	15" /381mm	Natural	10036, 08427
	15" /381mm	Natural (Super Bar-Lok®)	10006, 10344
MS-3367-3-0	14.5" /368.3mm	Black weather resistant	10039, 08382
	21" /533.4mm	Black weather resistant	10608
	24" /609.6mm	Black weather resistant	10614
MS-3367-3-9	14.5" /368.3mm	Natural	10038, 08378
	21" /533.4mm	Natural	10606
	24" /609.6mm	Natural	10612
MS-3367-4-0	4" /101.6mm	Black weather resistant	08433, 08435
	8" /203.2mm	Black weather resistant slim line	10327, 10330
	6" /152.4mm	Black weather resistant slim line	10393, 10396
MS-3367-4-2	4" /101.6mm	Red	08508
MS-3367-4-3	4" /101.6mm	Orange	08582
MS-3367-4-4	4" /101.6mm	Yellow	08583
MS-3367-4-5	4" /101.6mm	Green	08584
MS-3367-4-6	4" /101.6mm	Blue	08587
MS-3367-4-9	4" /101.6mm	Natural	08432, 08434
	8" /203.2mm	Natural slim line	10325, 10328
	6" /152.4mm	Natural slim line	10391, 10394
MS-3367-5-0	5.5" /139.7mm	Black weather resistant	08431, 08384
	8" /203.2mm	Black weather resistant	08380, 08386
MS-3367-5-2	8" /203.2mm	Red	08690
MS-3367-5-4	8" /203.2mm	Yellow	08782
MS-3367-5-5	8" /203.2mm	Green	08664
MS-3367-5-6	8" /203.2mm	Blue	08671
MS-3367-5-9	5.5" /139.7mm	Natural	08376, 08383
	8" /203.2mm	Natural	08377, 08385
	11.5" /292.1mm	Natural slim line	10985
MS-3367-6-0	28" /711.2mm	Black weather resistant	10620
MS-3367-6-9	28" /711.2mm	Natural	10618
MS-3367-7-0	11" /279.4mm	Black weather resistant	08286, 08930
MS-3367-7-9	11" /279.4mm	Natural	08600, 08859
MS-3368-1-9A	7.5" /190.5mm	Natural ID	08413, 08419
MS-3368-5-9E	4" /101.6mm	Natural ID	08412, 08417

World Wide Locations

USA & CANADA

Avery Dennison
224 Industrial Road
Fitchburg, MA 01420
USA
Tel. 800-225-5913
Tel. 978-345-8100
Fax. 800-848-2169
Email fastener@averydennison.com

ASIA

Avery Dennison
No. 7 Chun Ying Street
Tseung Kwan O Industrial Estate
New Territories
Hong Kong
Tel. 852-2372-3000
Fax. 852-2873-6436

EUROPE, MIDDLE EAST & AFRICA

Avery Dennison
Unit 5 Elia Close, Chapel Lane
High Wycombe
Buckinghamshire, HP12 4FX
United Kingdom
Tel. +44 0 1628 859500

LATIN AMERICA

Avery Dennison
Aristóteles #123
Parque Industrial Kalos
Apodaca, Nuevo León
66600
México
Tel. +52 (81) 3348 0700
Fax. + 52 (81) 8864 4101



Item numbers, descriptions and
availability are subject to change.
Please check website for current updates.

fastener.averydennison.com

To learn more or to get a quote, contact your sales representative, or visit:
fastener.averydennison.com

Connect with us on:



For more information on technical performance and printing recommendations, please refer to the respective datasheets. Please note that the Avery Dennison product range and service offering can be subject to changes. For an accurate overview, please check our website fastener.averydennison.com or contact your local Avery Dennison sales representative.

DISCLAIMER — ©2023 Avery Dennison Corporation. All rights reserved. Avery Dennison and all other Avery Dennison brands, this publication, its content, product names and codes are owned by Avery Dennison Corporation. All other brands and product names are trademarks of their respective owners. This publication must not be used, copied or reproduced in whole or in part for any purposes other than marketing by Avery Dennison. All Avery Dennison statements, technical information and recommendations are based on tests believed to be reliable but do not constitute a guarantee or warranty. All Avery Dennison products are sold with the understanding that purchaser has independently determined the suitability of such products for its purposes. All Avery Dennison's products are sold subject to Avery Dennison's general terms and conditions of sale.