

■ Connections

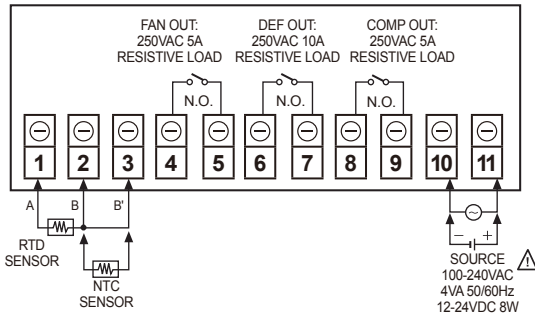

■ Installations

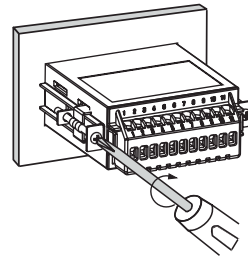

※Insert this unit into a panel, fasten bracket by pushing with tools as shown

■ Dimensions

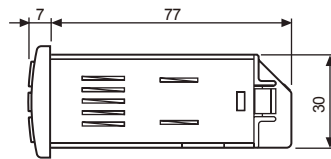
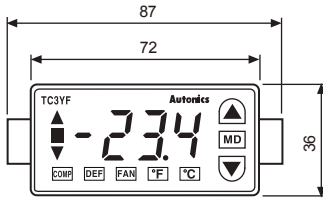

●Panel cut-out

(unit: mm)

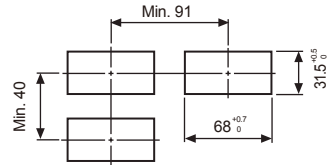

■ Parts description

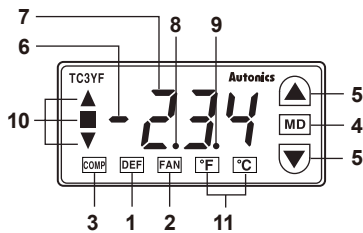

1. DEF(Defrost output lamp): Light is ON when defrost output is ON.
2. FAN(Evaporation-fan output lamp): Light is ON when evaporation output is ON.
3. COMP(Compressor output lamp): Light is ON when compressor output is ON.
4. MD key: For entering, changing, shifting and saving parameters
5. Up/Down key (Setting key: Up/Down): For changing parameters
6. - : Displaying minus symbol
7. Display process value:
Display a current value (PV) on RUN mode.
Display a parameter and a setting value when setting parameter.
8. ●(Display a decimal point): Display a decimal point when the time unit is 'Min'
9. ●(Display a decimal point): Display a decimal point when the temperature unit is '°C'

10. Display a deviation(▲, ■, ▼): SV is standard, PV(Present temperature) - ▲, ▼(red) / ■ (green)

11. Temperature unit(°C, °F): Selectable °C or °F

※When delay time is applied, the output lamp of defrost output, evaporation-fan and compressor is ON simultaneously after the lamp flashes every one second.

■ Input type and range

Input sensor	Temperature range (°C)	Temperature range (°F)
RTD(Dpt100Ω)	-99.9 to 99.9	-148 to 212
Thermistor	-40.0 to 99.9	-40 to 212

■ SV Setting

- ※If any key is untouched for 60sec., it returns to RUN mode.
- ※When pressing MD key for displaying setting value, it returns to RUN mode.
- ※When Down key at 0.0, minus values are enable to set.
- ※Press Up/Down key to set(change) the value continuously, number is increased(decreased) at high speed.

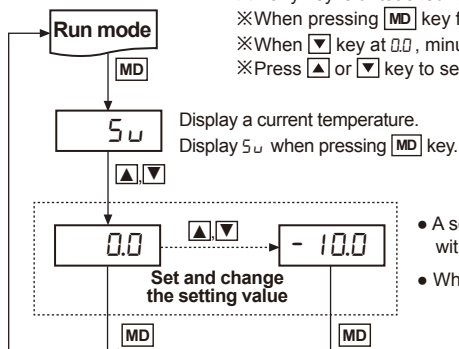

- A setting value flashes every 0.5 sec., and it is available to change the value with Up/Down key.
- When pressing MD key, a setting value is saved and it returns to RUN mode.

Freezing/Defrost type

Parameter 1 group

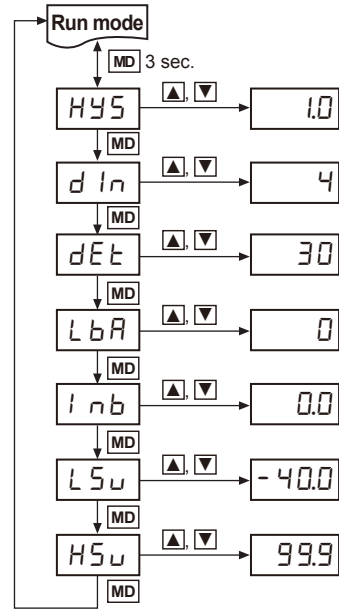

- ※In RUN mode, if **[MD]** key is pressed for 3 sec., it enters into parameter 1 group.
- ※When entering to parameter 1 group, **H_L5** parameter is displayed.
- ※After checking or changing setting value in each parameter, press **[MD]** key to save and move to next parameter setting.
- ※Press **[MD]** key for 3 sec. during setting operation, it returns to RUN mode.

- HYS** → 1.0
Set a hysteresis of compressor output.
Set range: 0.5 to 5.0°C(2 to 50°F)
- dIn** → 4
Set a defrosting interval.
Set range: 0 to 24 hours
※If defrosting interval is set to 0, it is operated as a manual.
- dEt** → 30
Set the time of defrosting operation.
Set range: 0 to 59 min.
※If defrosting interval is set to 0, it does not operated.
- LbA** → 0
Set monitoring time for loop break alarm
Set range: 0 to 999 sec.
※If monitoring time is set to 0, LBA does not operated.
- Inb** → 0.0
Correct an error generated in input sensor.
Set range: -10.0 to 10.0°C
- LSu** → -40.0
Set the low limit value.
Set range: Within the rated temperature range by input sensor
- HSu** → 99.9
Set the high limit value.
Set range: Within the rated temperature range by input sensor

Parameter 2 group

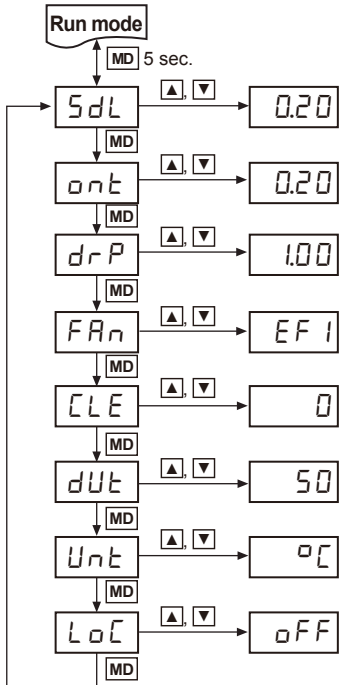

- ※In RUN mode, if **[MD]** key is pressed for 5 sec., it enters into parameter 2 group.
- ※When entering to parameter 2 group, **S_dL** parameter is displayed.
- ※After checking or changing setting value in each parameter, press **[MD]** key to save and move to next parameter setting.
- ※Press **[MD]** key for 3 sec. during setting operation, it returns to RUN mode.

- SdL** → 0.20
Set a start-up delay and re-operation time of compressor.
Set range: 0m10s to 9m59s
- onT** → 0.20
Set a minimum ON time to prevent frequent ON/OFF of compressor.
Set range: 0m10s to 5m00s
- drP** → 1.00
Set a delay time of defrost-end and evaporation-fan.
Set range: 0m00s to 5m59s
- FRn** → EF1
Set the evaporation-fan operation mode.
EF1 ← [A] → EF2 ← [A] → EF3 ← [A] → EF4 ← [A] → EF5
- CLt** → 0
Set operation interval of compressor in error.
Set range: 0 to 20ms
- dUt** → 50
Set the ON operation ratio(%) of compressor within operation interval in error.
Set range: 0 to 100%
- UnT** → °C
Set a temperature unit.
°C ← [A] → °F
- LoC** → OFF
Set a lock mode.
OFF ← [A] → L.C.1 ← [A] → L.C.2 ← [A] → L.C.3

oFF	Unlocks
L.C.2	Locks parameter 1, 2 group
L.C.1	Locks parameter 2 group
L.C.3	Locks parameter 1, 2 group, temperature SV setting

Factory default

Parameter 1 group

Parameter	Factory default	Parameter	Factory default
HYS	1.0	Inb	0
dIn	4	LSu	-40.0
dEt	30	HSu	99.9
LbA	0	When NTC sensor input unit is °C	

Parameter 2 group

Parameter	Factory default	Parameter	Factory default
SdL	0.20	CLt	0
onT	0.20	dUt	50
drP	1.00	UnT	°C
FRn	EF1	LoC	oFF

- (A) Photo electric sensor
- (B) Fiber optic sensor
- (C) Door/Area sensor
- (D) Proximity sensor
- (E) Pressure sensor
- (F) Rotary encoder
- (G) Connector/Socket
- (H) Temp. controller
- (I) SSR/ Power controller
- (J) Counter
- (K) Timer
- (L) Panel meter
- (M) Tacho/ Speed/ Pulse meter
- (N) Display unit
- (O) Sensor controller
- (P) Switching mode power supply
- (Q) Stepper motor& Driver&Controller
- (R) Graphic/ Logic panel
- (S) Field network device
- (T) Software
- (U) Other

■ Function and operation

◎ Hysteresis [HY5]

- It executes ON/OFF control and controls compressor output.
- The compressor can be damaged by frequent ON/OFF cycle at setting value. Therefore it can establish Hysteresis between activation temperature and deactivation temperature to prevent the compressor.
Ex) If TC3YF is established as setting temperature (SV) as -20°C, hysteresis[HY5] as 1.0, the compressor output is ON when it is reached -19°C and it is OFF when it is reached -21°C.
- ※In ON/OFF control, the temperature is lower than SV, the output is OFF and it is ON when it is higher and it is also designated as dual position control.
- ※The setting range of hysteresis is 0.5 to 5.0°C (2 to 50°F).

◎ Input correction [INB]

It corrects an error generated by temperature sensor inputted from external.(set range: -10.0 to 10.0°C / -18 to 18°F)
Ex) When room temperature is -18°C, the display temperature of temperature controller is -20°C, set the input correction [INB] value as 2.0, it is corrected as -18°C.

◎ Defrost



When compressor is operated for a long time, the efficiency is lowered by the frost evaporator and freezer built in. A defrost designates to remove frost and ice around the evaporator.

● Heating defrost(Auto defrost)

Mount a heater next to an evaporator and operate it with defrost interval [dln] and time [dEt] of temperature controller, removing frost and ice.

● Manual defrost

Manual defrost function operates to defrost by pressing  key for 3 sec. in any time. It ignores defrost cycle and operates defrost during the set time. The set defrost cycle value is not cleared.

- ※Press  key for 3 sec. and it operates defrost during the set defrost time.
- ※Press  key for 3 sec. it switches manual defrost to auto defrost.(At the OFF of defrost output, defrost cycle starts again.)
- ※When defrost interval is set to "00", it is only operated as manual defrost.
- ※When it used as manual defrost, compressor output and evaporation-fan output are OFF when the defrost output is ON.
- ※The setting range of defrost interval [dln] is 0 to 24 hours and defrost time [dEt] is 0 to 59 min.

◎ Cooling(Compressor) operation

Temperature control: Keep the setting temperature by repeating ON/OFF operation in the range of hysteresis.

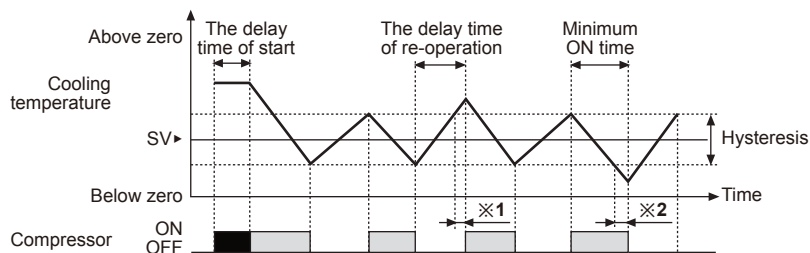

※  : The output is not operated, only the front COMP lamp is flashing.

● The delay time of start-up and re-operation [5dL]

1) Delay of start-up

- : When applying the power again on a compressor after power is failed, the compressor will be overloaded. In this case, delay of start-up prevents curtailing of the life cycle of a compressor. The setting range is 0m10s to 9m59s.
- ※The output lamp is ON simultaneously after the lamp flashes every one second during delay time.

2) Delay of re-operation

- : It does not operate within delay time of re-operation after compressor turned OFF to prevent frequent ON/OFF. The setting range is 0m10s to 9m59s.
- ※1: For delay time of start-up, compressor output is OFF even when PV is lower than SV. It is turned ON after delay time of re-operation is over.

● Minimum ON time [ONt]

- Set a minimum ON time to prevent frequent ON/OFF. (set range: 0m10s to 5m00s)
- ※2: Compressor output is ON even when PV is lower than hysteresis. It is turned to OFF after the minimum ON time is over.

◎ Defrost operation(Heating defrost)

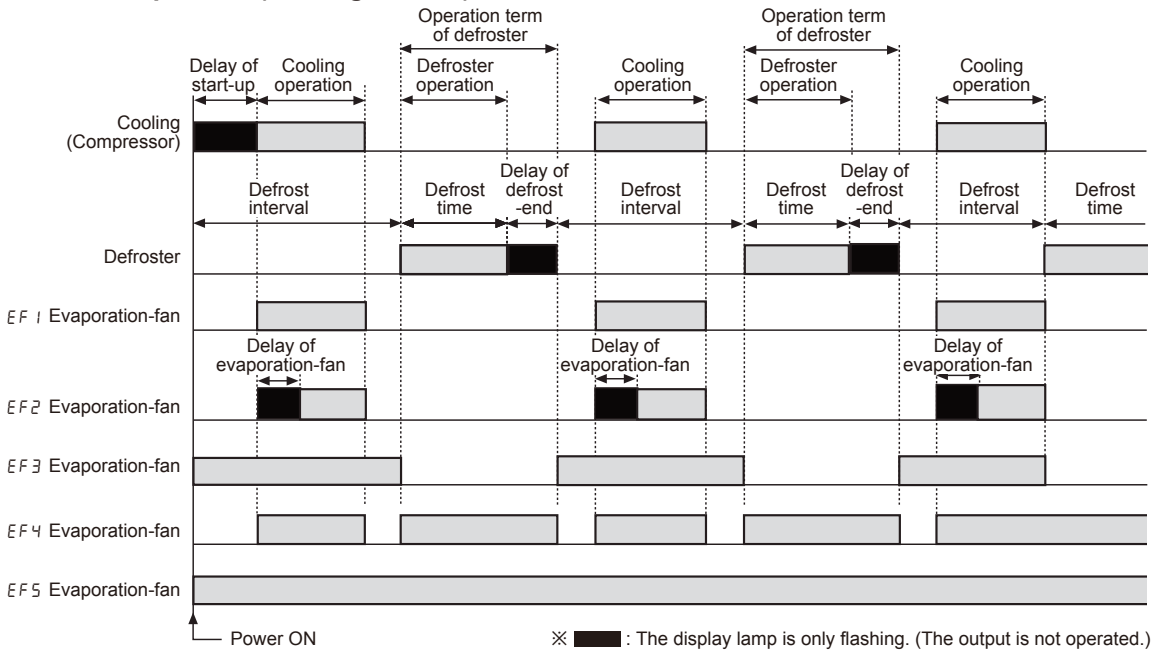

● Defrost interval [$dI n$]

It starts to defrost for relevant interval. The setting range is 0 to 24 hours.
When the defrost interval is set to "00", it is only operated as manual.

● Defrost time [dEt]

The defroster (heater) is ON during defrost time. The setting range is 0m to 59m.

● The delay time of defrost-end / evaporation-fan operation [Dripping Time: $d-rP$]

- 1)The delay time of defrost-end: It is the time for draining remained drops. After the delay time is over, compressor starts operating. (The setting range: 0m00s to 5m59s)
- 2)The delay time of evaporation-fan operation: To improve the efficiency of cooling system, the operation of evaporation fan is delayed until evaporation plate gets frozen after compressor operating. (The setting range: 0m00s to 5m59s)

※The delay time of defrost-end and evaporation-fan operation are applied with one setting time. [$d-rP$]

※When the delay time of defrost-end is finished, defrost is discontinued and defrost interval is repeated.

※The output lamp is ON simultaneously after the lamp flashing every one second during the delay time.

◎ Evaporation operation mode [$FA n$]

- Operation mode 1 [$EF 1$]: It operates same as cooler.
- Operation mode 2 [$EF 2$]: It operates after the delay time of evaporation-fan operation. OFF during defrost operation.
- Operation mode 3 [$EF 3$]: It is started when the power is applied and only operated during the defrost interval. (It does not any influence upon the freezer.)
- Operation mode 4 [$EF 4$]: The evaporation-fan operates only in the operation term of freezer or defrost, it is OFF when compressor and defroster are stopped. (It is used to control the above zero temperature.)
- Operation mode 5 [$EF 5$]: It is started when the power is applied and it works until the power is failed.

◎ Error

E_{rr} mark and content are flashing every 0.5 sec. when error is occurred.

E_{rr} / oPn	Input sensor is disconnected
E_{rr} / LbA	Input sensor is normal or freezer temperature is not changed over 1.0°C(°F) for observation time(LbA) of loop break.
E_{rr} / LLL	Process temperature (PV) is lower than the display range
E_{rr} / HHH	Process temperature (PV) is higher than the display range

※The error display of oPn , LLL , HHH disappears after the abnormal factors are cleared. (Sensor connection/returning to the display range)

(A)	Photo electric sensor
(B)	Fiber optic sensor
(C)	Door/Area sensor
(D)	Proximity sensor
(E)	Pressure sensor
(F)	Rotary encoder
(G)	Connector/ Socket
(H)	Temp. controller
(I)	SSR/ Power controller
(J)	Counter
(K)	Timer
(L)	Panel meter
(M)	Tacho/ Speed/ Pulse meter
(N)	Display unit
(O)	Sensor controller
(P)	Switching mode power supply
(Q)	Stepper motor& Driver&Controller
(R)	Graphic/ Logic panel
(S)	Field network device
(T)	Software
(U)	Other

◎ Operation cycle [$CL E$] / ON duty ratio of compressor in error [$d U E$]

When an error occurs, repeats ON/OFF operation based on setting values of operation cycle[$CL E$] and ON duty ratio[$d U E$] of second setting group to protect the inside of the compressor. This is repeated until error is removed.

※The setting range of operation cycle: 0 to 20 min, The setting range of ON duty ratio: 0 to 100%

※When operation cycle of compressor is "0", it keeps OFF status in error.
The ON duty ratio [$d U E$] is not displayed in error.

※The duty ratio of compressor ON is "100", it keeps ON status in error.

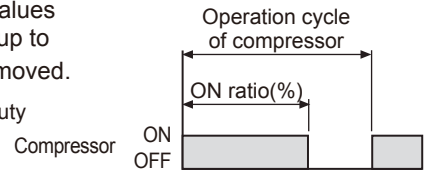

◎ Loop Break Alarm (LBA)

When the cooling temperature is not changed over 1.0°C(2°F) during monitoring time set at loop break alarm[$L b A$] parameter, it is regarded as abnormal operation. It displays $E r r$ and $L b A$ every 0.5sec. and the compressor output repeats ON/OFF by the operation cycle[$CL E$] and ON duty ratio [$d U E$] setting in error.

Check a compressor and press \blacktriangle , \blacktriangledown keys for 3 sec. at the same time and error display is cleared. It operates normally. When set value of LBA is set as "0", LBA function does not operate.(LBA set range: 0 to 999 sec.)

■ Proper usage

- Please beware not to exceed the rated specification of relay when using relay contact or it may cause a fire with breakdown.
- Please mount a surge absorption device at coil when controlling high-capacity power relay or a magnet, the counter electromotive force can be flowed into the inside of the device for relay contact operation.
- Please install power switch or circuit-breaker in order to cut power supply off.
- The switch or circuit-breaker should be installed near by users.
- This unit is designed for temperature controlling only. Do not apply this unit as a voltage meter or a current meter.
- In case of using RTD sensor, 3-wire type must be used. If you need to extend the line, 3-wires must be used with the same thickness as the line. It might cause temperature difference if the resistance of line is different.
- Please check the polarity and connect correctly when connecting RTD sensor to temperature controller. NTC sensor is a non-polarity.
- In case of making power line and input signal line close, line filter for noise protection should be installed at power line and input signal line should be shielded.
(Note) Please make sensor line shortly and use it because the narrow range of input correction range.
- Keep away from the high frequency instruments.(High frequency welding machine & sewing machine, big capacitive SCR controller)
- Please use AWG28-12 for power input and relay output connection, fasten the terminal block as a torque 0.3N-m.
- Installation environment
 - It shall be used indoor.
 - Altitude Max. 2000m.
 - Pollution Degree 2
 - Installation Category II.