

Autonics Multi Indicator KN-2000W SERIES

INSTRUCTION MANUAL



Thank you very much for selecting Autonics products.
For your safety, please read the following before using.

Safety Considerations

- ※Please keep these instructions and review them before using this unit.
- ※Please observe the cautions that follow;
- Warning** Serious injury may result if instructions are not followed.
- Caution** Product may be damaged, or injury may result if instructions are not followed.
- ※The following is an explanation of the symbols used in the operation manual.
- Caution:** Injury or danger may occur under special conditions.

Warning

- In case of using this unit with machinery (E.g.: nuclear power control, medical equipment, ship, vehicle, train, airplane, combustion apparatus, safety device, crime/disaster prevention equipment, etc) which may cause damages to human life or property, it is required to install fail-safe device.**
Failure to follow this instruction may result in fire, human injury or damage to property.
- Install this unit on a panel.**
Failure to follow this instruction may result in electric shock.
- Do not connect, repair, or inspect this unit when power is ON.**
Failure to follow this instruction may result in electric shock.
- Do not disassemble the case. Please contact us if it is required.**
Failure to follow this instruction may result in electric shock or fire.
- Wire properly after checking terminal numbers.**
Failure to follow this instruction may result in fire.

Caution

- This unit shall not be used outdoors.**
Failure to follow this instruction may result in shortening the life cycle of the product or electric shock.
- Please observe the rated specifications.**
Failure to follow this instruction may result in shortening the life cycle of the product or fire.
- In cleaning this unit, do not use water or organic solvent. And use dry cloth.**
Failure to follow this instruction may result in electric shock or fire.
- Do not use this unit where there are flammable or explosive gas, humidity, direct ray of the sun, radiant heat, vibration and impact etc.**
Failure to follow this instruction may result in fire or explosion.
- Do not inflow dust or wire dregs into the unit.**
Failure to follow this instruction may result in fire or malfunction.
- Wire it properly after checking terminal numbers when connecting power cable and measuring input.**
Failure to follow this instruction may result in fire or explosion.

Ordering Information

KN-2	0	0	0	W	
Size	W	DIN W96×H48mm			
Power supply	0	100-240VAC 50 to 60Hz			
	1	24VDC			
Option output	0	No option			
	1	Transmission output (4-20mA)*1			
	4	RS485 communication output			
	5	Transmission output (4-20mA) + RS485 communication output			
Alarm output	0	No alarm output			
	2	Alarm output: 2			
	4	Alarm output: 4			
Item	KN-2	Multi Indicator			

※1: For transmission output (4-20mA), select one between transmission output+alarm output 2 or transmission output+alarm output 4.
※The above specifications are subject to change without notice.

Connections

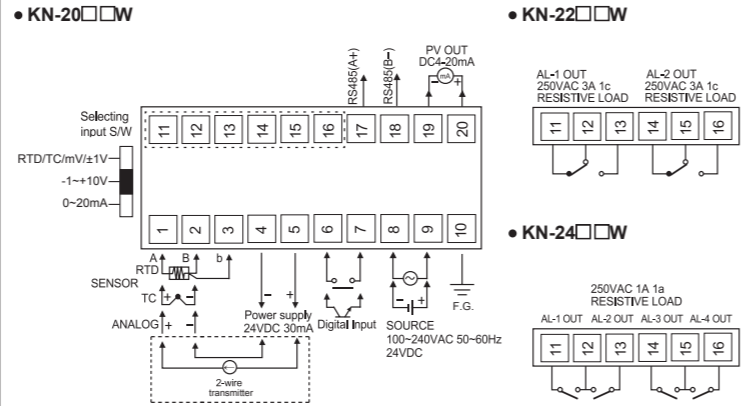

Unit Description

- Display part (red)**
 - Run mode: Displays current measurement value.
 - Parameter set mode: Displays parameter and SV.
 - Unit indicator:** Displays the set unit.
 - Alarm output indicator**: Turns ON when the alarm is ON.
- 4. MODE key**
Used to enter parameter set mode, move to parameters, save SV and return to RUN mode.
- 5. ⏪, ⏩, ⏴, ⏵ key:** Used to change parameter SV.
- 6. D.IN3**
Press the ⏪ and ⏩ keys for 3 sec at the same time, it operates the set function (alarm clear, display hold, zero-point adjustment) at [d1 - L] at program mode.

Dimensions

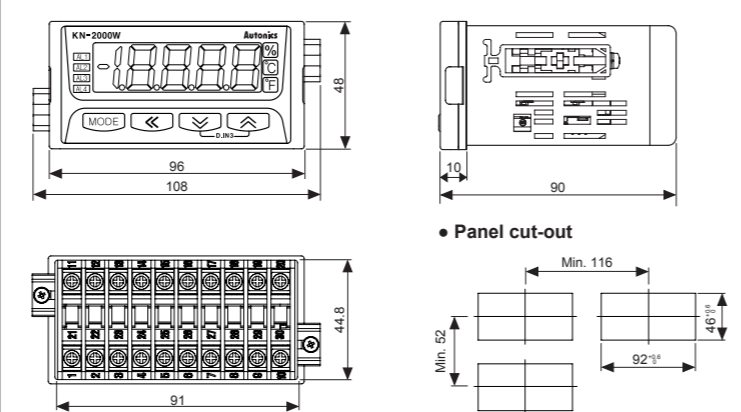

Input Type and Range

Input type	Parameter	Input range(°C)	Input range(°F)	
Thermo-couple	K(CA)	tC - t'	-200.0 to 1350.0	-328 to 2462
	J(IC)	tC - t'	-200.0 to 800.0	-328.0 to 1472.0
	E(CR)	tC - t'	-200.0 to 800.0	-328.0 to 1472.0
	T(CC)	tC - t'	-200.0 to 400.0	-328.0 to 752.0
	R(PR)	tC - r	0.0 to 1750.0	32 to 3182
	B(PR)*	tC - b	400.0 to 1800.0	752 to 3272
	S(PR)*	tC - 5	0.0 to 1750.0	32 to 3182
	N(NN)*	tC - n	-200.0 to 1300.0	-328 to 2372
	C(W5)*	tC - L	0 to 2300	32 to 4172
	L(IC)*	tC - L	-200.0 to 900.0	-328.0 to 1652.0
	U(CC)*	tC - U	-200.0 to 400.0	-328.0 to 752.0
	Platine II*	tC - P	0.0 to 1390.0	32 to 2534
RTD	Cu50Ω*	tCU50	-200.0 to 200.0	-328.0 to 392.0
	Cu100Ω*	tCu100	-200.0 to 200.0	-328.0 to 392.0
	JPt100Ω	tJPt.1	-200.0 to 600.0	-328.0 to 1112.0
	DPI50Ω	tDPE.5	-200.0 to 600.0	-328.0 to 1112.0
	DPI100Ω	tDPE.1	-200.0 to 850.0	-328.0 to 1530.0
Analog	Current	0.00 - 20.00mA	RnR1	-19999 to 19999 (display range is variable depending on decimal point position)
		4.00 - 20.00mA	RnR2	
		-50.00 - 50.00mV	Rnu1	
	Voltage	-200.0 - 200.0mV	Rnu2	
		-1.0000 - 1.0000V	R-u1	
		-1.000 - 10.000V	R-u2	

※Above input types which have the * mark are not displayed.
To display the above input types, supply the power with pressing the MODE key.

Specifications

Series	KN-2000W
Power supply	AC voltage 100-240VAC~ 50 to 60Hz DC voltage 24VDC=
Allowable voltage range	90 to 110% of rated voltage
Power consumption	AC voltage Max. 8VA DC voltage Max. 3W
Display method	4½-digit, 7-segment LED (selectable red, green, yellow) method
Character size	W10×H17mm
Input type	RTD JPt100Ω, DPt100Ω, DPt50Ω, Cu50Ω, Cu100Ω (5 types)
	Thermocouple K, J, E, T, R, B, S, N, C (W5), L, U, PLII (12 types)
Analog	•Voltage: ±1.0000V, ±50.00mV, ±200.0mV, -1.000-10.000V (4 types)
	•Current: 4.00-20.00mA, 0.00-20.00mA (2 types)
Digital input	•Contact input: max. 2kΩ in ON, Max. 90kΩ in OFF •Non-contact input: residual voltage max. 1.0V in ON, leakage current max. 0.03mA in OFF •Outflow current: approx. 0.2mA
Sub output	Alarm output •2-point: relay contact capacity 250VAC~ 3A 1c •4-point: relay contact capacity 250VAC~ 1A 1c
	Transmission output ISOLATED DC4-20mA (PV transmission) load resistance max. 600Ω
Com. output	RS485 (Modbus RTU)
Display accuracy	±0.2% F.S. ±1-digit (25±5°C)
	±0.3% F.S. ±1-digit (-10 to 20°C, 30 to 50°C) In case of thermocouple and below -100°C input, [±0.4% F.S.]±1-digit ※TC-T, TC-U is min. ±2.0°C
Setting method	Set by front keys or RS485 communication
Alarm output hysteresis	Set ON/OFF interval (1 to 999-digit)
Sampling cycle	Analog input: 100ms, temperature sensor input: 250ms
Dielectric voltage	2000VAC 50/60Hz for 1 min (between input terminal and power terminal)
Vibration	0.75mm amplitude at frequency of 5 to 55Hz (for 1 min) in each X, Y, Z direction for 2 hours
Relay life cycle	2-point Mechanical: min. 10,000,000, Electrical: min. 100,000 (250VAC 3A resistance load)
	4-point Mechanical: min. 20,000,000, Electrical: min. 500,000 (250VAC 1A resistance load)
Insulation resistance	Over 100 MΩ (at 500VDC megger)
Noise immunity	±2kV the square wave noise (pulse width 1μs) by noise simulator
Memory retention	Approx. 10 years (non-volatile semiconductor memory type)
Environ -ment	Ambient temp. -10 to 50°C, storage: -20 to 60°C Ambient humi. 35 to 85%RH, storage: 35 to 85%RH
Approval	CE
Weight*1	Approx. 332g (approx. 200g)

※1: The weight includes packaging. The weight in parenthesis is for unit only.
※Environment resistance is rated at no freezing or condensation.

Communication

- Communication set [Program mode: Addr, bAud]**
You can set communication address [Addr] and communication speed [bAud] for RS485 communication.
 - Communication write enable/disable [Program mode: ConW]**
You can set to enable [EnR] or disable [diSR] or writing parameter setting by RS485 communication.
 - Communication manual**
Refer to communication manual for RS485 communication.
 - Visit our web site (www.autonics.com) to download communication manual and software [Integrated device management program: DAQMaster].
 - Software [Integrated device management program: DAQMaster]**
Integrated device management program, DAQMaster, is able to set and monitor parameters. It is available only for RS485 communication models.
- | Item | Minimum requirements | Specifications |
|------------------|------------------------------------------------------------|-----------------------------------------------------------------------------------------------------------------------------|
| System | IBM PC compatible computer with Intel Pentium III or above | Com. method RS485 2-wire half duplex
Com. speed(BPS) 19200, 9600, 4800, 2400, 1200
Converter Converter built in RS232 |
| Operating system | Microsoft Windows 98/NT/XP/Vista/7/8/10 | Max. connections 32 units |
| Memory | 256MB or more | Com. distance Max. 1200m (within 700m recommended) |
| Hard disk | More than 1GB of free hard disk space | Protocol Modbus 1.1 RTU |
| VGA | 1024×768 or higher resolution display | Parity None |
| Others | RS-232 serial port (9-pin), USB port | Stop Bit 1-bit |
| | | Data length 8-bit |

Monitoring Mode

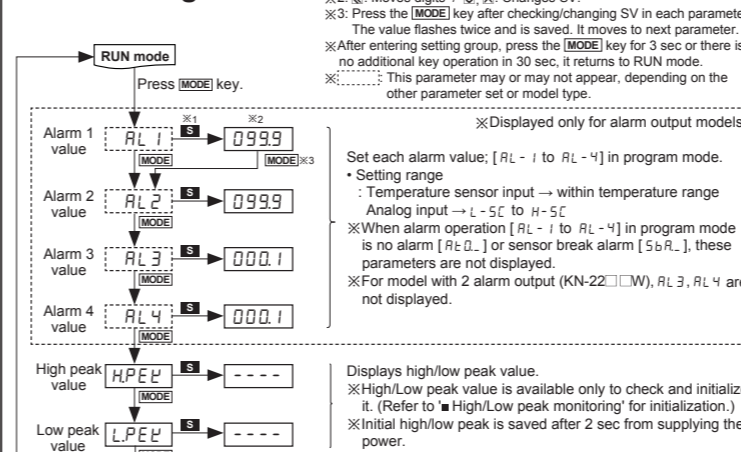

Program Mode

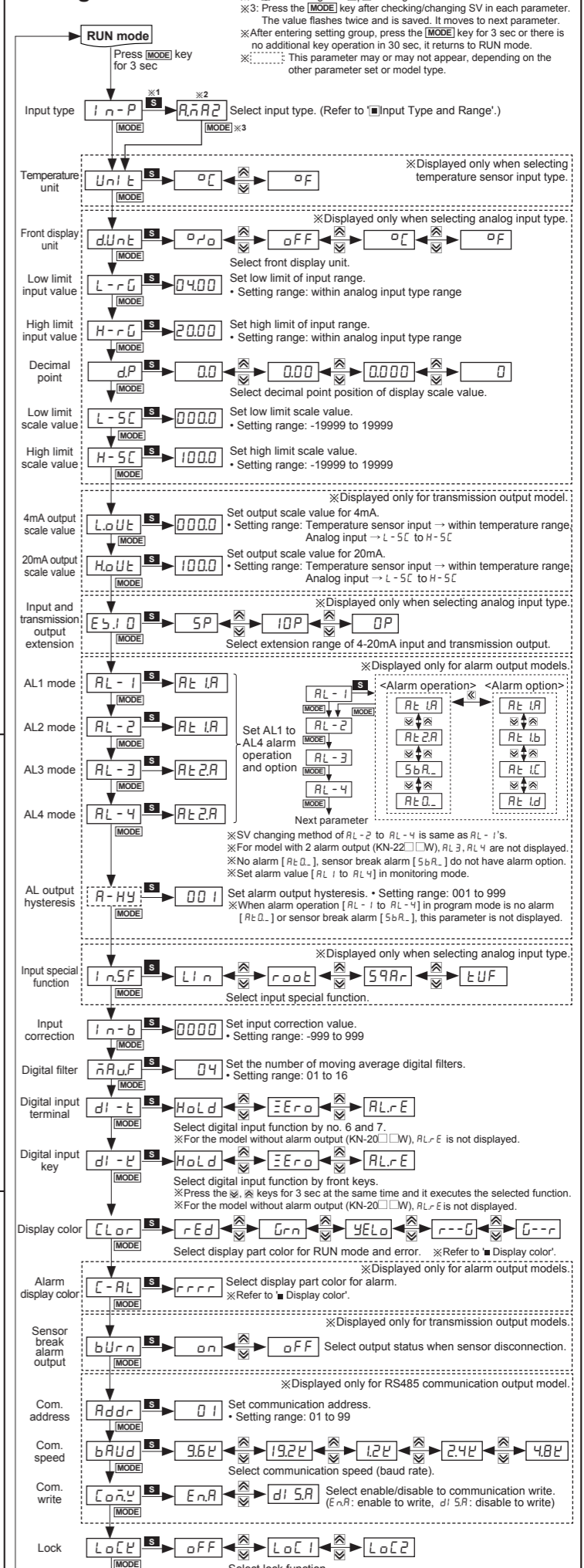

Functions

Alarm [AL-1, AL-2, AL-3, AL-4]

This product has 2 or 4 alarms to operate individually when the value is too high or low. Alarm function is set by the combination of alarm operation and alarm option. To clear alarm, use digital input function (setting $d1 - t, d1 - t$ as $AL-1E$) or turn the power OFF and ON.

※For the model (KN-20□□W) without alarm output, these parameters are not displayed.

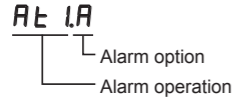

Alarm operation

Mode	Name	Alarm operation	Descriptions
$AL-0$	—	—	No alarm operation
$AL-1$	High limit alarm	OFF → ON High limit alarm value: 800°C PV	$PV \geq$ alarm temperature, alarm is ON
$AL-2$	Low limit alarm	ON → OFF Low limit alarm value: 200°C PV	$PV \leq$ alarm temperature, alarm is ON
$5bA$	Sensor break alarm	—	It will be ON when it detects sensor disconnection. Sensor break alarm does not have alarm option.

※ H: Alarm output hysteresis

Alarm option

Option	Name	Descriptions
$AL-1A$	Standard alarm	If it is an alarm condition, alarm output is ON. Unless an alarm condition, alarm output is OFF.
$AL-1b$	Alarm latch	If it is an alarm condition, alarm output is ON. Before clearing the alarm, an ON condition is latched. (Holding the alarm output)
$AL-1c$	Standby sequence	First alarm condition is ignored. From the second alarm condition, standard alarm operates. When power is ON and it is an alarm condition, it is ignored. From the second alarm condition, standard alarm operates.
$AL-1d$	Alarm latch and standby sequence	If it is an alarm condition, it operates both alarm latch and standby sequence. When power is ON and it is an alarm condition, it is ignored. From the second alarm condition, alarm latch operates.

Alarm output hysteresis [Program mode: A-HY]

Set the interval of ON/OFF alarm output. The set hysteresis is applied to AL1 to AL4 and it is as below.
※E.g.) $A-HY$: 4, high limit alarm value: 800, low limit alarm value: 200

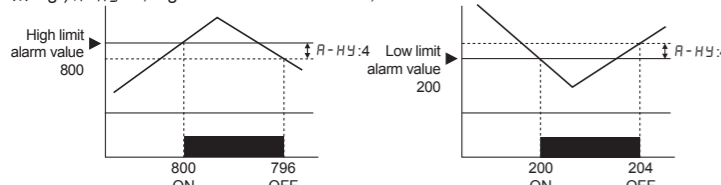

High/Low peak monitoring [Monitoring mode: HPEL, LPEL]

This function is to save high/low peak to check the invisible abnormal condition of system at $HPEL$ or $LPEL$ in monitoring mode. When the high/low peak is out of the temperature range, it displays HHHH or LLLL. To initialize high/low peak, press the MODE , MODE keys at the same time for 3 sec at $HPEL$ or $LPEL$. In this case, peak value is the present input value.

Error

Display	Descriptions	Troubleshooting
LLLL	Flashes when measured sensor input is lower than the temperature range.	When input is moved within the temperature range, it is cleared.
HHHH	Flashes when measured sensor input is higher than the temperature range.	
bUr	Flashes when the sensor is break or not connected.	Check temperature sensor connection.
Err	Flashes when there is error to SV	Check set conditions and re-set it.

User input range [Program mode: L-rG, H-rG]

When selecting analog input, you can set the input range for your purpose. Set low limit input value [$L-rG$] and high limit input value [$H-rG$] to limit the input range.
•Set conditions:
Low limit input value [$L-rG$] +20%F.S. < High limit input value [$H-rG$]

Parameter initialization

To initialize all parameter as factory default, supply the power to the product with pressing the MODE and MODE keys at the same time and it enters initialization parameter.

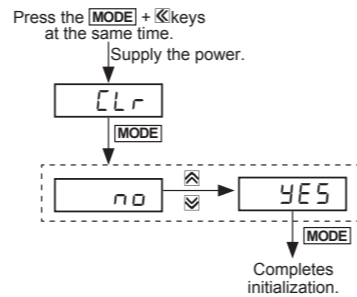

Input and transmission output extension [Program mode: EYU]

This function is to extend analog input and 4 to 20mA transmission output to 5% or 10% range.

Mode	Operation
$0P$	Outputs 4 to 20mA within analog input range.
$5P$	Outputs 3.2 to 20.8mA for 5% out of the analog input range.
$10P$	Outputs 2.4 to 21.6mA for 10% out of the analog input range.

※ This parameter is displayed only for transmission output (4-20mA) model. But it is not displayed when selecting temperature sensor input.

Input correction [Program mode: I-n-b]

This function is to correct the error occurring from a thermocouple, a RTD or analog input out of allowable error range of this unit. This is also available to correct error when a sensor cannot contact the subject position by calculating the error temperature. Variable temperature sensors have accuracy level. Because high accuracy type is expensive, standard thermocouples are generally used. In this case, temperature sensor may occur error. By executing this function, you can get more accurate temperature. When executing input correction function, you should measure the error from a sensor accurately. If the measured error is not correct, error may be greater. (If $I-n-b = tUF, I-n-b$ as atmospheric pressure input value not as input correction function. Refer to 'Two unit function'.)
E.g.) When measured temperature is 4°C and actual temperature is 0°C. Set $I-n-b$ as -4, and display value is 0°C.

Transmission output scale [Program mode: LoUt, HoUt]

For 4-20mA current output, this function is to set the display value for 4mA [$LoUt$] and the display value for 20mA [$HoUt$]. The interval between $LoUt$ and $HoUt$ is 10% F.S. If it is below 10%, it is fixed as 10% of SV.

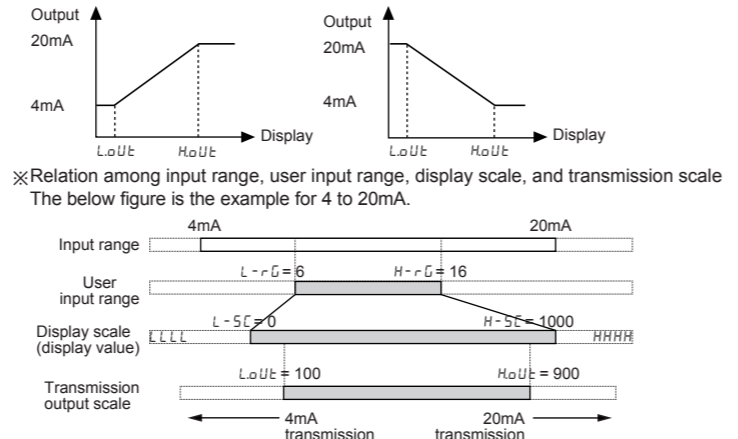

Two unit function [Program mode: tUF]

When connecting a pressure sensor, compound pressure which is below atmospheric pressure (0) is for vacuum as mmHg and which is atmospheric pressure or over it is for positive pressure as kg/cm². Atmospheric pressure is 0 kg/cm². When this unit does not display 0 kg/cm², you can correct zero-point adjustment function. When using two unit function, $L-5C$ is fixed as -760. $L-5C$ parameter is displayed but you cannot set this. You can set $H-5C$ within 0 to 19999 range.

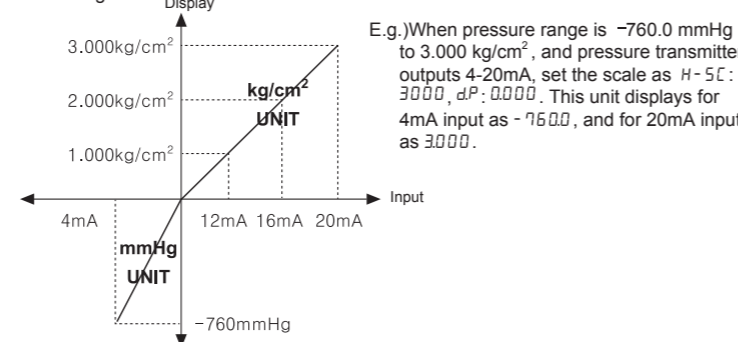

Display scale [Program mode: L-5C, H-5C]

For analog input, this function is to set (-19999 to 19999) for particular high/low limit value in order to display high/low limit value of measurement input. If measurement inputs are 'a' and 'b' and particular values are 'A' and 'B', it will display a=A, b=B as below graphs.

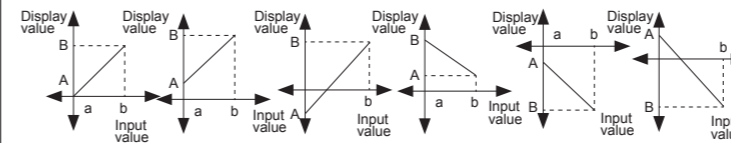

Display scale function is able to change display value for max./min. measured input by setting high limit scale [$H-5C$] and low limit scale [$L-5C$] in program mode.
※E.g.) Set high/low scale value (input range is 0 to 10V)

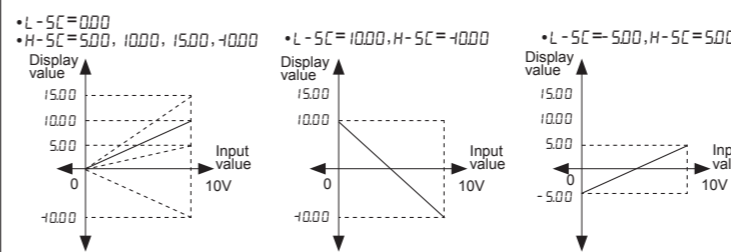

※ When changing input type, high/low scale is changed as factory default.

Input special function [Program mode: I-nSF]

When selecting analog input, this function is to display the calculated actual value by square, root ($\sqrt{\quad}$), or two unit function (TUF) as display value.

Parameter	Functions	Graph	Applications
LIn	Outputs as input value	Display: $Y = AX + B$	Standard characteristics. Input for linearity.
$r00t$	Outputs the rooted ($\sqrt{\quad}$) input value	Display: $Y = A(\sqrt{X}) + B$ ($X \geq 0$) $Y = 0 (X < 0)$	Used for measuring flows by pressure signal.
$59Rr$	Outputs the squared input value	Display: $Y = A(X^2) + B$ ($X > 0$) $Y = -A(X^2) + B$ ($X < 0$)	Used for outputting differential pressure by flow signal.
tUF	Refer to 'Two unit function'		

※ Display value and mA output value for $59Rr$:

$$\text{Display value} = \left(\frac{\text{Input value} - L-rG}{H-rG - L-rG} \right)^2 \times (H-5C - L-5C) + L-5C$$

※ Display value and mA output value for $r00t$:

$$\text{Display value} = \left(\frac{\text{Input value} - L-rG}{H-rG - L-rG} \right) \times (H-5C - L-5C) + L-5C$$

Digital filter [Program mode: nRUF]

Moving average digital filter is able to stably display and output the noise from input line and irregular signals as software.
• Filter set range : 01 to 16
(When setting as 01, digital filter function does not run.)
※ Display cycle is same when executing moving average digital filter.

Digital input [Program mode: d1-t, d1-t]

By digital input terminal [$d1-t$] (no. 6, 7 terminals) or digital input key [$d1-t$] (D.IN3: MODE for 3 sec), one of three functions executes as the below table.

Function	Operaiton
$AL-rE$	Alarm clear When alarm is ON in RUN mode, it clears alarm forcibly. (It applies only for alarm latch, alarm latch and standby sequence options.) Alarm clear operates only when the value is out of the alarm value range. After clearing alarm, alarm operates its option normally. ※ For the model without alarm output (KN-20□□W), this parameter is not displayed.
$HoLd$	Display HOLD Temporarily indicated value is stopped in order to check indicated value in unstable input.
$E-r0$	Zero-point adjustment Set preset display value as 0. This function is related with input correction [$I-n-b$]. When executing zero adjustment function in display value as 4, input correction value [$I-n-b$] is set as -4 automatically.

Alarm output for disconnecting input sensor [Program mode: bUr]

When disconnecting input sensor, you can set the status of transmission output.

Parameter	SV	Transmission output(4-20mA)
bUr	$0n$	20mA+5% output
	$0FF$	4mA-5% output

Display color [Program mode: CLor / C-RL]

This function is to change display color for occurring error, operating alarm automatically. User can check the status of this unit directly.
※ Color of monitoring mode, program mode is red.

RUN mode and error display color [Program mode: CLor]

Parameter	Display color	Parameter	Display color
SV	RUN	$YEL0$	Yellow
rEd	Red	$r-r-0$	Red
Grn	Green	$Gr-r$	Green

Alarm display color [Program mode: C-RL]

This parameter is displayed only for the alarm output models (KN-22□□W, KN24□□W).

• The number of set digit is same as the number of alarm output.

[2 alarm outputs (KN-22□□W)] $C-RL$ → rr

[4 alarm outputs (KN-24□□W)] $C-RL$ → $rrrr$

• Set color for each alarm. It changes as $r \rightarrow G \rightarrow Y \rightarrow r$ in turn.

※ E.g.) $C-RL$ → Grn (Press any one among the MODE , MODE , MODE keys.)

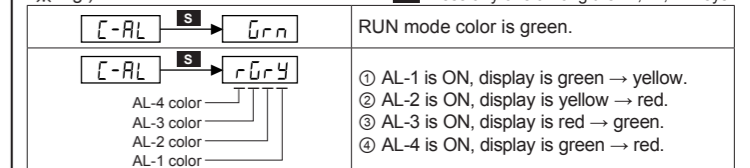

• When alarm is cleared, or two alarms operate at the same time, the latest alarm's color is applied.
• When error occurs [$HHHH, LLLL, bUr, Err, Err1$] during alarm, the set color of $CLor$ is applied.

Lock [Program mode: LoEL]

It limits to check parameter set value and to change it.

	$0FF$	$LoEL$	$LoEL2$
Program mode	●	●	○
Monitoring mode	●	●	●

●: Enable to check/set, ●: Enable to check, disable to set, ○: Disable to check
※ In $LoEL2$, only $LoEL$ parameter displays in program mode.

Factory Default

Monitoring mode

Parameter	Default	Parameter	Default	Parameter	Default
$AL1$	0999	$AL3$	0001	$HPEL$	----
$AL2$	0999	$AL4$	0001	$LPEL$	----

Program mode

Parameter	Default	Parameter	Default	Parameter	Default	Parameter	Default
$I-n-P$	$ARAR$	$LoUt$	0000	$I-n-SF$	LIn	$Addr$	01
$UnIt$	$0C$	$HoUt$	1000	$I-n-b$	0000	$bAUd$	$9.6P$
$dUnE$	$0P0$	EYU	$5P$	$nRUF$	04	$CoNt$	EnR
$L-rG$	0400	$AL-1$	$AL1A$	$d1-t$	$HoLd$	$LoEL$	$0FF$
$H-rG$	2000	$AL-2$	$AL2A$	$d1-t$	$HoLd$		
		$AL-3$	$AL3A$	$CLor$	rEd		
		$AL-4$	$AL4A$	$C-RL$	$rrrr$		
$L-5C$	0000	$A-HY$	001	bUr	$0n$		

Cautions during Use

- For connecting the power, use a crimp terminal (M3.5, max. 7.2mm).
- The connection of this unit should be separated from the power line and high voltage line in order to prevent inductive noise.
- Install a power switch or a circuit breaker to supply or cut off the power.
- Switch or circuit breaker should be installed nearby users for convenient control.
- Do not use this unit near the high frequency instruments (high frequency welding machine & sewing machine, large capacity SCR controller).
- When supplying input, if $HHHH$ or $LLLL$ is displayed, measured input may have problem. Turn off the power and check the line.
- Installation environment
 - Indoors
 - Altitude max. 2,000 m
 - Pollution Degree 2
 - Installation category II

※ It may cause malfunction if above instructions are not followed.

Major Products

- Photoelectric sensors
- Fiber optic sensors
- Door sensors
- Door side sensors
- Area sensors
- Proximity sensors
- Pressure sensors
- Rotary encoders
- Connectors/Sockets
- Switching mode power supplies
- Control switches/Lamps/Buzzers
- I/O Terminal Blocks & Cables
- Stepper motors/drivers/motion controllers
- Graphic/Logic panels
- Field network devices
- Laser marking system(Fiber, CO₂, Nd:YAG)
- Laser welding/soldering system
- Temperature controllers
- Temperature/Humidity transducers
- SSR/Power controllers
- Counters
- Timers
- Panel meters
- Tachometer/Pulse(Rate)meters
- Display units
- Sensor controllers
- Recorders
- Indicators
- Converters
- Controllers
- Thyristor units
- Pressure transmitters
- Temperature transmitters

Autonics Corporation
http://www.autonics.com

HEADQUARTERS:
18, Bansong-ro 513 beon-gil, Haeundae-gu, Busan, South Korea, 48002
TEL: 82-51-519-3232
E-mail: sales@autonics.com