

Overview

It is being digitalized and accelerated with built-in micro processor because of development of computer. It is widely used in industrial NC, ROBOT, servo motors and OA equipment in order to detect accurate location and operating speed and to provide some feedback. Rotary encoder is a device that converts shaft's rotation angle into electrical signals (pulse) and provides an output.

Principle Of Operation

Incremental rotary encoder

Incremental rotary encoder consists of a rotating slit which is painted black pattern and a fixed slit between light emitting elements and light receiving elements. By rotating encoder's shaft, light from the light emitting elements passes through these slits, or is blocked. The passing light is converted as current signal by light receiving element. This current signal outputs square wave pulse through a wave shaping circuit and an output circuit. Incremental output phases are A phase, B phase which have phase difference at 90°, and Z phase, zero-reference phase.

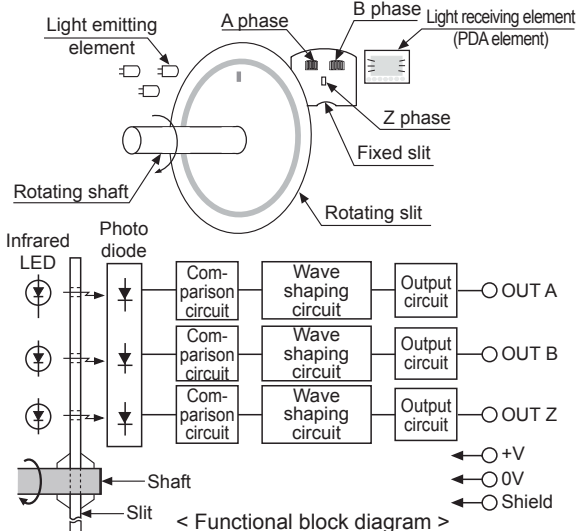

Absolute rotary encoder

The absolute rotary encoder divides from 0° to 360° as certain rate and specifies electrical digital code (BCD, Binary, Gray code) to the each divided angle position. The absolute rotary encoder as the absolute angle sensor outputs the specified digital code according to the rotational shaft position. Due to no impact on the electric characteristics, this encoder does not need memory retention circuit against power failure and has high noise strength.

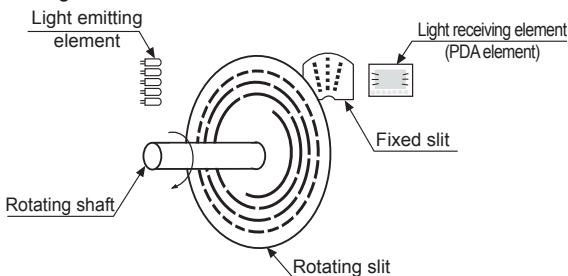

Connection Example And Output Types Of Rotary Encoder

Totem pole output

A totem pole output is a type of electronic circuit that consist of two transistors between +V and 0V as shown in the figure below. When output signal is "H", upper transistor will be ON and lower transistor will be OFF. When output signal is "L", upper transistor will be OFF and lower transistor will be ON. Totem pole output features low output impedance because the circuit is designed to be capable of flowing current in both directions. In addition, it has little influence of waveform distortion and noise, and is used for longer encoder line.

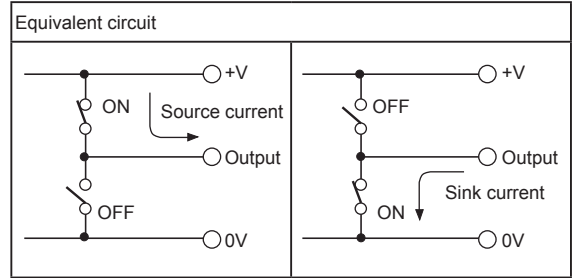
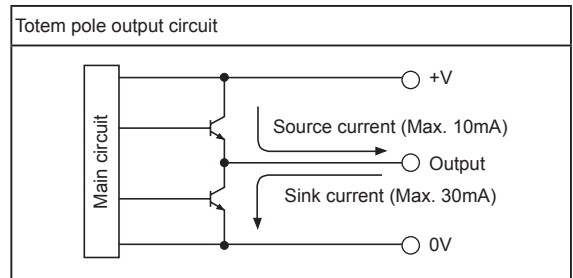

In case of voltage output type

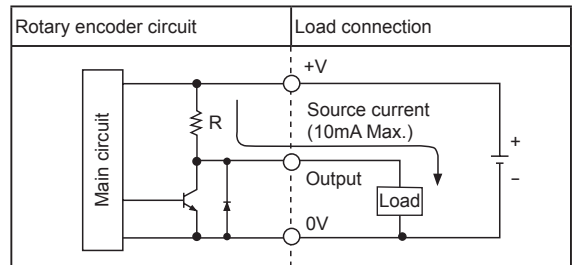

In case of NPN open collector output type

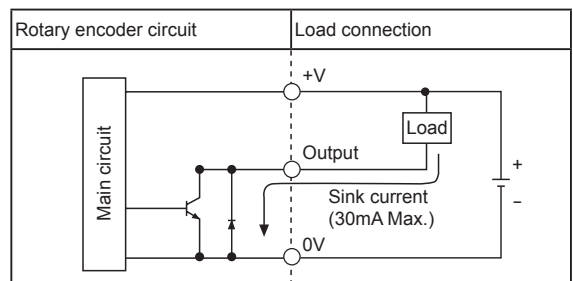

(A) Photoelectric Sensors

(B) Fiber Optic Sensors

(C) Door/Area Sensors

(D) Proximity Sensors

(E) Pressure Sensors

(F) Rotary Encoders

(G) Connectors/ Sockets

(H) Temperature Controllers

(I) SSRs / Power Controllers

(J) Counters

(K) Timers

(L) Panel Meters

(M) Tacho / Speed / Pulse Meters

(N) Display Units

(O) Sensor Controllers

(P) Switching Mode Power Supplies

(Q) Stepper Motors & Drivers & Controllers

(R) Graphic/ Logic Panels

(S) Field Network Devices

(T) Software

Technical Description

● Connection example totem pole output type and IC circuit

If certain deviation occurs between encoder's max. output signal voltage (V_{out}) and max. allowable input voltage of logic IC (V_{in}), it is required to adjust circuit's voltage level as shown in the figure below.

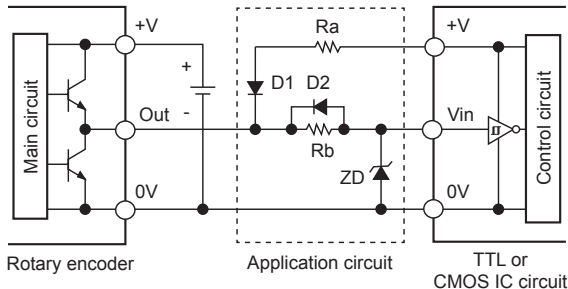

※If input voltage of control circuit is lower than applied voltage of encoder,

- 1) Make sure that zener voltage on ZD should be the same with max. allowable input voltage (V_{in}) of logic IC circuit.
- 2) Make sure that R_a and R_b should be adjusted to stable input signal level when designing application circuit.
- 3) In case cable length between encoders and control circuit is short, it is fine to design the circuit without R_a and D_1 .

● Connection example totem pole output type and Coupler

Encoder's output circuit can be isolated by using photo coupler as shown in the figure below.

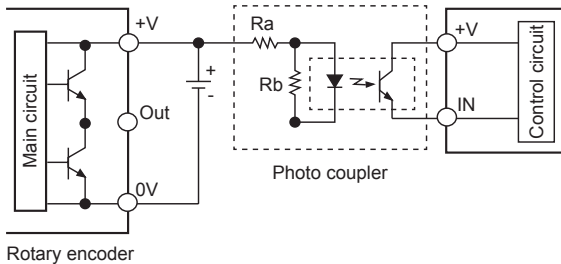

Note 1) All components applied to application circuits shall be connected adjacent to photo coupler.

Note 2) Make sure to select the photo coupler having higher response speed than encoder's max. response frequency.

◎ NPN open collector output

As shown below, it is one of various output types using NPN transistor to connect emitter with "0V" terminal, and to open "+V" terminal with collector so that collector terminal can be used as an output terminal.

It is useful when encoder's power voltage and controller's power voltage are not matched.

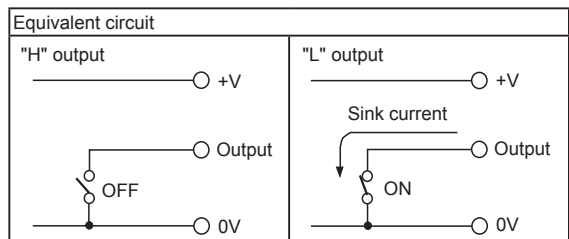
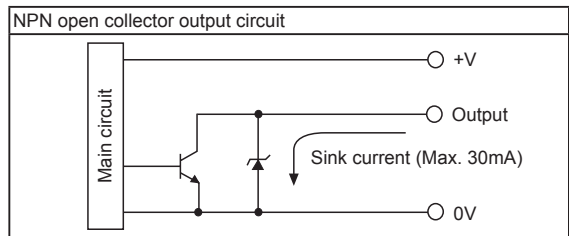

● Connection example of NPN open collector output type collector and counter.

When connect to a counter which is voltage input type, please connect to pull-up resistance between +V and output (transistor's collector) from external.

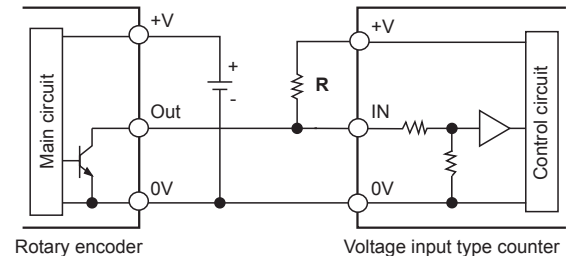

Note) Make the value of pull up resistance under 1/5 of input impedance of a counter.

● Connection example of NPN open collector output type and photo coupler

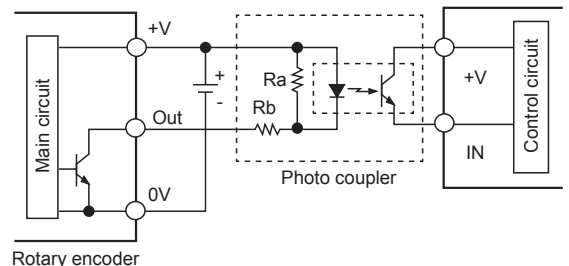

Note 1) R_a value should be a high resistance within the stable operating range of photo coupler.

Note 2) R_b value should be within the stable operating range of photo coupler. This value is not exceeded the rated load current of rotary encoder.

◎ PNP open collector output (Only for absolute type)

As shown below, it is one of various output types using PNP transistor to connect emitter with "+V" terminal, and to open "0V" terminal with collector so that collector terminal can be used as an output terminal. It is useful when encoder's power voltage and controller's power voltage are not matched.

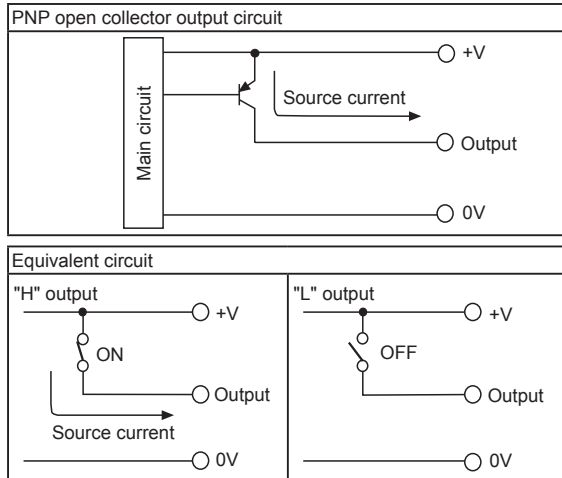

● Connection example of PNP open collector output type and external application circuit

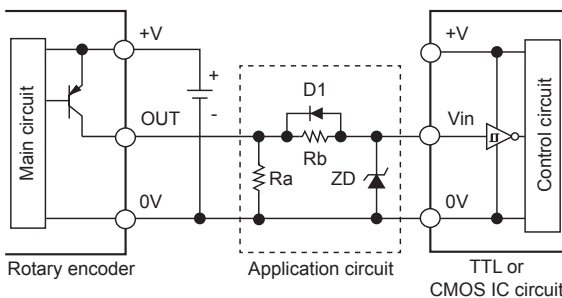

Note 1) Please use low resistance that does not exceed the rated load current of rotary encoder.

Note 2) Select components that make zener voltage of ZD the same as maximum allowable input voltage of logic IC.

● Connection example of PNP open collector output type and photo coupler

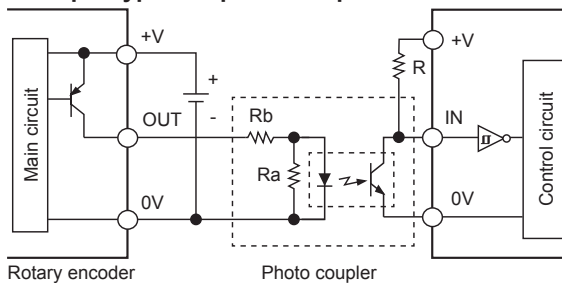

Note) Ra and Rb values should be within the stable operating range of photo coupler. These values are not exceeded the rated load current of rotary encoder.

※ Only absolute rotary encoder has PNP open collector output type.

◎ Connection example of rotary encoder and PLC

Rotary encoder output is able to connect PLC which is DC type input module. Be sure to set the output pulse of rotary encoder longer enough (more than 10 times) than scan time of PLC. (Either make rpm lower or use a low pulse encoder).

Because DC power of PLC is not stabilized, please supply stable power to rotary encoder.

● Common terminal is "0V"

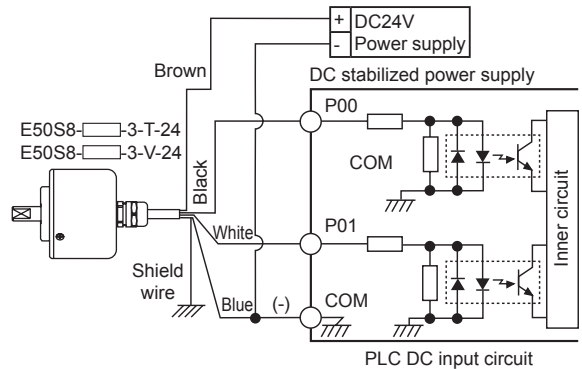

● Common terminal is "+24V"

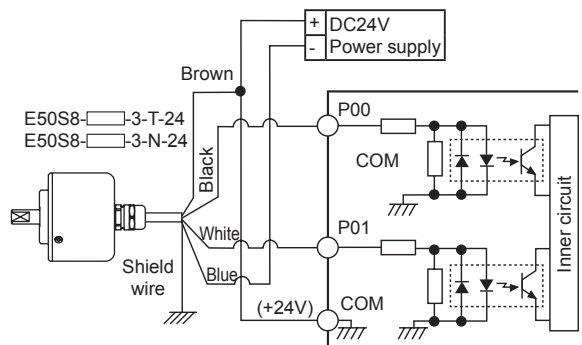

◎ Line driver output

Line Drive output uses Line Drive exclusive IC (26LS31) on output circuit as shown below. That exclusive IC has high speed response. So, it is proper for long-distance transmission and is strong on noise.

However, use IC (26LS32) corresponded to RS422A on response side.

Also, in case of extending wiring length, use twisted pair line. If make output line, it is able to get a characteristic to eliminate normal mode noises as offsetting electromotive force occurred in line.

(Terminating resistance of receiver (Zo): Approx. 200Ω)

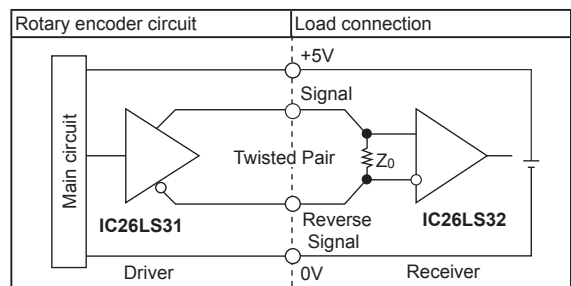

(A)	Photoelectric Sensors
(B)	Fiber Optic Sensors
(C)	Door/Area Sensors
(D)	Proximity Sensors
(E)	Pressure Sensors
(F)	Rotary Encoders
(G)	Connectors/ Sockets
(H)	Temperature Controllers
(I)	SSRs / Power Controllers
(J)	Counters
(K)	Timers
(L)	Panel Meters
(M)	Tacho / Speed / Pulse Meters
(N)	Display Units
(O)	Sensor Controllers
(P)	Switching Mode Power Supplies
(Q)	Stepper Motors & Drivers & Controllers
(R)	Graphic/ Logic Panels
(S)	Field Network Devices
(T)	Software

Technical Description

■ Glossary

● Resolution

Resolution is number of output pulse while rotary encoder shaft revolves once.

For incremental rotary encoder, resolution means number of graduations on a silt, and for absolute rotary encoder, resolution means number of divisions.

● Starting torque

The torque needed to rotate the shaft of the rotary encoder at startup. The torque during rotation is normally lower than the starting torque.

● Maximum response frequency

The max. number of pulses that rotary encoder could respond electronically in a sec. And it also can be the shaft speed when the device in which the encoder is used is in operation.

$$\text{Max. response frequency} = \frac{\text{Revolutions}}{60} \times \text{Resolution}$$

Note) Max. revolutions should be within max. allowable revolutions. Resolution should not be exceeded max. response frequency.

● Maximum allowable revolution (rpm)- Mechanical specification

It means the mechanical maximum allowable revolution of rotary encoder, and has an impact on the lifetime of the encoder.

So, please do not exceed the rated values listed in.

● Maximum response revolution (rpm)- Electronic specification

The maximum revolution speed for rotary encoder to output electric signal ordinarily. It is decided by max. response frequency and resolution.

$$\text{Max. response revolution (rpm)} = \frac{\text{Max. response frequency}}{\text{Resolution}} \times 60$$

Set resolution that makes max. response revolution not to exceed max. allowable revolution.

● CW (Clock wise)

The clockwise direction of rotation from the shaft, the shaft. (A phase precedes B phase at 90° in our company's standard feature.)

● CCW (Counter clock wise)

The counterclockwise direction of rotation from encoder's shaft. (B phase precedes A phase at 90° in our company's standard feature.)

● A, B phase

Digital signals of which phase difference is 90°, and that is to determine the direction of rotation.

● Z phase

Signal that is generated once a revolution and is called zero-reference phase.

● BCD Code (Binary-Coded Decimal code)

It is a binary-coded decimal system.

Because it is easy to change a decimal code to binary code with the '8 4 2 1' that indicates the weight of each bit, it is widely used with controllers and counters.

E.g.) In case of converting decimal digit 23 to binary-coded decimal code, it would be;

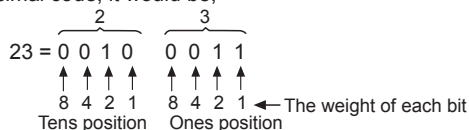

● Binary code

The most basic code expressed in combination of 0 and 1. E.g.) In case of converting decimal digit 27 to binary code, it would be 11011.

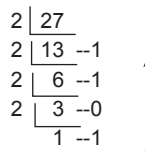

Write down in the direction of arrow.

● Gray code

Gray code is made to complement the defects of binary code. Only one bit changes state form one position to another so that it prevents errors occurring.

E.g.) In case of converting decimal digit 12 (1100 in binary code) to gray code, it would be 1010.

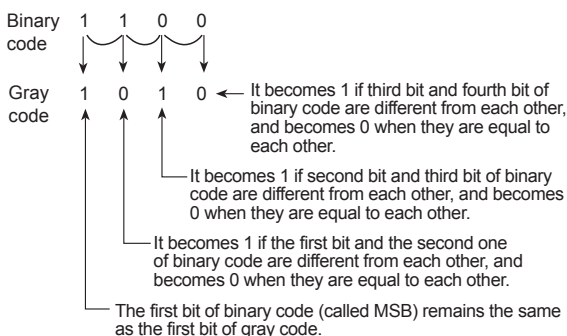

< Absolute code table >

Decimal	Gray Code				Binary Code				BCD Code					
	2 ⁴	2 ³	2 ²	2 ¹	2 ⁰	2 ⁴	2 ³	2 ²	2 ¹	2 ⁰	2 ³	2 ²	2 ¹	2 ⁰
0	0	0	0	0	0	0	0	0	0	0	0	0	0	0
1	0	0	0	0	1	0	0	0	0	1	0	0	0	0
2	0	0	0	1	1	0	0	0	1	0	0	0	0	1
3	0	0	0	1	0	0	0	0	1	1	0	0	0	1
4	0	0	1	1	0	0	0	1	0	0	0	0	1	0
5	0	0	1	1	1	0	0	1	0	1	0	0	0	1
6	0	0	1	0	1	0	0	1	1	0	0	0	0	1
7	0	0	1	0	0	0	0	1	1	1	0	0	0	1
8	0	1	1	0	0	0	1	0	0	0	0	0	0	0
9	0	1	1	0	1	0	1	0	0	1	0	0	0	1
10	0	1	1	1	1	0	1	0	1	0	0	0	1	0
11	0	1	1	1	0	0	1	0	1	1	0	0	0	1
12	0	1	0	1	0	0	1	1	0	0	0	0	1	0
13	0	1	0	1	1	0	1	1	0	1	0	0	0	1
14	0	1	0	0	1	0	1	1	1	0	0	0	1	0
15	0	1	0	0	0	0	1	1	1	1	0	0	0	1
16	1	1	0	0	0	1	0	0	0	0	0	0	1	1
17	1	1	0	0	1	1	0	0	0	1	0	0	1	1
18	1	1	0	1	1	1	0	0	1	0	0	0	1	0
19	1	1	0	1	0	1	0	0	1	1	0	0	0	1
20	1	1	1	1	0	1	0	1	0	0	0	1	0	0
21	1	1	1	1	1	1	0	1	0	1	0	0	0	1
22	1	1	1	0	1	1	0	1	1	0	0	0	1	0
23	1	1	1	0	0	1	0	1	1	1	0	0	1	1
24	1	0	1	0	0	1	1	0	0	0	0	1	0	0
25	1	0	1	0	1	1	1	0	0	1	0	0	1	0

■ Glossary (Coupling)

◎ Misalignment

● Parallel misalignment

It rotates with parallel misalignment by δ when the centers of two axes connected by a coupling are not symmetrical. E.g.) In case of converting decimal digit 23 to binary-coded decimal code, it would be;

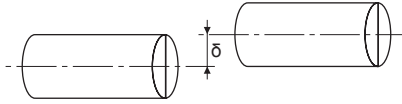

● Angular misalignment (Symmetrical)

It rotates with angular misalignment by α when the center distances of two axes connected by a coupling are equal.

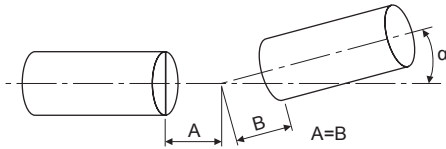

● Angular misalignment (Non-symmetrical)

It rotates with angular misalignment by α when the center distances of two axes connected by a coupling are not equal.

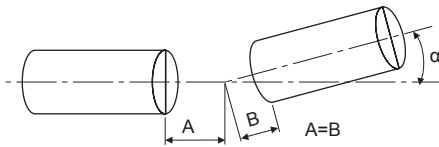

● Combined parallel and angular misalignment

It rotates with parallel misalignment by δ and angular misalignment by α when the centers of two axes connected by a coupling are not paralleled.

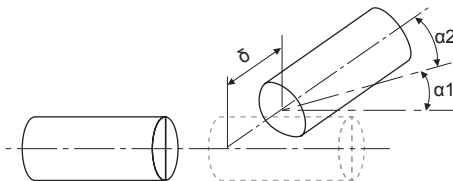

● End-play

It rotates with End-play by X from one of two shafts connected by a coupling.

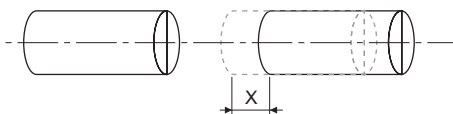

● Run out

It rotates with vibration in a radial direction.

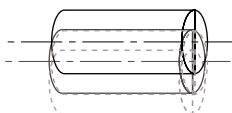

■ Proper Usage

◎ Caution for using

Because rotary encoder consist of precision parts, excessive force can cause internal slit damaged.

So, please be careful when using it.

- When combine to chains, timing belts, toothed wheels, use the coupling so that the axis of encoder is not impacted by an excessive force.

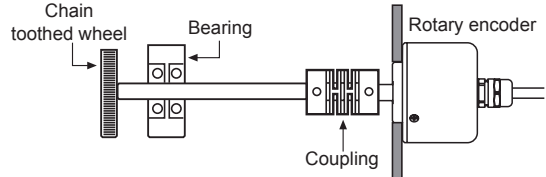

- Do not apply excessive loads to the axis of rotation.



- Be sure not to inflict more than 3kgf of the tensile on Rotary encoder wiring.

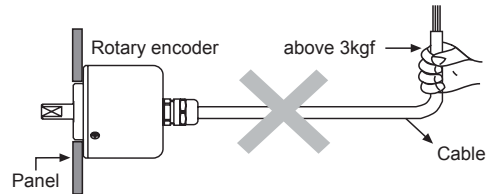

- Do not drop water or oil on the rotary encoder. Otherwise, it may cause malfunction.
- Do not hammer when combining either hollow shaft or built-in type encoder with a body of revolution. Especially be careful with high-pulse encoder that has fragile glass slit.
- Pulse phase of encoder varies depending on the direction of rotation. If the shaft rotates right when see it from the end of the shaft, it is Clockwise (CW). And if it rotates left, it is Counterclockwise (CCW). A phase precedes B phase when it is on CW.

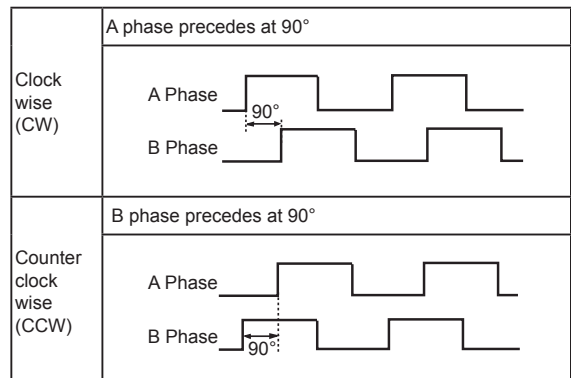

(A) Photoelectric Sensors

(B) Fiber Optic Sensors

(C) Door/Area Sensors

(D) Proximity Sensors

(E) Pressure Sensors

(F) Rotary Encoders

(G) Connectors/ Sockets

(H) Temperature Controllers

(I) SSRs / Power Controllers

(J) Counters

(K) Timers

(L) Panel Meters

(M) Tacho / Speed / Pulse Meters

(N) Display Units

(O) Sensor Controllers

(P) Switching Mode Power Supplies

(Q) Stepper Motors & Drivers & Controllers

(R) Graphic/ Logic Panels

(S) Field Network Devices

(T) Software

Technical Description

◎ Cautions when connecting wiring

- Cable shield line of rotary encoder is directly connected to the case, so please ground the metal parts of encoder case to prevent malfunction from being caused by external noises. Also make sure shield line of encoder cable to be grounded, not to be opened.

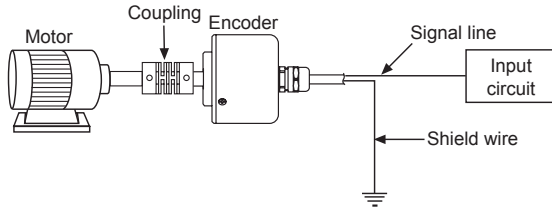

- Work on the wiring when power is turned off. And wrap it with pipe separately from other wires like power line, otherwise malfunction or internal circuit failure can be caused.
- It is better to shorten the wire length otherwise, the fall and rise time of wave form gets as long as the wire extended. Because which make it impossible to get an wanted output wave, please use it after standardizing the wave form using Schmidt trigger circuit.

◎ Vibration

- If vibration is inflicted to rotary encoder, pulses can be caused in wrong way. Thus, please place it in vibration-less area.
- The more pulses in one revolution, the narrower the gradations on resolution curve, and in which condition, operation vibration can be transmitted and that may cause uncommon pulses.