

CNE Series

Sensor Connector

■ Features

- **Wire mount plug/socket**
 - Compact and highly reliable of pressure welding connector
 - Enables to connect wires as wire mount plug/socket
 - Different 9 colors of cover by wire diameter
 - Visible wiring status with translucent cover
- **Board mount socket**
 - Enables to insert 4, 2, or 1 wire mount plugs
 - Contact placed in mold against electric shock and short-circuit
 - Mountable on board closely
- **Commons**
 - Significantly reduces connection time and effort
 - Wide products range for various wires
 - Compact and high density installation with 2mm of contact pitch
 - Max. 3A of current capacity by a pin

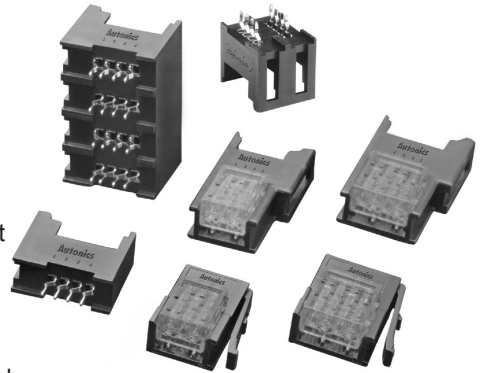

■ Ordering Information

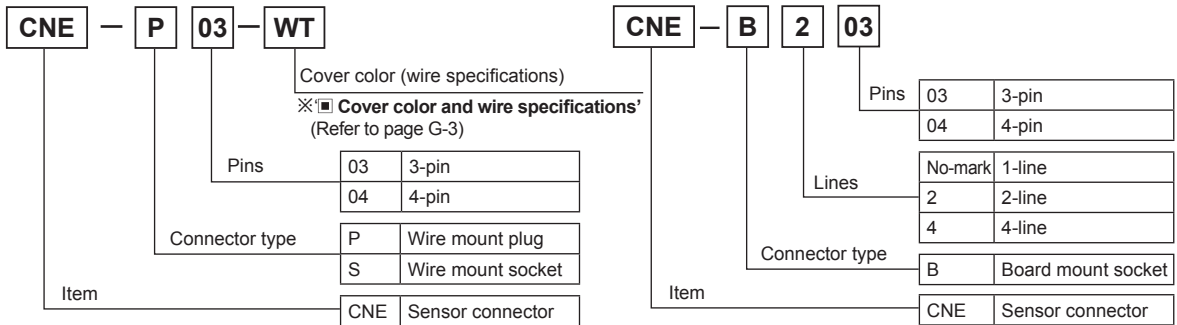

■ Specifications

Type	Wire mount plug	Wire mount socket	Board mount socket
Model	CNE-P□□	CNE-S□□	CNE-B□□
Application	Connector	Board mount socket/Wire mount socket	Wire mount plug
	Cable	AWG30-20 (Ø0.6mm to Ø2.0mm)	
	PCB	—	
			Fender plated-through hole, Hole dia.: 1.0mm, PCB thickness: 1.0 to 2.2mm
Rated voltage	Max. 250VAC~/DC=		
Rated current	Max. 3.0A		
Environment	Ambient temp.	-20 to 85°C (applying 1A), -20 to 75°C (applying 2A), -20 to 60°C (applying 3A)	
	Ambient humi.	40 to 80%RH	
Terminal retention	Min. 1.4kgf		
Pressure strength	● AWG30: Min. 0.5kgf ● AWG24: Min. 0.8kgf ● AWG20: Min. 1.0kgf		
Extraction	Min. 0.49N (50gf)/pin		
Insertion	Max. 1.96N (200gf)/pin		
Dielectric strength	1,000VAC for 1min (between terminals)		
Insulated resistance	Over 1,000MΩ (between terminals)		
Contact resistance	Max. 0.05Ω (short-current: 1mA, max. open voltage: 20mV)		
Material	Body: PC/ABS (UL94V-0), Terminal: C5210 (gold 0.2μm), Case: PC (UL94-V0)		Body: PC/ABS (UL94-V0), Terminal: C5210 (gold 0.2μm)

Sensor Connector

■ Cover Color and Wire Specifications

Cover color	3-pin	4-pin	Applied wire specifications	
			Nominal cross section area (mm ²)	Cover diameter (mm)
Transparent (WT)	CNE-□03-WT	CNE-□04-WT	0.05 to 0.08 (AWG30 to 28)	∅0.6 to 0.8
Yellow-Green (YG)	CNE-□03-YG	CNE-□04-YG		∅0.8 to 1.0
Violet (VT)	CNE-□03-VT	CNE-□04-VT		∅1.0 to 1.2
Red (RE)	CNE-□03-RE	CNE-□04-RE	0.13 to 0.21 (AWG26 to 24)	∅0.8 to 1.0
Yellow (YW)	CNE-□03-YW	CNE-□04-YW		∅1.0 to 1.2
Orange (OG)	CNE-□03-OG	CNE-□04-OG		∅1.2 to 1.6
Green (GN)	CNE-□03-GN	CNE-□04-GN	0.32 to 0.5 (AWG22 to 20)	∅1.0 to 1.2
Blue (BL)	CNE-□03-BL	CNE-□04-BL		∅1.2 to 1.6
Gray (GY)	CNE-□03-GY	CNE-□04-GY		∅1.6 to 2.0

□: P (wire mount plug), S (wire mount socket)

■ Dimensions

◎ Wire mount plug

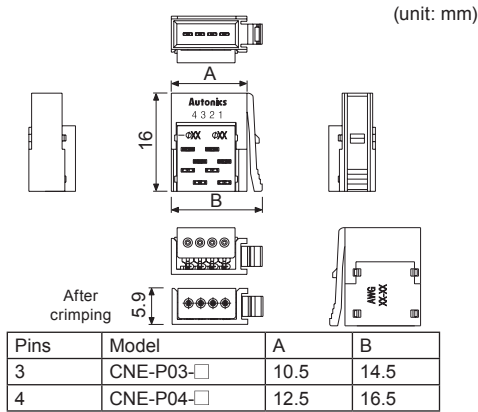

◎ Wire mount socket

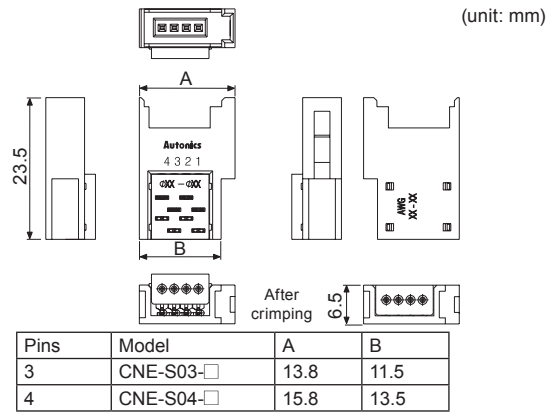

◎ Board mount socket

● CNE-B03 (1-line×3-pin)

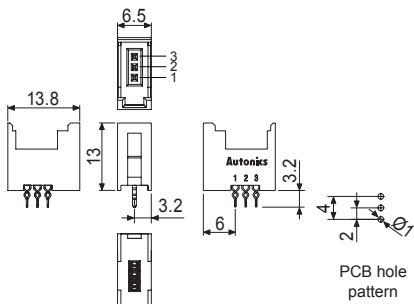

● CNE-B04 (1-line×4-pin)

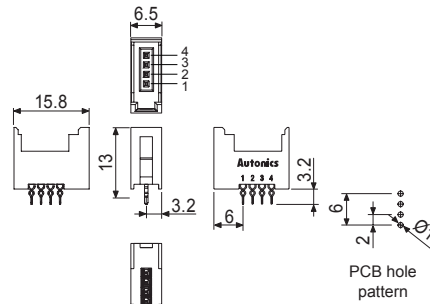

● CNE-B203 (2-line×3-pin)

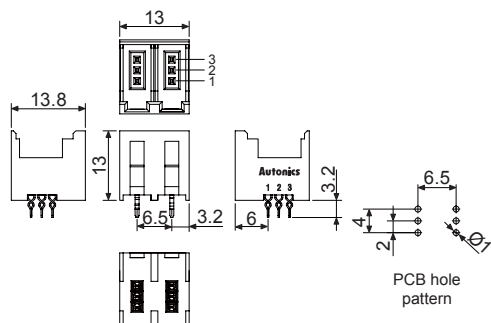

● CNE-B204 (2-line×4-pin)

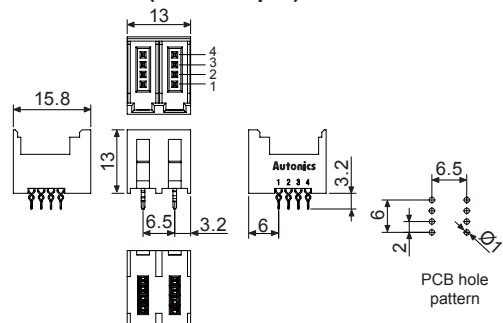

(A)	Photoelectric Sensors
(B)	Fiber Optic Sensors
(C)	Door/Area Sensors
(D)	Proximity Sensors
(E)	Pressure Sensors
(F)	Rotary Encoders
(G)	Connectors/ Connector Cables/ Sensor Distribution Boxes/ Sockets
(H)	Temperature Controllers
(I)	SSRs / Power Controllers
(J)	Counters
(K)	Timers
(L)	Panel Meters
(M)	Tacho / Speed / Pulse Meters
(N)	Display Units
(O)	Sensor Controllers
(P)	Switching Mode Power Supplies
(Q)	Stepper Motors & Drivers & Controllers
(R)	Graphic/ Logic Panels
(S)	Field Network Devices
(T)	Software

CNE Series

■ Dimensions

◎ Board mount socket

(unit: mm)

● CNE-B403 (4-line×3-pin)

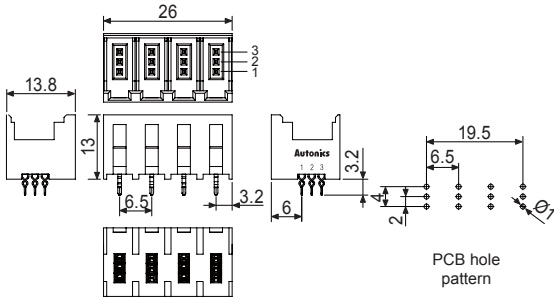

● CNE-B404 (4-line×4-pin)

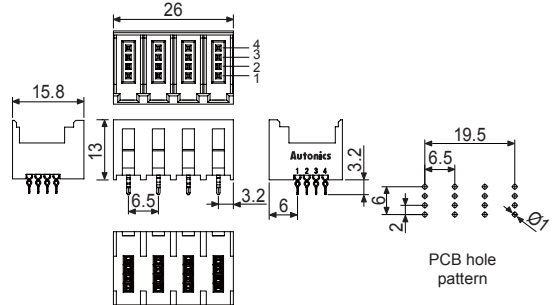

■ Wiring Sensor Connector

1) Select connector

- Check the wire specifications (conductor section, cover diameter).
- Select the proper color of sensor connector (model) by referring to the below table.

Cover color	Wire mount plug	Wire mount socket	Applied wire specifications	
			Nominal cross section area (mm ²)	Cover diameter (mm)
Transparent (WT)	CNE-P□-WT	CNE-S□-WT	0.05 to 0.08 (AWG30 to 28)	Ø0.6 to 0.8
Yellow-Green (YG)	CNE-P□-YG	CNE-S□-YG		Ø0.8 to 1.0
Violet (VT)	CNE-P□-VT	CNE-S□-VT		Ø1.0 to 1.2
Red (RE)	CNE-P□-RE	CNE-S□-RE	0.13 to 0.21 (AWG26 to 24)	Ø0.8 to 1.0
Yellow (YW)	CNE-P□-YW	CNE-S□-YW		Ø1.0 to 1.2
Orange (OG)	CNE-P□-OG	CNE-S□-OG	0.32 to 0.5 (AWG22 to 20)	Ø1.2 to 1.6
Green (GN)	CNE-P□-GN	CNE-S□-GN		Ø1.0 to 1.2
Blue (BL)	CNE-P□-BL	CNE-S□-BL		Ø1.2 to 1.6
Gray (GY)	CNE-P□-GY	CNE-S□-GY		Ø1.6 to 2.0

※□: Number of pins (03: 3-pin, 04: 4-pin)

※The proper sensor connector may be different by conductor of wire.

※Cover diameter of applied wire at connector (at translucent part) and AWG number of body backside are marked.

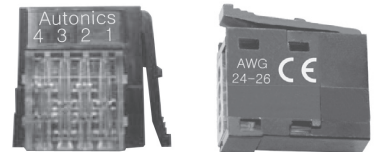

2) Insert the wires

- Check the pin numbers and insert the wires into the according holes.
- Check that the wires are fully inserted to the end of the cover.

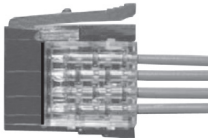

3) Crimping

- Insert the cover into the body with a jig (press fitting tool, etc).
- ※Apply pressure with the jig from the side, as shown in the figure below



4) Check the cover

- Check to make sure that the cover is level with the body and that there is no space between the cover and the body.

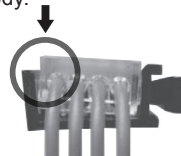

Wrong (1)
Not enough cover insertion.

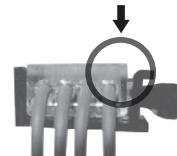

Wrong (2)
Not enough cover insertion.

※Press the part of arrows again.