

BJ Series Long Sensing Distance/BGS Reflective/Micro Spot Type

Compact And Long Sensing Distance Type

■ Features

■ Long distance sensing type

- Long sensing distance with high quality lens
- Long sensing distance
 - : Through-beam type 15m, Diffuse reflective type 1m, Polarized retroreflective type 3m (MS-2A)
- M.S.R. (Mirror Surface Rejection) function (Polarized retroreflective type)
- Compact size: W20×H32×L10.6mm
- Protection structure IP65/IP67 (IEC standard)
- Light ON/Dark ON selectable by VR
- Sensitivity adjustment VR incorporated
- Built-in reverse power polarity, output short, overcurrent protection circuit
- Mutual interference prevention function (Except through-beam type)
- Improve noise resistance and minimize effect of disturbing light

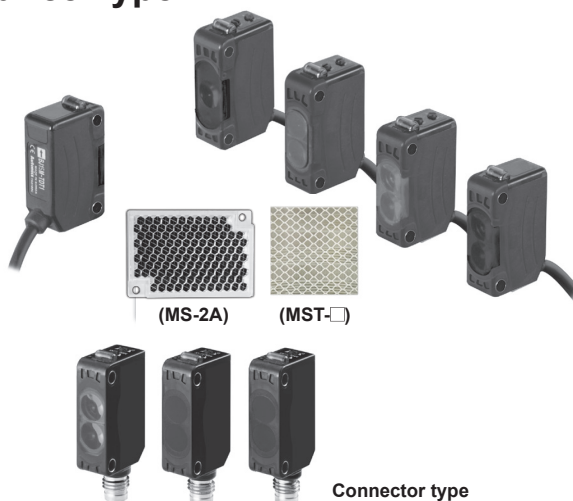

⚠ Please read "Caution for your safety" in operation manual before using.



■ Specifications

※The model name with '-C' is connector type.
 ※MST-□ is sold separately.

Type	Long distance sensing type							
Model	NPN open collector output	BJ15M-TDT BJ15M-TDT-C	BJ10M-TDT BJ10M-TDT-C	BJ7M-TDT	BJ3M-PDT BJ3M-PDT-C	BJ1M-DDT BJ1M-DDT-C	BJ300-DDT BJ300-DDT-C	BJ100-DDT BJ100-DDT-C
Model	PNP open collector output	BJ15M-TDT-P BJ15M-TDT-C-P	BJ10M-TDT-P BJ10M-TDT-C-P	BJ7M-TDT-P	BJ3M-PDT-P BJ3M-PDT-C-P	BJ1M-DDT-P BJ1M-DDT-C-P	BJ300-DDT-P BJ300-DDT-C-P	BJ100-DDT-P BJ100-DDT-C-P
Sensing type	Through-beam				Retroreflective (Built-in polarizing filter)	Diffuse reflective		
Sensing distance	15m	10m	7m	0.1 to 3m*1 (MS-2A)	1m (Non-glossy white paper 300×300mm)	300mm (Non-glossy white paper 100×100mm)	100mm (Non-glossy white paper 100×100mm)	
Sensing target	Opaque material of min. Ø12mm		Opaque material of min. Ø8mm	Opaque material of min. Ø75mm	Translucent, opaque materials			
Hysteresis	—							
Response time	Max. 1ms							
Power supply	12-24VDC±10% (Ripple P-P: Max.10%)							
Current consumption	Emitter/Receiver: Max. 20mA				Max. 30mA			
Light source	Infrared LED (850nm)	Red LED (660nm)	Red LED (650nm)	Red LED (660nm)	Infrared LED (850nm)	Red LED (660nm)	Infrared LED (850nm)	
Sensitivity adjustment	Built-in the adjustment VR							
Operation mode	Light ON/Dark ON selectable by VR							
Control output	NPN or PNP open collector output ●Load voltage: Max. 26.4VDC ●Load current: Max. 100mA ●Residual voltage - NPN: Max. 1V, PNP: Max. 2.5V							
Protection circuit	Reverse polarity protection, output short-circuit protection, interference prevention function (Except through-beam type)							
Indicator	Operation indicator: Red, Stable indicator: Green (Emitter's power indicator: Green)							
Insulation resistance	Min.20MΩ (at 500VDC megger)							
Noise resistance	±240V the square wave noise (pulse width:1μs) by the noise simulator							
Dielectric strength	1000VAC 50/60Hz for 1minute							
Vibration	1.5mm amplitude at frequency of 10 to 55Hz (for 1 min.) in each X, Y, Z direction for 2 hours							
Shock	500m/s ² (approx. 50G) in each X, Y, Z direction for 3 times							
Environment	Ambient illumination	Sunlight: Max. 11,000lx, Incandescent lamp: Max. 3,000lx (Receiver illumination)						
	Ambient temperature	-25 to 55°C, storage: -40 to 70°C						
	Ambient humidity	35 to 85%RH, storage: 35 to 85%RH						
Protection structure	BJ - IP65 (IEC standard), BJ-C - IP67							
Material	Case: PC+ABS, LED Cap: PC, Sensing part: PMMA							
Cable*2	BJ: Ø3.5mm, 3-wire, Length: 2m (Emitter of through-beam type: Ø3.5mm, 2-wire, Length: 2m) (AWG24, Core diameter: 0.08mm, Number of cores: 40, Insulator out diameter: Ø1mm)							
Accessories	Common	Mounting bracket, Bolt, Nut, VR adjustment driver			—			
	Individual	—			Reflector (MS-2A)	—		
Approval	CE							
Unit weight	BJ: Approx. 90g, BJ-C: Approx. 20g				BJ: Approx. 60g BJ-C: Approx. 30g	BJ: Approx. 45g, BJ-C: Approx. 10g		

*1: The sensing distance is extended from 0.1 to 4m or 0.1 to 5m when using optional reflector MS-2S or MS-3S.

When using reflective tapes, the reflectivity will vary by the size of the tape. Please refer to the "■ Reflectivity By Reflective Tape Model" table before using the tapes.

*2: M8 connector cable is sold separately. (Cable - AWG22, Core diameter: 0.08mm, Number of cores: 60, Insulator out diameter: Ø1.25mm)

※The temperature or humidity mentioned in Environment indicates a non freezing or condensation environment.

(A) Photoelectric Sensors

(B) Fiber Optic Sensors

(C) Door/Area Sensors

(D) Proximity Sensors

(E) Pressure Sensors

(F) Rotary Encoders

(G) Connectors/Sockets

(H) Temperature Controllers

(I) SSRs / Power Controllers

(J) Counters

(K) Timers

(L) Panel Meters

(M) Tacho / Speed / Pulse Meters

(N) Display Units

(O) Sensor Controllers

(P) Switching Mode Power Supplies

(Q) Stepper Motors & Drivers & Controllers

(R) Graphic/Logic Panels

(S) Field Network Devices

(T) Software

Transparent Glass Sensing/BGS Reflective/Micro Spot Type

■ Features

■ BGS reflective type

- Adopts BGS method superior than convergent reflective to minimize error by background, or color, material of sensing object for stable sensing by adjusting the volume
- Visible light source to check the position of sensing spot and small spot minimizing effect of the ambient objects with narrow sensing width

■ Transparent glass sensing type / Micro spot type

- Stable sensing for transparent object (LCD, PDP, glass etc) by BJG30-DDT
- Easy to check sensing location with visible micro spot (BJN Series)
- Detects tiny objects (min. sensing target $\varnothing 0.2\text{mm}$ copper wire)

■ Commonness

- Compact size: W20×H32×L10.6mm
- Protection structure IP65 (IEC standard)
- Light ON/Dark ON selectable by VR (Except BJG30-DDT)
- Sensitivity adjustment VR incorporated (Except BJG3 DDT)
- Built-in reverse power polarity, output short, overcurrent protection circuit
- Mutual interference prevention function (Except BGS reflective type)
- Improve noise resistance and minimize effect of disturbing light

⚠ Please read "Caution for your safety" in operation manual before using.

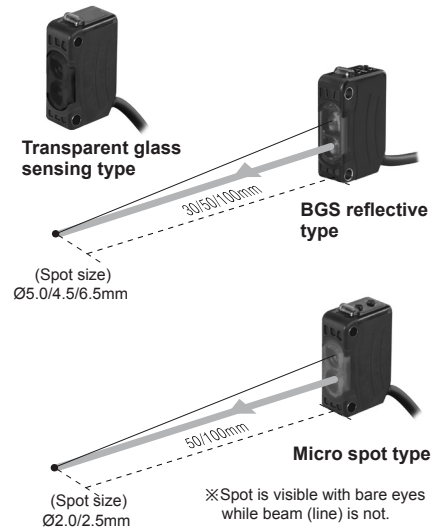

■ Specifications

Type	Transparent glass sensing type		BGS reflective type ^{※1}		Micro spot type	
Model	BJG30-DDT		BJ30-BDT	BJ50-BDT	BJN50-NDT	BJN100-NDT
Model	—		BJ30-BDT-P	BJ50-BDT-P	BJN50-NDT-P	BJN100-NDT-P
Sensing type	Diffuse reflective		BGS reflective		Narrow beam reflective	
Sensing distance	30mm (Non-glossy white paper 100×100mm)	15mm (Transparent glass 50×50mm, t=3.0mm)	10 to 30mm (Non-glossy white paper 50×50mm)	10 to 50mm (Non-glossy white paper 50×50mm)	30 to 70mm	70 to 130mm
Sensing target	Transparent glass, opaque materials, translucent		Translucent, opaque materials		Translucent, opaque materials	
Min. diameter of transmitting spot	—		Approx. $\varnothing 5.0\text{mm}$	Approx. $\varnothing 4.5\text{mm}$	Approx. $\varnothing 2.0\text{mm}$	Approx. $\varnothing 2.5\text{mm}$
Min. sensing target	—		—		Approx. min. $\varnothing 0.2\text{mm}$ (Copper wire)	
Hysteresis	Max. 20% at sensing distance		Max. 10% at sensing distance		Max. 25% at sensing distance	Max. 20% at sensing distance
Response time	Max. 1ms		Max. 1.5ms		Max. 1ms	
Power supply	12-24VDC $\pm 10\%$ (Ripple P-P: Max.10%)					
Current consumption	Max. 30mA					
Light source	Infrared LED (850nm)		Red LED (660nm)		Red LED (650nm)	
Sensitivity adjustment	—		Built-in the adjustment VR			
Operation mode	Light ON fixed		Light ON/Dark ON selectable by VR			
Control output	NPN open collector output ● Load voltage: Max. 26.4VDC ● Load current: Max. 100mA ● Residual voltage: Max. 1V		NPN or PNP open collector output ● Load voltage: Max. 26.4VDC ● Load current: Max. 100mA ● Residual voltage - NPN: Max. 1V, PNP: Min. 2.5V			
Protection circuit	Reverse polarity protection, output short-circuit protection, interference prevention function (Except BGS reflective type)					
Indicator	Operation indicator: red, Stability indicator: green					
Insulation resistance	Min. 20M Ω (at 500VDC megger)					
Noise resistance	$\pm 240\text{V}$ the square wave noise (pulse width: 1 μs) by the noise simulator					
Dielectric strength	1,000VAC 50/60Hz for 1 min.					
Vibration	1.5mm amplitude at frequency of 10 to 55Hz (for 1 min.) in each X, Y, Z direction for 2 hours					
Shock	500m/s ² (approx. 50G) in each X, Y, Z direction for 3 times					
Environment	Ambient illumination	Sunlight: Max. 11,000lx, Incandescent lamp: Max. 3,000lx (Receiver illumination)				
	Ambient temperature	-25 to 55°C, storage: -40 to 70°C				
	Ambient humidity	35 to 85%RH, storage: 35 to 85%RH				
Protection structure	IP65 (IEC standard)					
Material	Case: PC+ABS, LED Cap: PC, Sensing part: PMMA					
Cable	$\varnothing 3.5\text{mm}$, 3-wire, Length: 2m (AWG24, Core diameter: 0.08mm, Number of cores: 40, Insulator out diameter: $\varnothing 1\text{mm}$)					
Accessories	Mounting bracket, Bolt		Mounting bracket, Bolt, Nut, VR adjustment driver			
Approval	CE					
Unit weight	Approx. 45g		Approx. 50g		Approx. 45g	

※1: In case of BGS sensing type, black/white difference is max. 10% of sensing distance and sensitivity adjustment range is -10% of max. sensing distance (based on non-glossy white paper).

※ The temperature or humidity mentioned in Environment indicates a non freezing or condensation environment.

Long Sensing Distance/BGS Reflective/Micro Spot Type

■ Feature Data

◎ Through-beam type

- BJ15M-TDT- (C)- (P) / BJ10M-TDT- (C)- (P) / BJ7M-TDT- (P)

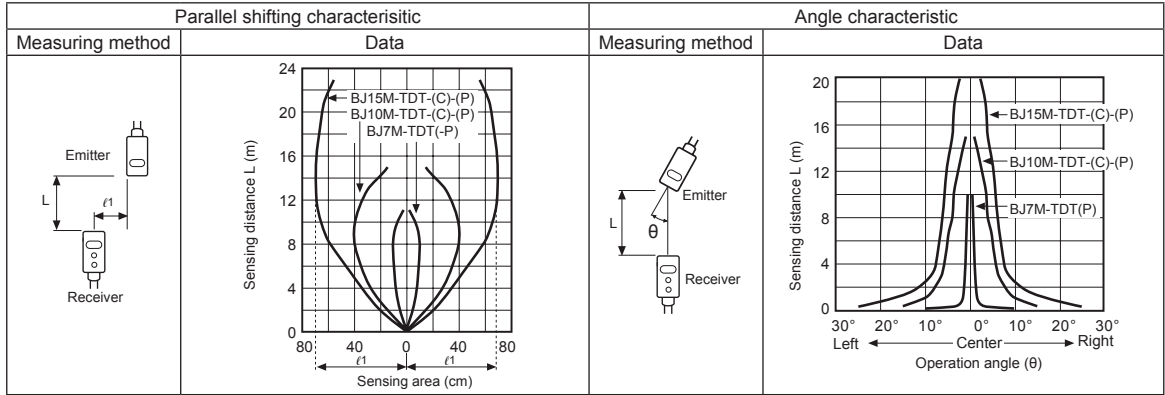

◎ Retroreflective type

- BJ3M-PDT- (C)- (P)

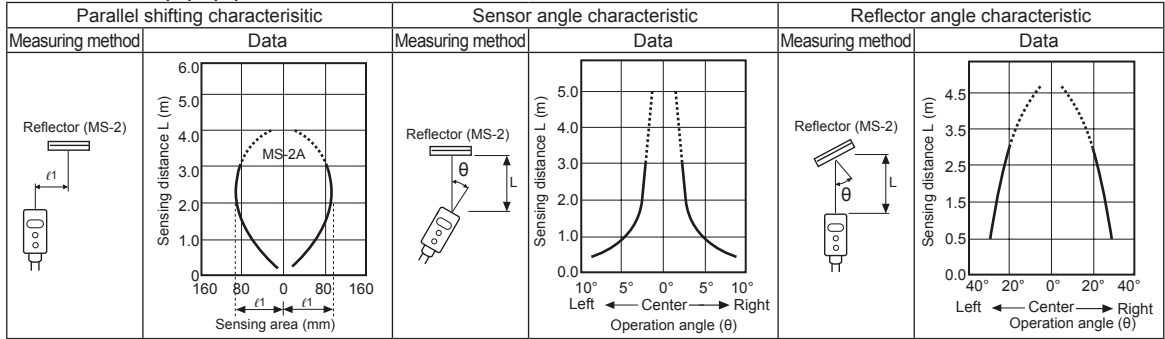

◎ Diffuse/Narrow beam reflective type

- BJ1M-DDT- (C)- (P)

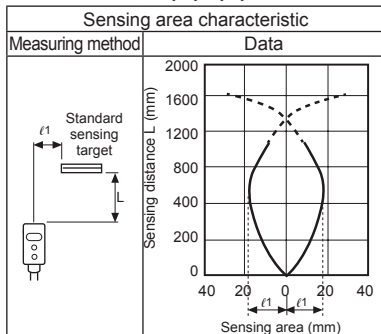

- BJ300-DDT- (C)- (P)

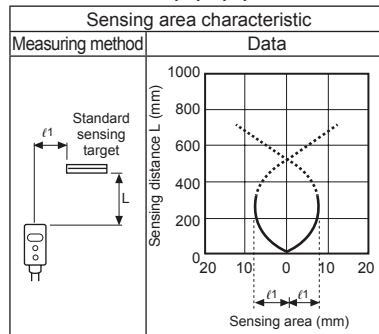

- BJ100-DDT- (C)- (P)

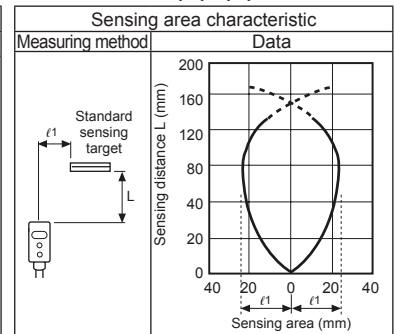

- BJJ30-DDT

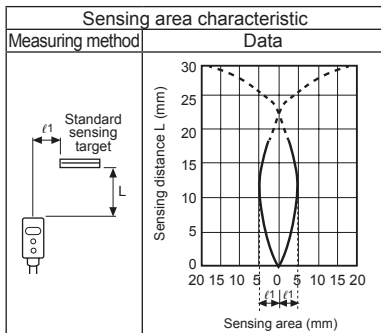

- BJN50-NDT- (P)

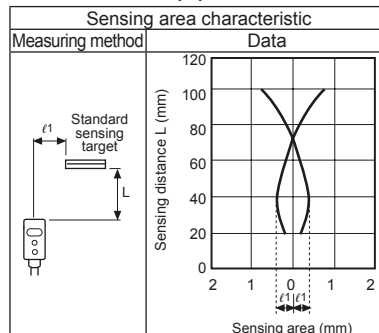

- BJN100-NDT- (P)

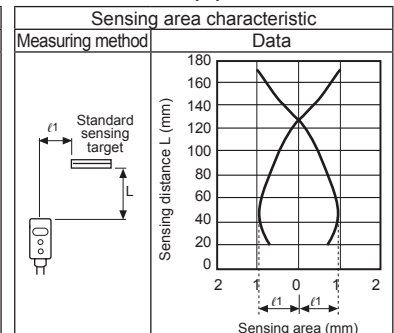

(A) Photoelectric Sensors

(B) Fiber Optic Sensors

(C) Door/Area Sensors

(D) Proximity Sensors

(E) Pressure Sensors

(F) Rotary Encoders

(G) Connectors/ Sockets

(H) Temperature Controllers

(I) SSRs / Power Controllers

(J) Counters

(K) Timers

(L) Panel Meters

(M) Tacho / Speed / Pulse Meters

(N) Display Units

(O) Sensor Controllers

(P) Switching Mode Power Supplies

(Q) Stepper Motors & Drivers & Controllers

(R) Graphic/ Logic Panels

(S) Field Network Devices

(T) Software

BJ Series

Feature Data

◎ BGS reflective type

● BJ30-BDT / BJ30-BDT-P

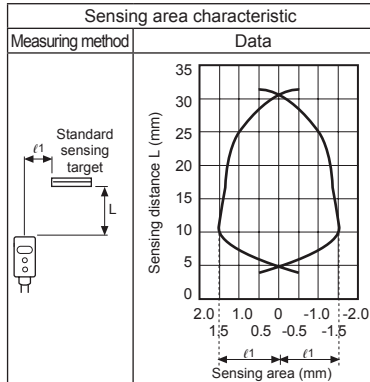

● BJ50-BDT / BJ50-BDT-P

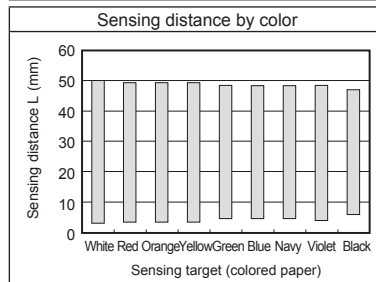
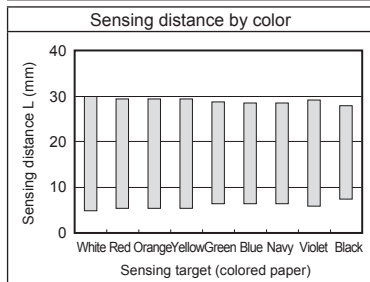
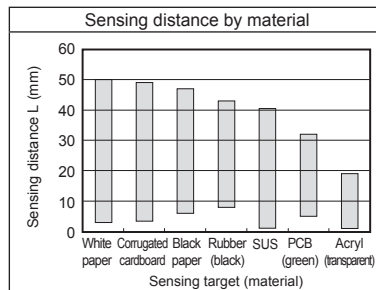
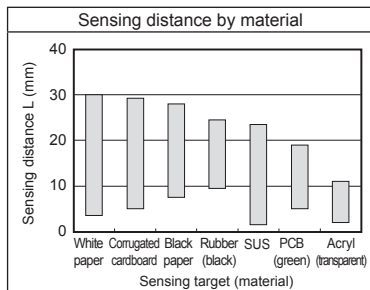
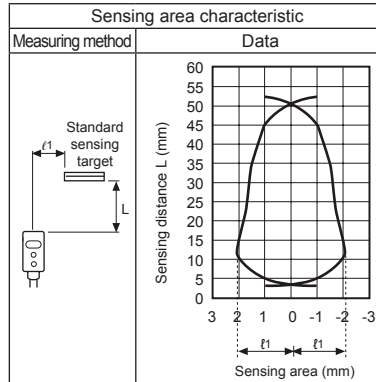

Connections

● Through-beam type

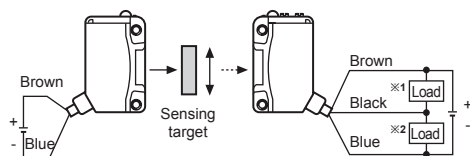

※1: Load connection for NPN output
 ※2: Load connection for PNP output

● Retroreflective type

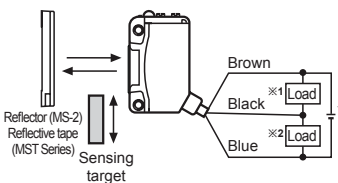

● Diffuse/Narrow beam/BGS reflective type

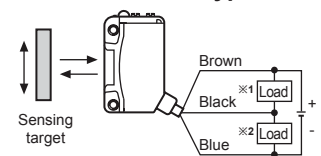

Connections For Connector Part

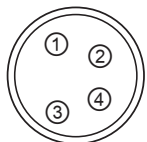

M8 Connector pin

Connector pin No.	Cable colors	Function
①	Brown	Power Source (+V)
②	White	—
③	Blue	Power Source (0V)
④	Black	Output

※Connector pin ② is N-C (Not Connected) terminal.

● Connector cable (sold separately)

※Connector cable model
 : CID408-□, CLD408-□
 ※Please refer to G-6 for connector cable.

Long Sensing Distance/BGS Reflective/Micro Spot Type

Control Output Diagram

• NPN open collector output

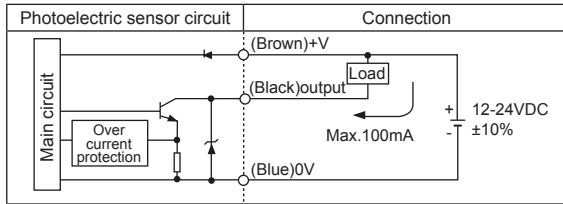

• PNP open collector output

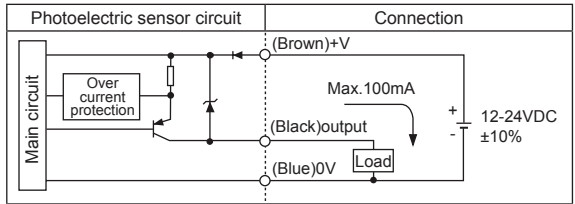

Operation Mode

Operation mode	Light ON		Dark ON	
Receiver operation	Received light		Received light	
	Interrupted light		Interrupted light	
Operation indicator (red LED)	ON		ON	
	OFF		OFF	
Transistor output	ON		ON	
	OFF		OFF	

Dimensions

(unit: mm)

• Through-beam type

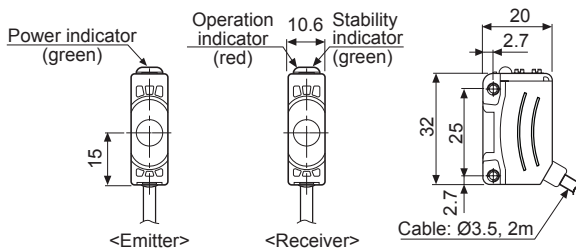

• Through-beam type (Connector type)

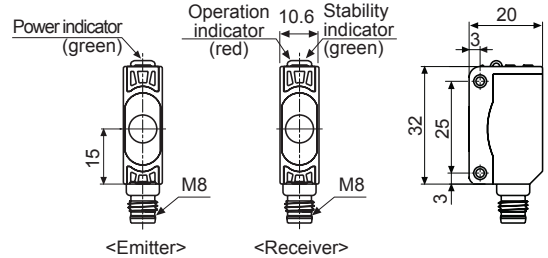

• Retroreflective type

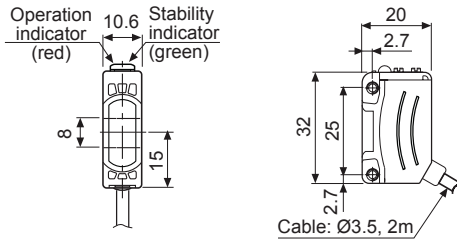

• Retroreflective type (Connector type)

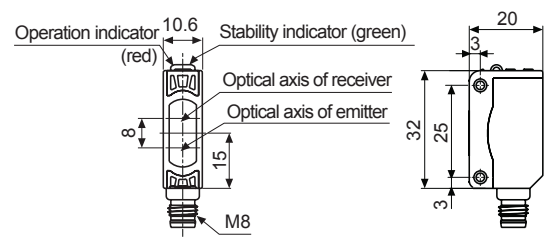

• Diffuse/Narrow beam/BGS reflective type - Connect the bracket A

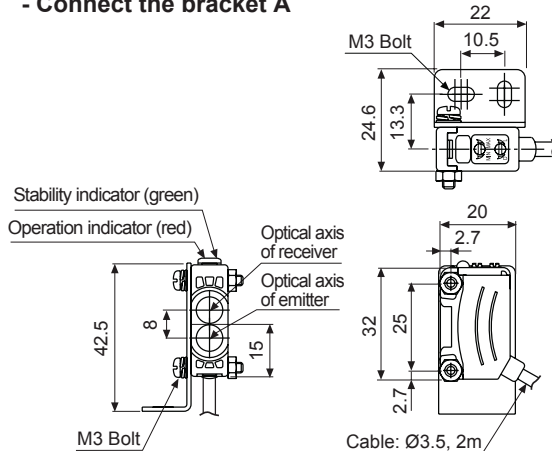

• Diffuse reflective type (Connector type) - Connect the bracket B

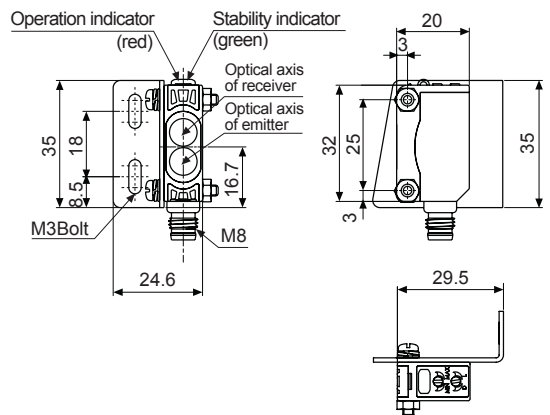

(A) Photoelectric Sensors

(B) Fiber Optic Sensors

(C) Door/Area Sensors

(D) Proximity Sensors

(E) Pressure Sensors

(F) Rotary Encoders

(G) Connectors/Sockets

(H) Temperature Controllers

(I) SSRs / Power Controllers

(J) Counters

(K) Timers

(L) Panel Meters

(M) Tacho / Speed / Pulse Meters

(N) Display Units

(O) Sensor Controllers

(P) Switching Mode Power Supplies

(Q) Stepper Motors & Drivers & Controllers

(R) Graphic/Logic Panels

(S) Field Network Devices

(T) Software

BJ Series

● Reflector

(accessory: MS-2A,
sold separately: MS-2S, MS-3S)

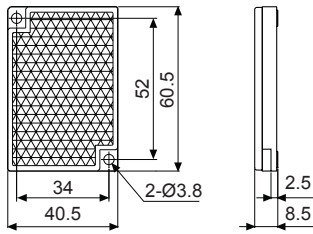

● Bracket A

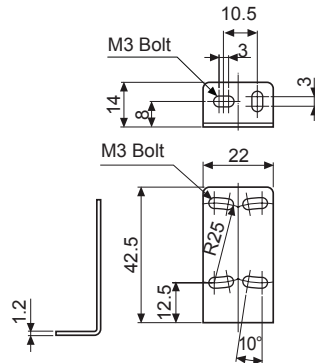

● Bracket B (sold separately)

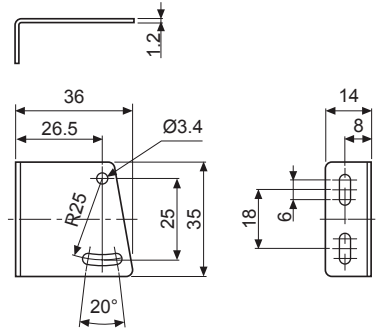

● Reflective tape (sold separately)

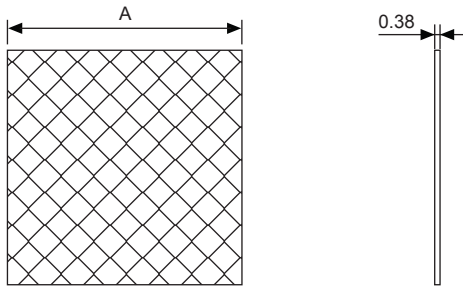

(unit: mm)

	A
MST-50-10	□50
MST-100-5	□100
MST-200-2	□200

■ Operation Timing Diagram

● Through-beam type

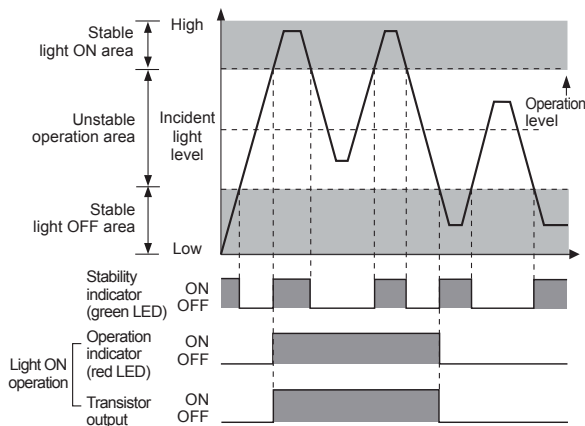

● Retroreflective/Diffuse/Narrow beam/ BGS reflective type

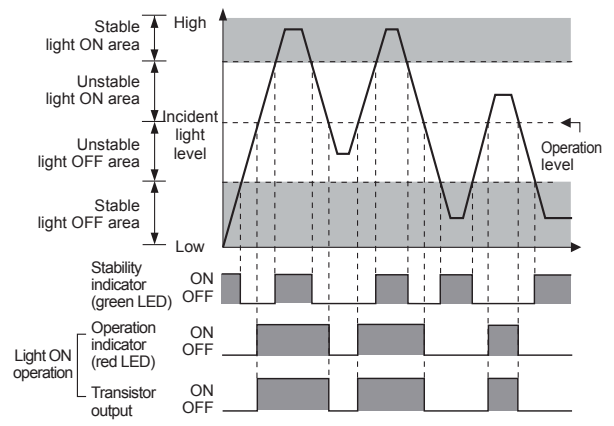

※The waveforms of "Operation indicator" and "Transistor output" are for Light ON operation.
They are opposite operation for Dark ON operation.

■ Mounting And Sensitivity Adjustment

◎ For mounting

Please use bolts M3 for
mounting of sensor,
set the tightening torque under 0.5N·m.

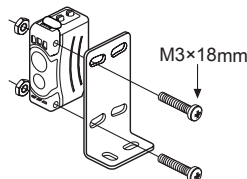

Long Sensing Distance/BGS Reflective/Micro Spot Type

☉ Switching of operation mode

Light ON operation		Turn the switching volume of operation mode to the end of right (L direction), it is set as Light ON.
Dark ON operation		Turn the switching volume of operation mode to the end of left (D direction), it is set as Dark ON.

※For through-beam type, the switching volume of operation mode is built-in the receiver.

☉ Optical axis adjustment

● Through-beam type

- Place the emitter and the receiver facing each other and supply the power.
- After adjusting the position of the emitter and the receiver and checking their stable indicating range, mount them in the middle of the range.
- After mounting this unit, check the operation of the sensor and lighting of the stability indicator in both status. (None or sensing target status)

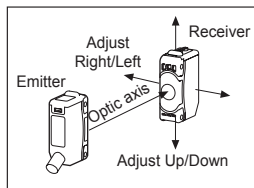

※When the sensing target is translucent or small (under sensing target of '■ Specifications'), it may not be detected by the sensor because the light can penetrate it.

● Retroreflective type

- Place the sensor and the reflector (or reflective tape) facing each other and supply the power.
 - After adjusting the position of the sensor and reflector (or reflective tape) and checking their stable indicating range, mount them in the middle of the range. (None or sensing target status)
 - After mounting this unit, check the operation of the sensor and in both status. (None or sensing target status)
- ※Please use reflective tape (MST Series) for where a reflector is not installed.

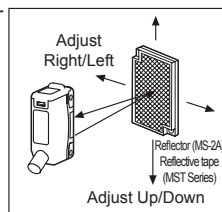

● Diffuse/Narrow beam/BGS reflective type

After placing a sensing target, adjust the sensor to up or down, right or left. Then, fix the sensor in the center of position where the stability is operating.

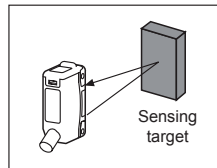

● Object (Copper wire) detection <Micro spot type>

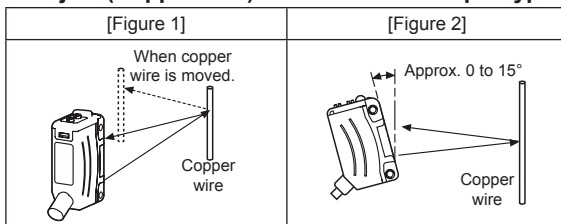

※Mount the sensor slanted at an angle ranged 0 to 15° shown above as [Figure 2] for stable detection to detect as shown in [Figure 1].

■ Sensitivity Adjustment

Order	Position	Description
1		Turn the adjustment VR to the right of min. and check position (A) where the operation indicator is turned ON in "Light ON status".
2		Turn the adjustment VR more to the right of position (A), check position (B) where the operation indicator is turned ON. And turn the adjustment VR to the left, check position (C) where the operation indicator is turned OFF in "Light OFF status". ※If the operation indicator is not turned ON although the adjustment VR is turned to the max. position, the max. position is (C).
3		Set the adjustment VR at the center of (A) and (C). To set the optimum sensitivity, check the operation and lighting of stability indicator with sensing target or without it. If the stability indicator is not turned ON, please check the sensing method again because sensitivity is unstable.

※No sensitivity adjustment function available for BJG30-DDT models.

	Light ON status	Light OFF status
Through-beam type		
Retro-reflective type		
Diffuse/Narrow beam/BGS reflective		

※Set the sensitivity to operate in stable light ON area and the reliability for the environment (temperature, voltage, dust etc) is increased. In unstable light ON area, be sure to check the variation of environment.

※Do not apply excessive force on the adjustment VR, it may be broken.

※Please use reflective tape (MST Series) for where a reflector is not installed.

■ Reflectivity By Reflective Tape Model

MST-50-10(50×50mm)	40%
MST-100-5(100×100mm)	60%
MST-200-2(200×200mm)	100%

※This reflectivity is based on the reflector (MS-2A).

※Reflectivity may vary depending on usage environment and installation conditions.

The sensing distance and minimum sensing target size increase as the size of the tape increases.

Please check the reflectivity before using reflective tapes.

※For using reflective tape, installation distance should be min. 20mm.

(A) Photoelectric Sensors

(B) Fiber Optic Sensors

(C) Door/Area

Sensors

(D) Proximity

Sensors

(E) Pressure

Sensors

(F) Rotary

Encoders

(G) Connectors/

Sockets

(H) Temperature

Controllers

(I) SSRs / Power

Controllers

(J) Counters

(K) Timers

(L) Panel

Meters

(M) Tacho /

Speed / Pulse

Meters

(N) Display

Units

(O) Sensor

Controllers

(P) Switching

Mode Power

Supplies

(Q) Stepper Motors

& Drivers

& Controllers

(R) Graphic/

Logic

Panels

(S) Field

Network

Devices

(T) Software