

## Door Side Sensor

### ■ Features

- Long sensing distance: 0 to 10m
- High ambient intensity of illumination:  
Max. 100,000lx of sunlight
- Easy to connect sensor head to controller
- Easy sensitivity setting  
(automatic sensitivity setting by one push method)
- Self-diagnosis function
- Compact Size (W77×L44×H24mm)

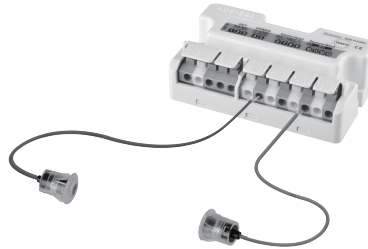

**⚠ Please read "Safety Considerations" in operation manual before using.**



### ■ Specifications

Model	ADS-SE1 (1-channel)	ADS-SE2 (2-channel)
Sensing type	Through-beam type	
Sensing distance	0 to 10m	
Power supply	12-24VAC ±10% 50/60Hz / 12-24VDC ±10% (ripple P-P: max. 10% )	
Power consumption/Current	AC: Max. 2VA, DC: Max. 50mA	
Control output	Contact composition	1c
	Contact capacity <sup>※1</sup>	50VDC 0.3A (resistive load)
	Relay life cycle	Mechanical- Min. 5,000,000 operations, Electrical- Min. 100,000 operations
Response time	Approx. 50ms (from light OFF)	
Output holding time	Approx. 500ms (from light ON)	
Available sensor set	1-channel	2-channel
Indicator	OUT1 indicator: Red LED, OUT2 indicator: Green LED (Refer to C-20 for the display status in operation)	
Light source	Infrared LED (850nm modulated)	
Vibration	1.5mm amplitude at frequency of 10 to 55Hz (for 1min) in each X, Y, Z direction for 2 hours	
Shock	500m/s <sup>2</sup> (approx. 50G) in each X, Y, Z direction for 3 times	
Environment	Ambient illumination	Sunlight: Max. 100,000lx (receiver illumination)
	Ambient temperature	-20 to 55°C, storage: -25 to 60°C
	Ambient humidity	35 to 85% RH, storage: 35 to 85% RH
Protection structure	IP30 (IEC standard)	
Sensor cable length	5m	
Sensor cable	Ø2.4mm, 1-wire, 5m (AWG26, core diameter: 0.16mm, number of cores: 7, insulator out diameter: Ø1.32mm)	
Material	Sensor - Holder: Acrylonitrile butadiene styrene, Lens: Polymethyl methacrylate, Lens guide: Polycarbonate, Nut: Polycarbonate Controller - Housing: Acrylonitrile butadiene styrene, Cover: Acrylonitrile butadiene styrene, Bolt: Steel chromium molybdenum (brass, Ni-plate)	
Accessory	Sensor 1set (ADS-SHP), Fixing bolt (M4×20) for controller: 2	
Approval	CE	
Weight <sup>※2</sup>	Approx. 450g (approx. 300g)	

※1: Do not use Load which is beyond the rated capacity of contact point of Relay.

It can cause bad insulation, contact fusion, bad contact, relay breakdown, and fire etc.

※2: The weight includes packaging. The weight in parenthesis is for unit only.

※Please purchase 1 set of sensor separately when mounting 2 sets of sensor.

※The mounting bracket of sensor (ADS-SB12, ADS-SB10) is sold separately.

※It is enable to purchase a controller (ADS-SEC1/2) separately.

※The temperature or humidity mentioned in Environment indicates a non freezing or condensation environment.

# Door Side Sensor

## Unit Description

### • Controller (ADS-SEC1/2)

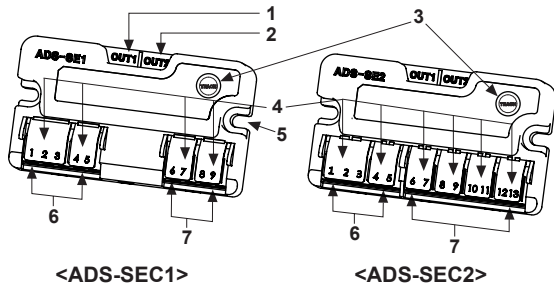

<ADS-SEC1>

<ADS-SEC2>

1. OUT1 indicator (red)
2. OUT2 indicator (green)
3. Sensitivity setting key (TEACH)
4. Wiring connection button
5. Mounting hole
6. Power and output connection terminal (1 to 5)
7. Emitter/Receiver sensor connector terminals
  - ADS-SEC1: 6 to 9
  - ADS-SEC2: 6 to 13

### • Sensor (ADS-SHP)

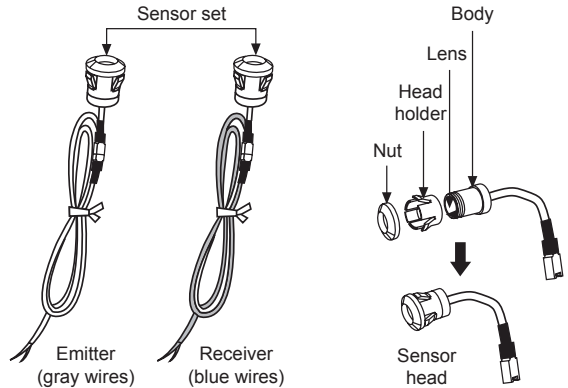

- ※To mount a sensor with a nut and a head holder, use the bracket for one push method.
- ※To mount a sensor without a nut and a head holder, use the bracket for screw method.
- ※ADS-SE2 is available to 2 sets of sensors at the same time. Additional 1 set of sensors is sold separately.

## Dimensions

(unit:mm)

### • Controller (ADS-SEC1/2)

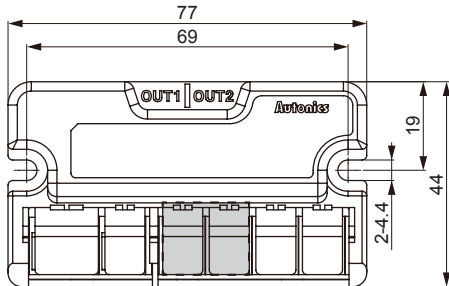

※ part is only for ADS-SEC2.

### • Mounting bracket (sold separately)

#### • One push type (ADS-SB12)

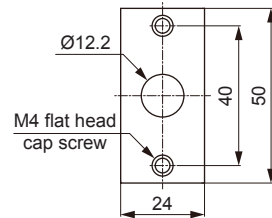

#### • Screw type (ADS-SB10)

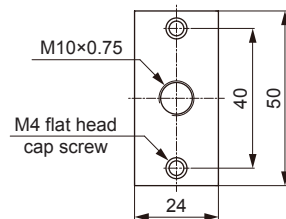

※Controller (ADS-SEC1/2), Sensor (ADS-SHP:5m) are sold separately.

### • Sensor (ADS-SHP)

#### • One push type

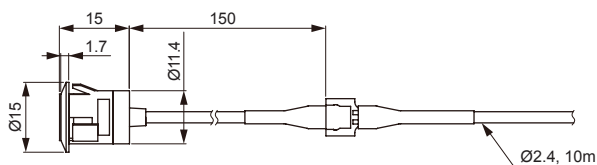

#### • Screw type

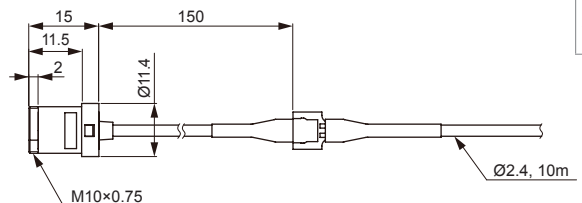

(A)	Photoelectric Sensors
(B)	Fiber Optic Sensors
(C)	Door/Area Sensors
(D)	Proximity Sensors
(E)	Pressure Sensors
(F)	Rotary Encoders
(G)	Connectors/ Connector Cables/ Sensor Distribution Boxes/ Sockets
(H)	Temperature Controllers
(I)	SSRs / Power Controllers
(J)	Counters
(K)	Timers
(L)	Panel Meters
(M)	Tacho / Speed / Pulse Meters
(N)	Display Units
(O)	Sensor Controllers
(P)	Switching Mode Power Supplies
(Q)	Stepper Motors & Drivers & Controllers
(R)	Graphic/ Logic Panels
(S)	Field Network Devices
(T)	Software

## ■ Installation

### ◎ Controller

#### 1. Follow as below when adjusting wiring length.

- Cut off the wiring length as much as user needs.
- Connect the wire to the terminal after taking off the wire covering. It is easy to connect if soldering the end of the wires.

※Be sure of connecting wires in power off.

※Follow the figure when cutting off the wires of sensor head. If the cover of wire is taken off too much, it may cause damage to this product as the end of both wires is shorted.

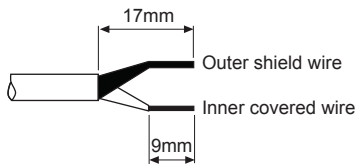

#### 2. Match wires in the number of terminals and connect them.

- Do not connect extended wire to the wire of sensor head. It may cause malfunction by noise.
- Do not connect two wires or more to a terminal.

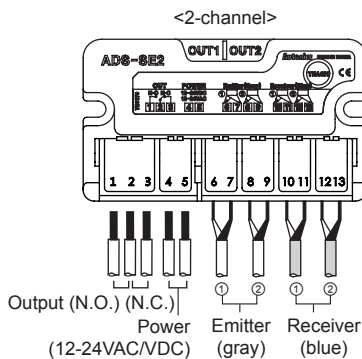
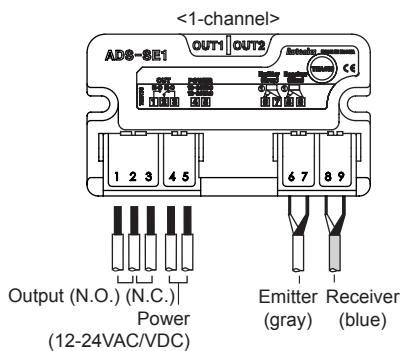

#### ● Connection method for power and output wires

- Press a connecting button and wiring it.
- It does not operate normally if the wiring is connected conversely.
- Make sure of connecting power wire to the terminal 4, and 5. Otherwise, It may cause damage to this product.
- Allowable diameter of power and output wires  
-Single and Stranded wire: 0.2 to 1.5 mm<sup>2</sup>

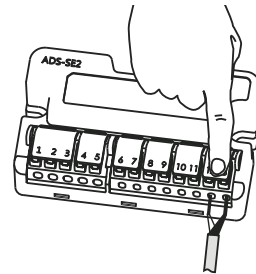

#### ⚠ Caution for installing controller

- Fix a controller with 2 fixing bolts.
- Process the fixing holes of a controller by M4. Refer to "■ Dimension" for the position of holes.
- Do not tighten bolts to fix a controller. The fixing holes of controller may be broken.

### ◎ Sensor

#### 1. Make a hole on the side post of auto door as follows.

##### ● When not using the mounting bracket

- ① One push method
  - Mounting hole for sensor head:  $\varnothing 12.2^{+0.1}$  mm
  - Panel thickness for sensor head:  $1.5^{+0.5}$  mm
- ② Screw method
  - Mounting hole for sensor head: M10×0.75mm
  - Panel thickness for sensor head:  $1.5^{+0.5}$  mm

##### ● When using the mounting bracket

- ① One push method
  - Through hole for sensor head:  $\varnothing 13$  to 14mm
  - Fixing screw hole for bracket: M4 Tap or  $\varnothing 3.5$ mm
- ② Screw method
  - Through hole for sensor head:  $\varnothing 13$  to 14mm
  - Fixing screw hole for bracket: M4 Tap or  $\varnothing 3.5$ mm

※Check the mounting holes for the head of emitter and receiver are in parallel for the optical axes.

※Grind around the mounting holes drilled smoothly. It may hurt by sharp parts and cause malfunction by the inclined sensor head.

# Door Side Sensor

## 2. Mount sensor heads to the mounting holes.

### • When not using the bracket

- ① One push method
  - Put the sensor head into the mounting hole as the figure.
  - ※Check the nuts are fixed on the sensor body tightly.
  - ※Install the sensor with no gap between the nut and the side of the door (or panel).
- ② Screw method
  - Put the sensor head to the mounting hole.
  - ※Install the sensor with no gap between the panel and the sensor.

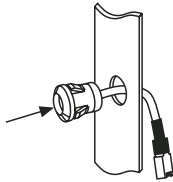

### • When using the bracket

- ① One push method
  - Put the sensor head to the bracket.
  - Fix the bracket to the desired place by screws.
  - ※Check the nut is fixed to the sensor body tightly.
  - ※Install the sensor with no gap between the nut and the side of the door (or bracket).

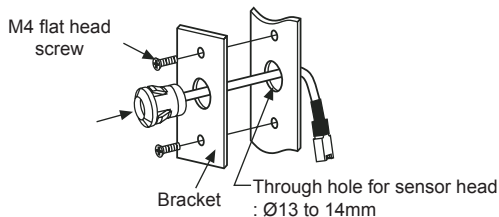

### ② Screw method

- Remove the nut and head holder from the sensor head.
- Install the sensor head to the bracket.
- Fix the bracket on the side post of the door by screws.
- ※It may cause malfunction because sensitivity setting is not available as the optical axes are not matched if sensor body is inclined.
- ※Check the damage such as scratches or pollutant on the lens of the sensor head. It may cause malfunction in the condition of interrupted light or lack of sensitivity by dust.

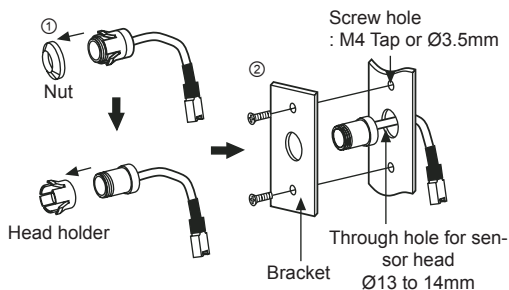

### ⚠ Caution for sensor installation

- The rated sensing distance is 10m (A). Install the sensors within the rated sensing distance.
- Install the sensor with more than 50cm (B) gap from the bottom and ceiling. It may cause malfunction by reflected beams from the surface of the bottom and ceiling.
- Do not put obstacles between Emitter and Receiver, or it may cause malfunction.
- This product is for indoor. Avoid the place where exposed in direct sunlight or it is in over rated intensity of illumination.

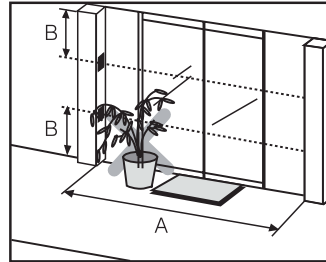

## ■ Sensitivity Setting

### ⊙ Sensitivity setting

Sensitivity setting is required when a user installs this unit at first or there is malfunction due to lack of sensitivity. Depending on the sensing distance, the controller automatically sets the optimum sensitivity for the best operation.

### ⊙ Order of Sensitivity setting

Sensitivity setting key adjustment	Indicator	Status
Press sensitivity setting key	Red/Green indicators flashe in turn	Ready sensitivity setting
After 1 sec during pressing sensitivity setting key	Red/Green indicators turn OFF	Starts sensitivity setting
	Red/Green indicators flashes	Completes sensitivity setting
Completes sensitivity setting	Indicates operation status	

※When pressing the sensitivity setting key below 1 sec, the sensitivity setting is canceled and it operates as the latest setting. If sensitivity is not enough or the setting is not correct, this unit may have malfunction.

### • Check the followings when sensitivity setting is failed.

- ① Check there are obstacles between Emitter/Receiver heads.
- ② Check there is dirt on the head lens of Emitter/Receiver.
- ③ Check the wires are disconnected or connected properly as the label (connection diagram).
- ④ Check the heads of Emitter/Receiver are inclined.
- ⑤ Check the above items and resolve the problems and set the sensitivity again.

(A)	Photoelectric Sensors
(B)	Fiber Optic Sensors
(C)	Door/Area Sensors
(D)	Proximity Sensors
(E)	Pressure Sensors
(F)	Rotary Encoders
(G)	Connectors/ Connector Cables/ Sensor Distribution Boxes/ Sockets
(H)	Temperature Controllers
(I)	SSRs / Power Controllers
(J)	Counters
(K)	Timers
(L)	Panel Meters
(M)	Tacho / Speed / Pulse Meters
(N)	Display Units
(O)	Sensor Controllers
(P)	Switching Mode Power Supplies
(Q)	Stepper Motors & Drivers & Controllers
(R)	Graphic/ Logic Panels
(S)	Field Network Devices
(T)	Software

# ADS-SE1/2

## Indicator

☀: ON, ◐: Flash, ●: OFF

Connected sensor	Indicator		Status	
	OUT1 (red)	OUT2 (green)	After setting sensitivity	In operation
1-channel (ADS-SE1/2)	☀	●	Sensitivity setting success	Received light
	◐	◐	Sensitivity setting failure	Emitter disconnection or sensor cable extension
	◐	●	—	Lack of sensitivity
	●	●	—	Interrupted light
2-channel (ADS-SE2)	☀	☀	1, 2-channel sensitivity setting success	1, 2-channel received light
	☀	◐	1-channel sensitivity setting success, 2-channel sensitivity setting failure	2-channel lack of sensitivity
	☀	●	—	1-channel received light, 2-channel interrupted light
	◐	☀	1-channel sensitivity setting failure, 2-channel sensitivity setting success	1-channel lack of sensitivity
	●	☀	—	1-channel interrupted light, 2-channel received light
	◐	◐	1, 2-channel sensitivity setting failure	1, 2-channel lack of sensitivity or emitter disconnection
	●	●	—	1, 2-channel interrupted light



※For ADS-SE2, OUT1 indicator (red) is for Receiver status set sensitivity by Emitter of 1-channel and OUT2 indicator (green) is for Receiver status set sensitivity by Emitter of 2-channel.

※If lack of sensitivity occurs by not-matched optical axes or pollution on the lens of emitter/receiver during self diagnostic function, for ADS-SE1, the OUT1 indicator (red) turns ON. For ADS-SE2, the OUT indicator of the channel lack of received light turns ON.

## Operation Check

Please check the operation flow chart below.

☀: ON, ●: OFF

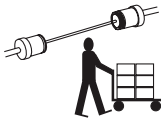
Operation							
Power OFF							
Status		<ul style="list-style-type: none"> <li>Normal operation</li> <li>No human or any material between sensors</li> </ul>		Human or material is passing between sensors (when cutting off the transmitted beam)		After human or material is passed	
Indicator (OUT1 red/OUT2 green)		●	☀	●	☀		
Relay output status	N.O.	OPEN	OPEN	CLOSE	OPEN		
	N.C.	CLOSE	CLOSE	OPEN	CLOSE		

## Troubleshooting

Malfunction	Cause	Troubleshooting
It does not work.	Power voltage	Check the power cable and adjust power voltage.
	Cable disconnection, incorrect connection	Please check wiring and terminal.
	Rated sensing distance	Use it in rated sensing distance.
Sometimes it does not work.	Pollution by pollutant on the lens of Emitter Receiver.	Remove the pollutant.
It is operated even if people does not enter in sensing area.	Rated sensing distance	Use it in rated sensing distance.
	There are obstacles between Emitter and Receiver.	Remove obstacles.
	There is equipment generating strong noise or ratio wave (Motor, Generator, High-tension wire).	Keep away from the equipment generating strong noise or ratio wave.

## ■ Caution for Using

1. Follow instructions in 'Caution for Using'.  
Otherwise, It may cause unexpected accidents.
2. 12-24VDC, 12-24VAC power supply should be insulated and limited voltage/current or Class 2, SELV power supply device.
3. Use the product, 1 sec after supplying power.  
When using separate power supply for the sensor and load, supply power to sensor first.
4. When using switching mode power supply to supply the power, ground F.G. terminal and connect a condenser between 0V and F.G. terminal to remove noise.
5. When connecting a DC relay or other inductive load, remove surge by using diodes or varistors.
6. Wire as short as possible and keep away from high voltage lines or power lines, to prevent surge and inductive noise.
7. This unit may be used in the following environments.
  - ①Indoors (in the environment condition rated in 'Specifications')
  - ②Altitude max. 2,000m
  - ③Pollution degree 3
  - ④Installation category II

(A)  
Photoelectric  
Sensors

(B)  
Fiber  
Optic  
Sensors

(C)  
Door/Area  
Sensors

(D)  
Proximity  
Sensors

(E)  
Pressure  
Sensors

(F)  
Rotary  
Encoders

(G)  
Connectors/  
Connector Cables/  
Sensor Distribution  
Boxes/ Sockets

(H)  
Temperature  
Controllers

(I)  
SSRs / Power  
Controllers

(J)  
Counters

(K)  
Timers

(L)  
Panel  
Meters

(M)  
Tacho /  
Speed / Pulse  
Meters

(N)  
Display  
Units

(O)  
Sensor  
Controllers

(P)  
Switching  
Mode Power  
Supplies

(Q)  
Stepper Motors  
& Drivers  
& Controllers

(R)  
Graphic/  
Logic  
Panels

(S)  
Field  
Network  
Devices

(T)  
Software