



OPERATION AND SERVICE MANUAL

HypotMAX®

**MODEL 7705 (10 kV AC ONLY HIPOT)
MODEL 7710 (12 kV DC ONLY HIPOT)
MODEL 7715 (20 kV AC ONLY HIPOT)
MODEL 7720 (20 kV DC ONLY HIPOT)**

SERIAL NUMBER

--	--	--	--	--	--	--

Model 7705,7710,7715,7720

Item 38672, Ver 3.17

Printed January 4th, 2021



Associated Research

28105 North Keith Dr. - Lake Forest, IL 60045 USA

T. 1-847-367-4077 F. 1-847-367-4080

info@arisafety.com www.arisafety.com



DECLARATION OF CONFORMITY

Manufacturer: Associated Research, Inc.
Address: 28105 North Keith Dr.
Lake Forest, IL 60045
USA
Product Name: 7705/7710/7715/7720 Electrical Safety
Compliance Analyzer
Model Number: 7705/7710/7715/7720

Conforms to the following Standards:

Safety: UL 61010-1:2012
CAN/CSA-C22.2 NO. 61010-1-12
EN 61010-1:2010, EN 61010-2-030:2010
EN 61010-031:2002+A1
IEC 61010-1:2010, IEC 61010-2-030:2010
IEC 61010-31:2002+A1

EMC: EN 61326-1:2013
EN 55011:2009/A1

Supplementary Information

*The product herewith complies with the requirements of the **Low Voltage Directive 2014/35/EU**, the **EMC Directive 2014/30/EU** and the **RoHS Directive 2011/65/EU** with respect to the following substances: Lead (Pb), Mercury (Hg), Cadmium (Cd), Hexavalent chromium (Cr (VI)), Polybrominated biphenyls (PBB), Polybrominated diphenyl ethers (PBDE), Deca-BDE included.*

Last two digits of the year the CE mark was first affixed: 05

The technical file and other documentation are on file with Associated Research, Inc.

Joseph Guerriero, President
Associated Research, Inc.
Lake Forest, Illinois USA
July 20, 2017

TABLE OF CONTENTS

1. INTRODUCTION	1
1.1. Warranty.....	1
1.2. Safety Symbols	2
1.2.1. Product Marking Symbols	2
1.2.2. Caution and Warning Symbols.....	2
1.3. Glossary of Terms.....	2
1.4. Safety	4
1.4.1. Service and Maintenance.....	4
1.4.2. Test Station	5
1.4.3. Test Operator	6
1.5. Key Features and Benefits	8
2. GETTING STARTED	9
2.1. Unpacking and Inspection	9
2.1.1. Packaging	9
2.1.2. Contents of Carton	9
2.2. Installation	11
2.2.1. Work Area	11
2.2.2. Power Requirements.....	11
2.2.3. Basic Connections	12
2.2.4. Environmental Conditions	12
3. SPECIFICATIONS AND CONTROLS	14
3.1. 7705 Functional Specifications.....	14
3.2. 7710 Functional Specifications.....	15
3.3. 7715 Functional Specifications.....	16
3.4. 7720 Functional Specifications.....	17
3.5. General Specifications	19
3.6. Instrument Controls.....	20
3.6.1. Front Panel Controls	20
3.6.2. Rear Panel Controls.....	21
4. PROGRAMMING INSTRUCTIONS	23
4.1. Power Up	23
4.2. System Parameter Settings.....	23
4.2.1. PLC Remote	23
4.2.2. Fail Stop.....	24
4.2.3. LCD Contrast	25
4.2.4. Alarm Volume.....	25
4.2.5. Smart GFI	25
4.2.6. GPIB Address	26
4.2.7. BUS Remote Command Set	27

4.2.8. Memory Lock.....	27
4.2.9. Default System Parameters	28
4.2.10. Default System Parameter Initialization	28
4.3. LOCK/LOCAL Key	28
4.3.1. Lock Function.....	28
4.3.2. Local Function.....	29
4.4. Password Setting	29
4.5. Test Setup.....	30
4.5.1. Memory Configuration.....	30
4.5.2. Test Parameters.....	30
4.5.3. Default Test Parameters	32
4.6. Setting Up a Test	32
4.6.1. Output Voltage setting.....	33
4.6.2. HI-Limit Current setting	33
4.6.3. LO-Limit Current setting	33
4.6.4. Ramp UP Time setting	34
4.6.5. Dwell Unit setting	34
4.6.6. Dwell Time setting.....	34
4.6.7. Ramp Down Time setting.....	35
4.6.8. Frequency Selection (AC units only)	35
4.6.9. Arc Detect and Arc Sensitivity Selection	35
4.6.10. Ramp-HI selection (DC units only)	36
4.6.11. Charge-LO setting (DC units only)	37
4.6.12. Connect.....	38
5. OPERATING INSTRUCTIONS.....	39
5.1. Instrument Connections	39
5.2. Settings Screen.....	40
5.3. Performing a Test.....	40
5.3.1. Discharge Function in DC units.....	40
5.3.2. Connected Memory Indicator	41
5.3.3. Manual Voltage Adjustment	41
5.4. Reviewing Test Results.....	42
5.5. Test Messages.....	42
5.6. Additional Messages for DC units	45
5.7. BUS Remote message.....	46
5.8. Fatal Error	46
5.9. Output Error	47
6. CONNECTION OF REMOTE I/O.....	48
6.1. Signal Outputs on Remote I/O	48
6.2. Signal Inputs of Remote I/O and Memory Access.....	49
7. BUS REMOTE INTERFACE USB / RS-232 / GPIB	52
7.1. USB / RS-232 Interface.....	52
7.1.1. RS-232 Connector	52

7.1.2. Communications Port Configuration.....	52
7.1.3. Sending and Receiving Commands.....	53
7.2. GPIB Interface.....	53
7.2.1. GPIB Connector.....	53
7.2.2. GPIB Address.....	54
7.3. Interface Functions.....	54
7.4. USB / RS-232 / GPIB Interface Command List	55
7.4.1. Rules for Sending Commands to the Instrument.....	55
7.4.2. Test Execution Commands.....	55
7.4.3. File Editing Commands.....	56
7.4.4. Test Parameter Editing Commands and Companion Queries.....	57
7.4.5. System Parameter Editing Commands and Companion Queries.....	58
7.4.6. Query Commands.....	59
7.4.7. IEEE 488.2 Common Commands.....	60
7.4.8. Status Reporting.....	62
7.4.9. GPIB Service Request.....	63
7.5. Example of Communicating Over the GPIB Bus.....	64
7.6. Non Volatile Memory.....	64
7.7. BUS Remote message.....	64
8. OPTIONS.....	65
9. CALIBRATION.....	68
9.1. Warranty Requirements.....	68
9.2. Calibration Initialization.....	69
9.3. Calibration Procedure.....	69
9.3.1. Calibration of Hipot Voltage.....	69
9.3.2. Calibration of 7705 AC Hipot Current.....	70
9.3.3. Calibration of 7715 AC Hipot Current.....	72
9.3.4. Calibration of 7710 DC Hipot Current.....	73
9.3.5. Calibration of 7720 DC Hipot Current.....	75
9.3.6. Calibration Complete Message.....	78
10. REPLACEMENT PARTS LIST.....	79

Index is located at the back of the manual.

1. INTRODUCTION

1.1. Warranty Policies

Ikonix USA, certifies that the tester listed in this manual meets or exceeds published manufacturing specifications. This tester was calibrated using standards that are traceable to the National Institute of Standards and Technology (NIST).

Your new tester is warranted to be free from defects in workmanship and material for a period of (5) years from date of shipment. We aim to provide an amazing experience and quality testers that last a long time. If you're not satisfied with your tester, return it within 45 days for a full refund. Calibrate annually with us, or one of our authorized partners, and we'll extend your warranty an additional year for the service life of your tester, and at least five years after discontinuation. If it breaks during that time, we promise to fix it for free (unless abuse or excessive damage is present). When your tester reaches the end of its service life, we'll responsibly recycle it and give you a discount on a replacement. Annual calibration and inspection must be made in each successive year starting one year after the original purchase date in order to remain eligible for extended warranty coverage beyond the standard warranty period (five years).

Ikonix USA recommends that your tester be calibrated on a twelve-month cycle. A return material authorization (RMA) must be obtained from Ikonix USA. To obtain an RMA please contact our Customer Support team at 1-847-367-4077 or visit arisafety.com. Damages sustained as a result of improper packaging will not be honored. Transportation costs for the return of the tester for warranty service must be prepaid by the customer. Ikonix USA will assume the return freight costs when returning the tester to the customer. The return method will be at the discretion of Ikonix USA.

Except as provided, herein Ikonix USA makes no warranties to the purchaser of this tester and all other warranties, expressed or implied (including, without limitation, merchantability or fitness for a particular purpose), are hereby excluded, disclaimed and waived.

Any non-authorized modifications, tampering or physical damage will void your warranty. Elimination of any connections in the earth grounding system or bypassing any safety systems will void this warranty. This warranty does not cover accessories not of Ikonix USA manufacture. Parts used must be parts that are recommended by Ikonix USA as an acceptable specified part. Use of non-authorized parts in the repair of this tester will void the warranty.

*5 year warranty is valid on any model purchased in 2021 or after.

****This Page Intentionally Left Blank****

1.2. Safety Symbols

1.2.1. Product Marking Symbols



Product will be marked with this symbol when it is necessary to refer to the operation and service manual in order to prevent injury or equipment damage.



Product will be marked with this symbol when hazardous voltages may be present.



Product will be marked with this symbol at connections that require earth grounding.

1.2.2. Caution and Warning Symbols



Calls attention to a procedure, practice, or condition that could possibly cause bodily injury or death.



Calls attention to a procedure, practice, or condition that could possibly cause damage to equipment or permanent loss of data.

1.3. Glossary of Terms

(As used in this manual)

Alternating Current, AC: Current that reverses direction on a regular basis. Utility power is usually generated in the form of a sinusoid at a frequency of 60 times per second in the United States and 50 times per second in other countries.

Arc: A partial momentary breakdown due to the force of a strong electric field on closely spaced conductors, sometimes evidenced by corona or a luminous flashover.

Breakdown: The failure of insulation to effectively prevent the flow of current. If the test voltage is gradually raised, breakdown will begin suddenly at a certain voltage level and current flow will not be directly proportional to voltage. Once a breakdown occurs, especially for a period of time, the next gradual application of voltage will often cause a breakdown to begin at a lower voltage.

Conductor: A solid or liquid material which permits the flow of electrons. A material which has a volume resistivity of no more than $10^3 \Omega\text{-cm}$.

Current: The movement of electrons through a conductor. Current is measured in amperes (A), milliamperes (mA), microamperes (uA). Symbol = I

Dielectric: An insulating material that is positioned between two conductive materials in such a way that a charge or voltage may appear across the two conductive materials.

Direct Current, DC: Current that flows in one direction only. The source of direct current is said to be polarized and has one terminal that is always at a higher potential than the other.

Frequency: The number of cycles an AC waveform repeats over time. Usually given in Hertz (Hz).

Ground: Refers to the point of low potential in a circuit to which all other voltages are referenced. May or may not be tied to the earth. Also referred to as Earth.

Hot: Used to refer to the test lead or output side of an instrument that is at high potential.

Impedance: The property of capacitive or inductive items to limit certain frequencies.

Insulation: Gas, liquid or solid material which has a volume resistivity of at least 10^{12} Ω -cm and is used for the purpose of restricting current flow between conductors.

Leakage: AC or DC current flow through insulation and over its surfaces. Current flow is directly proportional to voltage. The insulation is thought of as a constant impedance unless breakdown occurs.

Neutral: The point of low potential in a circuit to which all other voltages are referenced. Also known as Common.

Peak Current: The maximum amplitude of an AC current waveform. For a sinusoid, 1.414 x the RMS value.

Power: The amount of work performed by an energy source over time, given in Watts (W).

PF (Power factor): Power Factor = W/VA where W =Watts (Real Power) and VA =Volts x Amps (apparent power). It is important to note that the closer the power factor is to "1" the more resistive the DUT is. The closer the power factor is to 0 the more reactive (inductive or capacitive) the DUT is.

Reactive Current: The current component due to the reactive impedance of a load. Also called imaginary current.

Real Current: The current component due to the resistance of a load.

Resistance: The property of a substance that impedes current and results in the dissipation of power in the form of heat. The practical unit of resistance is the *ohm* (Ω). Symbol = **R**

Return: The path by which current returns to a source.

RMS: The Root Mean Squared value of a voltage or current waveform. An RMS waveform delivers the same amount of energy to a load as a DC waveform of the same value. For a sinusoid, the RMS value is .707 x the peak value.

Total Current: The vector sum of the real current component and the reactive current component produced by an applied voltage.

VA: A rating of instantaneous power found by multiplying an instrument's maximum output current by its maximum output voltage.

Voltage: The force which causes current through an electrical conductor, given in volts (V). Symbol = V

1.4. Safety

This product and its related documentation must be reviewed for familiarization with safety markings and instructions before operation.

This product is a Safety Class I instrument (provided with a protective earth terminal). Before applying power verify that the instrument is set to the correct line voltage (115 or 230) and the correct fuse is installed.

This product carries an NRTL (Nationally Recognized Testing Laboratory) and comes equipped with an audible and visual failure indicator.

WARNING
<p>HypotMAX produces voltages and currents that can cause harmful or fatal electric shock. To prevent accidental injury or death, these safety procedures must be strictly observed when handling and using the test instrument.</p>

1.4.1. Service and Maintenance

User Service

To prevent electric shock do not remove the instrument cover. There are no internal user serviceable parts. Routine maintenance or cleaning of internal parts is not necessary. Avoid the use of cleaning agents or chemicals on the instrument, as some chemicals may damage plastic parts or lettering. Any external cleaning should be done with a clean, dry or slightly damp cloth. Schematics, when provided, are for reference only. Refer servicing and certification to an Associated Research, Inc. authorized service center.

SAFETY
<p>This instrument meets UL requirements for audible and visual failure indication.</p>

<p>ASSOCIATED RESEARCH, INC. 13860 WEST LAUREL DRIVE LAKE FOREST, IL 60045-4546 U.S.A.</p>	<p>☎PHONE: 1 (847) 367-4077 1 (800) 858-TEST (8378) FAX: 1 (847) 367-4080 E-MAIL: info@asresearch.com</p>
--	---

Service Interval

Associated Research, Inc. will not be held liable for injuries suffered if the instrument is not properly maintained and safety checked annually. See section **1.1. Warranty Policies** for more information.

1.4.2. Test Station

Location

Select an area away from the mainstream of activity where employees do not walk while performing their normal duties. If this is not practical because of production line flow, then the area should be roped off and marked for **HIGH VOLTAGE TESTING**. No employees other than test operators should be allowed inside.

If benches are placed back-to-back, be especially careful about the use of the bench opposite the test station. Signs should be posted: **“DANGER – HIGH VOLTAGE TEST IN PROGRESS – UNAUTHORIZED PERSONNEL KEEP AWAY.”**

Work Area

When possible, use the instrument on a non-conducting table or workbench. If you cannot avoid using a conductive surface, be certain that it is connected to a good earth ground and the high voltage connection is insulated from the grounded surface.

There should not be any metal in the work area between the operator and the location where products being tested will be positioned. Any other metal in the work area should be connected to a good ground, never left “floating”.

Keep the area clean and uncluttered. All test equipment and unnecessary test leads should be removed from the test bench and put away. It should be apparent to both the operator and to any observers which product is under test, which product is waiting to be tested and which product has already been tested.

Power

Power to the test station should be arranged so that it can be shut off by one prominently marked switch located at the entrance to the test area. In case of an emergency, anyone should be able to cut off the power before entering the test area to offer assistance.

More Information

For more information on setting up a safe work station, please visit the Events and Training section of our website at <http://www.asresearch.com/events-training/Default.aspx>

ESD TESTING

Electrical safety tests should not be performed in or around ESD testing areas. ESD methods should not be employed during electrical safety testing, as this could cause a hazardous condition for equipment and test operators.

1.4.3. Test Operator

WARNING

This instrument generates voltages and currents that can cause **harmful or fatal electric shock** and must only be operated by a skilled worker trained in its use. **The operator should understand the electrical fundamentals of voltage, current, and resistance.**

WARNING

Do not touch the device under test, high voltage test lead, alligator clip, or clip insulator once the test has been started.

WARNING

Do not touch the front panel when testing or after a malfunction has occurred.

Rules

Operators should be thoroughly trained to follow all national safety standard guidelines for electrical safety testing in the workplace. Defeating any safety system should be considered a serious offense with severe penalties. Allowing unauthorized personnel in the area during a test should also be dealt with as a serious offense. Test operators should be familiar with methods to properly discharge a device under test in case test leads become disconnected during testing.

Refer to the following standards for more information:

- NFPA 70E
- OSHA 1910 subpart (S)
- EN50191

Dress

Operators should not wear jewelry that could accidentally complete a circuit.

WARNING

ESD protocols should not be observed while

performing electrical safety tests. Intentionally grounding the test operator could lead to a **harmful or fatal electric shock**.

Medical Restrictions

Personnel with heart ailments or devices such as pacemakers should be informed that the voltages and currents

KEY SAFETY POINTS TO REMEMBER

- Keep unqualified and unauthorized personnel away from the test area.
- Arrange the test station in a safe and orderly manner.
- In case of any problem, turn off the high voltage first.

generated by the instrument are very dangerous. If contacted, the instrument may cause heart-related problems. Please have the test operator consult a physician for recommendations.

1.5. Key Features and Benefits of the HypotMAX

PATENTED SMARTGFI®	SmartGFI™ disables the instrument's output voltage in less than 1 millisecond if excessive leakage to ground is detected. If enabled, SmartGFI™ automatically detects if the DUT is floating or grounding and turns ON or OFF accordingly.
STORAGE OF UP TO 50 SETUPS	A real benefit for manufacturers that test different products. The instrument can store 50 individual memories that may be performed individually or connected for a 50-step test.
DIGITALLY CONTROLLED ARC DETECTION SYSTEM	Allows the operator to choose whether low-level arcs should be detected. The operator can select from multiple sensitivity levels.
TAMPER PROOF FRONT PANEL CONTROLS	Limit user access to the setup screens so that only authorized personnel with a security code can change test parameters.
PLC REMOTE INPUTS AND OUTPUTS	Two standard 9 pin interfaces provide outputs for PASS, FAIL, RESET and TEST IN PROCESS signals. Inputs include TEST, INTERLOCK, RESET and remote recall of MEMORIES 1 - 3. Provides the user with the ability to operate the HypotMAX through simple PLC relay control.
SOFTWARE CALIBRATION CONTROL	HypotMAX is calibrated through the front panel keypad. All calibration information is stored in non-volatile memory. This allows HypotMAX to be completely calibrated without removing any covers and exposing the technician to hazardous voltages.
LOW-CURRENT SENSE	Monitors the minimum level of current flow, thus ensuring that the DUT is properly connected and that the Hipot test is being performed.
ELECTRONIC RAMPING (UP & DOWN)	Provides a gradual and timed method to increase or decrease output voltage to the DUT minimizing any damage from quick high voltage changes to sensitive DUTs.

2. GETTING STARTED

Introduction

This section contains information for the unpacking, inspection, preparation for use and storage of your Associated Research, Inc., product.

2.1. Unpacking and Inspection

2.1.1. Packaging

Your instrument was shipped in a custom foam insulated container. If the shipping carton is damaged, inspect the contents for visible damage such as dents, scratches or a broken display. If the instrument is damaged, notify the carrier and Associated Research, Inc.'s customer support department. **Please save the shipping carton and packing material for the carrier's inspection.** Our customer support department will assist you in the repair or replacement of your instrument. Please do not return your product without first notifying us and receiving an RMA (return material authorization) number. To receive an RMA number, please contact our customer support department at 1-800-858-TEST (8378).

Safe Lifting and Carrying Instructions

Proper methods of lifting and carrying can help to protect against injury. Follow the recommendations below to ensure that instruments are handled in a safe manner.

- Determine if the instrument can be lifted by one individual or requires additional support.
- Make sure that your balance is centered and your feet are properly spaced, shoulder width apart behind the instrument.
- Bend at the knees and make sure your back is straight.
- Grip the instrument with your fingers and palms and do not lift unless your back is straight.
- Lift up with your legs, not your back.
- Keep the instrument close to your body while carrying.
- Lower the instrument by bending your knees. Keep you back straight.

2.1.2. Contents of the Carton

Inside the carton should be the following:

	HYPOTMAX INSTRUMENT	
	7715, 7720	7705, 7710
PART DESCRIPTION	AR PART NUMBER	AR PART NUMBER
High Voltage Cable	38686**	38712
Return Cable	38685	38736
Fuse	37780, 6.3 Amp, Slo-Blo 250VAC	37780, 6.3 Amp, Slo-Blo 250VAC
USB Cable AB-Type 1.8m	39066	39066
RS232 Cable	37863	37863
3U Rack Mount Handle	38787	38787
3U Rack Mount Bracket	38788	38788
Handle to Bracket screws	38549 (qty.4)	38549 (qty.4)
Interlock Connector	38075	38075
Line Cord*	33189 Standard	33189 Standard

- NOTE: The Line Cord listed is American. Other Line Cords are available upon request. An optional HV probe is available AR part number 38694.

CAUTION

Do not replace the included line cord with an improperly rated cord. A UL listed and CSA labeled power cord must be used with the instrument in the United States and Canada. The power cord must include a NEMA5-15 style male plug, SVT or SJT cord sets, and be rated for at least 125VAC, 14A. Number 14 gauge wire or larger must be used.

WARNING

Only accessories that meet the manufacturer's specifications shall be used.



2.2. Installation

2.2.1. Work Area

WARNING

Locate a suitable testing area and be sure you have read all safety instructions for the operation of the instrument and suggestions on the test area setup in section **1.4. Safety**. Make sure the work area you choose has a three-prong grounded outlet capable of supplying the necessary input current to the power source. Be sure the outlet has been tested for proper wiring before connecting the instrument to it.

WARNING

The mains plug is used as the disconnecting device and shall remain readily operable. The socket-outlet shall be installed near the equipment and shall be easily accessible.

2.2.2. Power Requirements

This instrument requires a power source of either 115 volts AC $\pm 10\%$, 50/60 Hz single phase or 230 volts AC $\pm 10\%$, 50/60 Hz single phase. Before applying power verify that the instrument is set to the correct line voltage (115 or 230 volts). Adjust the voltage select switch to 115 for use with a 115 volt input. Adjust the voltage select switch to 230 for use with a 230 volt input. See section **3.2.2. Rear Panel Controls** for an image of the rear panel.

CAUTION

Do not replace the power supply cord with an improperly rated cord. For North American: A UL listed and CSA labeled power cord must be used with the instrument in the United States and Canada. The power cord must include a NEMA5-15 style male plug, SVT or SJT cord sets, and be rated for at least 125VAC, 10A, number 16 gauge (or 125VAC, 15A, number 14 gauge) wire or larger, and the length of the cord does not exceed 2 m must be used. For European: A certified power supply cord not lighter than light PVC sheathed flexible cord according to IEC 60227, designation H03 VV-F or H03 VVH2-F (for equipment mass not exceeding 3 kg), or H05 VV-F or H05 VVH2-F2 (for equipment mass exceeding 3 kg), and be rated for at least 3G 0.75 mm² (for rated current up to 10 A) or 3G 1.0mm² (for rated current over 10 A up to 16 A) wire or larger, and the length of the cord does not exceed 2 m must be used.

CAUTION

Do not switch the line voltage selector switch located on the rear panel while the instrument is on or operating. This may cause internal damage and represents a safety risk to the operator.

WARNING

HypotMAX must be connected to a good ground. Be certain that the power wiring is properly polarized and that the proper low resistance bonding to ground is in place.

2.2.3. Basic Connections

Power Cable

The instrument is shipped with a line cord containing a protective earth ground. When the line cord is connected to an appropriate AC power source the cable will connect the chassis to earth ground.

WARNING

The main plug shall only be inserted in a socket outlet with a protective ground (earth) contact. This protective ground **must not be defeated** by the use of an extension cord without a protective conductor.

Return Connection

When the instrument's return is grounded, any internal and external stray leakage will be monitored due to currents that flow from high voltage to earth ground (such as from high voltage to the chassis of the instrument). These currents are inherent and will cause errors when trying to monitor very low leakage currents in the microamp range.

The output power supplies of this instrument are referenced directly to earth ground. Any conductor that completes a path between the high voltage and earth ground will form a completed circuit.

Environmental Conditions

This equipment is intended for indoor use only. The equipment has been evaluated according to Installation Category II and Pollution Degree 2 as specified in IEC 60664.

This instrument may be operated in environments with the following limits:

Temperature.....	41° - 104° F (5° - 40°C)
Relative humidity.....	0 – 80%
Altitude.....	6560 feet (2,000 meters)

WARNING

Keep the ventilation slits uncovered during operation. Failure to do so could cause the instrument to overheat and may damage internal components.

Storage and Shipping Environment

This instrument may be stored or shipped in environments with the following limits:

Temperature.....	-40° - 167° F (-40° - 75°C)
Altitude.....	50,000 feet (15,240 meters)

The instrument should also be protected against temperature extremes that may cause condensation within the instrument.

CAUTION

Failure to operate this instrument within the specified conditions could result in damage.

If the instrument is used in a manner not specified by the manufacturer, the protection provided by the instrument may be impaired.

More Information

For more information on test operator and workstation safety please visit the Events and Training section of our website at <http://www.asresearch.com/events-training/Default.aspx>.

3. SPECIFICATIONS AND CONTROLS

3.1. 7705 Functional Specifications

INPUT		
Voltage	115/230 VAC \pm 10%, Single Phase, User selection	
Frequency	50/60 Hz \pm 5%	
Fuse	6.3 Amp, 250V Slow Blow	
DIELECTRIC WITHSTAND TEST MODE		
Output Rating	10 kV @ 20 mA	
Output Adjustment	Range:	0.00 – 10.00 kV AC
	Resolution:	10 volt/step
	Accuracy:	\pm (2% of setting + 10 volts)
HI and LO-Limit	Range 1:	0.000 – 9.999 mA
	Resolution:	0.001 mA/step
	Range 2:	10.00 – 20.00 mA
	Resolution:	0.01 mA/step
	Accuracy:	\pm (2% of setting + 2 counts)
Arc Detection	Range:	1 – 9 at Output Voltage < 7.00 kV 1 – 8 at Output Voltage \geq 7.00 kV
Failure Detector	Audible and Visual	
Voltage Display	Range:	0.00 – 10.00 kV Full Scale
	Resolution:	10 volt
	Accuracy:	\pm (2% of reading + 20 V)
Current Display	Auto Range	
	Range 1:	0.000 mA – 3.500 mA
	Resolution:	0.001 mA
	Range 2:	3.00 – 20.00 mA
	Resolution:	0.01 mA
	Accuracy:	\pm (2% of reading + 3 counts)
AC Output Wave Form	Sine Wave, Crest Factor = 1.3 – 1.5	
Output Frequency	Range:	60 or 50 Hz, User Selection
	Accuracy:	\pm 1%
Output Regulation	\pm (1 % of setting + 10 volts) from no load to full load	
Dwell Timer	Range:	0.0, 0.3 – 999.9 seconds 0.0 - 999.9 minutes (0 = Constant)
	Resolution:	0.1 second or minute increments
	Accuracy:	\pm (0.1% + 1 count)
Ramp-UP	Range:	0.3 – 999.9 sec

Ramp-DOWN	Range:	0.0 – 999.9 sec
	Resolution:	0.1 sec increments
	Accuracy:	± (0.1% + 1 count)
Ground Fault	GFI Trip Current:	1 mA max
Interrupt	HV Shut Down response:	< 1 ms

3.2. 7710 Functional Specifications

INPUT		
Voltage	115/230 VAC ± 10%, Single Phase, User selection	
Frequency	50/60 Hz ± 5%	
Fuse	6.3 Amp, 250V Slow Blow	
DIELECTRIC WITHSTAND TEST MODE		
Output Rating	12 kV @ 10 mA	
Output Adjustment	Range:	0.00 – 12.00 kV DC
	Resolution:	10 volt/step
	Accuracy:	± (2% of setting + 10 volts)
Ramp-HI	13 mA peak maximum, 10 mA DC, ON/OFF selectable	
Charge-LO	Range:	0.0 - 350.0 µA DC or Auto set
HI and LO-Limit	Range 1:	0.0 – 999.9 µA
	Resolution:	0.1 µA/step
	Range 2:	1000 – 9999 µA
	Resolution:	1 µA/step
	Accuracy:	± (2% of setting + 2 counts)
Arc Detection	Range:	1 – 9
Failure Detector	Audible and Visual	
Voltage Display	Range:	0.00 – 12.00 kV Full Scale
	Resolution:	10 volt
	Accuracy:	± (2% of reading + 20 V)
Current Display	Auto Range	
	Range 1:	0.0 µA - 350.0 µA
	Resolution:	0.1 µA
	Range 2:	300 µA - 3500 µA
	Resolution:	1 µA
	Range 3:	3000 µA - 9999 µA
Resolution:	10 µA	
	Accuracy:	± (2% of reading + 3 counts)
DC Output Ripple	≤ 5% Ripple RMS at 12 kV DC @ 9999 uA, Resistive Load	

Output Regulation	$\pm (1 \% \text{ of setting} + 10 \text{ volts})$ from no load to full load	
Maximum Capacitive Load	1.7 μF < 2 kV	0.3 μF < 8 kV
	0.8 μF < 4 kV	0.25 μF < 10 kV
	0.4 μF < 6 kV	0.2 μF < 12 kV
Discharge time	No load ≤ 400 ms. Capacitive loading will increase the discharge time. The time will vary due to the load condition and voltage selection.	
Dwell Timer	Range:	0.0, 0.4 – 999.9 seconds 0.0 - 999.9 minutes (0 = Constant)
	Resolution:	0.1 second or minute increments
	Accuracy:	$\pm (0.1\% + 1 \text{ count})$
Ramp-UP	Range:	0.4 – 999.9 sec
Ramp-DOWN	Range:	0.0, 1.0 – 999.9 sec (0=OFF)
	Resolution:	0.1 sec increments
	Accuracy:	$\pm (0.1\% + 1 \text{ count})$
Ground Fault	GFI Trip Current:	1 mA max
Interrupt	HV Shut Down response:	< 1 ms (Actual Output Voltage discharge time is not included and vary due to load condition)

3.3. 7715 Functional Specifications

INPUT		
Voltage	115/230 VAC $\pm 10\%$, Single Phase, User selection	
Frequency	50/60 Hz $\pm 5\%$	
Fuse	6.3 Amp, 250V Slow Blow	
DIELECTRIC WITHSTAND TEST MODE		
Output Rating	20 kV @ 10 mA	
Output Adjustment	Range:	0.00 – 20.00 kV AC
	Resolution:	10 volt/step
	Accuracy:	$\pm (2\% \text{ of setting} + 10 \text{ volts})$
HI and LO-Limit	Range:	0.000 – 9.999 mA
	Resolution:	0.001 mA/step
	Accuracy:	$\pm (2\% \text{ of setting} + 2 \text{ counts})$
Arc Detection	Range:	1 – 9 at Output Voltage < 15.00 kV 1 – 7 at Output Voltage ≥ 15.00 kV
Failure Detector	Audible and Visual	
Voltage Display	Range:	0.00 – 20.00 kV Full Scale
	Resolution:	10 volt
	Accuracy:	$\pm (2\% \text{ of reading} + 20 \text{ V})$

Current Display	Auto Range	
	Range 1:	0.000 mA – 3.500 mA
	Resolution:	0.001 mA
	Range 2:	3.00 – 10.00 mA
	Resolution:	0.01 mA
	Accuracy:	± (2% of reading + 3 counts)
AC Output Wave Form	Sine Wave, Crest Factor = 1.3 – 1.5	
Output Frequency	Range:	60 or 50 Hz, User Selection
	Accuracy:	± 1%
Output Regulation	± (1 % of setting + 10 volts) from no load to full load	
Dwell Timer	Range:	0.0, 0.3 – 999.9 seconds 0.0 - 999.9 minutes (0 = Constant)
	Resolution:	0.1 second or minute increments
	Accuracy:	± (0.1% + 1 count)
Ramp-UP	Range:	0.3 – 999.9 sec
Ramp-DOWN	Range:	0.0 – 999.9 sec
	Resolution:	0.1 sec increments
	Accuracy:	± (0.1% + 1 count)
Ground Fault	GFI Trip Current:	1 mA max
Interrupt	HV Shut Down response:	< 1 ms

3.4. 7720 Functional Specifications

INPUT		
Voltage	115/230 VAC ± 10%, Single Phase, User selection	
Frequency	50/60 Hz ± 5%	
Fuse	6.3 Amp, 250V Slow Blow	
DIELECTRIC WITHSTAND TEST MODE		
Output Rating	20 kV @ 5 mA	
Output Adjustment	Range:	0.00 – 20.00 kV DC
	Resolution:	10 volt/step
	Accuracy:	± (2% of setting + 10 volts)
Ramp-HI	6.75 mA peak maximum, 5 mA DC, ON/OFF selectable	
Charge-LO	Range:	0.0 - 350.0 µA DC or Auto set
HI and LO-Limit	Range 1:	0.0 – 999.9 µA
	Resolution:	0.1 µA/step
	Range 2:	1000 – 5000 µA
	Resolution:	1 µA/step
	Accuracy:	± (2% of setting + 2 counts)

Arc Detection	Range:	1 – 9
Failure Detector	Audible and Visual	
Voltage Display	Range:	0.00 – 20.00 kV Full Scale
	Resolution:	10 volt
	Accuracy:	± (2% of reading + 20 V)
Current Display	Auto Range	
	Range 1:	0.0 μA - 350.0 μA
	Resolution:	0.1 μA
	Range 2:	300 μA - 5000 μA
	Resolution:	1 μA
	Accuracy:	± (2% of reading + 3 counts)
DC Output Ripple	≤ 5% Ripple RMS at 20 kV DC @ 4999 uA, Resistive Load	
Output Regulation	± (1 % of setting + 10 volts) from no load to full load	
Maximum Capacitive Load	1.5 uF < 2 kV	0.12 uF < 14 kV
	0.28 uF < 4 kV	0.10 uF < 16 kV
	0.18 uF < 6 kV	0.08 uF < 20 kV
	0.15 uF < 10 kV	
Discharge time	No load ≤ 500 ms. Capacitive loading will increase the discharge time. The time will vary due to the load condition and voltage selection.	
Dwell Timer	Range:	0.0, 0.4 – 999.9 seconds 0.0 - 999.9 minutes (0 = Constant)
	Resolution:	0.1 second or minute increments
	Accuracy:	± (0.1% + 1 count)
Ramp-UP	Range:	0.4 – 999.9 sec
Ramp-DOWN	Range:	0.0, 1.0 – 999.9 sec (0=OFF)
	Resolution:	0.1 sec increments
	Accuracy:	± (0.1% + 1 count)
Ground Fault	GFI Trip Current:	1 mA max
Interrupt	HV Shut Down response:	< 1 ms (Actual Output Voltage discharge time is not included and vary due to load condition)

3.5. General Specifications

GENERAL	
Agency Compliance	CE, cTUVus, RoHS2
Remote Control And Signal Output	The following input and output signals are provided through two 9 pin D type connectors; Remote control: Test, Reset, and Remote Interlock. Remote recall of memory program #1, #2 and #3 Outputs: Pass, Fail, Test-in-Process, and Reset
Interface	Standard USB/RS-232, Optional GPIB.
Program Memory	50 Sets
Security	Key Lock capability to avoid unauthorized access to all test parameters Memory Lock capability to avoid unauthorized access to memory locations.
Safety	Built-in Smart GFI circuit
Display	2 x 20 characters with front panel contrast setting.
Alarm Volume Setting	Front panel adjustable volume setting with 10 set points.
Line Cord	Detachable 7 ft. (2.13m) power cable terminated in a three prong grounding plug.
Terminations	Detachable 5ft.(1.52m) high voltage and return lead with clips.
Mechanical	Tilt up front feet. Dimensions: (W x H x D) 16.93 x 5.24 x 15.75 in. (430 x 133 x 400 mm) Weight: 48.9 lbs. (22.2 kg)
Environmental	Operating Temperature: 32° - 104°F, (0° - 40°C) Relative Humidity: 0% to 80%
Calibration	Traceable to National Institute of Standards and Technology (NIST). Calibration controlled by software. Adjustments are made through front panel keypad in a restricted access calibration mode. Calibration information stored in non-volatile memory.

Why use the term “Counts”?

Associated Research publishes some specifications using COUNTS which allows us to provide a better indication of the tester’s capabilities across measurement ranges. A COUNT refers to the lowest resolution of the display for a given measurement range. For example, if the resolution for voltage is 1V then 2 counts = 2V.

3.6. Instrument Controls

3.6.1. Front Panel Controls

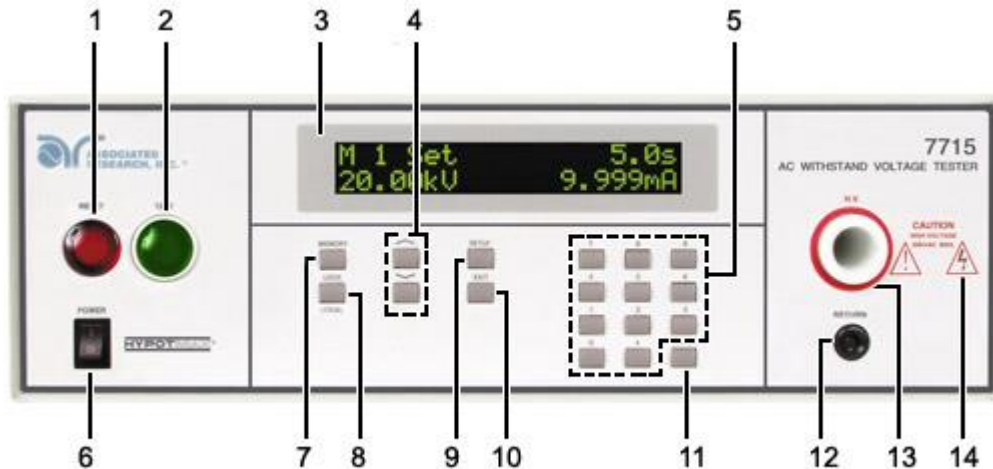

1. **RESET BUTTON:** Resets the instrument. If a failure condition occurs during a test, pressing this button will reset the system, shut off the alarm and clear the failure condition. The Reset button must be pressed before performing another test or changing any of the setup parameters. This button also serves as an abort signal to stop any test in progress.
2. **TEST BUTTON:** Starts a test.
3. **LCD DISPLAY:** The 2x20-character display indicates test function, memory location, test parameter and failure type as well as test measurements during a test.
4. **UP-DOWN ARROW KEYS:** Keys to cycle through test parameter setup.
5. **DATA ENTRY KEYS:** Keys to input numeric parameters.
6. **POWER SWITCH:** Rocker style power switch with international ON (|) and OFF (0) markings.
7. **MEMORY:** Use this key to select one of the 50 memories to modify or run stored test parameters.
8. **LOCK/LOCAL:** Enters key lockout mode. Use this key when you wish to go from the Remote operation of the instrument to the Local mode.
9. **SETUP:** Use this key to enter the setup menu and view or change the display contrast, alarm volume, and PLC remote settings.

10. **EXIT:** Use this key to exit any menu or to clear an unwanted entry in a parameter field.
11. **ENTER:** Use this key as an ENTER key to accept numeric data for parameter settings.
12. **RETURN OUTPUT TERMINAL:** Connector used to attach the return test lead, adapter box return lead or test fixture return lead to the instrument. This connection provides the return current path.
13. **HIGH VOLTAGE OUTPUT TERMINAL:** Connector used to attach the high voltage test lead, adapter box high voltage lead or test fixture high voltage lead to the instrument. This connection provides the high voltage used during a Hipot test.
14. **HIGH VOLTAGE INDICATOR:** This indicator flashes to warn the operator that high voltage is present at the high voltage output terminal.

3.6.2. Rear Panel Controls

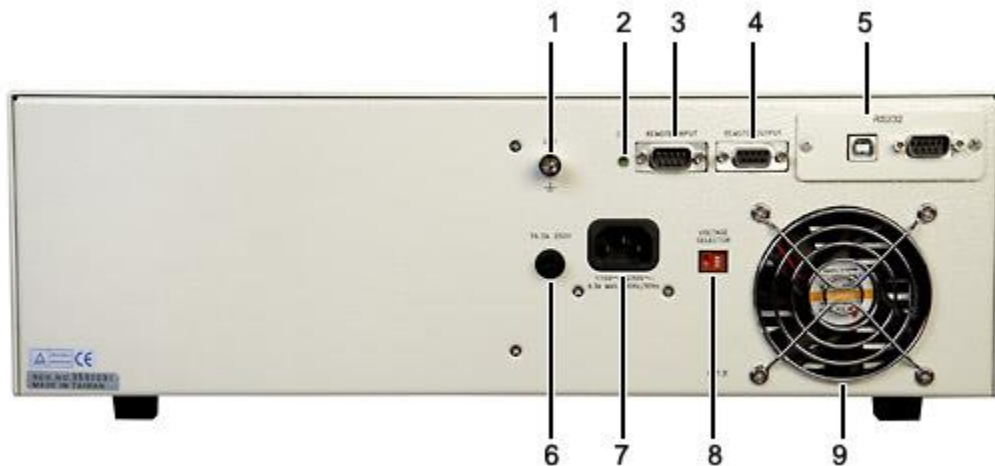

1. **CHASSIS GROUND (EARTH) CONNECTION:** This terminal should be connected to a good earth ground before operation.
2. **CALIBRATION BUTTON:** To put the instrument into the calibration mode push this button and turn on the power switch simultaneously.
3. **REMOTE SIGNAL INPUT:** 9-Pin D-type subminiature male connector for remote control of TEST, RESET, and REMOTE INTERLOCK DISABLE functions, as well as MEMORY SELECTION (See section 6.0. **Connection of Remote I/O** for more detailed information).

- 4. REMOTE SIGNAL OUTPUT:** 9-Pin D-type subminiature female connector for monitoring PASS, FAIL, and PROCESSING output relay signals (See section **6.0. Connection of Remote I/O** for more detailed information).
- 5. BUS INTERFACE:** Standard connector for interconnection to the USB/RS-232 Bus interface. Optional IEEE 488 interface may be substituted for the USB/RS-232.
- 6. FUSE RECEPTACLE:** To change the fuse, unplug the power (mains) cord and turn the fuse receptacle counter-clockwise. The fuse compartment will be exposed. Please replace the fuse with one of the proper rating.
- 7. INPUT POWER RECEPTACLE:** Standard IEC 320 connector for connection to a standard NEMA style line power (mains) cord.
- 8. INPUT POWER SWITCH:** Sets the line voltage configuration of the instrument. In the left position it is set for 115 volt operation, in the right position it is set for 230 volt operation.
- 9. THERMAL COOLING FAN:** Runs continuously to cool the instrument.

4. PROGRAMMING INSTRUCTIONS

4.1. Power Up

Turn on the POWER switch located on the lower left hand side of the front panel. Upon powering the instrument up, a POWER ON SELF TEST will be automatically performed. This test will check for the condition of the instrument's critical components. In addition the display will show the following message, with the actual model number and software version number:



The program will then recall the Memory which was last executed.

4.2. System Parameter Settings

Press the SETUP key to progress through the menu of System Parameters. Successive key presses will advance the menu forward. The sequential forward menu items are: PLC Remote, Fail Stop, Contrast, Alarm, Smart GFI, GPIB address, BUS Remote Command Set, and Memory Lock. The system settings are global and are not specific to any memory location.

4.2.1. PLC Remote

Press the SETUP key to advance to the PLC Remote parameter. The display will show:

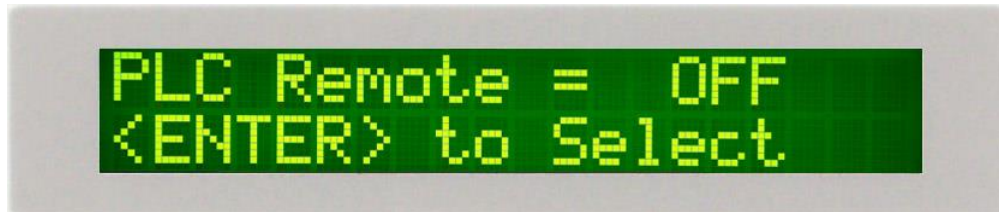

Use the ENTER key to select the mode PLC Remote Control.

Press the SETUP key to advance to the address setting if the GPIB interface card is installed on this instrument. If this instrument does not have the GPIB interface card (the program will advance to the contrast setting), or press the EXIT key to exit from the PLC Remote selection to the operation mode. The instrument will store the selection of PLC Remote automatically.

If the Remote Control is set to ON, the test function will be controlled by the via the remote connectors located on the rear panel. The TEST button on the front panel is disabled but the RESET button is still enabled.

The remote Memory Program recall functions can be performed only when the PLC Remote is set ON. In addition, when the PLC remote is set to ON the remote TEST signal input is active while in the Bus Remote Mode.

If the Remote Control is set to OFF, the operation of the instrument will be controlled by the local TEST and RESET buttons on the front panel.

4.2.2. Fail Stop

Press the SETUP key to advance the menu to the Fail Stop parameter. The display will show:



```
Fail Stop = OFF
<ENTER> to Select
```

Use the ENTER key to toggle the Fail Stop ON and OFF.

This mode allows the instrument to continue testing after detecting a failure. If the Fail stop is OFF and a failure occurs during the test sequence, the RESET button will light and a short alarm will sound but the sequence will continue to the end. At the end of the test sequence, the RESET button will light and alarm will sound indicating failure during the sequence. Pressing the RESET button will silence the alarm and reset the instrument.

A display of the first eight connected memories PASS/FAIL results on items tested is provided at the conclusion of the last connected memory.



```
Test P F P F P F P F
Mem  1 2 3 4 5 6 7 8
```

The display will show the results of the eight memories as follows:
The pass-fail status is indicated by the letter F (Fail) or P (Pass).

Toggle the Fail Stop function or press the SETUP key to forward to the LCD Contrast selection. Press the EXIT key to return to the operation mode. The program will store the Fail Stop setting automatically.

4.2.3. LCD Contrast

Press the SETUP key to advance the menu to the Contrast parameter. The display will show:



Use the Numeric keys to enter the LCD Contrast level, then press the ENTER key. The program will change the LCD Contrast immediately when the ENTER key is pressed, so the setting can be viewed.

The LCD Contrast level may be adjusted from 1 - 9. Level 1 is the lowest contrast and level 9 is the highest contrast.

Press the SETUP key to advance to the Alarm Volume setting. Press the EXIT key to return to the operation mode. The program will store the Contrast setting automatically.

4.2.4. Alarm Volume

Press the SETUP key to advance the menu to the Volume parameter. The display will show:



The Audible Alarm Volume range is from 0 - 9. Level 0 is used to disable the Audible Alarm. Level 1 is the lowest volume and level 9 is the loudest.

Use the Numeric keys to enter the Audible Alarm level, then press the ENTER key. The program will provide a sample sound for checking immediately when the ENTER key is pressed.

Press the SETUP key to forward to the Smart GFI selection. Press the EXIT key to return to the operation mode. The program will store the Volume setting automatically.

4.2.5. Smart GFI

Press the SETUP key to advance the menu to the Smart GFI parameter. The display will show:



```
Smart GFI = ON
<ENTER> to Select
```

Use the ENTER key to toggle the Smart GFI ON and OFF.

The high voltage power supply of the HypotMAX is internally referenced to earth ground. Since the leakage current measuring circuit of the instrument monitors only current that flows through the return lead the possibility exists for current to flow directly from the high voltage output to earth ground without being measured. The SmartGFI (Ground Fault Interrupt) circuit monitors the current between the high voltage output and earth ground. Therefore, if the operator touches the high voltage lead and earth ground, the instrument will detect this hazardous condition and shut off immediately.

SmartGFI goes beyond a standard GFI circuit by automatically determining the return configuration of the DUT (grounded or floating) and enabling or disabling depending on the situation. When the HypotMAX's Return lead is floating, the SmartGFI circuit enables, protecting the test operator from electric shock. When the HypotMAX's Return lead is earth grounded, the SmartGFI circuit disables and the instrument operates in a grounded return mode of operation. If the GFI were to remain active in this state, the tester would continuously fail since all current is returning through earth ground. By disabling the SmartGFI circuit and operating in a grounded return mode, HypotMAX allows the user to perform tests on devices that have their chassis's earth grounded by the test fixture or test environment.

Toggle the Smart GFI function or press the SETUP key to forward to the GPIB address selection. Press the EXIT key to return to the operation mode. The program will store the Smart GFI setting automatically.

4.2.6. GPIB Address (optional)

Press the SETUP key to advance the menu to the GPIB address parameter. The display will show:



```
GPIB addr = 8
Range: 0-31
```

Use the Numeric keys to enter the GPIB Address, then press the ENTER key.

Change the GPIB address again or press the SETUP key to advance to the Memory Lock parameter. Press the EXIT key to return to the operation mode. The program will store the GPIB address automatically.

4.2.7. BUS Remote Command Set (unavailable with Option 02 Printer Card)

Press the SETUP key to advance the menu to the Command Set Format parameter. The display will show:



```
Command Set= 488.2
<ENTER> to Select
```

Use the ENTER key to toggle the remote command set between 488.1 and 488.2. Please refer to section **7.0. Bus Remote Interface USB/GPIB/RS232** for additional information about this selection.

Change the BUS Remote Command Set again or press the SETUP key to advance to the Memory Lock parameter. Press the EXIT key to return to the operation mode. The program will store the BUS Remote Command Set automatically.

4.2.8. Memory Lock

Press the SETUP key to advance the menu to the Memory Lock parameter. The display will show:



```
Memory Lock= OFF
<ENTER> to Select
```

Use the ENTER key to toggle the Memory Lock ON and OFF.

Memory Lock is a sub-function of the Lock setting. In order for the Memory Lock function to work, the Lock must first be turned ON. Selecting the Memory Lock OFF will allow the user to access all available Memory locations but restricts access to memory editing capabilities. Selecting the Memory Lock ON will allow the user to only run the currently loaded memory.

Press the SETUP key to forward to the PLC Remote selection. Press the EXIT key to return to the operation mode. The program will store the Memory Lock setting automatically.

4.2.9. Default System Parameters

Setup	PLC Remote	OFF
	Fail Stop	ON
	Contrast	5
	Alarm	5
	Smart GFI	ON
	Command Set	488.2
	Mem Lock	ON

4.2.10. Default System Parameter Initialization

WARNING

Initializing the instrument will overwrite all memories with the Default parameters!

Press the “0” and the “1” keys and power the instrument at the same time. A question will appear on the display as follows:



Set Defaults?
SETUP=Yes EXIT=No

Pressing the SETUP key will load the Default Test and System parameters. All memories will be loaded with the default parameters and the System parameters will be set to the factory defaults. The default system parameters are displayed in section 4.2.9.

4.3. LOCK/LOCAL Key

4.3.1. Lock Function

Press the LOCK/LOCAL key. If the Password is enabled, the display will show:



Password =
0-9999

If a password has not been set, use the Numeric Key to enter the password and then press the ENTER key. The program will switch the Key Lock function to LOCK mode and advance the program to Operation mode automatically. If the wrong password is entered, the program will give a warning sound and the display will show:



Password = ERROR
0-9999

The program will return to the original screen and wait for a new password.

If the Password is disabled (Password is set "0"), the display will show:



Lock = OFF
<ENTER> to Select

Use the ENTER key to select the Key Lock mode, and then press the EXIT key. The program will switch the Key Lock function and advance the program to the Operation mode automatically. If the Key Lock function is in the Lock mode, the LOCK indicator on the front panel will light.

Memory Lock

If the Memory Lock function is selected to ON, the Memory selection Menu will be disabled when in the Lock Mode. If the Memory Lock is selected to OFF, the Memory selection Menu will be enabled when in the Lock Mode. Different memories can be recalled but the test parameters or steps cannot be changed.

Please refer to section **4.2.8. Memory Lock** for instructions on this feature.

4.3.2. Local Function

Use this key when you wish to go from the Remote operation of the instrument to the Local mode (operates the instrument from the front panel).

4.4. Password Setting

Press the "4" and "7" keys simultaneously and then turn the input power switch ON. The program will automatically enter to the Password Setting mode and the display screen will show:



Password =
0-9999

The Password can be any four (4) digit number. If the Password is set to 0, the keyboard lock out will be selected by the LOCK key on the front panel without a Password. The Password default is preset to 0 at the factory.

4.5. Test Setup

4.5.1. Memory Configuration

The HypotMAX is equipped with 50 memory locations number 1 through 50. Each memory location consists of 1 test and may be linked to perform up to 50 tests in sequence.

To Select the Memory Location
Press the MEMORY key, the display will show:



Use the Numeric Keys to enter the memory location number, and then press the ENTER key. The program will recall the test parameters stored in this location and return to the operation mode automatically.

4.5.2. Test Parameters

Voltage: The Voltage that is applied to the High Voltage and Return terminals or the Current and Return terminals during a test.

HI-Limit: A maximum current or resistance threshold that when exceeded triggers a failure.

LO-Limit: A minimum current or resistance threshold that when not exceeded triggers a failure.

Ramp-UP: A length of time that is allowed for the test voltage to climb from 0 to the voltage set point.

Dwell Unit: Allows for the selection of seconds or minutes as the Dwell timers base unit.

Dwell: A length of time that is allowed for the set point voltage to be applied.

Ramp-DOWN: A length of time that is allowed for the test voltage to decay from set point to zero.

Arc Detect: This function when turned on activates the Arc Detection threshold controlled by the Arc Sense parameter.

Arc Sense: The numbers corresponding to the different arc sensitivity levels are 1 through 9, 1 meaning the maximum threshold of allowable arcing, 9 meaning the minimum threshold of allowable arcing. During Hipot testing, some low current arcing may be allowable. Arc sense is a maximum allowable threshold for arcing.

Frequency: This parameter is available in AC tests only and is selectable using the settings menu between 50 and 60Hz.

Connect: This function when turned ON will connect or link the current memory to the next memory. This function allows all 50-memory locations to be connected together.

Ramp-HI: Ramp-HI will allow current higher than the normal HI-Limit current setting of the DC Withstand Voltage test, during the Ramp-Up time, to avoid false failure due to charging current. Ramp-HI may be selected ON or OFF using a soft key. A description of how to set up this parameter is given in the **4.6.10. Ramp-Hi selection** section of this manual.

Charge-LO: The Charge-LO function is used to check if the cables are connected properly at the beginning of a test. This function is only available in DC Withstand and Insulation resistance testing. A description of how to set up this parameter is given in the **4.6.11. Charge-Lo setting** section of this manual.

4.5.3. Default Test Parameters

The following table is a listing of the Default Parameters for the ACW tests available in the 7705 and 7715 HypotMAX and the DCW tests available in the 7710 and 7720 HypotMAX. When you receive your HypotMAX all 50 memory locations will be loaded with these parameters. The Default Parameters are as follows:

TEST TYPE	PARAMETER	VALUE
ACW units	Voltage	1.24kVAC
	HI-Limit (current)	5.000mA
	LO-Limit (current)	0.000mA
	Ramp UP	0.3s
	Dwell Unit	Second
	Dwell Time	1.0s
	Ramp-DOWN	0.0s
	Frequency	60Hz
	Arc Detect	OFF
	Arc Sense	5
	Connect	OFF
DCW units	Voltage	1.50kVDC
	HI-Limit	5000 μ A
	LO-Limit	0.0 μ A
	Ramp-UP	0.4s
	Dwell Unit	Second
	Dwell Time	1.0s
	Ramp-DOWN	0.0s
	Arc Detect	OFF
	Arc Sense	5
	Ramp-HI	OFF
	Charge-LO	0.0 μ A
Connect	OFF	

4.6. Setting Up a Test

Before going to setup the Test Parameters, make sure that the Keyboard is in the Unlock mode, and then follow this procedure to setup the Test Parameters.

Press the Memory key and using the numeric keypad enter the Memory number you would like to edit and then press the ENTER key.

Use the \wedge or \vee arrow keys to progress through the test parameters menu. The \vee key will advance forward and \wedge key will advance backward. The sequential forward menu items are Voltage, HI-Limit, LO-Limit, Ramp-UP, Dwell Unit, Dwell Time, Ramp-DOWN, Frequency, Arc Detect, Arc Sense, and Connect.

4.6.1. Output Voltage setting

Advance the menu to the Voltage parameter. The display will show:



Voltage = 1.50 kV
Range: 0.00-20.00kV

Use the Numeric keys to enter the voltage setting, and then press the ENTER key. The program will store the voltage setting and advance to the High Limit parameter automatically.

Press the EXIT key to exit from the setting mode to the operation mode if all parameters have been set.

4.6.2. HI-Limit Current setting

Advance the menu to the HI-Limit parameter. The display will show:



HI-Limit = 5000 uA
Range: 0.0-5000uA

Use the Numeric keys to enter the HI-Limit setting, and then press the ENTER key. The program will store the HI-Limit setting and advance to the LO-Limit parameter automatically.

Press the EXIT key to exit from the setting mode to the operation mode if all parameters have been set.

4.6.3. LO-Limit Current setting

Advance the menu to the LO-Limit parameter. The display will show:



LO-Limit = 0.0 uA
Range: 0.0-5000uA

Use the Numeric keys to enter the LO-Limit setting, then press the ENTER key. The program will store the LO-Limit setting and advance to the Ramp-UP parameter automatically.

Press the EXIT key to exit from the setting mode to the operation mode if all parameters have been set.

If the LO-Limit is set to “0”, the LO-Limit is disabled.

4.6.4. Ramp-UP Time setting

Advance the menu to the Ramp-UP time parameter. The display will show:



```
Ramp-UP = 0.4 s
Range: 0.4-999.9s
```

Use the Numeric keys to enter the Ramp-UP time setting, then press the ENTER key. The program will store the Ramp-UP time setting and advance to the Dwell Time setting automatically.

Press the EXIT key to exit from the setting mode to the operation mode if all parameters have been set.

4.6.5. Dwell Unit setting

Advance the menu to the Dwell Unit parameter. The display will show:



```
Dwell Unit = Second
<ENTER> to Select
```

Use the ENTER key to toggle between the Seconds and Minutes. The program will store the Dwell Unit setting and advance to the Dwell Time setting automatically.

4.6.6. Dwell Time setting

Advance the menu to the Dwell Time parameter. The display will show:



```
Dwell Time = 1.0 s
0.4-999.9s 0=Const.
```

Use the Numeric keys to enter the Dwell Time setting, and then press the ENTER key. The program will store the Dwell Time setting and advance to the Ramp -DOWN time

setting automatically. The unit is “second” and 0.1 second per step. The display will show the elapsed time during the testing.

Press the EXIT key to exit from the setting mode to the operation mode if all parameters have been set.

If the Dwell Time is set to “0”, the timer will continue to count to the maximum test time then reset to “0” and start over automatically. The test will continue until a reset is executed or a failure occurs.

4.6.7. Ramp-DOWN Time setting

Advance the menu to the Ramp-DOWN time parameter. The display will show:



Ramp-DOWN = 0.0 s
Range: 0, 1.0-999.9s

Use the Numeric keys to enter the Ramp-DOWN time setting, then press the ENTER key. The program will store the Ramp-DOWN time setting and advance to the Frequency Selection automatically.

Press the EXIT key to exit from the setting mode to the operation mode if all parameters have been set.

4.6.8. Frequency Selection (AC units only)

Advance the menu to the Frequency parameter and the display will show:



Frequency = 60 Hz
<ENTER> to Select

Use the ENTER key to select the Output Frequency, then press the ^ or v key to advance to another test parameter or press the EXIT key to exit from the setting mode to the operation mode.

4.6.9. Arc Detect and Arc Sensitivity Selection

Advance the menu to the Arc Detection selection. The display will show:



Arc Detect= ON
<ENTER> to Select

Use the ENTER key to toggle the Arc Detect mode, then press the \wedge or \vee key to advance the program to the Arc Sense parameter or press the EXIT key to exit from the setting mode to the operation mode.

Advance the menu to the Arc Sense parameter. The display will show:



Arc Sense = 5
Range: 1-9 9=High

Use the Numeric keys to enter the Arc Sense setting, and then press the ENTER key. The numeric value is proportional to the amount of sensitivity, i.e. “9” is the highest sensitivity. The program will store the Arc Sense setting and advance to the Connect mode selection automatically.

For the model 7715 the ARC Sense Range changes from 1 to 7 when output voltage is set for 15 kV or more.

If the Arc Detect mode is set to ON, the program will indicate an arc failure when the arc current is over the setting and the program will shut down the test immediately.

If the Arc Detect mode is set to OFF, the program will not indicate an arc failure when the arc current is over the setting.

4.6.10. Ramp-HI selection (DC units only)

Advance the menu to the Ramp-High parameter. The display will show:



Ramp-HI = ON
<ENTER> to Select

Use the ENTER key to select the Ramp-HI mode, then press the \wedge or \vee key to advance the program to another test parameter or press the EXIT key to exit from the setting mode to the operation mode.

The Ramp-HI function is active during the Ramp period only. Ramp-HI will allow current higher than the normal HI-Limit current setting of the DC Withstand Voltage test to avoid false failure due to charging current.

4.6.11. Charge-LO setting (DC units only)

Advance the menu to the Charge-LO parameter. The display will show:



```
Charge-LO = 0.0 uA
<TEST> to Auto Set
```

The Charge-LO function is used to check if the test cables are connected properly at the beginning of a test. A capacitive DUT will draw charging current on the DC Withstand Voltage test when the Output is activated. If the charging current was lower than the setting, the test cables may not be connected properly.

The Charge-LO value can be set manually or automatically. To set the Charge-LO value manually, use the numeric keys to enter the Charge-LO current setting and then press the ENTER key. The program will store the Charge-LO setting and advance to the Ramp-HI parameter. The setting range of Charge-LO is from 0.0 to 350.0 μA . To use Auto Set, be sure that the test parameter of Output Voltage and Ramp Time have been set to the values that will be used for the Final test and connect the test cables and/or test fixture between the instrument and DUT. If the scanner is to be used then the scanner channel must also be set, and then press the TEST button. The instrument will apply the voltage that has been entered for this memory-step selection.

WARNING

Please be aware that the program will activate high voltage on the output connector while the Test button is pressed.

The program will read the charging current of DUT and set the Charge-LO current at approximately one half (1/2) of the reading. The display will show:



```
Charge-LO = 0.0 uA
<TEST> to Auto Set
```

The value showing on the display is the Charge-LO setting and is not the reading of the charging current of the DUT.

Then press the \wedge or \vee key to advance the program to another test parameter or press the EXIT key to exit from the setting mode to the operation mode.

4.6.12. Connect

Advance the menu to the Connect selection. The display will show:

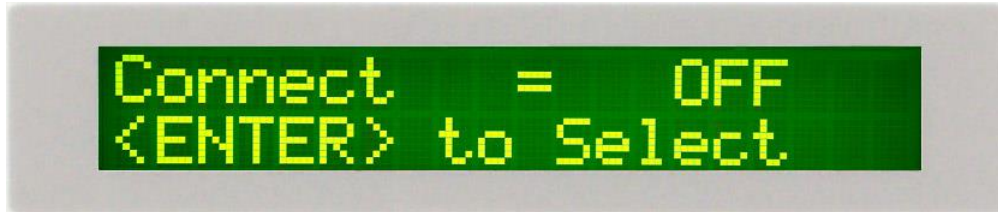

Use the ENTER key to toggle the Connect Mode ON and OFF.

This function when turned ON will connect or link the current memory to the next memory. This Allows HypotMAX to Run 50 consecutive tests in a sequence if desired.

5. OPERATING INSTRUCTIONS

5.1. Instrument Connections

Before the operation of this instrument, make sure that all Test Parameters have been set properly according to the Test Parameters Setup Procedures. Also, check the system setting of Remote Control, LCD Contrast, the Alarm Volume, and Fail Stop.

Be sure to connect the appropriate test leads to the device under test (DUT) or test fixture. Be sure to connect the safety ground (on the rear panel) to a suitable known good ground before energizing this instrument. Then connect the return lead first to the test fixture or the DUT followed by the high voltage lead.

Please check your connections to be sure they are making good contact. Clear the area of any debris that may create a hazardous situation and ask any unnecessary personnel to leave the area.

WARNING

DO NOT TOUCH THE DEVICE UNDER TEST, HIGH VOLTAGE TEST LEAD, ALLIGATOR CLIP, OR CLIP INSULATOR ONCE THE TEST HAS BEEN STARTED.

WARNING

DO NOT TOUCH THE FRONT PANEL WHEN TESTING OR AFTER A MALFUNCTION HAS OCCURRED.

This instrument is supplied with a high voltage test lead terminated with an alligator clip. This clip is designed to allow firm connection to the DUT without the need for an operator to hold a probe or lead in place during the test. This clip and insulator will carry the voltage and current of this tester but they are not intended to be held by the operator during the test while the high voltage is energized. Please insure that you do not make contact with the alligator clip or the clip insulator while high voltage is energized.

Interlock Connector

HypotMAX is equipped with a Remote Interlock feature. Remote Interlock utilizes a set of closed contacts to enable the instrument's output. If the Remote Interlock contacts are open the output of the instrument will be disabled. To disable the Remote Interlock feature connect the Interlock Key into the Signal Input port located on the back of the tester.



5.2. Settings Screen

The settings screen will show parameter settings of the test that will be performed and the memory location that they are stored in. This screen can be accessed after a test is Aborted or Passed by pressing the RESET button or after a test failure by pressing the RESET button twice. The following is an example of a Settings Screen for the 7720 before any test has been executed.

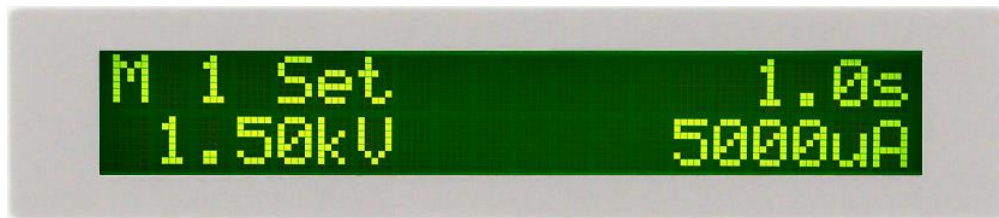

M XX:	Memory Program number
Set:	Withstand Voltage test setting screen
XXX.X s:	Dwell Time setting
X.XX KV:	Output Voltage setting
X.XXX mA:	High-Limit current setting (AC withstand instruments)
XXXX μ A:	High-Limit current setting (DC withstand instruments)

The Settings screen is the main operational screen of instrument. From this screen, test parameters are monitored while the test is being performed.

5.3. Performing a Test

1. From the Settings screen, press the MEMORY key and select the memory you wish to perform using the numeric keypad then press the ENTER key to return you to the Perform Test screen.
2. Attach the appropriate load or DUT to the instrument.

WARNING

DO NOT TOUCH THE DEVICE UNDER TEST, HIGH VOLTAGE TEST LEAD, ALLIGATOR CLIP, OR CLIP INSULATOR ONCE THE TEST HAS BEEN STARTED.

3. Press the TEST button.
4. The instrument will now perform the test or connected sequence of tests.

5.3.1. Discharge Function in DC units

The 7710 and 7720 units are equipped with a Discharge function that is designed to discharge the voltage of a capacitive DUT so that it may be safely disconnected from the test leads of the instrument. The discharge function monitors the voltage of the DUT and remains active until the voltage of the DUT falls below 40 volts. The instrument will also not allow another test to be executed until the voltage of the DUT falls below 40 volts. The discharge period will occur either directly after the Dwell time, if Ramp-DOWN is set to "0", or after the designated Ramp-DOWN time.

During the Discharge time, the display will show:



If the capacitance of the DUT is very small it is possible that you will not see this display due to the short amount of time required to discharge the DUT.

The voltage and time of discharging DUT will be displayed during the discharge period but this information is only intended for reference and cannot be reviewed after the end of the discharge period. The process signal of the remote I/O remains active during the discharge period and the high voltage lightning bolt indicator on the front panel of the instrument is also active during the discharge period.

As a safety precaution, if the RESET button is pressed during the discharge period, the instrument will log the RESET but will not discontinue the discharge function. Pressing the RESET during the discharge will only prevent a connected memory from executing after the discharge time.

The capacitance of the DUT should never exceed the maximum specification listed in this manual.

WARNING

DO NOT TOUCH THE DEVICE UNDER TEST, HIGH VOLTAGE TEST LEAD, ALLIGATOR CLIP, OR CLIP INSULATOR DURING THE DISCHARGE CYCLE.

5.3.2. Connected Memory indicator

The connected memory indicator is an underscore symbol located directly next to the Memory number and only will be displayed when the connect function has been turned ON in the Test parameters.

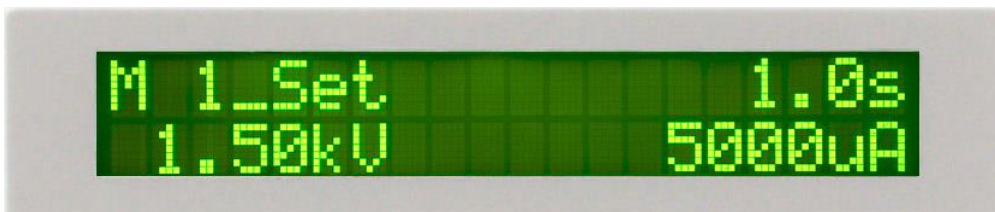

5.3.3. Manual Voltage Adjustment

When HYPOTMAX is performing a test, the \wedge and \vee keys may be used to adjust the output voltage.

Pressing the \wedge key will increase the output voltage, pressing the \vee key will decrease the output voltage. Manual voltage adjustment temporarily overrides the voltage setting and only remains in effect until the test is terminated by Pass, Fail, or Abort.

When the Lock parameter is selected ON in the system menu, manual voltage adjustment is disabled.

5.4. Reviewing Test Results

The method for reviewing test results is to press the ENTER key at the end of the test sequence. Results can be reviewed at any time before the next test is executed by pressing the ENTER key and then scrolling with the up and down arrow keys or repeatedly pressing the ENTER key. The results of the last test in the process will be followed by the first test when scrolling through the results. All buffers are cleared at the start of the next test cycle.

Pressing the EXIT or RESET key will return you to the Settings screen.

5.5. Test Messages

If the test in process is Aborted with the RESET button or remote control, the display will show:



If the test in process is Aborted with the RESET button or remote control before the meter readings are taken, the display will show:



At the beginning of AC Withstand Voltage test when the voltage begins to ramp but before the meter readings are taken, the display will show:



During the AC Withstand Voltage test when the values are being updated in real time during the ramp cycle, the display will show:



During the AC Withstand Voltage test when the values are being updated in real time during the dwell cycle, the display will show:



If the ramp time is very short and the program has not read the meter readings, the display will show:



If the DUT current exceeds the HI-Limit of AC Withstand Voltage test and the leakage current is within the metering range, the display will show:



If the DUT current exceeds the HI-Limit of AC Withstand Voltage test and the leakage current is not within the metering range, the display will show:



M 1 HI-Limit 0.3s
0.96kV >5000uA

If the DUT current is well beyond the metering range of AC Withstand Voltage test the instrument assumes that the failure is due to a short circuit, the display will show:



M 1 Short 0.0s
--.--kV >5000uA

If the DUT current is well beyond the metering range of AC Withstand Voltage test and an Arcing condition beyond the Arc Sense limit is indicated, the display will show:



M 1 BreakDown 0.0s
--.--kV >5000uA

If the DUT current falls below the LO-Limit of AC Withstand Voltage test, the display will show:



M 1 LO-Limit 0.0s
1.45kV 74.2uA

If the DUT current is within the metering range of the AC Withstand Voltage test and an Arcing current exceeds the Arc-Sense limit and the Arc function is set to ON, then an Arc failure has occurred and the display will show:



M 1 Arc-Fail 5.2s
1.50kV 3.3uA

If a Ramp-DOWN time has been set and the dwell portion of the test is complete the display will show:



M 1 Ramp-DOWN 3.8s
1.49kV 0.0uA

If the DUT has passed the DC Withstand Voltage test and the test process is complete the display will show:



M 1 Pass 5.0s
5.00kV 249.6uA

5.6. Additional Messages for DC units

If the Ramp-HI function is enabled and the leakage current during the Ramp cycle exceeds 9.999mA for the model 7710 or 5mA for the model 7720, then the display will show:



M 1 Ramp-HI 5.2s
0.26kV >5000uA

If the leakage current during the Ramp cycle falls below the Charge -LO setting, then the display will show:



M 1 Charge-LO 0.3s
0.14kV 9.0uA

When running capacitive DUTs the instrument will discharge the DUT at the end of the Dwell or Ramp-DOWN cycle depending on the test settings. The display will show the following screen during the discharge cycle:



M 1 Discharge 6.5s
0.11kV

If the capacitance of the DUT is very small it is possible that you will not see this display due to the short amount of time required to discharge the DUT.

5.7. BUS Remote Message

The REM indicator will be displayed when the instrument is in the Remote Control mode. When the BUS Remote is on the instrument is able to send and receive signals across the GPIB IEEE-488 or USB/RS-232 bus.



M 1 Set 1.0s
1.50kV REM 5000uA

5.8. Fatal Error

The only active button or key in this situation is the RESET button. The only reason the RESET button is active is to allow you to silence the alarm and open the fail relay. This type of failure permanently locks the instrument in the “Fatal Error” mode and requires that the instrument be serviced by Associated Research. The customer should contact Associated Research, Inc to receive further instruction. An example of the Fatal Error screen appears as follows:



FATAL ERROR 9002
Call 1-800-858-8378



FATAL ERROR 9003
Call 1-800-858-8378

The following Fatal Error identification numbers will represent type of the failure that has occurred:

Error Code 9002 will appear on the display, if the instrument's System data or the

Model/Option/Serial Number data are corrupted and do not match the settings.

Error Code 9003 will appear on the display, if the instrument's Calibration data is corrupted.

5.9. Output Error

If the instrument has an internal problem and the TEST button is pressed, the Output Error screen will appear as follows:



The RESET button is not active while this screen is displayed. To clear this screen and return to test mode the EXIT key must be pressed. When the EXIT key is pressed, the instrument will continue with its normal failure indication process. The failure light and Alarm can then be cleared by pressing the RESET button. This message appears on the display after exiting from the Output Error screen.



If this error message appears please call Associated Research, Inc. immediately at 1-800-858-TEST (8378).

6. CONNECTION OF REMOTE I/O

Two 9-pin “D” type connectors are mounted on the rear panel and provide REMOTE-INPUT-OUTPUT control and information. These connectors mate with standard 9 pin D-sub-miniature connector provided by the user. The output mates to a male (plug) connector while the input mates to a female (receptacle) connector. For best performance, a shielded cable should be used. To avoid ground loops the shield should not be grounded at both ends of the cable. Suggested AMP part numbers for interconnecting to the Remote I/O are shown below:

205204-4	PLUG SHELL WITH GROUND INDENTS
205203-3	RECEPTACLE SHELL
745254-7	CRIMP SNAP-IN PIN CONTACT (for plug)
745253-7	CRIMP SNAP-IN SOCKET CONTACT (for receptacle)
745171-1	SHIELDED CABLE CLAMP (for either plug or receptacle)
747784-3	JACKSCREW SET (2)

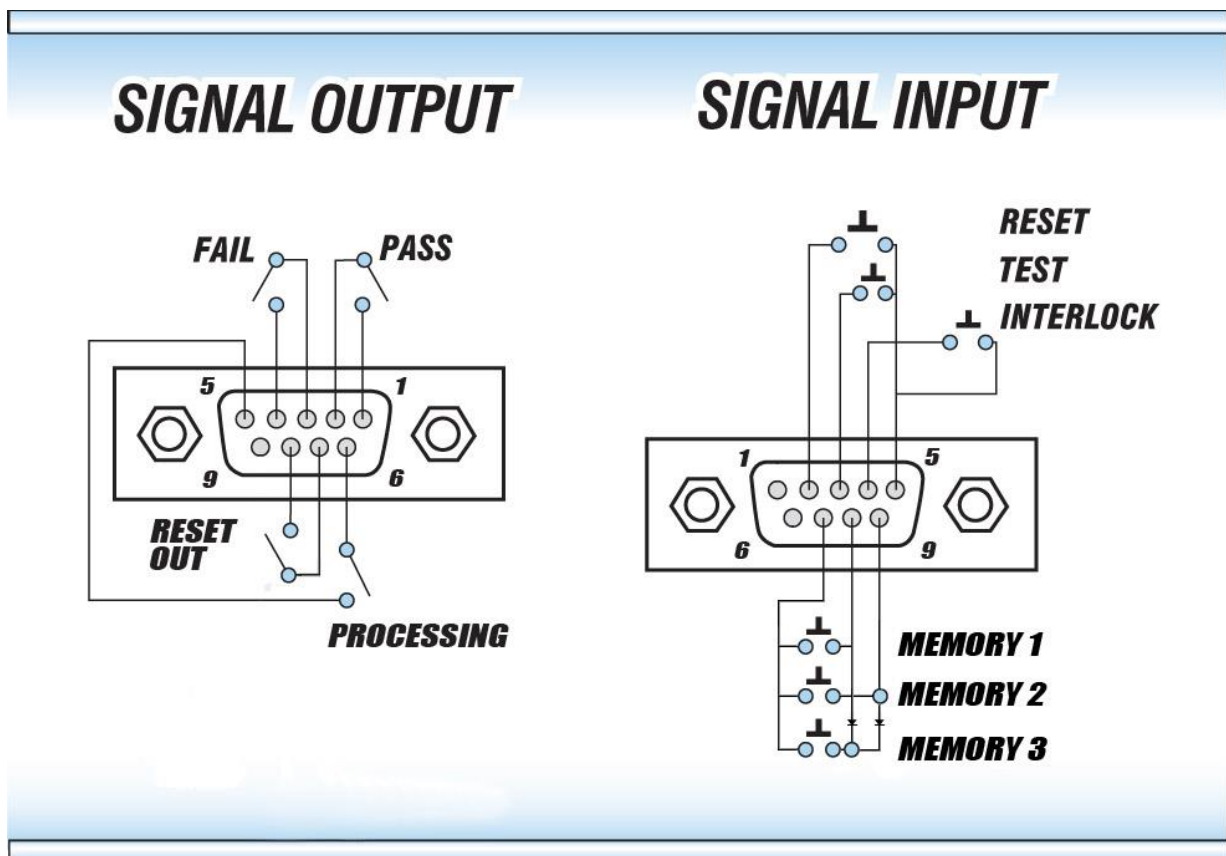

6.1. Signal Outputs on Remote I/O

The rear panel connector provides three output signals to remotely monitor PASS, FAIL, and PROCESSING conditions. The monitoring signals are provided by three normally open internal relays that toggle on and off to indicate the condition of the tester. These are normally open free contacts and will not provide any voltage or

current. The ratings of the contacts are 1 AAC / 125 VAC (0.5 ADC / 30 VDC). The signal outputs are provided on the 9-pin female D connector. Below is a listing that indicates what conditions activate each pin. When a terminal becomes active, the relay closes thereby allowing the external voltage to operate an external device.

Pins 1 and 2 provide the PASS signal.
Pins 3 and 4 provide the FAIL signal.
Pins 5 and 6 provide the PROCESSING signal.

The following describes how the relays operate for each test condition:

PROCESSING – The relay contact closes the connection between pin (5) and pin (6) while the instrument is performing a test. The connection is opened at the end of the test. The process contact is closed all the way through to the end of the discharge cycle in DC units.

PASS – The relay contact closes the connection between pin (1) and pin (2) after detecting that the item under test passed all tests. The connection is opened when the next test is initiated or the reset function is activated.

FAIL – The relay contact closes the connection between pin (3) and pin (4) after detecting that the item under test failed. The connection will open when the next test is initiated or the reset function activated.

6.2. Signal Inputs of Remote I/O and Memory Access

The HypotMAX remote connector enables remote operation of the TEST, RESET, and REMOTE INTERLOCK functions, and allows the operator to select Memory 1, Memory 2, and Memory 3.

When the PLC Remote mode is on, the HypotMAX will respond to simple switch or relay contacts closures. A normally open momentary switch can be wired across pins 3 and 5 to allow remote operation of the TEST function. A minimum pulse width or contact closure of 20mS is required to guarantee a test start. A normally open momentary switch can be wired across pins 2 and 5 to allow remote operation of the RESET function. A minimum pulse width or contact closure of 50mS is required to guarantee that a running test will abort. When the PLC remote function is (ON) the TEST switch on the front panel will be disabled to prevent a test from being activated through this switch. For safety, the front panel RESET switch remains active even when a remote reset switch is connected so that high voltage can be shut down from either location.

DID YOU KNOW?

The Remote Signal Input connector may be used with various accessories, including light curtains, foot switches, and safety probes. Contact Associated Research, Inc. for more information.

The HypotMAX also allow access to three MEMORY PROGRAMS through the remote control connector. This gives the user the capability to quickly change parameters and initiate a test remotely. The built in memory programs of the instrument are used to accomplish this. Three internal memory programs can be accessed, by connecting terminals 7, 8, and 9 in different combinations. The memory select lines should be set simultaneously and remain set for a minimum of 20ms to guarantee that the correct memory will be selected. However, the memory select bits may be set in sequential manner, provided that the time delay between each bit is less than 4ms. When the desired bit pattern has been established it should remain set for a minimum of 20ms to guarantee that the correct memory will be selected. It may be necessary to "OR" the momentary switches (relay contacts) to prevent incorrect program selection due to timing errors.

WARNING

THAT MEMORY

ACTIVATING MEMORY PROGRAM FUNCTIONS THROUGH THE REMOTE CONNECTOR, SELECTS THE PROGRAM AND STARTS THE TEST WHICH IS PREPROGRAMMED INTO

CAUTION

DO NOT CONNECT VOLTAGE OR CURRENT TO THE SIGNAL INPUTS, THIS COULD RESULT IN DAMAGE TO THE CONTROL CIRCUITRY.

MEMORY ONE – Momentarily connecting terminal 7 to 8 signals the instrument to immediately begin the test program that is stored in memory one.

MEMORY TWO – Momentarily connecting terminal 7 to 9 signals the instrument to immediately begin the test program that is stored in memory two.

MEMORY THREE – Momentarily connecting terminal 7 to terminals 8 and 9 signals the instrument to immediately begin the test program that is stored in memory three.

Remote Interlock

HypotMAX is equipped with a Remote Interlock feature. Remote Interlock utilizes a set of closed contacts to enable the instrument's output. If the Remote Interlock contacts are open the output of the instrument will be disabled. Remote Interlock could also be referred to as a remote system lockout, utilizing "fail when open" logic. If the Remote Interlock contacts are open and the TEST button is pushed, a pop-up message will be displayed on the screen for two seconds. The message will appear as follows:



Interlock is Open

If the Remote Interlock contacts are opened during a test, the pop-up message will be displayed and the test will abort. The hardware has been configured to provide the interlock connections on pins 4 and 5 of the Remote Interface, Signal Input port. The instrument can still be used without the external interlock device as long as the Interlock Disable Key (38075 provided with unit) is plugged into the Remote Interface, Signal Input port. If there is nothing connected to the Remote Interface, Signal Input port to provide a connection to the Remote Interlock, the instrument will not perform tests.



PLC Remote Pop-up message

If you attempt to start a test from the front panel Test button and the PLC remote function is turned ON, a pop-up message will be displayed. The pop-up message will appear as follows:



7. BUS REMOTE INTERFACE USB/RS-232/GPIB

This section provides information on the proper use and configuration of the bus remote interface. The USB/RS-232 remote interface is standard on the HypotMAX but the GPIB (IEEE-488) interface option can be substituted for the USB/RS-232 interface. Please refer to section **8.0. Options** for details on the HypotMAX options. The USB/RS-232 interface uses the same command set as the GPIB interface for setting test parameters; however, many functions of the GPIB 488.2 interface are not available through USB/RS-232. The IEEE-488 interface included with the HypotMAX conforms to the requirements of the IEEE-488.2 standard.

The USB/RS-232 interface card requires the user to download a driver in order for the instrument to recognize the USB interface. The driver can be found on the Associated Research, Inc. website:

<http://www.asresearch.com/products/software/USB-driver.aspx>

Click on “USB/RS-232 Driver” to download the driver. This link contains an automatic extract and install program. Follow the instructions of the installation program to initialize the driver install. NOTE: The USB port acts as a USB to RS-232 converter. As a result, the PC will recognize the USB port as a virtual COM port.

7.1. USB / RS-232 Interface

This interface provides all of the control commands and parameter setting commands of the GPIB interface with the exception of some of the 488.2 Common Commands and SRQ capability. All commands can be found in section **7.4. USB/RS-232/GPIB Command List**. The identification command *IDN and the Status Reporting commands are also available through USB/RS-232.

7.1.1. RS-232 Connector

The RS-232 cabling should be configured as follows for a 9-pin serial port interface:

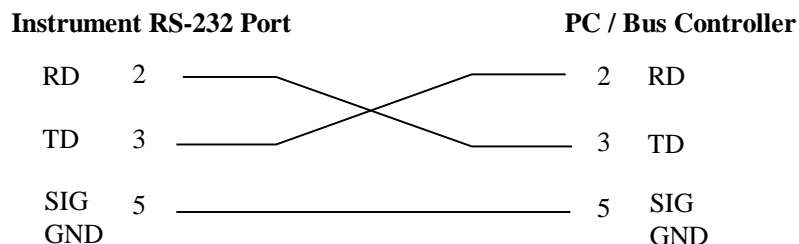

7.1.2. Communications Port Configuration

The COM port should have the following configuration:

- 9600 baud
- 8 data bits
- 1 stop bit

- No parity

This interface does not support XON/XOFF protocol or any hardware handshaking. The controller should be configured to ignore the handshaking lines DTR (pin 4), DSR (pin 6) CTS (pin 8) and RTS (pin 7). If the port cannot be configured through software to ignore these lines the handshake lines should be jumpered together in two different sets. Pins 4 and 6 should be jumpered together and pins 7 and 8 should be jumpered together at the controller end of the cable.

7.1.3. Sending and Receiving Commands

Sending Data

Once a command is sent to the instrument over the USB/RS-232 bus the instrument will send one of two responses. If the transfer was recognized and completed the instrument will return with 06 hex or 6 decimal, the Acknowledge (ACK) ASCII control code. If there is an error with the command string that is sent, the instrument will respond with 15 hex or 21 decimal, the Not Acknowledge (NAK) ASCII control code. The ACK or NAK response allows for software handshaking to monitor and control data flow.

Receiving Data

When requesting data from the instrument it will automatically send the data back to the controller input buffer. The controller input buffer will accumulate data being sent from the instrument, including the ACK and NAK response strings, until it has been read by the controller.

7.2. GPIB Interface

This interface is optional on the HypotMAX and provides all of the control commands and parameter setting commands of the USB/RS-232 interface along with 488.2 Common Commands and SRQ capability. All commands can be found in section **7.4. USB/RS-232/GPIB Command List**.

7.2.1. GPIB Connector

Connection is usually accomplished with a 24-conductor cable with a plug on one end and a connector at the other end. Devices may be connected in a linear, star or a combination configuration.

The standard connector is the Amphenol or Cinch Series 57 Microribbon or AMP CHAMP type. The GPIB uses negative logic with standard transistor-transistor logic (TTL) levels. When DAV is true, for example, it is a TTL low level (≤ 0.8 V), and when DAV is false, it is a TTL high level (≥ 2.0 V).

Restrictions and Limitations on the GPIB

- A maximum separation of 4 m between any two devices and an average separation of 2 m over the entire bus.
- A maximum total cable length of 20 m.

- No more than 15 device loads connected to each bus, with no less than two-thirds powered on. For example 1 GPIB controller and a maximum of 14 GPIB instruments.
- **NOTE:** A bus extender, which is available from numerous manufacturers, is available to overcome these limitations.

7.2.2. GPIB Address

Each device on the GPIB (IEEE-488) interface must have a unique address. You can set the address of the HypotMAX to any value between 0 and 30. The address can only be set from the front panel. The address is stored in non-volatile memory and does not change when the power has been off or after a remote reset.

- **The address is set to 8 when the instrument is shipped from the factory.**

7.3. Interface Functions

The capability of a device connected to the bus is specified by its interface functions. These functions provide the means for a device to receive, process, and send messages over the bus. The interface functions are listed in the chart below.

GPIB 488.1 INTERFACE FUNCTIONS

INTERFACE FUNCTION	SUBSET	DESCRIPTION
Source Handshake	SH1	Complete Source handshake capability
Acceptor Handshake	AH1	Complete Acceptor handshake capability
Talker	T6	Talker functions (unaddress if MLA)
Listener	L4	Listener functions (unaddress if MTA)
Service Request	SR1	Complete Service request capability
Remote Local	RL0	No remote/local capability
Parallel Poll	PP0	No parallel poll capability
Device Clear	DC1	Complete Device clear capability
Device Trigger	DT0	No device trigger capability
Controller	C0	No controller capability
Electrical Interface	E2	Three-state drivers

Controllable Items	Test and Reset control.
	Setting of test parameters for tests.
	Reading of instrument status and test results.
Data Codes	ASCII
Delimiter	NL (+ EOI)

7.4. USB / RS-232 / GPIB Interface Command List

Echo and Response Considerations

USB/RS-232 Responses

The USB/RS-232 bus will automatically send any response back to the controller's input buffer.

GPIB Queries and Responses

The HypotMAX GPIB bus will not send any data to the controller without being queried. A GPIB read command must be sent after a command string to retrieve any data from a query command (?).

7.4.1. Rules for Sending Commands to the Instrument

The following conventions are used to describe the commands syntax for HypotMAX:

- Braces ({ }) enclose each parameter for a command string.
- Triangle brackets (< >) indicate that you must substitute a value for the enclosed parameter.
- The Pipe (|) is used to separate different parameter options for a command.
- The command and the parameter data must be separated with a space.
- Each command string should be terminated by the ASCII control code, New Line (NL), (OAh) or the end of line (EOL) message for GPIB.
- All commands that end with a question mark (?) are query commands and required an IEEE-488 read command to retrieve the data from the device's output buffer.

7.4.2. Test Execution Commands

The following commands are used to control actual output voltage and current from the instrument. Please observe all safety precautions.

COMMAND	DESCRIPTION
TEST	Execute a Test
RESET	Abort a test in Process or Reset Failures
SAO	Set Auto-Offset
SACG	Set Auto-Charge-LO

TEST

Starts the test sequence at the selected step loaded into memory (RAM).

RESET

Stop or abort a test. Also used to reset a latched failure condition.

SAO

Set the offset for the Continuity test. The cables and any test fixture should be connected before executing the command. This command will perform an actual test and all safety precautions should be observed when using this command.

SACG

Set the Charge-LO parameter for the DCW or IR test. The cables and any test fixture should be connected before executing the command. The test parameters that are set for the step will be used when performing the auto setting. This command will perform an actual test and all safety precautions should be observed when using this command.

7.4.3. File Editing Commands

The following commands are used to create or modify Test Setup Files.

COMMAND	DESCRIPTION	VALUE
FL <memory number>	File Load	memory number = 1-50
ADD <test,p1,p2,p3...>	Add all parameters of a test	
SF {1 0}	Fail Stop	1=On, 0=Off

FL <memory number>

Load a file by memory number from non-volatile memory into random access memory RAM.

ADD <test,p1,p2,p3...>

This command edits all parameters in a memory location. Parameters will be edited at the memory location that has been selected.

The parameter <test> indicates the test type. The test type values ACW or DCW must be used. The parameters <p1,p2> etc. indicate the individual settings for each test. All parameters must be included with the command and should appear in the same order that is shown in the table below. Also, like the individual parameter editing commands, the unit should not be included with the value. Only the numeric value should be included in the command string. The list of parameters can also be found in the default parameters section of the manual, or refer to the Test Parameter Editing commands section for the proper values.

The parameter values should use complete text and not use the coded values that are associated with the individual parameter setting commands such as "ON" and "OFF". The LS? companion command will also list all parameters in complete text in the order as they appear in the following table, preceded by the memory number.

ACW	DCW
-----	-----

1	Voltage	Voltage
2	HI-Limit	HI-Limit
3	LO-Limit	LO-Limit
4	Ramp Up	Ramp Up
5	Dwell Unit	Dwell Unit
6	Dwell Time	Dwell Time
7	Ramp Down	Ramp Down
8	Frequency (50/60)	Arc Detect (ON/OFF)
9	Arc Detect (ON/OFF)	Arc Sense
10	Arc Sense	Ramp-HI (ON/OFF)
11	Connect (ON/OFF)	Charge-LO
12		Connect (ON/OFF)

7.4.4. Test Parameter Editing Commands and Companion Queries

These commands are used to modify the test parameter within each memory. These commands require a parameter value to be included with the command. The companion query command will read the parameter. The writing of the parameter requires that the unit not be included with the value, only the numeric value should be included with the command. Also, when the query commands are used the response will not include the unit's characters. Many of the commands will function the same way for multiple test types; however, the input range may be different and therefore used a different possible set of values.

COMMAND	NAME	TEST TYPES	VALUE
EA < value > EA?	Edit Arc	ACW DCW	1 – 9
EAD {1 0} EAD?	Edit Arc-Detect	ACW DCW	1= On, 0=Off
ECC {1 0} ECC?	Edit Connect	ACW DCW	1= On, 0=Off
ECG < value > ECG?	Edit Charge-Lo	DCW	0.0 - 350.0uA
EDW < value > EDW?	Edit Dwell	ACW DCW	0, 0.3 - 999.9s (7705, 7715) 0, 0.4 - 999.9s (7710,7720) 0, 0.1 - 999.9m
EF {1 0} EF?	Edit Frequency	ACW	1=60Hz, 0=50Hz
EH < value > EH?	Edit HI-Limit	ACW DCW	0.000 – 9.999mA (7715, 7705)
EL < value > EL?	Edit LO-Limit		10.00 - 20.00mA (7705) 0.0 – 999.9 uA (7710, 7720) 1000 – 9999uA(7710) 1000 - 5000uA (7720)

COMMAND	NAME	TEST TYPES	VALUE
ERD <value > ERD?	Edit Ramp-DOWN	ACW DCW	0.0 - 999.9s (7705, 7715) 0, 1.0 - 999.9s (7710, 7720)
ERH {1 0} ERH?	Edit Ramp-HI	DCW	1= On, 0=Off
ERU < value> ERU?	Edit Ramp-UP	ACW DCW	0.1 - 999.9s (7705) 0.3 - 999.9s (7715) 0.4 - 999.9s (7710, 7720)
EV <value> EV?	Edit Voltage	ACW DCW	0 - 10.00kV (7705) 0 - 12.00kV (7710) 0 - 20.00kV (7715) 0 - 20.00kV (7720)

7.4.5. System Parameter Editing Commands and Companion Queries

These commands are used to modify the system parameters for the instrument. These commands require a parameter value to be included with the command. The companion query command will read the parameter using the same value that is used for setting the parameter.

COMMAND	NAME	VALUE
SPR {1 0} SPR?	PLC Remote	1= On, 0=Off
SF {1 0} SF?	Fail Stop	1= On, 0=Off
SAL < value > SAL?	Alarm Volume	0 - 9
SC < value > SC?	Contrast	1 - 9
SL {1 0} SL?	Lock	1= On, 0=Off
SML {1 0} SML?	Memory Lock	1= On, 0=Off
SSG {1 0} SSG?	Smart GFI	1= On, 0=Off
SD1 < value > SD1?	Device ID	0 - 9999999
SD2 {1 0} SD2?	Device ID	1= On, 0=Off
SPM {2 1 0} SPM?	Print Mode	0=AUTO, 1=MANUAL, 2=OFF
SPRE {1 0} SPRE?	Prn Result n	1=FAIL, 0=ALL
SPS {1 0} SPS?	Prn Setting n	1= On, 0=Off

COMMAND	NAME	VALUE
SFF {1 0} SFF?	Form Feed n	1= On, 0=Off

7.4.6. Query Commands

These query commands will retrieve data from the instrument. The GPIB bus application requires an IEEE-488 read command to be sent after the query command. These commands include functions for retrieving test data, test results and remote hardware status as well as setup file information.

COMMAND	NAME	VALUE
TD?	List Testing Data	Test In Process
RD <memory number>?	List Results Data	memory number = 1-50
RR?	Read Remote Reset	1=Open, 0=Closed
RI?	Read Remote Interlock	1=Open, 0=Closed
LS?	List Memory Parameters	
LS <memory number>?	List Memory Parameters by memory number	memory number = 1-50

TD?

Read the active data being displayed on the LCD display while the test is in process. It will also read the last data taken when the test sequence has completed. Each parameter is separated by commas and includes memory number, test type, test status, and metering. The syntax for this command response is {memory, test type, status, kV meter, mA meter, dwell time}. Each meter will contain only the value and not the units. In the case of DCW current where both uA and mA are used on the display, the command response will always indicate the current in uA for example 2.0mA will respond with 2000 for 2000uA.

RD <memory number>?

Read the results for an individual memory. The memory number is the actual memory number that has been saved within the file, not the order of which the memories were executed. For example if the test was executed starting from memory 3 and ending with memory 5 then the first test results will be found in location 3 not in location 1. Each parameter is separated by commas and includes memory number, test type, test status, and metering. The syntax for this command response is {memory, test type, status, kV meter, mA meter, dwell time}. Each meter will contain only the value and not the units. In the case of DCW current where both uA and mA are used on the display the command response will always indicate the current in uA for example 2.0mA will respond with 2000 for 2000uA.

RR?

Read the remote Reset input signal. When the remote reset has been activated by closing the contacts the query will return a value of 1 to indicate the instrument is being Reset.

RI?

Read the remote Interlock input signal. When the remote Interlock has been activated by opening the contacts the query will return a value of 0 to indicate the instrument is in the Interlock state and will not be able to generate output voltage or current.

LS?

Lists all the Parameters for the individual memory that is currently selected. See the ADD command for the list of parameters. A comma (,) will separate each parameter and will be preceded with the memory number.

LS <memory number>?

Lists all the Parameters for the individual memory indicated by *memory number* = 1-50. See the ADD command for the list of parameters. A comma (,) will separate each parameter and will be preceded with the memory number.

7.4.7. IEEE 488.2 Common Commands

These commands are required by the IEEE-488.2 standard with the exception of *PSC, *PSC?. Most of these commands are not available over the USB/RS-232 bus except for the *IDN? command which can be used to retrieve the instrument identification information, and the four status reporting commands *ESR?, *ESE, *ESE? and *STB?

COMMAND	NAME	DESCRIPTION
*IDN?	Identification Query	Associated Research Inc., Model Number, Serial Number, Firmware Revision
*RST	Reset Command	Resets HypotMAX
*TST?	Self-Test Query	00H=OK 01H=TEST EEPROM ERROR
*CLS	Clear Status Command	Clear Standard Event Status Register Clear Service Request Register
*OPC	Operation Complete Command	When all selected pending operations complete, ESR BIT0=1
*OPC?	Operation Complete Query	When all selected pending operations complete, Output Queue=1
*WAI	Wait-to-Continue Command	
*PSC {1 0}	Power-on Status Clear Command	1 = Power-on clear enable

COMMAND	NAME	DESCRIPTION
		registers 0 = Power-on load previous enable registers
*PSC?	Power-on Status Clear Query	
*ESR?	Standard Event Status Register Query	0 - 255
*ESE <value>	Standard Event Status Enable Command	value = 0 - 255
*ESE?	Standard Event Status Enable Query	0 - 255
*STB?	Read Status Byte Query	Read Status Byte
*SRE <value>	Service Request Enable Command	value = 0 - 255
*SRE?	Service Request Enable Query	0 - 255

*IDN?

Read the instrument identification string. Company =Associated Research Inc.

*RST

Reset the instrument to original power on configuration. Does not clear Enable register for Standard Summary Status or Standard Event Registers. Does not clear the output queue. Does not clear the power-on-status-clear flag.

*TST?

Performs a self-test of the instrument data memory. Returns 0 if it is successful or 1 if the test fails.

*CLS

Clears the Status Byte summary register and event registers. Does not clear the Enable registers.

*OPC

Sets the operation complete bit (bit 0) in the Standard Event register after a command is completed successfully.

*OPC?

Returns an ASCII "1" after the command is executed.

*WAI

After the command is executed, it prevents the instrument from executing any further query or commands until the no-operation-pending flag is TRUE.

***PSC {1|0}**

Sets the power-on status clear bit. When set to 1 the Standard Event Enable register and Status Byte Enable registers will be cleared when power is turned ON. 0 setting indicates the Enable registers will be loaded with Enable register masks from non-volatile memory at power ON.

***PSC?**

Queries the power-on status clear setting. Returns 0 or 1.

***ESR?**

Queries the Standard Event register. Returns the decimal value of the binary-weighted sum of bits.

***ESE <value>**

Standard Event enable register controls which bits will be logically OR'd together to generate the Event Summary bit 5 (ESB) within the Status Byte.

***ESE?**

Queries the Standard Event enable register. Returns the decimal value of the binary-weighted sum of bits.

***STB?**

Read the Status Byte. Returns the decimal value of the binary-weighted sum of bits.

***SRE <value>**

Service Request enable register controls which bits from the Status Byte should be use to generate a service request when the bit value = 1.

***SRE?**

Queries the Service Request enable register. Returns the decimal value of binary-weighted sum of bits.

7.4.8. Status Reporting

Status reporting system is configured using two types of registers. An Event Register and a Summary register. The summary register is known as the Status Byte register and records high-level summary information acquired by the event registers.

An Event register reports defined conditions or messages at each bit. The bits are latched and remain at an active state until the register is either Read or Cleared. Reading the event register automatically clears the register and sets all bits to inactive state or 0. When querying an event register the information is returned as a decimal number representing the binary-weighted sum of all bits within the register.

The Enable registers bits represent the selection of bits that will be logically-ORed together to form the summary bit in the status byte. The *CLS command will not clear the enable registers and if you wish to clear the register you must set it to a value of 0. Like the event register, the enable register is represented as a decimal number that equals the binary-weighted sum of all bits.

The enable register will clear to value of 0 at power up unless the *PSC 0 command had been executed before power-off. The *PSC command tells the device whether or not it should clear the enable registers at power-on. Using this command will allow SRQs to function immediately after power-on.

		STANDARD EVENT REGISTER		STATUS BYTE REGISTER	
Bit	Binary weight	Event Register	Enable Register	Summary Register	Enable Register
0	1	Operation Complete		ALL PASS	
1	2	not used		FAIL	
2	4	Query Error		ABORT	
3	8	Device Error		TEST IN PROCESS	
4	16	Execution Error		Message Available (MAV)	
5	32	Command Error		Event Summary Bit (ESB)	
6	64	not used		Request Service (RQS) or Master Summary Status (MSS)	not used
7	128	Power On		not used	

*ESR?

*ESE

*STB? | SPOLL

*SRE

*ESE?

*SRE?

7.4.9. GPIB Service Request

The service request capability is not available with the USB/RS-232 interface. The SRQ line will be activated only after one or more of the service request functions have been enabled using the Status Byte Enable Register command *SRE.

The status byte bit assignments are as described in the previous section for status reporting. When the instrument has requested service, the enabled bit or bits and the RQS bit 6 will be active or 1. Bit 4, 5, and 7 are not used and will be set to false, or 0 for all status byte reads.

After the serial poll (SPOLL) is executed the RQS bit will be cleared to 0, and the remaining bits will remain unchanged. The status byte, ESB bit will not change value until the event register is read and cleared for the corresponding status byte bit.

For example after the All Pass SRQ has been enabled, when the test(s) have finished with pass indications the instrument will set the hardware SRQ line and output the

status byte of 41 hex. This means that bit 6 and bit 0 are set to a value of 1. After reading the status byte the status byte value will change to 01 hex.

7.5. Non Volatile Memory

The instrument saves each parameter in non-volatile memory when the parameters are sent to the instrument. The non-volatile memory has a limited write cycle life, therefore for programmers who wish to send all parameters before executing each test, should use Memory 50. The parameters will be stored in the CPU's Random Access Memory (RAM) until another memory location is selected. However, settings written to RAM from USB/GPIB/RS-232 mode will be lost when power is shut down. Parameter changes to RAM are unlimited and will not affect the life of the internal non-volatile memory chip.

7.6. BUS Remote message

The REM indicator will be displayed when the instrument is in the Remote Control mode. When the BUS Remote is on the instrument is able to send and receive signals across the GPIB IEEE-488 or USB/RS-232 bus.



FOR MORE INFORMATION ON IEEE (GPIB) PLEASE CONTACT

The Institute of Electrical and Electronic Engineers, Inc.
345 East 47th Street,
New York, NY 10017
☎ 1-212-705-7018 (Communications Society of IEEE)
Internet: www.ieee.org

8. OPTIONS

Introduction

This section contains a list and descriptions of available factory installed options at the time of this printing. The list of options contains an option code number that can be referenced on the data plate on the rear panel of the unit.

Option Label

On the rear panel of the instrument, you will find a label that contains the option code.

For example, your options code would appear as follows:

Fitted with option 01..... OPT: 01
 Fitted with option 01 and 08..... OPT: 0108

HypotMAX Options

Option List

CODE	DESCRIPTION
01	GPIB Card
02	Printer Port (Discontinued)

01 GPIB Card

This option may be substituted for the USB/RS232 interface. This option provides all of the function control of the USB/RS232 interface with the addition of SRQ functions. All commands can be found in section 7.0. Bus Remote Interface USB/RS-232/GPIB of this manual.

02 Printer Port Option (Discontinued)

This option allows the instrument to generate hardcopy printout of the test results. The printout can be configured to print automatically with each test, or manually by pressing a front panel key. There is also capability to enter a serial number identifier to each test that increments automatically after each test is performed. The test can be further configured to print only results from tests that have failed or to print all test results from every test performed.

The Printer Port is a parallel interface and should be compatible with most parallel printers. The printer port output uses simple ASCII characters and control codes. Simply connect the printer to the instrument and configure the printer output using the Setup menu. The following sections describe the setup procedures for configuring the printer output.

Auto Print

Please press the SETUP key to enter the Setup menu. Press the SETUP key six more times to scroll to the Auto Print selection the screen will show:



AUTO Print = ON
<ENTER> to Select

To configure Autoprinting press the ENTER key to change the selection. When Auto Print = ON the printer output will generate data every time the test has completed, and will also enable two other menus to configure the Print Mode and the Print Number. When Auto Print = OFF the user must press the EXIT/PRINT key on the lower center section of the keypad to generate printer output.

When the EXIT/PRINT key is pressed after the test is completed the printer output will be a duplicate of the front panel LCD test results. This key should only be used to retrieve test results after the test has been completed. Although the output will print the LCD screen during a test, the actual elapsed test time may be effected when printing while the test is active.

Print Mode

Please press the SETUP key. This menu selection works in conjunction with Auto Print. The Print Mode screen appears as follows:



Print Mode = All
<ENTER> to Select

The printer output will generate the 40 character LCD display test results when the test is complete. This selection will determine when the 40-character output will print. When Print Mode = All the printer output will print the test results from every test performed. When Print Mode = Fail only the test that have failed will be printed. The Print Number or Serial number will print for every test, followed by the appropriate test results depending on the Print Mode that has been selected.

Print Number

Please press the SETUP key. This menu selection works in conjunction with Auto Print. The Print Number screen appears as follows:



The print number is used to identify each test result. The number can be set to match the exact serial number or some portion of actual serial number of the item under test or just used as an identifier or tracking number. Type in the desired starting number in the range from 0 -9999. This number will increment as each test is performed. The next number that will be used can be viewed from this menu at any time after a test has been completed. This number is not save as part of the non-volatile memory setup parameters. Therefore each time the power to the instrument is turned off, the number will be reset to 0.

Form Feed

Please press the SETUP key. The Form Feed screen appears as follows:



This command forces a form feed after each complete test sequence. When the form feed is turned off the pages will break whenever the page is determined to be full by the printer.

9. CALIBRATION

DID YOU KNOW?

This instrument has been fully calibrated at the factory in accordance to our published specifications and with standards traceable to the National Institute of Standards & Technology (NIST).

You will find in this manual a copy of the "Certificate of Calibration". It is recommended that you have this instrument recertified at least once per year. Associated Research, Inc. recommends you use "Calibration Standards" that are NIST traceable or traceable to agencies recognized by NIST to keep this instrument within published specifications. Unless necessary, do not recalibrate the instrument within the first 12 months.

End user metrology standards or practices may vary. These metrology standards determine the measurement uncertainty ratio of the calibration standards being used. Calibration adjustments can only be made in the Calibration mode and calibration checks or verifications can only be made while operating in Test mode.

- **NOTE:** Verification should be performed before and after calibration. Calibration effects will only be noticeable after exiting calibration mode.

9.1. Warranty Requirements

Associated Research, Inc. offers a standard three-year manufacturer's warranty. This warranty can be extended an additional two years provided that the instrument is returned each year to Associated Research, Inc. for its annual recertification. In order to be eligible for the extended warranty instruments must be returned to Associated Research, Inc. for certification service at least once every twelve months.

A return material authorization number (RMA) must be obtained from Associated Research, Inc. before returning this instrument for calibration. To obtain an RMA number or for information regarding our warranty, please contact our customer support representatives at 1-800-858-TEST (8378) or setup an RMA online at <http://www.asresearch.com/support/RMA-request.aspx>.

Required Calibration Equipment

- 0 - 10 kV RMS AC and DC Voltage Divider. Voltage divider must handle 14.14kV peak.
- 7705, 20mA AC Ammeter.
- 7715, 10 mA AC Ammeter.
- 7710, 10mA DC Ammeter.
- 7720, 5mA DC Ammeter.
- 7705, 7710, 100K Ω , 20-watt resistor, 1000 volt.
- 7710, 7715, 100K Ω , 10-watt resistor, 1000 volt.
- 7720, 100K Ω , 2.5-watt resistor, 1000 volt.

- 7710,7720 1M Ω , 0.25-watt resistor, 300 volt

9.2. Calibration Initialization

Press and hold the calibration key on the rear panel with a pen, pencil, or small screwdriver while powering ON the HypotMAX. The HypotMAX enters calibration mode after the power on sequence is complete.

The program will automatically enter to the calibration mode and the display screen will show:



Calibration Mode
v:Forward ^:Backward

Use the \vee (Forward) and \wedge (Backward) keys to move through the calibration menu. The following instructions follow the sequence scrolling forward through the menu.

9.3. Calibration Procedure

9.3.1. Calibration of Hipot Voltage

The first screen to appear in the Calibration mode is the Voltage calibration display. The display will show:



ACW Voltage, 10kV
<TEST> to Calibrate



DCW Voltage, 10kV
<TEST> to Calibrate

Connect an AC standard voltage meter for 7705 and 7715 or a DC standard voltage meter for 7710 and 7720 which can measure up to 10KV to the output connectors and then press the TEST button, the program will automatically generate an output of about 10KV and the display will show:



HI-Voltage= ---- V
Enter Standard V-out

Use the Numeric keys to enter the standard value of voltage, unit V, and then press the ENTER key to store the standard value of AC or DC Hipot voltage for calibration and display will show:



ACW Voltage, 10kV OK
<TEST> to Calibrate



DCW Voltage, 10kV OK
<TEST> to Calibrate

9.3.2. Calibration of 7705 AC Hipot Current

AC Hipot, 20mA current range

Press the \vee key, the program will advance to the AC 20.00mA range calibration of the Hipot test. The display will show:



AC 20.00mA, 100K Ω OK
<TEST> to Calibrate

Connect a resistor about 100K Ω /40W in series with a AC standard Ammeter which can measure up to 20.00mA to the output leads. The Ammeter should be connected to the return lead, then press the TEST button, the program will automatically generate an output of about 2000V/20mA and the display will show:



Current = ---- mA
Enter Standard I-out

Use the Numeric keys to enter the standard value of current, unit mA, and then press the ENTER key to store the standard value of AC 20.00mA range for calibration and the display will show:



AC 20.00mA, 100K Ω OK
<TEST> to Calibrate

AC Hipot, 3.500mA current range

Press the \vee key, the program will advance to the AC 3.500mA range calibration of the Hipot test. The display will show:



AC 3.500mA, 100K Ω
<TEST> to Calibrate

Connect a resistor about 100K Ω /40W in series with a AC standard Ammeter which can measure up to 3.500mA to the output leads. The Ammeter should be connected to the return lead, then press the TEST button, the program will automatically generate an output on the output connectors about 300V/3.00mA and the display will show:



Current = ---- mA
Enter Standard I-out

Use the Numeric keys to enter the standard value of current, unit mA, and then press the ENTER key to store the standard value of AC 3.500mA range of the hipot test and the display will show:



AC 3.500mA, 100K Ω OK
<TEST> to Calibrate

Calibration of 7715 AC Hipot Current

AC Hipot, 10mA current range

Press the \vee key, the program will advance to the AC 10.00mA range calibration of the Hipot test. The display will show:



AC 10.00mA, 100K Ω
<TEST> to Calibrate

Connect a resistor about 100K Ω /10W in series with a AC standard Ammeter which can measure up to 10.00mA to the output leads. The Ammeter should be connected to the return lead, then press the TEST button, the program will automatically generate an output of about 1000V/10.00mA and the display will show:



Current = ---- mA
Enter Standard I-out

Use the Numeric keys to enter the standard value of current, unit mA, and then press the ENTER key to store the standard value of AC 10.00mA range for calibration and the display will show:



AC 10.00mA, 100K Ω OK
<TEST> to Calibrate

AC Hipot, 3.500mA current range

Press the \vee key, the program will advance to the AC 3.500mA range calibration of the Hipot test. The display will show:



AC 3.500mA, 100K Ω
<TEST> to Calibrate

Connect a resistor about 100K Ω /10W in series with a AC standard Ammeter which can measure up to 3.500mA to the output leads. The Ammeter should be connected to the return lead, then press the TEST button, the program will automatically generate an output on the output connectors about 350V/3.00mA and the display will show:



Current = ----- mA
Enter Standard I-out

Use the Numeric keys to enter the standard value of current, unit mA, and then press the ENTER key to store the standard value of AC 3.500mA range of the hipot test and the display will show:



AC 3.500mA, 100K Ω OK
<TEST> to Calibrate

9.3.3. Calibration of 7710 DC Hipot Current

DC Hipot, 10mA current range

Press the \vee key, the program will advance to the DC 10.00mA range calibration of the Hipot test. The display will show:



DC 10.00mA, 100K Ω
<TEST> to Calibrate

Connect a resistor about 100K Ω /10W in series with a DC standard Ammeter which can measure up to 10.00mA to the output leads. The Ammeter should be connected

to the return lead, then press the TEST button, the program will automatically generate an output of about 1000V/10mA and the display will show:



Current = ---- mA
Enter Standard I-out

Use the Numeric keys to enter the standard value of current, unit mA, and then press the ENTER key to store the standard value of DC 10.00mA range for calibration and the display will show:



DC 10.00mA, 100KΩ OK
<TEST> to Calibrate

DC Hipot, 3500 μ A current range

Press the \vee key, the program will advance to the DC 3500 μ A range calibration of Hipot test. The display will show:



DC 3.500mA, 100KΩ
<TEST> to Calibrate

Connect a resistor about 100K Ω /10W in series with a DC standard Ammeter which can measure up to 3000 μ A to the output leads. The Ammeter should be connected to the return lead, then press the TEST button, the program will automatically generate an output of about 300V/3000 μ A and the display will show:



Current = ---- μ A
Enter Standard I-out

Use the Numeric keys to enter the standard value of current, unit μ A, and then press the ENTER key to store the standard value of DC 3500 μ A range of Hipot test and the display will show:



DC 3.500mA, 100K Ω OK
<TEST> to Calibrate

DC Hipot, 350 μ A current range

Press the \vee key, the program will advance to the setting and reading of DC 320 μ A range calibration of the Hipot test. The display will show:



DC 350.0 μ A, 1M Ω
<TEST> to Calibrate

Connect a resistor about 1M Ω /0.25W in series with a DC standard Ammeter which can measure up to 300 μ A to the output leads. Connect the Ammeter to the return leads, then press the TEST button, the program will automatically generate an output of about 300V/300 μ A and the display will show:



Current = ----- μ A
Enter Standard I-out

Use the Numeric keys to enter the standard value of current, unit μ A, and then press the ENTER key to store the standard value of DC 350 μ A range of the Hipot test and the display will show:



DC 350.0 μ A, 1M Ω OK
<TEST> to Calibrate

9.3.4. Calibration of 7720 DC Hipot Current

DC Hipot, 5.00mA current range

Press the \vee key, the program will advance to the DC 5.00mA range calibration of the Hipot test. The display will show:



DC 5.00mA, 100K Ω
<TEST> to Calibrate

Connect a resistor about 100K Ω /2.5W in series with a DC standard Ammeter which can measure up to 5.00mA to the output leads. The Ammeter should be connected to the return lead, then press the TEST button, the program will automatically generate an output of about 500V/5.00mA and the display will show:



Current = ----- mA
Enter Standard I-out

Use the Numeric keys to enter the standard value of current, unit mA, and then press the ENTER key to store the standard value of DC 5.00mA range for calibration and the display will show:



DC 5.00mA, 100K Ω OK
<TEST> to Calibrate

DC Hipot, 3500 μ A current range

Press the \vee key, the program will advance to the DC 3500 μ A range calibration of Hipot test. The display will show:



DC 3.500mA, 100K Ω
<TEST> to Calibrate

Connect a resistor about 100K Ω /2.5W in series with a DC standard Ammeter which can measure up to 3000 μ A to the output leads. The Ammeter should be connected to the return lead, then press the TEST button, the program will automatically generate an output of about 300V/3000 μ A and the display will show:



Current = ----- uA
Enter Standard I-out

Use the Numeric keys to enter the standard value of current, unit μA , and then press the ENTER key to store the standard value of DC 3500 μA range of Hipot test and the display will show:



DC 3.500mA, 100K Ω OK
<TEST> to Calibrate

DC Hipot, 350 μA current range

Press the \vee key, the program will advance to the setting and reading of DC 320 μA range calibration of the Hipot test. The display will show:



DC 350.0 μA , 1M Ω
<TEST> to Calibrate

Connect a resistor about 1M Ω /0.25W in series with a DC standard Ammeter which can measure up to 300 μA to the output leads. Connect the Ammeter to the return leads, then press the TEST button, the program will automatically generate an output of about 300V/300 μA and the display will show:



Current = ----- uA
Enter Standard I-out

Use the Numeric keys to enter the standard value of current, unit μA , and then press the ENTER key to store the standard value of DC 350 μA range of the Hipot test and the display will show:

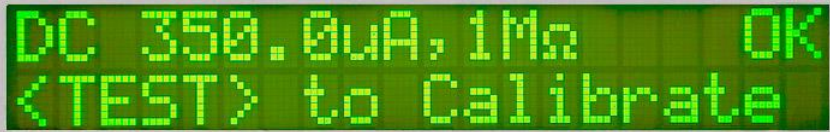

DC 350.0uA, 1MΩ OK
<TEST> to Calibrate

9.3.5. Calibration Complete Message

When a complete calibration of Hipot voltage and current has been performed, a message will appear on the screen to confirm the calibration is finished. The message will appear as follows:



Calibration
complete

10. REPLACEMENT PARTS

Rev: I 08/20/2018 ECO: 5962

Part Number	Qty.	Ref. Designator	Description
Supplied Accessories			
38787	2	-	3U Rack Mount Handle
38788	2	-	3U Rack Mount Bracket
38549	4	-	Screws Handle to Bracket
37780	1	-	Fuse 6.3A 250V Slow Blow 20mm
38686	1	(7715 and 7720 only)	High Voltage Cable
38694	1	(7715 and 7720 only)	High Voltage Probe (optional)
38712	1	(7705 and 7710 only)	High Voltage Cable
38736	1	-	Cable Assembly Return
39066	1	-	USB Cable AB-Type 1.8m
33189	1	-	Cable Input Cordset USA
38075	1	-	Interlock Connector
Panel Components			
38680	1	-	Return Connector
38679	1	-	High Voltage Connector
38069	1	-	Power Switch 2P 15A
37571	1	-	Earth Connector
37806	1	TEST	Test Switch Green Lighted
37807	1	RESET	Reset Switch Red Lighted
39391	1	Test/Pass	Replacement Bulb
39392	1	Reset/Fail	Replacement Bulb
38101	1	-	Feet Kit w/o Rubber Inserts
38102	4	-	Rubber Insert for Feet
39260	1	-	20 x 2 Character
PCB Assemblies			
38665	1	CON4320	Main Control Board
38666	1	HV4320 (7715, 7720)	HV Control Board
38706	1	HV4320 (7705, 7710)	HV Control Board
38662	1	AMP4320	Amplifier Board
38667	1	REM4320	Remote Board
39063	1	USB/RS232	USB/RS232 Interface Board
38268	1	PWR 3670	Input Voltage Select Board
38305	1	CGP-03	GPIB Interface Board
38664	1	CKB-03	Keypad Board

Part Number	Qty.	Ref. Designator	Description
39061	1	CPR-01	Printer Card
38703	1	RY7710 (7705 only)	High Voltage Board AC
38704	1	RY7710 (7710 only)	High Voltage Board DC
Internal Components			
40176	1	IC 2	IC W79E632A Microcontroller
38427	1	IC 39	IC 29C020 EEPROM PLCC
38846	1	IC 24	IC SM89516A Microcontroller
38298	1	IC 40	IC ATF16V8B 20Pin PLCC
38681	1	T1	Input Transformer
38718	1	T2	High Voltage Output Transformer (7705)
38716	1	T2	High Voltage Output Transformer (7710)
38682	1	T2	High Voltage Output Transformer (7715)
38725	1	T2	High Voltage Output Transformer (7720)
38705	1	RECMD (7720 only)	Rectifier Module

Index

AC Withstand	39, 41, 42, 43, 44
Adapter Box.....	20
Arc.....	3, 8, 13, 14, 15, 17, 30, 31, 34, 35, 43, 56
Benefits	8
Breakdown.....	3, 4
Calibration	10, 20, 67
Calibration Procedure.....	68
Charge-LO.....	30, 54, 55
Connected Memories	23, 37, 39, 41, 68
Connected Steps.....	54, 55, 58
Continuity Test.....	55
Contrast	18, 20, 22, 23, 24, 27, 38
Controls.....	11, 13, 19, 61
DC Withstand.....	30
Default Parameters	27, 31, 55
Dielectric Withstand Test	27, 31, 55, 56, 57
Discharge.....	7
DUT	7, 8, 25, 38, 39, 42, 43, 44
Dwell.....	13, 15, 16, 17, 29, 31, 33, 34, 39, 42, 44, 56
Edit Parameters.....	31, 56, 57
ESD	6, 7
Exit Key.....	22
Fail Stop.....	55
Features.....	8
Frequency.....	3, 4, 13, 14, 15, 16, 30, 31, 34, 56
Front Panel Controls	8, 19
Glossary.....	3
GPIB.....	51, 52, 53, 54, 58, 62, 63, 64, 78, 80
HI-Limit.....	13, 14, 15, 16, 29, 30, 31, 32, 42, 43
Interlock	8, 9, 20, 38, 49, 50, 58, 59, 78
LCD.....	19, 23, 24, 38, 58
Leakage	4, 8, 11, 25, 42, 43
Lockout.....	19, 49
LO-Limit	29, 31, 32, 33, 43
Max-Lmt.....	56

Medical Restrictions.....	7
Memory	8, 18, 19, 22, 23, 26, 28, 29, 30, 31, 37, 39, 40, 48, 49, 53, 54, 55, 60, 61, 63
Menu.....	20, 22, 23, 24, 25, 26, 28, 30, 31, 32, 33, 34, 35, 37, 41, 68
Min-Lmt.....	56
Offset.....	55
Operator.....	6, 7, 8, 11, 12, 20, 25, 48
Options.....	51, 54, 64
Parameters	
System Parameters	22, 27
Test Parameters.....	8, 18, 19, 28, 29, 31, 38, 39, 40, 51, 53, 55
PLC.....	8, 48
Power	4, 6, 11
Power Factor.....	4
Programming.....	22
Ramp-HI.....	30, 56, 57
Ramping.....	8
Rear Panel Controls	11, 20
Receptacle.....	21, 47
Regulation	13, 15, 16, 17
Remote....	8, 18, 19, 20, 21, 22, 23, 26, 27, 28, 38, 41, 47, 48, 49, 50, 51, 53, 58, 59, 64, 78, 80
Remote Interlock	18, 38, 49, 50, 58
Resistance.....	4, 7, 11, 29
Return.....	11
RS-232.....	21, 51, 54, 59, 62, 63, 64, 80
Safety	3, 5, 7, 11, 18
Safety Symbols.....	3
Security	8, 18
Sequence.....	23, 37, 39, 41, 54, 68
Service	1, 3, 5, 6, 10, 53, 67
Service Interval.....	6
Setup	8, 11, 19, 20, 22, 23, 24, 25, 26, 27, 31, 38
File	55, 58
Short.....	23, 42, 43
Smart GFI	18, 22, 24, 25, 27
Specifications.....	13, 14, 15, 16, 18
Test Parameters.....	51, 53, 55
Test Station	6, 7
Trip Point	13, 14, 15, 16, 29, 31, 32, 33, 42, 43
Unpacking.....	9
Warranty	1, 2, 67

