

**Anritsu** Advancing beyond

# Microwave Site Master™

Cable & Antenna Analyzer with Optional  
VNA & VVM Modes

## S820E

1 MHz to 8 GHz, 14 GHz, 20 GHz, 30 GHz, 40 GHz



# Site Master is the Preferred Cable and Antenna Analyzer of Wireless Service Providers, Contractors, and Installers Worldwide

The Site Master S820E is the most advanced Site Master ever developed. With microwave frequency coverage up to 40 GHz. The S820E redefined the standards for portable handheld analyzers, setting another industry benchmark for performance and accuracy. The S820E is the culmination of >50 years of microwave development, utilizing the very latest technologies to deliver accuracy and performance previously reserved only for benchtop instruments. Fully equipped with four VNA receivers (a1, a2, b1, b2), the Site Master S820E offers true VNA performance in a portable package. The Site Master S820E is the most advanced Site Master ever developed. With microwave frequency coverage up to 40 GHz. The S820E redefined the standards for portable handheld analyzers, setting another industry benchmark for performance and accuracy.



## Site Master S820E Family

### Standard Capabilities Include:

1-Path, 2-Port Measurements	USB Transmission Measurements	Waveguide Measurements	Smith Chart 1-Port Phase	High Accuracy Power Meter	Pass/Fail Fiber Visual Inspection	Built-in Help Menu and full User Guide
-----------------------------	-------------------------------	------------------------	--------------------------	---------------------------	-----------------------------------	--

1. More standard features than any other microwave cable/antenna analyzer on the market
2. Unique, simultaneous reflection (VSWR or RL) plus extended USB transmission measurement across frequency range of interest with a single calibration. Dual display of results with independent limit lines and pass/fail analysis
3. Unprecedented dynamic range of 110 dB all the way up to 40 GHz for real benchtop performance in the field
4. Best frequency resolution of 1 Hz throughout entire operating range for maximum frequency flexibility
5. Fast sweep speed of  $\leq 550 \mu\text{s}/\text{data point}$  for fast field measurements
6. Full temperature coax calibration kits from  $-10^\circ\text{C}$  to  $+55^\circ\text{C}$  for field precision measurement
7. Waveguide support including ten built-in waveguide calibration kits + ten user defined calibration kits
8. Wide calibration temperature window of  $\pm 10^\circ\text{C}$  requiring less recalibrations
9. Highest RF immunity of +17 dBm for operation in harsh RF environments
10. Explosive Atmosphere MIL-PRF-28800F Section 4.5.6.3 compliant
11. Active thermal management enables fastest warmup, unmatched stability, and reduces need to re-calibrate
12. Longest battery life with >5 hours of operation for the most field uptime on one charge
13. Large, high-resolution display (8.4 inch, 800x600) for maximum readability in all lighting conditions with an intuitive touchscreen graphical user interface

### Nonlinear Transmission Line (NLTL) Sampler Technology (aka, ShockLine) onboard Site Master S820E

Vector network analyzers (VNA) are precise measuring instruments that have been in use since their initial introduction several decades ago. Like most measuring instruments, they convert signals to an intermediate frequency (IF) and then process the signals. There are two traditional methods of converting signals to IF: one method is to employ mixers, another method is to employ samplers. Each conversion method has benefits as well as deficits. Mixers tend to work best at lower frequencies, whereas samplers are much more efficient at higher frequencies. Fortunately, the Site Master S820E actually employs both methods, each one optimized for the range that it operates in. Models with coverage beyond 8 GHz employ Anritsu's NLTL sampler technology above 8 GHz. The benefits of the NLTL sampler conversion methods compared to mixer-based conversion methods are outlined below.

- 1. Superior Conversion Efficiency in Microwave Bands:** As test frequencies increase, mixer-based conversion relies on using  $n$  order mixer harmonics, where each of those harmonics gets progressively lower in amplitude as the  $n$  harmonic order of the mixer increases. To combat this increasing loss in conversion efficiency, additional amplifiers are required to increase the signal levels in order to be able to perform analysis on the signals. Each additional amplifier adds the following unwanted characteristics: reduced stability, reduced linearity, increased noise figure, increased distortion and harmonics, increased power consumption, and increased heat generation.
- 2. Increased Reliability:** Because ShockLine NLTL technology is so much more efficient than traditional mixer-based technology, fewer amplifiers are needed in the IF stages. Fewer active components directly results in higher reliability, better stability, and lower power consumption.
- 3. Improved Linearity:** Active devices, such as amplifiers, are subject to nonlinear behavior. This is true for any component that is not purely passive. Since fewer IF amplifiers are required, the immediate results are improved linearity overall.
- 4. Increased Stability:** A welcome characteristic of the ShockLine NLTL technology used in the Site Master S820E over mixer-based technology is significantly better stability over time, which directly equates to less measurement drift, longer intervals between calibrations, and superior repeatability and accuracy.
- 5. Lower Power Consumption:** Since fewer amplifiers are needed, less power is consumed. The resulting reduction in power consumption delivers several primary and secondary benefits. Primary benefits include longer battery operation times and less internal heat generated. Secondary benefits include faster cooling of the instrument and lighter weight since less heat sinking material is needed to manage instrument temperatures.
- 6. Highest Dynamic Range and Superior Accuracy:** The total outcome of the benefits of ShockLine NLTL sampler technology are easily apparent and directly available with the Site Master S820E. 110 dB of dynamic range up to 40 GHz in a portable, handheld VNA instrument is without equal. Never before has there been this much performance in such a small package.

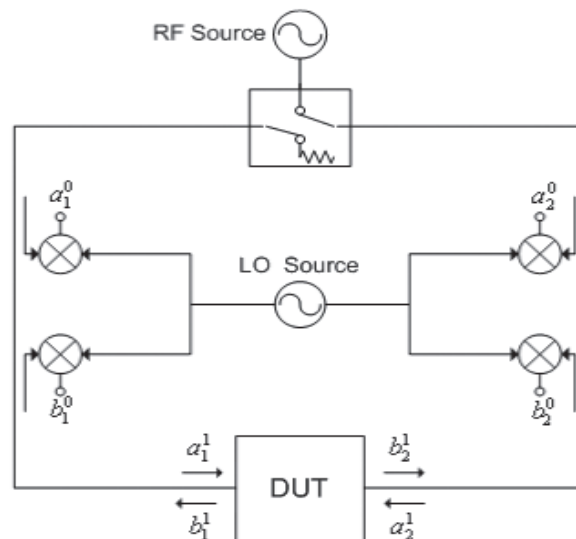

Equivalent Simplified Block Diagram of Site Master S820E VNA-Based Four Receiver Design

# Microwave Site Master S820E Cable & Antenna Analyzer Standard Features



## Cable & Antenna Analyzer



*The Site Master S820E is Purposely Designed for Use in the Field*

### Rugged, Reliable, Lightweight, and Portable

Site Master S820E is rugged, reliable, field-proven, and always ready. At only 3.0 kg (6.6 lbs) including battery, it's effortless to carry whether you are on level ground, climbing a large tower, or heading through a roof hatch. Your Site Master easily goes along with you.



*Inside Special Test Chamber Filled with Volatile Hexane Mixture*

### MIL-PRF-28800F Explosive Atmosphere Compliant

The Site Master S820E has been designed and tested to meet the MIL-PRF-28800F Section 4.5.6.3 Explosive Atmosphere requirements for safe usage on flight decks and in areas where high volatility may exist.

### Superior Battery Operating Time

The Microwave Site Master S820E provides the longest battery operation time of any handheld microwave analyzer available today. With >5 hours of continuous usage (40 GHz model, typical), you will not have to waste valuable time looking for available AC power to complete the measurements you need while on site.

Also included are intelligent power saving features like sleep mode with instant on (handy for traveling between sites) and auto-display brightness that will reduce the screen backlight automatically if the instrument has not been accessed for some time. One touch of the screen, keypad, or wheel will automatically restore brightness levels.

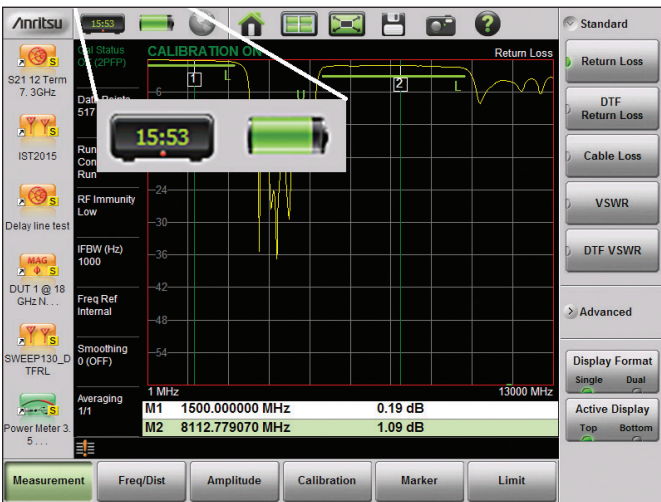

*Provides Long Battery Time Ideal for Field Use*

# Microwave Site Master S820E Cable & Antenna Analyzer Standard Features



## Cable & Antenna Analyzer

### Efficient Menu Screen

The Menu Key activates the touchscreen menu for one-button access to all of the analyzer modes and quick access to the dedicated setup shortcut icons.



Main Menu Screen Provides One-Touch Mode Selection and Access to Setup Shortcuts

### On-Board 1-Touch Help



An intelligent, useful help menu launches with the press of the Help Icon. The entire User Guide is built-in, as well as some useful FAQs and easy access to full system information.

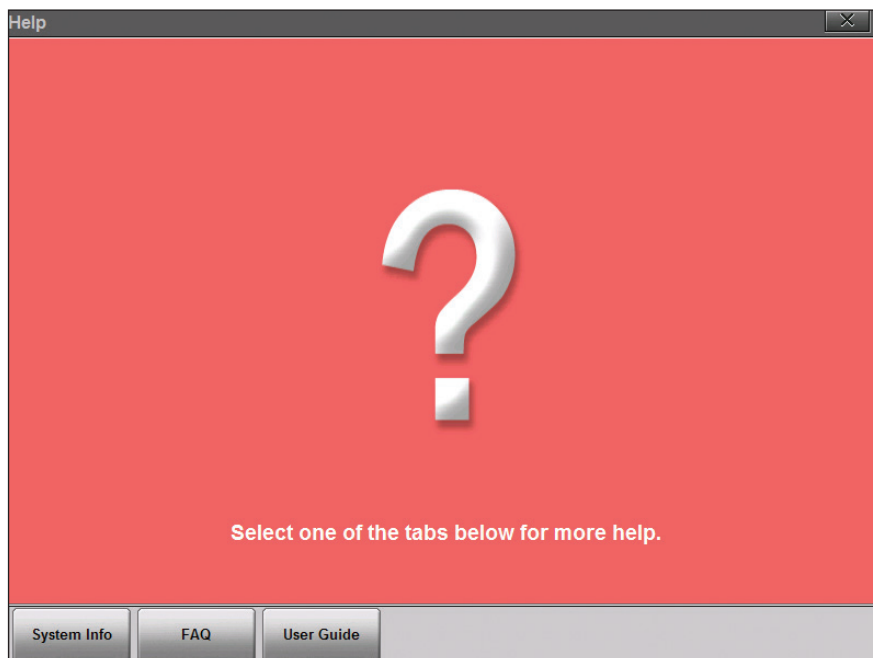

On-Screen Help Menu

# Microwave Site Master S820E Cable & Antenna Analyzer Standard Features



## Cable & Antenna Analyzer

### Site Master S820E Delivers the Most Standard Measurements\* of Any Microwave Hand-held Analyzer

The Site Master S820E delivers the most standard measurement capabilities of any microwave handheld analyzer: 2-port transmission, Smith Chart, phase, USB sensor transmission, high-accuracy power, visual fiber inspection, and dual display.

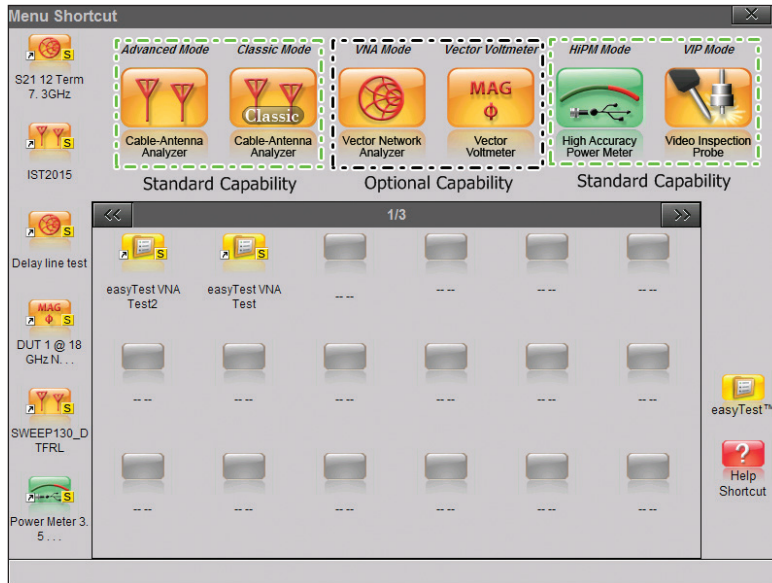

*With the Most Standard Measurements, the Site Master S820E Provides Extreme Value  
\*USB Sensor and USB Visual Inspection Probe Sold Separately*



### Classic Mode Provides Familiar GUI for Immediate Efficiency

For more than 20 years the Anritsu Site Master has been the defacto standard Cable & Antenna analyzer. In that time, many measurement procedures (MOP's) have been developed based on the original Site Master user interface and operation. For the user who needs to follow one of those MOP procedures, switching the S820E into Classic Mode will allow them to complete the tasks quickly and efficiently.

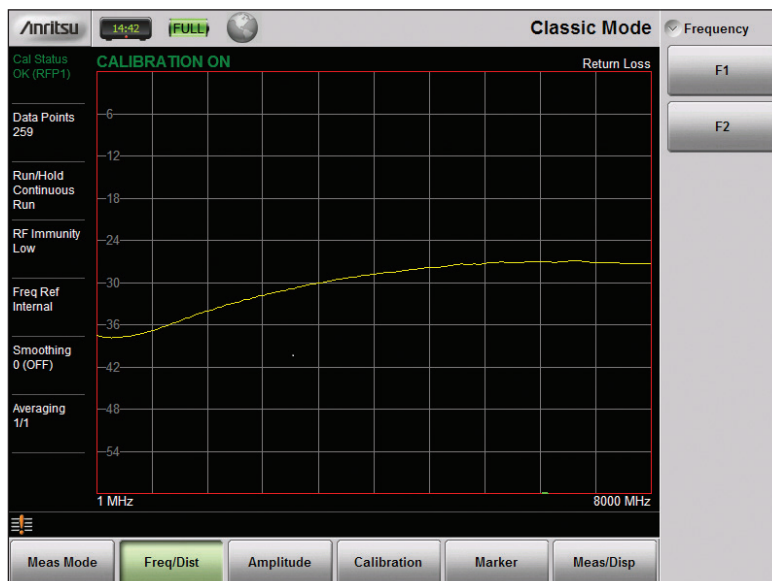

*Classic Mode is Standard on Every Site Master S820E. Advanced Mode Provides Even More Capabilities*

# Microwave Site Master S820E Cable & Antenna Analyzer Standard Features



## Cable & Antenna Analyzer

### Standard GPS function provides location, time & date stamping for saved measurements

Contractors and field technicians are often required to show proof of where the measurements have been made, and the S820E's standard GPS functionality (GPS module sold separately) provides location, time, and date stamping on saved measurements. Users can easily synchronize the S820E's internal system time with GPS time if desired.

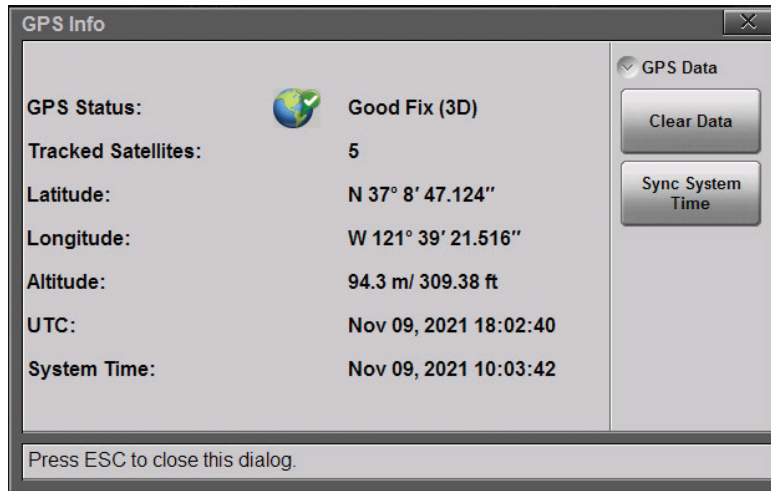

### Full support for Waveguide measurements with 10 built-in Rectangular Waveguide calibration kits, and up to ten user defined Waveguide Calibration kits can be easily added to the S820E

Waveguide is often used when high power, high frequencies, and low loss is required. Ship Radar systems are just one prime example, many legacy point-to-point microwave backhaul radio systems also use Waveguide. Signals propagate through Waveguide differently than through coaxial cable(s), due to the dispersive nature of Waveguide, thus obtaining accurate distance-to-fault (DTF) information requires the measuring instrument to account for the dispersive behavior of Waveguide. The S820E handles all of this for you automatically once the Cal Line type has been set to Waveguide.

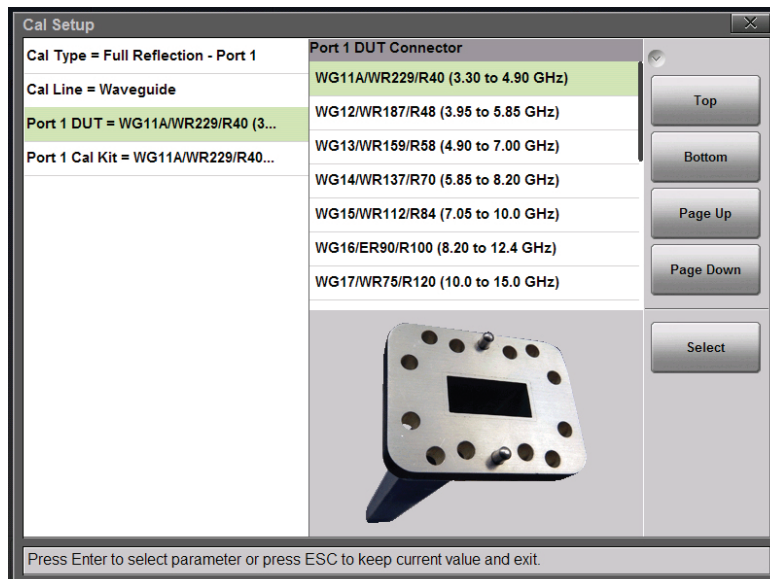



# Microwave Site Master S820E Cable & Antenna Analyzer Standard Features



## Cable & Antenna Analyzer

### Unprecedented Dynamic Range

The Site Master S820E delivers the most dynamic range ever offered in a handheld cable and antenna analyzer. With up to 110 dB of dynamic range, even at 40 GHz the Site Master S820E delivers performance that exceeds previous generation VNAs. You no longer have to sacrifice dynamic range in order to achieve the convenience of handheld portability.

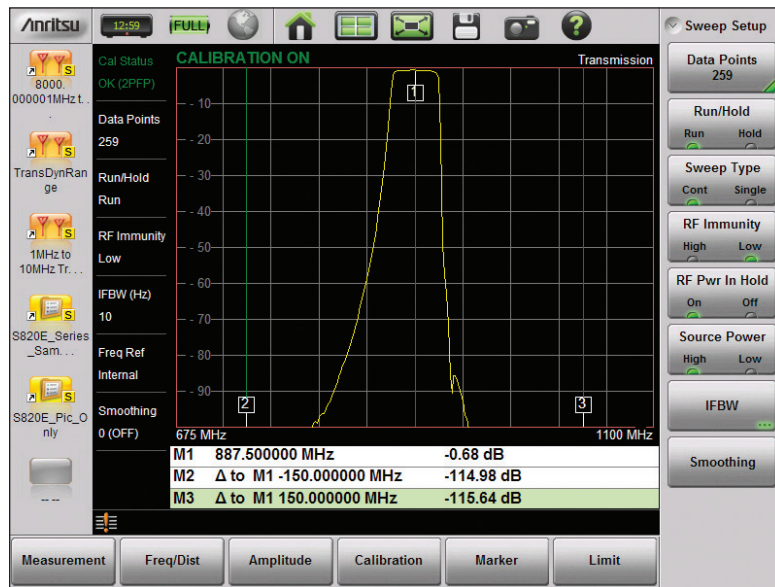

100 dB Scale Displayed with Noise Floor Off Screen. Delta Markers Indicate ~115 dB of Dynamic Range

### Mixed Measurements with Dual Display

Flexible dual display allows users to simultaneously measure any two types of measurements. Depending on the measurement combination, independent calibrations may be applied to each measurement. With the SC-8268 transmission sensor, both return loss and USB sensor transmission can be done simultaneously from 1 MHz to 40 GHz.

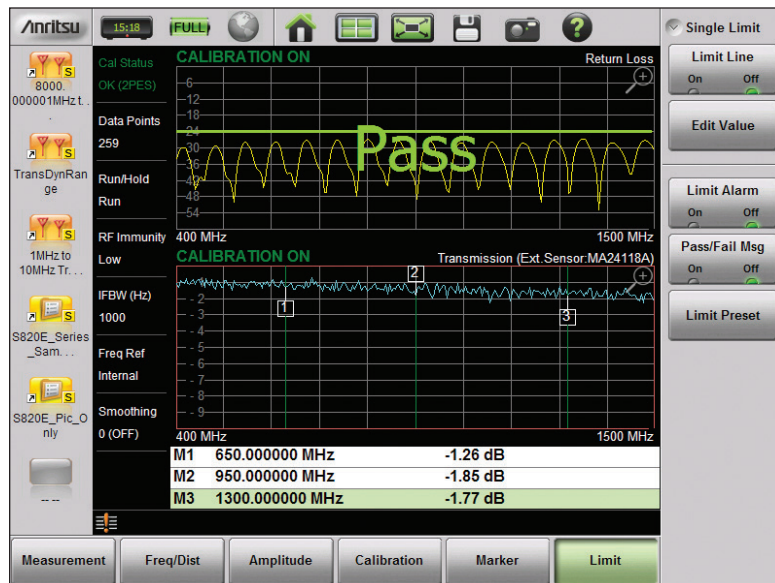

Return Loss (upper) Displayed with 2-Port USB Transmission (lower) Using External USB Sensor

## Microwave Site Master S820E Cable & Antenna Analyzer Standard Features



### Cable & Antenna Analyzer

#### USB Sensor Transmission Measurement Solves Challenging Issues with Ease

There are countless scenarios where a transmission measurement needs to be made on fixed transmission lines. Some typical examples include coaxial cables within aircraft wings and fuselage, cables and/or waveguide installed in large naval vessels, submarine periscope cable assemblies, locomotive coaxial cables, coaxial cables installed in mine shafts, elevator shafts, tunnels, and so on. The Site Master S820Es USB sensor transmission measurement capability allows users to make those measurements quickly and efficiently. For long end-to-end distances, extending the USB Sensor is easily accomplished with the optional, low-cost extender kit available from Anritsu. Unlike similar competitive solutions, the Site Master S820E provides this unique capability while simultaneously making reflection (Return Loss or VSWR) measurements or distance-to-fault (DTF) measurements, and this capability does not require a mode change or multiple calibrations.



*USB Transmission Sensor and Extender Kit Shown Connected to a Site Master S820E*



*Aircraft Typically Contain Many Embedded Transmission Lines that Require Validation at Regular Maintenance Intervals*

# Microwave Site Master S820E Cable & Antenna Analyzer Standard Features



## Cable & Antenna Analyzer

### Calibration Made Easy Via Graphical Images and Guided Steps to Eliminate Errors

The Site Master S820E takes advantage of the large, high-resolution display to provide the user with detailed images showing the connector type as well as a guided, step-by-step calibration sequence. Once the required calibration steps have been completed, the user can then apply the calibration and begin making measurements. During calibration sweeps, the Site Master S820E emits a beep tone to alert the user that the sweep has completed and the next calibration component is ready to be measured. The screen continuously updates during calibration to indicate which step(s) of the calibration are completed until the entire sequence is complete. Even inexperienced users can confidently calibrate the Microwave Site Master S820E.

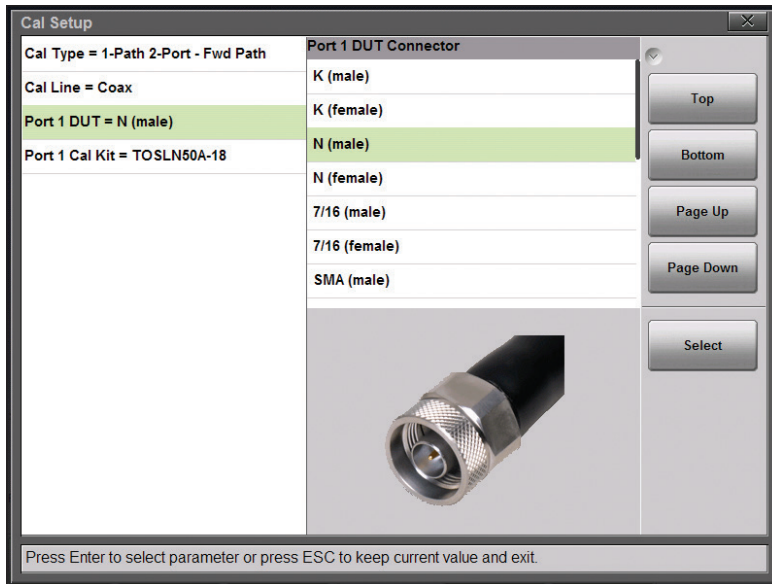

Site Master S820E Displays Images of the Connector Types to the User During Calibration Setup

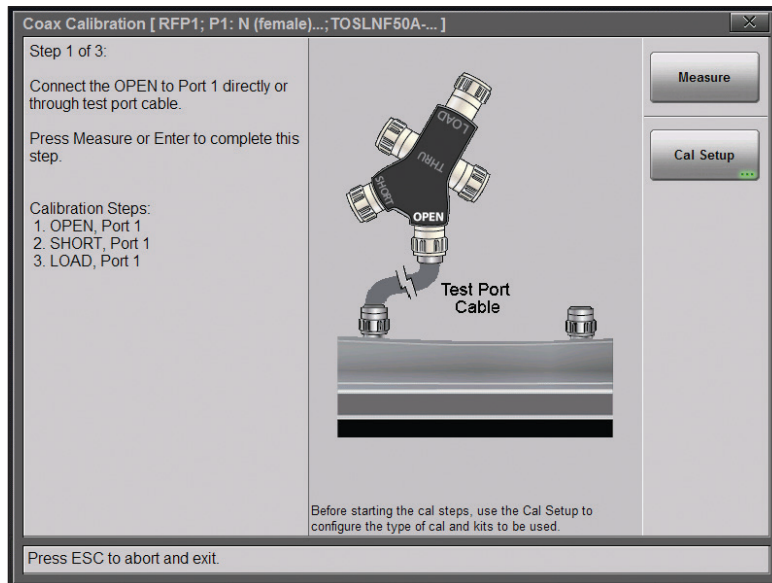

Step-by-Step, Guided Calibration with Live Progress Updates Eliminates Errors

# Microwave Site Master S820E Cable & Antenna Analyzer Standard Features



## Cable & Antenna Analyzer

### Multiple Markers & Flexible Limits

The Site Master S820E has eight available markers per active trace, flexible limits (upper and/or lower) that can be either simple lines or segmented for specific testing needs, as well as built-in Pass/Fail testing and limit alarms that ensure your device under test is within its specifications.

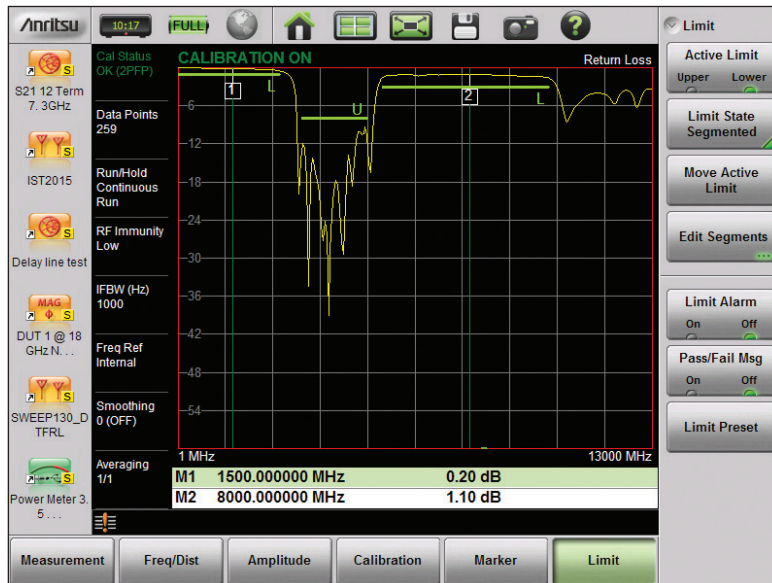

Markers can be Moved Simply by a Touch/Hold then Drag, or by Entering the Marker Frequency Manually

### Convenient Direct Access Shortcuts

Users can store their six favorite setups conveniently in the area highlighted for one-touch direct access. No need to go through the main menu or file menu to access those six setups. If your needs change, simply replace those setups with the latest to suit your needs. (Not available in Classic Mode).

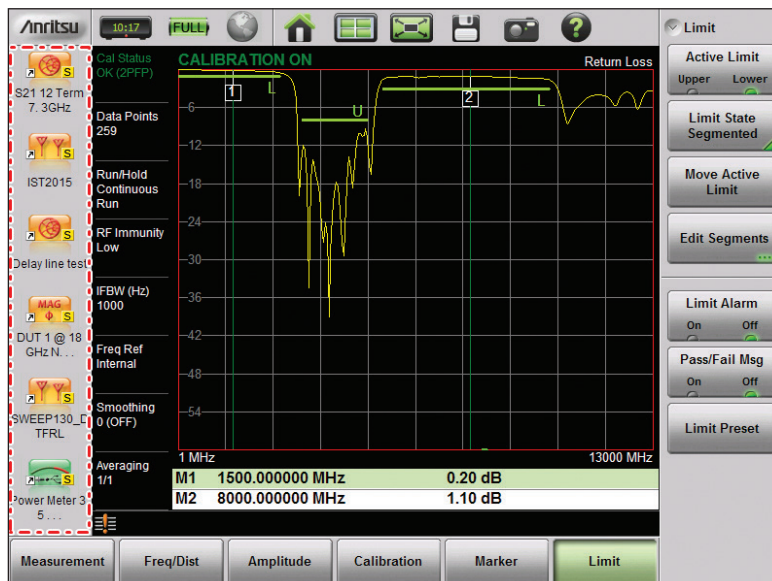

User-Definable Shortcuts for Frequently Used Functions



## Cable & Antenna Analyzer

### Variable IFBW Settings to Optimize Speed and Performance

Unlike competitive products which offer only a single, fixed IFBW in Cable & Antenna analyzer mode, the Site Master S820E provides four user selectable IFBW settings to obtain the best performance/speed needed for the current task at hand. Excellent performance is provided by the default 1 kHz IFBW.

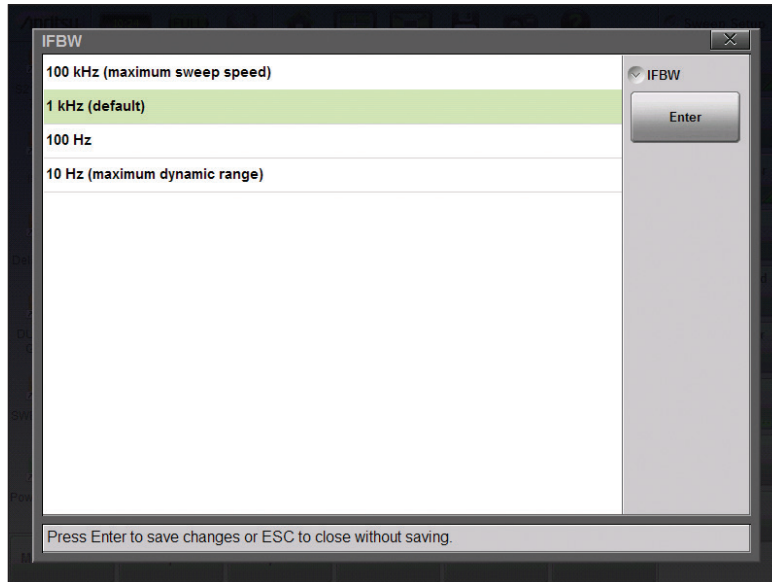

*Users can Easily Adjust the IFBW to Get Increased Speed or Increased Dynamic Range Anytime*

### DTF Aid Screen Makes Complex DTF Measurements Easy

DTF measurements are a powerful and valuable tool for field installation/maintenance of wireless communication systems. However, it can be challenging for some users. The Site Master S820E includes a very useful DTF-Aid screen to help the user with the setup of the instrument so that they can obtain the best and most accurate DTF measurements, enabling them to locate and correct the source of the problem quickly and efficiently.

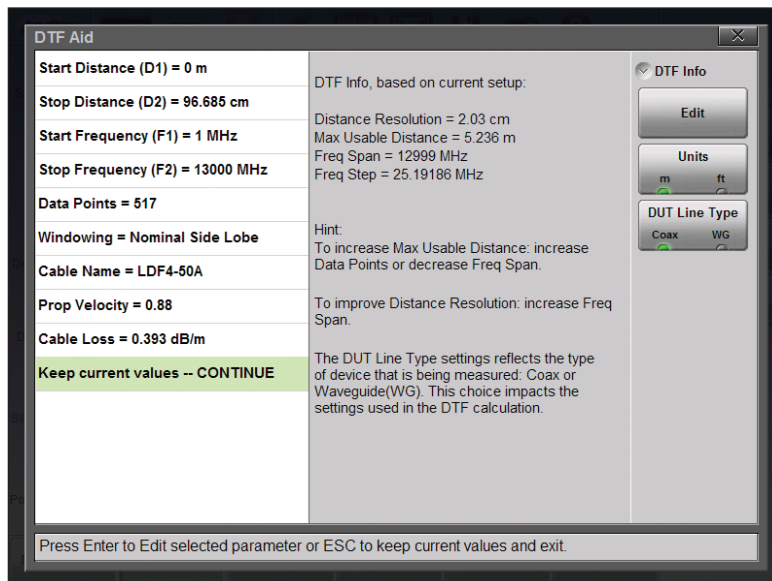

*DTF-Aid Screen also Includes Hints on How to Optimize the Settings Even Further*

## Microwave Site Master S820E Cable & Antenna Analyzer Standard Features



### High-Accuracy Power Meter

The Site Master S820E includes a high-accuracy power meter mode for accurately measuring power in the field. This is a standard capability on every device, unlike some competitor's products that charge for this capability. Uses Anritsu external USB power sensors, sold separately.

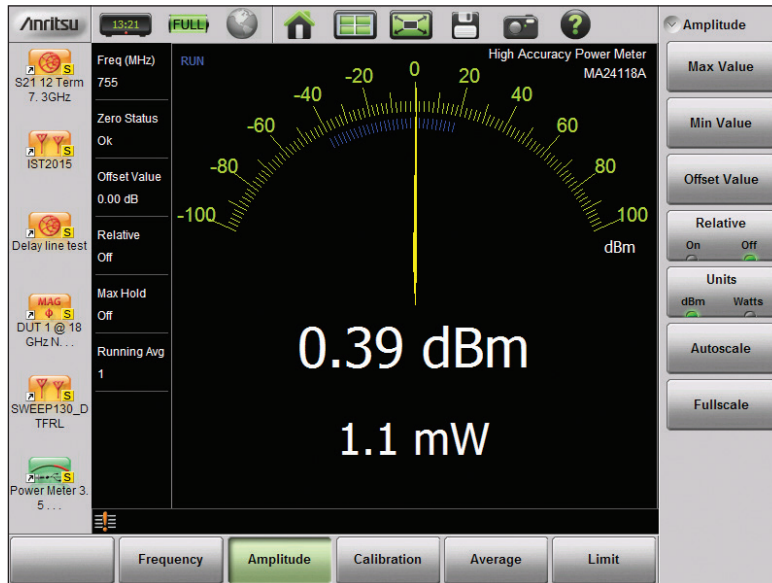

*Built in High Accuracy Power Meter Measurement Screen*

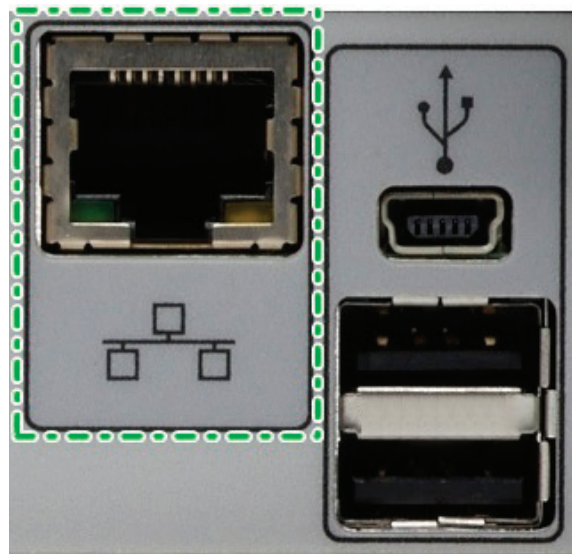

### Standard Ethernet RJ-45 Port

The Site Master S820E comes standard with an RJ-45 Ethernet port. Connecting to any Ethernet network is as simple as connecting the cable and either setting the instrument to obtain an I.P. address automatically via DHCP, or if necessary users can enter their own manual I.P. address configuration. Full remote control of the instrument is available either using SCPI commands, or using the built-in web server with any device and HTML5 compatible browser. Add an external USB powered Wi-Fi router and you now have complete wireless remote control of the instrument, using your favorite Android, IOS, or Windows® device.

# Microwave Site Master S820E Cable & Antenna Analyzer Standard Features



## Cable & Antenna Analyzer

### Standard Multiple USB Ports

The Site Master S820E comes standard with two USB type A ports, and one USB type mini B port. The type B mini USB port may be used for remote SCPI operation of the instrument or for transferring measurements to and from an external PC with the supplied Line Sweep Tools (LST) software. Two type A USB 2.0 ports support numerous external peripheral devices such as USB memory sticks, external mouse and/or keyboard, external USB Power Sensors, or an external Anritsu USB microscope for performing IEC-61300-3-35 pass/fail testing on Fiber Optic cable ends.

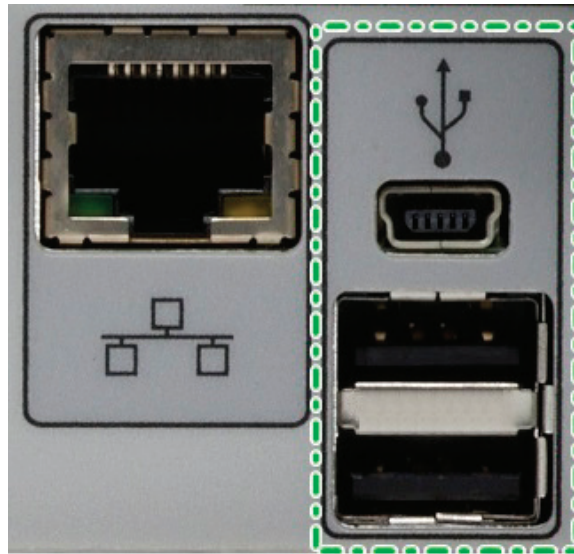

### GUI Remote Control Via Built-in Web Server

The Site Master S820E has a built-in web server that enables remote control of the instrument that is connected to a network via the RJ-45 connector, or wirelessly with the addition of an external USB powered Wi-Fi router. Works with several HTML5 compatible web browsers. Once a valid network connection has been established, type in the IP address of the instrument in the URL field and a virtual instrument will appear in the browser display. You now have control of the instrument almost as if it was in front of you. Measurements and/or files are easily transferred into the remote PC or tablet. A virtual keypad replicates the instrument keypad and the scroll wheel function is replicated using the four arrow keys (up/down/left/right).

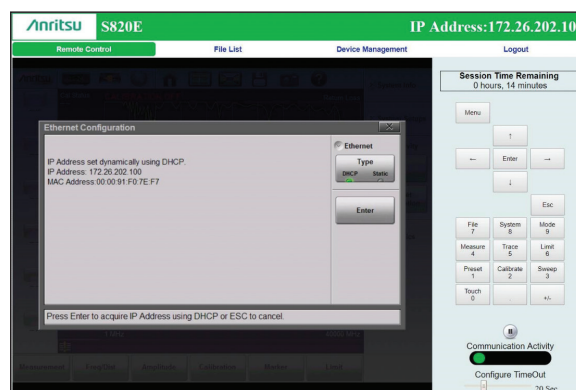

## Microwave Site Master S820E Cable & Antenna Analyzer Standard Features



### Cable & Antenna Analyzer

#### Large, Easy-to-see Touchscreen Keyboard

Unlike some competitive products, the Site Master S820E has a large, built-in popup keyboard that saves valuable time in the field when saving files, setups, etc. Time spent in the field is valuable and using a scroll wheel to select individual letters and characters one at a time is very time consuming and error-prone. With this large, QWERTY-style keyboard, saving files, setups, or anything else is done quickly with few (if any) errors. The time saved by this handy keyboard increases your efficiency and the returns will be quickly obvious and noticeable. You will find yourself wondering how you ever managed without this.

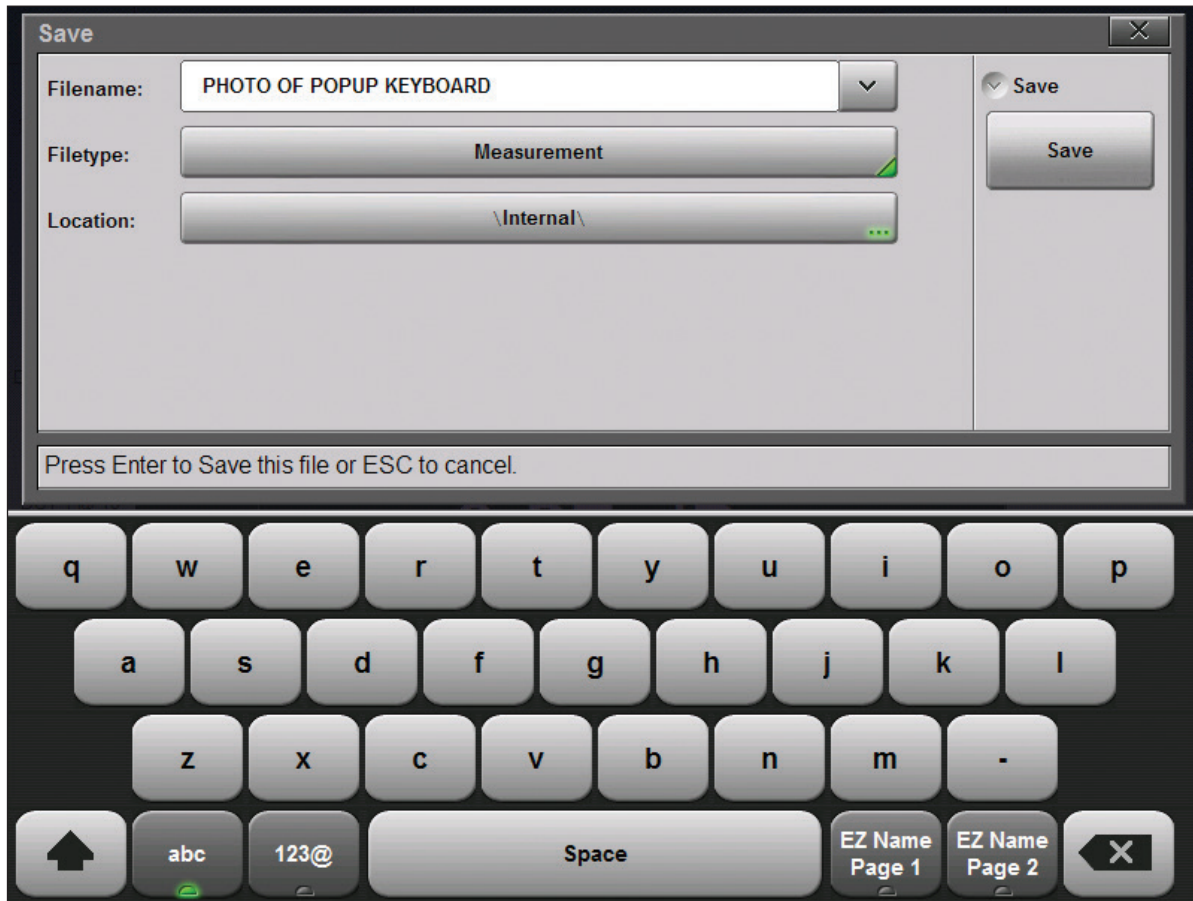

*Buttons are Large, Easy to See and Press even with Gloves On. Makes File Saving Easier than Ever*



# Microwave Site Master S820E Cable & Antenna Analyzer Standard Features



## Cable & Antenna Analyzer

### EZ Name Quick Naming Matrix Saves Even More Valuable Time

Unique to Anritsu, the customizable EZ Name Quick Naming Matrix saves even more valuable time. Users can preset up to 36 commonly used names. The resulting time saved is immediately beneficial. You can now save file names labeled with Site ID, Sector, Color Code, Measurement type, Termination, and Frequency in less than five seconds. With the EZ Name Quick Matrix feature, you can now label the traces of the entire site in minutes instead of hours.

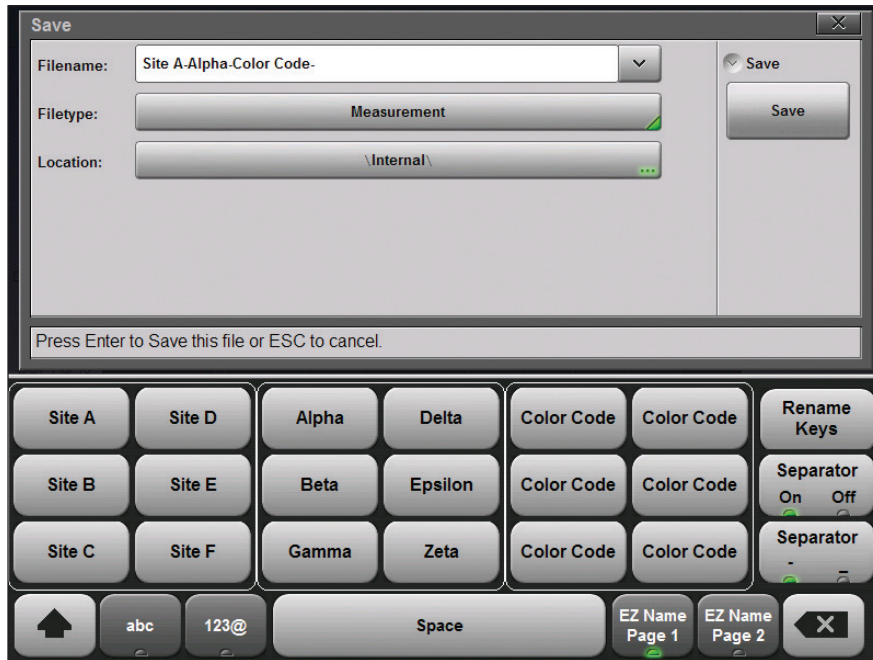

*Most Common Site Name Requirements are Preprogrammed into the EZ Name Matrix.  
Page 1 of 2 Shown*

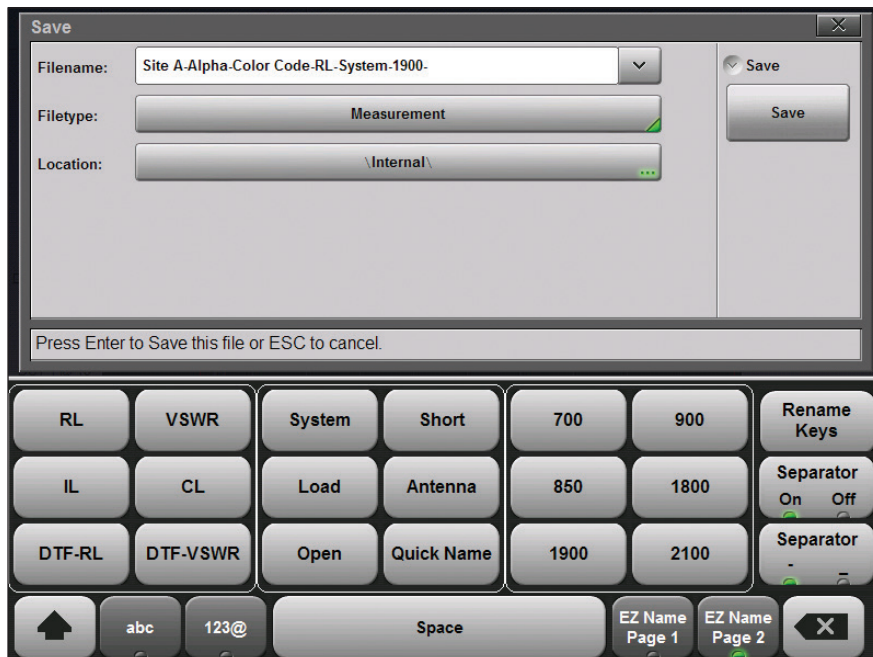

*18 Additional Customizable EZ Name Buttons Available on Page 2*

# Microwave Site Master S820E Cable & Antenna Analyzer Available Options



## Vector Network Analyzer (Option 440)

### Fully Reversing VNA Mode

Adding Option 440 provides fully reversing Vector Network Analysis capability. Now users can measure all four S-parameters (S11, S12, S21, S22) with one single device connection. VNA Mode also provides several additional capabilities to the user that are not found in the standard Cable & Antenna Analyzer mode(s).

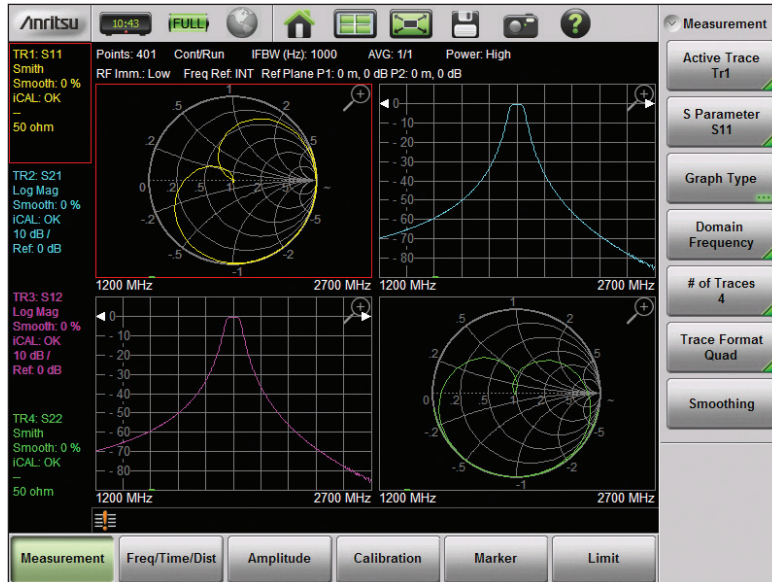

User Configurable Quad Display Showing all Four S-Parameters Simultaneously

### Optimize Speed and Dynamic Range Easily with Large Range of User Definable IFBW Settings

Experienced VNA users know that the dynamic range and sweep speed performance of the instrument is directly related to the IFBW used for the measurement. The Site Master S820E offer numerous user definable IFBW settings to achieve the best balance of both speed and dynamic range.

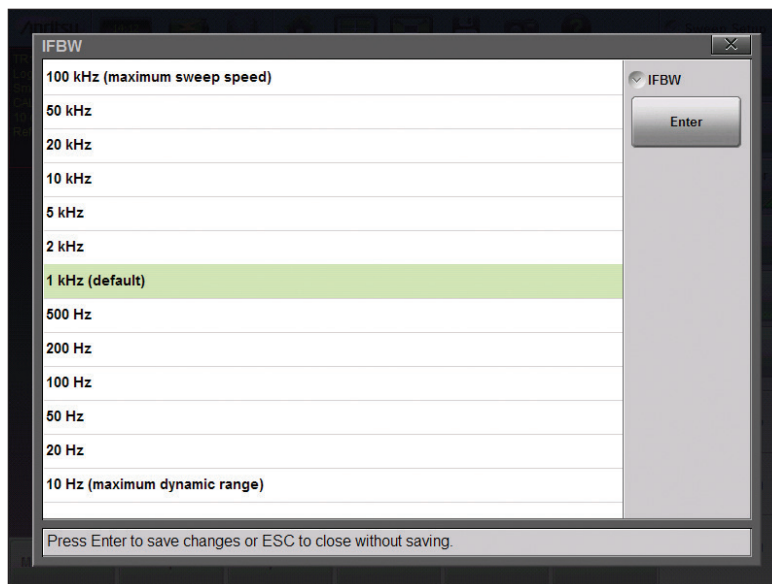

Default 1 kHz IFBW Gives a Great Blend of Speed and Dynamic Range



## Vector Network Analyzer (Option 440)

### Easily Adjust Reference Plane in Distance or Time and Amplitude

Adjusting the reference plane is easily accomplished in the port config menu. Offset the reference plane in either distance or time and account for any losses in amplitude. Automatic Reference Plane extension quickly unwraps phase with a single button press. Use Automatic Reference Plane extension to quickly measure the electrical length of DUTs like adapters, tuning stubs, etc.

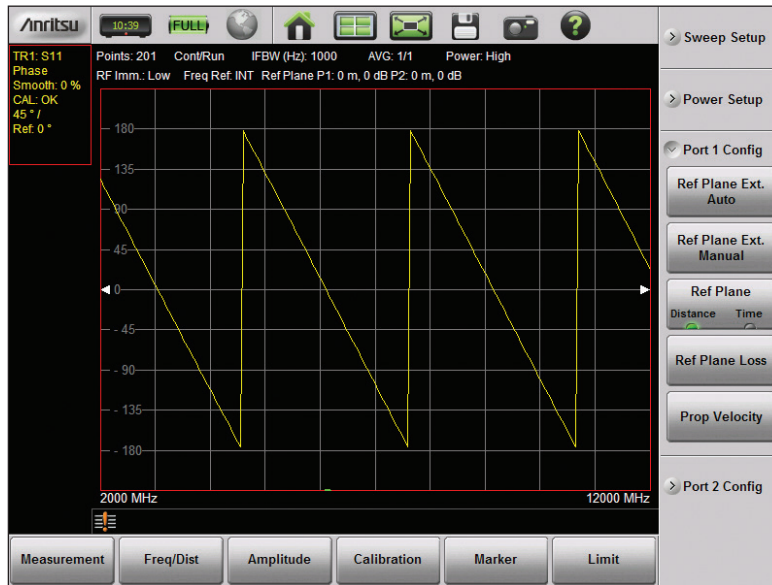

*Before 1-Button Automatic Reference Plane Extension*

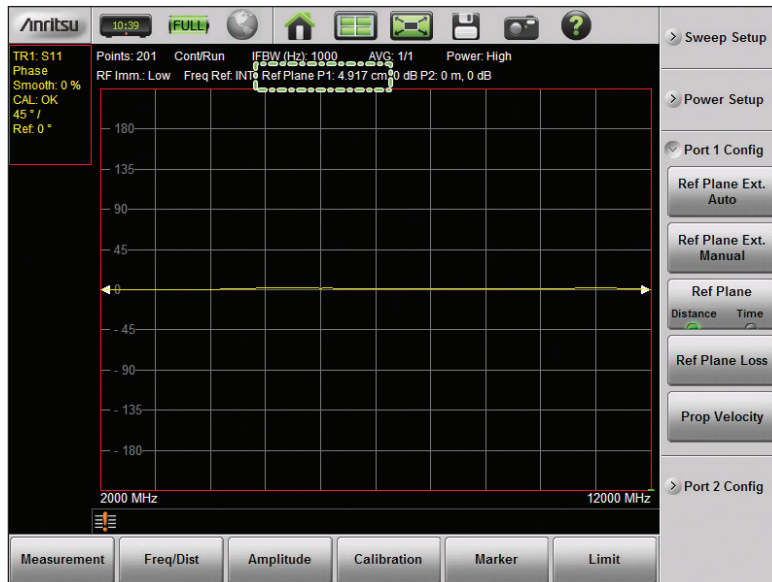

*After 1-Button Automatic Reference Plane Extension*

## Microwave Site Master S820E Cable & Antenna Analyzer Available Options



### Vector Network Analyzer (Option 440)

#### Numerous Trace Graph Types Available in VNA Mode

Complex VNA measurements can be presented to the user in many different forms. The Site Master S820E has 12 of the most common VNA graph types, so you shouldn't have any situations where the desired graph format is not available. Each trace can be individually configured to meet your needs.

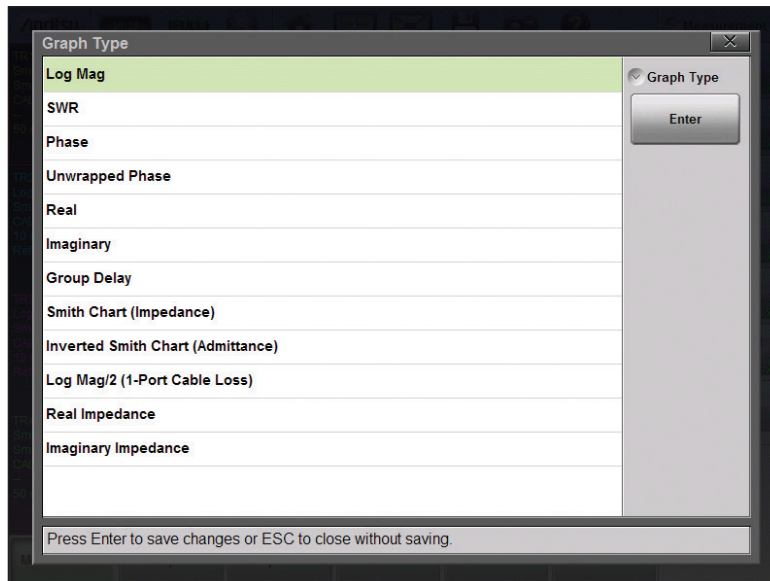

*12 of the Most Common VNA Graph Types are Readily Available to Apply to Any Trace*

#### Numerous File Types for Compatibility with External Software Tools

VNA measurement files are often used with simulation software, materials measurement software and so on. To help ensure compatibility with a wide array of post processing software tools, the Site Master S820E offers numerous options for saving files. Simply select the file format that suits your needs and that's it.

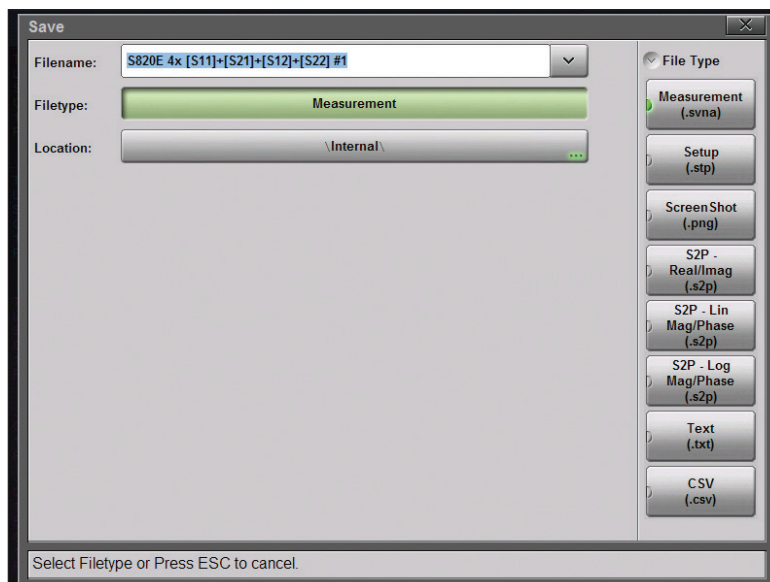

*Select from Numerous File Formats in VNA Mode for Easy Use with External Software Packages*

# Microwave Site Master S820E Cable & Antenna Analyzer Available Options



## Vector Network Analyzer (Option 440)

### Convenient Through Update Feature for Removing the Transmission Measurement Drift Effects of External Cables

The Site Master S820Es Active Thermal Management minimizes instrument drift caused by temperature changes. External cables used are now the largest cause of transmission measurement drift. This instrument has a convenient Through Update feature that allows these drift effects to be easily removed without having to repeat a full 2-port calibration. An excellent time-saving feature that maximizes your accuracy and productivity.

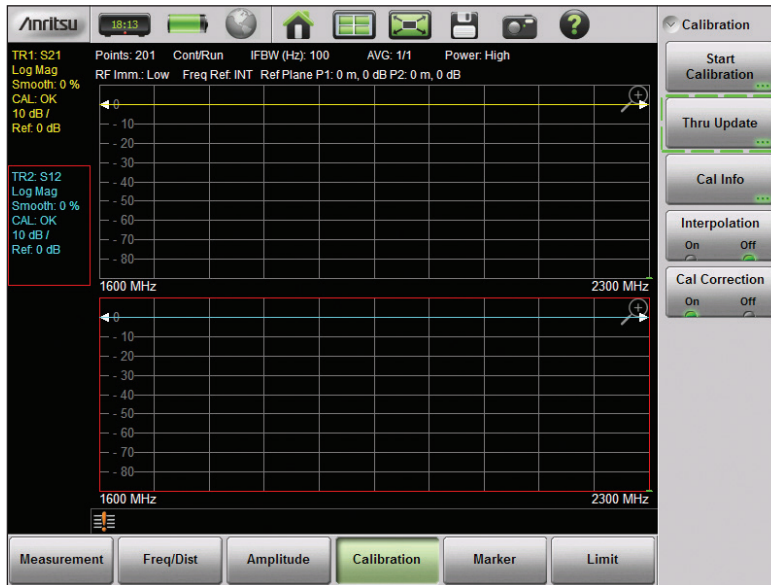

*With a Simple Through Update, Measurement Errors Caused by the External Cable Drift is Removed*

### Flexible Display Configuration with Easy Overlaid Measurements

Many users prefer to have several measurement traces overlaid on a single graph as opposed to showing multiple graphs. Filters are a good example. Overlaying S11 (Return Loss), and S21 (Insertion Loss) & S21 (Group Delay) is easily done with a configurable display.

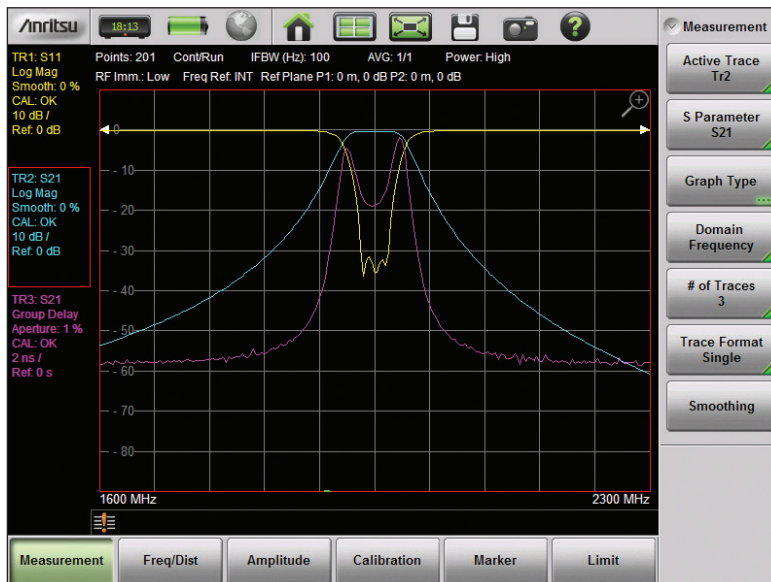

*Filter Measurement with S11 (Return Loss), S21 (Insertion Loss) and S21 (Group Delay) Shown*

# Microwave Site Master S820E Cable & Antenna Analyzer Available Options



## Vector Voltmeter (Option 441)

### Full-function Vector Voltmeter Option

The Site Master S820E Vector Voltmeter option provides full capabilities including A/B and B/A ratio measurements. The A/B and B/A Ratio measurement functionality does not require any additional VNA options, unlike some competitive products in the market.

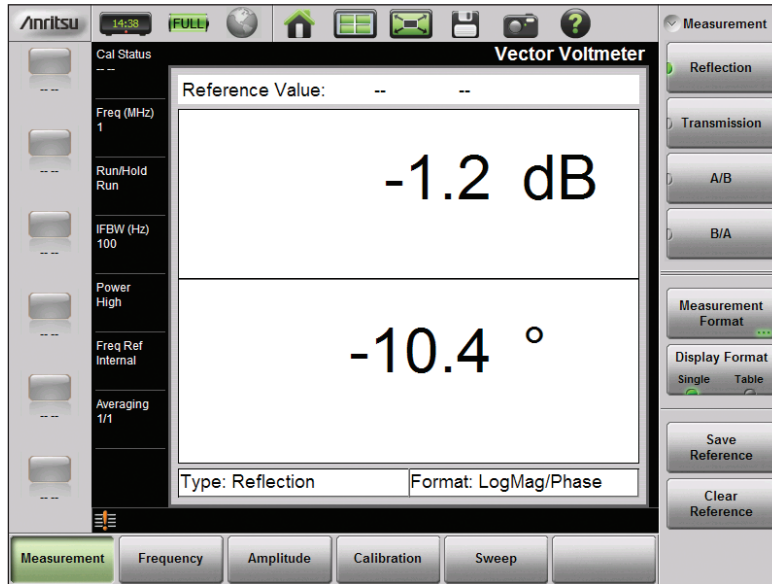

Full Vector Voltmeter A/B or B/A Ratio Capability without Needing Additional VNA Mode Options

### Measure and Match Multiple Cables (Up to 12 Plus 1 Reference) or DUTs With Ease Using the Standard Table Display

Often there are cases where multiple cables need to be matched to some specified tolerance for the system to deliver its intended performance. Using the standard Table display format, the Site Master S820E Vector Voltmeter option simplifies this task and saves valuable time in the field.

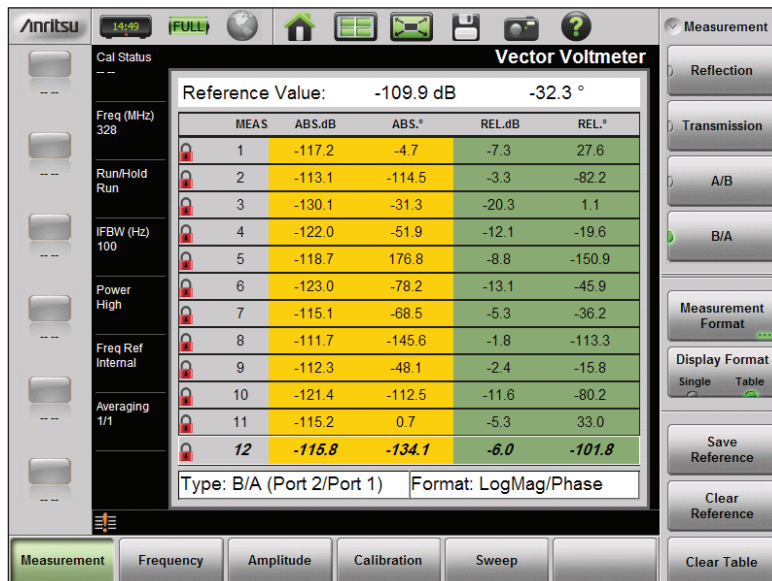

Easily Phase Match Multiple Cables with the Standard Table Display Feature

# Microwave Site Master S820E Cable & Antenna Analyzer Available Options



## Vector Voltmeter (Option 441)

### Unique, Time-saving Auto-Tune Input for A/B and B/A Ratio Function

Other Vector Voltmeter instruments require a 10 MHz reference between the Vector Voltmeter and the external source, otherwise the reference input signal may not be seen due to absolute frequency errors of the instruments. The Site Master S820E has a unique, automatic Auto-Tune feature that allows the instrument to lock itself to the reference input signal even if the absolute frequency error is beyond the measurement bandwidth.

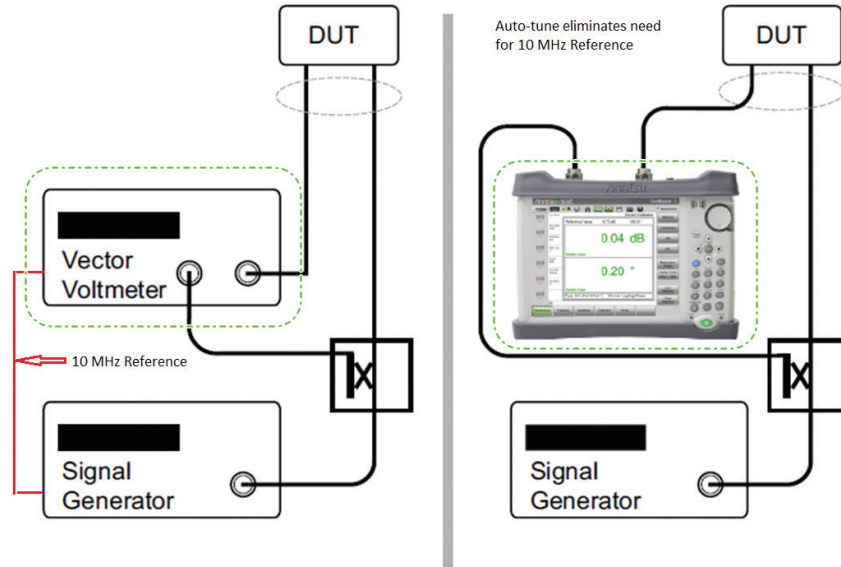

Vector Voltmeter on Left Requires 10 MHz Reference. The Auto-Tune Feature Eliminates this Requirement

### Flexible Data Display Format For Ease of Comparison and Compatibility with Other Data Formats

Most modern Vector Voltmeter options only offer one data display type during operation — log magnitude and phase. The Site Master S820E offers both of these as well as three other data display types to suit the user's needs or preferences. Switching between display types is fast and easy.

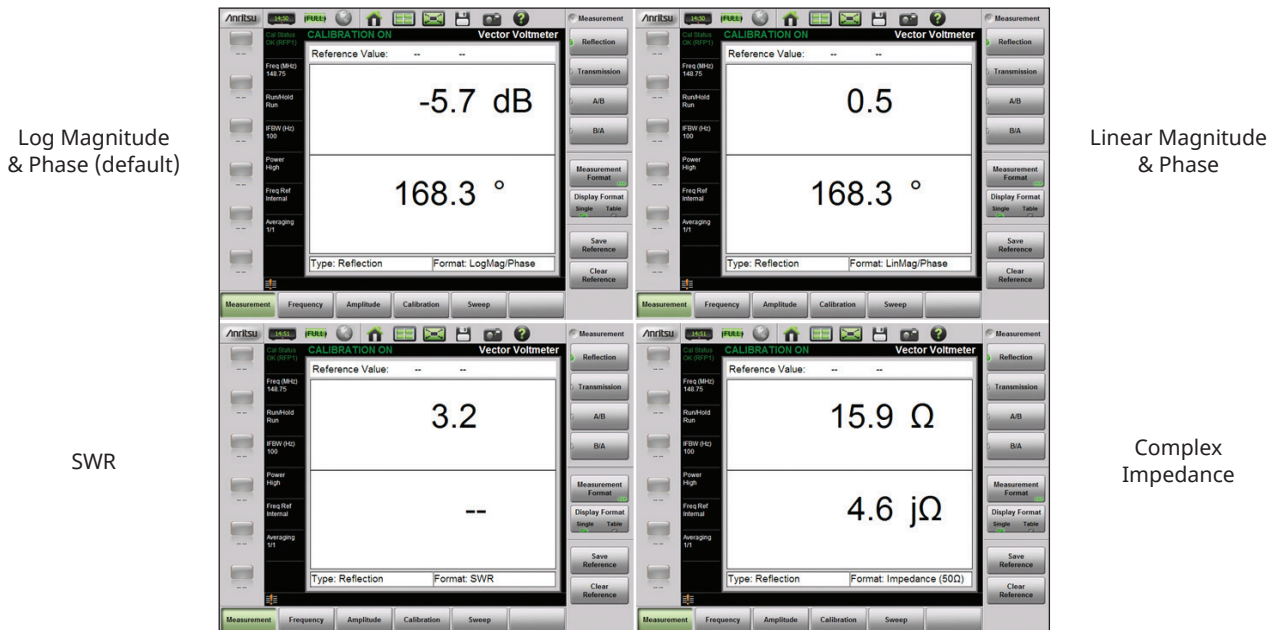

Select Which Data Display Format You Prefer, the Site Master S820E Converts the Format Automatically for You

# Microwave Site Master S820E Cable & Antenna Analyzer Available Options

## Physical Information

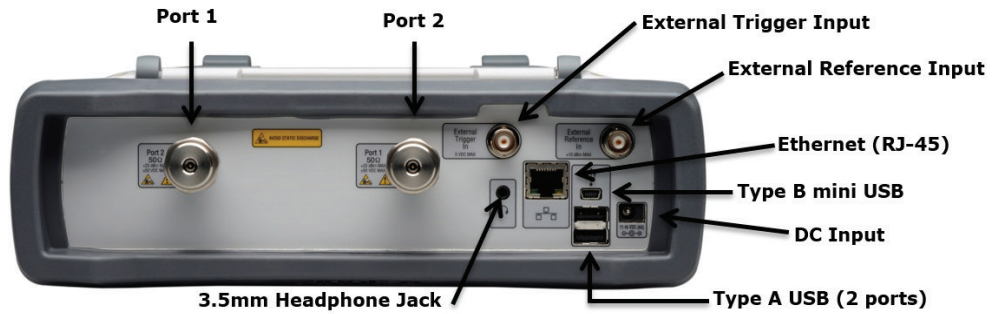

All connectors are conveniently located on the top panel, leaving the sides clear for handheld use

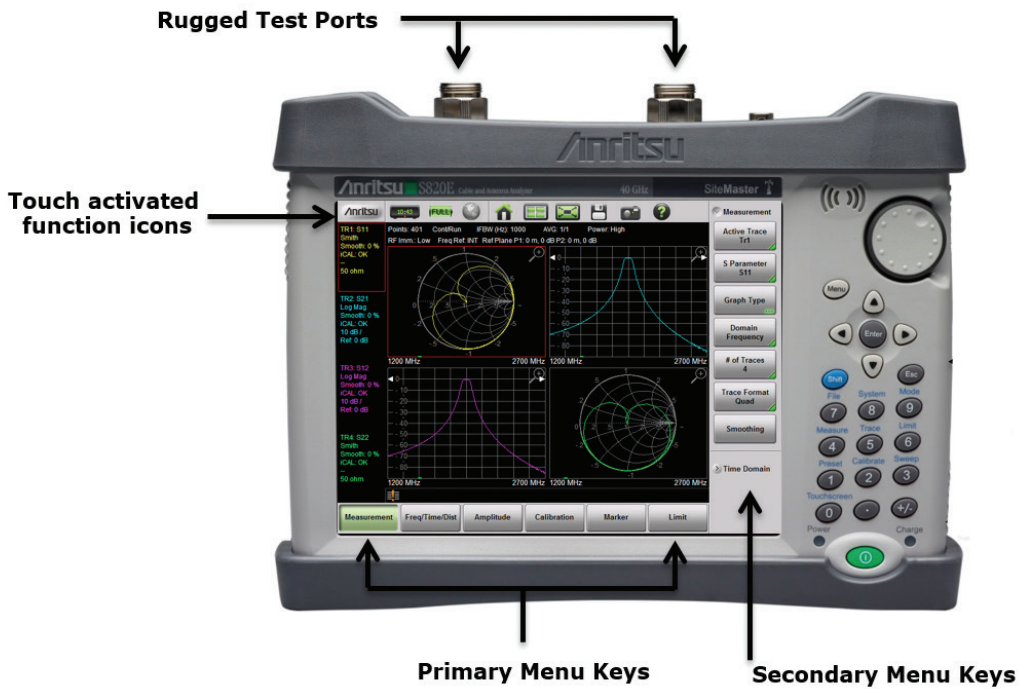



# Microwave Site Master S820E Cable & Antenna Analyzer Ordering Information

## Ordering Information (standard configuration)



Part Number	Description
S820E	Microwave Site Master (Requires one frequency option: 708, 714, 720, 730, or 740) Three Year Warranty (One year on battery)

### Frequency Options (select one frequency option only)

Option Number	Description
S820E-0708	1 MHz to 8 GHz, type N(f) ports
S820E-0714	1 MHz to 14 GHz, type N(f) ports
S820E-0720	1 MHz to 20 GHz, type Ruggedized K(m) ports (compatible with 3.5 mm and SMA connectors)
S820E-0730	1 MHz to 30 GHz, type Ruggedized K(m) ports (compatible with 3.5 mm and SMA connectors)
S820E-0740	1 MHz to 40 GHz, type Ruggedized K(m) ports (compatible with 3.5 mm and SMA connectors)

### Instrument Options



Option Number	Description
S820E-0440	Vector Network Analyzer (VNA)
S820E-0441	Vector Voltmeter (VVM)
S820E-0097	Accredited Calibration to ISO17025 and ANSI/NCSL Z540-1
S820E-0098	ISO17025 and ANSI/NCSL Z540-1
S820E-0099	Premium Calibration to ISO17025 and ANSI/NCSL Z540-1 plus test data

### Standard Accessories (included with instrument)



Part Number	Description
2000-1654-R	Soft Carrying Case
71693-R	Ruggedized K(f) to N(f), 2 pcs (included only with S820E-0720)
633-75	Rechargeable Li-Ion Battery
40-187-R	AC-DC Adapter
806-141-R	Automotive Power Adapter, 12 VDC, 60 W
2000-1691-R	Stylus with Coiled Tether
2000-1797-R	Screen Protector Film (one factory installed, one spare)
3-2000-1498	USB A/5-pin Mini-B Cable, 3.05 m (10 ft)
2000-1371-R	Ethernet Cable, 2.13 m (7 ft) Certificate of Calibration and Conformance

### Documentation (available at [www.anritsu.com](http://www.anritsu.com))

Part Number	Description
11410-00749	Technical Data Sheet
10580-00343	User Guide
10580-00344	Programming Manual
10580-00345	Maintenance Manual

- **United States**

- **Anritsu Americas Sales Company**

450 Century Parkway, Suite 190, Allen, TX 75013 U.S.A.  
Phone: +1-800-Anritsu (1-800-267-4878)

- **Canada**

- **Anritsu Electronics Ltd.**

- **Americas Sales and Support**

450 Century Parkway, Suite 190, Allen, TX 75013 U.S.A.  
Phone: +1-800-Anritsu (1-800-267-4878)

- **Brazil**

- **Anritsu Eletronica Ltda.**

Praça Amadeu Amaral, 27 - 1 Andar  
01327-010 - Bela Vista - Sao Paulo - SP, Brazil  
Phone: +55-11-3283-2511  
Fax: +55-11-3288-6940

- **Mexico**

- **Anritsu Company, S.A. de C.V.**

Bldv Miguel de Cervantes Saavedra #169 Piso 1, Col. Granada  
Mexico, Ciudad de Mexico, 11520, MEXICO  
Phone: +52-55-4169-7104

- **United Kingdom**

- **Anritsu EMEA Ltd.**

200 Capability Green, Luton, Bedfordshire, LU1 3LU, U.K.  
Phone: +44-1582-433200  
Fax: +44-1582-731303

- **France**

- **Anritsu S.A.**

12 avenue du Québec, Immeuble Goyave,  
91140 VILLEBON SUR YVETTE, France  
Phone: +33-1-60-92-15-50

- **Germany**

- **Anritsu GmbH**

Nemetschek Haus, Konrad-Zuse-Platz 1,  
81829 München, Germany  
Phone: +49-89-442308-0  
Fax: +49-89-442308-55

- **Italy**

- **Anritsu S.r.l.**

Spaces Eur Arte, Viale dell'Arte 25, 00144 Roma, Italy  
Phone: +39-6-509-9711

- **Sweden**

- **Anritsu AB**

Kistagången 20 B, 2 tr, 164 40 Kista, Sweden  
Phone: +46-8-534-707-00

- **Finland**

- **Anritsu AB**

Technopolis Aviapolis, Teknobulevardi 3-5 (D208.5.),  
FI-01530 Vantaa, Finland  
Phone: +358-20-741-8100

- **Denmark**

- **Anritsu A/S**

c/o Regus Winghouse, Ørestads Boulevard 73, 4th floor,  
2300 Copenhagen S, Denmark  
Phone: +45-7211-2200

- **Spain**

- **Anritsu EMEA Ltd.**

- **Representation Office in Spain**

Paseo de la Castellana, 141. Planta 5, Edificio Cuzco IV  
28046, Madrid, Spain  
Phone: +34-91-572-6761

- **Austria**

- **Anritsu EMEA GmbH**

Am Belvedere 10, A-1100 Vienna, Austria  
Phone: +43-(0)1-717-28-710

- **United Arab Emirates**

- **Anritsu EMEA Ltd.**

- **Anritsu A/S**

Office No. 164, Building 17, Dubai Internet City  
P. O. Box – 501901, Dubai, United Arab Emirates  
Phone: +971-4-3758479

- **India**

- **Anritsu India Private Limited**

6th Floor, Indiqueb ETA, No.38/4, Adjacent to EMC2,  
Doddanekundi, Outer Ring Road, Bengaluru – 560048, India  
Phone: +91-80-6728-1300  
Fax: +91-80-6728-1301

- **Singapore**

- **Anritsu Pte. Ltd.**

1 Jalan Kilang Timor, #07-04/06 Pacific Tech Centre  
Singapore 159303  
Phone: +65-6282-2400  
Fax: +65-6282-2533

- **Vietnam**

- **Anritsu Company Limited**

16th Floor, Peakview Tower, 36 Hoang Cau Street, O Cho Dua Ward,  
Dong Da District, Hanoi, Vietnam  
Phone: +84-24-3201-2730

- **P.R. China (Shanghai)**

- **Anritsu (China) Co., Ltd.**

Room 2701-2705, Tower A, New Caohejing International  
Business Center No. 391 Gui Ping Road Shanghai, 200233, P.R. China  
Phone: +86-21-6237-0898  
Fax: +86-21-6237-0899

- **P.R. China (Hong Kong)**

- **Anritsu Company Ltd.**

Unit 1006-7, 10/F., Greenfield Tower, Concordia Plaza,  
No. 1 Science Museum Road, Tsim Sha Tsui East,  
Kowloon, Hong Kong, P.R. China  
Phone: +852-2301-4980  
Fax: +852-2301-3545

- **Japan**

- **Anritsu Corporation**

8-5, Tamura-cho, Atsugi-shi, Kanagawa, 243-0016 Japan  
Phone: +81-46-296-6509  
Fax: +81-46-225-8352

- **Korea**

- **Anritsu Corporation, Ltd.**

8F, A TOWER, 20, Gwacheondaero 7-gil, Gwacheon-si,  
Gyeonggi-do, 13840, Republic of Korea  
Phone: +82-2-6259-7300  
Fax: +82-2-6259-7301

- **Australia**

- **Anritsu Pty. Ltd.**

Unit 20, 21-35 Ricketts Road, Mount Waverley, Victoria 3149, Australia  
Phone: +61-3-9558-8177  
Fax: +61-3-9558-8255

- **Taiwan**

- **Anritsu Company Inc.**

7F, No. 316, Sec. 1, NeiHu Rd., Taipei 114, Taiwan  
Phone: +886-2-8751-1816  
Fax: +886-2-8751-1817

List Revision Date: 20230901



Anritsu utilizes recycled paper and environmentally conscious inks and toner.



© Anritsu. All trademarks are registered trademarks of their respective owners. Data subject to change without notice. For the most recent specifications visit: [www.anritsu.com](http://www.anritsu.com)

11410-00780, Rev. K Printed in United States 2023-11  
©2023 Anritsu Company. All Rights Reserved.