

Field Master Pro™ MS2090A

High-Performance RF Spectrum Analyzer

9 kHz to 9/14/20/26.5/32/43.5/54 GHz

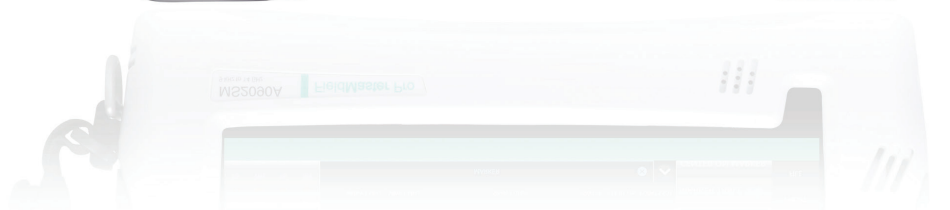

THE SKY'S

Anritsu introduces the Field Master
performance handheld



FieldMaster Pro™ MS2090A

THE LIMIT



Pro MS2090A. The world's highest
and spectrum analyzer.

No limits.

Delivering the highest levels of performance available in a handheld RF spectrum analyzer, the Field Master Pro MS2090A instrument gives field engineers and technicians unparalleled measurement accuracy previously reserved for only benchtop instruments.

No gaps.

Integrated and continuous frequency coverage from 9 kHz to 54 GHz provides the ability to view the RF spectrum and measure all transmissions in order to avoid interference.

No misses.

The built-in real-time spectrum analyzer (RTSA) provides the ultimate signal analysis and interference capture tool. RTSA spans up to 110 MHz (option dependent) and provides capabilities for cellular interference monitoring to full industrial, scientific, and medical (ISM) band signal analysis. Its unparalleled performance meets the latest 5G test challenges while maintaining support for a full range of wireless technologies in use today. The IQ capture and streaming options allow for analyzing signals in the greatest detail.

Field Master Pro MS2090A

OVERVIEW

The Anritsu Field Master Pro MS2090A high-performance handheld RF spectrum analyzer is the culmination of over 60 years of microwave test and measurement equipment development that leverages the very latest technologies to deliver performance and accuracy previously reserved for only benchtop instruments. With continuous frequency coverage from 9 kHz to 9/14/20/26.5/32/43.5/54 GHz, the Field Master Pro MS2090A is leading the way for next-generation test equipment designed to meet the unique needs of technologies used in 5G networks (millimeter-wave [mmWave] frequencies, active antenna systems, beamforming, and dynamic physical layer attributes) while maintaining support for the full range of requirements of today's wireless industries such as, wireless service providers, broadcasting, regulatory authorities, aerospace/defense, satellite systems, and radar.

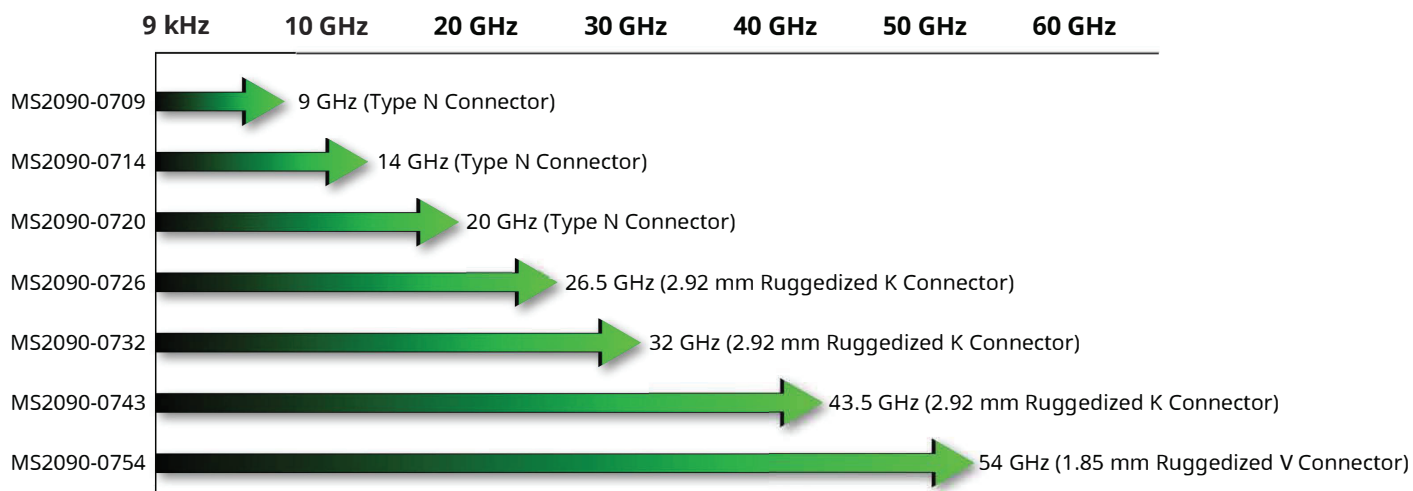

As RF technologies continue to become more ingrained in our daily lives, the RF spectrum is becoming more crowded at all frequencies. 5G radios are now being deployed at 28 GHz and 39 GHz in addition to the spectrum demands of sub-6 GHz cellular systems for mobile applications. The use of electronics in the automotive industry is growing rapidly as seen with sensors for autonomous driving becoming pervasive in today's vehicles. As we all continue to consume more data and expect faster access even in remote locations, point-to-point radio links are moving higher in frequency and expanding in bandwidth to support these demands. The ability to view the RF spectrum and measure the transmissions from all of these systems is critical in order to avoid interference and guarantee performance. The Field Master Pro MS2090A high-performance RF spectrum analyzer was developed to provide field service engineers and technicians with the unparalleled performance and functionality needed to meet the growing demands of these complex systems - all in a handheld, battery-powered instrument.

Field Master Pro MS2090A



Key RF Specifications

Parameter	Specification
Frequency range	9 kHz to 9/14/20/26.5/32/43.5/54 GHz
Analysis bandwidth	100 MHz
Demodulation	5G NR demodulation, RF and modulation quality plus SSB signal analysis
TOI	+20 dBm
DANL (with pre amp)	-164 dBm
Amp range	DANL to +30 dBm
Phase noise @ 1 GHz	-110 dBc/Hz @ 100 kHz offset (typical)
RBW/VBW	1 Hz to 10 MHz
Input SWR	1.5
Amplitude accuracy	< 14 GHz ± 1.3 dB (± 0.5 dB typ)
RTSA bandwidth	22 MHz, 55 MHz, 110 MHz (option dependent)

Key Features

Feature	Specification
Display	10.1 inch, 1280 x 800 color touchscreen
Traces	6
Detectors	Peak, RMS/Avg., Negative
Gated sweep	For time gated spectrum measurements
Markers	12, fully featured with table
Limit lines	Complex limit lines with Pass/Fail
IQ	Capture and streaming of IQ data
Connectivity	802.11
GNSS	GPS & GLONASS
Interfaces	USB 3.0, Ethernet
Battery life	>2 hours (function dependent)

Unmatched RF Performance

The Field Master Pro MS2090A device delivers the highest levels of RF performance available in a handheld, touchscreen spectrum analyzer. With a displayed average noise level (DANL) of -164 dBm and third-order intercept (TOI) of typically $+20$ dBm, measurements such as spectrum clearing, radio alignment, harmonic, and distortion are even more accurate than previously possible. For modulation measurements on digital systems, 100 MHz modulation bandwidth coupled with best-in-class phase noise performance maximizes measurement accuracy, while 0.5 dB typical amplitude accuracy provides confidence when testing transmitter power and spurious emissions.

Feature-Rich Device Enhances Usability

All Field Master Pro MS2090A models offer a comprehensive range of features that speed and simplify measurements.

- Built-in **RTSA** provides the ultimate signal analysis and interference capture tool. RTSA spans of 22, 55, 110 MHz (option dependent) with $2.05 \mu\text{s}$ POI that provides capability for cellular interference monitoring to full ISM band signal analysis.
- **IQ capture and streaming options** enable comprehensive off-line processing of IQ data. With up to 110 MHz captures bandwidth and the option to utilize the 2 GB of internal memory or continuously stream over Ethernet, USB 3.0, or a high-speed digital interface, it is possible to post-process signals to hunt for and identify the most elusive signals.
- In addition to a **full span swept-tuned spectrum analyzer and amplitude**, all versions include a **spectrogram display**. Spectrograms are a view of how the frequency content of a signal changes with time. It is especially useful when monitoring the RF spectrum for intermittent or interfering signals.
- **Integrated channel power and occupied bandwidth (OBW) measurements** simplify the analysis and characterization of common radio transmissions. Regulatory authorities typically specify limits for transmitters based on these measurements.
- The **built-in adjacent channel power (ACPR) measurement** simplifies the measurement of out-of-band transmitter emissions, which is required to speed conformance testing.

Rugged Design for Field Use

With years of experience designing instruments for the field, Anritsu knows how durable and robust test equipment needs to be. From cell sites in the extreme cold of the Antarctic to satellite earth stations on desert mountain tops, test instruments need to be ready — whatever the conditions. The durable rubber over-mold covers a hardened steel frame to protect the instrument from the knocks and blows that happen when field technicians are on-site. All connectors are protected from damage by covers or protruding instrument bezels. The large 10.1 inch color touchscreen is protected by tempered soda lime glass designed to exceed the impact protection IK08 rating and standard, protecting it against 5 joules of impact (the equivalent to the impact of a 1.7 kg mass dropped from 300 mm above the impacted surface). A grab handle is located on the side and large D rings are mounted to attach the supplied shoulder strap when required.

Field Master Pro MS2090A

High-Resolution Multi-Touch Screen and Modern User Interface Eases Usability

The Field Master Pro MS2090A spectrum analyzer features menus and a user interface developed to meet industry-standard guidelines for touchscreen instruments. Frequently used functions are immediately accessible and touching on-screen values opens up dialog boxes for rapid changes. Menus can be collapsed to maximize the trace display area or detailed trace settings can be displayed on the screen so that complex configurations are easily understood. Support for familiar, multi-touch gestures allows you to swipe and scan across the frequency range or pinch and zoom to quickly view signals of interest (SOI). A stylus stored in the carry handle facilitates the use of the screen even when wearing gloves or if you simply prefer a tool instead of your finger. The 1280 x 800 resolution screen offers excellent brightness with high-contrast color schemes. Switch between the standard color palate for normal use or a black and white high-contrast display for better visibility in direct sunlight.

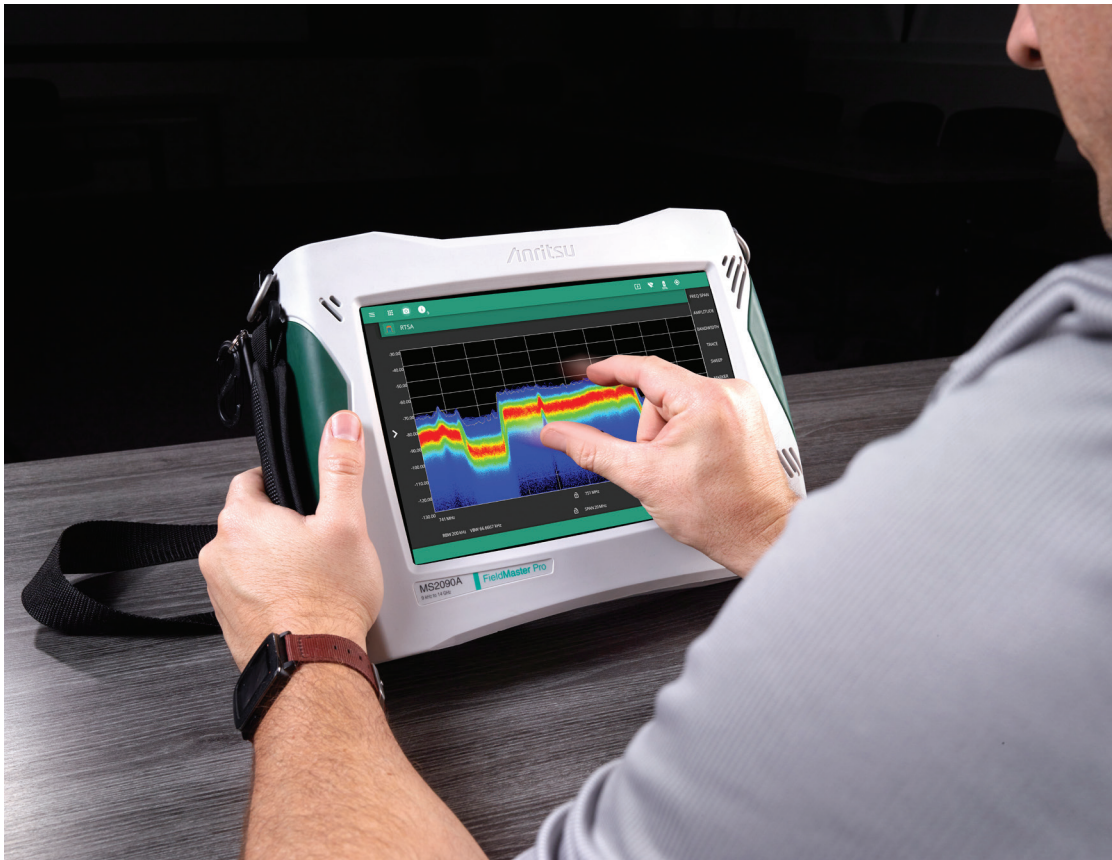

Field Master Pro MS2090A features a 10.1 inch multi-touch screen

APPLICATIONS

Interference Hunting and Spectrum Clearing

The value of RF spectrum allocations has grown rapidly as cellular and broadcast operators expand their networks. Spectrum usage is changing as older technologies, such as broadcast television or private mobile radio, are moved out of the sub-6 GHz bands and new technologies take their place. Many national regulatory authorities have auctioned and reallocated the spectrum, reassigning the frequency bands for exclusive access. In order to deploy new networks efficiently, the owners of the spectrum must clear the spectrum and validate that all legacy users have stopped all transmission. The Field Master Pro MS2090A meets the requirements for spectrum clearance with its fast sweep speeds, low distortion front-end, and spectrogram display.

Utilizing the Mobile InterferenceHunting™ MX280007A software and an omnidirectional antenna, all signals are captured across a defined frequency band. A built-in preamplifier optimizes the sensitivity of the Field Master Pro MS2090A instrument so that low-level signals are captured. The Field Master Pro MS2090A spectrum analyzer has a range of features to isolate and locate illegal or intermittent interferes.

- Interference finder option 0024 enables a smooth, fast audio response to changes in signal power
- Interfaces with the Mobile MX280007A software for a fully integrated solution
- Up to 6 traces can be individually configured to display max or min hold
- Spectrogram displays facilitate the long-term monitoring of the spectrum so that intermittent signals are captured and stored
- Power spectral density mode in the RTSA enables the identification of interfering signals that are located at the same frequency as the wanted signal but lower in power

Selecting a directional antenna, such as one of the Anritsu Yagi antennas, along with the fast sweep rate of the Field Master Pro MS2090A unit provides a clear picture of RF activity across a wide frequency range and at low power levels.



Directional antennas used with the Field Master Pro MS2090A facilitate the location of interfering signals

Field Master Pro MS2090A

APPLICATIONS (Cont'd)

Broadcast Transmitter Analysis

RF transmitters need to be tested at the time of installation and then at regular intervals to confirm they conform to regulatory requirements. The Field Master Pro MS2090A RF spectrum analyzer is ideal for a comprehensive range of transmitter measurements. Harmonic and spurious tests are required to ensure that the transmitter does not interfere with other users of the RF spectrum. These tests can be performed by connecting a cable directly to a test port or over-the-air (OTA) using an accessory antenna. The Field Master Pro MS2090A instrument also has excellent TOI performance and distortion-free dynamic range, ensuring accurate harmonic and spurious measurements to 54 GHz (option dependent).

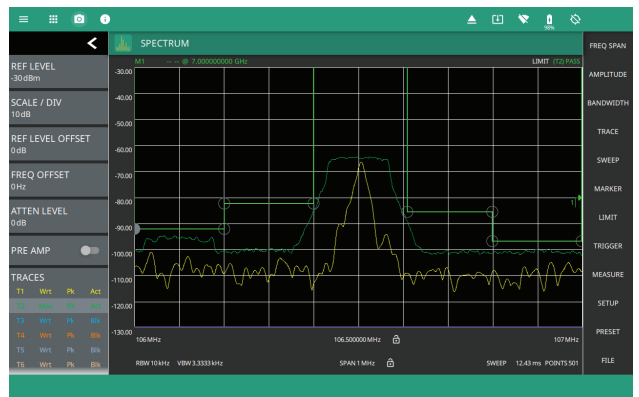

Cross-Border Interference

Cross-border interference between cellular networks has become a significant issue at many international borders. Regulatory authorities often require a measurement of field strength or power flux density (PFD) from the operator before they will initiate any compliance enforcement with the interfering party. The Field Master Pro MS2090A's interference finding features can also be used with its field strength and PFD measurements to check test power levels and create reports required by regulatory authorities for reporting possible power violations. With the field strength setting, users can apply antenna factors either from Anritsu's broad list of tested antennas or from a custom file, giving amplitude results in dBm/m². Those same factors can be applied to any measurement, including the channel power measurement where the user can then read out the PFD in units of dBm/m²/MHz.

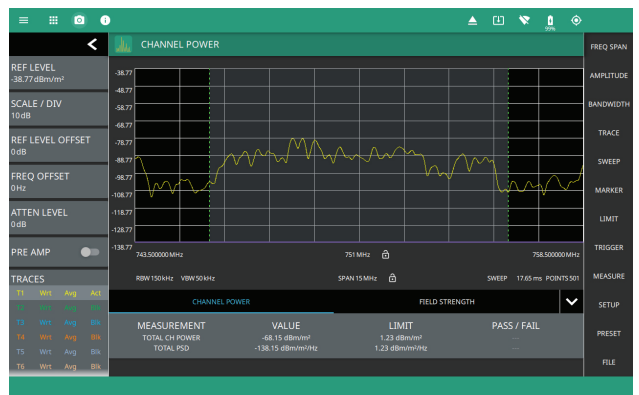

Field Master Pro MS2090A

APPLICATIONS *(Cont'd)*

Microwave Radio Links

Microwave radio links have become central building block of cellular and data networks. Installation crews need to align the radios over distances from a few tens of meters to several kilometers. The Field Master Pro MS2090A spectrum analyzer has frequency options to 54 GHz with exceptional sensitivity for dish alignment. Using a waveguide horn antenna, the power and modulation bandwidth can be verified at installation and during maintenance testing.



Pulse Radar Measurements

The wide bandwidth of the Field Master Pro MS2090A enables detailed analysis of pulsed radar signals. In zero span the default bandwidth is 40 MHz and the minimum sweep time is 60 ns, with pulse rise time measurements as short as 20 ns. Up to 12 markers can be positioned on the traces to simplify pulse repetition, pulse width, and rise time measurements. In zero span a fixed frequency IF output option is also available to interface with external analysis tools. To get fully automated pulse characterization with measurements made in compliance with IEEE Std-181-2003, add pulse analyzer option 0421.

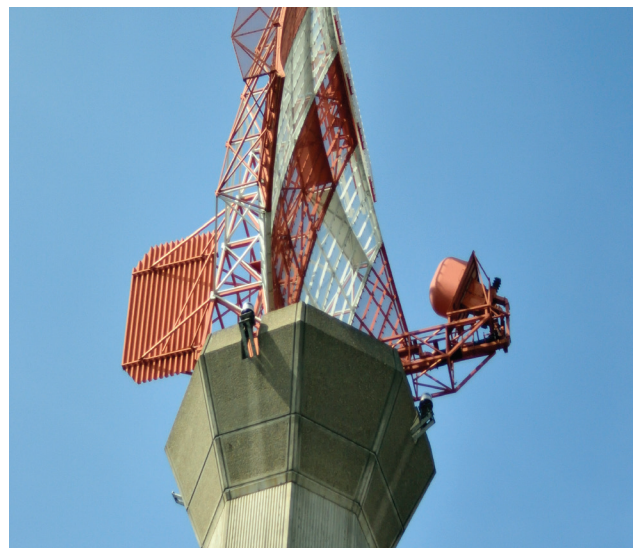

Satellite System Monitoring

The United Nations Office for Outer Space Affairs estimates there are close to 2,000 active satellites orbiting the earth. Each of these communicates with the ground through dedicated earth stations. Common frequencies for satellite communications have been in the 2 to 4 GHz bands and 4 to 8 GHz bands. Now new bands are opening up in the 12 to 18 GHz, 26 to 40 GHz bands, and even 36 to 50 GHz. As the number of satellites increase so does the opportunity for interference between all the communications. The Field Master Pro MS2090A is ideal for monitoring downlink signals to search for interference and noise.



OPTIONS

Option 0888 5G NR Base Station Measurements

The rapid introduction of 5G NR networks requires an instrument that can validate the performance of the gNB base stations quickly in a field environment. In both the 3.5 GHz bands and the (mmWave) 28 GHz and 39 GHz bands, the adoption of active antenna systems means that new test methods need to be considered. Some radios may have test monitor ports integrated, but many operators will make gNB transmitter measurements OTA.

The Field Master Pro MS2090A high-performance spectrum analyzer performs the essential measurements in full compliance with the 3GPP TS 38.104 V15. Measurements supported include:

Frequency Error	Unwanted Emissions	Carrier Aggregation (Up to 8 Carriers)
Time Offset	Occupied Bandwidth	
Cell/Sector ID	Adjacent Channel Leakage Ratio	
Modulation Quality (EVM)	Transmitter Spurious to 12.75 GHz	
	EIRP	
	SS-RSRP, SS-RSRQ, SS-SINR	

A key part of 5G NR signals is the synchronization signal block (SSB). Decoding the SSB can reveal the important cell characteristics, like cell ID, frequency error, and beam powers. Making measurements on the SSB allows transmitter testing on a live gNB. As well as displaying beam ID, the RSRP is graphed for each of the beams in the SSB. In order to properly decode the signal, the user must know center frequency, bandwidth, and subcarrier spacing of the signal under test. This can be entered manually or by using a 3GPP-defined band and absolute radio-frequency channel number (ARFCN). It is also critical to know the frequency position of the SSB relative to the center frequency of the signal. This can also be entered manually as an offset from center or by entering the global synchronization channel number (GSCN). In cases where the SSB location is unknown, the Field Master Pro MS2090A has an Auto SSB Detect feature that searches the 3GPP-defined raster of potential SSB positions to find it automatically. In some cases, especially in mmWave, a single transmitter can be transmitting up to eight carriers simultaneously. The Field Master Pro MS2090A has a carrier aggregation feature that allows up to eight individual carriers to be set up and measured sequentially in a loop to ensure all are working correctly.

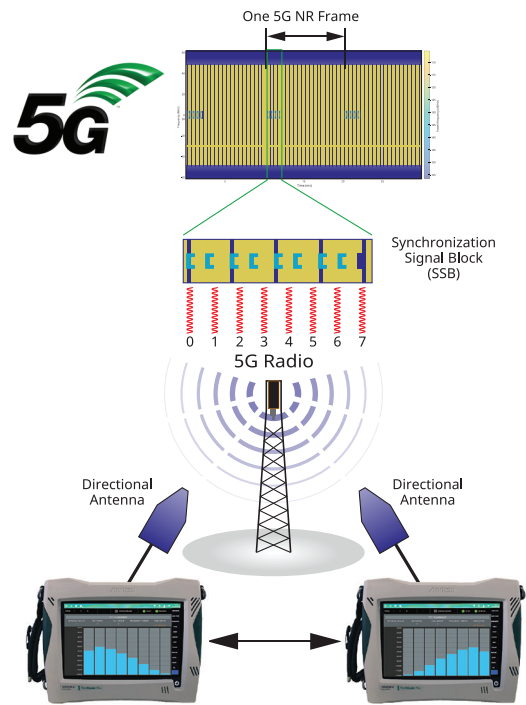

Field Master Pro MS2090A displays RSRP vs. beam index based on OTA analysis of the 5G NR SSB

Field Master Pro MS2090A

OPTIONS (Cont'd)

Where direct access to an RF test connector is not possible, 5G NR installation testing must be performed OTA with a directional antenna or waveguide horn antenna. Because the SSB is always transmitted, the easiest way to test an active gNB is to make measurements on these elements. The Field Master Pro MS2090A decodes all active beams in the signal, typically 8 beams for radios in the 3 to 6 GHz bands and 12 to 64 beams in the mmWave bands around 28 GHz and 39 GHz. A measurement summary screen displays all the essential results to validate base station performance.

In cases where multiple cells are present, it may be helpful to use an omnidirectional antenna to measure the relative power of the different cells and track handover points where the power of two cells is close to equal. The Field Master Pro MS2090A offers a Multi PCI measurement that utilizes advanced software processing to detect all active beams in a given location. The PCI, RSRP, SINR, and EVM of each beam is returned and can then be displayed as an RSRP histogram or as a table to summarize all results.

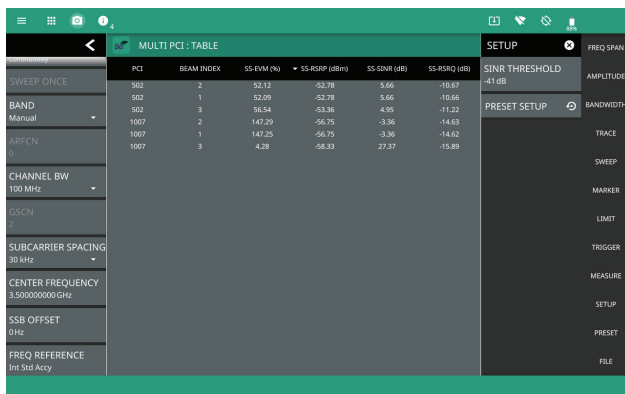
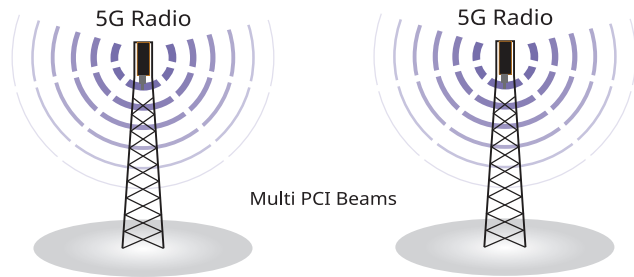

Field Master Pro MS2090A

Field Master Pro MS2090A offers Multi PCI measurements for OTA testing of one or more 5G NR gNB

Many 5G mmWave gNB transmit four 100 MHz carriers to increase total throughput from a single cell site. These carriers share a common cell ID but have unique ARFCN, GSCN, and SSBs and each needs to be decoded individually. The Field Master Pro MS2090A option supports carrier aggregation measurements as standard. Up to eight carriers with unique settings can be configured and decoded in sequence. The screen displays each carrier power in bar graph format, including the RSRP of the beam with the best SINR, with cell information listed in a table below.

Field Master Pro MS2090A

OPTIONS (Cont'd)

A range of 3GPP-compliant spectrum measurements are supported. To measure gNB transmit power, the Field Master Pro MS2090A instrument includes EIRP and channel power measurements. Both are made OTA using a waveguide horn or broadband antenna to receive the signal. In cases where the gNB can be put into test modes and test model waveforms transmitted, a gated sweep feature enables measurements to be made on defined symbols in the 5G frame. OBW, ACP, and spectral emission mask (SEM) measurements have pre-configured setups to speed testing.



Automated occupied bandwidth measurement result for a 100 MHz 5G NR radio

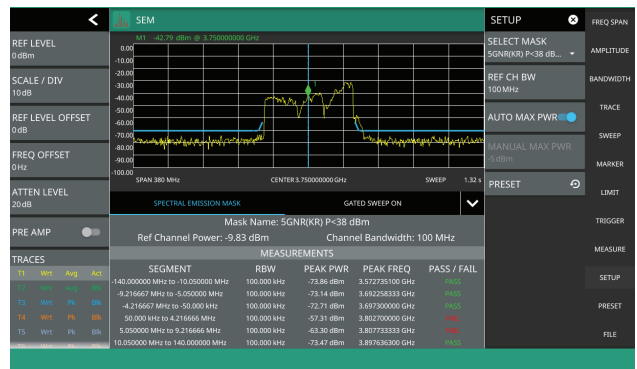

OTA SEM measurement on a 5G NR transmission with pass/fail results

The Field Master Pro MS2090A is designed to support EIRP measurements according to 3GPP definition. Section 6 of TS 38.141-2 provides specific definitions and instructions for measuring radiated transmit power. By utilizing a dual polarized directional antenna, users can save the EIRP from each pole and the Field Master Pro MS2090A software will sum them to provide a total EIRP, which equates to the total radiated power of the radio.

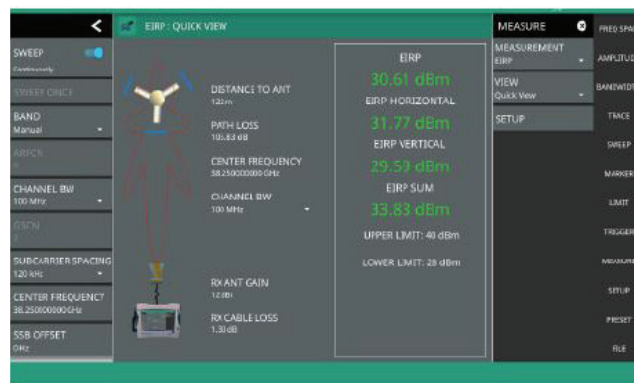

The EIRP results "Quick View" screen provides a graphical display of measurement configuration and total EIRP power

Field Master Pro MS2090A

OPTIONS (Cont'd)

Option 0883 LTE Base Station Analyzer

The Field Master Pro MS2090A features several measurements for installation and maintenance of LTE FDD radios. The goal of these measurements is to help maximize data rate and capacity with accurate power settings, ensuring low out-of-channel emissions and good signal quality. These attributes help to create a low dropped call rate, a low blocked call rate, and a good customer experience. LTE sites also play a critical role in most early 5G deployments, acting as the anchor to 5G communications. Cell site technicians or RF engineers can make measurements OTA to spot-check a transmitter's coverage and signal quality without taking the cell site off-line. When the OTA test results are ambiguous, one can directly connect to the base station to check the signal quality and transmitter power.

The Field Master Pro MS2090A offers the following LTE measurements:

- Cell ID, Sector ID, Cell Group
- Frequency Error
- Time Offset
- PBCH, RS and SS Power
- Signal Quality (EVM)
- PBCH
- PDSCH (QPSK, 16QAM, 64QAM, 256QAM)
- MIMO Antenna Power and Time Alignment Error (TAE)
- Channel Power
- Occupied Bandwidth
- ACLR and Spectral Emissions Masks
- Time Alignment Error
- Resource Block Usage
- OFDM Symbol Transmit Power (OSTP)
- Carrier Aggregation
- Multi PCI Scanner

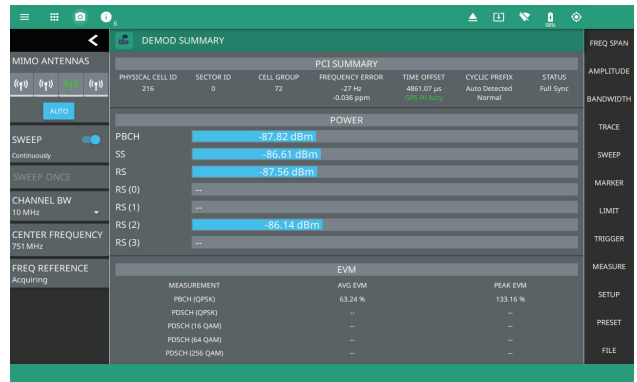
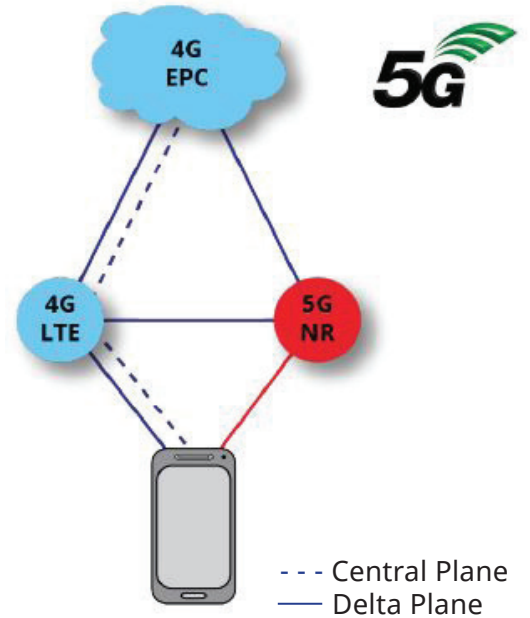

LTE results summary display

Field Master Pro MS2090A

OPTIONS (Cont'd)

Option 0199 Real-Time Spectrum Analyzer

For many spectrum and network stakeholders, basic spectrum sweeps may not give enough information. The RTSA option provides real-time signal capture with 110 MHz bandwidth and the ability to capture signals down to a 2.05 μ s duration with 100% POI at full amplitude. This provides unrivalled insight into interference in the wireless spectrum, capturing interfering signals that are too short in duration to be seen with conventional spectrum analyzers yet may be degrading system performance. A power spectral density display shows the relative time that RF power is present at all levels and frequencies within the capture span. This is a powerful tool to find interfering signals within the same band as known/wanted signals. The spectrogram displays the maximum output of the RTSA FFT over time with settable 50 ms to five seconds resolution. The spectrogram provides a history of spectral activity enabling intermittent interferers to be detected and recorded.



RTSA with spectrogram display provides detailed insight into signal behavior

Option 0124 IQ Capture

Field Master Pro MS2090A also offers options for IQ Waveform Capture (Option 0124) and IQ Waveform Streaming (Option 0125) to enable detailed offline analysis of signals captured OTR. The 2 GB of internal memory is allocated to IQ captures, enabling data capture at 200 mega samples per second with 110 MHz capture bandwidth for up to five seconds. Once captured, data files can be exported by USB memory devices to a PC for post processing. The single capture mode triggers one event and then waits for a new trigger event before initiating further captures. The continuous capture mode initiates sequential captures to a new file without additional triggering until stopped by the user.



Free Run, External, Video, and Level Trigger options are available in the RTSA mode to initiate IQ data capture

Field Master Pro MS2090A

OPTIONS (Cont'd)

Option 0125 IQ Streaming

For users who need more data over a longer period of time, the Field Master Pro MS2090A supports gapless streaming of data over Ethernet, USB 3.0, or directly to the IQC5000B series RF record and playback system from Bird Technologies (bandwidths dependent on transfer speeds).

Following the capture of IQ data, post processing on a PC is used to analyze the signal in greater detail. Information on the IQ data format is explained in detail in the instrument user guide for anyone using custom Matlab, Python, etc. tools. Field Master Pro MS2090A IQ files can also be analyzed by commercial IQ analysis applications. Field Master Pro MS2090A data can be easily converted to .xdat format for evaluation with Bird Technologies' Spectro-X data analysis tool.

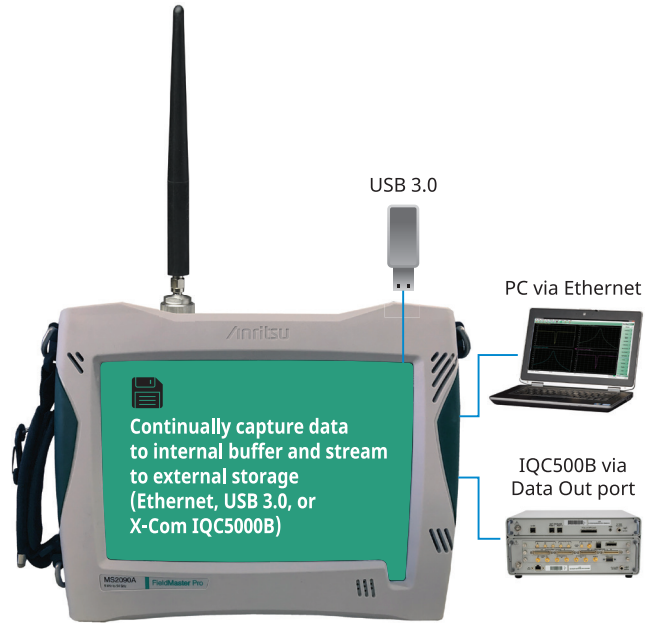

Continuous update of the RTSA is supported even when streaming IQ data

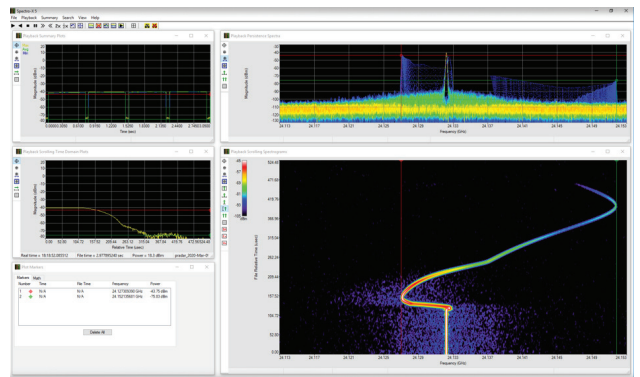

IQ file compatibility with Bird Spectro-X software for post-processing can highlight detailed information on a radar pulse pre- and post-signal drift with μs resolution

Field Master Pro MS2090A

OPTIONS (Cont'd)

Option 0444 EMF Measurements (9 KHz to 6 GHz)

As networks get denser and new radio transmissions are added to the environment, it is critical to monitor the electric field power levels to ensure public safety. The Field Master Pro MS2090A offers two solutions for regulators or network operators to make measurements of the electromagnetic field (EMF). Option 0444 EMF measurement uses a standard spectrum analyzer sweep and a tri-axial isotropic antenna to measure field strength in frequency-specific bands in all spatial directions. This is useful for both LTE and 5G FR1 to ensure radios are not transmitting excessive power. Three antennas are supported providing frequency coverage from 9 kHz to 6 GHz. Antennas are individually calibrated and the instrument reads the calibration data through the USB interface. The same interface is used to switch rapidly between the three antenna orientations to provide complete three axis isotropic measurements. Field Master Pro MS2090A displays the results of each axis on the spectrum display and a table presents a summary of measurements, including peak and average field strength and measurement time.

Option 0445 EMF Meter (20 MHz to 40 GHz)

Once measurements are initiated, the results are displayed as a peak and average bar chart with the current field strength reading as a percentage of ICNIRP limits. The two meter interface cable between the instrument and probe enables the probe to be cycled between ground level and up to two meters above the ground to identify field strength maximums. Up to 16 measurement positions can be recorded at a given test site, for example on a rooftop where a new 5G mmWave radio is being installed. Results can be saved to memory for later analysis and report generation.



Field Master Pro MS2090A with the 2000-1791-R Isotropic Antenna

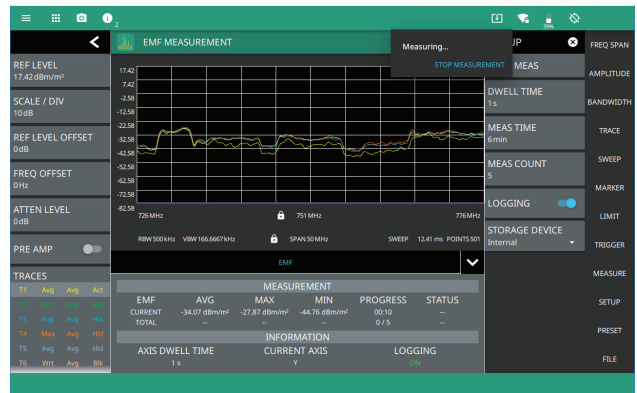

EMF results show power from each antenna axis and summary results for peak and average power over a defined time period



Field Master Pro MS2090A mmWave EMF Meter with 2000-1985-R EMF Probe

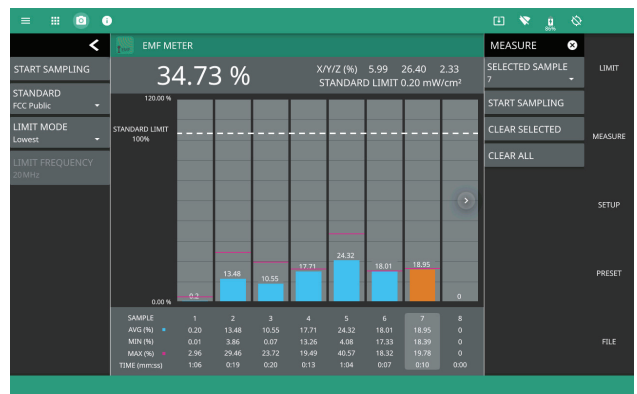

EMF meter displays percentage of ICNIRP limit over time at up to 16 positions at any given site

OPTIONS (Cont'd)

Option 0400 and 0407 Vision Monitor Software

Vision Monitor software options 0400 and 0407 offer a range of applications for monitoring the RF spectrum over a period of time and storing results to a database. Vision Monitor is an ideal tool for long-term interference monitoring. Limits can be set with automated alarms for limit violations to capture short-term or intermittent signals. Other features include a scanner option that enables the monitoring of a range of frequency bands or channels over time, with unique settings for each channel being monitored. A multi-trace view shows the spectrum for all channels being monitored on the same display.

The Vision Monitor application is fully automated. Measurements can be captured and periodically uploaded to a database for further processing. Depending on need and storage capacity, users can store spectrum history over many months or years with a user-defined capture assigned schedule.

All spectrum measurement databases are searchable, allowing the user to quickly locate patterns of signal activity relevant to an investigation. The spectrum history can also potentially be used in legal proceedings for documenting illegal or unlicensed broadcast activity. Other functions provided by Vision Monitor include:

- Threshold and trace mask settings for alarm generation
- Email alert is sent when threshold violation generates an alarm
- Reporting on spectrum integrity on a daily or weekly basis
- Vision™ runs on a PC/laptop using the Windows® operating system (Windows 7/8/10)

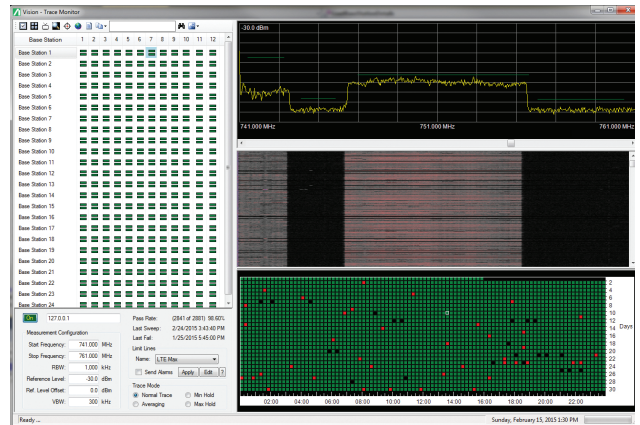

Vision Monitor simultaneously displays current spectrum, spectrogram, and pass/fail history over extended time period on a single screen



Vision Monitor Trace Viewer provides live spectrum analysis from multiple channels on a single screen for wide area monitoring

Field Master Pro MS2090A

OPTIONS (Cont'd)

Mobile InterferenceHunter (MIH) MX280007A

Anritsu's Mobile InterferenceHunter MX280007A is a quick and reliable way to find single or multiple sources of interference that are degrading the performance of an RF communications network. MIH can distinguish between multiple signal sources, reflections, RF shadows, drifting signals, bursty signals, and multi-path transmitters making it a cost effective solution for a wide range of interferers.

Interference hunting is achieved by applying proprietary algorithms to channel power data captured with geolocation positioning information during an area drive in a vehicle.

When used with Field Master Pro MS2090A, MIH provides interference hunting and spectrum clearing capability from 9 kHz to 54 GHz. The Mobile InterferenceHunter MX280007A is a quick, reliable, and multi-emitter enabled solution to InterferenceHunter MX280007A and spectrum clearing needs.



MIH system installation with large in vehicle display and omni antenna on roof

Option 0421 Pulse Analyzer Measurements

The pulse analyzer option for Field Master Pro MS2090A provides automated measurements and characterization of pulse signals. Pulsed RF signals are common in military and civil radar as well as industrial sensors and medical therapeutics. Validating the performance of any pulsed RF system will require detailed knowledge of the pulse characteristics. The Field master Pro MS2090A pulse analyzer option automates the capture and display of pulsed signals, providing a comprehensive readout of all standard measurements. The large 10.1 inch screen provides graphical display and numeric results on a single screen. Common pulse measurements (including pulse power, peak power, rise/fall time, and pulse width and repetition frequency) are all calculated automatically. Rise times as short as 20 ns can be measured when option 0104 is enabled. Simply set up the trigger level, trigger delay, and capture time to display the pulse graphically on the display and all measurements are performed automatically. The position of key parameters, including 10% and 90%, rise time and peak power are highlighted by on screen marker lines. To ensure measurement traceability, all pulse measurements are compliant to IEEE Standard for Pulses and Related waveforms (181-2011).

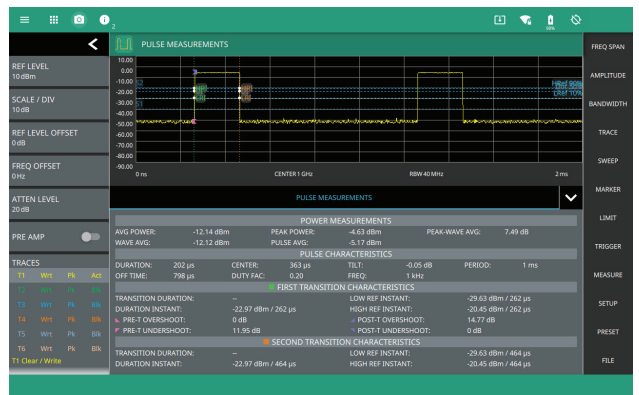

OPTIONS (Cont'd)

Option 0024 Interference Hunter

Having confirmed the presence and frequency of an interfering signal with the RTSA, the next task is to pinpoint its location. If the location is completely unknown, the MIH provides the best route to locate the location within a block in urban environments. The interference hunter mode is ideal for locating an individual building or even a specific floor within a building. The interference hunter measurement is used in conjunction with a directional antenna to locate the direction of an interfering signal. This test measures the integrated power of a received signal over a specified frequency range. During the measurement, the instrument emits an audio tone that coincides with the power of the received signal. As the antenna is pointed toward the signal source, the signal level increases further into the set max and min level, and the audio increases in pitch. Simply pointing the antenna towards the source of interference causes the tone to increase in pitch and level, speeding the location search of even the most elusive of signals.

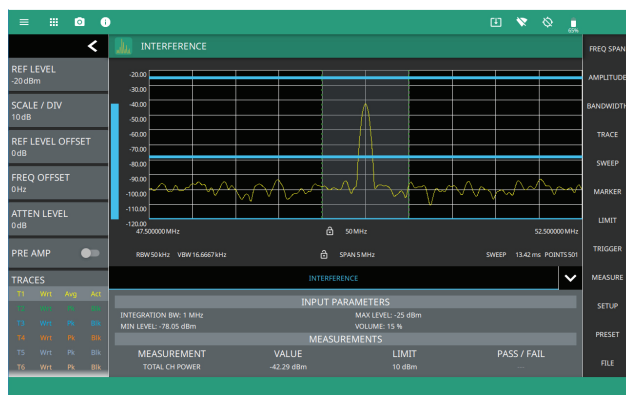
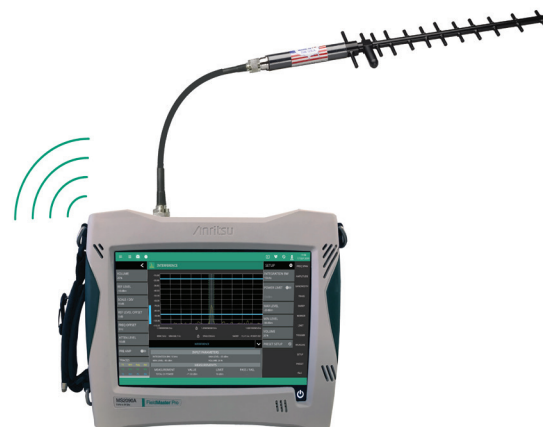

Interference Finder Option 0024 provides fast audio tone response to changing interference levels

Field Master Pro MS2090A

OPTIONS (Cont'd)

5G Coverage Mapping

Coverage mapping provides a clear representation of the signal strength of 5G transmitters over intended geographic area. The Field Master Pro MS2090A spectrum analyzer is configured to continuously measure RF data including 5G channel power, EIRP, or RSRP. When used with the NEON[®] Signal Mapper MA8100A, the results are graphically displayed on a digital map or building floor plan. The NEON Signal Mapper MA8100A supports outdoor coverage mapping using GPS coordinates taken from the Field Master Pro MS2090A instrument's built-in Global National Satellite System (GNSS) receiver and indoor coverage mapping using the NEON Tracking Unit.

The NEON Signal Mapper MA8100A solution consists of a NEON Tracking Unit, NEON Signal Mapper Software for Android devices, and NEON Command Software for a PC. For indoor coverage mapping, the NEON Tracking Unit supports the collection and processing of sensor data that delivers 3D location information. The NEON Tracking Unit connects to the NEON Signal Mapper MA8100A application that is run on an Android device. The NEON Signal Mapper MA8100A application provides an intuitive Android user interface, enabling trained users to map RF signals within buildings. RF data is captured by Field Master Pro MS2090A unit and the data is sent to the Android device. For outdoor coverage mapping applications, the Field Master Pro MS2090A instrument provides both location and RF data directly to the Android device. The application shows which SSB beam is recording the highest signal level for each data point when the user is in 5G demod mode.

Twelve markers facilitate the rapid identification and analysis of all signals on the screen whether delta or fixed. The combined spectrum and spectrogram display shows activity over time in a given spectrum band. In dynamic environments, such as the 2.4 GHz ISM band, and Wi-Fi activity can be recorded over time to assess the spectral occupancy. Six cursers positioned in the spectrogram time domain define the active spectrum traces.

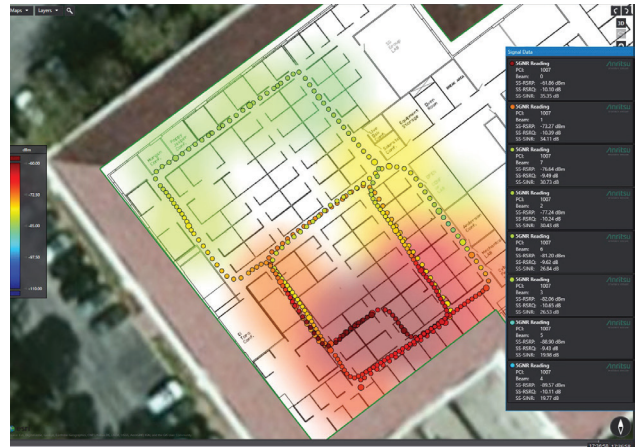

Typical result screen for indoor coverage mapping



Typical result screen for outdoor coverage mapping

Field Master Pro MS2090A

KEY FEATURES

Multiple Traces and Detectors

Up to six traces can be displayed simultaneously, with each trace able to use different detector and averaging. Each trace is color-coded with an information table highlighting the detector type, averaging, and status of each active trace.

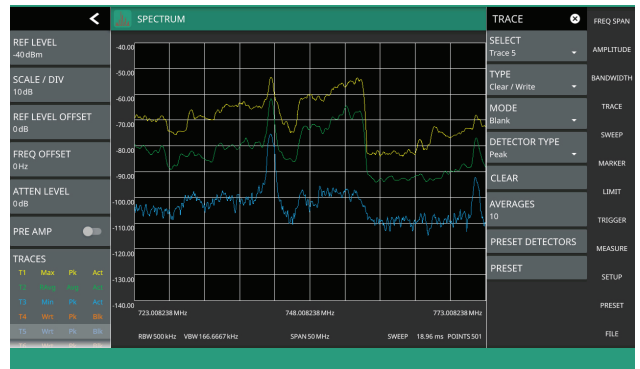

Comprehensive Markers

Markers, with detailed results table, enable recording and archiving of results. A noise maker can be activated for noise power measurements in a 1 Hz bandwidth, and each marker can be set to initiate a true frequency count at the end of a sweep. Peak search options can be seen by double tapping a marker to open the search option.

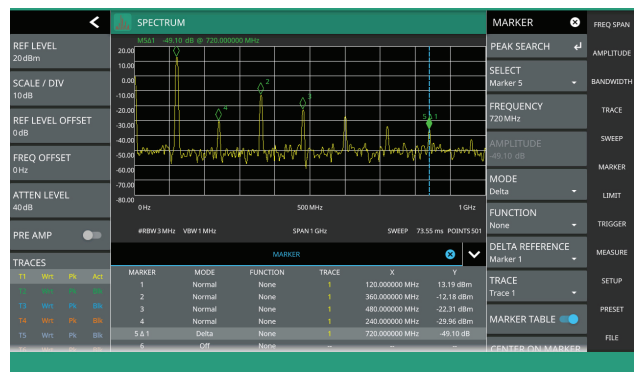

Limit Lines with Pass/Fail

Flexible limits, from simple maximum level lines to complex envelope shapes, provide automated pass/fail indication and can be used to trigger remote alarms. Limits can be entered manually to conform to international standards or automatically generated based on the signals measured in the current trace. The instrument will save the trace data any time the trace crosses a limit line. This is useful in the case of intermittent interference where the user can set the limit line and capture the right information automatically when it crosses the line.

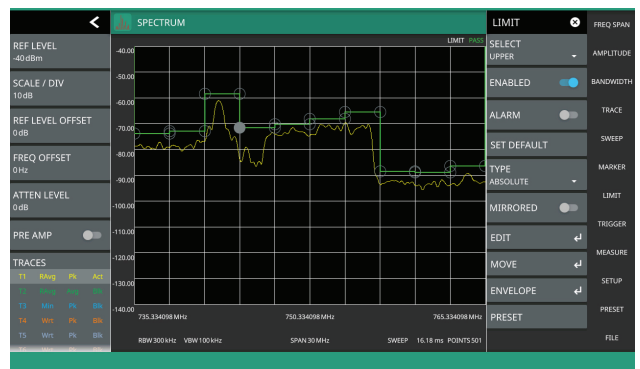

Zero Span

Selecting zero span in the spectrum analyzer mode enables the analysis of pulsed and time varying signals. Zero span is ideal for capturing the profile of short duration radar pulses and validating the length of data packets in wireless systems. Comprehensive markers facilitate the measurement of pulse width, pulse repetition frequency, and pulse rise time. A 40 MHz resolution bandwidth in zero span allows a minimum sweep time of 60 ns to be set and measurement of rise time as short as 60 ns to be measured.

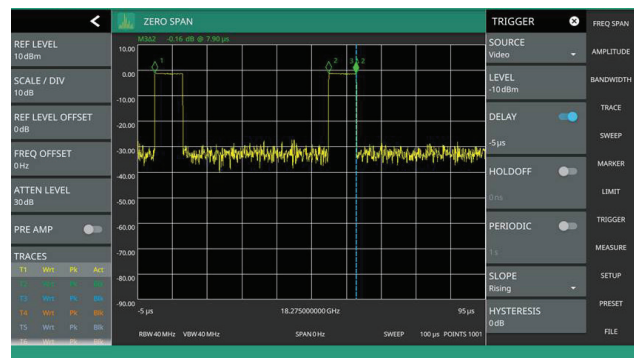

Field Master Pro MS2090A

KEY FEATURES (Cont'd)

Spectrogram

The combined spectrum and spectrogram display shows activity over time in a given spectrum band.

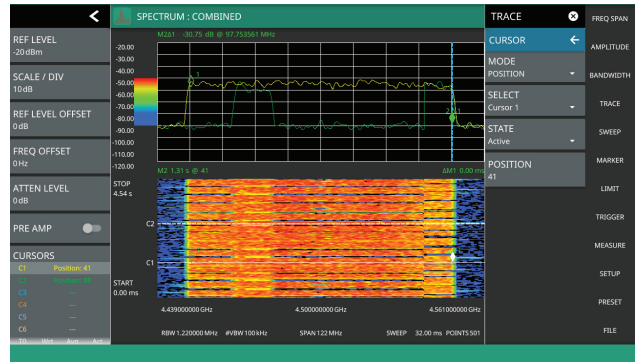

Smart Measurement

The Field Master Pro MS2090A includes smart measurements for channel power, occupied bandwidth, adjacent channel power, and spectral emission mask. Smart measurements provide dedicated set up menus to quickly configure the instrument and display results in industry-standard formats. For TDD radios, a gated sweep feature captures data only when the radio is transmitting, providing accurate and stable measurement results.

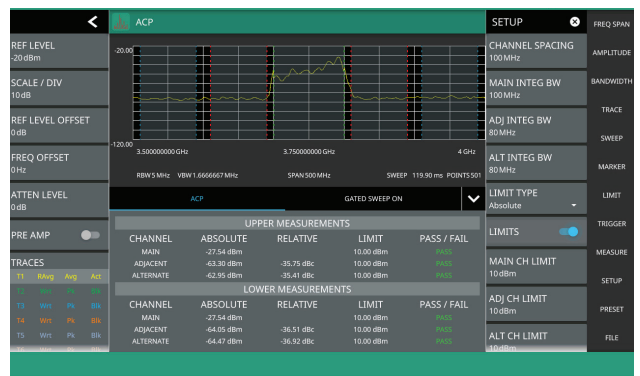

Ethernet and Wi-Fi®Connectivity

Full remote control of all instrument functions are available using the standard Ethernet interface. The Field Master Pro MS2090A conforms to standard SCPI protocols. 802.11b/g/a/n connectivity is also supported. The Field Master Pro MS2090A connects to Wi-Fi routers enabling remote control of the instrument using IP protocols. A remote desktop tool comes standard with the Field Master Pro MS2090A solution, enabling control of the device over an internet and Wi-Fi connection from any location.

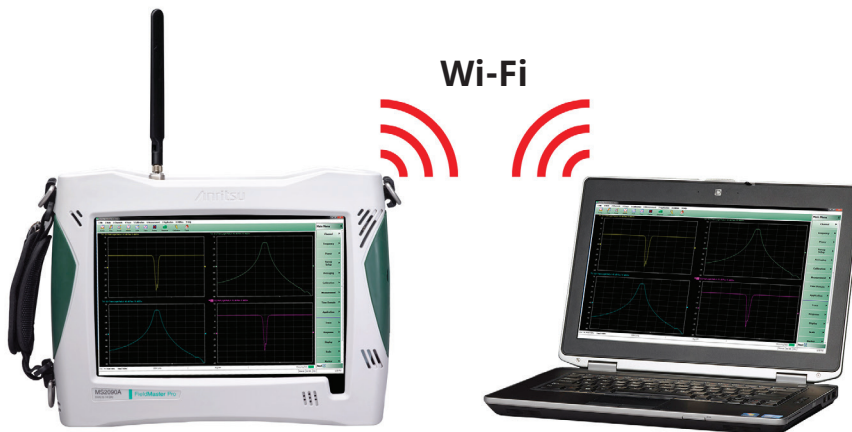

Field Master Pro MS2090A

Laptop PC
(in Hot Spot Mode)

Field Master Pro MS2090A

Comprehensive Interface Selection

The Field Master Pro MS2090A spectrum analyzer comes standard with: 3 x USB 3.0 type A host ports; 1 x USB 3.0 Type C device port; and, Data Out and microSD interfaces. USB 3.0 host interfaces can be used to save screen images such as a .png file, IQ data files, IQ data streaming, and facilitate software or option updates. The Data Out port is used for high-speed IQ streaming. USB Type C and microSD are provided to support future applications.

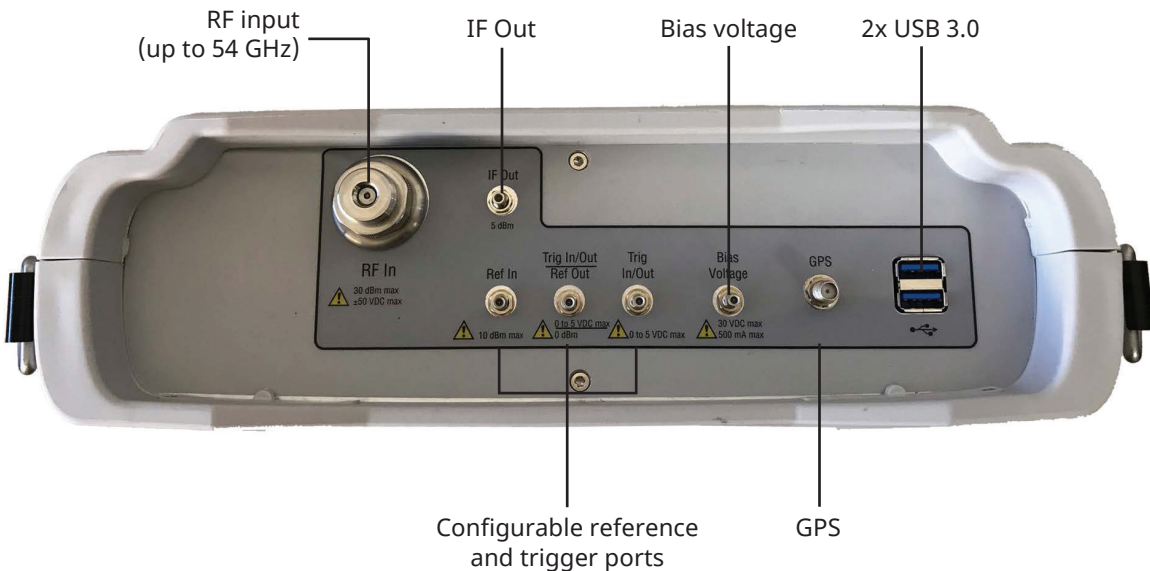
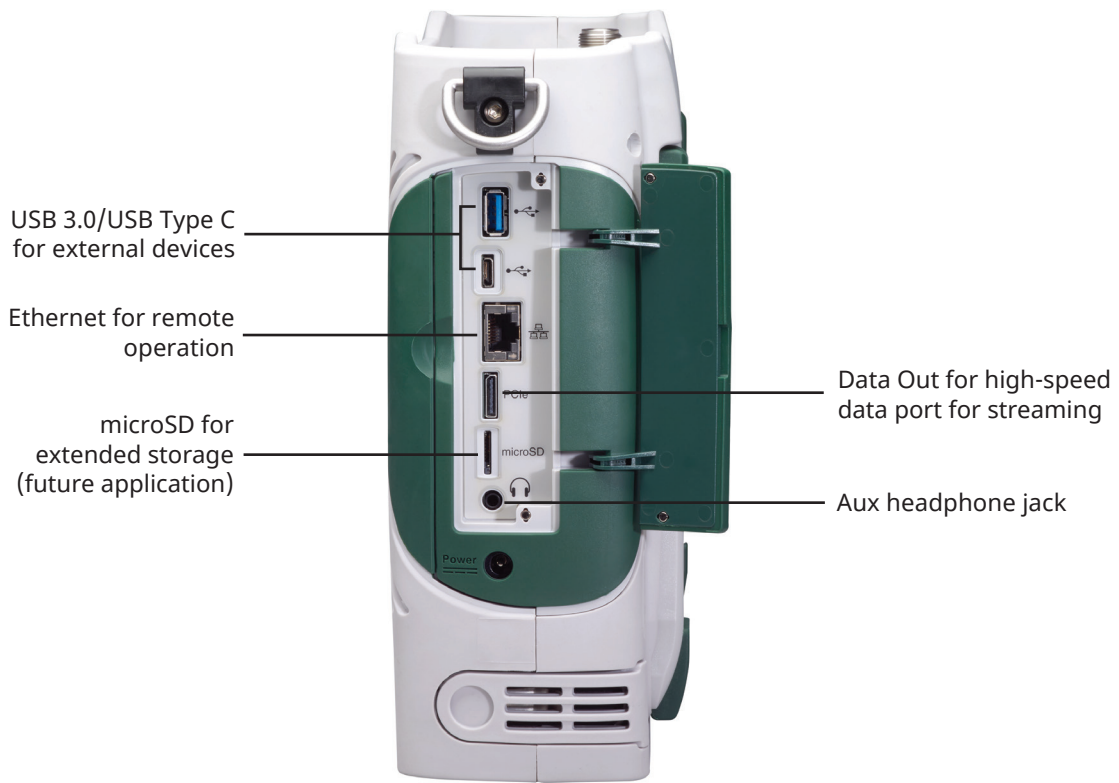

Ordering Information

PartNumber	Description
MS2090A	Field Master Pro (Requires Option 709, 714, 720, 726, 732, 743, or 754)
Options	
MS2090A-0709	Frequency Range 9 kHz to 9 GHz
MS2090A-0714	Frequency Range 9 kHz to 14 GHz
MS2090A-0720	Frequency Range 9 kHz to 20 GHz
MS2090A-0726	Frequency Range 9 kHz to 26.5 GHz
MS3090A-0732	Frequency Range 9 kHz to 32 GHz
MS2090A-0743	Frequency Range 9 kHz to 43.5 GHz
MS2090A-0754	Frequency Range 9 kHz to 54 GHz
MS2090A-0024	Interference Hunter
MS2090A-0031	GPS Receiver (Requires GPS Antenna, Sold Separately)
MS2090A-0089	Zero Span IF Output
MS2090A-0090	Gated Sweep
MS2090A-0103	50 MHz Analysis Bandwidth
MS2090A-0104	100 MHz Analysis Bandwidth
MS2090A-0124	IQ Waveform Capture
MS2090A-0125	IQ Waveform Streaming (Requires Option 124)
MS2090A-0126	IQ Waveform Capture (Non Export Controlled)
MS2090A-0127	IQ Waveform Streaming (Non Export Controlled, Requires Option 126)
MS2090A-0199	Real-Time Spectrum Analyzer
MS2090A-0883	LTE FDD Summary Measurements (Requires GPS Option MS2090A-0031)
MS2090A-0888	5G NR Downlink Measurements (Requires GPS Option MS2090A-0031)
MS2090A-0400	Vision Monitor Enabled
MS2090A-0407	Vision High-Speed Port Scanner Enabled
MS2090A-0421	Pluse Analyzer
MS2090A-0444	EMF Measurement (Frequency Selective, Requires Anritsu Istropic Antenna)
MS2090A-0445	EMF Meter Enabled (Broadband, Requires 2000-1985-R Isotropic EMF Probe, 20 MHz to 40 GHz)
MS2090A-xxxx-0097	Accredited Calibration to ISO17025 and ANSI/NCSL Z540-1 (xxxx is the Frequency Option Number)
MS2090A-xxxx-0098	Standard Calibration to ISO17025 and ANSI/NCSL Z540-1 (xxxx is the Frequency Option Number)
MS2090A-xxxx-0099	Premium Calibration to ISO17025 and ANSI/NCSL Z540-1 Plus Test Data (xxxx is the Frequency Option Number)

For a full list of all accessories for the Field Master Pro MS2090A, please refer to the Technical Data Sheet (P/N 11410-01000).

• **United States**

Anritsu Company

450 Century Parkway, Suite 190, Allen,
TX 75013 U.S.A.
Phone: +1-800-Anritsu (1-800-267-4878)

• **Canada**

Anritsu Electronics Ltd.

700 Silver Seven Road, Suite 120,
Kanata, Ontario K2V 1C3, Canada
Phone: +1-613-591-2003
Fax: +1-613-591-1006

• **Brazil**

Anritsu Eletrônica Ltda.

Praça Amadeu Amaral, 27 - 1 Andar
01327-010 - Bela Vista - Sao Paulo - SP - Brazil
Phone: +55-11-3283-2511
Fax: +55-11-3288-6940

• **Mexico**

Anritsu Company, S.A. de C.V.

Bldv Miguel de Cervantes Saavedra #169 Piso 1, Col. Granada
Mexico, Ciudad de Mexico, 11520, MEXICO
Phone: +52-55-4169-7104

• **United Kingdom**

Anritsu EMEA Ltd.

200 Capability Green, Luton, Bedfordshire LU1 3LU, U.K.
Phone: +44-1582-433200
Fax: +44-1582-731303

• **France**

Anritsu S.A.

12 avenue du Québec, Batiment Iris 1-Silic 612,
91140 VILLEBON-SUR-YVETTE, France
Phone: +33-1-60-92-15-50
Fax: +33-1-64-46-10-65

• **Germany**

Anritsu GmbH

Nemetschek Haus, Konrad-Zuse-Platz 1
81829 München, Germany
Phone: +49-89-442308-0
Fax: +49-89-442308-55

• **Italy**

Anritsu S.r.l.

Via Elio Vittorini 129, 00144 Roma Italy
Phone: +39-06-509-9711
Fax: +39-6-502-2425

• **Sweden**

Anritsu AB

Isafjordsgatan 32C, 164 40 KISTA, Sweden
Phone: +46-8-534-707-00

• **Finland**

Anritsu AB

Teknobulevardi 3-5, FI-01530 VANTAA, Finland
Phone: +358-20-741-8100
Fax: +358-20-741-8111

• **Denmark**

Anritsu A/S

c/o Regus Winghouse, Ørestads Boulevard 73, 4th floor,
2300 Copenhagen S, Denmark
Phone: +45-7211-2200

• **Russia**

Anritsu EMEA Ltd.

Representation Office in Russia

Tverskaya str. 16/2, bld. 1, 7th floor.
Moscow, 125009, Russia
Phone: +7-495-363-1694
Fax: +7-495-935-8962

• **Spain**

Anritsu EMEA Ltd.

Representation Office in Spain

Edificio Cuzco IV, Po. de la Castellana, 141, Pta. 5
28046, Madrid, Spain
Phone: +34-915-726-761
Fax: +34-915-726-621

• **United Arab Emirates**

Anritsu EMEA Ltd.

Dubai Liaison Office

902, Aurora Tower,
P O Box: 500311- Dubai Internet City
Dubai, United Arab Emirates
Phone: +971-4-3758479
Fax: +971-4-4249036

• **India**

Anritsu India Pvt Ltd.

6th Floor, Indiqube ETA, No.38/4, Adjacent to EMC2,
Doddanekundi, Outer Ring Road, Bengaluru - 560048, India
Phone: +91-80-6728-1300
Fax: +91-80-6728-1301

• **Singapore**

Anritsu Pte. Ltd.

11 Chang Charn Road, #04-01, Shriro House
Singapore 159640
Phone: +65-6282-2400
Fax: +65-6282-2533

• **Vietnam**

Anritsu Company Ltd.

Room No. 1635, 16th Floor, ICON 4 Tower, 243A De La
Thanh Street,
Lang Thuong Ward, Dong Da District, Hanoi, Vietnam
Phone: +84-24-3760-6216
Fax: +84-24-6266-2608

• **P. R. China (Shanghai)**

Anritsu (China) Co., Ltd.

Room 2701-2705, Tower A,
New Caohejing International Business Center
No. 391 Gui Ping Road Shanghai, 200233, P.R. China
Phone: +86-21-6237-0898
Fax: +86-21-6237-0899

• **P. R. China (Hong Kong)**

Anritsu Company Ltd.

Unit 1006-7, 10/F., Greenfield Tower, Concordia Plaza,
No. 1 Science Museum Road, Tsim Sha Tsui East,
Kowloon, Hong Kong, P. R. China
Phone: +852-2301-4980
Fax: +852-2301-3545

• **Japan**

Anritsu Corporation

8-5, Tamura-cho, Atsugi-shi, Kanagawa, 243-0016 Japan
Phone: +81-46-296-6509
Fax: +81-46-225-8352

• **Korea**

Anritsu Corporation, Ltd.

5FL, 235 Pangyoeyeok-ro, Bundang-gu, Seongnam-si,
Gyeonggi-do, 13494 Korea
Phone: +82-31-696-7750
Fax: +82-31-696-7751

• **Australia**

Anritsu Pty Ltd.

Unit 20, 21-35 Ricketts Road,
Mount Waverley, Victoria 3149, Australia
Phone: +61-3-9558-8177
Fax: +61-3-9558-8255

• **Taiwan**

Anritsu Company Inc.

7F, No. 316, Sec. 1, NeiHu Rd., Taipei 114, Taiwan
Phone: +886-2-8751-1816
Fax: +886-2-8751-1817



Anritsu utilizes recycled paper and environmentally conscious inks and toner.



© Anritsu All trademarks are registered trademarks of their respective owners. Data subject to change without notice. For the most recent specifications visit: www.anritsu.com

11410-01103, Rev. L Printed in United States 2020-07
©2020 Anritsu Company. All Rights Reserved.