

DATASHEET APVSG(-X) Specification V1.24

Single- and Multi-Channel Ultra-Agile Vector Signal Generators

Models up to 4, 6, 12, 20, and 40 GHz



Document size:

1 title page
29 content pages

DEFINITIONS

- The specifications in the following pages describe the warranted performance of the instrument for 23 ± 5 °C after a 30-minute warm-up period.

Typical: Expected mean values, not warranted performance

Min and max: Parameter range that is guaranteed by product design, and/or production tested. Warranted performance specifications include guard-bands to account for the expected statistical performance distribution, measurement uncertainties, and changes in performance due to environmental conditions.

INTRODUCTION

• Ultra-Agile Vector Signal Generator

The APVSG is an ultra-fast-switching vector-modulated signal generator series covering a continuous frequency ranges from 10 MHz to 4, 6, 12, 20, or 40 GHz, respectively, with 0.001 Hz resolution, and 400 MHz RF modulation bandwidth.

The APVSG-X is the corresponding multi-channel product series.

A high performance internal I/Q modulator enables customized waveforms as modulation signals and supports variety of modulation schemes including avionics modulation. The internal dual channel arbitrary waveform generator fitted ensures carrier suppression of >80 dB and image suppression of >75 dB.

The standard APVSG enables ultra-fast CW frequency sweeping, chirping, intra-pulse modulation, pulse shaping with very low phase noise.

Among others, the following use cases are supported:

- Upload multiple formats of IQ Data into APVSG Memory. An APVSG GUI supports data formats from various vendors. The internal RAM can store up to 512 MS (32 bits per I/Q sample) of IQ data. The APVSG internal AWG can play selected sections of the RAM upon a user trigger.
- Use APVSG to synthesize and play predefined digital modulation formats (option IVM)
- Use the analog I/Q inputs (option AIQ) with up to 250 MHz analog bandwidth.
- Use FCP interface (option FCP) to:
 - live stream digital I/Q data up to 125 MSa.
 - instantaneously switch between pre-loaded I/Q data segments.
 - control for ultra-fast frequency hopping (additionally, option UFS required).

All APVSGs operate with an ultra-stable temperature compensated frequency reference (OCXO) that can be phase-locked to an external reference.

The compact unit allows for full front panel control via touch panel display, and PC GUI Software supported operation via ETHERNET, USB, FCP and GPIB communication ports.

FACTS & FIGURES & SPECIFICATIONS

Signal Specifications

PARAMETER	MIN	TYPICAL	MAX	NOTE
Frequency Range	10 MHz		4 GHz 6 GHz 12 GHz 20 GHz 40 GHz	APVSG04 APVSG06 APVSG12 APVSG20 APVSG40
Frequency Resolution		0.001 Hz		
Phase Resolution		0.01 deg		
Frequency & Amplitude Switching / Settling Time		1.5 ms 500 μ s 200 ns 800 ns		valid signal after SCPI received List sweep within 400 MHz BW, Option UFS within entire frequency range, Option UFS
Output Power Level				See Figures
10 to 100 MHz >0.1 GHz	-65 dBm		+13 dBm +17 dBm	APVSG04
0.1 to 6 GHz	-60 dBm		+15 dBm	APVSG06
0.1 to 12 GHz	-60 dBm		+15 dBm	APVSG12
0.1 to 5 GHz 5 to 10 GHz 10 to 20 GHz	-60 dBm		+18 dBm +20 dBm +14 dBm	APVSG20
0.1 to 5 GHz 5 to 10 GHz 10 to 20 GHz 20 to 30 GHz 30 to 36 GHz 36 to 40 GHz	-60 dBm		+18 dBm +20 dBm +14 dBm +10 dBm +6 dBm	APVSG40
Power Resolution		0.01 dB		
Power Level Uncertainty				See Figure 5
<4 GHz		0.25 dB	0.7 dB	Digital ALC on, >-20dBm
4 to 6 GHz		0.3 dB	1.0 dB	
6 to 20 GHz		0.3 dB	1.3 dB	
20 to 40 GHz			1.5 dB	
<4 GHz		0.3 dB	0.8 dB	Pmin to -20 dBm
4 to 6 GHz		0.35 dB	1.2 dB	
6 to 20 GHz		0.4 dB	1.3 dB	
20 to 40 GHz			1.5 dB	
Reverse Power Protection				
DC Voltage			\pm 10 V	
RF Power			26 dBm	
Output Impedance		50 Ω		
VSWR		1.8		See Figure
SSB Phase Noise at 1 GHz and 10 dBm				See Figures 1, 2
at 10 Hz from carrier		-87 dBc/Hz -100 dBc/Hz		Option LN
at 1 kHz from carrier		-130 dBc/Hz		
at 20 kHz from carrier		-145 dBc/Hz		
at 100 kHz from carrier		-150 dBc/Hz		
SSB Phase Noise at 4 GHz and 10 dBm				See Figures 1, 2
at 10 Hz from carrier		-74 dBc/Hz -90 dBc/Hz		Option LN
at 1 kHz from carrier		-121 dBc/Hz		
at 20 kHz from carrier		-133 dBc/Hz		
at 100 kHz from carrier		-138 dBc/Hz		
SSB Phase Noise at 10 GHz and 10 dBm				See Figures 1, 2
at 10 Hz from carrier		-60 dBc/Hz -75 dBc/Hz		Option LN
at 1 kHz from carrier		-85 dBc/Hz		

at 20 kHz from carrier		-100 dBc/Hz		
at 10 MHz from carrier		-118 dBc/Hz		
SSB Phase Noise at 20 GHz and 10 dBm				See Figures 1, 2
at 10 Hz from carrier		-61 dBc/Hz -74 dBc/Hz		Option LN
at 1 kHz from carrier		-100 dBc/Hz		
at 20 kHz from carrier		-95 dBc/Hz		
at 10 MHz from carrier		-113 dBc/Hz		
Harmonics @ 0 dBm 0.01 to 4 GHz		-45 dBc	-40 dBc	APVSG4
Harmonics @ 0 dBm 0.01 to 4 GHz 4 to 7 GHz 7 to 12 GHz		-45 dBc -35 dBc -55 dBc	-40 dBc -30 dBc -50 dBc	APVSG6 & APVSG12
Harmonics @ 0 dBm 0.01 to 5 GHz 5 to 20 GHz >20 GHz		-50 dBc -35 dBc -35 dBc	-45 dBc -30 dBc -30 dBc	APVSG20 & APVSG40
Non-Harmonic Spurious (at 0 dBm output, > 10 kHz offset)		-90 dBc -80 dBc -80 dBc -70 dBc -60 dBc -55 dBc	-75 dBc -70 dBc -50 dBc -50 dBc -50 dBc -45 dBc	< 1.2 GHz 1.2 to 2.5 GHz 2.5 to 4 GHz 4 to 12 GHz 12 to 20 GHz > 20 GHz

I/Q Modulator

PARAMETER	MIN	TYPICAL	MAX	NOTE
RF modulation bandwidth		400 MHz		
IQ Frequency response				Over full IQ bandwidth
< 10 GHz		<±1.0 dB		
10 to 30 GHz		<±2.0 dB		
30 to 40 GHz		<±3.5 dB		
Carrier leakage		-90 dBc	-70 dBc	
Image sideband rejection		-85 dBc	-65 dBc	

Internal I/Q Baseband Generator

PARAMETER	MIN	TYPICAL	MAX	NOTE
Sample resolution		16 bits		each I and Q
Clock source		Internal		
Sample rate	10 Hz		500 MHz	
Sample rate resolution		1 Hz		
Waveform length	18 Sa 216 Sa		512 MSa 384 MSa	* Marker signals active
External trigger to RF output delay		tbd		500 MHz clock rate
Segment mode				
Number of segments	1		65536	
Segment changeover		Immediate, (TBD end of actual segment)		
Trigger modes		Same segment, next segment, addressed segment		
Sequencer play list length	1		2048	
Sequency segment repetitions	1		tbd	
Changeover time		TBD (meas)		500 MHz clock rate, external trigger
Marker signals				
Markers are defined during the waveform generation process.				
Number of markers		3		
Type		waveform		
Marker outputs		MF1 Out, MF2 Out, RF blanking		Selectable, see chapter MULTI FUNCTION OUTPUTS
Marker delay setting range		tbd		
Marker delay setting resolution		tbd		
Marker duration minimum value		1 sample 4 samples		Sample rate <= 125 MSa Sample rate > 125 MSa
Marker jitter		+/- 3 samples		Sample rate > 125 MSa
Marker polarity		Normal / inverted		
Marker output to RF output delay		tbd		

* Shorter Waveforms will be automatically extended by cyclically repeating the waveform.

Internal Vector Modulation (Option IVM)

PARAMETER	MIN	TYPICAL	MAX	NOTE
Modulation schemes	8QAM, 16QAM, 32QAM, 64QAM, 128QAM, 256QAM, 512QAM, 1024QAM, 2048QAM, 4096QAM			
Symbol rate	10 S/s		200 MS/s	
Basband Filter	cosine, root cosine, Gaussian, rectangular, Dirac, rectangular asymmetric			
Filter parameter range				
Cosine, root cosine (parameter α)	0.05		1	
Gaussian (parameter B x T)	0.05		2.5	
Data source	PRBS generator, user data list			
Data lists	8 bits		tbd	

Multicarrier Generation (Option IVM)

PARAMETER	MIN	TYPICAL	MAX	NOTE
Number of carriers	1		1024	
Frequency offset	-200 MHz		200 MHz	
Power offset	-60 dB		0 dB	0.1 dB resolution
Tone initial phase offset	0 deg		360 deg	0.1 deg resolution

Avionics Modulation (Option AVIO)

PARAMETER	MIN	TYPICAL	MAX	NOTE
AVIO Modulation DME				
Operating modes	interrogation & reply			
DME channel	X, Y			
Frequency range	960 MHz		1215 MHz	
Pulse on/off ratio		80 dB	70 dB	
Pulse rise/fall times	100 ns		50 μ s	100 ns resolution
Pulse width	100 ns		50 μ s	100 ns resolution
Pulse spacing	100 ns		300 μ s	100 ns resolution
Pulse rate	10 Hz		10 kHz	1 Hz resolution
Pulse shaping	cos, cos ² linear, gauss			individually settable for rising & falling edge
ID code		tdb		
ID rate		tdb		
AVIO Modulation VOR				
Bearing accuracy	$\pm 2\%$ / ± 0.5 deg			
Subcarrier frequency accuracy	9960 \pm 2 Hz			
AM accuracy	30 \pm 1%			
AM distortion (THD)			2%	
FM accuracy	480 \pm 1 Hz			
AVIO Modulation ILS				
AM accuracy	40 \pm 1%			
AM distortion			0.5%	
DDM resolution		0.0002 0.0004		Localizer Glide Slope
DDM accuracy		0.0004 0.0008		Localizer Glide Slope
Marker Beacon				
AM tone accuracy (95% AM)		5% of setting		
AM tone distortion (95% AM)		5%		



Analog Modulation (Option MOD)

PARAMETER	MIN	TYPICAL	MAX	NOTE
Pulse Modulation				
Modulation source	internal Pulse Generator/ external			
Modulator	RF (internal/external) or Baseband (BB, internal)			
Pulse rise/fall time		5 ns		10% / 90% of amplitude
On/off ratio	40 dB 90 dB 50 dB TBD dB	45 dB 95 dB 50 dB TBD dB		BB pulse modulator <4 GHz RF pulse modulator >4 GHz RF pulse modulator
Pulse overshoot			1 dB	
Video feedthrough		tbd		
Polarity / video polarity	normal / inverted			independently selectable
External pulse input to video output delay		20ns (meas)		
Video output to RF output delay		5ns (meas) 350ns (meas)		RF modulator BB modulator
External trigger to video output delay		TBD		
Pulse jitter (internal source)			<1 ps	
Internal Pulse Generator				
Pulse Mode	single pulse			
Pulse period setting range	16ns		10s	
Pulse period setting resolution		8ns		
Pulse width setting range	0ns		10s	
Pulse width setting resolution		8ns		
Pulse width accuracy		same as time base		
Amplitude Modulation				
Modulation source		Internal / External		External requires option AIQ
Modulation depth	0%		100%	Output is clipped at max power level
Deviation accuracy		0.1%	1%	1 kHz rate, 80% depth
Deviation resolution		0.1%		
Distortion (THD)			1%	1 kHz rate, 80% depth
Modulation frequency range	0.1 Hz		100 MHz	
Modulation waveforms		Sine, Square		
Frequency Modulation				
Modulation source		Internal / External		External requires option AIQ
Maximum frequency deviation (peak)	200 MHz			
Deviation accuracy		0.5%	1%	
Distortion (THD)		< 1 %		1 kHz rate, 10 kHz deviation
Modulation frequency range	0.1 Hz		100 MHz	
Modulation waveforms	Sine			
Phase Modulation				
Modulation source		Internal / External		External requires option AIQ
Phase deviation (peak)	0		100 rad	
Deviation accuracy		0.5%	1%	
Modulation frequency range	0.1 Hz		100 MHz	
Modulation waveforms	Sine			
Distortion (THD)		< 1%		1 kHz rate & N x rad deviation

Frequency Reference

PARAMETER	MIN	TYPICAL	MAX	NOTE
Internal Reference Frequency		100 MHz 10 MHz		Option LN
Initial calibrated accuracy			±10 ppb	At 23 ± 3 °C
Temperature stability			±100 ppb ±20 ppb	0 to 50 °C Option LN
Aging after 1st year			1 ppm 0.03 ppm	Option LN
Aging per day			5 ppb 0.5 ppb	after 30 days operation Option LN
Warm-up time	5 min			
Output of internal reference	10 MHz or 100 MHz			
Output power	0 dBm			
Output impedance	50 Ω			
High Performance Phase Synchronization Clock	3 GHz			
Phase Lock to External Reference	5 MHz		250 MHz	Option VREF
External reference frequency resolution	1 MHz			Option VREF
Reference Input Level				
10 MHz or 1-250 MHz	-5 dBm	0 dBm	+10 dBm	
Lock Range				
10 MHz or 1-250 MHz			±1.5 ppm	
Reference Input Impedance		50 Ω		

Sweeping Capability

PARAMETER	MIN	TYPICAL	MAX	NOTE
Sweep Type	List, linear, logarithmic, sawtooth, triangle, random			
Frequency Sweep Range	Full range			
Sweep Parameters	Frequency, power, phase			
Step time (t_{step})	500 μs 200 ns 800 ns		19998 s 19998 s	Option UFS, within +/- 200 MHz Option UFS, within full range
Settling time (t_{inv})				To stabilize phase and amplitude, depends on frequency step
Time resolution		2 ns		
Timing accuracy per point		2 ns		

Trigger Capability

PARAMETER	MIN	TYPICAL	MAX	NOTE
Trigger Types	Continuous, single (point), gated, gated direction			
Trigger Source	External, bus (LAN, USB, GPIB)			
Trigger Modes	Continuous free run (AUTO), trigger and run, reset and run			
Trigger uncertainty		+/-8 ns		
External trigger delay	0		10 s	Settable
External delay resolution		2 ns		
Trigger Polarity	Rising, falling			

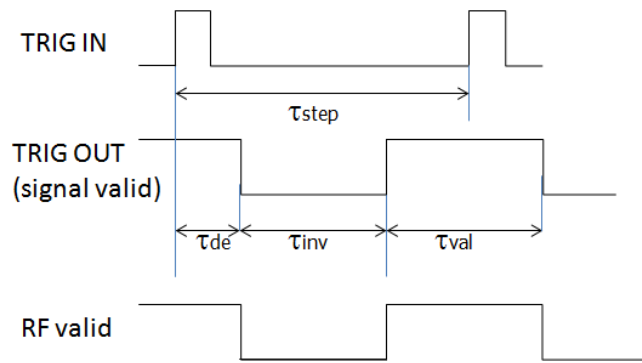

External Multi-Function Inputs

PARAMETER	MIN	TYPICAL	MAX	NOTE
Connector Type	MF1 IN, MF2 IN			see chapter CONNECTORS, IOS
Application	Ext Pulse, Ext trigger			
Nominal Input impedance	DC 10k Ω and AC 50 Ω (nom)			
Threshold voltage	0.85V	0.9 V	0.95 V	
Nominal input voltage	0 V		3.3 V	TTL compatible
Hysteresis		60 mV		

External Multi-Function Outputs

PARAMETER	MIN	TYPICAL	MAX	NOTE
Connector Type	MF1 OUT, MF2 OUT			see chapter CONNECTORS, IOS
Application	Pulse video, Marker signals			
Nominal output impedance	TBD			
Nominal output voltage	0 V		3.3 V	LVTTTL

Fast Control Port (Option FCP)

PARAMETER	MIN	TYPICAL	MAX	NOTE
Interface	Parallel bidirectional LVDS with 100 Ω termination at receiver			
Common mode level		typ. 1.2V		
Differential input threshold		typ. +/-100mV		
Differential output voltage		typ. 300mV		
Connector type	36-pin mini-D female			
Mode IQ data stream				
Sampling rate (IQ samples)	Up to 125 MS/s (optional up to 250 MS/s)			
Input/output format, interleaved clock	16 bits data + clock + valid			
Latency at 125MS/s	typ. 500 ns			
Mode Multi segment waveform addressing				
Input format	Up to 16 bits segment address + strobe			
Latency at general access	typ. 850 ns			
Latency at fastest access	typ. TBD ns			
Mode Parameter hopping				
Parameter	Frequency (up to 48bit), amplitude, phase			
Input format	8 bits address + n* 8bits data + strobe			

External Analog I/Q Data Inputs (Option AIQ)

PARAMETER	MIN	TYPICAL	MAX	NOTE
Analog bandwidth	250 MHz (tbc)			
Input impedance	50 Ω			
Voltage range	-0.5 V		0.5 V	
Full scale voltage		0.5Vrms		$v\sqrt{I^2+Q^2}$
Input impedance		50 Ohms		
Connector Type	I IN, Q IN			see chapter CONNECTORS, IOS

 **Multi-Channel Performance**

PARAMETER	MIN	TYPICAL	MAX	NOTE
Isolation between Channels		>90 dB		
Relative Phase Stability		tbd		

TYPICAL PERFORMANCE CURVES

Figure 1: SSB Phase Noise Performance, CW without option LN, Pout = 10 dBm

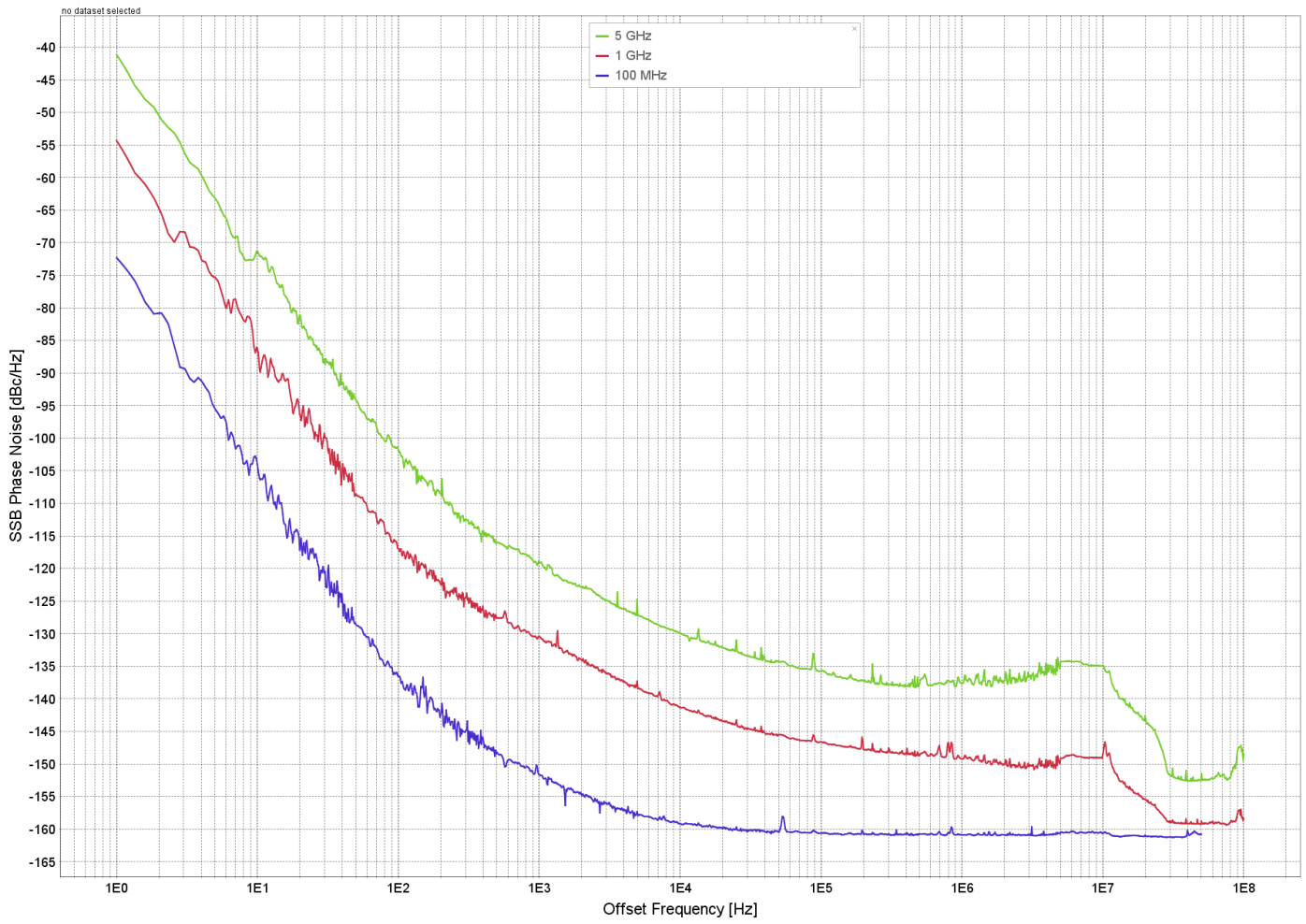

Offset → RF ↓	1 Hz	10 Hz	100 Hz	1 kHz	10 kHz	100 kHz	1 MHz	floor
100 MHz		-119	-135	-148	-155	-156	-158	-159
1 GHz		-100	-114	-129	-140	-150	-152	-160
4 GHz		-87	-102	-118	-129	-139	-140	-151

Figure 2: SSB Phase Noise Performance, CW with option LN, 1 GHz, Pout = 10 dBm

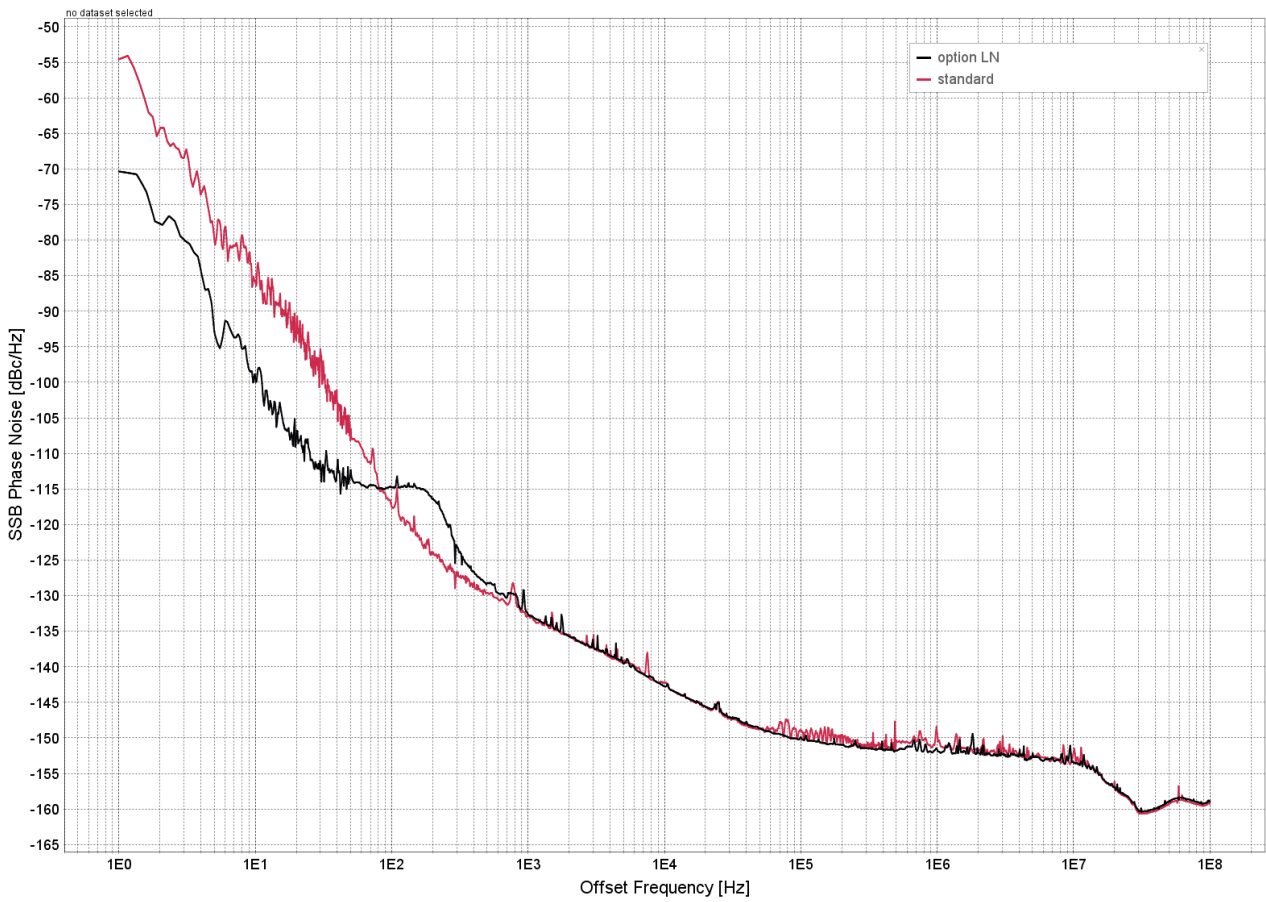

Figure 2a: Amplitude Noise, 2 GHz, Pout = 10 dBm

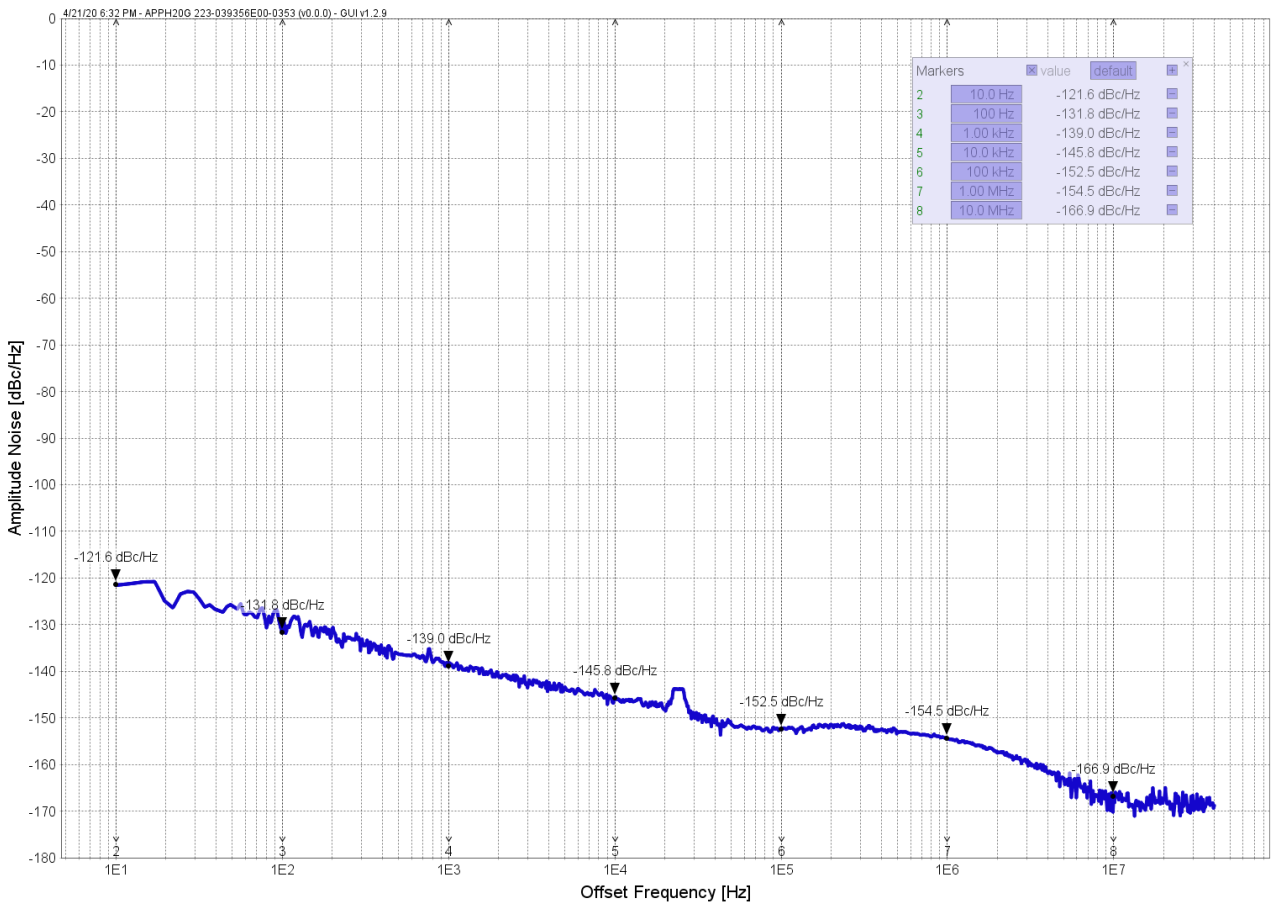

 Figure 3: Maximum Output Power

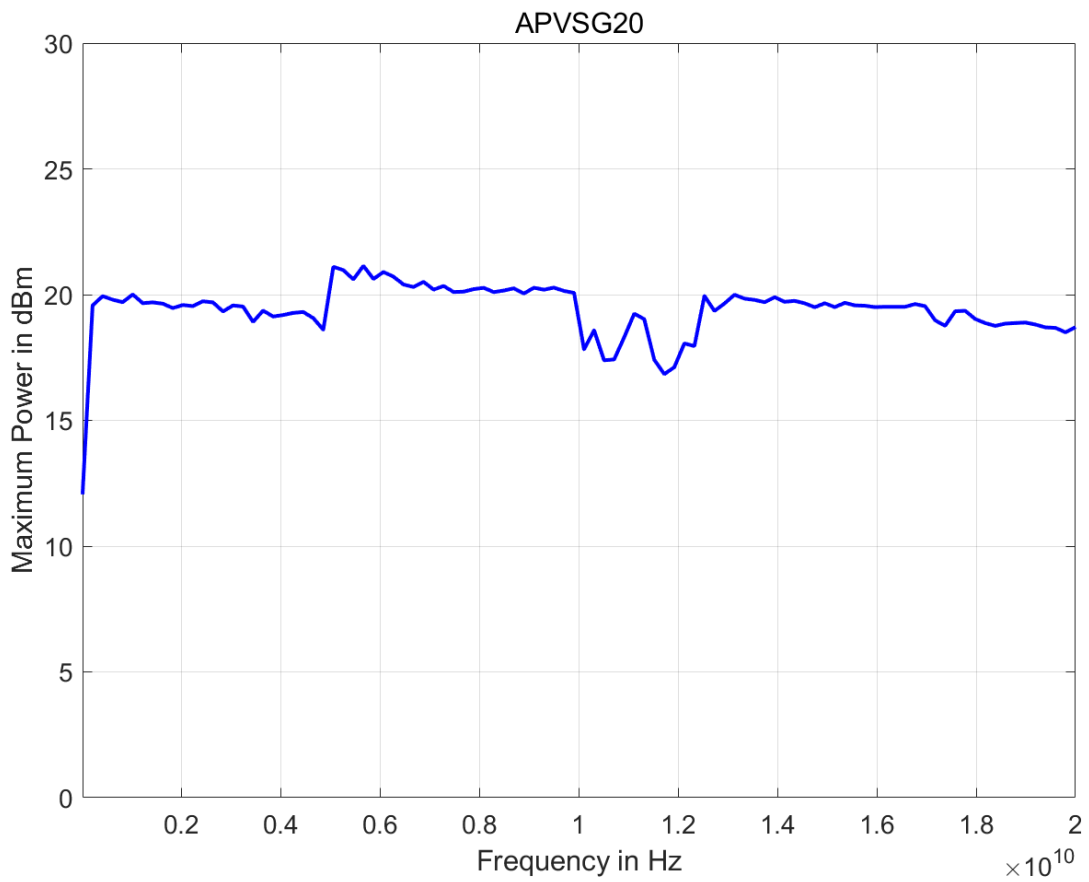
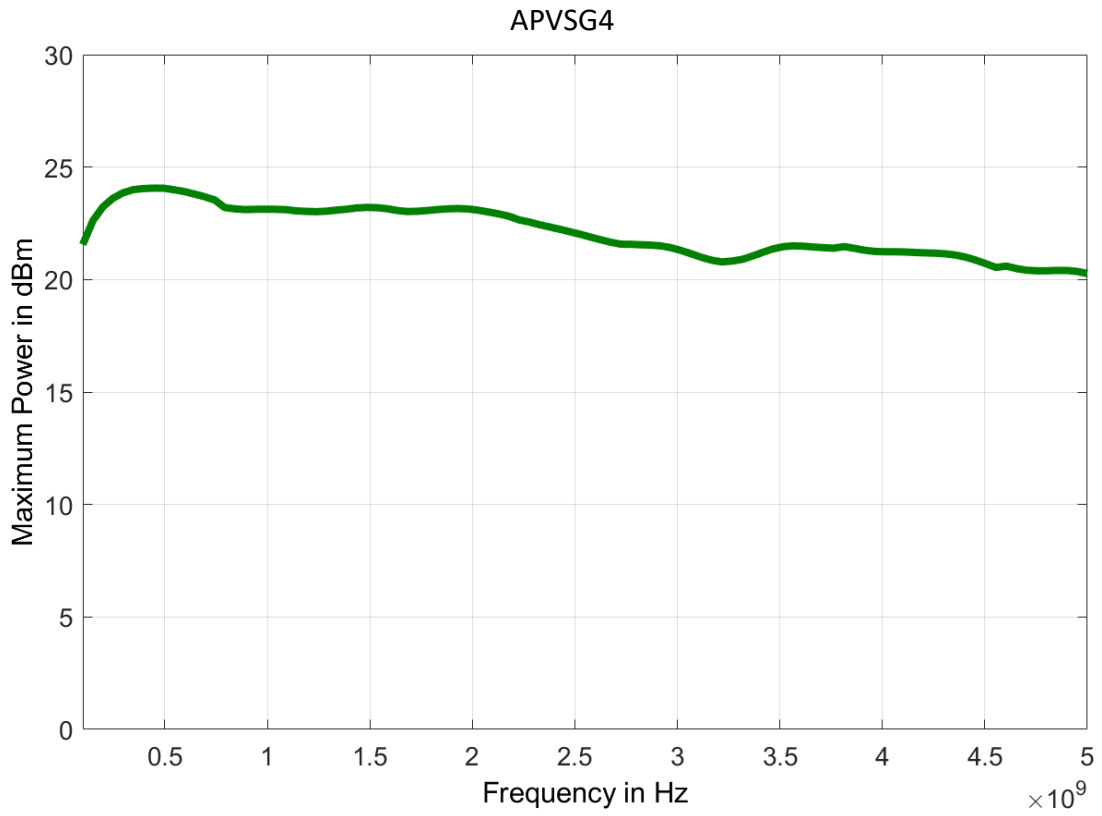

Figure 4: Harmonic performance at 0 dBm

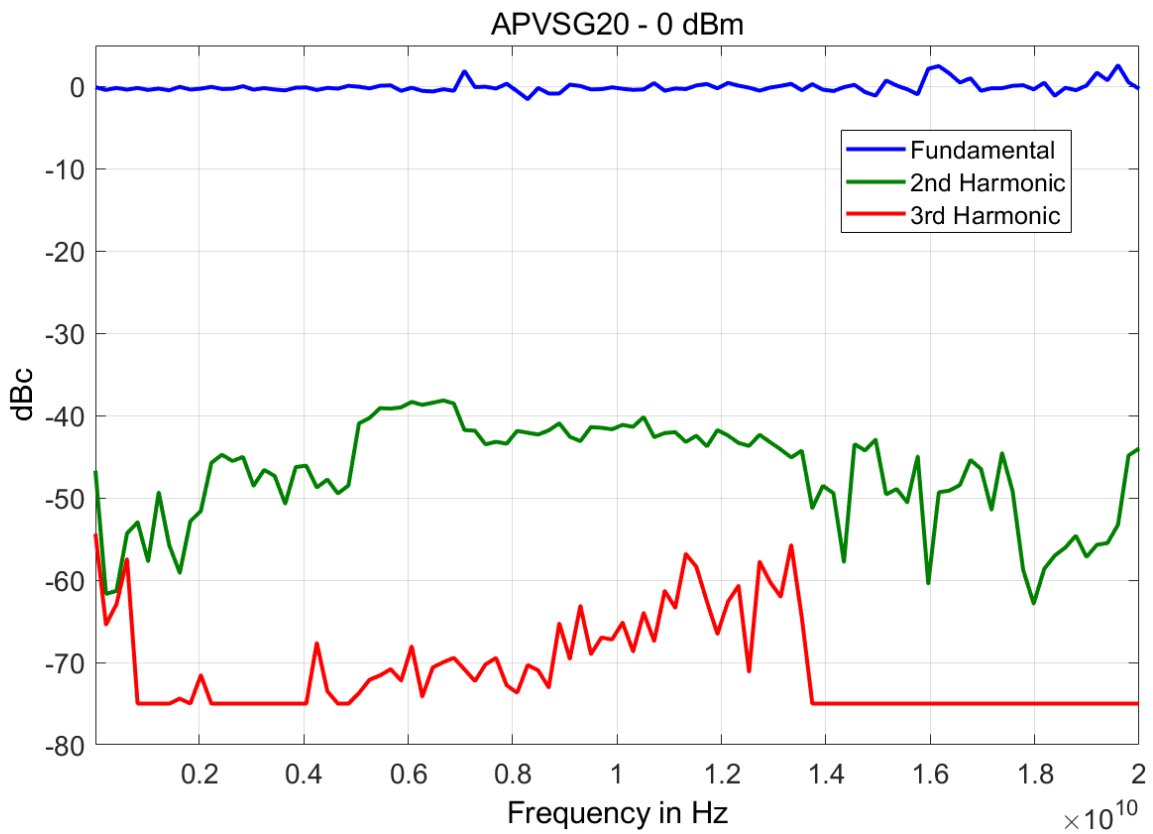
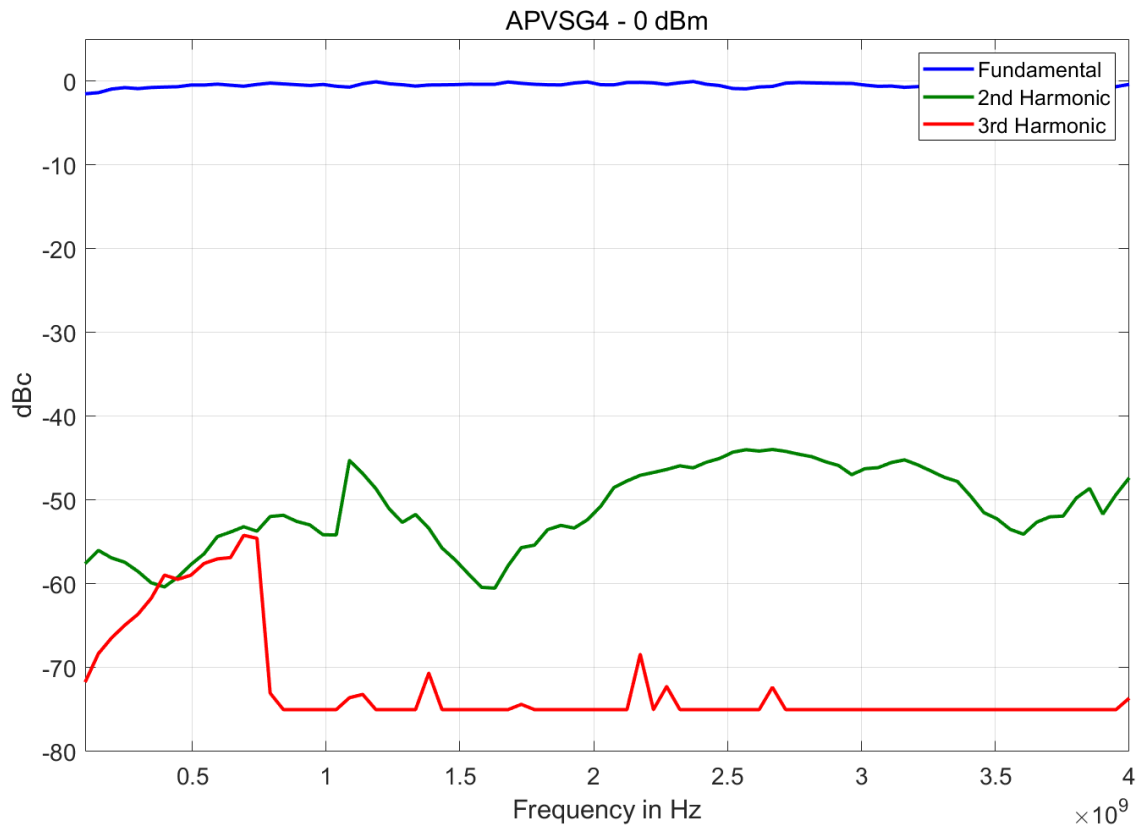
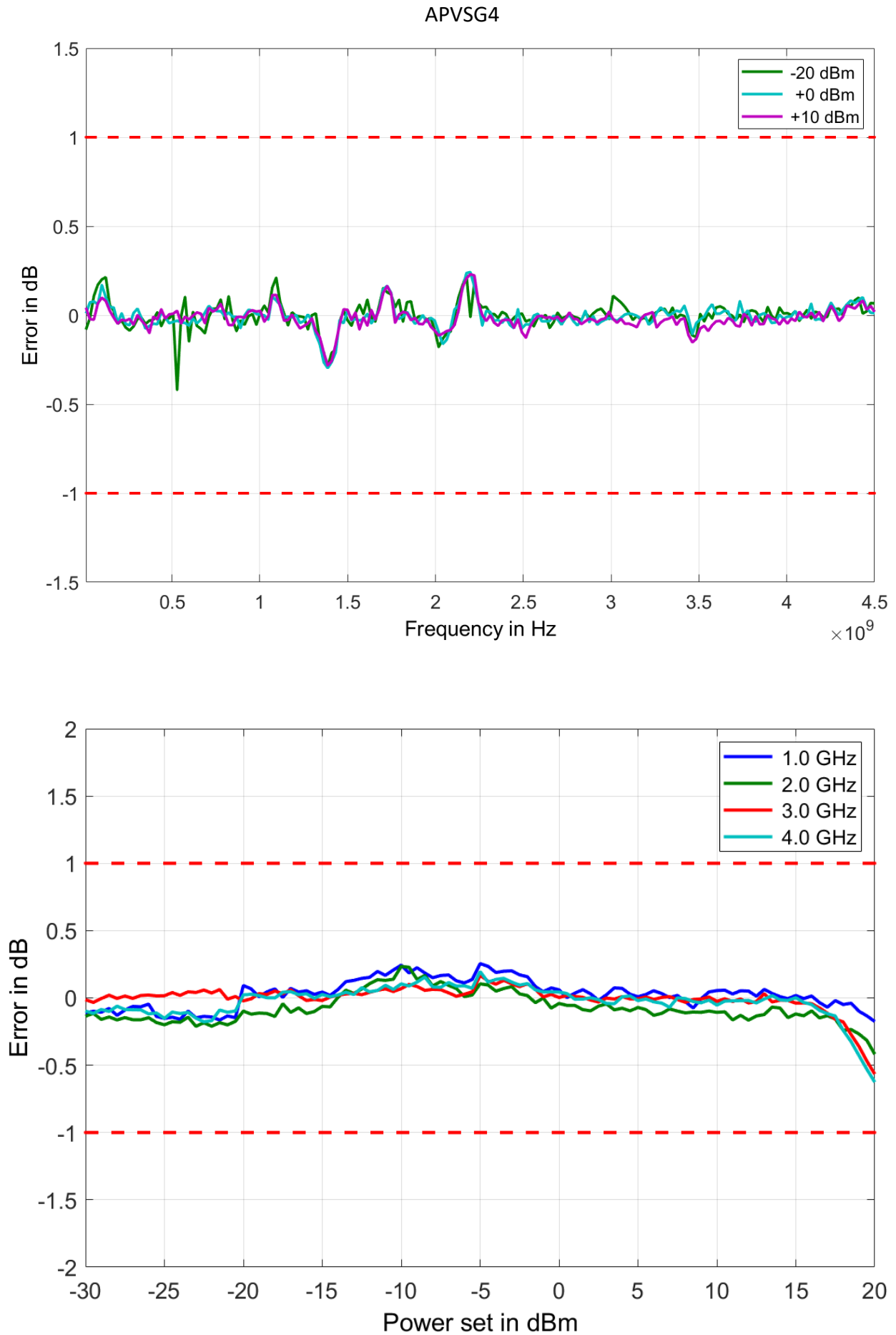
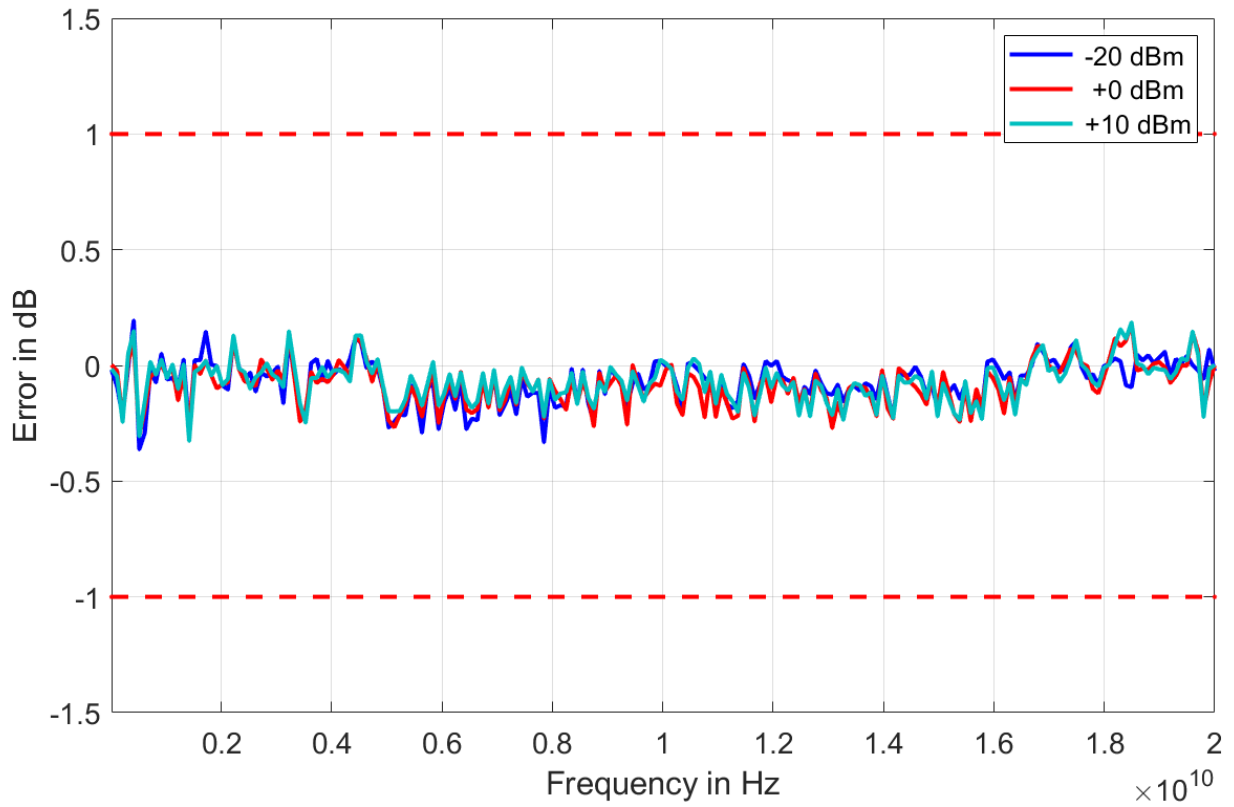

Figure 5: Level accuracy



APVSG20



APVSG20

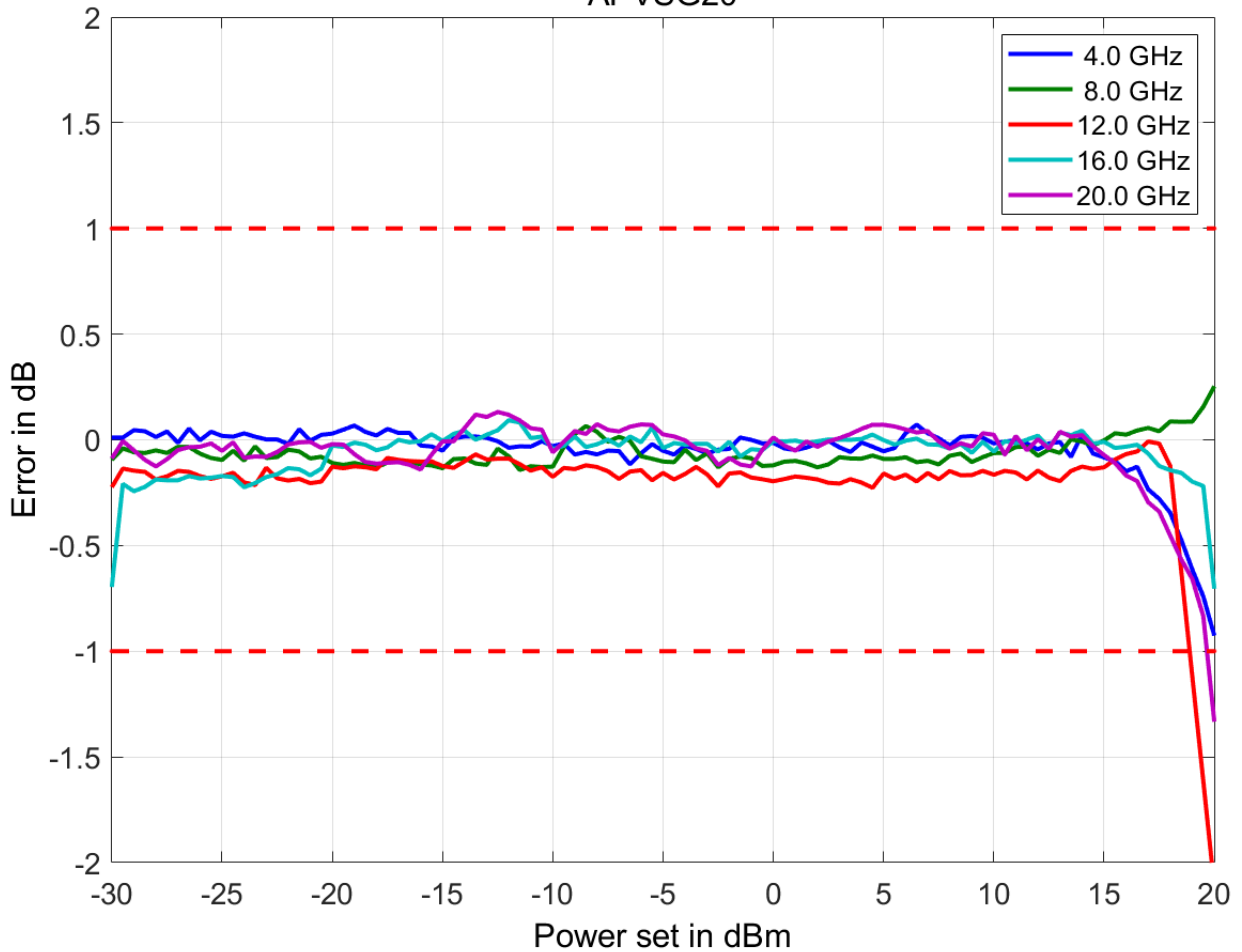

 **Figure 6: IQ Relative Response (measured)**

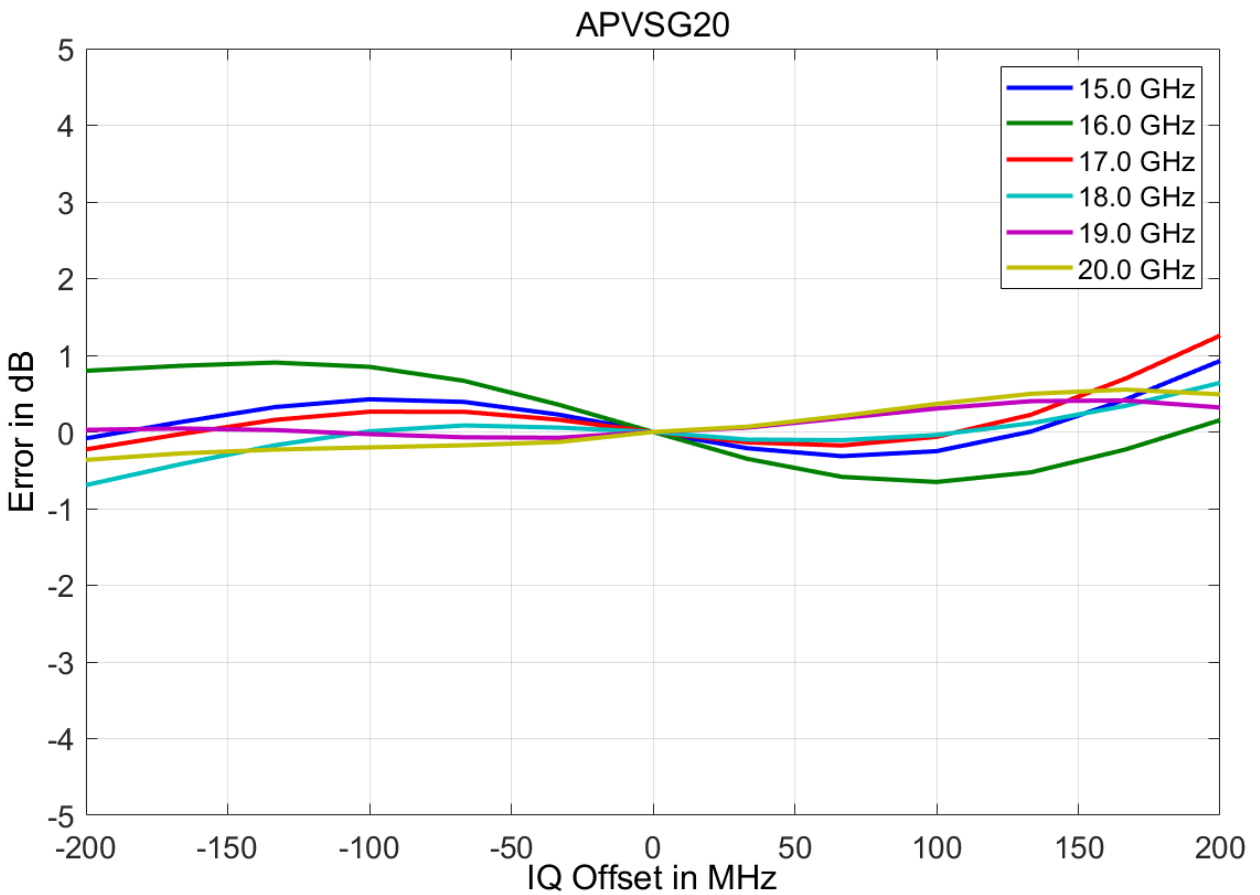
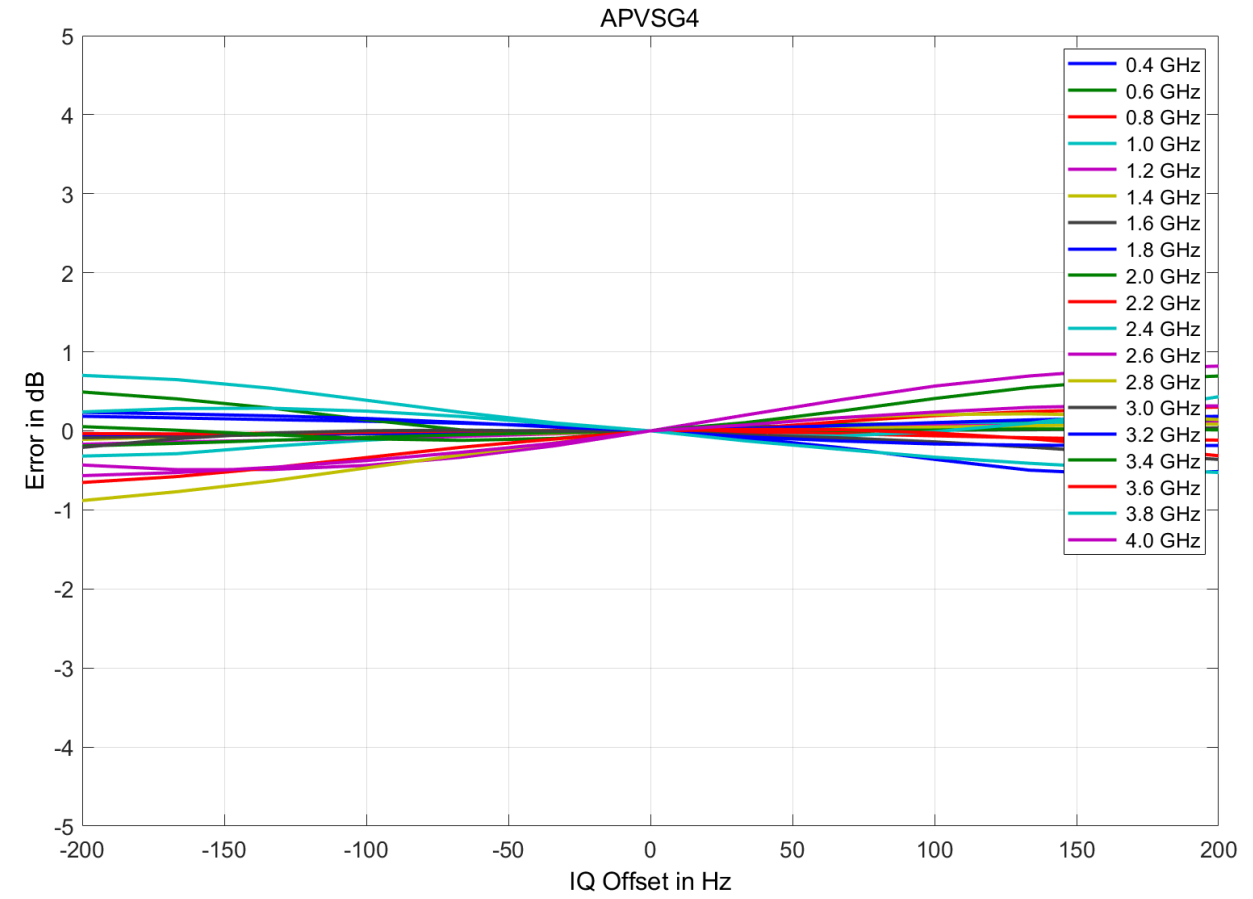

Figure 7: 64-tone 400 MHz bandwidth signal

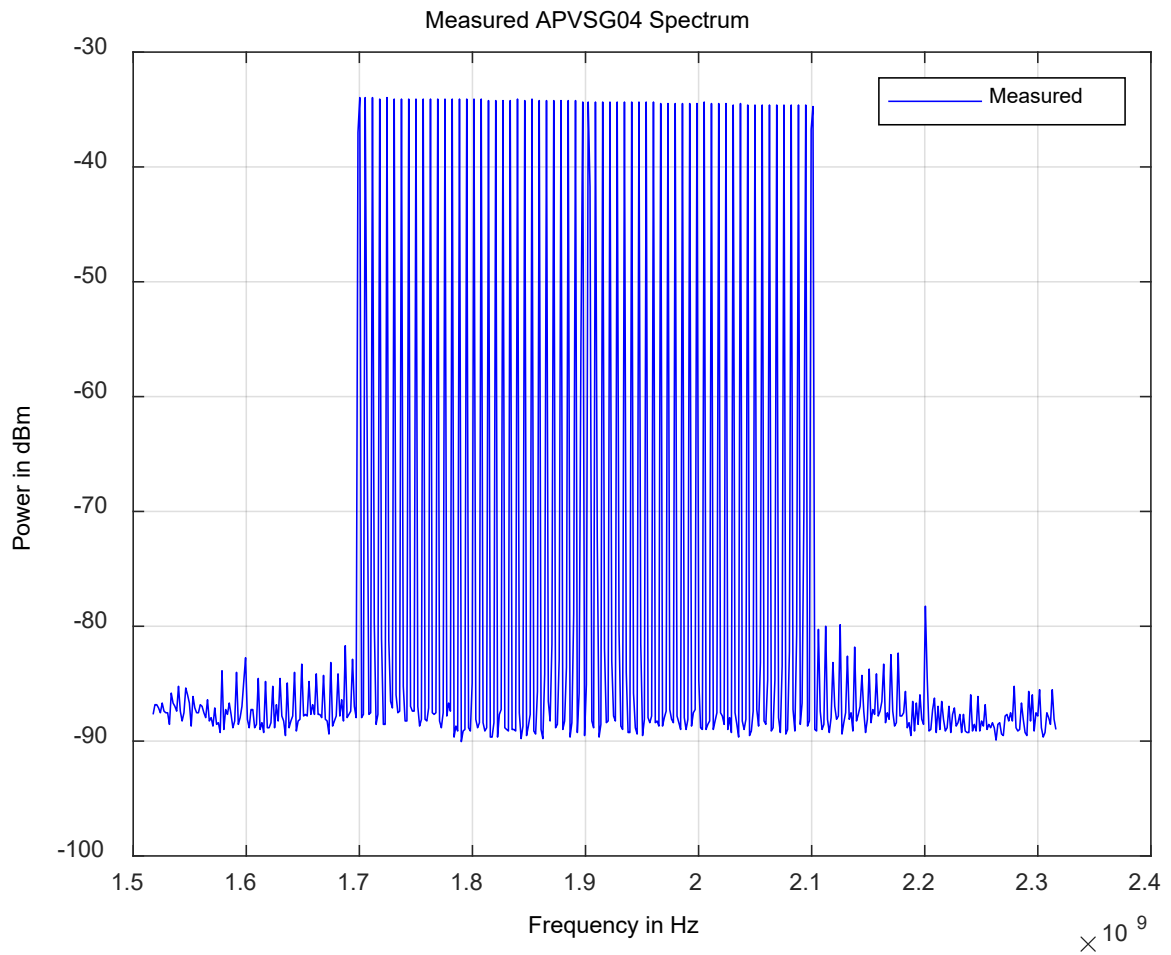

Figure 8: Two-tone sideband rejection

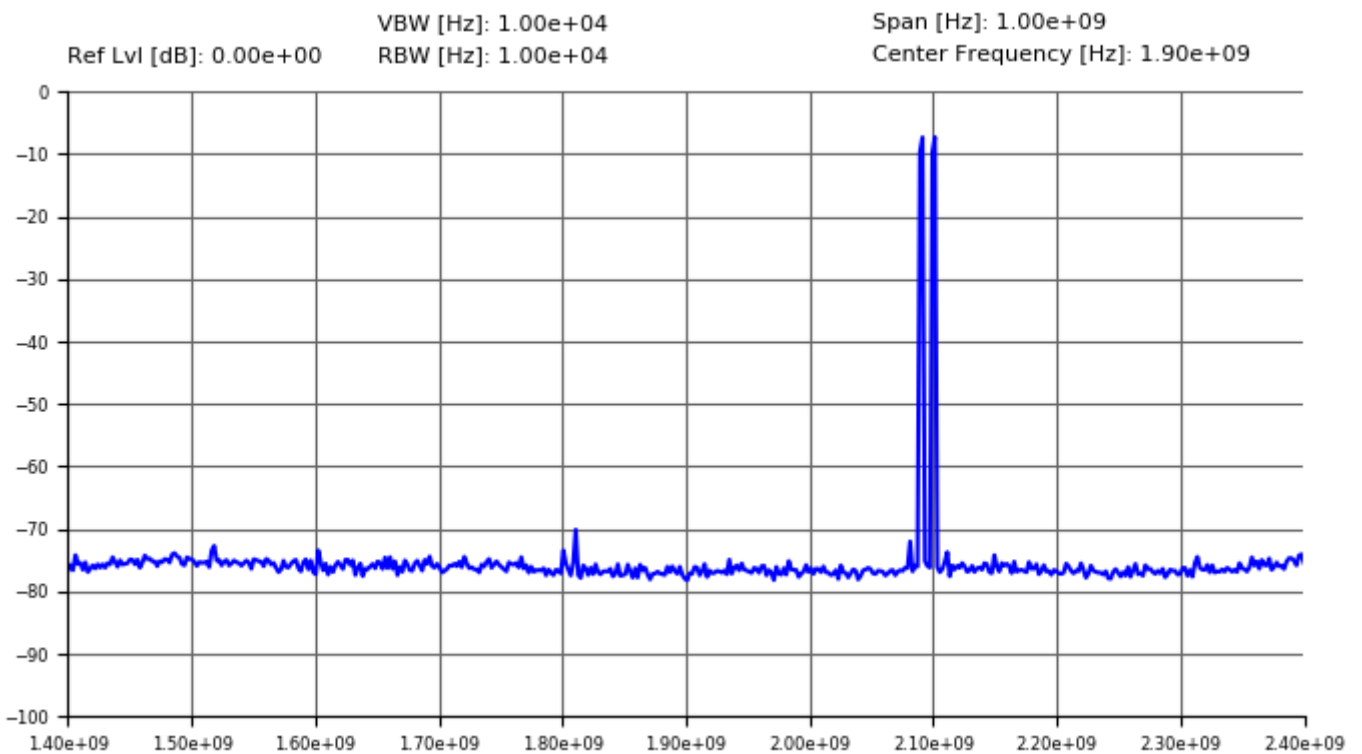

Figure 9: Wideband FM (1MHz rate, 200 MHz deviation)

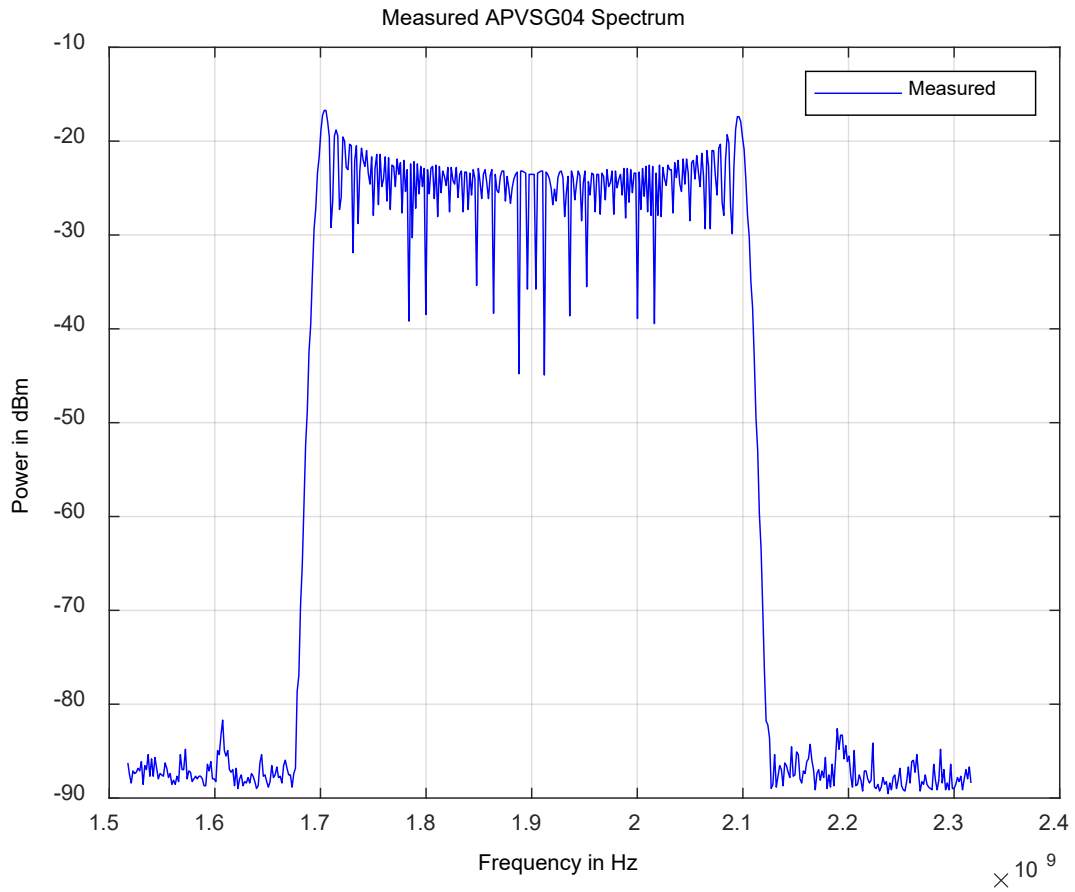

Figure 10: Pulsed chirp (10 microseconds, 400 bandwidth)

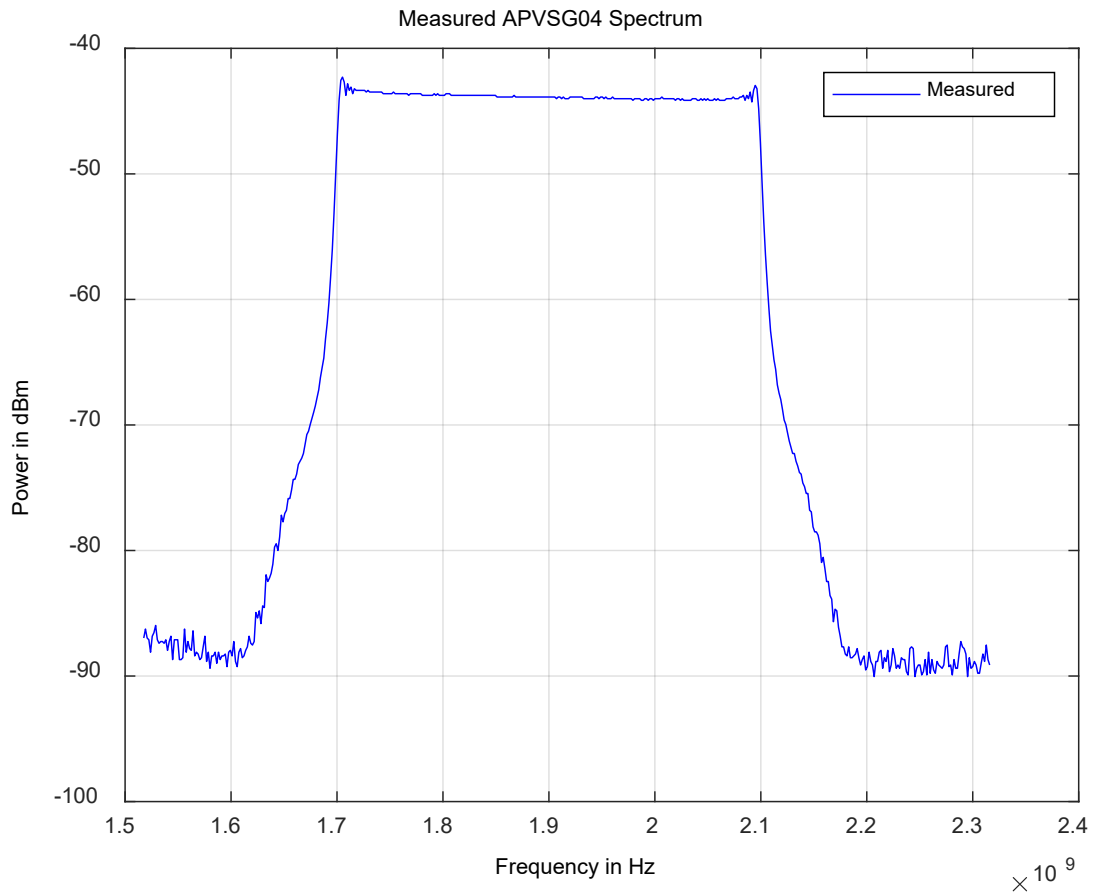

Figure 11: Amplitude modulation (1 kHz rate, 80% depth)

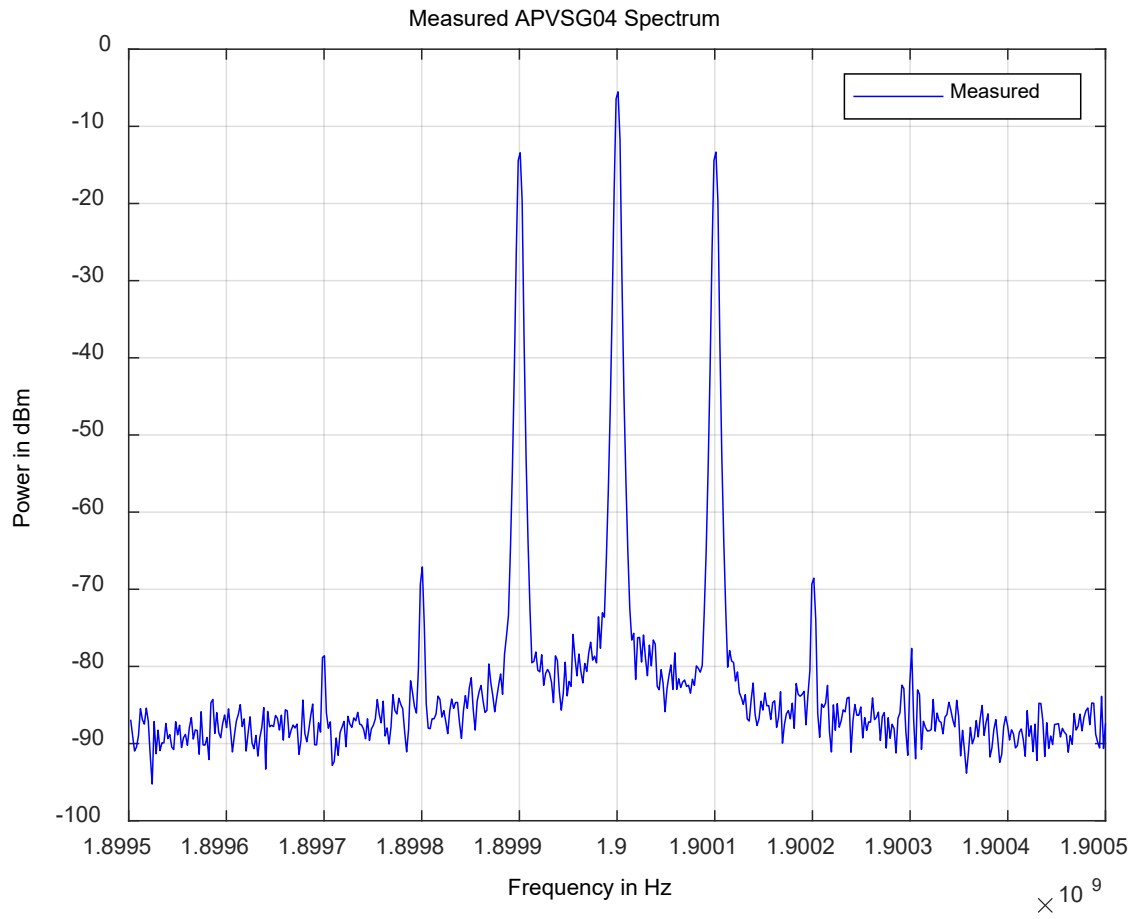

Figure 12: DME Spectrum (X channel, raised cosine filter)

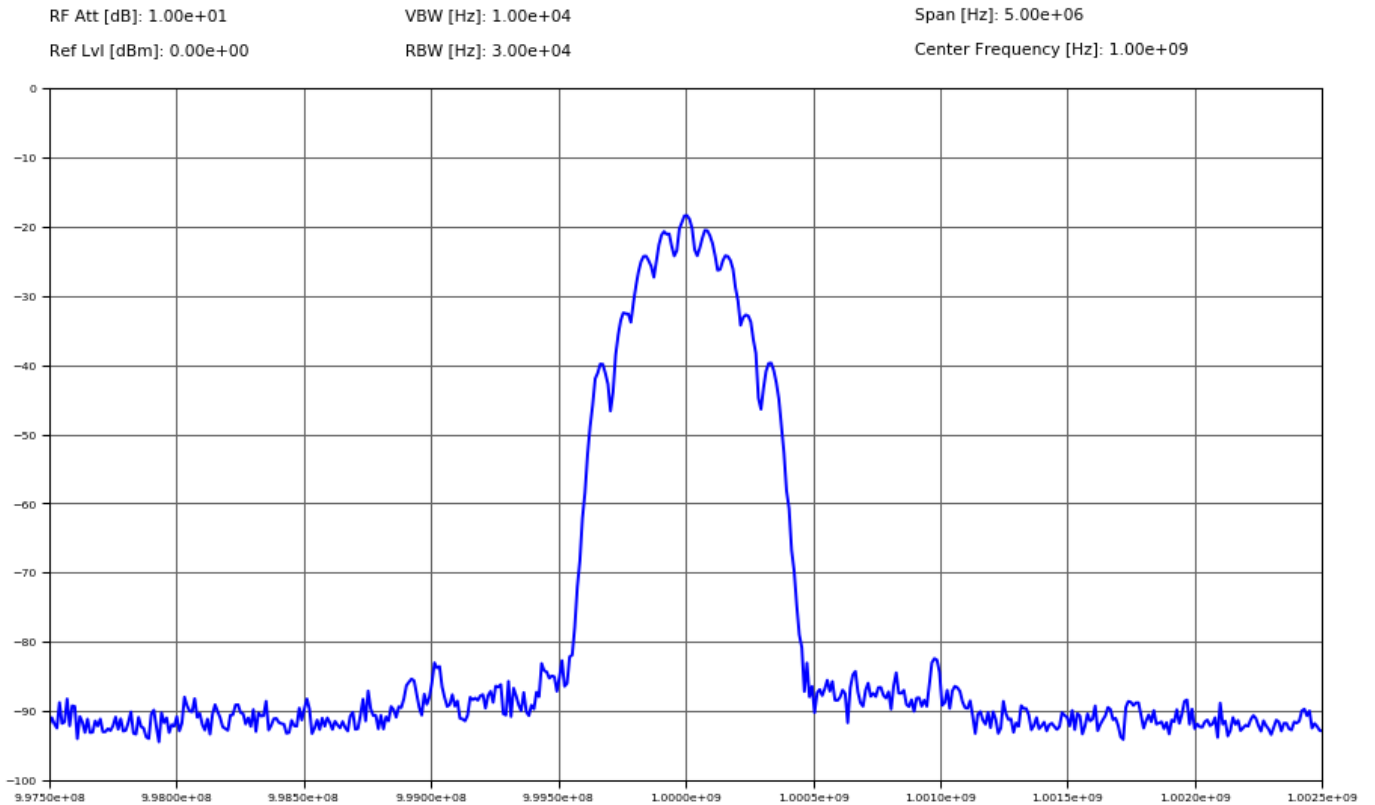

Figure 13: Pulse modulation (10 MHz rate, 10 ns pulse width)

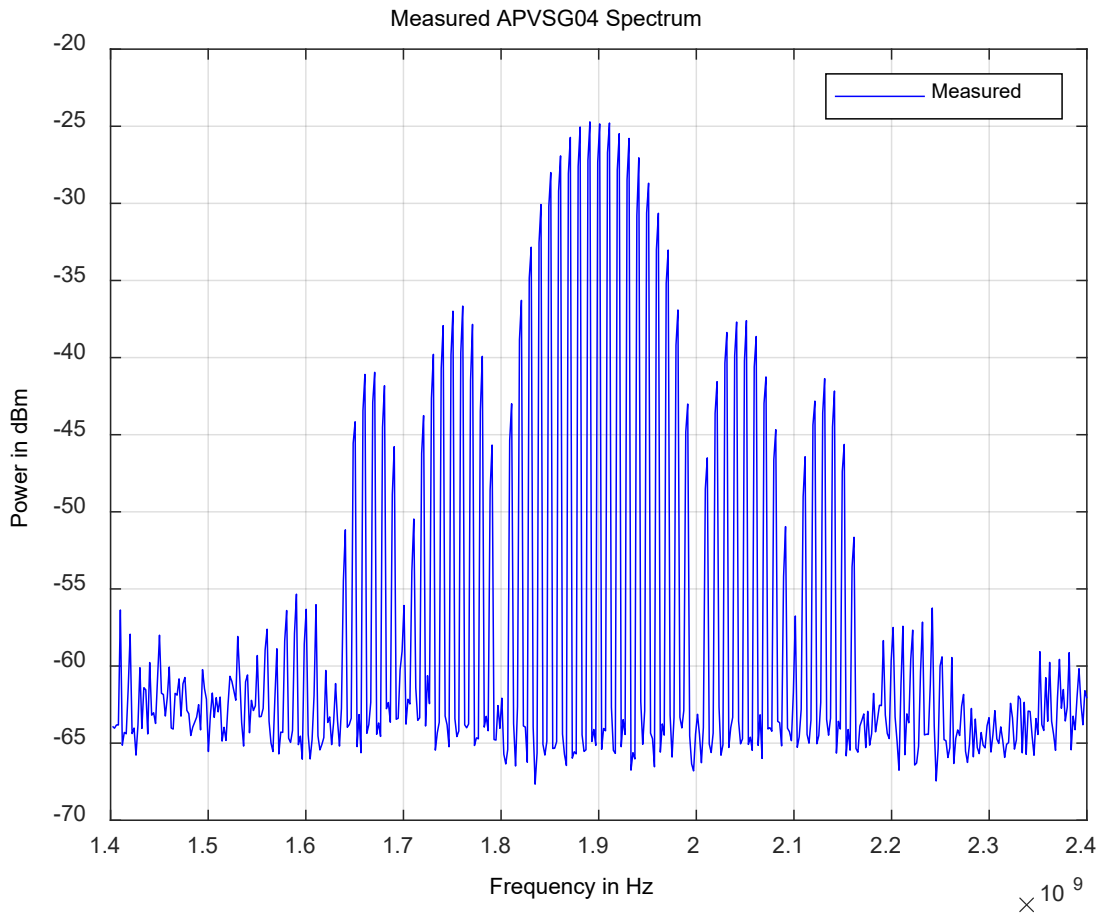

Figure 14: 256QAM 10 MS/s

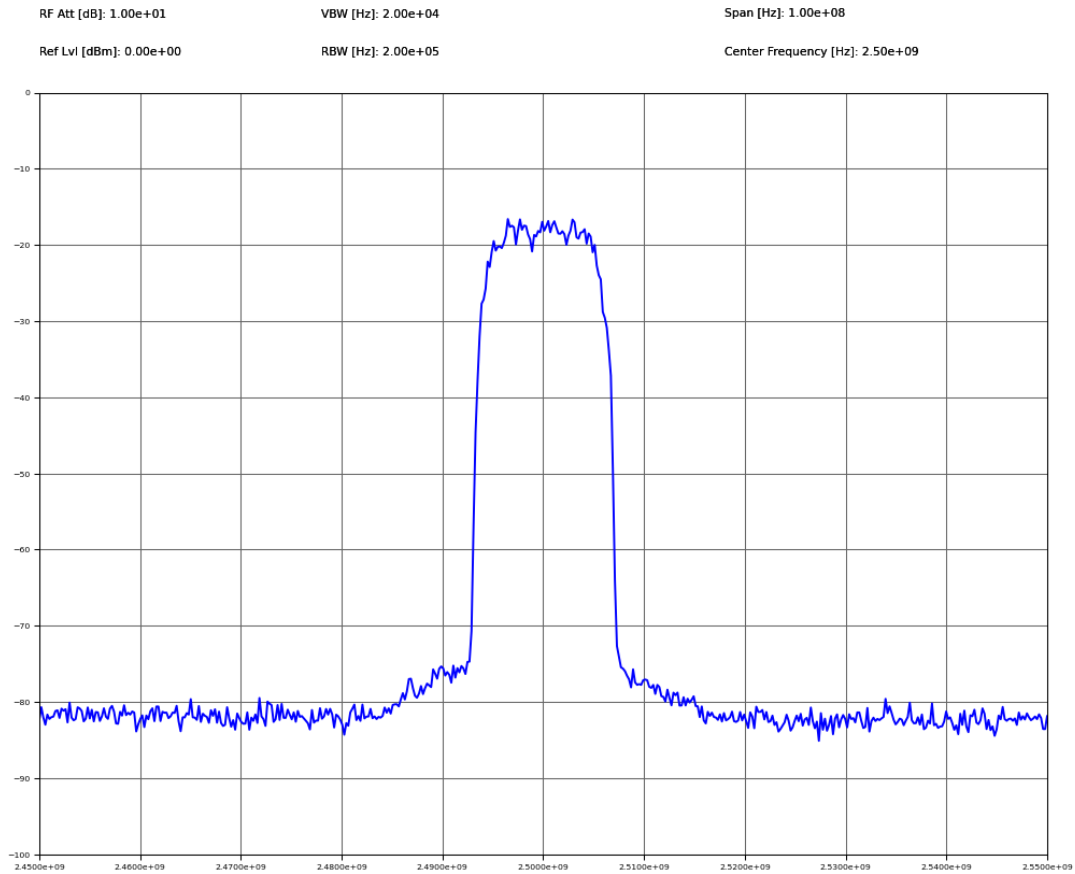

Figure 15: 16QAM 250 MS/s

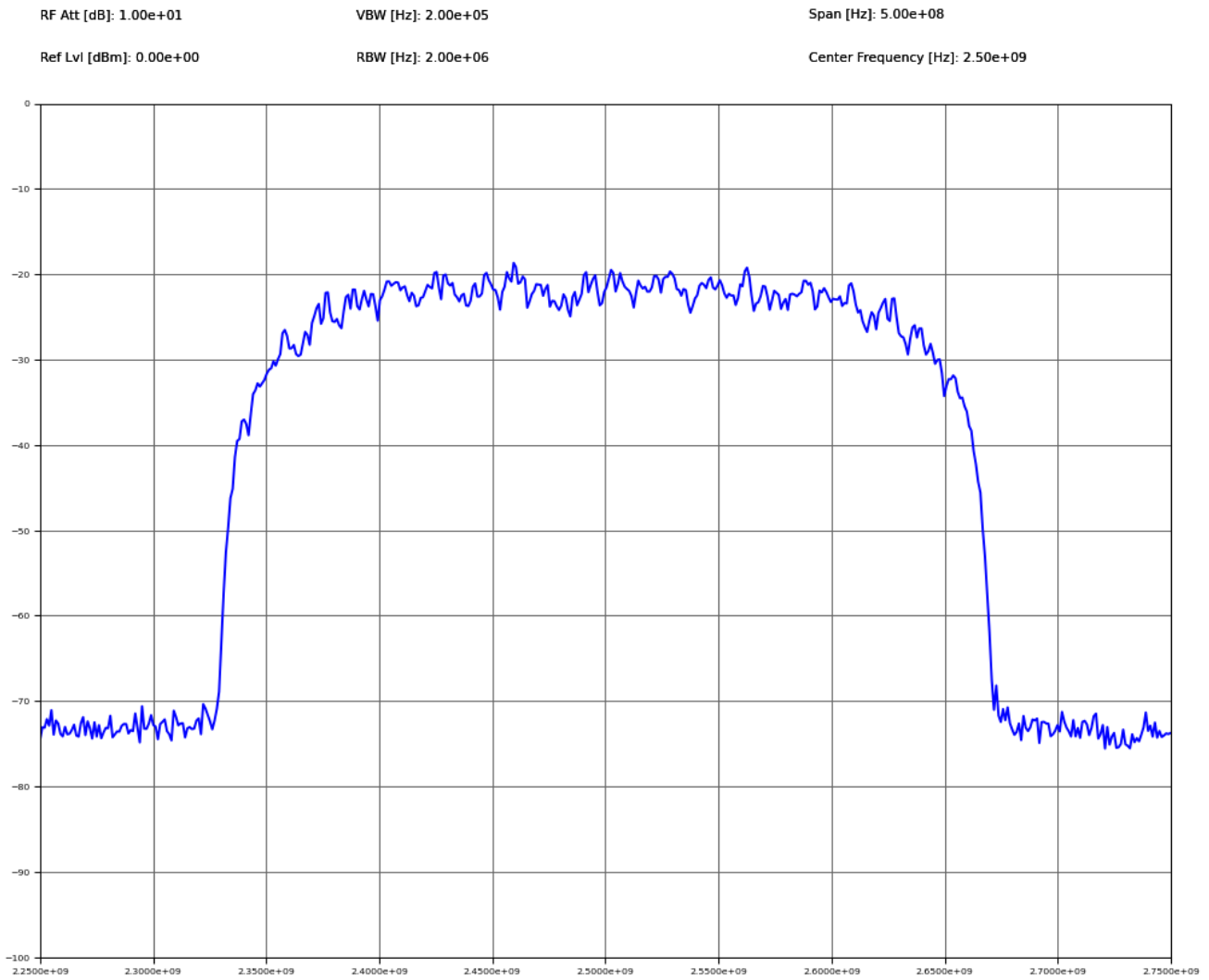

Figure 16: EMV vs Output Power, 16QAM, 10 MS/s, 2.5 GHz

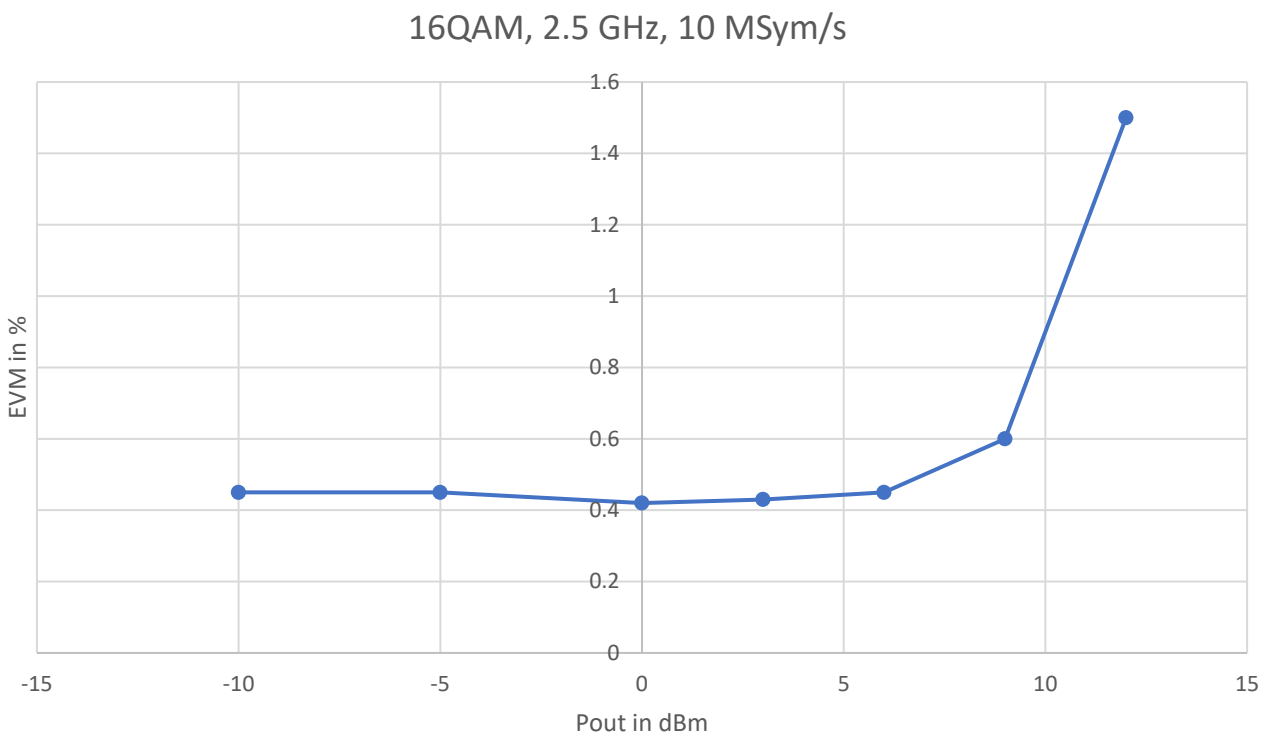

Figure 17: EMV vs Symbol Rate, 16QAM

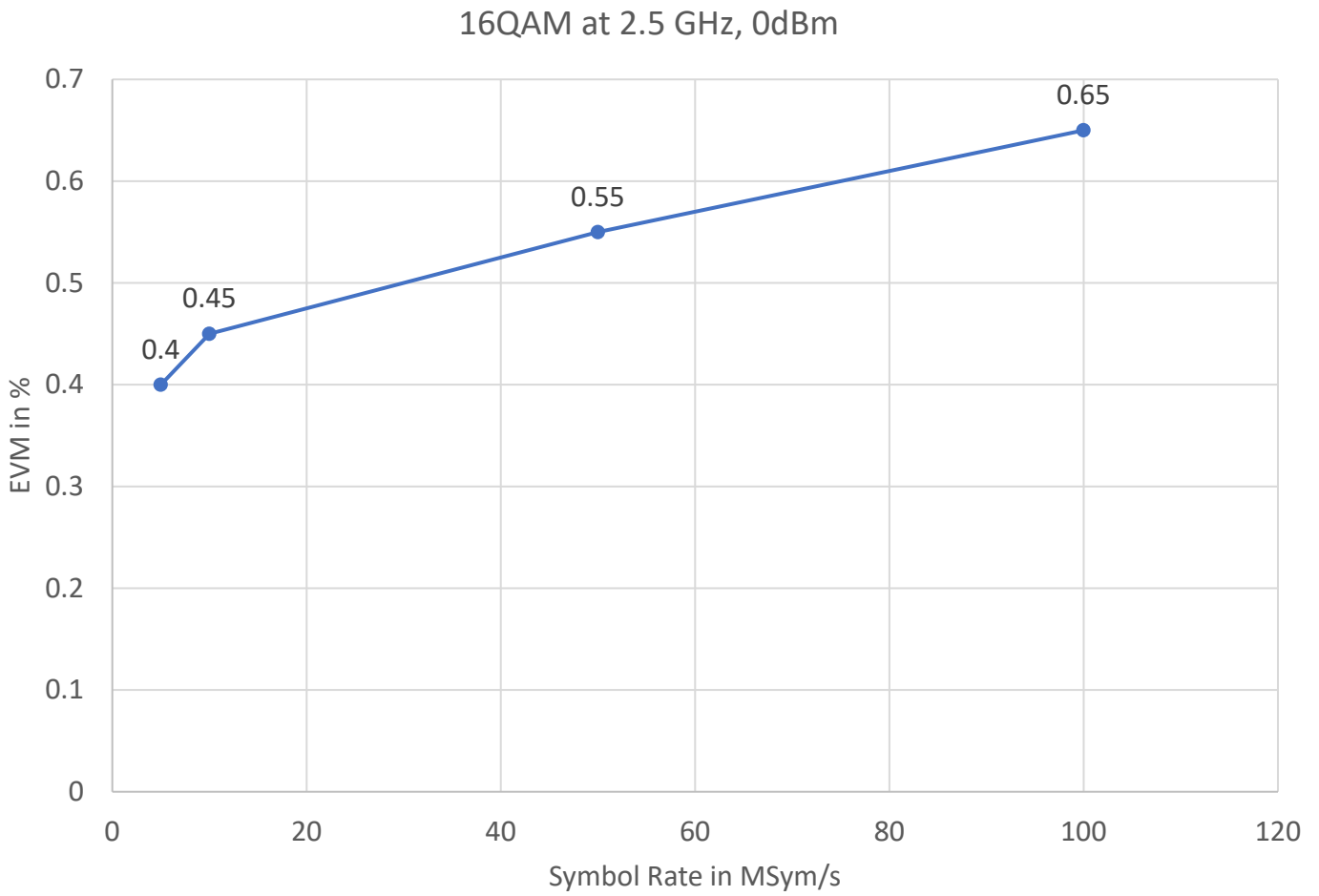

Figure 18: EMV vs RF Frequency, 16QAM, 10 Msymbols/s

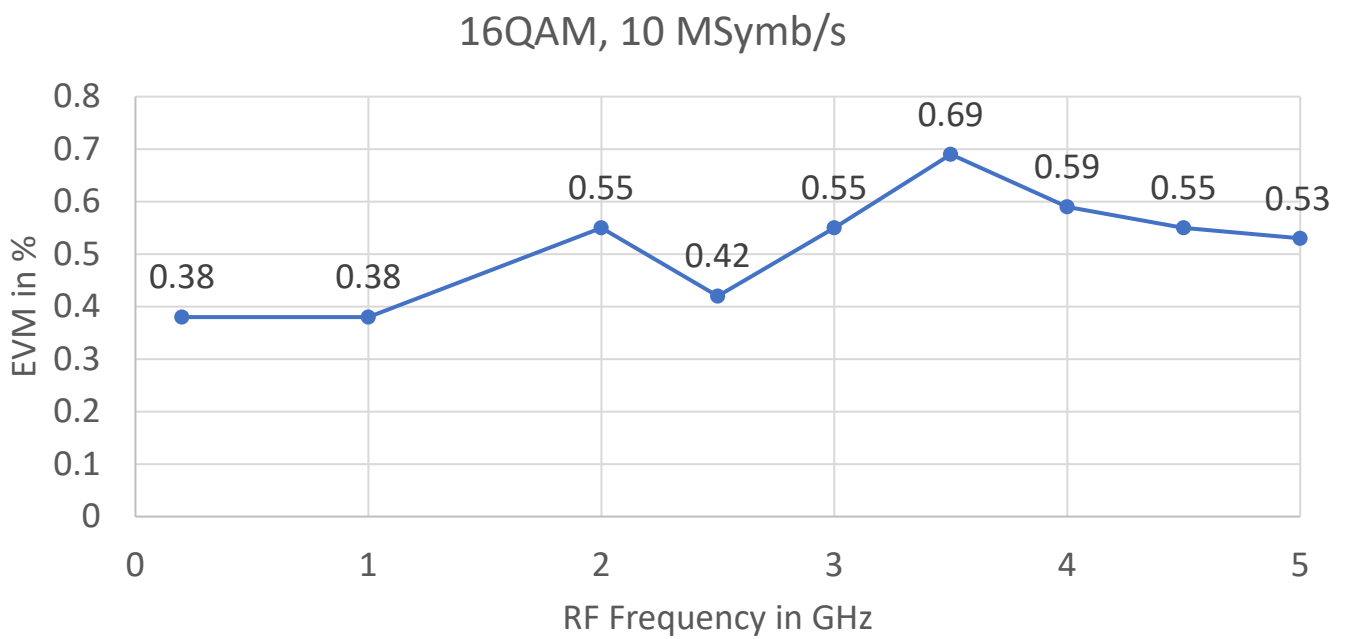

Figure 19: Typical VSWR (APVSG04)

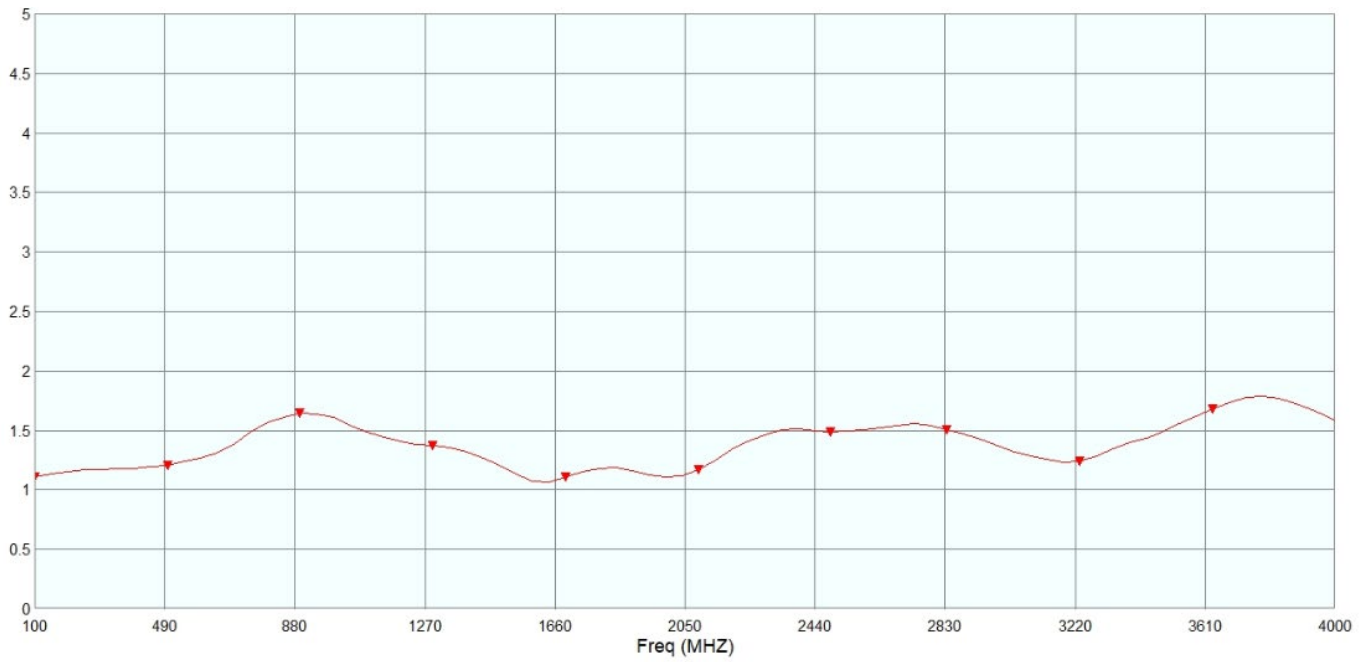
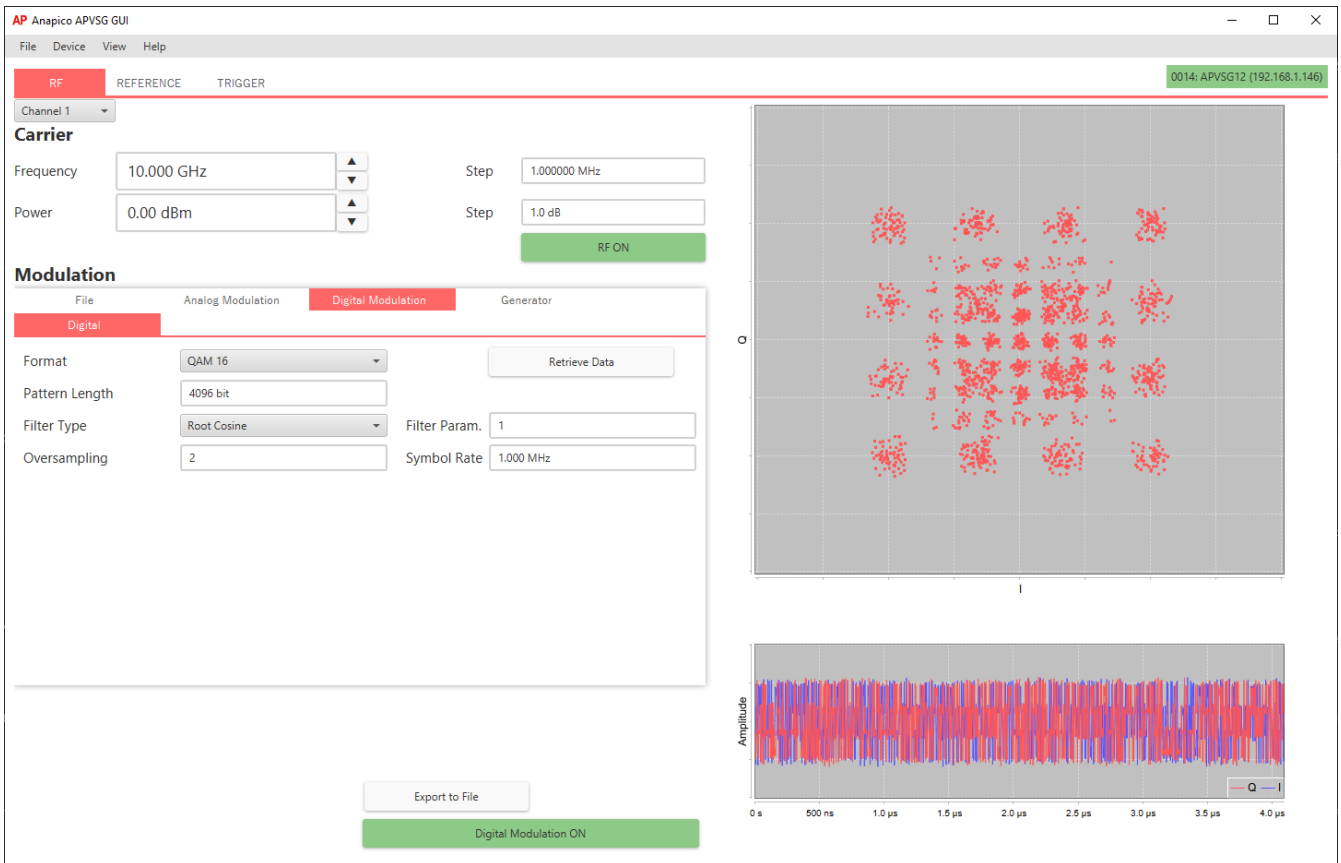

Figure 20: Typical VSWR (APVSG12 & APVSG20)

tba

Figure 21: User Interface



CONNECTORS, IOS

Front panel (single channel model):

LABEL	TYPE	DESCRIPTION	OPTION
RF 50 Ω	N female (APVSG04/APVSG06/APVSG12) SMA female (APVSG20) K (2.92mm) female (APVSG40)	RF output	



Rear panel (single channel model):

LABEL	TYPE	DESCRIPTION	OPTION
I & Q IN	BNC female	Input for analogue in-phase signals	AIQ
REF IN, REF OUT	BNC female	Reference frequency input & output	
USB	USB type B	Remote programming interface	
LAN	RJ-45	Remote programming interface	
DC24V	DC power plug female	Power of Instrument	
MF1 IN, MF2 IN	BNC female	Multi-function inputs: user-configurable (e.g. trigger, external pulse)	
MF1 OUT, MF2 OUT	BNC female	Multi-function outputs: user-configurable (e.g. trigger, marker)	
ON/OFF	SWITCH	Turns the device on or off.	
GROUND SCREW		Connects the device to ground reference	

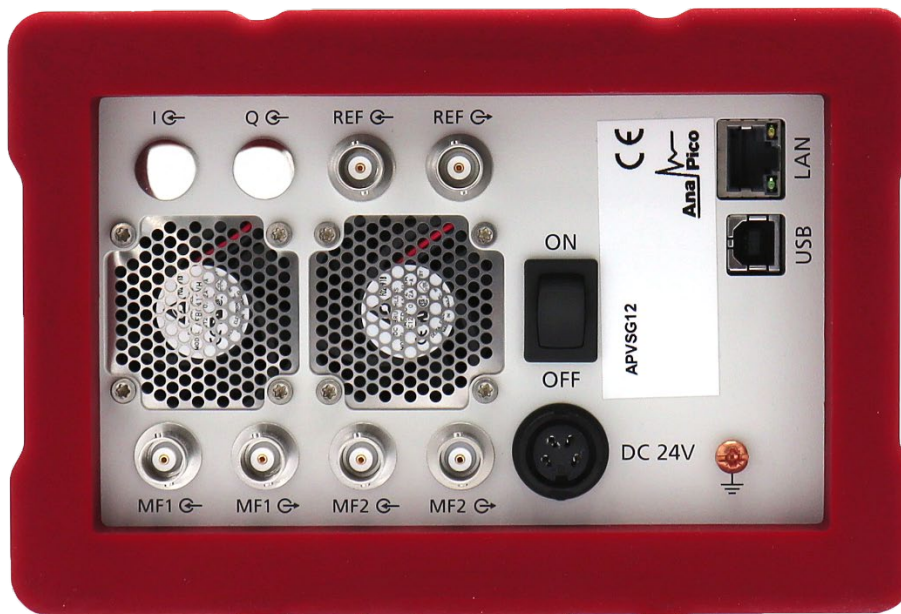

Front panel (2U multi (2 to 4) channel model):

LABEL	TYPE	DESCRIPTION	OPTION
RF OUT (for each channel)	SMA female / K (2.92mm) female (APVSG40-X)	RF output	



Rear panel (2U multi (2 to 4) channel model):

LABEL	TYPE	DESCRIPTION	OPTION
USB	USB type B	Remote programming interface	
LAN	RJ-45	Remote programming interface	
GPIO	24-pin female	Remote programming interface	GPIO
REF IN	SMB female	Reference frequency input	
REF OUT	SMB female	Reference frequency output	
CLK IN	SMB female	High-stability reference input	
CLK OUT	SMB female	High-stability reference output	
FCP (for each channel)	36-pin mini-D female	Fast control port	FCP
MF1 IN, MF2 IN (for each channel)	SMB female	Multi-function inputs: user-configurable (e.g. trigger, external pulse)	
MF1 OUT, MF2 OUT (for each channel)	SMB female	Multi-function outputs: user-configurable (e.g. trigger, marker)	
I IN, Q IN (for each channel)	SMB female	Analog IQ-modulation inputs	AIQ



ORDERING INFORMATION



HOST MODEL	PRODUCT	DESCRIPTION
APVSG	APVSG04	4 GHz model
APVSG	APVSG06	6 GHz model
APVSG	APVSG12	12 GHz model
APVSG	APVSG20	20 GHz model
APVSG	APVSG40	40 GHz model
APVSG-X	APVSG04-X	4 GHz model (X channels)
APVSG-X	APVSG06-X	6 GHz model (X channels)
APVSG-X	APVSG12-X	12 GHz model (X channels)
APVSG-X	APVSG20-X	20 GHz model (X channels)
APVSG-X	APVSG40-X	40 GHz model (X channels)
APVSG(-X)	Option LN	Enhanced close-in phase noise & frequency stability
APVSG(-X)	Option UFS	Ultra-fast switching speed
APVSG(-X)	Option FCP	Fast control port (digital IQ data streaming)
APVSG(-X)	Option MOD	Analog modulations
APVSG(-X)	Option IVM	Internal vector modulations
APVSG(-X)	Option AVIO	Avionic modulations
APVSG(-X)	Option VREF	Variable REF input
APVSG(-X)	Option AIQ	External analog I/Q Inputs
APVSG(-X)	Option WE	One year warranty extension
APVSG(-X)	Option ReCal	Recalibration

GENERAL CHARACTERISTICS

Remote programming interfaces

- Ethernet 100BaseT LAN interface,
- USB 2.0 device interface
- GPIB (IEEE-488.2,1987) with listen and talk (Option GPIB)
- Control language SCPI Version 1999.0

Power requirements

Single channel model

Input voltage range	24 VDC \pm 3.0 V	
Power consumption (typ) (without options)	45W 55W 65W	APVSG04 APVSG06, APVSG12 APVSG20, APVSG40
Main adapter supplied (without options)	100 - 240 VAC 50/60Hz; 24 VDC and 65W max	APVSG04, APVSG06, APVSG12
	100 - 240 VAC 50/60Hz; 24 VDC and 160 W max	APVSG20, APVSG40

Multi-channel model

Input voltage range	100 - 240 VAC 50/60Hz	
Fuse rating	5x20mm, 250 V, 5 AT	2-poles, each
Power consumption (max) (without options)	200 W	APVSG4-4

Environmental (Levels similar to MIL-PRF-28800F Class 3/4)

Environmental stress Samples of this product have been type tested to be robust against the environmental stresses of storage, transportation, and end-use; those stresses to temperature, humidity, shock, vibration, altitude, and power line conditions.

Operating temperature range: 0 to 45 °C

Storage temperature range: -40 to 70 °C

Operating and storage altitude up to 15,000 feet (4600 m)



notice

EMC complies to EMC regulations and directives for emission and immunity to interference (EN 61326-1 Industrial, EN/IEC 61326-2-1).

Safety complies to applicable safety regulation IEC/EN 61010-1.

This product complies with directive 2011/65/EU.

Single-channel (portable / benchtop)

Weight: 2.72 kg (6 lbs) net, \leq 3.63 kg (8 lbs) shipping

Dimensions: 124 mm H x 182 mm W x 305 mm L (incl. connectors) [4.21 in H x 6.77 in W x 11.42 in L]

Multi-channel (rack-mountable) 19" 2HU enclosure

Weight: 18 kg (37 lbs) net, \leq 25 kg (8 lbs) shipping

Dimensions:

Body: 86 mm H x 444 mm W x 567mm L [3.4 in H x 16.8 in W x 18.9 in L]

Front panel: 88 mm H x 486.2mm W [3.46 in H x 19.14 in W]

Recommended calibration cycle: 24 months



Document History

Version/Status	Date	Author	Notes
V110	2019-10-28	jk	Update
V111	2020-02-20	yg/jk	Update
V113	2020-03-31	jk	Analog modulations revised, option EIQ added, measurement plots added
V114	2020-04-31	jk	New plots added
V120	2020-11-10	jk	Extended to multi-channel, 12GHz model
V121	2021-1-10	jk	Power specs refined, data plots added
V122	2021-05-03	rp	Pulse modulation, marker, multi-function in/outputs specs refined
V123	2021-06-01	ee	Updated product images
V124	2021-06-25	jk	Refined power ranges

AnaPico Inc.

Europastrasse 9
8152 Glattbrugg
Switzerland

Phone +41 44 440 00 50
Email sales@anapico.com

www.anapico.com
www.anapico.com/downloads/

