

INSTRUCTION MANUAL

AMB 45

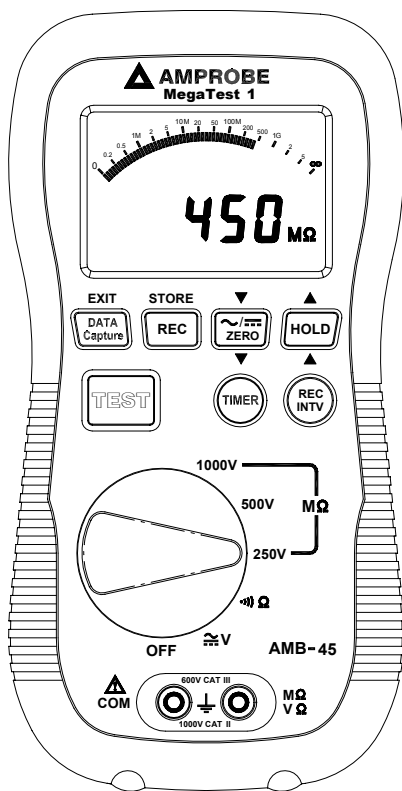

 **AMPROBE** [®]

CONTENTS	PAGE
I. SAFETY INFORMATION.....	2
Environment conditions.....	2
Maintenance & Cleaning.....	2
Safety symbols.....	3
II. GENERAL SPECIFICATION.....	3
III. ELECTRICAL SPECIFICATION.....	4
IV. SYMBOL DEFINITION & BUTTON LOCATION.....	5
V. MEASURING FUNCTION.....	7
1. ACV Function.....	7
2. DCV Function.....	7
3. Low Ohm Function and Continuity Function.....	7
4. MegaOhm Function.....	7
VI. AUTO POWER OFF.....	10
VII. BATTERY CHANGING.....	10
VIII. FUSE CHANGING.....	10

I. SAFETY INFORMATION

- Read the following safety information carefully before attempting to operate or service the meter.
- The circuit under test must be de-energized and isolated before connections are made except for voltage measurement.
- Circuit connections must not be touched during a test.
- After insulation test, capacitance circuits must be allowed to discharge before disconnecting the test leads.
- To avoid damages to the instrument do not apply the signals, which exceed the maximum limits shown in the technical specification tables, to the meter.
- Do not use the meter or test leads if they look damaged. Use extreme caution when working around bare conductors or bus bars.
- Use the meter only as specified in this manual; otherwise, the protection provided by the meter may be impaired.
- Caution when working with voltages above 60V DC or 30 V AC RMS. Such voltages pose a shock hazard.
- Before taking resistance measurements or testing acoustic continuity, disconnect circuit from main power supply and all loads from the circuit.



Environment conditions:

- ① Installation Categories III 600V
- ② Pollution Degree 2
- ③ Altitude up to 2000 meters
- ④ Indoor use only
- ⑤ Relatively humidity 80% max.
- ⑥ Operation Temperature 0~40°C

Maintenance & Cleaning:

- ① Only qualified personnel should perform repairs or servicing not covered in this manual.
- ② Periodically wipe the case with a dry cloth. Do not use abrasives or solvents on these instruments.

Safety symbols:

-  Caution (Refer to this manual before using the meter)
-  Dangerous voltages, risk of electric shock.
-  Meter is protected throughout by double insulation.
When servicing, use only specified replacement parts.

Approvals:  EN-61010-1 600V CAT III 1000V CATII
VDE 0413

II. GENERAL SPECIFICATION:

- **Display:**
70 x 46mm Big LCD Panel with 60 segments analog bar Indication.
- **Over range Indication:**
“OL” will be shown on the LCD Panel when out of range measurement is made.
- **Low Battery Indication:**
The  will be show when the battery need to be changed.
- **Sampling Rate:**
2.5 times/sec Digital Display; 10 times/sec Bar Graph
- **Power Source:**
1.5V AA size Battery X 8
- **Operating Temperature and Humidity:**
0°C to 40°C (32°F to 104°F), bellow 80% RH
- **Storage Temperature:**
-10°C to 60°C (14°F to 140°F)
- **Dimension:**
230 x 116 x 62 mm ; 9 x 4.6 x 2.4 inch
- **Weight:**
Approx. 750g(with battery)
- **Accessories:**
Test Lead, Large Jaw Alligator Clips, Battery, Instruction Manual, Carrying Case, software, RS-232 cable.

III. ELECTRICAL SPECIFICATION:

- AC Voltage

Range	Resolution	Accuracy
600V	0.1V	1.5%rdg+5dgts

- DC Voltage

Range	Resolution	Accuracy
600V	0.1V	1%rdg+3dgts

- Ω Ohms (Autoranging)

Range	Resolution	Accuracy
400 Ω	0.1 Ω	1%rdg+5dgts
4000 Ω	1 Ω	

- **•••** Continuity beeper

Range	Active	Protection
•••	$\leq 40\Omega$	250Vrms

- M Ω (Autoranging)

Range	Resolution	Accuracy
4/40/400/4000M Ω (250V)	1K Ω	3%rdg+5dgts < 2G Ω
4/40/400/4000M Ω (500V)		5%rdg+5dgts < 4G Ω
4/40/400/4000M Ω (1000V)		

Recording Length: 4000 records

IV. Symbol Definition and Button Location

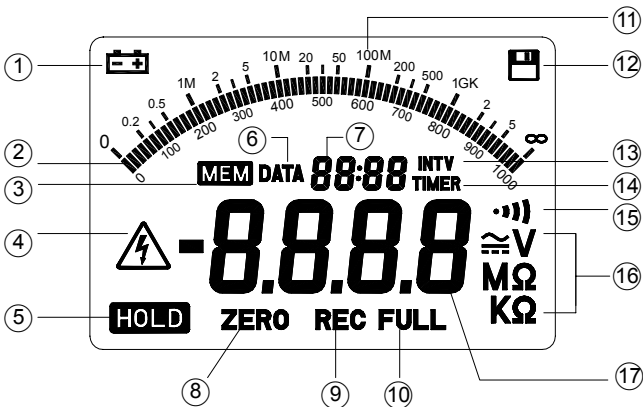

Symbol Definition:

- ① Low battery
- ② Analog bar display
- ③ Data in capture memory
- ④ High voltage warning
- ⑤ Data hold
- ⑥ Data capture mode indication
- ⑦ Second digit display
- ⑧ Low ohm zero function
- ⑨ REC in process
- ⑩ Memory full
- ⑪ Analog Bar Scale
- ⑫ Data recording
- ⑬ REC interval symbol
- ⑭ Insulation test timer symbol
- ⑮ Continuity buzzer function
- ⑯ Measuring unit
- ⑰ Main digit display

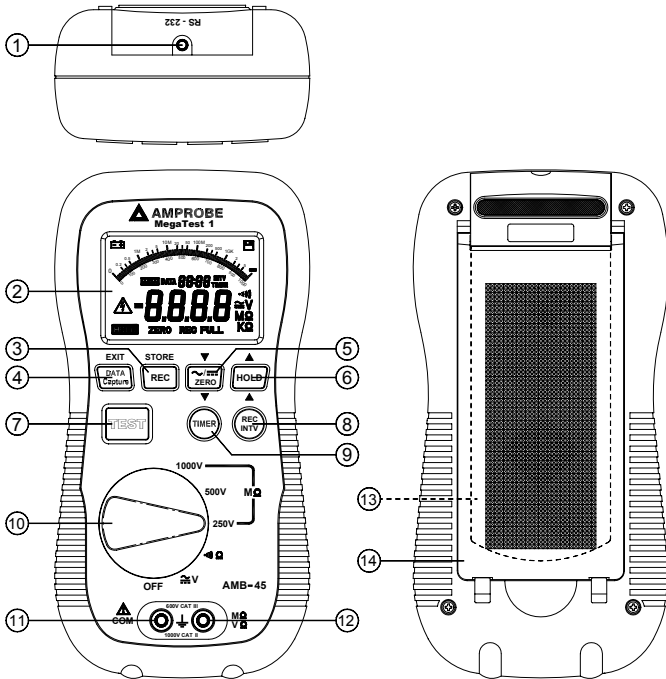

① RS232 connector

② LCD Display

③ REC button

④ Data capture Button

⑤ AC/DC button

⑥ Data Hold Button

⑦ TEST Button

⑧ REC interval setup button

⑨ Insulation timer button

⑩ Function selection dial

⑪ Black terminal

⑫ Red terminal

⑬ Battery Compartment Cover

⑭ Foldable stand



V. MEASURING FUNCTIONS

1. ACV Function:

Turn function selector to voltage range. Connect black test lead to Black terminal and red one to the Red terminal. Connect test lead to the test circuit in parallel. Operator can hold the reading by pressing the  key.



2. DCV Function:

Turn function selector to voltage range. Connect black test lead to Black terminal and red one to the Red terminal.

Press the  button to change the mode from ACV to DCV function. Connect test lead to the test circuit in parallel. One can hold the reading by pressing the  key.

3. Low Ohm Function and Continuity Function:

Turn function selector to Ohm range. Connect black test lead to Black terminal and red one to the Red terminal. Connect test lead to the test circuit in parallel. If the reading is less than 40 Ohm, the continuity beeper will sound.



One may null the lead resistance (under 40 Ohm) by shorting the test lead then press the  key. When the lead resistance is recorded a ZERO symbol will display on the LCD. Press  key again to go back to normal operation. If the lead resistance is great than 40Ω, the error beeping will sound. Because the test current provided by the meter could reach 200mA, do not use this range to test electronic component like diode, transistor or fuse.

Caution: Before measuring, verify the circuit is not live by voltage function

4. MegaOhm Function:



Turn the function selector to the desired test voltage range. The LCD will display “----” to indicate the tester is standing by. Connect black test lead to Black terminal and red one to the Red terminal. Connect test lead to the test circuit in parallel. One may take the measuring under manual power mode or power lock mode:



- **Manual Mode:** If the timer symbol and setup is not shown on the center of LCD, the tester is under manual mode. Press the test key to activate the test voltage source and the measuring will stop after it got the first stable reading or the  is pressed again before a stable reading is reached. A periodic beeping will warn the high voltage output. A series of beeping with shorter period indicate the discharging in progress. When the beeper stops, the discharge is completed. The test result will be held on the display automatically.

Lock Mode: Press the  button to enter or exit the Power Lock operation mode. Under this mode the timer and setup will be shown in the center of LCD. Press the test button once to activate the test source and the testing down counter will be shown in the 2nd digital display. A periodic beeping will warn the high voltage output. The test process can be stop by pressing the  button again or when the testing down counter reaches zero. A series of beeping with shorter period indicate the discharging in progress. When the beeper stops, the discharge is completed. The test result will be held on the display automatically.





 **Caution:**



Before measuring, verify the circuit is not live by voltage function.
Do not stare the test before the lead is connected to the test circuit properly.
Do not remove the test leads from the test circuit before the discharge process is completed.

Setup Timer: When the function selector is under insulation ranges, the user can setup the timer by pressing  for 2 seconds. The timer setup will blink in LCD and it can be changed by  and  keys. Pressing these keys one time will change the setup by one second and pressing these keys for more than two seconds the value will change continuously. Once the setup is done, the user needs to press the timer again to store the value into the memory.

Setup REC interval: The user can setup the REC interval by pressing . The interval setup will blink in LCD and it can be changed by  and  keys. Pressing these keys one time will change the setup by one second and pressing these keys for more than two seconds the value will change continuously. Once the setup is done, the user needs to press the timer again to store the value into the memory.

Start/Stop REC measuring DATA: When the function selector is under voltage and low resistance ranges, the user can start the REC function by pressing  key. The REC symbol will display in the LCD. The REC down counter will also be shown in LCD to forecast the next data sampling time. When the second that the recording occurs, a disk symbol will be shown to indicate this process. When the function selector is under insulation ranges, the user can set the REC mode only before the measuring start. If the REC mode is set, a measuring will start the REC process automatically.

Data Capture Function: When the user want to store a reading on the LCD, he can press  key to enter data capture window. The tester will automatically searched the next available capture memory to store the reading or the user can browse up and down by press the  and  keys. Once the address is chosen, the user need to press  key to store reading. The user can exit data capture window by press  key again.

Erase Data Memory: The user can erase all the memory in the following process. Turn the tester off. Press and hold  key then turn on the tester.  will be shown to indicate the erasing is under process. When it is done, message  will be shown in the LCD and the user can release the key.

VI. AUTO POWER OFF

When the tester is idle for thirty minutes, with no function selector or button operation, it will turn itself off automatically. To turn the tester on again, the user has to turn the function selector to "OFF" position, then the selected function.

VII. BATTERY CHANGING

When  appear on the LCD, the battery need to be replaced with new ones. To replace the battery the user should turn the function selector to OFF position. Then the user needs to open the battery compartment cover with a screwdriver. Eight AA 1.5V batteries are needed to replace the old ones. After all Batteries are changed, put the cover back and fasten the screw.

VIII. FUSE CHANGING:

When connect the meter under Ohm rang to a source > 10V, the protection fuse will break the circuit and new one will be needed for replacement. To replace the fuse, user should prepare an F 0.5A 600V fuse. First, the user should turn the tester off and remove the test leads then remove the Back Cover and Replace the fuse.

WARRANTY

Congratulations! Your new instrument has been quality crafted according to quality standards and contains quality components and workmanship. It has been inspected for proper operation of all of its functions and tested by qualified factory technicians according to the long-established standards of our company.

Your instrument has a limited warranty against defective materials and/or workmanship for one year from the date of purchase provided that, in the opinion of the factory, the instrument has not been tampered with or taken apart.

Should your instrument fail due to defective materials, and/or workmanship during this one year period, a no charge repair or replacement will be made to the original purchaser. Please have your dated bill of sale, which must identify the instrument model number and serial number and call the number listed below:

**Repair Department
ATP – Amprobe, TIF, Promax
Miramar, FL
Phone: 954-499-5400
800-327-5060
Fax: 954-499-5454
Website: www.amprobe.com**

Please obtain an RMA number before returning product for repair.

Outside the U.S.A. the local representative will assist you. Above limited warranty covers repair and replacement of instrument only and no other obligation is stated or implied.



ADVANCED TEST PRODUCTS

Miramar, FL
Phone: 954-499-5400
Fax: 954-499-5454
www.amprobe.com