

REV.	DATE	DESCRIPTION
NC	01/16/03	INITIAL RELEASE
A	06/11/03	ADD MOUNTING HOLE DIMS.

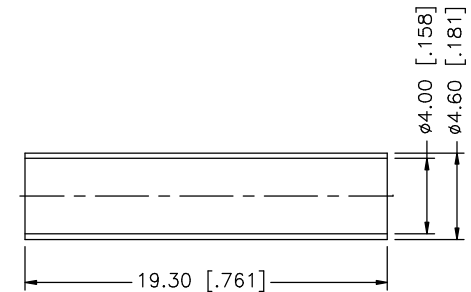
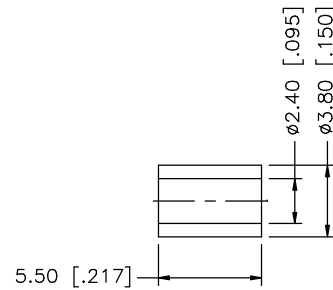
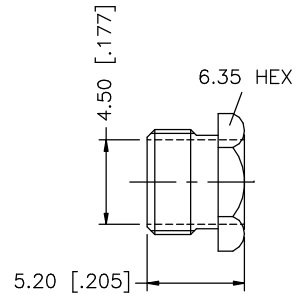
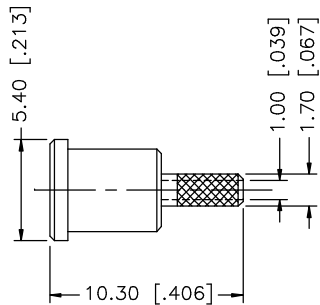
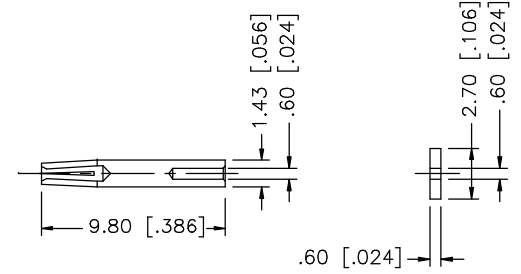
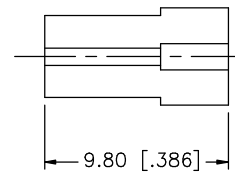
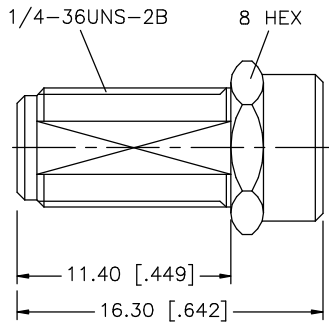
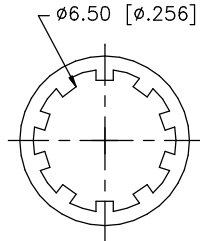
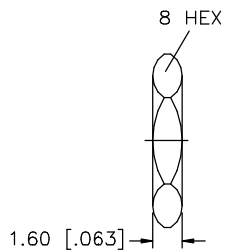
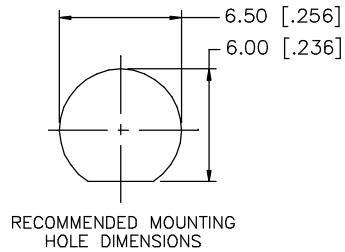
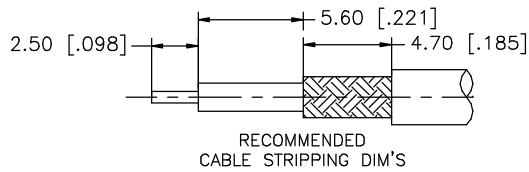

DESCRIPTION	MATERIAL	FINISH	QTY
8			
7	HEAT SHRINK		
6	FERRULE	COPPER	GOLD 1
5	HEX NUT	BRASS	GOLD 1
4	BARREL	BRASS	GOLD 1
3	CONTACT PIN	BRASS	GOLD 1
2	INSULATOR	TEFLON	NATURAL 1
1	HOUSING/BODY	BRASS	GOLD 1

UNLESS OTHERWISE SPECIFIED DIMENSIONS ARE IN MILLIMETERS. DIMENSIONS IN [] ARE IN INCHES AND FOR CUSTOMER REFERENCE ONLY.

UNLESS OTHERWISE SPECIFIED TOLERANCES FOR MILLIMETERS ARE:
0.5 - 8mm ± 0.20mm
8 - 30mm ± 0.40mm
30 - 120mm ± 0.50mm

UNLESS OTHERWISE SPECIFIED TOLERANCES FOR INCHES ARE:
.020 - .315 = ± 0.007"
.315 - 1.180 = ± 0.015"
1.180 - 4.724 = ± 0.020"

DO NOT SCALE DRAWING

APPROVALS	DATE
DRAWN G.R.S.	06/11/03
CHECKED	
ISSUED	
SHEET 1 OF 1	
CAD FILE C:/132/132220.DWG	

Amphenol Connex

PART DESCRIPTION
**SMA BULKHEAD CRIMP JACK
(FOR RG-178B/U, 196/U CABLE)**

PART NO. **132220**

DWG. NO.	REV.	SIZE	SCALE
132220.DWG	A	A	NA