

8 Terminal

Vertical PCB
Spring Clamp



TECHNICAL INFORMATION

Electrical: 10A, 300V, 26-14 AWG
Housing Material: Glass-filled Polycarbonate
Temperature Range: Up to 125°C (257°F)
Flammability Rating: UL94 V-O
Color: Light Gray

Terminal Type: Spring Cage Clamp
Terminal Screw Size: –
Recommended Torque: –
Max. PCB's: (1) Vertical
Mounting: 35mm DIN Rail or optional panel mounting*

ORDERING INFORMATION

Part Number	Type	Description	PCB Connection
91.501	KU4037B	Right Angle Pins	Machine Solder/ Wire Jumper

ACCESSORIES

Accessories	Part Number	Type
1 Meter DIN Rail	2511120/1M	TS35x7.5/1M
*Panel Mount Tab	93.001.5	PMA/KU

ENCLOSURE DRAWING (To convert to inches divide by 25.4.)

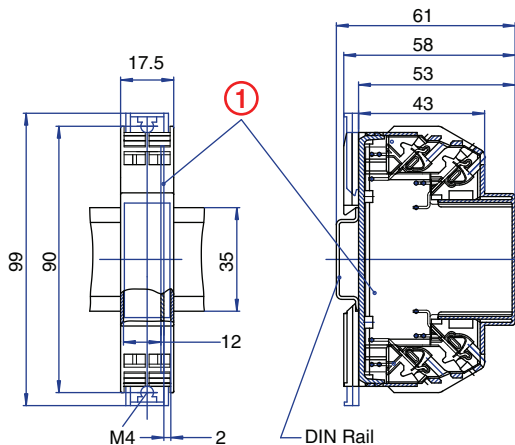

PCB DRAWING (To convert to inches divide by 25.4.)

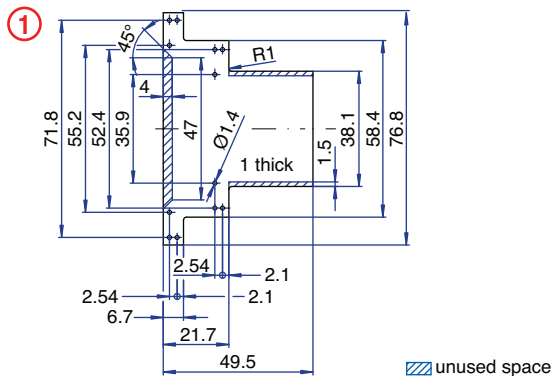

8 Terminal

Horizontal PCB
Spring Clamp



TECHNICAL INFORMATION

Electrical: 10A, 300V, 26-14 AWG
Housing Material: Glass-filled Polycarbonate
Temperature Range: Up to 125°C (257°F)
Flammability Rating: UL94 V-O
Color: Light Gray

Terminal Type: Spring Cage Clamp
Terminal Screw Size: –
Recommended Torque: –
Max. PCB's: (1) Horizontal
Mounting: 35mm DIN Rail or optional panel mounting*

ORDERING INFORMATION

Part Number	Type	Description	PCB Connection
91.502	KU4037C	Straight Pins	Machine Solder

ACCESSORIES

Accessories	Part Number	Type
1 Meter DIN Rail	2511120/1M	TS35x7.5/1M
*Panel Mount Tab	93.001.5	PMA/KU

ENCLOSURE DRAWING (To convert to inches divide by 25.4.)

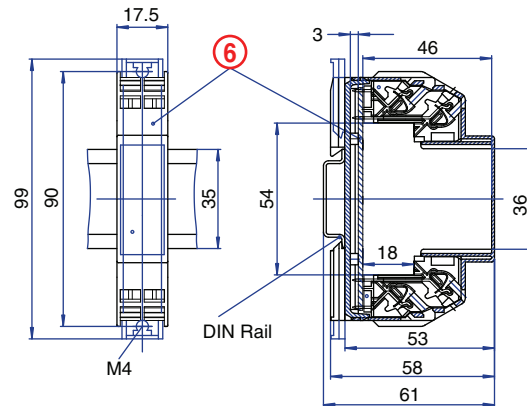

PCB DRAWING (To convert to inches divide by 25.4.)

