

# Digital Multimeter Models 5212, 5215 & 5217



ENGLISH

User Manual

 **AEMC**<sup>®</sup>  
INSTRUMENTS  
CHAUVIN ARNOUX GROUP



Copyright © Chauvin Arnoux®, Inc. d.b.a. AEMC® Instruments. All rights reserved.

No part of this documentation may be reproduced in any form or by any means (including electronic storage and retrieval or translation into any other language) without prior agreement and written consent from Chauvin Arnoux®, Inc., as governed by United States and International copyright laws.

Chauvin Arnoux®, Inc. d.b.a. AEMC® Instruments  
15 Faraday Drive, Dover, NH 03820 USA  
Tel: (800) 945-2362 or (603) 749-6434  
Fax: (603) 742-2346

This documentation is provided “as is,” without warranty of any kind, expressed, implied, or otherwise. Chauvin Arnoux®, Inc. has made every reasonable effort to ensure that this documentation is accurate; but does not warrant the accuracy or completeness of the text, graphics, or other information contained in this documentation. Chauvin Arnoux®, Inc. shall not be liable for any damages, special, indirect, incidental, or inconsequential; including (but not limited to) physical, emotional, or monetary damages due to lost revenues or lost profits that may result from the use of this documentation, whether or not the user of the documentation has been advised of the possibility of such damages.

Chauvin Arnoux®, Inc., AEMC®, are registered trademarks of Chauvin Arnoux®, Inc.

# Statement of Compliance

---

Chauvin Arnoux®, Inc. d.b.a. AEMC® Instruments certifies that this instrument has been calibrated using standards and instruments traceable to international standards.

We guarantee that at the time of shipping your instrument has met its published specifications.

**An N.I.S.T. traceable certificate may be requested at the time of purchase, or obtained by returning the instrument to our repair and calibration facility, for a nominal charge.**

The recommended calibration interval for this instrument is 12 months and begins on the date of receipt by the customer. For recalibration, please use our calibration services. Refer to our repair and calibration section at [www.aemc.com](http://www.aemc.com).

**Serial #:** \_\_\_\_\_

**Catalog #:** 2154.07/2154.08/2154.09

**Model #:** 5212/5215/5217

Please fill in the appropriate date as indicated:

Date Received: \_\_\_\_\_











Date Calibration Due: \_\_\_\_\_



Chauvin Arnoux®, Inc.  
d.b.a AEMC® Instruments  
[www.aemc.com](http://www.aemc.com)

Thank you for purchasing the AEMC Multimeter.

For best results from your instrument and for your safety, read the enclosed operating instructions carefully and comply with the precautions for use. These products must be only used by qualified and trained users.

	Signifies that the instrument is protected by double or reinforced insulation.
	This symbol on the instrument indicates a WARNING that the operator must refer to the user manual for instructions before operating the instrument. In this manual, the symbol preceding instructions indicates that if the instructions are not followed, bodily injury, installation/sample and/or product damage may result.
	Compliance with the Low Voltage & Electromagnetic Compatibility European directives (73/23/CEE & 89/336/CEE)
	AC – Alternating current
	AC or DC – Alternating or direct current
	Risk of electric shock. The voltage at the parts marked with this symbol may be dangerous.
	Important instructions to read and understand completely.
	Important information to acknowledge.
	Ground/Earth symbol
	In conformity with WEEE 2002/96/EC

### Definition of Measurement Categories (CAT)

**CAT IV** Measurement category IV corresponds to measurements taken at the source of low-voltage installations.  
*Example:* power feeders, counters and protection devices.

**CAT III** Measurement category III corresponds to measurements on building installations.  
*Example:* distribution panel, circuit-breakers, machines or fixed industrial devices.

**CAT II** Measurement category II corresponds to measurements taken on circuits directly connected to low-voltage installations.  
*Example:* power supply to domestic electrical appliances and portable tools.

## PRECAUTIONS FOR USE

---

The protection obtained by the instrument can be compromised if it is used in a way that is not recommended by the manufacturer. Carefully read and understand all required precautions when using this instrument.

Failure to comply with these safety instructions can create a risk of electric shock, fire, and explosion; resulting in destruction of the instrument, injury to the user, and damage to the facility. If the instrument is used other than as specified in this manual, the protection provided by the instrument may be impaired.

- Before using the instrument, make sure it functions properly by measuring a known voltage, and check continuity by short-circuiting both test leads.
- Do not use the instrument in an explosive atmosphere or in the presence of flammable gas or smoke.
- Do not use the instrument on electrical networks with a rated voltage or category higher than those listed for the instrument.
- Respect the maximum rated voltages and currents between terminals and in relation to ground/earth.
- Do not use the instrument if it appears damaged, incomplete, or incorrectly closed.
- Before each use, check the condition of the insulation of the leads, the instrument, and all accessories. Any insulation that appears damaged (even partially) must be taken out of service for repair or disposal.
- Use leads and accessories for voltage according to IEC 61010-031 and measurement categories at least equal to those of the instrument. An accessory with a lower category reduces the category of the combined multimeter/accessory combination to that of the accessory.
- Respect the environmental conditions of use listed in this manual.
- Strictly comply with the fuse specifications. Disconnect all cables before opening the fuse access cover.
- Do not modify the instrument or replace components using substitute parts. Repairs and adjustments must be performed by AEMC® Instruments.
- Replace the battery immediately if the  symbol appears on the display. Disconnect all leads before opening the battery access cover.
- Use personal protection equipment when conditions require it.
- Keep hands and fingers away from unused terminals.

# Table of Contents

---

<b>1. INTRODUCTION .....</b>	<b>5</b>
1.1 Receiving Your Shipment.....	5
1.2 Ordering Information.....	5
1.2.1 Replacement Parts.....	5
1.3 Introducing the Models 5212, 5215 & 5217.....	6
1.4 Front Panel.....	8
1.5 LCD Screen.....	9
1.6 Buttons.....	10
1.7 Selection Dial.....	10
1.8 Terminals.....	11
<b>2. SET UP &amp; OPERATION .....</b>	<b>12</b>
2.1 Setup.....	12
2.1.1 Installing Batteries.....	12
2.1.2 Mounting.....	13
2.1.3 Instrument Check.....	14
2.2 Measurement Options.....	14
2.2.1 Manual Range and Auto Range.....	15
2.2.2 Display Hold.....	15
2.2.3 Max-Min Spread (Models 5215 and 5217).....	15
2.2.4 Relative Measurement (Models 5215 and 5217).....	16
2.3 Operation.....	16
2.3.1 Non-Contact Voltage Detection (NCV).....	17
2.3.2 Voltage Measurement.....	18
2.3.3 DC and AC Current Measurement.....	19
2.3.4 Continuity Check.....	20
2.3.5 Resistance Measurement.....	21
2.3.6 Diode Test.....	22
2.3.7 Capacitance Measurement.....	23
2.3.8 Frequency & Duty Cycle Measurement (Model 5217).....	24
2.3.9 Temperature Measurement (Model 5217).....	24
<b>3. SPECIFICATIONS.....</b>	<b>25</b>
3.1 Reference Conditions.....	25
3.2 General Specifications.....	25
3.3 Measurement Resolution and Accuracy.....	26

**4. MAINTENANCE.....28**

- 4.1 Battery Check .....28
- 4.2 Cleaning.....28
- 4.3 Testing and Replacing Fuses.....28
  - 4.3.1 Testing the 10A Fuse .....28
  - 4.3.2 Testing the 630mA Fuse .....29
  - 4.3.3 Replacing a Fuse.....29
- 4.4 Metrological Check and Calibration .....30
- 4.5 Technical and Sales Assistance.....30
- 4.6 Limited Warranty.....31
- 4.7 Warranty Repairs .....31



# 1. INTRODUCTION

## 1.1 Receiving Your Shipment

Upon receiving your shipment, make sure that the contents are consistent with the packing list. Notify your distributor of any missing items. If the equipment appears to be damaged, file a claim immediately with the carrier and notify your distributor at once, giving a detailed description of any damage. Save the damaged packing container to substantiate your claim.

## 1.2 Ordering Information

<b>Multimeter Model 5212</b> .....	<b>Cat. #2154.07</b>
<b>Multimeter Model 5215</b> .....	<b>Cat. #2154.08</b>
<b>Multimeter Model 5217</b> .....	<b>Cat. #2154.09</b>

*Includes meter, soft carrying pouch, set of 2 color-coded leads (red/black), K-Thermocouple adapter (Model 5217), two 1.5V AA batteries and a user manual.*

### 1.2.1 Accessories

Lead - Set of 2, 5 ft (1.5m) Color-coded (Red/Black) Silicone Leads, Test Probes & Alligator Clips {Rated 1000V CAT IV}.....	<b>Cat. #2152.05</b>
MultiFix (universal mounting system) .....	<b>Cat. #5000.44</b>

### 1.2.2 Replacement Parts

Soft Carrying Pouch .....	<b>Cat. #2154.71</b>
Lead - Set of 2, 5 ft (1.5m) Needle Tip Color-coded (Red/Black) w/4mm Right-angle Plug {600V CAT IV w/shield on Needle Tip, 1000V CAT II w/o shield} ..	<b>Cat. #2154.74</b>
K-Thermocouple w/4mm integrated adapter .....	<b>Cat. #2139.71</b>
Fuse - Set of 5, 10A, 1000V (Fast Blow), 30kA, 0.4 x 1.2" (10 x 30mm) .....	<b>Cat. #2154.75</b>
Fuse - Set of 5, 0.63A, 1000V (Fast Blow), 10kA, 0.25 x 1.26" (6.3 x 32mm) .....	<b>Cat. #2154.76</b>

**Order Accessories and Replacement Parts Directly Online**  
*Check our Storefront at [www.aemc.com](http://www.aemc.com) for availability*

### 1.3 Introducing the Models 5212, 5215 & 5217

The Digital Multimeter Models 5212, 5215, and 5217 measure electrical and physical quantities, including:

- AC and DC Voltage
- AC and DC Current
- Resistance and Continuity
- Capacitance
- Frequency and duty cycle (Model 5217)
- Temperature (Model 5217)

The instrument can also perform continuity checks, voltage detection, and diode testing (including forward bias voltage). Measurement features include Auto Range mode, which enables the instrument to select the best range for the input detected, and a Data Hold function.

The following table lists the various features respectively:

	Model 5212	Model 5215	Model 5217
TRMS	●	●	●
LCD	4000 cts	6000 cts	6000 cts
NCV	●	●	●
VLowZ	●	●	●
VAC	●	●	●
VDC	●	●	●
mVAC	●	●	
mVDC	●	●	
AAC	●	●	●
ADC	●	●	●
mAAC		●	●
mADC		●	●
μAAC		●	●
μADC		●	●
Temperature °C & °F			●
Resistance	●	●	●
Diode test	●	●	●
Continuity	●	●	●
Capacitance	●	●	●
HOLD	●	●	●
Backlight	●	●	●
Flashlight	●	●	●

	<b>Model 5212</b>	<b>Model 5215</b>	<b>Model 5217</b>
Auto Range	•	•	•
Max-Min		•	•
Frequency (Hz) and Duty Cycle			•
Relative Measurement		•	•
Sleep Mode	•	•	•

## 1.4 Front Panel

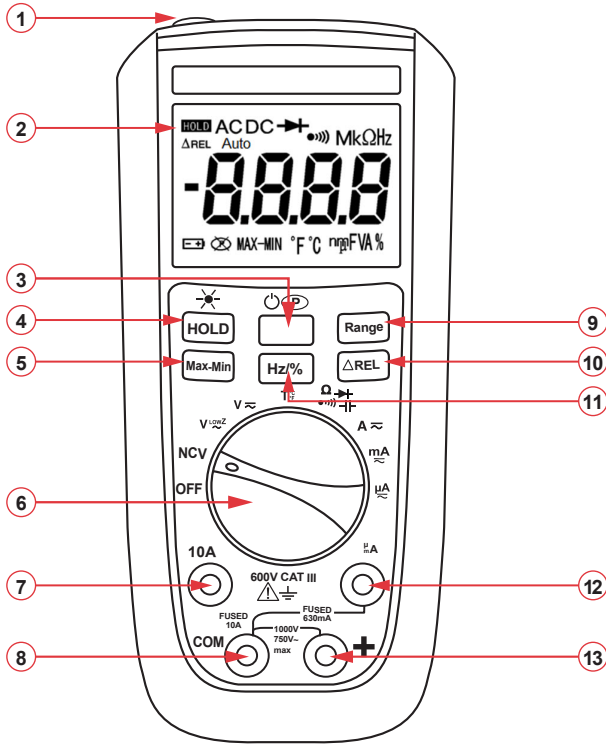

Figure 2-1 (Model 5217 Shown)

The instrument front panel consists primarily of an LCD display, a rotary mode selection dial, function buttons, and input terminals. Different instrument models provide different combinations of buttons, modes, and terminals.

1	"Flashlight" LED	8	Common input terminal
2	LCD display	9	Range button
3	Function (yellow) button Sleep mode enable/disable	10	Relative Measurement button (Models 5215/5217)
4	HOLD button Short press: Holds measurement Long (>2s) press: turns on back- light/flashlight	11	Frequency/duty cycle button (Model 5217)
5	Maximum/Minimum button (Models 5215 and 5217)	12	μmA current input terminal (Models 5215/5217)
6	Measurement selection dial	13	Voltage input terminal
7	10A current input terminal		

## 1.5 LCD Screen

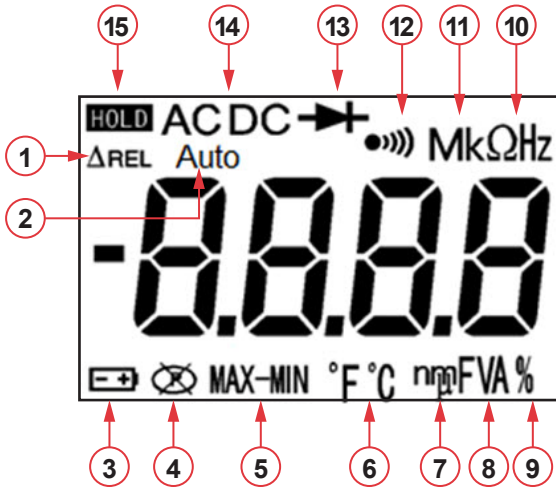

Figure 2-2

In the center of the front panel is the LCD screen. In addition to displaying measurement results, the LCD includes a number of indicator symbols.

1	Relative mode	9	Duty cycle percentage
2	Auto ranging enabled	10	Measurement (resistance or frequency)
3	Low Battery indicator	11	Decimal prefix (mega or kilo)
4	Sleep mode (auto-shutdown) enabled	12	Continuity test selected
5	Max, Min, or Max minus Min indicator	13	Diode test selected
6	Fahrenheit or Celsius indicator	14	AC or DC indicator
7	Decimal prefix (nano, micro, or milli)	15	Display Hold enabled
8	Amps or volts indicator; Capacitance (Farads) indicator		

## 1.6 Buttons

Below the LCD is a set of up to six buttons (model dependent).

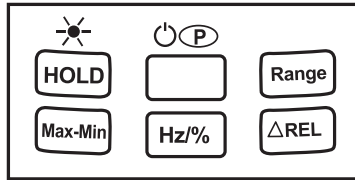

Figure 2-3 (Model 5217)

- **HOLD** freezes the measurement display (see § 2.2.2). A long press (>2 seconds) turns ON the "flashlight" on the top of the instrument, and the LCD backlight.
- **⏻P** (Yellow button) performs several tasks, depending on the instrument mode. These include:
  - Enable and disable Sleep mode (§ 2.1.1.1)
  - Toggle between AC and DC in current and voltage measurements (§ 2.3.2 and 2.3.3)
  - Toggle between continuity/ resistance/ diode/capacitance measurement (§ 2.3.4 through 2.3.6)
  - Toggle between °C and °F for temperature measurements on Model 5217 (§ 2.3.9)
- **Range** enables/disables auto ranging (§ 2.2.1).
- **Max-Min** (Models 5215 and 5217) enables Max-Min mode (§ 2.2.3).
- **ΔREL** (Models 5215 and 5217) enables relative measurement mode (§ 2.2.4).
- **Hz%** (Model 5217) enables frequency and duty cycle measurement (§ 2.3.8).

## 1.7 Selection Dial

The rotary selection dial determines the type of measurement to be made.

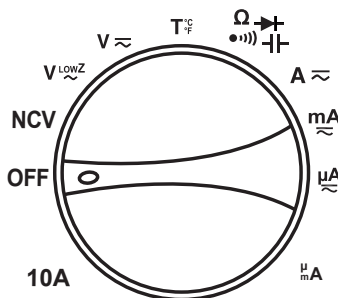

Figure 2-4 (Model 5217)

<b>OFF</b>	Turns the instrument OFF	<b>T</b> $\frac{^{\circ}\text{C}}{\text{F}}$	Temperature (Model 5217)
<b>NCV</b>	Non-Contact Voltage detection	$\Omega$ $\rightarrow$ $\nabla$ $\bullet$ $\rightarrow$ $\nabla$	Continuity/Resistance/Diode test/Capacitance/Fuse check
<b>V</b> $\approx$ <sup>LOWZ</sup>	Voltage with instrument set to low impedance voltage mode	<b>A</b> $\approx$	Amps
<b>V</b> $\approx$	Voltage with instrument set to normal voltage mode	<b>mA</b> $\approx$	milliamps (Models 5215 and 5217)
<b>mV</b> $\approx$	millivolts (Models 5212 and 5215)	<b><math>\mu</math>A</b> $\approx$	microamps (Models 5215 and 5217)

## 1.8 Terminals

The instrument includes three (Model 5212) or four (Models 5215 and 5217) input terminals.

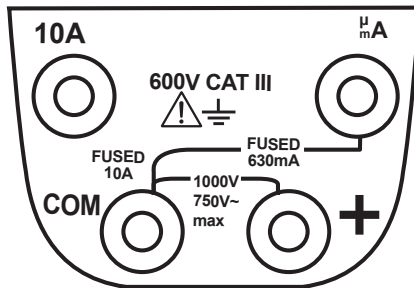

Figure 2-5 (Models 5215 and 5217)

- **10A** is used for measuring AC and DC current up to 10A, and (Model 5217) current frequency/duty cycle. For the Model 5212 this terminal is used for all current measurements. For the Models 5215 and 5217 this is used for **A**  $\approx$  (amp) measurements.
- **$\mu$ mA** (Models 5215 and 5217) is used for AC and DC milliamp and microamp current measurements up to 600mA.
- **COM** (Common) is the “return” terminal used for all measurements.
- **+** is used for measuring voltage, capacitance, and resistance; for checking circuit continuity; and for checking diodes. For the Model 5217, this terminal is also used for measuring temperature and voltage frequency/duty cycle.

## 2. SET UP & OPERATION

### 2.1 Setup

The instrument requires a few simple setup steps before use. This includes:

- Install the batteries and perform a battery check.
- Perform a quick instrument check.
- Select a mounting format (flat or hand-held, magnetic mount, stand).

#### 2.1.1 Installing Batteries

The instrument uses two AA batteries. To install the batteries:

1. Ensure all leads are disconnected from the instrument and the circuit.
2. Remove the protective rubber shock-proof housing from the instrument.
3. Using a screwdriver, remove the two battery cover screws on the back.
4. Lift the instrument stand, and then gently pull on the stand to separate the battery cover from the instrument.
5. Place the batteries in the casing. Be sure to position each with the correct polarity.
6. Replace the battery cover, screws, and protective housing.
7. Turn ON the instrument by selecting any dial setting and check that it powers up correctly. Then check the LCD to see whether or not the Low Battery indicator is displayed. If so, replace the batteries.

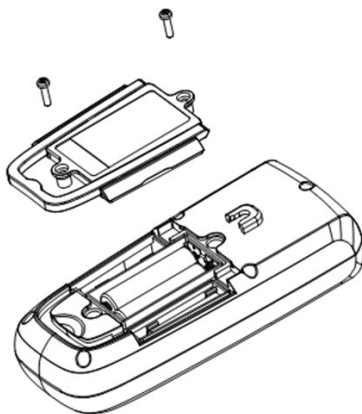





Figure 3-1



### 2.1.1.1 Sleep Mode

To extend battery life, the instrument includes a Sleep mode feature.

In Sleep mode, the LCD turns OFF after 30 minutes of inactivity. Pressing the  (yellow button) restores the LCD. When Sleep mode is enabled, the  symbol appears.

To disable the Sleep mode feature, press and hold down  while turning the instrument ON. (Sleep mode will be re-enabled the next time you turn the instrument ON.)

### 2.1.2 Mounting

The instrument can be mounted three different ways:

- **Stand:** The instrument includes a pull-out stand. When this stand is extended, the instrument can be placed on a horizontal surface for viewing in an upright position.



Figure 3-2

- **Mounting Slot:** On the back of the instrument is a slot that can be slid over a screw head or other mounting point. This lets you mount the instrument to a wall or other permanent location.
- **Magnet Mount:** The removable protective housing includes a set of molded-in magnets located near the top. These allow the instrument to be affixed onto a magnetic surface.

### 2.1.3 Instrument Check

Before using the instrument for the first time, perform a quick series of steps to ensure it is working properly. We also recommend performing this procedure whenever you operate the instrument after a prolonged period of inactivity (a week or longer).

1. Ensure all leads are disconnected from the instrument and the circuit.
2. Turn the instrument ON. Check the startup screen to ensure all symbols and indicators display. (Due to the short duration the startup screen appears, you may need to turn the instrument ON and OFF more than once to check every part of the screen.)
3. Turn the rotary dial to the Continuity  $\Omega \rightarrow \text{diode}$  setting. The LCD should display the symbol **OL**, indicating an overload condition.
4. With the dial still on  $\Omega \rightarrow \text{diode}$ , insert the red test lead into the + (voltage) terminal and the black test lead into the **COM** terminal. Touch the leads together; the beeper should sound, and after a few moments a reading close to 000.0 should appear on the LCD.
5. Turn the dial to a voltage setting (for example **V**  $\approx$ ), select AC or DC by pressing  $\text{P}$ , and touch the leads to a known voltage (such as a battery or AC electrical outlet) to ensure the reading is accurate.

## 2.2 Measurement Options

The instrument includes several features that enhance its measurement and display capabilities, including:

- **Manual and Auto Range** let you set the measurement range yourself or enable the instrument to do it.
- **Display HOLD** lets you “freeze” a measurement displayed on the screen.
- **Maximum/Minimum mode** displays the maximum and minimum measurements and the difference between them (Models 5215 and 5217).
- **Relative Measurement** defines a measurement value against which subsequent measurements will be compared (Models 5215 and 5217).

## 2.2.1 Manual Range and Auto Range

The instrument features both manual range and Auto Range options. Auto Range enables the instrument to automatically select the best measurement range for the detected resistance, voltage, current, or capacitance input. This allows you to have the best resolution without manually resetting the range.

By default, the instrument starts in Auto Range mode, as indicated by the **AUTO** indicator on the LCD. To enable manual ranging, press the **Range** button. Each subsequent press of this button increases the measurement range by one order of magnitude (10x). When the highest range is reached, pressing this button returns to the lowest range.

To exit manual ranging, press and hold down the **Range** button until **AUTO** is displayed on the LCD.

## 2.2.2 Display Hold

To freeze a measurement displayed on the LCD, press the **HOLD** button once. The measurement will remain on the screen until you press the **HOLD** button a second time to resume normal measurement display. When display hold is enabled, the **HOLD** symbol appears on the LCD.

## 2.2.3 Max-Min Spread (Models 5215 and 5217)

By default, the instrument displays measurements continuously in real-time. You can instead have the instrument display only the minimum and maximum values of a measurement session. To do this, turn the instrument dial to the desired measurement type, and proceed as follows:

1. Press the **Max-Min** button. This initiates Max-Min mode, with the maximum value displayed for the measurement session. (The **MAX** symbol appears.) This value will remain on the screen until a higher value is measured.
2. Press the **Max-Min** button a second time to view the minimum value measured during this session. (The **MIN** symbol appears.) As with the maximum, the minimum value remains on the LCD until a lower value is measured.
3. Press the **Max-Min** button a third time to display the difference (spread) obtained by subtracting the maximum from the minimum. (The **MAX-MIN** symbol appears.)
4. To exit this mode, press and hold down the **Max-Min** button for longer than 2 seconds.



**NOTE:** Auto Range is disabled in Max-Min mode.

---

## 2.2.4 Relative Measurement (Models 5215 and 5217)

The instrument lets you define a measurement against which other measurements can be compared. The LCD will then display the difference between the present measurement and the defined “reference” measurement. This feature is available for all measurement types except frequency, duty cycle, NCV, diode, and continuity.

To set the reference measurement, turn the instrument dial to the desired measurement type, and proceed as follows:

1. Touch the test leads to the circuit.
2. When the desired measurement is displayed, press the **ΔREL** button. This stores the measured value as the reference, and activates relative measurement mode. (The **ΔREL** symbol appears on the LCD.)
3. As you take additional measurements, the LCD displays the difference between the real-time measurement and the reference measurement.
4. To exit relative measurement mode, press **ΔREL** until the **ΔREL** symbol disappears.



**NOTE:** Auto Range is disabled in relative measurement mode.

---

## 2.3 Operation

All Model 5200 series instruments can perform the following:

- Voltage measurement (including low impedance voltage via the  $V_{\text{LOWZ}}$  setting)
- Current measurement
- Capacitance measurement
- Resistance measurement
- Diode test (including measuring forward bias voltage and polarity detection)
- Continuity check
- Non-contact voltage detection

In addition, the Model 5217 provides the following measurements:

- Frequency and duty cycle
- Temperature



**WARNING**



**Be sure to carefully observe all safety precautions when testing components, especially when working with unknown currents or voltages.**

### 2.3.1 Non-Contact Voltage Detection (NCV)

The instrument can detect whether or not AC voltage is present in a circuit without making physical contact. Note that the instrument can only detect AC live voltage referenced to the ground.



**Never touch a circuit based solely on whether or not NCV detects voltage. Detection may not occur if:**

- The instrument is held too far away from the conductor under test
- The electric field is weak
- The conductor under test is shielded

To enable voltage detection:

1. Turn the dial to **NCV**.
2. While holding the instrument, point it towards the conductor under measurement and approach the conductor with the top of the instrument
3. If no AC live voltage is detected, the letters EF (Electric Field) appear on the LCD. If AC live voltage is detected, up to four dashes appear on the LCD, the beepers sounds, and the backlight blinks red. The number of dashes displayed, and the speed with which the backlight blinks and buzzer beeps, depends on how close the instrument is held to the live conductor. The closer the conductor, the more dashes are displayed and the faster the blinking/beeping.

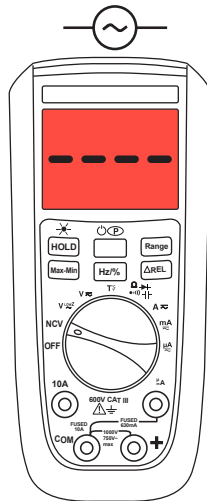

Figure 3-1

### 2.3.2 Voltage Measurement

The instrument provides three settings for measuring voltage:

- $V_{\sim}^{LOWZ}$  lowers the instrument's input impedance to  $500k\Omega$  to help prevent “ghost” voltage from affecting the measurement. (Standard input impedance can be in the 10 to  $11M\Omega$  range, depending on the voltage measurement range selected.)
- $V_{\sim}$  measures volts
- $mV_{\sim}$  measures millivolts (Models 5212 and 5215)

To take a voltage measurement:

1. Connect the red test lead to the **+** terminal and the black test lead to **COM**.
2. Turn the rotary dial to the desired voltage setting ( $V_{\sim}^{LOWZ}$ ,  $V_{\sim}$ , or  $mV_{\sim}$ ).

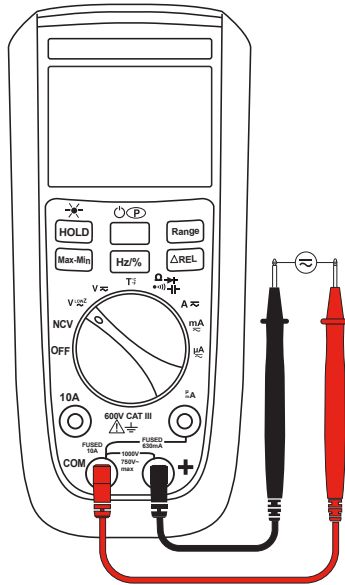

Figure 3-2

3. Connect the probe tips to the circuit under test.
4. Press  $\text{⏏}$  to toggle back and forth between AC and DC measurements. (Note that VDC is not available in  $V_{\sim}^{LOWZ}$  mode.)



**NOTE:** When the Model 5212 or Model 5215 is set to  $mV_{\sim}$ , input above  $400mV$  (Model 5212) or  $600mV$  (Model 5215) displays the  $\text{OL}$  symbol on the LCD, indicating an overload condition.

### 2.3.3 DC and AC Current Measurement

All Model 5200 series instruments provide the  $\mathbf{A}$   $\approx$  setting for measuring current. The Models 5215 and 5217 also include the settings  $\mathbf{mA}$  (milliamps) and  $\mathbf{\mu A}$  (microamps).

By default, the instrument is in DC mode.

To measure current:

1. Connect the black test lead to the **COM** terminal, and the red test lead as follows:
  - For measuring amps, connect to the terminal labeled **10A**.
  - For measuring milliamps or microamps on the Models 5215 and 5217, connect to the terminal labeled  $\mathbf{\mu A}$ .

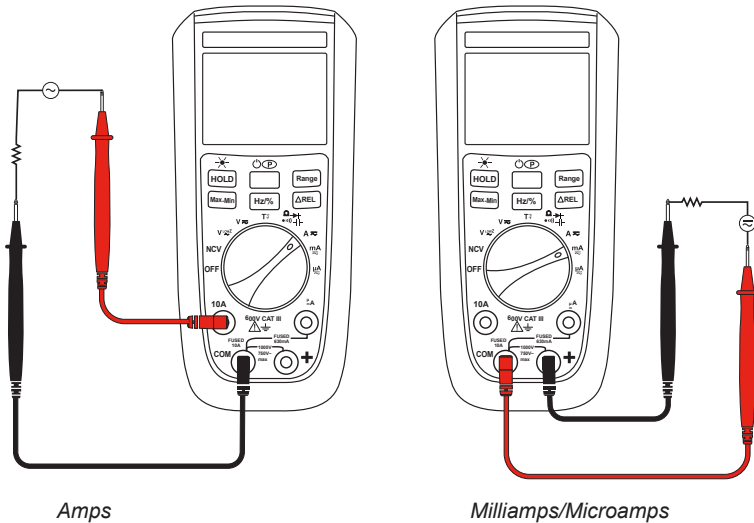

Figure 3-3

2. Turn the dial to the desired current setting ( $\mathbf{A}$   $\approx$ ,  $\mathbf{mA}$   $\approx$ , or  $\mathbf{\mu A}$   $\approx$ ).
3. Connect the probe tips to the circuit under test.
4. Press the yellow  $\text{AC/DC}$  button to toggle back and forth between AC and DC measurements.



**NOTE:** If current is above 10A, an alarm sounds and the instrument's fuse may blow.

### 2.3.4 Continuity Check

The instrument can perform a quick continuity check. This can help determine whether or not a circuit is complete.

1. Ensure that the circuit to be tested has no voltage running through it. An NCV test can help determine whether or not the circuit is live (see § 2.3.1).
2. Connect the red test lead to the + terminal and the black test lead to the **COM** terminal.
3. Turn the dial to . The symbol consists of the Greek letter Omega ( $\Omega$ ) above a diode symbol (a triangle pointing right with a vertical line on its right side).
4. Touch the probes to the desired points in the circuit under test. If there is continuity, the circuit's resistance is displayed on the LCD. If this resistance is under  $50\Omega$ , the beeper also sounds, indicating a potential short circuit.





**NOTE:** If there is no continuity (the resistance is above  $600\Omega$ ), the LCD displays  $\infty L$ , indicating an open circuit or high resistance.  symbol on the LCD, indicating an overload condition.

---



## 2.3.5 Resistance Measurement

To measure resistance, perform the following steps:

1. Ensure that the circuit to be tested has no voltage running through it (see § 2.3.1).
2. Connect the red test lead to the **+** terminal and the black test lead to the **COM** terminal.
3. Turn the dial to .
4. Press the yellow  button once. The symbol **MΩ** appears on the LCD, indicating the instrument is in resistance measurement mode.
5. Touch the probes to the desired points in the circuit under test. The resistance measurement appears on the LCD. If the resistance between the two points is above 60MΩ (or 40MΩ in the Model 5212), the LCD displays the **OL** symbol.

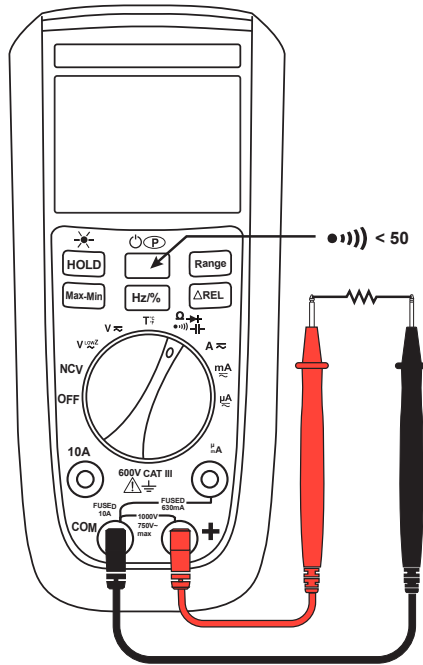

Figure 3-4

### 2.3.6 Diode Test

The instrument can measure the forward bias voltage of a diode, and also determine the diode's polarity.

1. Ensure that the circuit to be tested has no voltage running through it (see § 2.3.1).
2. Connect the red test lead to the **+** terminal and the black test lead to the **COM** terminal.
3. Turn the dial to  $\Omega \rightarrow \text{diode symbol}$ .
4. Press the yellow  $\text{P}$  button twice. The  $\rightarrow \text{diode symbol}$  appears on the LCD, indicating the instrument is in diode testing mode.
5. Touch the red test probe to the anode side of the diode under test, and black test probe to the cathode side. The diode's forward bias voltage is displayed on the screen.
6. If the polarity of the test leads is reversed with diode polarity (or if the forward bias voltage is above 3V) the  $\text{OL}$  symbol appears on the LCD. This can help identify the anode and cathode of the diode.

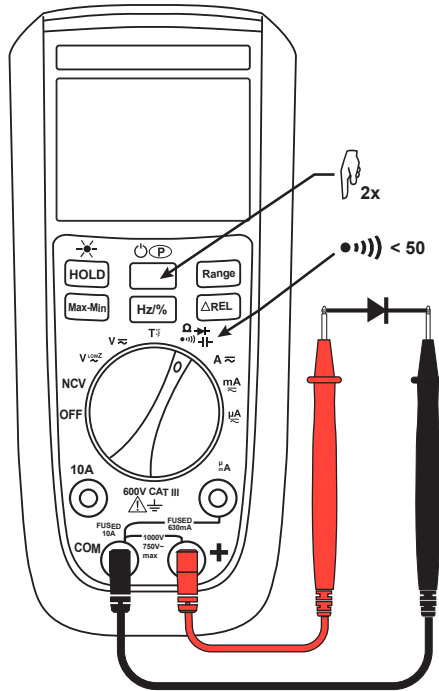



Figure 3-5

## 2.3.7 Capacitance Measurement

To measure capacitance:

1. Ensure that the circuit to be tested has no voltage running through it (see § 2.3.1).
2. Connect the red test lead to the + terminal and the black test lead to the **COM** terminal.
3. Turn the dial to .
4. Press the yellow  button three times. The **nF** symbol appears on the LCD, indicating the instrument is in capacitance measurement mode.
5. Touch the probes to the capacitor leads. After a few moments, the measurement will stabilize and display on the LCD. (This may require 15 seconds or more for measurements in the 100mF range.)

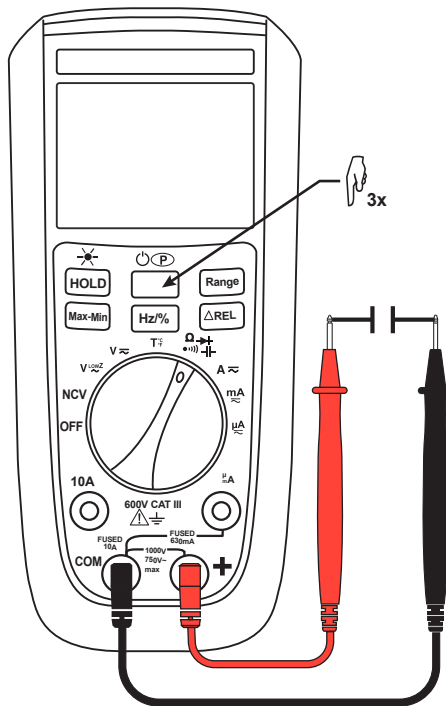

Figure 3-6

### 2.3.8 Frequency & Duty Cycle Measurement (Model 5217)

You can measure frequency while performing an AC voltage or current measurement. The instrument can measure the duty cycle of a square signal.

1. While in any AC current or voltage measurement mode, press the **Hz/%** button. This displays the frequency of the AC signal under measurement. (The symbol **Hz** appears on the LCD.)
2. Press **Hz/%** a second time to display the signal's percent of duty cycle.
3. Press **Hz/%** again to return to normal current/voltage measurement. (The symbol **AC** reappears on the LCD.)

### 2.3.9 Temperature Measurement (Model 5217)

The instrument includes an internal temperature sensor that allows it to display ambient temperature above 0°C without any input. An optional external K type thermocouple (Cat. #2139.71) is available as an accessory.



**Do not measure temperature on a live circuit.**

- Ensure that the circuit to be tested has no voltage running through it (see § 2.3.1).
- Turn the rotary dial to **T<sub>°</sub>**. The instrument displays the ambient temperature as measured by its internal temperature sensor.
- Plug the thermocouple's positive lead into the **+** terminal and the negative lead into the **COM** terminal.
- Touch the thermocouple tip to the object under measurement.
- Allow one minute for thermal stabilization.
- Press the yellow **⏻(P)** button to toggle between Celsius (°C) and Fahrenheit (°F).
- If the measured temperature exceeds 1300°C (2372°F) the LCD displays the **OL** symbol.

## 3. SPECIFICATIONS

### 3.1 Reference Conditions

Influencing Parameters	Reference Conditions
Ambient temperature	23°C ± 3° (73°F ± 5°)
Relative humidity	45 to 75%
AC frequency	60Hz ± 15Hz
Magnetic field	0A/m AC
Electric field	0V/m AC
Electrical purity	In DC: AC < 0.1% of the DC signal In AC: DC < 0.1% of the AC signal

### 3.2 General Specifications

<b>Standard</b>	600V CAT III IEC61010-1, IEC61010-2-033
<b>Display</b>	Digital LCD: <ul style="list-style-type: none"><li>• Models 5215 and 5217: 6000 count updates 3 times/s</li><li>• Model 5212: 4000 count updates 3 times/s</li></ul>
<b>Temperature</b>	Operating: -4°F to 120°F (-20° to 50°C) Storage: -22°F to 130°F (-30° to 55°C)
<b>Temperature coefficient</b>	150ppm (for T °C function 0.15%/°C)
<b>%RH (non-condensing)</b>	< 90% RH (up to 45°C (113°F))
<b>Operating Altitude</b>	0 to 2000m (approximately 6500')
<b>Electromagnetic compatibility</b>	EN 61326-1, EN 61326-2-2
<b>Battery type</b>	2 AA, NEDA 15A, IEC LR6
<b>Battery life</b>	Alkaline: typically 500 hours (approx)
<b>Size (H x W x L)</b>	6.7 x 3.1 x 2" (170 x 80 x 50mm) (with holster)
<b>Weight</b>	11.2 oz (320g approx)
<b>Conformity</b>	CE Marked
<b>Mechanical Conformity</b>	Drop test 1m: IEC 68-2-32 Shock 0.5J (IK04): IEC 68-2-27
<b>Test Probes Conformity</b>	IEC 61010-031
<b>Fuses</b>	<ul style="list-style-type: none"><li>• F1: Fast Fuse 630mA, 1000V, 10kA, size: 6.3 x 32mm (approximately 0.26 x 1.26")</li><li>• F2: Fuse 10A, 1000V, 30kA, size: 10 x 38mm (approximately 0.39 x 1.5")</li></ul>
<b>IP Rating</b>	IP54

### 3.3 Measurement Resolution and Accuracy

In the following table, accuracy is expressed as

$$\pm (x\% + y)$$

where  $x\%$  = the percentage of the reading and  $y$  = a number of counts (measured units). For example, the table below indicates that for measuring AC voltage the accuracy is 0.5% +4cts.

Accuracy values assume operation within the reference conditions listed in § 3.1.

Measurement	Range			Res.	Accuracy		
	Model 5212	Model 5215	Model 5217		Model 5212	Model 5215	Model 5217
$V_{AC}$	4.000V	6.000V	6.000V	0.001V	0.5%+4cts		
	40.00V	60.00V	60.00V	0.01V			
	400.0V	600.0V	600.0V	0.1V			
	600V	750V	750V	1V			
$V_{DC}$	4.000V	6.000V		0.001V	0.2%+2cts	0.2%+2cts	
	40.00V	60.00V		0.01V			
	400.0V	600.0V		0.1V			
	600V	1000V		1V	0.5%+2cts		
$mV_{AC}$	40.00mV	60.00mV	N/A	0.01mV	N/A		
	400.0mV	600.0mV		0.1mV			
$mV_{DC}$	40.00mV	60.00mV		0.01mV			
	400.0mV	600.0mV		0.1mV			0.2%+2cts
$A_{AC}$	4.000A	6.000A		0.001A	1%+5cts		
		10.00A		0.01A	0.5%+5cts		
$A_{DC}$	4.000A	6.000A		0.001A	1%+5cts		
		10.00A		0.01A	0.5%+5cts		
$mA_{AC}$	N/A	60.00mA		0.01mA	N/A	0.5%+5cts	
		600.0mA		0.1mA			
$mA_{DC}$		60.00mA		0.01mA		0.5%+3cts	
		600.0mA		0.1mA			
$\mu A_{AC}$		600.0μA		0.1μA		1%+5cts	
		6000μA		1μA			
$\mu A_{DC}$	600.0μA		0.1μA	0.5%+5cts			
	6000μA		1μA				

Measurement	Range			Res.	Accuracy		
	Model 5212	Model 5215	Model 5217		Model 5212	Model 5215	Model 5217
Resistance	400.0Ω	600.0Ω		0.1Ω	0.5%+5cts		
	4.000kΩ	6.000kΩ		0.001kΩ			
	40.00kΩ	60.00kΩ		0.01kΩ			
	400.0kΩ	600.0kΩ		0.1kΩ			
	4.000MΩ	6.000MΩ		0.001MΩ	1%+5cts		
	40.00MΩ	60.00MΩ		0.01MΩ	3%+5cts		
Diode test	3.000V			0.001V	10%		
Capacitance	1.000nF			0.001nF	10%+10cts		
	10.00nF			0.01nF	5%+5cts		
	100.0nF			0.1nF	2%+5cts		
	1.000μF			0.001μF			
	10.00μF			0.01μF			
	100.0μF			0.1μF			
	1.000mF			0.001mF	5%+5cts		
	10.00mF			0.01mF			
100.0mF			0.1mF				

## Model 5217 Only

Measurement	Range	Res.	Accuracy
Temperature °C/°F K-type thermocouple	50°C to 1200°C (122°F to 2192°F)	0.1°C (0.2°F)	(2%+1.8°F)
	0°C to 50°C (32°F to 122°F)	0.1°C (0.2°F)	(±5.4°F)
	-55°C to 0°C (-67°F to 32°F)	0.1°C (0.2°F)	(9%+3.6°F)
Frequency	10.00Hz	0.01Hz	1%+3cts
	100.0Hz	0.1Hz	
	1.000kHz	1Hz	
Duty cycle	0.1% to 99.9%	0.1	approximately 1%

Specifications are subject to change without notice

## 4. MAINTENANCE



Instrument repair or replacement of parts must be performed by the factory. Any non-approved repair or other work, such as replacing an original part with a substitute, can severely compromise safety and will void the warranty.

### 4.1 Battery Check

Before each use, turn ON the instrument and check the LCD to see whether or not the Low Battery  indicator is displayed. If so, replace the batteries as instructed in § 2.1.

### 4.2 Cleaning

Periodically wipe the case with a damp cloth and mild detergent. Do not use abrasives or solvents. Dirt or moisture in the terminals can affect the readings. Completely dry the instrument after cleaning and before each use.

### 4.3 Testing and Replacing Fuses

The instrument ships with two fuses, a 10A fuse (installed behind the 10A terminal) and a 630mA “fast” fuse (installed behind the  $\mu\text{A}$  terminal). If the fast fuse is blown the  $\mu\text{A}$  terminal is inactive; if the **10A** fuse is blown the 10A terminal is inactive. (Other functions will operate normally even with one or both fuses blown.)

#### 4.3.1 Testing the 10A Fuse

1. Turn the rotary dial to  (Continuity test).
2. Plug one test lead into the + terminal.
3. Plug the other test lead into the **10A** terminal.
4. Touch the tips of the two leads together. The buzzer beeps, and a reading appears on the LCD. A reading between 0 and 000.2 $\Omega$  indicates the fuse is good. If *OL* appears on the LCD, replace the fuse (see § 4.3.3).



### 4.3.2 Testing the 630mA Fuse

1. Turn the rotary dial to  $\Omega \rightarrow \mu A$ .
2. Press the yellow  $\odot \text{P}$  button to enter auto ranging mode.
3. Plug one test lead into the + terminal.
4. Plug the other test lead into the  $\mu A$  terminal.
5. Touch the tips of the two leads together. A reading of around 6 to 7 $\Omega$  indicates the fuse is good. If  $OL$  appears on the LCD, replace the fuse (see § 4.3.3).

### 4.3.3 Replacing a Fuse



**Only use 10A and 630mA fuses in the instrument, as specified in § 3.2.**

1. Remove the protective housing from the instrument.
2. Using a screwdriver, remove the two battery cover screws on the back.
3. Lift the instrument stand, and then gently pull on the stand to separate the battery cover from the instrument.
4. Locate the fuses (Figure 15). Carefully remove the fuse to be replaced, using a flathead screwdriver or similar implement if necessary.
5. Insert the replacement fuse.
6. Replace the battery cover, screws, and protective cover.



Figure 4-1

## 4.4 Metrological Check and Calibration

To ensure that your instrument meets factory specifications, we recommend that it be scheduled to be shipped to our factory Service Center at one-year intervals for recalibration, or as required by other standards or internal procedures.

**Note for Calibration Laboratories and Facilities:** The Models 5212, 5215, and 5217 include onboard firmware enabling each instrument to be calibrated by connecting the inputs to a calibrator and pressing the front panel push buttons. This information is only released to authorized personnel or facilities. Contact AEMC® Instruments for these calibration procedures.

### **For Instrument Repair and Calibration:**

You must contact our Service Center for a Customer Service Authorization Number (CSA#). This will ensure that when your instrument arrives, it will be tracked and processed promptly. Please write the CSA# on the outside of the shipping container. If the instrument is returned for calibration, we need to know if you want a standard calibration or a calibration traceable to N.I.S.T. (this includes a calibration certificate plus recorded calibration data).

**Ship To:** Chauvin Arnoux®, Inc. d.b.a. AEMC® Instruments  
15 Faraday Drive  
Dover, NH 03820 USA  
Phone: (800) 945-2362 (Ext. 360)  
(603) 749-6434 (Ext. 360)  
Fax: (603) 742-2346 or (603) 749-6309  
E-mail: [repair@aemc.com](mailto:repair@aemc.com)

(Or contact your authorized distributor)

Costs for repair, standard calibration, and calibration traceable to N.I.S.T. are available.

**NOTE: You must obtain a CSA# before returning any instrument.**

## 4.5 Technical and Sales Assistance

If you are experiencing any technical problems, or require any assistance with the proper operation or application of your instrument, please call, fax or e-mail our technical support team:

**Contact:** Chauvin Arnoux®, Inc. d.b.a. AEMC® Instruments  
Phone: (800) 945-2362 (Ext. 351)  
(603) 749-6434 (Ext. 351)  
Fax: (603) 742-2346  
E-mail: [techsupport@aemc.com](mailto:techsupport@aemc.com)

## 4.6 Limited Warranty

The Models 5212, 5215 & 5217 are warranted to the owner for a period of three years from the date of original purchase against defects in manufacture. This limited warranty is given by AEMC® Instruments, not by the distributor from whom it was purchased. This warranty is void if the unit has been tampered with, abused or if the defect is related to service not performed by AEMC® Instruments.

Full warranty coverage and product registration is available on our website at [www.aemc.com/warranty.html](http://www.aemc.com/warranty.html).

Please print the online Warranty Coverage Information for your records.

### What AEMC® Instruments will do:

If a malfunction occurs within the warranty period, you may return the instrument to us for repair, provided we have your warranty registration information on file or a proof of purchase. AEMC® Instruments will, at its option, repair or replace the faulty material.

**REGISTER ONLINE AT: [www.aemc.com](http://www.aemc.com)**

## 4.7 Warranty Repairs

What you must do to return an Instrument for Warranty Repair:

First, request a Customer Service Authorization Number (CSA#) by phone or by fax from our Service Department (see address below), then return the instrument along with the signed CSA Form. Please write the CSA# on the outside of the shipping container. Return the instrument, postage or shipment pre-paid to:

**Ship To:** Chauvin Arnoux®, Inc. d.b.a. AEMC® Instruments  
15 Faraday Drive  
Dover, NH 03820 USA  
Phone: (800) 945-2362 (Ext. 360)  
(603) 749-6434 (Ext. 360)  
Fax: (603) 742-2346 or (603) 749-6309  
E-mail: [repair@aemc.com](mailto:repair@aemc.com)

**Caution:** To protect yourself against in-transit loss, we recommend you insure your returned material.

**NOTE:** You must obtain a CSA# before returning any instrument.



10/19

99-MAN 100419 v5