

R&S® SMA100A Signal Generator Quick Start Guide



1400.0069.62 – 09

This document describes the R&S®SMA100A, stock no. 1400.0000k02 and its options.

The firmware of the instrument makes use of the operating system LINUX® and other valuable open source software packages. The most important of them together with their corresponding open source license and the verbatim license texts are provided on the user documentation CD-ROM (included in delivery).

The OpenSSL Project for use in the OpenSSL Toolkit (<http://www.openssl.org/>) includes cryptographic software written by Eric Young (eay@cryptsoft.com) and software written by Tim Hudson (tjh@cryptsoft.com).

Rohde & Schwarz would like to thank the open source community for their valuable contribution to embedded computing.

© 2011 Rohde & Schwarz GmbH & Co. KG

Muehldorfstr. 15, 81671 Munich, Germany

Phone: +49 89 41 29 - 0

Fax: +49 89 41 29 12 164

E-mail: info@rohde-schwarz.com

Internet: <http://www.rohde-schwarz.com>

Printed in Germany – Subject to change – Data without tolerance limits is not binding.

R&S® is a registered trademark of Rohde & Schwarz GmbH & Co. KG.

Trade names are trademarks of the owners.

The following abbreviations are used throughout this manual: R&S®SMA100A is abbreviated as R&S SMA.

Basic Safety Instructions

Always read through and comply with the following safety instructions!









All plants and locations of the Rohde & Schwarz group of companies make every effort to keep the safety standards of our products up to date and to offer our customers the highest possible degree of safety. Our products and the auxiliary equipment they require are designed, built and tested in accordance with the safety standards that apply in each case. Compliance with these standards is continuously monitored by our quality assurance system. The product described here has been designed, built and tested in accordance with the attached EC Certificate of Conformity and has left the manufacturer's plant in a condition fully complying with safety standards. To maintain this condition and to ensure safe operation, you must observe all instructions and warnings provided in this manual. If you have any questions regarding these safety instructions, the Rohde & Schwarz group of companies will be happy to answer them.







Furthermore, it is your responsibility to use the product in an appropriate manner. This product is designed for use solely in industrial and laboratory environments or, if expressly permitted, also in the field and must not be used in any way that may cause personal injury or property damage. You are responsible if the product is used for any intention other than its designated purpose or in disregard of the manufacturer's instructions. The manufacturer shall assume no responsibility for such use of the product.

The product is used for its designated purpose if it is used in accordance with its product documentation and within its performance limits (see data sheet, documentation, the following safety instructions). Using the product requires technical skills and a basic knowledge of English. It is therefore essential that only skilled and specialized staff or thoroughly trained personnel with the required skills be allowed to use the product. If personal safety gear is required for using Rohde & Schwarz products, this will be indicated at the appropriate place in the product documentation. Keep the basic safety instructions and the product documentation in a safe place and pass them on to the subsequent users.

Observing the safety instructions will help prevent personal injury or damage of any kind caused by dangerous situations. Therefore, carefully read through and adhere to the following safety instructions before and when using the product. It is also absolutely essential to observe the additional safety instructions on personal safety, for example, that appear in relevant parts of the product documentation. In these safety instructions, the word "product" refers to all merchandise sold and distributed by the Rohde & Schwarz group of companies, including instruments, systems and all accessories.

Symbols and safety labels

							
Notice, general danger location Observe product documentation	Caution when handling heavy equipment	Danger of electric shock	Warning! Hot surface	PE terminal	Ground	Ground terminal	Be careful when handling electrostatic sensitive devices

					
ON/OFF supply voltage	Standby indication	Direct current (DC)	Alternating current (AC)	Direct/alternating current (DC/AC)	Device fully protected by double (reinforced) insulation

Tags and their meaning

The following signal words are used in the product documentation in order to warn the reader about risks and dangers.



indicates a hazardous situation which, if not avoided, will result in death or serious injury.



indicates a hazardous situation which, if not avoided, could result in death or serious injury.



indicates a hazardous situation which, if not avoided, could result in minor or moderate injury.



indicates the possibility of incorrect operation which can result in damage to the product.

In the product documentation, the word ATTENTION is used synonymously.

These tags are in accordance with the standard definition for civil applications in the European Economic Area. Definitions that deviate from the standard definition may also exist in other economic areas or military applications. It is therefore essential to make sure that the tags described here are always used only in connection with the related product documentation and the related product. The use of tags in connection with unrelated products or documentation can result in misinterpretation and in personal injury or material damage.

Operating states and operating positions

The product may be operated only under the operating conditions and in the positions specified by the manufacturer, without the product's ventilation being obstructed. If the manufacturer's specifications are not observed, this can result in electric shock, fire and/or serious personal injury or death. Applicable local or national safety regulations and rules for the prevention of accidents must be observed in all work performed.

1. Unless otherwise specified, the following requirements apply to Rohde & Schwarz products: predefined operating position is always with the housing floor facing down, IP protection 2X, pollution severity 2, overvoltage category 2, use only indoors, max. operating altitude 2000 m above sea level, max. transport altitude 4500 m above sea level. A tolerance of $\pm 10\%$ shall apply to the nominal voltage and $\pm 5\%$ to the nominal frequency.
2. Do not place the product on surfaces, vehicles, cabinets or tables that for reasons of weight or stability are unsuitable for this purpose. Always follow the manufacturer's installation instructions when installing the product and fastening it to objects or structures (e.g. walls and shelves). An installation that is not carried out as described in the product documentation could result in personal injury or death.
3. Do not place the product on heat-generating devices such as radiators or fan heaters. The ambient temperature must not exceed the maximum temperature specified in the product documentation or in the data sheet. Product overheating can cause electric shock, fire and/or serious personal injury or death.

Electrical safety

If the information on electrical safety is not observed either at all to the extent necessary, electric shock, fire and/or serious personal injury or death may occur.

1. Prior to switching on the product, always ensure that the nominal voltage setting on the product matches the nominal voltage of the AC supply network. If a different voltage is to be set, the power fuse of the product may have to be changed accordingly.
2. In the case of products of safety class I with movable power cord and connector, operation is permitted only on sockets with an earthing contact and protective earth connection.
3. Intentionally breaking the protective earth connection either in the feed line or in the product itself is not permitted. Doing so can result in the danger of an electric shock from the product. If extension cords or connector strips are implemented, they must be checked on a regular basis to ensure that they are safe to use.
4. If the product does not have a power switch for disconnection from the AC supply network, the plug of the connecting cable is regarded as the disconnecting device. In such cases, always ensure that the power plug is easily reachable and accessible at all times (corresponding to the length of connecting cable, approx. 2 m). Functional or electronic switches are not suitable for providing disconnection from the AC supply network. If products without power switches are integrated into racks or systems, a disconnecting device must be provided at the system level.
5. Never use the product if the power cable is damaged. Check the power cable on a regular basis to ensure that it is in proper operating condition. By taking appropriate safety measures and carefully laying the power cable, you can ensure that the cable will not be damaged and that no one can be hurt by, for example, tripping over the cable or suffering an electric shock.
6. The product may be operated only from TN/TT supply networks fused with max. 16 A (higher fuse only after consulting with the Rohde & Schwarz group of companies).
7. Do not insert the plug into sockets that are dusty or dirty. Insert the plug firmly and all the way into the socket. Otherwise, sparks that result in fire and/or injuries may occur.
8. Do not overload any sockets, extension cords or connector strips; doing so can cause fire or electric shocks.
9. For measurements in circuits with voltages $V_{\text{rms}} > 30 \text{ V}$, suitable measures (e.g. appropriate measuring equipment, fusing, current limiting, electrical separation, insulation) should be taken to avoid any hazards.
10. Ensure that the connections with information technology equipment, e.g. PCs or other industrial computers, comply with the IEC60950-1/EN60950-1 or IEC61010-1/EN 61010-1 standards that apply in each case.
11. Unless expressly permitted, never remove the cover or any part of the housing while the product is in operation. Doing so will expose circuits and components and can lead to injuries, fire or damage to the product.
12. If a product is to be permanently installed, the connection between the PE terminal on site and the product's PE conductor must be made first before any other connection is made. The product may be installed and connected only by a licensed electrician.
13. For permanently installed equipment without built-in fuses, circuit breakers or similar protective devices, the supply circuit must be fused in such a way that anyone who has access to the product, as well as the product itself, is adequately protected from injury or damage.

Basic Safety Instructions

14. Use suitable overvoltage protection to ensure that no overvoltage (such as that caused by a bolt of lightning) can reach the product. Otherwise, the person operating the product will be exposed to the danger of an electric shock.
15. Any object that is not designed to be placed in the openings of the housing must not be used for this purpose. Doing so can cause short circuits inside the product and/or electric shocks, fire or injuries.
16. Unless specified otherwise, products are not liquid-proof (see also section "Operating states and operating positions", item 1. Therefore, the equipment must be protected against penetration by liquids. If the necessary precautions are not taken, the user may suffer electric shock or the product itself may be damaged, which can also lead to personal injury.
17. Never use the product under conditions in which condensation has formed or can form in or on the product, e.g. if the product has been moved from a cold to a warm environment. Penetration by water increases the risk of electric shock.
18. Prior to cleaning the product, disconnect it completely from the power supply (e.g. AC supply network or battery). Use a soft, non-linting cloth to clean the product. Never use chemical cleaning agents such as alcohol, acetone or diluents for cellulose lacquers.

Operation

1. Operating the products requires special training and intense concentration. Make sure that persons who use the products are physically, mentally and emotionally fit enough to do so; otherwise, injuries or material damage may occur. It is the responsibility of the employer/operator to select suitable personnel for operating the products.
2. Before you move or transport the product, read and observe the section titled "Transport".
3. As with all industrially manufactured goods, the use of substances that induce an allergic reaction (allergens) such as nickel cannot be generally excluded. If you develop an allergic reaction (such as a skin rash, frequent sneezing, red eyes or respiratory difficulties) when using a Rohde & Schwarz product, consult a physician immediately to determine the cause and to prevent health problems or stress.
4. Before you start processing the product mechanically and/or thermally, or before you take it apart, be sure to read and pay special attention to the section titled "Waste disposal", item 1.
5. Depending on the function, certain products such as RF radio equipment can produce an elevated level of electromagnetic radiation. Considering that unborn babies require increased protection, pregnant women must be protected by appropriate measures. Persons with pacemakers may also be exposed to risks from electromagnetic radiation. The employer/operator must evaluate workplaces where there is a special risk of exposure to radiation and, if necessary, take measures to avert the potential danger.
6. Should a fire occur, the product may release hazardous substances (gases, fluids, etc.) that can cause health problems. Therefore, suitable measures must be taken, e.g. protective masks and protective clothing must be worn.
7. If a laser product (e.g. a CD/DVD drive) is integrated into a Rohde & Schwarz product, absolutely no other settings or functions may be used as described in the product documentation. The objective is to prevent personal injury (e.g. due to laser beams).

Repair and service

1. The product may be opened only by authorized, specially trained personnel. Before any work is performed on the product or before the product is opened, it must be disconnected from the AC supply network. Otherwise, personnel will be exposed to the risk of an electric shock.
2. Adjustments, replacement of parts, maintenance and repair may be performed only by electrical experts authorized by Rohde & Schwarz. Only original parts may be used for replacing parts relevant to safety (e.g. power switches, power transformers, fuses). A safety test must always be performed after parts relevant to safety have been replaced (visual inspection, PE conductor test, insulation resistance measurement, leakage current measurement, functional test). This helps ensure the continued safety of the product.

Batteries and rechargeable batteries/cells

If the information regarding batteries and rechargeable batteries/cells is not observed either at all or to the extent necessary, product users may be exposed to the risk of explosions, fire and/or serious personal injury, and, in some cases, death. Batteries and rechargeable batteries with alkaline electrolytes (e.g. lithium cells) must be handled in accordance with the EN 62133 standard.

1. Cells must not be taken apart or crushed.
2. Cells or batteries must not be exposed to heat or fire. Storage in direct sunlight must be avoided. Keep cells and batteries clean and dry. Clean soiled connectors using a dry, clean cloth.
3. Cells or batteries must not be short-circuited. Cells or batteries must not be stored in a box or in a drawer where they can short-circuit each other, or where they can be short-circuited by other conductive materials. Cells and batteries must not be removed from their original packaging until they are ready to be used.
4. Keep cells and batteries out of the hands of children. If a cell or a battery has been swallowed, seek medical aid immediately.
5. Cells and batteries must not be exposed to any mechanical shocks that are stronger than permitted.
6. If a cell develops a leak, the fluid must not be allowed to come into contact with the skin or eyes. If contact occurs, wash the affected area with plenty of water and seek medical aid.
7. Improperly replacing or charging cells or batteries that contain alkaline electrolytes (e.g. lithium cells) can cause explosions. Replace cells or batteries only with the matching Rohde & Schwarz type (see parts list) in order to ensure the safety of the product.
8. Cells and batteries must be recycled and kept separate from residual waste. Rechargeable batteries and normal batteries that contain lead, mercury or cadmium are hazardous waste. Observe the national regulations regarding waste disposal and recycling.

Transport

1. The product may be very heavy. Therefore, the product must be handled with care. In some cases, the user may require a suitable means of lifting or moving the product (e.g. with a lift-truck) to avoid back or other physical injuries.

2. Handles on the products are designed exclusively to enable personnel to transport the product. It is therefore not permissible to use handles to fasten the product to or on transport equipment such as cranes, fork lifts, wagons, etc. The user is responsible for securely fastening the products to or on the means of transport or lifting. Observe the safety regulations of the manufacturer of the means of transport or lifting. Noncompliance can result in personal injury or material damage.
3. If you use the product in a vehicle, it is the sole responsibility of the driver to drive the vehicle safely and properly. The manufacturer assumes no responsibility for accidents or collisions. Never use the product in a moving vehicle if doing so could distract the driver of the vehicle. Adequately secure the product in the vehicle to prevent injuries or other damage in the event of an accident.

Waste disposal

1. If products or their components are mechanically and/or thermally processed in a manner that goes beyond their intended use, hazardous substances (heavy-metal dust such as lead, beryllium, nickel) may be released. For this reason, the product may only be disassembled by specially trained personnel. Improper disassembly may be hazardous to your health. National waste disposal regulations must be observed.
2. If handling the product releases hazardous substances or fuels that must be disposed of in a special way, e.g. coolants or engine oils that must be replenished regularly, the safety instructions of the manufacturer of the hazardous substances or fuels and the applicable regional waste disposal regulations must be observed. Also observe the relevant safety instructions in the product documentation. The improper disposal of hazardous substances or fuels can cause health problems and lead to environmental damage.

Informaciones elementales de seguridad

Es imprescindible leer y observar las siguientes instrucciones e informaciones de seguridad!

El principio del grupo de empresas Rohde & Schwarz consiste en tener nuestros productos siempre al día con los estándares de seguridad y de ofrecer a nuestros clientes el máximo grado de seguridad. Nuestros productos y todos los equipos adicionales son siempre fabricados y examinados según las normas de seguridad vigentes. Nuestro sistema de garantía de calidad controla constantemente que sean cumplidas estas normas. El presente producto ha sido fabricado y examinado según el certificado de conformidad adjunto de la UE y ha salido de nuestra planta en estado impecable según los estándares técnicos de seguridad. Para poder preservar este estado y garantizar un funcionamiento libre de peligros, el usuario deberá atenerse a todas las indicaciones, informaciones de seguridad y notas de alerta. El grupo de empresas Rohde & Schwarz está siempre a su disposición en caso de que tengan preguntas referentes a estas informaciones de seguridad.

Además queda en la responsabilidad del usuario utilizar el producto en la forma debida. Este producto está destinado exclusivamente al uso en la industria y el laboratorio o, si ha sido expresamente autorizado, para aplicaciones de campo y de ninguna manera deberá ser utilizado de modo que alguna persona/cosa pueda sufrir daño. El uso del producto fuera de sus fines definidos o sin tener en cuenta las instrucciones del fabricante queda en la responsabilidad del usuario. El fabricante no se hace en ninguna forma responsable de consecuencias a causa del mal uso del producto.







Informaciones elementales de seguridad

Se parte del uso correcto del producto para los fines definidos si el producto es utilizado conforme a las indicaciones de la correspondiente documentación del producto y dentro del margen de rendimiento definido (ver hoja de datos, documentación, informaciones de seguridad que siguen). El uso del producto hace necesarios conocimientos técnicos y ciertos conocimientos del idioma inglés. Por eso se debe tener en cuenta que el producto solo pueda ser operado por personal especializado o personas instruidas en profundidad con las capacidades correspondientes. Si fuera necesaria indumentaria de seguridad para el uso de productos de Rohde & Schwarz, encontraría la información debida en la documentación del producto en el capítulo correspondiente. Guarde bien las informaciones de seguridad elementales, así como la documentación del producto, y entréguelas a usuarios posteriores.

Tener en cuenta las informaciones de seguridad sirve para evitar en lo posible lesiones o daños por peligros de toda clase. Por eso es imprescindible leer detalladamente y comprender por completo las siguientes informaciones de seguridad antes de usar el producto, y respetarlas durante el uso del producto. Deberán tenerse en cuenta todas las demás informaciones de seguridad, como p. ej. las referentes a la protección de personas, que encontrarán en el capítulo correspondiente de la documentación del producto y que también son de obligado cumplimiento. En las presentes informaciones de seguridad se recogen todos los objetos que distribuye el grupo de empresas Rohde & Schwarz bajo la denominación de "producto", entre ellos también aparatos, instalaciones así como toda clase de accesorios.

Símbolos y definiciones de seguridad

							
Aviso: punto de peligro general Observar la documentación del producto	Atención en el manejo de dispositivos de peso elevado	Peligro de choque eléctrico	Advertencia: superficie caliente	Conexión a conductor de protección	Conexión a tierra	Conexión a masa	Aviso: Cuidado en el manejo de dispositivos sensibles a la electrostática (ESD)

					
Tensión de alimentación de PUESTA EN MARCHA / PARADA	Indicación de estado de espera (Standby)	Corriente continua (DC)	Corriente alterna (AC)	Corriente continua / Corriente alterna (DC/AC)	El aparato está protegido en su totalidad por un aislamiento doble (reforzado)

Palabras de señal y su significado

En la documentación del producto se utilizan las siguientes palabras de señal con el fin de advertir contra riesgos y peligros.



PELIGRO identifica un peligro inminente con riesgo elevado que provocará muerte o lesiones graves si no se evita.



ADVERTENCIA identifica un posible peligro con riesgo medio de provocar muerte o lesiones (graves) si no se evita.



ATENCIÓN identifica un peligro con riesgo reducido de provocar lesiones leves o moderadas si no se evita.



AVISO indica la posibilidad de utilizar mal el producto y, como consecuencia, dañarlo.

En la documentación del producto se emplea de forma sinónima el término CUIDADO.

Las palabras de señal corresponden a la definición habitual para aplicaciones civiles en el área económica europea. Pueden existir definiciones diferentes a esta definición en otras áreas económicas o en aplicaciones militares. Por eso se deberá tener en cuenta que las palabras de señal aquí descritas sean utilizadas siempre solamente en combinación con la correspondiente documentación del producto y solamente en combinación con el producto correspondiente. La utilización de las palabras de señal en combinación con productos o documentaciones que no les correspondan puede llevar a interpretaciones equivocadas y tener por consecuencia daños en personas u objetos.

Estados operativos y posiciones de funcionamiento

El producto solamente debe ser utilizado según lo indicado por el fabricante respecto a los estados operativos y posiciones de funcionamiento sin que se obstruya la ventilación. Si no se siguen las indicaciones del fabricante, pueden producirse choques eléctricos, incendios y/o lesiones graves con posible consecuencia de muerte. En todos los trabajos deberán ser tenidas en cuenta las normas nacionales y locales de seguridad del trabajo y de prevención de accidentes.

1. Si no se convino de otra manera, es para los productos Rohde & Schwarz válido lo que sigue: como posición de funcionamiento se define por principio la posición con el suelo de la caja para abajo, modo de protección IP 2X, grado de suciedad 2, categoría de sobrecarga eléctrica 2, uso solamente en estancias interiores, utilización hasta 2000 m sobre el nivel del mar, transporte hasta 4500 m sobre el nivel del mar. Se aplicará una tolerancia de $\pm 10\%$ sobre el voltaje nominal y de $\pm 5\%$ sobre la frecuencia nominal.
2. No sitúe el producto encima de superficies, vehículos, estantes o mesas, que por sus características de peso o de estabilidad no sean aptos para él. Siga siempre las instrucciones de instalación del fabricante cuando instale y asegure el producto en objetos o estructuras (p. ej. paredes y estantes). Si se realiza la instalación de modo distinto al indicado en la documentación del producto, pueden causarse lesiones o incluso la muerte.
3. No ponga el producto sobre aparatos que generen calor (p. ej. radiadores o calefactores). La temperatura ambiente no debe superar la temperatura máxima especificada en la documentación del producto o en la hoja de datos. En caso de sobrecalentamiento del producto, pueden producirse choques eléctricos, incendios y/o lesiones graves con posible consecuencia de muerte.

Seguridad eléctrica

Si no se siguen (o se siguen de modo insuficiente) las indicaciones del fabricante en cuanto a seguridad eléctrica, pueden producirse choques eléctricos, incendios y/o lesiones graves con posible consecuencia de muerte.

1. Antes de la puesta en marcha del producto se deberá comprobar siempre que la tensión preseleccionada en el producto coincida con la de la red de alimentación eléctrica. Si es necesario modificar el ajuste de tensión, también se deberán cambiar en caso dado los fusibles correspondientes del producto.
2. Los productos de la clase de protección I con alimentación móvil y enchufe individual solamente podrán enchufarse a tomas de corriente con contacto de seguridad y con conductor de protección conectado.
3. Queda prohibida la interrupción intencionada del conductor de protección, tanto en la toma de corriente como en el mismo producto. La interrupción puede tener como consecuencia el riesgo de que el producto sea fuente de choques eléctricos. Si se utilizan cables alargadores o regletas de enchufe, deberá garantizarse la realización de un examen regular de los mismos en cuanto a su estado técnico de seguridad.
4. Si el producto no está equipado con un interruptor para desconectarlo de la red, se deberá considerar el enchufe del cable de conexión como interruptor. En estos casos se deberá asegurar que el enchufe siempre sea de fácil acceso (de acuerdo con la longitud del cable de conexión, aproximadamente 2 m). Los interruptores de función o electrónicos no son aptos para el corte de la red eléctrica. Si los productos sin interruptor están integrados en bastidores o instalaciones, se deberá colocar el interruptor en el nivel de la instalación.
5. No utilice nunca el producto si está dañado el cable de conexión a red. Compruebe regularmente el correcto estado de los cables de conexión a red. Asegúrese, mediante las medidas de protección y de instalación adecuadas, de que el cable de conexión a red no pueda ser dañado o de que nadie pueda ser dañado por él, p. ej. al tropezar o por un choque eléctrico.
6. Solamente está permitido el funcionamiento en redes de alimentación TN/TT aseguradas con fusibles de 16 A como máximo (utilización de fusibles de mayor amperaje solo previa consulta con el grupo de empresas Rohde & Schwarz).
7. Nunca conecte el enchufe en tomas de corriente sucias o llenas de polvo. Introduzca el enchufe por completo y fuertemente en la toma de corriente. La no observación de estas medidas puede provocar chispas, fuego y/o lesiones.
8. No sobrecargue las tomas de corriente, los cables alargadores o las regletas de enchufe ya que esto podría causar fuego o choques eléctricos.
9. En las mediciones en circuitos de corriente con una tensión $U_{\text{eff}} > 30 \text{ V}$ se deberán tomar las medidas apropiadas para impedir cualquier peligro (p. ej. medios de medición adecuados, seguros, limitación de tensión, corte protector, aislamiento etc.).
10. Para la conexión con dispositivos informáticos como un PC o un ordenador industrial, debe comprobarse que éstos cumplan los estándares IEC60950-1/EN60950-1 o IEC61010-1/EN 61010-1 válidos en cada caso.
11. A menos que esté permitido expresamente, no retire nunca la tapa ni componentes de la carcasa mientras el producto esté en servicio. Esto pone a descubierto los cables y componentes eléctricos y puede causar lesiones, fuego o daños en el producto.

Informaciones elementales de seguridad

12. Si un producto se instala en un lugar fijo, se deberá primero conectar el conductor de protección fijo con el conductor de protección del producto antes de hacer cualquier otra conexión. La instalación y la conexión deberán ser efectuadas por un electricista especializado.
13. En el caso de dispositivos fijos que no estén provistos de fusibles, interruptor automático ni otros mecanismos de seguridad similares, el circuito de alimentación debe estar protegido de modo que todas las personas que puedan acceder al producto, así como el producto mismo, estén a salvo de posibles daños.
14. Todo producto debe estar protegido contra sobretensión (debida p. ej. a una caída del rayo) mediante los correspondientes sistemas de protección. Si no, el personal que lo utilice quedará expuesto al peligro de choque eléctrico.
15. No debe introducirse en los orificios de la caja del aparato ningún objeto que no esté destinado a ello. Esto puede producir cortocircuitos en el producto y/o puede causar choques eléctricos, fuego o lesiones.
16. Salvo indicación contraria, los productos no están impermeabilizados (ver también el capítulo "Estados operativos y posiciones de funcionamiento", punto 1). Por eso es necesario tomar las medidas necesarias para evitar la entrada de líquidos. En caso contrario, existe peligro de choque eléctrico para el usuario o de daños en el producto, que también pueden redundar en peligro para las personas.
17. No utilice el producto en condiciones en las que pueda producirse o ya se hayan producido condensaciones sobre el producto o en el interior de éste, como p. ej. al desplazarlo de un lugar frío a otro caliente. La entrada de agua aumenta el riesgo de choque eléctrico.
18. Antes de la limpieza, desconecte por completo el producto de la alimentación de tensión (p. ej. red de alimentación o batería). Realice la limpieza de los aparatos con un paño suave, que no se deshilache. No utilice bajo ningún concepto productos de limpieza químicos como alcohol, acetona o diluyentes para lacas nitrocelulósicas.

Funcionamiento

1. El uso del producto requiere instrucciones especiales y una alta concentración durante el manejo. Debe asegurarse que las personas que manejen el producto estén a la altura de los requerimientos necesarios en cuanto a aptitudes físicas, psíquicas y emocionales, ya que de otra manera no se pueden excluir lesiones o daños de objetos. El empresario u operador es responsable de seleccionar el personal usuario apto para el manejo del producto.
2. Antes de desplazar o transportar el producto, lea y tenga en cuenta el capítulo "Transporte".
3. Como con todo producto de fabricación industrial no puede quedar excluida en general la posibilidad de que se produzcan alergias provocadas por algunos materiales empleados, los llamados alérgenos (p. ej. el níquel). Si durante el manejo de productos Rohde & Schwarz se producen reacciones alérgicas, como p. ej. irritaciones cutáneas, estornudos continuos, enrojecimiento de la conjuntiva o dificultades respiratorias, debe avisarse inmediatamente a un médico para investigar las causas y evitar cualquier molestia o daño a la salud.
4. Antes de la manipulación mecánica y/o térmica o el desmontaje del producto, debe tenerse en cuenta imprescindiblemente el capítulo "Eliminación", punto 1.

5. Ciertos productos, como p. ej. las instalaciones de radiocomunicación RF, pueden a causa de su función natural, emitir una radiación electromagnética aumentada. Deben tomarse todas las medidas necesarias para la protección de las mujeres embarazadas. También las personas con marcapasos pueden correr peligro a causa de la radiación electromagnética. El empresario/operador tiene la obligación de evaluar y señalar las áreas de trabajo en las que exista un riesgo elevado de exposición a radiaciones.
6. Tenga en cuenta que en caso de incendio pueden desprenderse del producto sustancias tóxicas (gases, líquidos etc.) que pueden generar daños a la salud. Por eso, en caso de incendio deben usarse medidas adecuadas, como p. ej. máscaras antigás e indumentaria de protección.
7. En caso de que un producto Rohde & Schwarz contenga un producto láser (p. ej. un lector de CD/DVD), no debe usarse ninguna otra configuración o función aparte de las descritas en la documentación del producto, a fin de evitar lesiones (p. ej. debidas a irradiación láser).

Reparación y mantenimiento

1. El producto solamente debe ser abierto por personal especializado con autorización para ello. Antes de manipular el producto o abrirlo, es obligatorio desconectarlo de la tensión de alimentación, para evitar toda posibilidad de choque eléctrico.
2. El ajuste, el cambio de partes, el mantenimiento y la reparación deberán ser efectuadas solamente por electricistas autorizados por Rohde & Schwarz. Si se reponen partes con importancia para los aspectos de seguridad (p. ej. el enchufe, los transformadores o los fusibles), solamente podrán ser sustituidos por partes originales. Después de cada cambio de partes relevantes para la seguridad deberá realizarse un control de seguridad (control a primera vista, control del conductor de protección, medición de resistencia de aislamiento, medición de la corriente de fuga, control de funcionamiento). Con esto queda garantizada la seguridad del producto.

Baterías y acumuladores o celdas

Si no se siguen (o se siguen de modo insuficiente) las indicaciones en cuanto a las baterías y acumuladores o celdas, pueden producirse explosiones, incendios y/o lesiones graves con posible consecuencia de muerte. El manejo de baterías y acumuladores con electrolitos alcalinos (p. ej. celdas de litio) debe seguir el estándar EN 62133.

1. No deben desmontarse, abrirse ni triturarse las celdas.
2. Las celdas o baterías no deben someterse a calor ni fuego. Debe evitarse el almacenamiento a la luz directa del sol. Las celdas y baterías deben mantenerse limpias y secas. Limpiar las conexiones sucias con un paño seco y limpio.
3. Las celdas o baterías no deben cortocircuitarse. Es peligroso almacenar las celdas o baterías en estuches o cajones en cuyo interior puedan cortocircuitarse por contacto recíproco o por contacto con otros materiales conductores. No deben extraerse las celdas o baterías de sus embalajes originales hasta el momento en que vayan a utilizarse.
4. Mantener baterías y celdas fuera del alcance de los niños. En caso de ingestión de una celda o batería, avisar inmediatamente a un médico.
5. Las celdas o baterías no deben someterse a impactos mecánicos fuertes indebidos.

Informaciones elementales de seguridad

6. En caso de falta de estanqueidad de una celda, el líquido vertido no debe entrar en contacto con la piel ni los ojos. Si se produce contacto, lavar con agua abundante la zona afectada y avisar a un médico.
7. En caso de cambio o recarga inadecuados, las celdas o baterías que contienen electrolitos alcalinos (p. ej. las celdas de litio) pueden explotar. Para garantizar la seguridad del producto, las celdas o baterías solo deben ser sustituidas por el tipo Rohde & Schwarz correspondiente (ver lista de recambios).
8. Las baterías y celdas deben reciclarse y no deben tirarse a la basura doméstica. Las baterías o acumuladores que contienen plomo, mercurio o cadmio deben tratarse como residuos especiales. Respete en esta relación las normas nacionales de eliminación y reciclaje.

Transporte

1. El producto puede tener un peso elevado. Por eso es necesario desplazarlo o transportarlo con precaución y, si es necesario, usando un sistema de elevación adecuado (p. ej. una carretilla elevadora), a fin de evitar lesiones en la espalda u otros daños personales.
2. Las asas instaladas en los productos sirven solamente de ayuda para el transporte del producto por personas. Por eso no está permitido utilizar las asas para la sujeción en o sobre medios de transporte como p. ej. grúas, carretillas elevadoras de horquilla, carros etc. Es responsabilidad suya fijar los productos de manera segura a los medios de transporte o elevación. Para evitar daños personales o daños en el producto, siga las instrucciones de seguridad del fabricante del medio de transporte o elevación utilizado.
3. Si se utiliza el producto dentro de un vehículo, recae de manera exclusiva en el conductor la responsabilidad de conducir el vehículo de manera segura y adecuada. El fabricante no asumirá ninguna responsabilidad por accidentes o colisiones. No utilice nunca el producto dentro de un vehículo en movimiento si esto pudiera distraer al conductor. Asegure el producto dentro del vehículo debidamente para evitar, en caso de un accidente, lesiones u otra clase de daños.

Eliminación

1. Si se trabaja de manera mecánica y/o térmica cualquier producto o componente más allá del funcionamiento previsto, pueden liberarse sustancias peligrosas (polveros con contenido de metales pesados como p. ej. plomo, berilio o níquel). Por eso el producto solo debe ser desmontado por personal especializado con formación adecuada. Un desmontaje inadecuado puede ocasionar daños para la salud. Se deben tener en cuenta las directivas nacionales referentes a la eliminación de residuos.
2. En caso de que durante el trato del producto se formen sustancias peligrosas o combustibles que deban tratarse como residuos especiales (p. ej. refrigerantes o aceites de motor con intervalos de cambio definidos), deben tenerse en cuenta las indicaciones de seguridad del fabricante de dichas sustancias y las normas regionales de eliminación de residuos. Tenga en cuenta también en caso necesario las indicaciones de seguridad especiales contenidas en la documentación del producto. La eliminación incorrecta de sustancias peligrosas o combustibles puede causar daños a la salud o daños al medio ambiente.

Kundeninformation zur Batterieverordnung (BattV)

Dieses Gerät enthält eine schadstoffhaltige Batterie. Diese darf nicht mit dem Hausmüll entsorgt werden.

Nach Ende der Lebensdauer darf die Entsorgung nur über eine Rohde&Schwarz-Kundendienststelle oder eine geeignete Sammelstelle erfolgen.

Safety Regulations for Batteries (according to BattV)

This equipment houses a battery containing harmful substances that must not be disposed of as normal household waste.

After its useful life, the battery may only be disposed of at a Rohde & Schwarz service center or at a suitable depot.

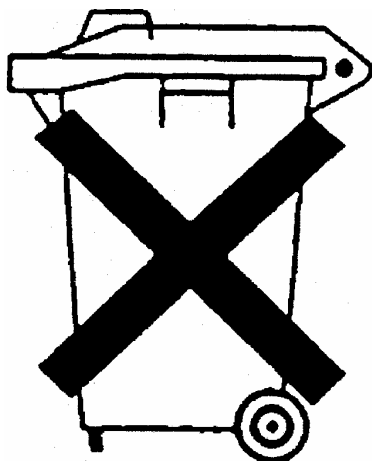

Normas de Seguridad para Baterías (Según BattV)

Este equipo lleva una batería que contiene sustancias perjudiciales, que no se debe desechar en los contenedores de basura domésticos.

Después de la vida útil, la batería sólo se podrá eliminar en un centro de servicio de Rohde & Schwarz o en un depósito apropiado.

Consignes de sécurité pour batteries (selon BattV)

Cet appareil est équipé d'une pile comprenant des substances nocives. Ne jamais la jeter dans une poubelle pour ordures ménagères.

Une pile usagée doit uniquement être éliminée par un centre de service client de Rohde & Schwarz ou peut être collectée pour être traitée spécialement comme déchets dangereux.

Customer Information Regarding Product Disposal

The German Electrical and Electronic Equipment (ElektroG) Act is an implementation of the following EC directives:

- 2002/96/EC on waste electrical and electronic equipment (WEEE) and
- 2002/95/EC on the restriction of the use of certain hazardous substances in electrical and electronic equipment (RoHS).

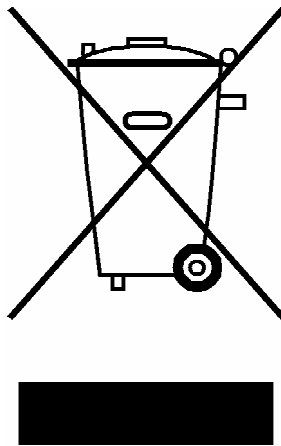

Product labeling in accordance with EN 50419

Once the lifetime of a product has ended, this product must not be disposed of in the standard domestic refuse. Even disposal via the municipal collection points for waste electrical and electronic equipment is not permitted.

Rohde & Schwarz GmbH & Co. KG has developed a disposal concept for the environmental-friendly disposal or recycling of waste material and fully assumes its obligation as a producer to take back and dispose of electrical and electronic waste in accordance with the ElektroG Act.

Please contact your local service representative to dispose of the product.



Qualitätszertifikat

Certificate of quality

Certificat de qualité

Certified Quality System
ISO 9001

Certified Environmental System
ISO 14001

Sehr geehrter Kunde,

Sie haben sich für den Kauf eines Rohde&Schwarz-Produktes entschieden. Hiermit erhalten Sie ein nach modernsten Fertigungsmethoden hergestelltes Produkt. Es wurde nach den Regeln unseres Qualitätsmanagementsystems entwickelt, gefertigt und geprüft. Das Rohde&Schwarz-Qualitätsmanagementsystem ist u.a. nach ISO9001 und ISO14001 zertifiziert.

Der Umwelt verpflichtet

- ▮ Energie-effiziente, RoHS-konforme Produkte
- ▮ Kontinuierliche Weiterentwicklung nachhaltiger Umweltkonzepte
- ▮ ISO 14001-zertifiziertes Umweltmanagementsystem

Dear Customer,

You have decided to buy a Rohde&Schwarz product. You are thus assured of receiving a product that is manufactured using the most modern methods available. This product was developed, manufactured and tested in compliance with our quality management system standards. The Rohde&Schwarz quality management system is certified according to standards such as ISO9001 and ISO14001.

Environmental commitment

- ▮ Energy-efficient products
- ▮ Continuous improvement in environmental sustainability
- ▮ ISO 14001-certified environmental management system

Cher client,

Vous avez choisi d'acheter un produit Rohde&Schwarz. Vous disposez donc d'un produit fabriqué d'après les méthodes les plus avancées. Le développement, la fabrication et les tests respectent nos normes de gestion qualité. Le système de gestion qualité de Rohde&Schwarz a été homologué, entre autres, conformément aux normes ISO9001 et ISO14001.

Engagement écologique

- ▮ Produits à efficience énergétique
- ▮ Amélioration continue de la durabilité environnementale
- ▮ Système de gestion de l'environnement certifié selon ISO 14001



ROHDE & SCHWARZ

CE Declaration of Conformity



Certificate No.: 2010-5

This is to certify that:

Equipment type	Stock No.	Designation
SMA100A	1400.0000.02	SIGNAL GENERATOR

complies with the provisions of the Directive of the Council of the European Union on the approximation of the laws of the Member States

- relating to electrical equipment for use within defined voltage limits (2006/95/EC)
- relating to electromagnetic compatibility (2004/108/EC)

Conformity is proven by compliance with the following standards:

EN 61010-1: 2001
EN 61326-1: 2006
EN 61326-2-1: 2006
EN 55011: 2007 + A2: 2007
EN 61000-3-2: 2006
EN 61000-3-3: 1995 + A1: 2001 + A2: 2005

For the assessment of electromagnetic compatibility, the limits of radio interference for Class B equipment as well as the immunity to interference for operation in industry have been used as a basis.

ROHDE & SCHWARZ GmbH & Co. KG
Mühldorfstr. 15, D-81671 München

Munich, 2009-02-05

Central Quality Management MF-QZ / Radde

CE

E-1

Customer Support

Technical support – where and when you need it

For quick, expert help with any Rohde & Schwarz equipment, contact one of our Customer Support Centers. A team of highly qualified engineers provides telephone support and will work with you to find a solution to your query on any aspect of the operation, programming or applications of Rohde & Schwarz equipment.

Up-to-date information and upgrades

To keep your instrument up-to-date and to be informed about new application notes related to your instrument, please send an e-mail to the Customer Support Center stating your instrument and your wish. We will take care that you will get the right information.

Europe, Africa, Middle East

Phone +49 89 4129 12345
customersupport@rohde-schwarz.com

North America

Phone 1-888-TEST-RSA (1-888-837-8772)
customer.support@rsa.rohde-schwarz.com

Latin America

Phone +1-410-910-7988
customersupport.la@rohde-schwarz.com

Asia/Pacific

Phone +65 65 13 04 88
customersupport.asia@rohde-schwarz.com

China

Phone +86-800-810-8228 /
+86-400-650-5896
customersupport.china@rohde-schwarz.com



Contents

1	Preface	7
1.1	Documentation Overview.....	7
1.2	Typographical Conventions.....	8
2	Preparing for Use	9
2.1	Front Panel Tour.....	9
2.1.1	Utility Keys.....	10
2.1.2	Standby LEDs and Standby Key.....	10
2.1.3	Display.....	10
2.1.4	Setup Keys.....	11
2.1.4.1	Keys for Setting Paramters.....	11
2.1.4.2	Display Keys.....	12
2.1.5	Keypad for data entry.....	12
2.1.6	Rotary Knob and Navigation Keys.....	13
2.1.7	Front Panel Connectors.....	14
2.2	Rear Panel Tour.....	15
2.2.1	Description of the Connectors.....	16
2.3	Putting into Operation.....	19
2.3.1	Unpacking and Checking the Instrument.....	20
2.3.2	Placing or Mounting the Instrument.....	20
2.3.3	Connecting the Instrument to the AC Supply.....	21
2.3.4	Starting the Instrument.....	22
2.3.4.1	Standby and Ready state.....	22
2.3.4.2	Start Display and Booting.....	22
2.3.4.3	Function Check.....	23
2.3.4.4	Default Settings.....	23
2.3.5	Shutting Down the Instrument.....	24
2.3.6	Power Fuses.....	25
2.4	Connecting External Accessories.....	25
2.4.1	Connecting USB Devices.....	25
2.5	Linux Operating System.....	26
2.6	Setting Up a Network (LAN) Connection.....	28

2.6.1	Connecting the Instrument to the Network.....	28
2.6.2	Assigning the IP Address.....	29
2.6.3	Using Computer Names.....	30
2.7	Remote Access via an External Controller.....	31
2.7.1	Using a Web Browser for Remote Access.....	32
2.7.2	Remote Access via Ultr@VNC.....	33
3	Getting Started.....	38
3.1	Brief Introduction to the Instrument's Concept.....	38
3.2	Application Field of the Instrument.....	40
3.3	Description of Individual Diagram Blocks.....	40
3.4	Example of Setup.....	42
4	Manual Operation.....	48
4.1	Key Features.....	48
4.2	Display.....	51
4.2.1	Settings Displayed in the Header Section.....	51
4.2.2	Status Information and Messages.....	52
4.2.2.1	Status Information.....	52
4.2.2.2	Messages.....	52
4.2.2.3	Volatile messages.....	53
4.2.2.4	Permanent Messages.....	53
4.2.3	Info Window.....	53
4.2.4	Block Diagram	54
4.2.4.1	Function Blocks in the Block Diagram.....	54
4.2.4.2	Signal Flow and Input/Output Symbols in the Block Diagram.....	55
4.2.5	Structure of the Dialogs.....	55
4.3	Accessing Dialogs.....	56
4.4	Setting Parameters.....	57
4.4.1	Working with the Cursor.....	58
4.4.2	Selecting a Control Element.....	58
4.4.3	Switching Parameters On/Off.....	59
4.4.4	Entering a Value.....	59
4.4.5	Working with Units	61
4.4.6	Selecting a Value from a List.....	61

4.4.7	Terminating Entries with Confirmation.....	62
4.4.8	Restoring the Previous Value.....	62
4.5	Editors.....	63
4.5.1	Working with List Editor.....	63
4.6	How to Use the Help System.....	65
4.7	File Management.....	66
4.7.1	File Select Dialog.....	67
4.7.2	File Manager.....	68
4.7.2.1	Extensions for User Files.....	69
4.8	Legend of Front-Panel Controls.....	70
4.8.1	Front Panel Key Emulation.....	71
A	Hardware Interfaces.....	73
A.1	GPIB Bus Interface.....	73
A.2	AUX I/O Connector.....	74
	Index.....	76

1 Preface

1.1 Documentation Overview

The user documentation for the R&S SMA consists of the following parts:

- Online Help system on the instrument,
- "Quick Start Guide" printed manual,
- Documentation CD-ROM with:
 - Online help system (*.chm) as a standalone help,
 - Operating Manual,
 - Service Manual,
 - Data sheet and specifications,
 - Links to useful sites on the R&S internet.

Online Help

The Online Help is embedded in the instrument's firmware. It offers quick, context-sensitive access to the complete information needed for operation and programming. The online help contains help on operating the R&S SMA and all available options.

Quick Start Guide

This manual is delivered with the instrument in printed form and in PDF format on the Documentation CD-ROM. It provides the information needed to set up and start working with the instrument. Basic operations and an example of setup are described. The manual includes also general information, e.g., Safety Instructions.

Operating Manual

The Operating Manual is a supplement to the Quick Start Guide. The manual is available in PDF format - in printable form - on the Documentation CD-ROM delivered with the instrument. In the Operating Manual, all instrument functions are described in detail. Furthermore, it provides an introduction to remote control and a complete description of the remote control commands with programming examples. Information on maintenance, instrument interfaces and error messages is also given. The manual can also be orderd in printed form (see ordering information in the data sheet).

Service Manual

This Service Manual is available in PDF format - in printable form - on the Documentation CD-ROM delivered with the instrument. It describes how to check compliance with rated specifications, on instrument function, repair, troubleshooting and fault elimination. It contains all information required for repairing the instrument by the replacement of modules.

This manual can also be orderd in printed form (see ordering information in the data sheet).

Release Notes

The release notes describe new and modified functions, eliminated problems, and last minute changes to the documentation. The corresponding firmware version is indicated on the title page of the release notes. The current release notes are provided in the Internet.

1.2 Typographical Conventions

The following text markers are used throughout this documentation:

Convention	Description
"Graphical user interface elements"	All names of graphical user interface elements on the screen, such as dialog boxes, menus, options, buttons, and softkeys are enclosed by quotation marks.
KEYS	Key names are written in capital letters.
File names, commands, program code	File names, commands, coding samples and screen output are distinguished by their font.
<i>Input</i>	Input to be entered by the user is displayed in italics.
Links	Links that you can click are displayed in blue font.
"References"	References to other parts of the documentation are enclosed by quotation marks.

2 Preparing for Use

The following topics will help you to get familiar with the instrument and perform the first steps:

- [Front Panel Tour](#)
- [Rear Panel Tour](#)
- [Putting into Operation](#)

This section explains the control elements and connectors of the Signal Generator R&S SMA with the aid of the front and rear views and describes how to put the instrument into operation. It also describes the connection of peripherals such as printer, keyboard or mouse. Specifications of interfaces can be found in the data sheet.

The [chapter 3, "Getting Started"](#), on page 38 of this manual provides an overview of the generator functions and introduces the operating concept. Detailed operating instructions and an overview of menus follow in [chapter 4, "Manual Operation"](#), on page 48.

For all reference information concerning manual and remote control of the instrument refer to the online help system or its printed/printable version. A more detailed description of the hardware connectors and interfaces is also part of the help system.

2.1 Front Panel Tour

The front panel of the R&S Signal Generator consists of the VGA display, some utility keys (left side) and the hardkey area with connectors and control interfaces (right side). The subsequent sections provide brief explanations on the controls and connectors, the hardkey area and the front panel.



For more detailed information, refer to the corresponding description in the Operating Manual.

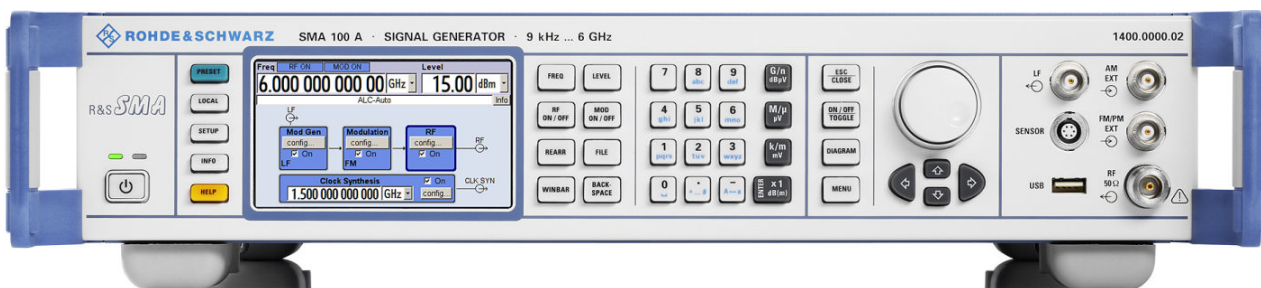

Fig. 2-1: Front panel view

2.1.1 Utility Keys



The keys to the left of the display cause the R&S SMA to return to a definite instrument state and provide information on the instrument and assistance.

For more information refer to chapter "Instrument Settings" in the Operating Manual.

PRESET

Sets the instrument to a defined state (see [chapter 2.3.4.4, "Default Settings"](#), on page 23).

LOCAL

Switches from remote control to local (manual) control.

SETUP

Opens the "Setup" dialog for configuring presettings.

INFO

Displays status messages, error messages and warnings.

HELP

Displays context-sensitive help text.

2.1.2 Standby LEDs and Standby Key

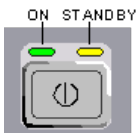

The standby LEDs and the ON/STANDBY key are located in the bottom left corner of the front panel.

The ON/STANDBY key toggles the instrument between standby and ready state (indicated by the standby LEDs).

The standby LEDs indicate the instrument states as follow:

- the green LED (left) is on when the instrument is ready for operation,
- the yellow LED (right) is on in the standby mode.

See also [chapter 2.3.4.1, "Standby and Ready state"](#), on page 22.

2.1.3 Display

The display clearly shows all main settings and signal generator states.

The display is divided into the following sections:

- Frequency and level display with info line
 - Frequency and level settings containing offset.
 - Status messages

- Brief error messages.
To access an window with detailed information for a message, use the INFO key.
- Block diagram
The block diagram shows the current configuration and the signal flow in the generator with the aid of function blocks containing an on/off switch. Selecting a function block opens a list of associated setting menus. Active menus, info windows and graphs are displayed on top of the block diagram. The block diagram can be displayed in the foreground anytime with the **DIAGRAM** key.

For detailed information, see [chapter 4.2, "Display"](#), on page 51.

2.1.4 Setup Keys

The keys to the right of the display set parameters, select views and control the windows.

2.1.4.1 Keys for Setting Paramters



These keys provide direct access to the settings in the header of the instrument and can be used for fast changing the state of the modulation and the RF signal.

For more information refer to chapter "Instrument Functions" in the Operating Manual.

FREQ

Activates frequency entry.

RF ON/OFF

Switches the RF signal on and off.

"RF OFF" is displayed in the header next to the "Frequency" field.

LEVEL

Activates level entry.

MOD ON/OFF

Switches the modulations on and off.

"MOD OFF" is displayed in the info line of the header next to the "Level" field.

REARR

Adjusts the size of the active menu to use the whole hight of the dislay.

FILE

Activates the menu for storing or loading files (see [chapter 4.7, "File Management"](#), on page 66).

WINBAR

Toggles between the active menus.

BACKSPACE

Deletes the character to the left of the cursor.

2.1.4.2 Display Keys

The keys left of the rotary knob arrange different windows on the display.

**ESC**

The function of this key depends on the current cursor position.

- Calls the next higher selection level.
- Closes the open window without accepting new entries; the old value or parameter is retained.
- In dialog boxes that contain a "Cancel" button it activates that button.
- Closes all kinds of dialog boxes, if the edit mode is not active.
- Quits the edit mode, if the edit mode is active.
- Switches between different entry fields of a menu.
- Shifts the entry cursor from the header display to the previously active menu, or to the previously highlighted block in the block diagram if no menu is active.

TOGGLE

- Switches highlighted elements or a function block on and off.
- Switches between two or more settings, e.g. items of selection lists. At the end of a list, the cursor is set on the first entry again.

DIAGRAM

Brings the block diagram to the foreground. Active menus are minimized.

The display of the header section can be enlarged so that it completely covers the display by pressing the DIAGRAM key twice. The frequency, level and status information is indicated in extra large letters.

MENU

Calls the menu tree.

2.1.5 Keypad for data entry

The keys in the data entry keypad are used to enter alphanumeric data and units.

Data entry keys are only enabled while the cursor is placed on a data input field in a dialog. Their function depends on the data type of the input field.



Keys	Description
0...9/abc	Enters the corresponding numbers (in numeric input fields) or characters (character input fields).
.	Inserts a decimal point (numeric input fields) or dot (character input fields) at the cursor position. Multiple decimal points are not allowed.
Unit keys	Selects a unit and thus determine the absolute value, or changes the unit, i.e. trigger a recalculation without changing the absolute value. The function depends on the time at which the UNIT key is used during parameter entry (see chapter 4.4.5, "Working with Units" , on page 61). For unit-free values, the X1 key is equivalent to ENTER. It confirms the previous entry and deactivates the input field.
_	Adds a blank in a character input field.
*... #	Enters special characters. Toggles through the available characters if the key is pressed several times in a row.
A <-> a	Toggles between uppercase and lowercase characters.
A, B, C, D, E, F	Enters hexadecimal values. The letters assigned to the keys are automatically active when an entry field with a hexadecimal value is active.

ENTER

Pressing the rotary knob has the same effect.

- Concludes the entry of dimensionless entries. For other entries, this key can be used instead of the default unit key. The new value is accepted.
- Confirms ("OK") and closes open input windows.
- In a dialog box, selects the default or focused button.
- In a dialog box, activates the edit mode for the focused area, if available.
- In a dialog box, activates or deactivates the selected option of the focused area, if the edit mode is active.
- Calls the next menu level.

2.1.6 Rotary Knob and Navigation Keys

The rotary knob and the arrow keys are alternative control elements for data variation and navigation in the graphical user interface.



ROTARY KNOB

The rotary knob has several functions:

- Increases (clockwise direction) or decreases (counter-clockwise direction) numeric values at a defined step width in editing mode
- Moves the cursor, e.g. to a function block in the block diagram
- Scrolls within lists, tables or tree views
- Acts like the ENTER key, when it is pressed.
- Shifts the selection bar within focused areas (e.g. lists), if the edit mode is activated.

Note: Turning or pressing the rotary knob is equivalent to pressing the UP and DOWN keys or the ENTER key in the keypad.

NAVIGATION KEYS



The navigation keys consist of 4 arrow keys which are used for navigation, alternatively to the rotary knob.

UP/ DOWN
KEYS

The up and down arrow keys do the following:

- In a numeric edit dialog box, increase or decrease the instrument parameter.
- In a list, table, window or dialog box, scroll vertically.

LEFT/ RIGHT
KEYS

The left and right arrow keys do the following:

- In an alphanumeric edit dialog box, move the cursor forward and back.
- In a list, table, window or dialog box, scroll horizontally.

2.1.7 Front Panel Connectors

The RF and LF connectors and various additional interface connectors are located on the front panel.

LF



Output for internal LF modulation generator signal.

See also data sheet and Operating Manual, section "LF Generator and LF Output".



AM EXT

Input for external AM modulation signals.



FM/PM EXT

Input for external FM or PhiM modulation signals (option R&S SMA-B20/-B22).

**RF**

Outputs for RF signal.

NOTICE! Maximum Input Levels. Do not overload the RF output. The maximum permissible back-feed is specified in the data sheet.

USB

USB (universal serial bus) interfaces of type A (host USB).

- Connection of peripherals such as mouse or keyboard
- Connection of memory stick for file transmission
- Firmware update

See also [chapter 2.4.1, "Connecting USB Devices"](#), on page 25.

SENSOR

Connector for R&S NRP-Zxx sensors.

With the aid of the "User Correction" function, a table with correction values for external test assemblies can be automatically determined, e.g. for compensating the frequency response of cables.

The power sensors are connected by inserting the male connector. To disconnect hold the connector by its sleeve. Pulling on the sensor cable will not release the sensor connector.

2.2 Rear Panel Tour

This section gives an overview of connectors on the rear panel of the instrument. Each connector is briefly described and a reference is given to the chapters containing detailed information. For technical data of the connectors refer to the data sheet.



For more detailed information, refer to the corresponding description in the Operating Manual.



Fig. 2-2: Rear panel view

2.2.1 Description of the Connectors

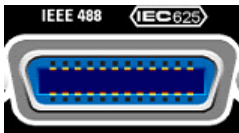

IEC 625/IEEE 488

IEC-bus (IEEE 488) interface for remote control of the instrument.

See also [chapter A.1, "GPIB Bus Interface"](#), on page 73 and chapter "Remote Control Basics" in the Operating Manual.

Note: In order to avoid electromagnetic interference (EMI) caused by open lines, always terminate any connected IEC-bus cable with an instrument or a controller.



INSTR TRIG

Input for external trigger for sweeps, list mode and Fast Hopping Mode.

AUX I/O



Parallel input for FM/PhiM digital data signals as well as control signals for Fast Hopping mode.

NOTICE! Risk of instrument damage. The maximum permissible input voltage is 3.3 V DC.

For detailed description of the AUX I/O connector, refer to [chapter A.2, "AUX I/O Connector"](#), on page 74.



USB IN

USB (universal serial bus) interface of type B (device USB).

This interface can be used for remote control of the instrument.

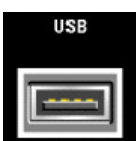

USB CONNECTORS TYPE A

- Connection of peripherals such as mouse, keyboard, etc.
- Connection of memory stick for file transmission
- Firmware update

Further USB interface type A are available on the front panel.

See also [chapter 2.4.1, "Connecting USB Devices"](#), on page 25.



PULSE EXT

Input of external pulse signal or input of external trigger/gate signal for internal pulse generator.



PULSE VIDEO

Output of internal pulse generator signal or external pulse signal fed in via the PULSE EXT connector (video signal).



PULSE SYNC

Output of sync signal for pulse generator signal. The sync signal is generated at the beginning of each pulse. For double-pulse generation, the sync signal is generated at the beginning of the first pulse.



EXT TUNE

Tuning input for the internal reference frequency.



LAN CONNECTOR

Ethernet interface

- For integrating signal generators in a network
- Remote control of signal generator
- Remote access to the signal generator
- Firmware update

See also:

- [chapter 2.6, "Setting Up a Network \(LAN\) Connection"](#), on page 28
- chapter "Remote Control Basics" in the Operating Manual

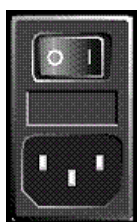

AC SUPPLY AND POWER SWITCH

When the R&S SMA is connected to the AC supply, it automatically sets itself to the correct range for the applied voltage (range: see type label). There is no need to set the voltage manually or change fuses.

The power switch can be set to two positions:

- **0**
The instrument is disconnected from the mains.
- **I**
The instrument is power-supplied. It is either ready for operation (STANDBY) or in operating mode, depending on the position of the ON/STANDBY switch on the instrument front.

See also data sheet and [chapter 2.3.3, "Connecting the Instrument to the AC Supply"](#), on page 21.

CF MEMORY SLOT

Slot for removable CompactFlash™ Card (option R&S SMA-B80).

**REF OUT**

Output of internal reference signal.

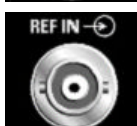
**REF IN**

Input for external reference signal.

**SENSOR**

Rear panel connector for R&S NRP-Zxx power sensors (option R&S SMA-B81).

This option is recommended for use of the instrument in a 19" rack. Installing the instrument in a 19" rack requires a rack adapter (refer to data sheet for Order No.).

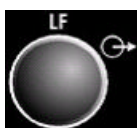
**LF**

Rear panel output for internal LF generator signal (option R&S SMA-B81).

This option is recommended for use of the instrument in a 19" rack. Installing the instrument in a 19" rack requires a rack adapter (refer to data sheet for Order No.).

**FM/PM EXT**

Rear panel input for external FM or PhiM modulation signals (option R&S SMA-B81).

This option is recommended for use of the instrument in a 19" rack. Installing the instrument in a 19" rack requires a rack adapter (refer to data sheet for Order No.).

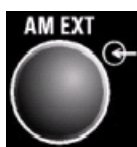
**AM EXT**

Rear panel input for external AM modulation signals (option R&S SMA-B81).

This option is recommended for use of the instrument in a 19" rack. Installing the instrument in a 19" rack requires a rack adapter (refer to data sheet for Order No.).

**RF OUT**

Rear panel output for RF signal (option R&S SMA-B81).

This option is recommended for use of the instrument in a 19" rack. Installing the instrument in a 19" rack requires a rack adapter (refer to data sheet for Order No.).

NOTICE! Maximum Input Levels. Do not overload the RF output. The maximum permissible back-feed is specified in the data sheet.

**CLK SYN**

Output of clock synthesizer (option R&S SMA-B29).

NOTICE! Maximum Input Levels. Do not overload the Clock Synthesizer output. The maximum permissible back-feed is specified in the data sheet.

2.3 Putting into Operation

This section describes the basic steps to be taken when setting up the R&S SMA for the first time.

WARNING

Shock hazard

Do not open the instrument casing. As a rule, normal operation of the instrument does not require opening the casing. Observe the general safety instructions and regulations at the beginning of the manual.

NOTICE

Risk of instrument damage

Note that the general safety instructions also contain information on operating conditions that will prevent damage to the instrument. The instrument's data sheet may contain additional operating conditions.

NOTICE

Risk of instrument damage

Before switching on the instrument, make sure that the following conditions are met:

- Instrument casing is closed and all fasteners are tightened.
- All fan openings are unobstructed and the airflow perforations are unimpeded. The minimum distance from the wall is 10 cm.
- The instrument is dry and shows no sign of condensation.
- The instrument is operated in the horizontal position on an even surface.
- The ambient temperature does not exceed the range specified in the data sheet.
- Signal levels at the input connectors are all within the specified ranges.
- Signal outputs are correctly connected and are not overloaded.

Failure to meet these conditions may cause damage to the instrument or other devices in the test setup.

NOTICE

Risk of electrostatic discharge

Protect the work area against electrostatic discharge to avoid damage to electronic components in the modules. For details, refer to the safety instructions at the beginning of this manual.



EMI impact on measurement results

Electromagnetic interference (EMI) can affect the measurement results. To avoid any impact, make sure that the following conditions are met:

- Use suitable double-shielded cables.
- Do not use USB connecting cables exceeding 1 m in length.
- Use only USB devices that remain within the permissible EMI limits.
- Always terminate any connected IEC-bus cables with an instrument or controller.

Outputs and lines have to be terminated properly with 50 Ohms.

For digital interfaces only the cable R&S SMA-Z6 is permitted for connection. The associated cable is available under part number 1415.0201.02.

2.3.1 Unpacking and Checking the Instrument

To remove the instrument from its packaging and check the equipment for completeness proceed as follows:

1. Pull off the polyethylene protection pads from the instrument's rear feet and then carefully remove the pads from the instrument handles at the front.
2. Pull off the corrugated cardboard cover that protects the rear of the instrument.
3. Carefully unthread the corrugated cardboard cover at the front that protects the instrument handles and remove it.
4. Check the equipment for completeness using the delivery note and the accessory lists for the various items.
5. Check the instrument for any damage. If there is damage, immediately contact the carrier who delivered the instrument. Make sure not to discard the box and packing material.



Packing material

Retain the original packing material. If the instrument needs to be transported or shipped at a later date, you can use the material to prevent control elements and connectors from being damaged.

2.3.2 Placing or Mounting the Instrument

The R&S SMA is designed for use under laboratory conditions, either on a bench top or in a rack using a rack adapter kit (order number see data sheet).

Bench Top Operation

If the R&S SMA is operated on a bench top, the surface should be flat. The instrument can be used in horizontal position, standing on its feet, or with the support feet on the bottom extended.

CAUTION

Risk of injury

The feet may fold in if they are not folded out completely or if the instrument is shifted. Fold the feet completely in or completely out to ensure stability of the instrument and personal safety. To avoid injuries, never shift the instrument when its feet are folded out. When the instrument is standing on its folded-out feet, do not work under the instrument and do not put anything under it, otherwise injuries or material damage could occur. The feet may break if they are overloaded. The overall load on the folded-out feet must not exceed 500 N.

Rackmounting

The R&S SMA can be installed in a rack using a rack adapter kit (Order No. see data sheet). The installation instructions are part of the adapter kit.

NOTICE

Risk of instrument damage

For rack installation, make sure that all fan openings are unobstructed and that the airflow perforations are unimpeded. This helps to prevent the instrument from overheating.

2.3.3 Connecting the Instrument to the AC Supply

The R&S SMA is automatically adapted to the AC voltage supplied. There is no need to set the voltage manually or change fuses. The [AC SUPPLY AND POWER SWITCH](#) is at the rear of the unit.

- ▶ Connect the instrument to the AC power source using the AC power cable delivered with the instrument.

Note: The instrument is in compliance with safety class EN61010-1. Connect the instrument only to a socket with earthing contact.

2.3.4 Starting the Instrument



Switching off the AC power

You can leave the AC power on permanently to preserve your last instrument settings. Switching off is required only if the instrument must be completely disconnected from all power supplies.

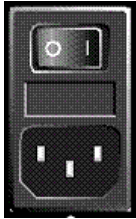

Starting up instruments with power switch

1. [Connect the instrument to the AC supply.](#)
2. To turn the power on, press the main power switch to position I (On).
After power-up, the instrument is in [standby or ready state](#), depending on the state of the ON/STANDBY key at the front panel of the instrument when the instrument was switched off for the last time.
3. In case the instrument is in standby mode, i.e. the yellow LED is on, press the ON/STANDBY key to switch the instrument to ready state.

2.3.4.1 Standby and Ready state

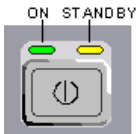

The ON/STANDBY key is located in the bottom left corner of the front panel.

Switching between standby and ready state

- ▶ Press the ON/STANDBY key briefly to switch the instrument from the standby to ready state or vice versa.

In ready state, the left, green LED is on. The instrument is ready for operation. All modules are power-supplied and the R&S SMA initiates its [startup procedure](#).

In standby state, the right, yellow LED is on. The standby power only supplies the power switch circuits and the oven-controlled crystal oscillator to keep it at its operating temperature. In this state it is safe to switch off the AC power and disconnect the instrument from the power supply.

2.3.4.2 Start Display and Booting

The instrument boots the operating system, starts the instrument firmware and automatically performs a selftest. If the previous session was terminated regularly, the instrument uses the last setup with the relevant instrument settings.

Once the startup procedure has been terminated, the block diagram opened in the previous session is displayed and the instrument is ready for operation.



Use the PRESET key to return the instrument to its definite reset/preset state, if the current setup is not anymore relevant.

To customize the start settings, use the "File" dialog.



Rebooting the instrument

Press the STANDBY key for approx. 5 s. to reboot the instrument, if the software stops unexpectedly.

2.3.4.3 Function Check

The signal generator automatically monitors the main functions when the instrument is switched on and continuously during operation.

A detected fault is indicated by a "ERROR" message displayed in the info line together with a brief error description. For in-depth identification of the error, press the INFO key. In response, a description of the error(s) is displayed.

For more information, refer to section "Error Messages" in the Operating Manual.

Additionally to the automatic monitoring, the R&S SMA offers the following capabilities to ensure correct functioning:

- **Internal Adjustments**
Press the SETUP key and select "System > Internal Adjustments" to access the dialog for performing and configuring of the adjustments settings. A maximum level accuracy can be obtained, for instance.
- **Selftest**
A selftest is provided for service purposes. The selftest is a protected test procedure, which can be accessed if protection level 1 is disabled.

2.3.4.4 Default Settings

When the instrument is switched on, it is not the preset state that is active, but rather the instrument state that was set before the instrument was switched off. It is also recommended that you use the PRESET key to return the instrument to its defined preset state every time a new configuration is required or the current setup is not anymore relevant.

The R&S SMA offers a two-stage preset concept:

- **Preset the instrument to a predefined state**
The PRESET key calls up a defined instrument setup. All parameters and switching states are preset (also those of inactive operating modes). The default instrument settings provide a reproducible initial basis for all other settings. However, functions that concern the integration of the instrument into a measurement setup are not changed, e.g. GPIB bus address or reference oscillator source settings.
- **Preset the instrument to its factory settings**
The instrument can also be forced to load its default factory settings. To access the corresponding dialog box, press the SETUP key and select the "Factory Preset". For more information and an overview of the settings affected by the factory preset function, see section "Factory Preset" in the Operating Manual.

Overview of the Most Important Preset States

The following list gives an overview of the presets for the most important generator settings. The other presets can be found in the preset tables of the individual menus and the information accompanying the remote commands.

- "RF frequency" = 1 GHz
- "RF level" RF output switched off
- "Offsets" = 0
- "Modulations State" = Off
- Uninterrupted level settings are switched off
"Level Attenuator Mode" = AUTO
- Internal level control "Level ALC" = AUTO
- User correction "Level Ucor" = OFF
- "LF output State" = Off
- "Sweep State" = Off
- "List mode State" = Off

Settings that are not affected by the PRESET key

- Reference frequency settings ("Ref Oscillator" menu)
- Power on settings ("Level/EMF" menu)
- Network settings ("Setup" menu)
- GPIB address ("Setup" menu)
- *IDN? Identification and emulation ("Setup" menu)
- Password and settings protected by passwords ("Setup" menu)
- Start/Stop Gui Update ("Setup" menu)
- Display and keyboard settings ("Setup" menu)



User-defined instrument states can be stored and called up in the "File" dialog.

2.3.5 Shutting Down the Instrument

To shut down the R&S SMA, proceed as described below.

NOTICE**Risk of losing data**

If you switch off the running instrument using the rear panel switch or by disconnecting the power cord, the instrument loses its current settings. Furthermore, program data may be lost.

Press the ON/STANDBY key first to shut down the application properly.

1. Press the ON/STANDBY key to save the current setup, shut down the operating system and set the instrument to standby state.
The yellow LED must be on.
2. To switch off the power, press the main power switch to position 0 (Off).
None of the front-panel LEDs should be on.

2.3.6 Power Fuses

The R&S SMA is fully fused by two fuses IEC60127-T3.15H/250 V.

The fuses are accommodated in the fuse holders next to the power connector. Use only fuses of the mentioned type.

WARNING**Shock hazard**

Before replacing a fuse, make sure that the instrument is switched off and disconnected from all power supplies.

Always use fuses supplied by Rohde & Schwarz as spare parts, or fuses of the same type and rating.

2.4 Connecting External Accessories

The equivalent USB ports on the front and/or rear panel of the R&S SMA can be used to connect a variety of accessories.

In addition the instrument provides interfaces for network integration (see [chapter 2.6, "Setting Up a Network \(LAN\) Connection"](#), on page 28).

2.4.1 Connecting USB Devices

The USB interfaces on the front and (optionally) rear panels of the R&S SMA allow you to connect USB devices directly to the instrument. This number can be increased as

necessary by using USB hubs. Due to the large number of available USB devices, there is almost no limit to the expansions that are possible with the R&S SMA.

The following list shows various USB devices that can be useful:

- Memory stick for easy transfer of data to/from a computer (e.g. firmware updates)
- CD-ROM drives for easy installation of firmware applications
- Keyboard or mouse to simplify the entry of data, comments, file names, etc.
- Power sensors, e.g. of the NRP Zxy family

Installing USB devices is easy under Linux, because all USB devices are plug&play. After a device is connected to the USB interface, the operating system automatically searches for a suitable device driver.

If Linux does not find a suitable driver, it will prompt you to specify a directory that contains the driver software. If the driver software is on a CD, connect a USB CD-ROM drive to the instrument before proceeding.

When a USB device is subsequently disconnected from the R&S SMA, the operating system immediately detects the change in hardware configuration and deactivates the corresponding driver.

All USB devices can be connected to or disconnected from the instrument during operation.

Connecting a memory stick or CD-ROM drive

If installation of a memory stick or CD-ROM drive is successful, the operating system informs you that the device is ready to use. The device is made available as a new drive (`/usb`). The name of the drive is manufacturer-dependent.

Connecting a keyboard

The keyboard is detected automatically when it is connected. The default keyboard layout is English – US.

Use the "Setup > Keyboard Settings" dialog to configure the keyboard properties.

Connecting a mouse

The mouse is detected automatically when it is connected.

2.5 Linux Operating System

The instrument contains the Linux operating system. To ensure that the instrument software functions properly, certain rules must be adhered to concerning the operating system.

NOTICE**Risk of causing instrument unusability**

The instrument is equipped with the Linux operating system. Additional software can therefore be installed on the instrument. The use and installation of additional software may impair instrument function. Thus, run only programs that Rohde & Schwarz has tested for compatibility with the instrument software.

The drivers and programs used on the instrument under Linux have been adapted to the instrument. Existing instrument software must always be modified using only update software released by Rohde & Schwarz.

The configuration of the operating system is optimally adapted to signal generator functions in the factory. Changes in the system setup are only required when peripherals like keyboard are installed or if the network configuration does not comply with the default settings (see [chapter 2.6.1, "Connecting the Instrument to the Network"](#), on page 28). After the R&S SMA is started, the operating system boots and the instrument firmware is started automatically.

**Accessing Operating System**

The operating system cannot be accessed.

All necessary system settings can be made in the "Setup" dialog.

The R&S SMA provides a internal CompactFlash™ Card, it does not contain a disk drive. The CompactFlash™ Card holds the firmware and the stored data. However, data transfer is only possible via a memory stick connected to a USB interface. The memory stick and the CompactFlash™ Card are accessed via the "File Manager".

Accessing the File System

The instrument also supports two standard methods to access the file system form a remote client:

- FTP (file transfer protocol)
- File sharing according to the SAMBA/SMB (server message block) protocol.

Both methods allow the access to the folder `/var/user/share`.

**Default password**

The FTP and SAMBA file access use the user "instrument" with default password "instrument".

It is highly recommended to change this password in the "Setup > Security > Change User Password" dialog before connecting the instrument to the network!

Screen saver

A screen saver can be activated in the R&S SMA. When active, the display is shut off when no entries via front panel, external mouse or external keyboard are made for a period of time. The screen saver prolongs the life time of the display.

Use the "Setup > Display Settings" dialog to switch on or off the screen saver and to adjust the screen saver settings.

2.6 Setting Up a Network (LAN) Connection

The R&S SMA is equipped with a network interface and can be connected to an Ethernet LAN (local area network). Provided the appropriate rights have been assigned by the network administrator and the Linux firewall configuration is adapted accordingly, the interface can be used, for example:

- To transfer data between a controller and the tester, e.g. in order to run a remote control program.
- To access or control the measurement from a remote computer using the "Remote Desktop" application, the Ultr@VNC program (or a similar tool)
- To connect external network devices (e.g. printers)
- To transfer data from a remote computer and back, e.g. using network folders

This section describes how to configure the LAN interface. It includes the following topics:

- [chapter 2.6.1, "Connecting the Instrument to the Network"](#), on page 28
- [chapter 2.6.2, "Assigning the IP Address"](#), on page 29



Accessing Operating System

The operating system cannot be accessed.

All necessary system settings can be made in the "Setup" dialog.

2.6.1 Connecting the Instrument to the Network

There are two methods to establish a LAN connection to the instrument:

- A non-dedicated network (Ethernet) connection from the instrument to an existing network made with an ordinary RJ-45 network cable. The instrument is assigned an IP address and can coexist with a computer and with other hosts on the same network.
- A dedicated network connection (Point-to-point connection) between the instrument and a single computer made with a (crossover) RJ-45 network cable. The computer must be equipped with a network adapter and is directly connected to the instrument. The use of hubs, switches, or gateways is not required, however, data transfer is still performed using the TCP/IP protocol.

In both cases, an IP address has to be assigned to the instrument and the computer, see [chapter 2.6.2, "Assigning the IP Address"](#), on page 29.

The R&S SMA uses the IP addresses 192.168.xxx.yyy for this purposes, where xxx and yyy may take values between 1...254; the subnet mask is always 255.255.255.0.

NOTICE**Risk of network failure**

Before connecting the instrument to the network or configuring the network, consult your network administrator. Errors may affect the entire network.

- ▶ To establish a non-dedicated network connection, connect a commercial RJ-45 cable to one of the LAN ports.
To establish a dedicated connection, connect a (crossover) RJ-45 cable between the instrument and a single PC.

If the instrument is connected to the LAN, the operating system automatically detects the network connection and activates the required drivers.

The network card can be operated with a 10 Mbps Ethernet IEEE 802.3 or a 100 Mbps Ethernet IEEE 802.3u interface.

2.6.2 Assigning the IP Address

Depending on the network capacities, the TCP/IP address information for the instrument can be obtained in different ways.

- If the network supports dynamic TCP/IP configuration using the Dynamic Host Configuration Protocol (DHCP), all address information can be assigned automatically.
- If the network does not support DHCP, the instrument tries to obtain the IP address via Zeroconf (APIA) protocol. If this attempt does not succeed or if the instrument is set to use alternate TCP/IP configuration, the addresses must be set manually.

By default, the instrument is configured to use dynamic TCP/IP configuration and obtain all address information automatically. This means that it is safe to establish a physical connection to the LAN without any previous instrument configuration.

NOTICE**Risk of network errors**

Connection errors can affect the entire network. If your network does not support DHCP, or if you choose to disable dynamic TCP/IP configuration, you must assign valid address information before connecting the instrument to the LAN. Contact your network administrator to obtain a valid IP address.

Assigning the IP address on the instrument

1. Press the SETUP key and select the "Network Settings" dialog.
2. Set the "Address Mode" to Static.

3. Select the "IP Address" and enter the IP address, for example *192.168.0.1*.. The IP address consists of four number blocks separated by dots. Every block contains 3 numbers in maximum.
4. Select the "Subnet Mask" and enter the subnet mask, for example *255.255.255.0*. The subnet mask consists of four number blocks separated by dots. Every block contains 3 numbers in maximum.

Assigning the IP address manually on a PC

1. Obtain the IP address and subnet mask for the R&S SMA and the IP address for the local default gateway from your network administrator. If necessary, also obtain the name of your DNS domain and the IP addresses of the DNS and WINS servers on your network. If you use more than one LAN connector, you need separate address information for each connector.
2. Press the "Windows" key to access the operating system.
3. Open the "Control Panel" by selecting "Start > Settings > Control Panel".
4. Select "Network Connections".
5. Right-click "Local Area Connection" and select "Properties" from the context-sensitive menu, or click "Local Area Connection" and then "File > Properties".
6. On the "General" tab, click "Internet Protocol (TCP/IP)" and then select "Properties".
7. Select "Use the following IP address" and enter the address information as obtained from the network administrator.
8. If necessary, you can also select "Use the following DNS server addresses" and enter your own DNS addresses.

For more information refer to the Windows XP Help.

2.6.3 Using Computer Names

Alternatively to the IP address, each PC or instrument connected in a LAN can be accessed via an unambiguous computer name. Each instrument is delivered with an assigned computer name, but this name can be changed.

Querying and changing a computer name

1. Press the "Setup" key and select "Network Settings".
The computer name is displayed under "Hostname".
2. Press the "Setup" key, select "Protection" and enable the "Protection Level 1".
The parameter "Hostname" in the "Network Settings" dialog is now enabled for configuration.

3. Change the "Hostname".

2.7 Remote Access via an External Controller

The R&S SMA can be remote accessed from a remote computer (external controller) via a network link. This allows convenient operation of the instrument from the desktop although the instrument is integrated in a rack somewhere else.



For an overview of the instrument's operating concept and the different ways to control and operate the instrument, see [chapter 3.1, "Brief Introduction to the Instrument's Concept"](#), on page 38.

There are different ways to establish a remote access connection to the signal generator but all of them require an established LAN connection between the instrument and the remote computer. The simplest way to remote access the instrument is to use a Web browser, such as Windows Internet Explorer or Mozilla Firefox for instance. Alternatively a remote access via a special application can be used.

The free-of-charge program Ultr@VNC for PCs with Linux/Unix or Windows operating system is available for setting up the remote access connection. Using this application requires additional installation.

See the following table for an overview of the different ways to establish a remote access connection to the signal generator.

Table 2-1: Remote access via an external computer

Remote access via	LAN connection	Installation of the additional application	
		on the instrument	on the remote computer
Web Browser e.g. Windows Internet Explorer or Mozilla Firefox see chapter 2.7.1, "Using a Web Browser for Remote Access" , on page 32	required	no	no
Ultr@VNC for PCs with Linux/Unix or Windows operating system see chapter 2.7.2, "Remote Access via Ultr@VNC" , on page 33	required	required	VNC Viewer required

When the connection is set up with Ultr@VNC, direct control on the instrument is possible while remote access is established.

For return to direct operation on the instrument, the connection must be cut. After cutting the connection, it is still enabled and can be established again any time. The connection is disabled only after deactivation of the program.

This section gives an information on how to use the Web browser for remote access, how to install the applications for remote access and how to establish the connection between

the instrument and an external computer with Windows operating system. Remote access via an external computer with Linux/Unix operating system is performed accordingly.



Default password

Remote-access and file access require the user "instrument" with default password "instrument".

NOTICE

Changing the default user and security passwords

It is highly recommended to change the default user and security passwords in the menu "Setup > Security" before connecting the instrument to the network (see section "Security - Setup-Protection" in chapter "General Instrument Settings" of the Operating Manual).

2.7.1 Using a Web Browser for Remote Access

The instrument can be remote-accessed via any Web browser, like Windows Internet Explorer or Mozilla Firefox for instance.

To remote access the instrument via Web browser:

1. Connect the instrument and the remote computer to a LAN, see [chapter 2.6.1, "Connecting the Instrument to the Network"](#), on page 28.
2. Instal the Java Runtime Environment JRE on the remote computer.
3. Type the instruments' IP address in the address field of the Web browser on your PC, e.g. `http://10.111.11.1`

The "VNC Authentication" screen appears.

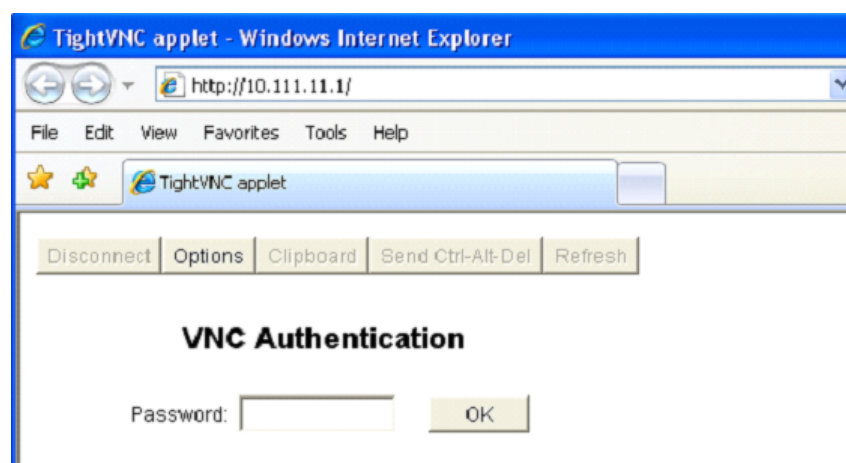

4. Enter the password and select "OK".

The default password is "instrument".

After the connection is established, the current signal generator screen with the block diagram is displayed and the instrument can be remote-accessed from the remote computer.

2.7.2 Remote Access via Ultr@VNC

Ultr@VNC is an application which can be used to access and control the instrument from a remote computer through a LAN connection. The program is included in operating system Linux/Unix. It is available as a free-of-charge download on the internet for operating system Window XP (<http://www.uvnc.com/download/index.html>) and on the instrument's CD-ROM.

NOTICE

Risk of Unauthorized Access

If the VNC application is enabled on the instrument, any user in the network who knows the computer name and login data can access it. To prevent this, make sure that the VNC server service on the instrument is disabled.

Setting up a VNC connection

1. Connect the instrument and the remote computer to a LAN, see [chapter 2.6.1, "Connecting the Instrument to the Network"](#), on page 28.
2. [Install the Ultr@VNC application](#) and enable it on the instrument.
3. In the ICF firewall, enable communication on the network via Ultr@VNC program.
4. Install the VNC Viewer on the remote computer with Windows operating system, see ["Installing the VNC Viewer on a Windows PC"](#) on page 35.
5. Set up the VNC connection between the instrument and:
 - a) the remote computer with Linux/Unix operating system, see ["Setting up the VNC connection on the Linux/Unix remote computer"](#) on page 35;
 - b) the remote computer with Windows operating system, see ["Setting up the VNC connection on the Windows remote computer"](#) on page 36.



Enabled Direct Control

The direct control of the instrument is not disabled and the instrument can be controlled from the front panel and via the remote computer alternately.

Installing the Ultr@VNC application

1. Download the program from the internet and copy it to a directory that can be accessed.
2. On the instrument, shut down firmware using the ALT+F4 key combination.

3. Double click on the setup file to start the installation.
The setup wizard leads through the installation. This description focus only on the relevant settings.
 - a) Select installation of all components.

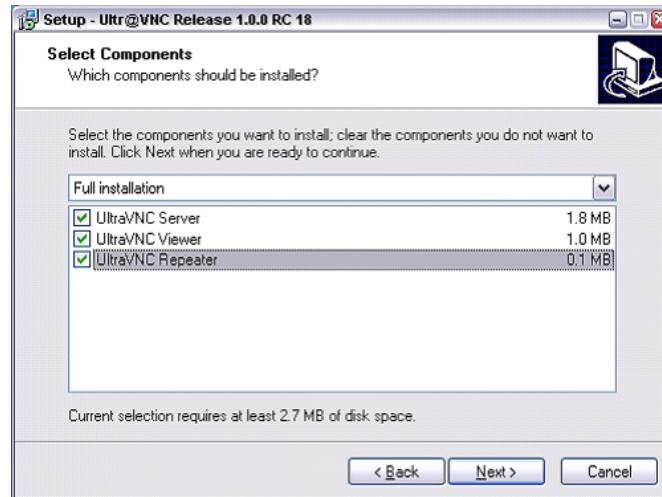

- b) In the "Additional Task Panel", enable all entries.

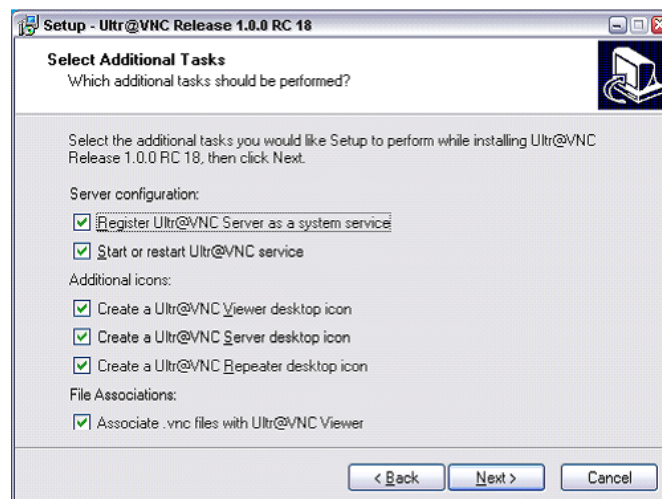

A successful installation is indicated by a message.

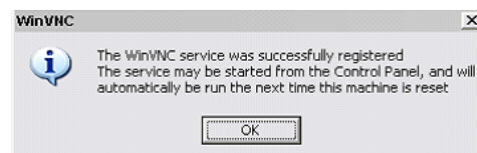

At the same time a warning is displayed stating that a password must be set.

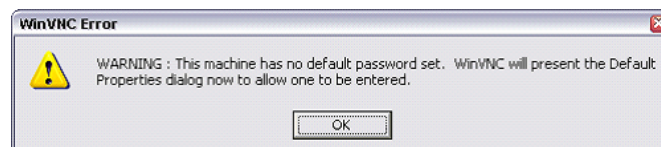

4. Select "OK".

The "Default Local System Properties" panel opens.

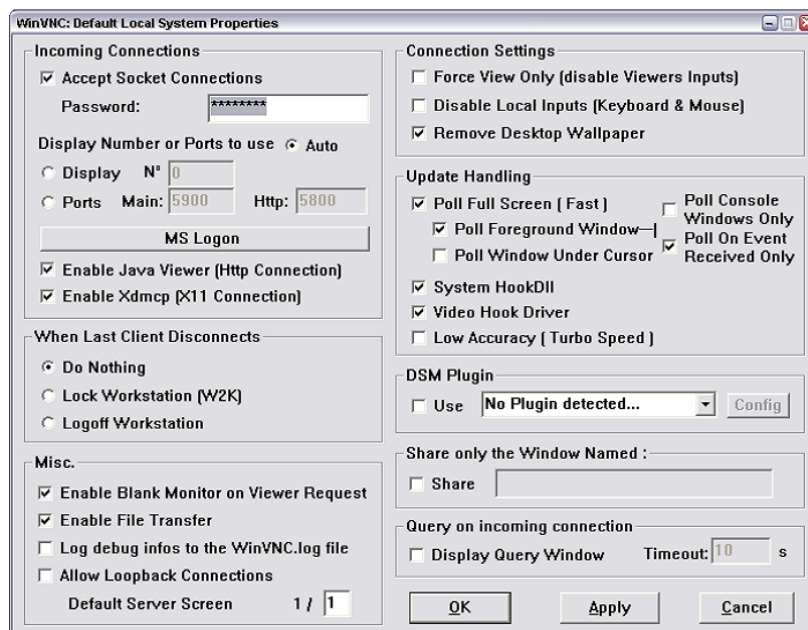

5. Enter a password with a length of at least five digits.
This password is used on the remote computer to access the instrument. Other settings may be changed according to the user-specific security requirements.

After the installation the Ultr@VNC program is automatically started together with the operating system. On mouse over, the IP address of the instrument is indicated. This IP address and the user-defined password are the prerequisites to enable remote access on the remote computer. Terminated connection is indicated by changed icon color.

Installing the VNC Viewer on a Windows PC

1. Download the Ultr@VNC program from internet and follow the installation instructions.
Only the program component VNC Viewer is required.

Note: The VNC Viewer program is included in the download for the installation of the Ultr@VNC program on the signal generator if "Full installation" was selected in the "Select Component" panel. In this case, the program `ultr@vncviewer.exe` can be copied to the Windows PC.

2. Install VNC Viewer program component on the remote computer.

Setting up the VNC connection on the Linux/Unix remote computer

The VNC program is available per default for Linux/Unix operating systems.

1. Start a Web browser on the remote computer and enter the IP address of the instrument.
2. Enter the following address:

vnc://<IP-address of the instrument>, e.g. vnc://192.168.1.1.

A dialog is opened and the password for the remote VNC connection is requested.

3. Enter the password as defined in the "Default Local System Properties" panel of the Ultr@VNC program and select "Log On".

The connection is established, the instrument is remote accessed and the current signal generator screen with the block diagram is displayed. The individual functions are operated using the mouse and keyboard.

In contrast to remote access via Remote Desktop, the direct control of the instrument is not disabled and the instrument can be controlled from the front panel and via the remote computer alternately.

Setting up the VNC connection on the Windows remote computer

1. Start VNC Viewer program component on the PC, select "VNC Server" and enter IP address of the instrument.

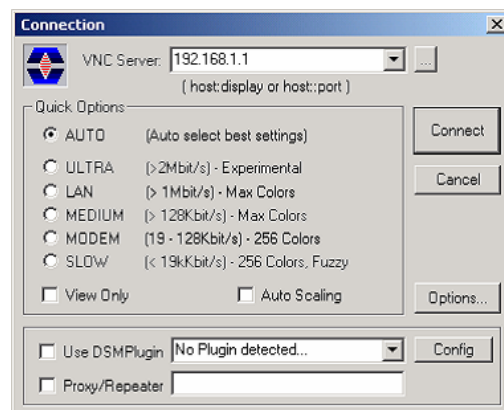

2. To initialize the connection, select "Connect".

A message requesting the password appears.

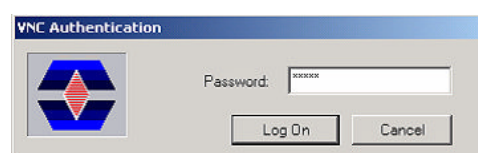

3. Enter the password as defined in the "Default Local System Properties" panel of the Ultr@VNC program and select "Log On".

The connection is established, the instrument is remote accessed and the current signal generator screen with the block diagram is displayed. The individual functions are operated using the mouse and keyboard.



Enabled Direct Control

The direct control of the instrument is not disabled and the instrument can be controlled from the front panel and via the remote computer alternately.

Terminating VNC Connection

The remote access via VNC connection can be terminated either on the R&S SMA or on the external PC. Terminating the connection does not disable it. It can be established again any time. See the notice above concerning unauthorized access due to VNC connection!

1. Terminate the connection on the R&S SMA
 - a) Press the "Windows" key to access the operating system.
 - b) Right-click on the VNC icon on the task bar and select "Kill all clients".
2. To terminate the connection on the external Linux/Unix PC, close the internet browser or close the signal generator window.
3. To terminate the connection on the external Windows PC, close the VNC Viewer program.

The connection is terminated. The color of the VNC icon in the status bar of the instrument changes.

A message on the external PC indicates the disconnection.

Disabling Remote Access via Ultr@VNC

The VNC connection can be disabled by removing the program on the instrument or by deactivating the VNC Server service.

1. Remove the VNC program
 - a) Press the "Windows" key to access the operating system and open the "Add or Remove Programs" by selecting "Start > Settings > Control Panel > Add or Remove Programs".
 - b) Remove the VNC program.
2. Deactivate the VNC Server service
 - a) Press the "Windows" key to access the operating system and open the "Services" by selecting "Start > Settings > Control Panel > Services".
 - b) Deactivate the VNC Server service.

The connection is disabled, the VNC icon disappears from the task bar of the instrument.

3 Getting Started

This section helps you to get familiar with the R&S SMA and provides an introduction to the general concept of the instrument with a sample of the possible application fields as well as a description of the main blocks in the signal generation flow.

This section also explains the operating concept in general and includes a brief introduction to operation by a step-by-step description of the configuration. The example is intended to provide a quick overview of the settings provided. No additional equipment is required.

3.1 Brief Introduction to the Instrument's Concept

The **operating concept** of the R&S SMA employs the following three ways of instrument control:

- Manual operation
- Remote control
- Remote access

Manual Operation

The R&S SMA can be entirely operated from the front panel. Peripherals such as mouse or keyboard can be connected but are not essential.

The R&S SMA is equipped with an intuitive user interface. The central element of the display is the block diagram that shows the signal flow and processing from the left on the display to most right, i.e. the generated signal can be seen at a glance.

Each block represents a functional unit of the instrument. Thus the user always knows the position at which a parameter has an effect in the signal flow. The main settings of a block are indicated in the block. The interconnection of employed inputs and outputs is also shown. The user is thus always informed about the connection of inputs and outputs in the signal flow and where they can be configured. A window is opened for each menu where parameters can be set. When the window is opened, an entry is made in the "Winbar" below the display. All open menus are of equal priority (not modal) and can be accessed any time.

The block diagram in the figure below shows a fully equipped instrument.

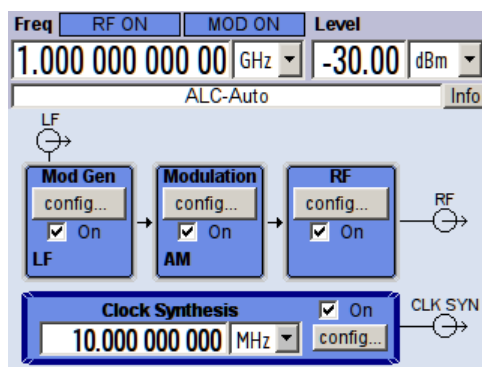

Fig. 3-1: Block diagram of a fully equipped R&S Signal Generator

With the aid of the rotary knob, the user can navigate in the block diagram and the dialogs, and can operate the instrument with one hand. The cursor is moved line by line through the block diagram or dialog. Turning the button clockwise advances the cursor. The selected block can be activated or deactivated with the TOGGLE key. Active blocks are highlighted by a colored background.

The instrument comprises a comprehensive info and help system. Context-sensitive help can be called any time with the HELP (F1) key. The help system indicates the currently selected parameter and offers additional services such as cross references, index and contents. The content of the help system corresponds to the operating manual of the instrument.

Warning and conflict messages caused by incorrect operation as well as further information are displayed in the "Info" line. A complete list of existing conflicts is displayed when the INFO (CTRL+I) key is pressed. Additional information on entries can be requested from the help system. The history function permits display of all messages.

Assistants simplify the completion of tables. After data entry in the assistant, the table is modified only after the "Accept" button has been pressed. Pressing the "Accept" button also stores the assistant data.

For an introduction into the manual operating of the instrument, detailed operating instructions and an overview of menus refer to [chapter 4, "Manual Operation"](#), on page 48.

For an in-depth description of the dialog boxes and the instrument functions refer to section "Instrument Functions" in the Operating Manual.

Remote Control

Remote control is an operation of the instrument by means of remote control commands or programs that automatize repeating settings. The instrument is connected to a computer running the program.

This way of operation and the instructions how to set up a connection for remote control are described in the Operating Manual, chapter "Remote Control Basics". The description of the remote control commands is provided in the Operating Manual, chapter "Remote Control".

Remote Access

Remote access is the operating of the instrument from a remote computer. Both the R&S SMA and the computer are connected in a LAN.

Remote access in contrast to **remote control** does not use remote-control commands but a separate software which is installed on the remote computer. After its start, the software simulates the user interface of the instrument. The instrument can thus be operated from the remote computer as on the unit itself. The individual functions are operated using the mouse and keyboard. Specific instrument functions can be executed using specific key combinations on the keyboard or a front panel key emulation that can be operated with the mouse.

This way of operation and the instructions how to set up a connection for remote access are described in [chapter 2.7, "Remote Access via an External Controller"](#), on page 31.

3.2 Application Field of the Instrument

The main field of application of the R&S SMA is the generation of sine wave signals with very high spectral purity. These signals are needed e.g. for adjacent channel or phase noise measurements.

In addition, the RF signal can be modulated with a wide variety of internal modulations waveforms, e.g. sine waves, triangle/rectangular/trapeze signals, and noise. Several modulation signals can be combined with variable weight.

3.3 Description of Individual Diagram Blocks

The signal path of the instrument is configured by installing a frequency option that comprises all required modules including synthesizer, output section and attenuator (optional without attenuator).



One of the following options must be installed.

- R&S SMA-B103 (up to 3 GHz)
- R&S SMA-B103L (up to 3 GHz, without attenuator)
- R&S SMA-B106 (up to 6 GHz)
- R&S SMA-B106L (up to 6 GHz, without attenuator)

Instruments without step attenuator provide a restricted level range at the RF output. Refer to the data sheet for detailed information.

Up-to-date information is available at R&S SMA homepage on the internet <http://www2.rohde-schwarz.com/product/sma100a.html>.



Mod Gen block

The internal modulation sources are configured in this block. Also, the "LF frequency sweep" can be activated here.

Two internal LF generators (second is optional) are available as the internal source(s) for the analog modulations AM, FM and PhiM. Different modulation shapes - sine, triangle, rectangle and noise - are offered for the second LF generator. Bandwidth and level distribution can be selected for the noise signal of the noise generator (optional).

Available modulation shapes are:

- sine
- triangle (optional)
- square (optional)
- trapeze (optional)
- noise with selectable bandwidth and level distribution (optional)

The internal modulation signals are provided at the LF output at the front of the instrument. The LF output signal and the modulations sources for the analog modulations AM, FM and PhiM can be selected independently from each other.

A pulse generator provides single and double pulse modulation with selectable pulse widths and periods. Additionally, an option is available to generate pulse train signals.

The R&S SMA offers three different sweep types (frequency sweep, level sweep and LF sweep) to be activated alternatively. Each type has 6 modes which differ with respect to the sweep cycle mode (continuous, individual and step-by-step) and triggering mode (automatic, internal and external). In the "Mod Gen" block, the LF sweep is configured. Frequency and level sweep settings are accessed via the "RF" block.

The status display in the block shows whether LF generator and/or a sweep are active. The selected internal LF generator and/or noise source are switched on or off with the TOGGLE ON/OFF key.

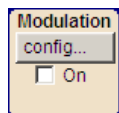

Modulation block

The internal and external analog modulations are configured and activated in this block. The MOD ON/OFF key switches the active modulation(s) on/off.

The internal modulation sources are configured in the "Mod Gen" block. The modulation inputs AM EXT, FM/PHIM EXT and PULSE EXT at the rear of the instrument are provided for external amplitude, frequency, phase and pulse modulation. AC or DC coupling for external feed is possible.

Modulation signals of up to three sources (two internal sources and one external source) can be combined for AM/FM and PhiM modulation.

Available internal and external analog modulation modes are:

- Amplitude modulation (AM)
- Frequency modulation (FM, optional)
- Phase modulation (PhiM, optional)
- Pulse modulation (Pulse)
- Chirp modulation (internal only)

In addition, external digital modulation signal can be used. The external signal for digital FM/PhiM modulation is fed in via the AUX I/O interface.

- Digital Frequency modulation (optional)
- Digital Phase modulation (optional)

Note: For modulation modes that can be simultaneously used, refer to the R&S SMA data sheet.

The status display in the block shows the active modulation(s). Use the TOGGLE ON/OFF key to switch the active modulation of the block on or off.



RF block

In this block, the RF parameters and frequency/level sweep settings are set.

The active sweep is displayed in the block. The RF ON/OFF key switches the RF signal on and off. When the signal is switched off, the switch before the RF output symbol is open.

RF settings include:

- Frequency and reference frequency
- Level settings; if required.
- NRP-Z Power Viewer and Power Analysis using power sensors
- Frequency and level sweep
- List Mode settings. In this mode, extremely fast frequency and level settings can be made.

The RF 50 OHM output connector at the front of the instrument provides the RF signal. An external trigger/gate signal for sweeps is input via the INST TRIG connector at the rear of the instrument

Note: Frequency and level are set fast with the aid of the FREQ and LEVEL keys.

Use the TOGGLE ON/OFF key to switch the RF output on or off.

Clock Synthesis

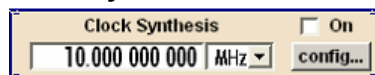

In this block, the clock synthesis is switched on or off and the frequency of the clock signal is set. For instruments equipment with modules with order number 1400.2749.02 DC offset can be defined, in addition.

The clock frequency is displayed in the block. Use the TOGGLE ON/OFF key to switch the generation of clock signal on or off.

3.4 Example of Setup

This section provides an example on how to configure the instrument for generating of an amplitude modulated signal and of a frequency modulated signal with noise.

Generation of an Amplitude-Modulated Signal

To generate a simple AM-modulated signal, proceed as follow:

1. Activate default (preset) state
Press the PRESET key to set a defined instrument state.

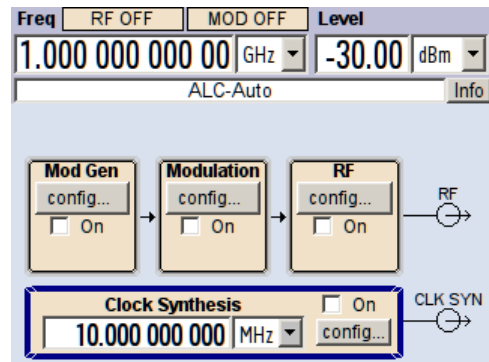

2. Select and activate AM modulation
 - a) Turn the rotary knob and select the "Mod" block.



- b) Press the rotary knob to open the dialog where the modulation can be selected (different modulation modes are available depending on the options installed).

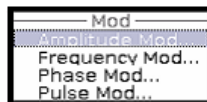

The "Amplitude Mod..." menu is the first menu and is highlighted per default.

- c) Turn the rotary knob and highlight "Amplitude Mod...". Press the rotary knob to open the "Amplitude Modulation" dialog.

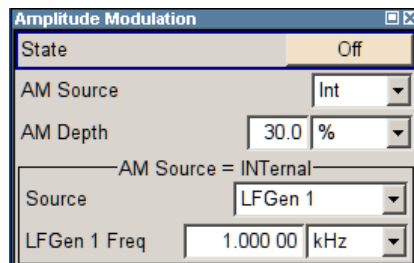

- d) Turn the rotary knob to select parameter "AM Depth", press the rotary knob to allow editing and enter the preferred AM depth with the aid of the numeric keypad and the unit keys.

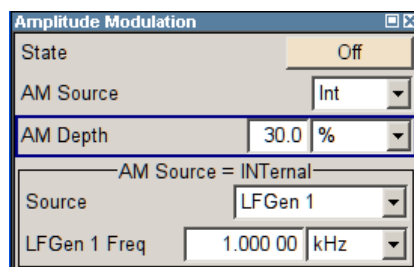

- e) Finally, select "State" and press the rotary knob to switch on the AM modulation.

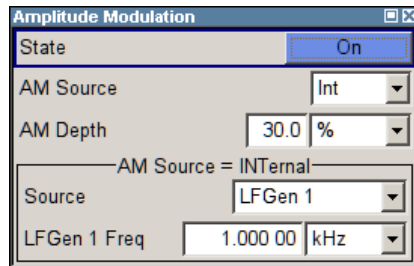

- f) Press the DIAGRAM key to display the complete block diagram.

To indicate the active state, the "Mod" block is displayed in blue. The "RF" is not yet active, which means that no RF signal is output.

3. Set frequency and level and activate RF signal

- a) Press the FREQ key to activate the editing mode for frequency entry. The "Frequency" entry field in the header section of the display is highlighted.

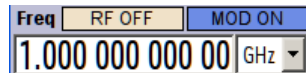

Enter the frequency using the numeric keypad and terminate the entry by pressing a unit key.

- b) Press the LEVEL key and enter the level settings in the same way.



- c) Press the DIAGRAM key to display the complete block diagram.
 d) Turn the rotary knob to select the "RF" block.
 Press the RF ON/OFF key to activate the "RF" block.

The AM modulation signal is now present at the RF output.

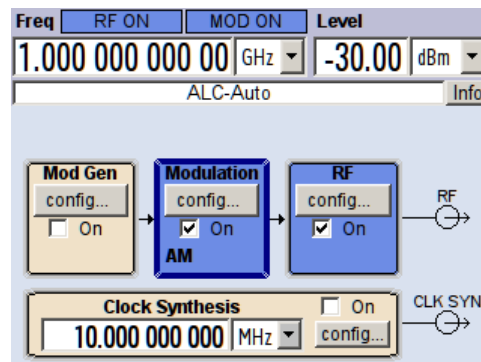

Generation of a Frequency Modulated Signal with Noise

To generate a simple FM-modulated with noise signal, proceed as follow:



This setting requires option Multifunction Generator, R&S SMA-K24.

1. Activate default (preset) state

Press the PRESET key to set a defined instrument state.

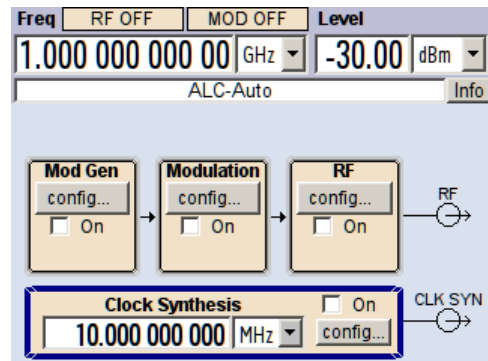

2. Select and activate FM modulation with internal noise signal and a deviation of 500 kHz

a) Turn the rotary knob and select the "Mod" block.



b) Press the rotary knob to open the dialog where the modulation can be selected (different modulation modes are available depending on the options installed).

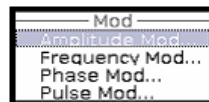

c) Turn the rotary knob and highlight "Frequency Mod...".

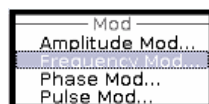

Press the rotary knob to open the "Frequency Modulation" dialog.

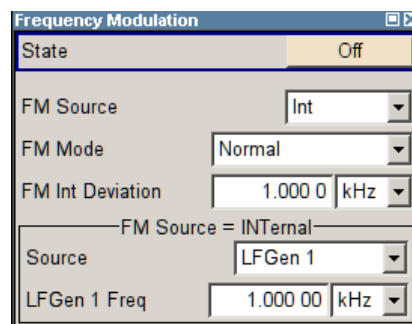

The internal source is the LF generator 1 by default. This setting is not changed.

- d) Turn the rotary knob to select parameter "FM Internal Source", press the rotary knob to open the selection list and select "Noise".

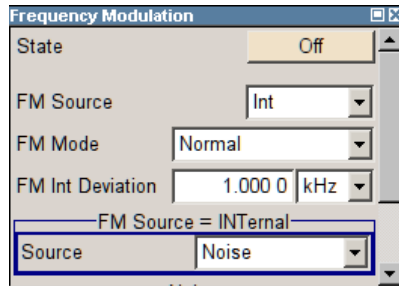

Gauss distribution and full bandwidth (10 MHz) are the default settings for the noise signal. These settings are not changed.

- e) Turn the rotary knob to select parameter "FM Int Deviation", press the rotary knob to allow editing and enter the preferred deviation with the aid of the numeric keypad and the unit keys.

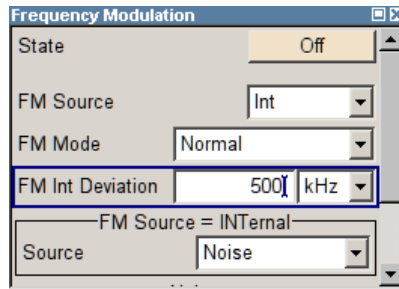

- f) Finally, select "State" and press the rotary knob to switch on the FM modulation.

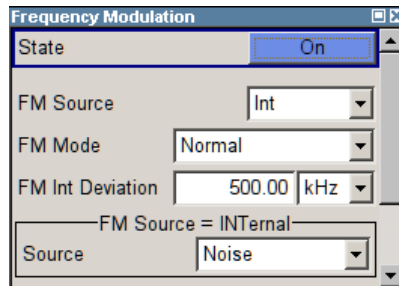

- g) Press the DIAGRAM key to display the complete block diagram.

To indicate the active state, the "Mod" block is displayed in blue. The "RF" is not yet active, which means that no RF signal is output.

3. Set frequency and level and activate RF signal

- a) Press the FREQ key to activate the editing mode for frequency entry. The "Frequency" entry field in the header section of the display is highlighted.

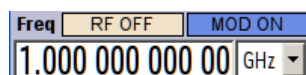

Enter the frequency using the numeric keypad and terminate the entry by pressing a unit key.

- b) Press the LEVEL key and enter the level settings in the same way.

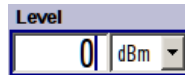

The noise now modulates the RF carrier.

- c) Press the DIAGRAM key to display the complete block diagram.
- d) Turn the rotary knob to select the "RF" block.
Press the RF ON/OFF key to activate the "RF" block.

The FM modulation signal is now present at the RF output. The LF output is not yet activated, i.e, the modulation signal is not output there.

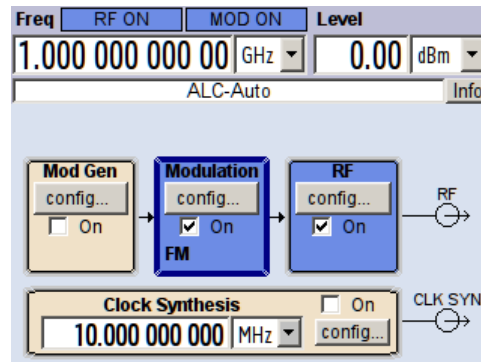

The graph below shows the FM modulated signal with noise (upper blue trace) and the unmodulated signal (lower greentrace).

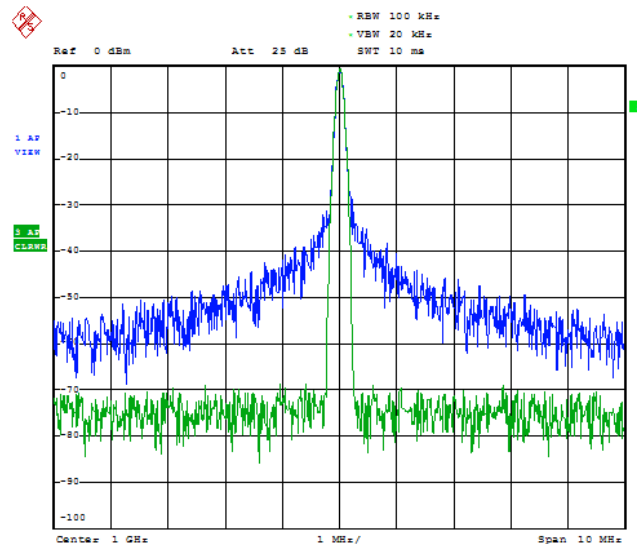

Date: 13. DEC. 2005 15:15:42

4 Manual Operation

The R&S SMA can be operated intuitively either via the interactive block diagram or via a menu tree. All menus are in the form of windows that can be operated in the same way. Rotary knob, keys and softkeys, or alternatively a mouse, allow direct and therefore convenient access to entries and settings.

The clear-cut display shows the current signal generator state. Numerous help functions support the user in signal configuration.

This section describes the concept of manual operation of the signal generator. This includes a description of the general structure of a dialog box, working with dialog boxes and the block diagram and the setting of parameters.

For an in-depth description of the dialog boxes and the instrument functions refer to section "Instrument Functions" in the Operating Manual.

4.1 Key Features

The manual operating concept of the R&S SMA enables the user to make settings as intuitively as possible and at the same time gives a permanent overview of characteristics of the generated signal and of the current instrument state. Numerous online help functions support user settings.

Block diagram

The block diagram is the core of the operating concept.

A graphics display shows the current configuration and the signal flow in the form of a block diagram. All graphical elements can be accessed for operation. An element is selected by means of the arrow keys and the associated setting function is called by pressing Enter. Required menus and graphs are displayed on the block diagram which is displayed again in the foreground whenever the DIAGRAM (CTRL+D) key is pressed.

Permanent frequency and level display

The main characteristics of the RF signal, frequency and level, are permanently displayed in the header section of the screen and can be directly set in the display fields after the FREQ (CTRL+F) or LEVEL (CTRL+L) key is pressed. Status messages for the output signal are displayed in addition to frequency and level.

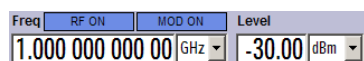

Operation via Graphical User Interface

- **Functional blocks**

Menus are assigned to the specific function blocks in the block diagram. The function blocks represent elements of signal generation. Function blocks displayed with a blue frame can be directly switched on and off by means of the TOGGLE ON/OFF (CTRL

+T) key. The menus of the highlighted function blocks can be called by pressing the ENTER key.

– **Example:**

The "Modulation" block contains all menus required for modulation signal configuration.

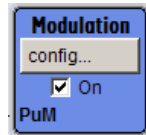

In this block all modulations can be selected.

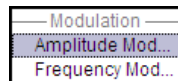

- **Signal flow**

The signal flow between the function blocks and the employed inputs and outputs are also shown.

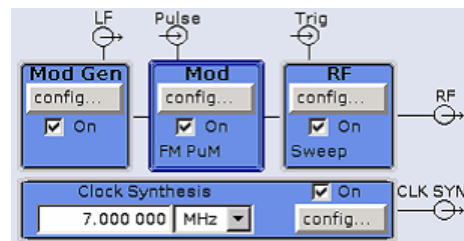

- **Menu tree**

The menu tree can be opened and closed with the MENU (CTRL+M) key. The menu tree is organized in the same way as the directories under Windows. The function blocks correspond to the first directory level, the menus to subdirectories.



Operation corresponds to the Windows concept

To offer the user a familiar environment, operation is very similar to operation of Windows user interfaces. All menus and tables are made up of known elements, such as selection lists, check boxes and entry fields.

A blue frame indicates that the selected item is active. In the highlighted element, entries can be made.

Rotary knob



Operation is possible via front-panel keys, an external keyboard and the mouse. However, most of the settings can be easily made with the rotary knob:

- Turning the rotary knob shifts the entry focus to the target element.
- Pressing the rotary knob activates the selected entry field. Depending on the parameter, the submenu is called, the numeric value varied, the list entry selected or the check box activated or deactivated.
- If a value is entered, the entry is stored by another click on the rotary knob and the editing mode is exited.

Clear settings with the aid of independent subdialogs

A separate window is opened for each dialog and subdialog. The dialogs can be operated independently of each other, i.e. none of the dialogs requires that settings in other dialogs be completed before it can be closed. This ensures flexible operation at all times.

Keys with assigned simple functions

Most keys on the front panel of the R&S SMA directly perform a simple function.

Since a great number of settings can thus be made by a keystroke, operation is easy. For instance, the CLOSE (ESC) key closes the active menu; with the RF ON/OFF (CTRL+R) key the RF output signal can be switched on or off.

An exception are keys that call a menu such as the MENU (CTRL+M) key which opens the complete menu tree of the instrument, the SETUP (CTRL+E) key which opens the menus for general instrument settings or the FILE (CTRL+S) key which opens the menu for file management.

Help functions for user support

Numerous help functions support the user in signal configuration.

- **Value ranges**

The valid setting range is displayed for each numeric parameter. This requires a short wait after activation of the entry field. The range is then displayed automatically after a few seconds.

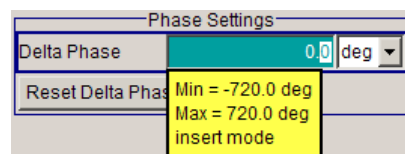

If the entered value is outside the permissible range, the next permissible value is automatically set and a message is output.

- **Context-sensitive help**

Context-sensitive help for each parameter can be called with the HELP or F1 key.

- **Comprehensive online help**

Each help page is part of a comprehensive online help function which can be called by means of an index, a content tree or the "Previous/Next" buttons.

Info line with messages for indication of the current instrument state

A great variety of different messages such as status messages, error messages, warnings or information are displayed in the header field of the screen. With the aid of the INFO (CTRL+I) key, help pages can be called for most of the messages. They provide background information on the message and indicate operating steps that may be required. All messages are explained in the online help which can be called with the HELP (F1) key.

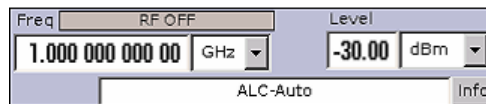

4.2 Display

The display shows the current signal generator state and offers graphical elements for direct operation. It is divided into three sections:

- The frequency and level display with info line indicates the main output signal parameters and reports the current state with status, error and warning messages.
- The block diagram shows the instrument configuration, the signal characteristic as well as the inputs and outputs used and permits interactive operation via graphics elements. Active menus and graphs are displayed on top of the block diagram.
- Winbar with labelled softkeys for menu display.

The block diagram in the figure below shows a fully equipped instrument.

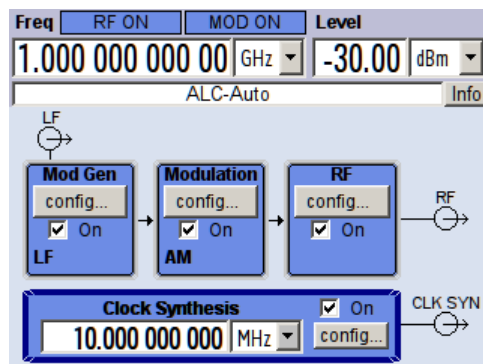

Fig. 4-1: Block diagram of a fully equipped R&S Signal Generator

4.2.1 Settings Displayed in the Header Section

Frequency/level settings and a few status messages (see [chapter 4.2.2, "Status Information and Messages"](#), on page 52) are displayed in the header field of the screen.

The display may vary depending on the instrument's operating mode:

- In the sweep mode, the current frequency or level of the output signal is displayed. The status message "SweepMode" is displayed in the info line.

- In the list mode, neither the current frequency nor level is displayed, the indication is dimmed.
- If user correction is active, the status message "UCorr" is displayed in the info line.



The value displayed in the "Freq" and "Level" field does not consider any offset set or multiplier factor.

For more information see "RF Frequency and Phase" and "RF Level" in the Operating Manual.

The frequency and level indication can be enlarged so that it covers the complete display of the R&S SMA by using the DIAGR key. This key toggles between block diagram, magnified frequency and level indication and the display of the active dialog. This requires the "Summary Screen Toggle" to be enabled.

See chapter "Display/Keyboard Settings" in the operating manual.

4.2.2 Status Information and Messages

The status information and messages are displayed in the header section of the screen. The messages differ with respect to their importance (errors, warnings, info) and the time of their appearance (brief and permanent messages). They require different treatment by the user. Further information on all messages can be called in the info window (see [chapter 4.2.3, "Info Window"](#), on page 53).

Refer to "Error messages" in the Operating Manual for an overview of all status information and messages as well as instructions for error elimination.

4.2.2.1 Status Information

The status information gives the user an overview of the main operating states and settings of the instrument. The states are indicated for information only and do not necessitate any action by the user.

Status information is displayed between the frequency and level fields, at the left of the info line or in the info line itself.

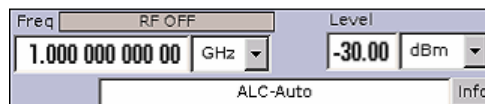

4.2.2.2 Messages

Messages indicate errors in the instrument. They are displayed in the info line in different colors depending on their importance and display duration. Errors (e.g. no calibration data) are displayed in red, information (e.g. file not found) and warnings in black. Warnings indicate less significant errors (e.g. the instrument operates outside specified data).

4.2.2.3 Volatile messages

Brief messages report automatic settings in the instrument (e.g. switching off of incompatible types of modulation) or on illegal entries that are not accepted by the instrument (e.g. range violations). They are displayed in the info line on a yellow background. They are displayed on top of status information or permanent messages.

Volatile messages do not normally demand user actions and disappear automatically after a brief period of time. They are stored in the history, however.

These messages can be read from remote using `SYST:ERR?` or `SYST:ERR:ALL?`.

4.2.2.4 Permanent Messages

Permanent messages are displayed if an error occurs that impairs further instrument operation, e.g. a hardware fault. The error signalled by a permanent message must be eliminated before correct instrument operation can be ensured.

The message is displayed until the error is eliminated. It covers the status display in the info line. After error elimination, the message automatically disappears and is also recorded in the history.

These messages can be read from remote using `SYST:SErr?`.

4.2.3 Info Window

A few operating states and the current message are displayed in the info line.

The INFO window with a list of current permanent messages and a detailed description of each message can be opened with the INFO (CTRL+I) key.

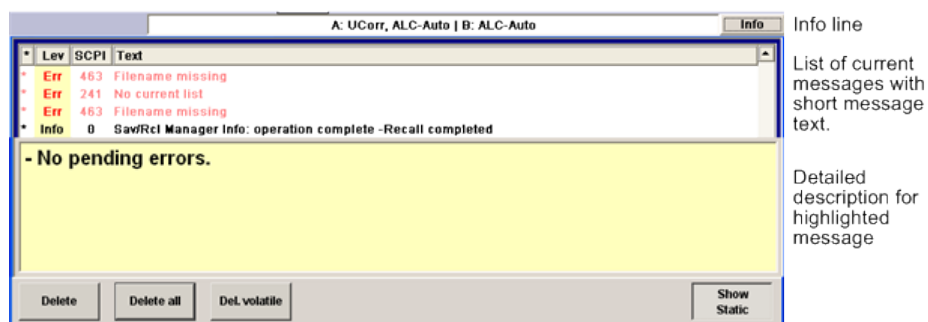

The upper section of the info window contains a list of all current permanent messages in the order of their occurrence, i.e. the most recent message is displayed first. In the lower section of the window, additional information on the highlighted message is displayed. A history of all messages that have occurred since instrument switch-on can be called with the "History" key. The most recent message is displayed first.

The messages are color-coded according to their level. Device-specific messages are red, info and remote control error are black. The level is also indicated in the "Lev" column (Err, Sys or Info). Column "SCPI" indicates the SCPI error code.

With the aid of the softkey buttons, error messages can be cleared and a history of all messages called.

Delete

Clears the highlighted message.

This button is available only if the history of the messages is displayed.

Delete All

Clears all messages.

This button is available only if the history of the messages is displayed.

History

Calls the list of all messages that have occurred since instrument switch-on. The most recent messages are displayed at the top of the list. When the button is pressed again, the list of current messages is displayed.

SCPI command:

`SYST:ERR?` or `STAT:QUE?`

Each time a `SYST:ERR?` or `STAT:QUE?` query is sent, the oldest entry in the error queue is returned and at the same time cleared in the list.

4.2.4 Block Diagram

The block diagram shows provided options, signal configuration and the currently selected signal flow of the generator with inputs and outputs used. Signal generation can be completely operated from the block diagram. The highlighted function block can be directly switched on and off with the TOGGLE ON/OFF (CTRL+T) key. Pressing the Enter opens the associated setting menu.

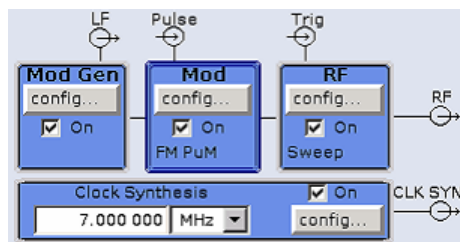
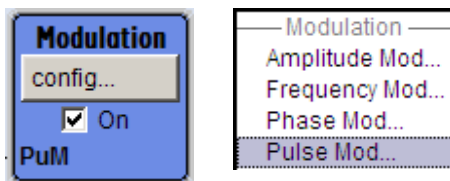

Fig. 4-2: Block diagram of the R&S SMA

4.2.4.1 Function Blocks in the Block Diagram

Each block represents a function of signal generation. The function is indicated in the headline of the block. In the check box, the respective function can be quickly activated/deactivated with the TOGGLE ON/OFF (CTRL+T) key. After activation, the block is displayed in blue. Status information is displayed below the check box. It is different for the different blocks.

Pressing the rotary knob (front panel) or the "Config..." button (mouse) opens the associated setting menu.

Example: Modulation block

In this block, the modulation signals are set. The status information of the "Modulation" block indicates the selected modulation.

4.2.4.2 Signal Flow and Input/Output Symbols in the Block Diagram

The input/output symbols in the block diagram show the currently used inputs and outputs of the signal generator. Unused inputs and outputs are not shown. The lines indicate the signal flow.

Symbols and labels refer to the corresponding inputs and outputs on the front and rear panel of the signal generator. The direction - input or output - is indicated by an arrow.

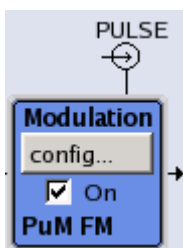
Example:

The symbols indicate the input for the external pulse signal on the instrument rear panel.

4.2.5 Structure of the Dialogs

The parameters are set in the menus. Menus are accessed either via the function blocks in the diagram or by means of the MENU (CTRL+M) key. The menus are displayed on top of the block diagram.

The WINBAR key toggles between the active menus. The REARR key toggles between the enlarged and normal sized menus.

Working with menus and dialog boxes is described in [chapter 4.3, "Accessing Dialogs"](#), on page 56; the setting of parameters in [chapter 4.4, "Setting Parameters"](#), on page 57.

The menus are in Windows format. The menus differ in details depending on their function but they consist of the same main elements. Each menu consists of a menu header and one or more menu areas with various fields for setting parameters.

The header line contains the name of the menu and the buttons for minimizing and closing the menu. To operate the buttons, use the mouse or the front key CLOSE (ESC).

Several fields of associated but separately set parameters are organized in menu areas. A menu area is framed and labelled with the function common to all parameters.

Example: Pulse Generator

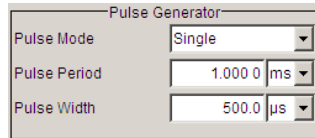

Each of the setting fields is assigned a parameter name. The kind of setting varies depending on the parameter to be set. Some settings can only be made in a specific configuration. If setting is not permitted with the specific configuration selected, the respective item is disabled and displayed in gray and the entry or selection field cannot be accessed.

4.3 Accessing Dialogs

The MENU (CTRL+M) key opens the complete menu tree. Selecting a functional block and pressing the ENTER key opens the menu associated with this block.

An alternatively way to access a dialog is to use the CLOSE (ESC), DIAGRAM (CTRL+D) and REARR (CTRL+A) keys on the front panel.

For a quick access to the dialogs, use one of the following alternative methods.

Displaying the block diagram or a dialog in the foreground

- ▶ Press the DIAGRAM (CTRL+D) key to move the cursor to the block diagram.
All active menus are minimized.

Enlarging the indication of the header section

- ▶ Press the DIAGRAM key twice to enlarge the indication of the header section.
Tip: Use the REARR key to toggle between the enlarged and normal sized dialogs.

Accessing the menu tree

- ▶ Press the MENU (CTRL+M) key to open the complete menu tree.

Calling the File or Setup dialog

- ▶ Use the FILE (CTRL+S) or SETUP (CTRL+E) keys to open the respective dialog.

Closing an active menu

- ▶ Press the CLOSE key to close an active menu.
Tip: If the cursor is at the highest menu level, you can also use the ESC key to close the active menu.

Accessing the header area

- ▶ Press the **FREQ** (CTRL+F) and **LEVEL** (CTRL+L) keys to activate the "Frequency" or "Level" entry fields in the header area.



Keyboard Shortcuts

Keyboard shortcuts (e.g. "Ctrl + D" for the displaying the block diagram in the foreground) provide direct access to all utility dialogs of the instrument (see [chapter 4.8, "Legend of Front-Panel Controls"](#), on page 70).

4.4 Setting Parameters

The R&S SMA offers several and sometimes alternative possibilities for setting parameters. Operation is possible from the front panel, with the aid of a mouse and/or from a PC keyboard.



The examples within this description focus on the operation from the front panel.



For more information, refer to:

- [chapter 4.8, "Legend of Front-Panel Controls"](#), on page 70 for an overview of key functions and a cross-reference between the front panel keys and the keyboard shortcuts
- "Instrument Functions" in the Operating Manual for a detailed description of key functions.

Most of the parameters are set in the different menus. The R&S SMA provides alternative ways for accessing the dialogs. Turn the rotary knob and navigate to the corresponding block in the block diagram and press the knob to open the dialog or perform a mouse click on the "Config..." button.

An exception are the "Setup" and "File" dialogs. In the "Setup" dialog, general settings are made which are not directly concerned with signal generation, e.g. setting of the GPIB-bus address. In the "File" dialog, files and lists are managed.

These menus can only be called with the **SETUP** (CTRL+E) and **FILE** (CTRL+S) keys.

Frequency and level are directly set in the header area of the display using the **FREQ** and **LEVEL** keys.

Specific settings can also be made directly in the block diagram, e.g. activating a function block by means of the **TOGGLE ON/OFF** (CTRL+T) key or switching the RF output on and off with the aid of the **RF ON/OFF** (CTRL+R) key. Changes affecting the signal flow are immediately visible in the graphics display.

This section provides an information about the parameter handling that comprises of the following main steps:

- [chapter 4.4.1, "Working with the Cursor"](#), on page 58
- [chapter 4.4.2, "Selecting a Control Element"](#), on page 58
- [chapter 4.4.3, "Switching Parameters On/Off"](#), on page 59
- [chapter 4.4.4, "Entering a Value"](#), on page 59
- [chapter 4.4.5, "Working with Units "](#), on page 61
- [chapter 4.4.6, "Selecting a Value from a List"](#), on page 61
- [chapter 4.4.7, "Terminating Entries with Confirmation"](#), on page 62
- [chapter 4.4.8, "Restoring the Previous Value"](#), on page 62

4.4.1 Working with the Cursor

After the instrument is switched on, the cursor is always on the first function block of the diagram (default setting).

Moving the cursor on the display

- ▶ To move the cursor, use one of the following alternative methods:
 - a) Use the rotary knob or the arrow keys.
 - b) Use the WINBAR key to toggle between the active dialogs.
 - c) Use the ESC key.

Tip: Be aware that the function of the ESC key depends on the current cursor position. The function of this key depends on the current cursor position.

- Calls the next higher selection level.
- Closes the open window without accepting new entries; the old value or parameter is retained.
- In dialog boxes that contain a "Cancel" button it activates that button.
- Closes all kinds of dialog boxes, if the edit mode is not active.
- Quits the edit mode, if the edit mode is active.
- Switches between different entry fields of a menu.
- Shifts the entry cursor from the header display to the previously active menu, or to the previously highlighted block in the block diagram if no menu is active.

Moving the cursor to the heading area

- ▶ Press the **FREQ** (CTRL+F) or **LEVEL** (CTRL+L) key to move the cursor to the header area.

4.4.2 Selecting a Control Element

Control elements are always selected in the same way no matter whether a function block in the diagram, a menu in the menu tree, a parameter in the menu or an entry in a list or table is concerned.

- ▶ To activate an element, put the cursor on it.



An active element is highlighted by a blue frame.

4.4.3 Switching Parameters On/Off

A parameter can be activated and deactivated using a button or a check box.

1. Select the parameter.
2. To change the state of a parameter, use the "Enter" function of the different control media:
 - Press the rotary knob
 - Press ENTER
 - Press the TOGGLE ON OFF (CTRL+T) key.

Colour and label of a button change, the check box is ticked or the tick is removed.

4.4.4 Entering a Value

Numeric and alphanumeric values can be edited in the entry fields. In the editing mode, cursors of different colour are used. A blue cursor indicates the overwrite mode, a green cursor the insert mode.

Numeric and alphanumeric values can either be newly entered or the existing value can be changed. Incorrect entries are cleared with the BACKSPACE key.

Entering a new numerical value

1. Select the parameter.
2. Press a numeric key to activate the editing mode.

The previous value is cleared and the new value can be entered.

Editing a value in the insert mode (default setting)

1. Press the rotary knob (= Enter) to activate the editing mode.
If the cursor is placed at the right of the total value, the insert mode is always active.
2. Set the cursor to the left of the number to be changed using the LEFT/RIGHT arrow keys.

The cursor is displayed in green.

3. Click on a numeric key to insert a new value.



Editing a value in the overwrite mode

1. Activate the editing mode.
2. Set the cursor on the numeric digit to be changed using the LEFT/RIGHT arrow keys.
The cursor is displayed in blue and the number to be replaced is highlighted.
3. Click on a numeric key to overwrite the highlighted value.



Varying a value

1. Activate the editing mode.
2. Set the cursor to the left of the number to be changed using the LEFT/RIGHT arrow keys.
The value at the cursor position is varied.
3. To vary the selected value, use the UP/DOWN arrow key or turn the rotary knob.
The value is increased or decreased.

Entering a new alphanumerical value

1. Select the parameter.
2. Press an alphanumeric key to start the editing mode.
The new value is entered.

Editing an alphanumerical value

An existing value, e.g. a file name, can be changed in the insert mode (see example) or in the overwrite mode.

1. Select the parameter and activate the editing mode.
2. Set the cursor to the left of the alphanumerical value using the LEFT/RIGHT arrow keys.
Tip: If hexadecimal values are to be entered, the numeric front-panel keys are automatically changed to hexadecimal values.
3. Click on an alphanumeric key to insert a new alphanumerical value.

Terminating the entry of a numeric value

To terminate the entry of a numeric value:

1. Press the rotary knob (= Enter).
2. Press a UNIT key on the front panel.
3. Select a "Unit" in the selection field next to the parameter value.

4.4.5 Working with Units

The unit of a parameter is displayed next to the value. When the parameter is edited, the unit is selected either from the list or by means of the front-panel keys. When the entry is completed, the unit can be changed. In this case the value remains unchanged but is automatically adapted to the new unit.



While operating the instrument by means of a mouse, assign the unit to the selected parameter before entering its value.

Assigning a unit

To assign a unit to a value, use one of the following alternatives:

1. Press a UNIT key on the front panel.



2. Select a "Unit" in the selection field next to the parameter value.
Press the ENTER key.

The unit displayed in the entry field next to the value is assigned.

Changing a unit

To subsequently change a unit, i.e. after the entry has been terminated and when the editing mode is not active, use one of the following alternatives:

1. Press a UNIT key on the front panel.
2. Select "Unit" in the selection field next to the parameter value.

The value remains unchanged but the display is automatically adapted to the new unit, i.e. the value is recalculated to suit the new unit.



The new unit is indicated in the value field of the menu.

4.4.6 Selecting a Value from a List

Selection lists provide a list of predefined values for the selected parameter.

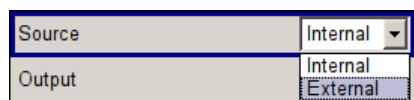

To select a item from a list, proceed as follow:

1. Press ENTER key to open the list.
2. Use one of the following alternatives to navigate through the list:

- a) Turn the rotary knob or use the UP/DOWN arrow keys.
The selected item is highlighted.
 - b) Press TOGGLE ON/OFF key several times until the preferred entry is displayed in the selection field.
3. To confirm the selection, press the ENTER key.

4.4.7 Terminating Entries with Confirmation

The instrument behaves different by the termination of entries depending on the parameter type and the way this parameter is set.

Confirming settings

- ▶ To confirm the settings, press the rotary knob or one of the UNIT keys (see also [chapter 4.4.5, "Working with Units"](#), on page 61).

Note: Variations by means of the rotary knob are immediately set.

Confirming multiple values

In some cases, like for instance when editing data in a user correction table, it is useful first to enter few values and to confirm them together. Such settings require additional confirmation. Not yet confirmed settings are displayed on a yellow background as an indication that the currently displayed values do not represent the target signal.

- ▶ To confirm these settings, select the "Save" or "Accept" button, respectively.

Confirming parameters with On/Off state

Most of the instrument functions with enabled and disabled states are calculated and effective only after this functions have been enabled. However, there are functions like the frequency variation of the reference oscillator for instance, that are immediately set after confirmation.

- ▶ To confirm a parameter with On/Off state, enable the parameter.

4.4.8 Restoring the Previous Value

Parameter variations with the rotary knob are immediately set and therefore not reversible.

Normally, values cannot be restored in the case of mouse control because no explicit confirmation is required in this case and entries are automatically confirmed when the entry or selection field is exited.

Restoring values

In the case of front-panel control or operation from the keyboard, previous values can be restored as long as the new value is not confirmed, i.e. the entry is not completed.

- ▶ To restore the values, press the ESC key.

Restoring values that require confirmation

All settings that are not confirmed with the "Accept" button but require this additional confirmation can be restored.

1. Press the ESC key.

A confirmation query is displayed.

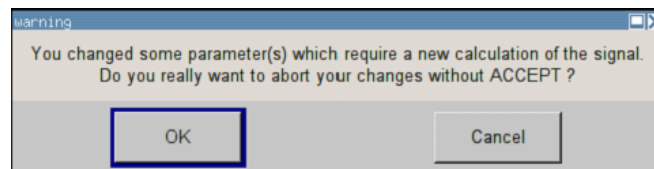

2. Confirm with "OK" to abort the changes.
Select "Cancel" to return to the dialog. The previous selected settings are displayed.

Restoring values after an extended calculation has been started

Calculation and setting might require different period of time. Many settings are made without noticeable calculation times; such operations are indicated by a "BUSY" message displayed in the status field of the header section.

A window with a progress indicates that the instrument performs an extended calculation that requires longer calculation time. The termination of such a calculation restores the previous values.

- ▶ Press the ABORT button to terminate the calculation.

All previous values are restored.

4.5 Editors

The R&S SMA provides user-friendly editors for defining lists. Lists containing frequency and level value pairs are used for the list mode and the user-defined level correction.

The lists are saved to files and may thus have any length. The file name of the lists and the directory to which the files are saved are user-selectable. The file prefix is different for each list type and is permanently assigned by the system.

For information about file handling and overview of the automatically assigned file prefixes, refer to [chapter 4.7, "File Management"](#), on page 66.

4.5.1 Working with List Editor

The "User Correction" and "List Mode" dialogs provide a list editor for defining the frequency/level value pairs.

Editing list mode data lists

1. To access a list editor and open an existing data list for editing, use the cursor keys to select the associated button "Edit User Correction Data..." or "Edit List Mode Data..." (if available) in the individual menu.

The selected list is displayed and the cursor marks the first row of the "Frequency/Hz" column.

	Frequency/Hz	Power/dBm
1	100 000.000	-140.00
2	100 010.000	-140.00
3	100 020.000	-140.00
4	100 030.000	-140.00
5	100 040.000	-140.00
6	100 050.000	-140.00
7	100 060.000	-140.00
8	100 070.000	-140.00
9	100 080.000	-140.00

Goto Edit Save

If no list has been selected, a blank list of only one row is displayed.

2. Press the LEFT/RIGHT arrow keys to change between the columns. Use the UP/DOWN arrow keys to mark a row.
3. Use the numeric keys to enter the value for the value pairs in the "Frequency/Hz" and "Power/dBm" table columns. A blank row is inserted at the end of the list. Terminate the entry by pressing a UNIT key.
4. To select a row, select the "GoTo" button and press the ENTER key. Use the numeric keys to enter the row index in the entry field and press the ENTER key to confirm the entry. The cursor moves to the selected row.
5. To insert a new row in the table, select the row above which the new row is to be inserted and select "Insert Row(s)". A row is inserted above the currently marked row. If no row has been selected, a row is inserted at the beginning of the list.
6. Use the "Save" function to save the edited list under its current name. Enter the file name in the "File Select" dialog and select the directory (see [chapter 4.7.1, "File Select Dialog"](#), on page 67). Only complete value pairs are taken into consideration; rows containing an entry in only one column are ignored.

Creating a new list mode data list

A new list can be created under a new name either by generating a blank file in the "File Select" menu (see section [chapter 4.7, "File Management"](#), on page 66) or by changing an existing list which will then be saved under a new name.

1. To create an empty data list, select "RF > List Mode > List Mode Data... > New List" or respectively "RF > User Correction > User Cor. Data... > New User Correction Data" and enter the file name of the new data list.

- To open the data list for editing, select the associated button "Edit User Correction Data..." or "Edit List Mode Data..." in the individual menu.
Edit the list and save it under a new name.

4.6 How to Use the Help System

The R&S SMA is equipped with a context-sensitive help function. A help page is available for each parameter and can be called any time during instrument operation.



Compiled online help systems are also available for all functions of the R&S SMA on the CD-ROM supplied with the instrument. This help program can be called on any controller with Internet Explorer version V4.0 and higher.

Calling context-sensitive and general help

- ▶ To display the general help dialog box, press the HELP (F1) key.

The help dialog is displayed. A topic containing information about the current menu or the currently opened dialog box and its function is displayed.

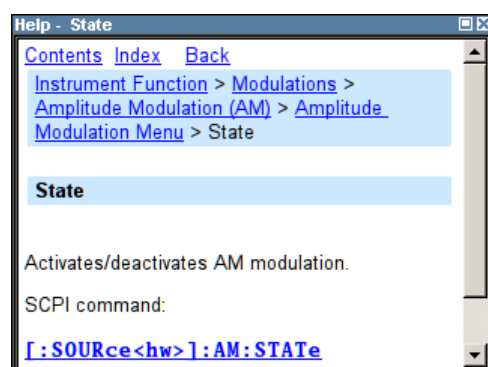

On top, the help dialog box contains a navigation bar with:

- "Contents" - accesses a table of help contents
- "Index" - switches to an index table
- "Back" / "Previous" / "Next" for navigation to further help topics

Navigating in the table of contents

- To move through the displayed contents entries, use the UP/DOWN keys. Entries that contain further entries are marked with a plus sign.
- To display a help topic, press the "ENTER" key.
The corresponding help topic is displayed.

Navigating in the help topics

- To scroll through a page, use the UP/DOWN arrow keys.

2. To jump to the linked topic, press the link text.
3. Use the "Previous" or "Next" links to jump to the corresponding topic.

Using the Index

1. Select "Index".
2. Enter the first characters of the topic you are interested in. The entries starting with these characters are displayed.
3. Press the ENTER key to change the focus.
4. Use the UP/DOWN keys to navigate and select the suitable keyword.
5. Press the ENTER key to display the help topic.
The corresponding help topic is displayed.

Closing the help window

- ▶ Press the HELP (F1) key.

4.7 File Management

The R&S SMA uses files to save all instrument data, i.e. system and user data.

The user data includes saved instrument settings and lists and the user correction.

The files are stored on the CompactFlash™ card of the instrument. The `/var` directory can be used to save user-defined data; any subdirectory structure can be created on `/var`. Some default subdirectories are predefined, but can be changed at any time.

The `/opt` directory is a protected system drive and therefore unaccessible system directory. The files on this directory contain data that must not be changed. Therefore, this drive should not be accessed, since reconstruction of the system partition will lead to data loss. To prevent inadvertent deletion or overwriting of system files, this drive is not specified in the file menus.

Files can be exchanged either via a memory stick or a connected network. A memory stick is connected to the USB interface and is assigned the `/usb` drive. In the case of a connected network, all network drives that can be accessed are available. The files are accessed in a "Save/Recall" dialog in the individual menus.

The files are differentiated according to their extensions; each type of file is assigned a specific file content. The extension is usually of no consequence to the user since access to the files occurs in the individual menu where only the relevant type of file is available. See [chapter 4.7.2.1, "Extensions for User Files"](#), on page 69 for an overview of the supported file extensions.

The user data can be roughly divided into the following data types:

- Settings
Instrument settings can be saved and loaded. In case of saving, the current setting is saved to the specified file.

- Lists
Lists, e.g. user correction lists, can be loaded. They can be generated either externally or internally. For internal generation, a new list must be created in the "File Select" dialog which will then be edited in the list editor of the individual menu.



For more information, refer to:

- [chapter 4.8, "Legend of Front-Panel Controls"](#), on page 70 for an overview of key functions and a cross-reference between the front panel keys and the keyboard shortcuts
- to "Instrument Functions" in the Operating Manual for a detailed description of key functions.

Accessing files with user data

1. To access an editable user data file, select the "Save/Recall" or "File Manger" function in the individual dialog.

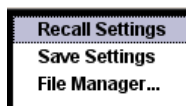

2. To access a loadable data file, select the "Select/New" or "File Manager" function in the individual dialog.

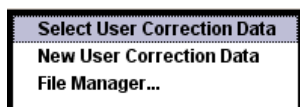

3. To access the "File Manager" function, press the SETUP (CTRL+E) key and select "Save/Recall > File Manager".

A "File Select" window for loading, saving or creating a file or the "File Manager" dialog for managing all files is displayed.



Saving and loading of all instrument settings

All instrument settings are saved and loaded in the "File" menu.

To access the "File" menu, press the FILE (CTRL+S) key.

For more information, see chapter "Storing and Loading Instrument Data - File Key" in the Operating Manual.

4.7.1 File Select Dialog

The "Save/Recall" dialog displays the available drives and directories. In the upper part, "Recent Data Sets", the files last used are listed.

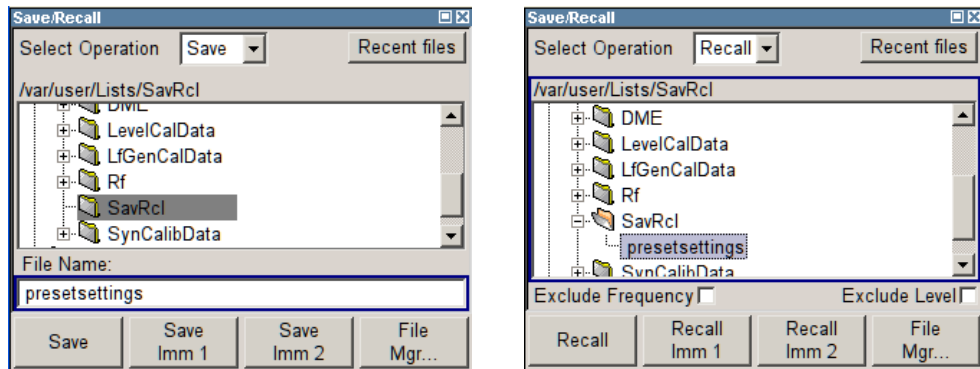

The available drives and directories and the files of the selected directory are displayed. The currently selected path is displayed above the window. Only the relevant files without file extensions are displayed. If the area is opened several times, the path last selected is displayed. When a file is saved or created, its name is user-selectable; the extension is assigned automatically and cannot be entered. The file is saved to the selected path.

In addition to the files saved by the user, some menus also offer files containing predefined contents. These files are saved to a specific directory on system drive; for this reason, this directory cannot be chosen from the "File Select" menu.

Working with the File Select dialog

1. Access the "File Select" dialog (see ["Accessing files with user data"](#) on page 67).
2. Navigate in the "File Select" dialog.
3. Load an existing file.
In the "Recall Settings" dialog, mark a file and press the "Select" button.
4. Save a file.
In the "Save Settings" dialog, enter file name in the "File Name:" field.
Select the directory to which the file is to be saved and then select the "Save" button.
5. Create a new file.
To create a new file, use the "Save Settings" functionality, i.e. specify file name and directory and save the file.

The created file is empty; it must be filled with the necessary values in the individual editor.

4.7.2 File Manager

The "File Manager" allows general file management such as copying, shifting, renaming and deleting files as well as generating new directories.

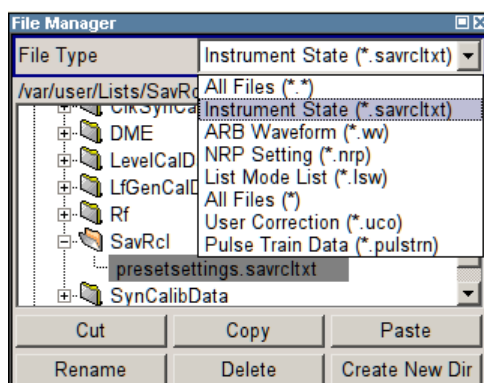

Use the "File Type" to select a file type from the list. This can be used to process either all files (all files (*) selection) or a specific selection of files. See [chapter 4.7.2.1, "Extensions for User Files"](#), on page 69 for an overview of the supported file extensions. The available drives and directories and the files of the selected directory are displayed. The currently selected path is displayed above the windows. If the area is opened several times, the path last selected is displayed. Unlike the "File Select" window, the "File Manager" displays the full file names including extensions.

Working with the File Manager dialog

1. Accessing the "File Manager" dialog (see ["Accessing files with user data"](#) on page 67).
2. Navigating in the "File Manager" dialog.
Operation is similar to the operation of menus with several areas.
3. Moving, duplicating, deleting or renaming files
To move a file, select the file and press the "Cut" button. Mark the directory to which the file is to be moved and select the "Paste" button. If the target directory already contains a file with the same name, a confirmation query is displayed to confirm overwriting of this file.
Perform the similar steps and cut/copy/rename/delete the file.
Tip: The operation corresponds to the Windows concept.
4. Creating a new directory
Mark drive or directory level where the new directory is to be created, select the "Create New Directory" button and enter the name of the new directory in the entry window that opens. Confirm with ENTER.

4.7.2.1 Extensions for User Files

The following table lists all available file extensions for user files. The currently available files on the instrument depends on the installed options.

Table 4-1: List of the automatically assigned file extensions in the instrument

Function	List type	Contents	File suffix
Instrument State	Settings	Instrument settings	*.savrc1txt
"User Correction"	List	User-defined level correction values	*.uco
		Export Data	*.txt or *.csv
"List Mode"	List	User-defined frequency/level value pairs	*.lsw
		Export Data	*.txt or *.csv
"Pulse Train List"		User-defined offtime/ontime/repetition values	*.pulstrn
ARB Waveform		ARB Waveform	*.wv
NRP Settings	Settings	NRP Settings	*.nrp

4.8 Legend of Front-Panel Controls

The following table lists all key functions available on the front panel. Key combinations used on the PC keyboard to trigger key functions on the instrument front panel are also described. Keyboard labels are described in alphabetical order.

In addition, a front panel key emulation and an on-screen keyboard can be used for manual operation by mouse only.

Table 4-2: Cross-reference between the front panel keys and keyboard shortcuts

Front-panel key	Key of PC keyboard	Function
Turning the rotary knob	Tab key (towards the right) Shift + Tab (towards the left)	Sets the cursor with the rotary knob.
Pressing the rotary knob	Enter	Pressing the rotary knob confirms an entry; it has the same function as the ENTER key.
Arrow keys	Arrow keys	Moves the cursor.
ENTER / *1 / dB(m)	Enter ALT + F12	Terminates an entry. Confirms entries in the base unit and values without a unit. Selects dBm for the RF level and dB for level offset and level step width.
. / *...#	. / *...#	Enters a period/decimal point. Enters a special character.
- / A->a	- / (shift+) a—z	Enters the sign. Switches between upper-case and lower-case letters.
0-9 / a...z	CTRL+ 0-9 / a...z CTRL	Enters the number/letter.
BACKSPACE	Backspace	Clears the last entry (number, sign or decimal point)

Front-panel key	Key of PC keyboard	Function
ESC / CLOSE	ESC / CTRL + G	Selects the next higher menu/selection level. When the editing mode is exited with ESC, the previous value is restored. Closes an active menu.
DIAGRAM	CTRL+ D	Sets the cursor on the block diagram and hides all menus.
FILE	CTRL + S	Activates the menu for storing instrument settings.
FREQ	CTRL+ F	Activates the frequency entry.
G/n / dBuV	ALT + F9	Selects the unit Giga/Nano, dBuV for the RF level and dBu for the LF level.
HELP	F1	Opens/closes context-sensitive help.
INFO	CTRL + I	Opens/closes the info window
k/m / mV	ALT + F11	Selects the units kilo/milli and mV for RF levels.
LEVEL	CTRL + L	Activates the level entry.
LOCAL	CTRL + Q	Switches the instrument from remote control to manual control.
M/u / uV	ALT + F10	Selects the units Mega/Micro and uV for RF levels.
MENU	CTRL + M	Calls the menu selection list.
MOD ON/OFF	CTRL + O	Switches modulation on/off. "MOD OFF" is indicated in the status line.
ON/OFF TOGGLE	CTRL + T	Switches a block or parameter on/off. Toggles between the different possibilities of setting a selection parameter.
PRESET	CTRL + P	Restores a defined basic instrument setup.
REARR	CTRL + A	Enlarges displayed menus
RF ON/OFF	CTRL + R	Switches the RF output signal on/off. "RF OFF" is indicated in the status line.
SETUP	CTRL + E	Opens the setup menu for general instrument settings.
WINBAR	CTRL + W	Toggles between the active menus.

4.8.1 Front Panel Key Emulation

The R&S SMA provides a front panel key emulation to enable execution of the front panel key functions by mouse e.g. for remote access. The emulation is called by a right mouse click. The front panel key functions are executed by a mouse click on the associated button.

Freq	Diagram
Level	Menu
File	Rearr.
RF On/Off	WinBar
Mod On/Off	Help
Preset	
Local	
Setup	
Hardcopy	
Info	

A Hardware Interfaces

This section covers hardware related topics, like pin assignment of the GPIB bus interface.

The remote control interfaces are described in details in the Operating Manual, section "Remote Control Basics".

All other interfaces are described in [chapter 2.1, "Front Panel Tour"](#), on page 9 and [chapter 2.2, "Rear Panel Tour"](#), on page 15.

For specifications refer to the data sheet.

A.1 GPIB Bus Interface

Pin assignment

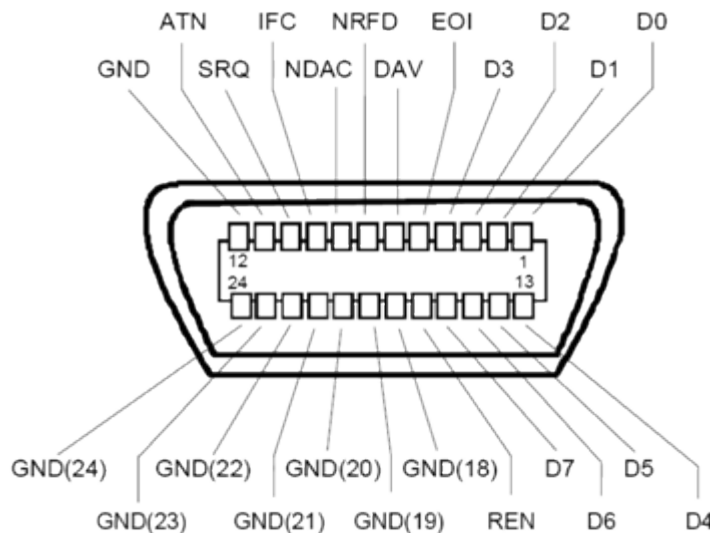

Fig. 1-1: Pin assignment of GPIB bus interface

Bus lines

- Data bus with 8 lines D0 to D7:
The transmission is bit-parallel and byte-serial in the ASCII/ISO code. D0 is the least significant bit, D7 the most significant bit.
- Control bus with five lines:
IFC (Interface Clear): active LOW resets the interfaces of the instruments connected to the default setting.
ATN (Attention): active LOW signals the transmission of interface messages, inactive HIGH signals the transmission of device messages.

SRQ (Service Request): active LOW enables the connected device to send a service request to the controller.

REN (Remote Enable): active LOW permits switchover to remote control.

EOI (End or Identify): has two functions in connection with ATN:

- ATN=HIGH active LOW marks the end of data transmission.
- ATN=LOW active LOW triggers a parallel poll.

- Handshake bus with three lines:

DAV (Data Valid): active LOW signals a valid data byte on the data bus.

NRFD (Not Ready For Data): active LOW signals that one of the connected devices is not ready for data transfer.

NDAC (Not Data Accepted): active LOW signals that the instrument connected is accepting the data on the data bus.

Interface Functions

Instruments which can be controlled via GPIB bus can be equipped with different interface functions. The interface function for the R&S SMA are listed in the following table.

Table 1-1: GPIB bus interface functions

Control character	Interface function
SH1	Handshake source function (source handshake), full capability
AH1	Handshake sink function (acceptor handshake), full capability
L4	Listener function, full capability, de-addressed by MTA.
T6	Talker function, full capability, ability to respond to serial poll, deaddressed by MLA
SR1	Service request function (Service Request), full capability
PP1	Parallel poll function, full capability
RL1	Remote/Local switch over function, full capability
DC1	Reset function (Device Clear), full capability
DT1	Trigger function (Device Trigger), full capability

A.2 AUX I/O Connector

Table 1-2: Pin assignment of the AUX I/O Connector connector

Pin	Signal	Description
1	FHOP_DATA	Data input for Fast Hopping list mode. See section "List Mode" in the Operating Manual.
2	Ground \perp	Ground
3	FHOP_CLK	Clock input for Fast Hopping list mode. See section "List Mode" in the Operating Manual.
4	FHOP_STRB	Strobe input for Fast Hopping list mode. See section "List Mode" in the Operating Manual.

Pin	Signal	Description
5	RF OFF	Input for fast switching of the RF output. Active High (1) switches the RF output off. A subsequent Active Low (0) switches the RF output on again. Switching is performed very fast (10us). However, the attenuation of the switched off output is considerably less than after regular switch-off, because the attenuator is not set to maximum attenuation.
6	INST TRIG	Input for external triggering of the analog modulations, sweeps and List mode. HOP input for controlling the frequency hop mode with external source in List mode.
7	BLANK	Output for blank signal. This signal marks the blank times (invalid level indication). The signal is generated automatically.
8	OPC	Output for Operation Complete line. Active High signals that all remote control commands have been executed. The output is always active.
9 .. 10	Ground \perp	Ground
11 .. 26	FM_DAT	Parallel data input with 16-bit word width for digital FM modulation data. The FM-Data bus is directly connected to the DDS of the synthesiser module. Thus, very fast frequency hop (settling times of 10 us) is possible for frequency bandwidth up to 80 MHz. See section "Frequency Modulation" in the Operating Manual.

Index

A

Abort button	63
Abort calculation	63
Access denied	56
AC supply	17
Architecture of the instrument	38
Arrow keys	13
ATN	73
Attention	73

C

CF memory slot	18
Clock synthesis	42
Computer name	
Changing	30
Connection to an external controller	31
Connector	
AM EXT	14, 18
AUX I/O	16
CLK SYN	18
EXT TUNE	17
FM/PM EXT	14, 18
GPIB	16
IEC/IEEE	16
INSTR TRIG	16
LAN	17
LF	14, 18
PULSE EXT	17
PULSE SYNC	17
PULSE VIDEO	17
REF IN	18
REF OUT	18
RF	15
RF OUT	18
SENSOR	15, 18
USB	15
USB type A	16
USB type B	16
Control bus	73
Controller, external	31
Cursor keys	13

D

Data Valid	73
DAV	73
Default instrument settings	23
DHCP	29
Display	51
Documentation Overview	7

E

EOI	73
Error messages	53

F

FHOP_DATA	74
Frequency display	51
Front panel key emulation	71
Fuses	21

G

Getting started	38
-----------------------	----

I

IFC	73
INFO key	53
Input connector	18
Interface	
functions (GPIB bus)	74
Interface Clear	73
IP address	
Changing	29

K

Key	
Arrow key	14
BACKSPACE	12
Cursor key	14
DIAGRAM	12
ENTER	13
ESC	12
FILE	11
FREQ	11
HELP	10
INFO	10
LEVEL	11
LOCAL	10
MENU	12
MOD ON/OFF	11
ON/OFF	12
PRESET	10, 23
REARR	11
RF ON/OFF	11
SETUP	10
TOGGLE	12
WINBAR	12
Key combinations	70
Keypad	12

L

LAN	
Configuration	28
Level display	51
Linux	26
Linux controller	33

M

Manual Remote Control	31
Menu structure	
access denied	56
header	55
menu area	56
Mod Gen block	41

N

Navigation keys	13
NDAC	73
NRFD	73

O

Online help	
Working with	65
Operating concept	38
Operating system	26
Option	
R&S SMA-B81	18
Output connector	14, 15, 16, 17, 18

P

Point-to-point connection	28
Preset	23
Preset instrument settings	23

R

Rackmounting	21
Remote access	31
REN	73
Reset instrument settings	23
RF block	42
Rotary knob	14

S

Setting not possible	56
Setting parameters	57
SRQ	73
Standby mode	10

U

Ultr@VNC	33
Units	
Input	12
UNIX controller	33

V

VNC connection	33
----------------------	----

W

Warnings	53
----------------	----